

PRODUCT LIST

IPCS

INTEGRATED PACKAGE CONTROL SOLUTIONS

GENSET CONTROLLERS | SYNCHRONIZERS | PROTECTION RELAYS



CONTENTS

GENSET CONTROLLERS	Genset Controllers Overview 5 easYgen-3000XT Series 6 easYgen-2000 Series 8 easYgen-1000 Series 10 easYgen-100 Series 12	Related Devices easYgen Series 16 • LS-5 Series 17 • GC-3000XT 14 • RP-3000XT 14 • easYlite 18	• actiVgen. 18 • LSG 18
SYNCHRONIZERS & LOAD SHARE CONTROLLERS	Synchronizers & Load Share Controllers Overview 19 DSLC-2 20 MSLC-2 20 SPM-D2 Series 21		
AUTOMATIC TRANSFER SWITCH CONTROLLERS	Automatic Transfer Switch Controllers Overview 22 DTSC-200 23 DTSC-50 23 Related Devices DTSC-200 24		
PROTECTION RELAYS	Protection Relays Overview 25 HighPROTEC-2 Line 26 High Tech Line 3 42 Professional Line 54 Basic Line 60	WI Line 62 easYprotec 65	
ACCESSORIES & SERVICES	Accessories & Services Overview . . . 66 Power Generation Accessories 67 Power Generation Small Parts 68 Power Distribution Communication . . 69 Battery Charging Units 70	Trainings 71	

General Terms and Conditions

This list covers all products from the Woodward product segment IPCS Integrated Package Control Solutions, with standard technical specs. For customized specs or special devices we will be pleased to receive your enquiry.

The publication of this document invalidates all previous versions. Dimensions and other data conform to the latest technical standards at the time of publication. We reserve the right to introduce modifications to this document at any time. We can accept no responsibility for printing errors. Any reprinting or duplication of this document in any form – in part or in whole – is prohibited without our consent.

Please Note: The instructions for the use of the listed products are provided electronically ONLY - no print version. A computer with CD-ROM drive and/or internet connection and a PDF viewer are required. A PDF viewer can be downloaded for example from www.adobe.com.

General Terms and Conditions	02
Woodward Worldwide	04
Approvals and Certifications	72
Index Table	76

ABOUT WOODWARD

Woodward is an independent designer, manufacturer, and service provider of control solutions for the aerospace and industrial markets. Our aerospace systems and components optimize the performance of fixed wing and rotorcraft platforms in commercial, business and military aircraft, ground vehicles and other equipment.

Our industrial related systems and components enhance the performance of industrial gas and steam turbines, reciprocating engines, compressors, wind turbines, electrical grids and other energy related industrial equipments. The company's innovative fluid energy, combustion control, electrical energy, and motion control systems help customers offer cleaner, more reliable and more efficient equipment. Our customers include leading original equipment manufacturers and end users of their products.

We are Global

AMERICAS

Colorado | Illinois | California | Michigan | South Carolina | Brazil

ASIA & MIDDLE EAST

China | Japan | Korea | India | Saudi Arabia | United Arab Emirates

EUROPE

Poland | Germany | Bulgaria | UK | Netherlands | Russia

DISTRIBUTORS & SERVICE

In addition to direct offices, Woodward is represented by a network of distributors and service facilities. For further information, please download:

>> www.woodward.com/directory

GENSET CONTROLLERS

The **easYgen-3000 XT** Series is an exceptionally versatile genset control and protection package with all the flexibility and features needed to fit a wide range of power generation applications. It allows the user to standardize on a single, affordable control for many uses – from standalone emergency generators to isochronous parallel operation of up to 32 gensets. Common applications include emergency standby, cogeneration, marine ship/shore power, island prime power or utility paralleling with peak shaving, and import/export control. The easYgen-3000XT controls are backwards compatible to easYgen-3000 series controls so they can synchronize, load share, and perform load-dependent start/stop as needed.

The **easYgen-2000** Series is a compact, affordable genset control and protection package for load sharing up to 16 gensets in island operation, or parallel operation of a single unit with a utility. Its integrated load-dependent start/stop programming allows you to define how gensets are brought on- and off-line to support changing load demands. It even works with a mix of different sized engines, so you can maintain the spinning reserve you need while optimizing fuel efficiency.

The innovative features of the **easYgen-1000**, including auto start-stop logic, real and reactive power sensing, and automatic transfer switch capability make it the intelligent choice for specialized mobile power and emergency stand-by applications. Advanced CAN communication provides control of most common engine ECUs and allows connection to the I/O expansion module. Available in a compact version and an advanced version with state-of-the-art features, the easYgen-1000 controls are smart choices for serial critical standby genset production.

The **easYgen-100** Series is an affordable, value-packed genset control for auto start/stop operations. It provides all the essential functionality for standby diesel/gas genset application with monitoring, protection and event recording functions common to higher end controls. Available in a compact version and an advanced version with state-of-the-art features, the easYgen-100 controls are smart choices for serial standby genset production.



EASYPGEN-3000XT SERIES



EASYPGEN-2000 SERIES



EASYPGEN-1000 SERIES



EASYPGEN-100 SERIES

EASYGEN-3000XT SERIES

FEATURE OVERVIEW

Genset Controllers



	3500XT		3400XT	
	P1	P2	P1	P2
MEASURING				
Generator voltage	3-ph	3-ph	3-ph	3-ph
Generator current	3-ph	3-ph	3-ph	3-ph
Mains voltage	3-ph	3-ph	3-ph	3-ph
Mains or ground current	1-ph	1-ph	1-ph	1-ph
Busbar voltage	1-ph	3-ph	1-ph	3-ph
CONTROL				
Breaker control logic (open and closed transition <100 ms) <i>FlexApp™</i>	3	3	3	3
Number of supported Woodward LS-5 units (1 or 2 breaker controls) #1	16	16	16	16
Automatic, Manual, Stop, and test operating modes	•	•	•	•
Single and multiple-unit operation	•	•	•	•
Mains parallel multiple-unit operation (up to 32 units)	•	•	•	•
AMF (auto mains failure) and stand-by operation	•	•	•	•
Critical mode operation	•	•	•	•
GCB and MCB synchronization (± slipping / phase matching)	•	•	•	•
GGB (Generator group breaker) control	•	•	•	•
Import / export control (kW and kvar)	•	•	•	•
Load-dependent start/stop	•	•	•	•
n/f, V, P, Q, and PF remote control via analog input or interface	•	•	•	•
Load/var sharing for up to 32 gensets	•	•	•	•
Freely configurable PID controllers	3	3	3	3
HMI				
Color Display with Softkey operation <i>DynamicsLCD™</i>	•	•	-	-
Start/stop logic for diesel / gas engines	•	•	•	•
Counters for operating hours / starts / maintenance / active/reactive energy	•	•	•	•
Configuration via PC [USB serial connection & ToolKit software (included)]	•	•	•	•
Event recorder entries with real time clock (battery backup)	1000	1000	1000	1000
Operating Temperature #5	-20 to 70 °C	-20 to 70 °C	-40 to 70 °C	-40 to 70 °C
PROTECTION				
	ANSI			
Generator: Voltage / frequency	59 / 27 / 810 / 81U	•	•	•
Generator: Overload, reverse/reduced power	32 / 32R / 32F	•	•	•
Generator: Synch Check	25	•	•	•
Generator: Unbalanced load	46	•	•	•
Generator: Instantaneous overcurrent	50	•	•	•
Generator: Time-overcurrent (IEC 255 compliant)	51 / 51V	•	•	•
Generator: Ground fault (measured ground current)	50G	•	•	•
Generator: Power factor	55	•	•	•
Generator: Rotation field	•	•	•	•
Engine: Overspeed / underspeed	12 / 14	•	•	•
Engine: Speed / frequency mismatch	•	•	•	•
Engine: D+ auxiliary excitation failure	•	•	•	•
Engine: Cylinder temperature	•	•	•	•
Mains: Voltage / frequency / Synch Check	59 / 27 / 810 / 81U / 25	•	•	•
Mains: Phase shift / rotation field / ROCOF (df/dt)	78	•	•	•
Busbar: Voltage / frequency	•	•	•	•
Busbar: Phase Rotation	-	•	-	•
I/Os				
Speed input: Magnetic / switching; Pickup	•	•	•	•
Discrete alarm inputs (configurable)	12 (9)	23 (20)	12 (9)	23 (20)
Discrete outputs (configurable) <i>LogicsManager™</i>	max. 12	max. 22	max. 12	max. 22
External discrete inputs / outputs via CANopen	32/32	32 / 32	32 / 32	32 / 32
Analog inputs #4 (configurable) <i>FlexIn™</i>	3	10	3	10
Analog outputs: +/- 10 V, +/- 20 mA, PWM; configurable	2	2	2	2
Analog outputs: 0 to 20 mA (0 to 10 V with external 500 Ω resistor)	-	4	-	4
External analog inputs / outputs via CANopen	16 / 4	16 / 4	16 / 4	16 / 4
Display and evaluation of J1939 analog values "supported SPNs"	100	100	100	100
CAN bus communication interfaces #2,3 <i>FlexCAN™</i>	3	3	3	3
Ethernet Modbus TCP Slave interface #3	3	3	3	3
USB Serial interface	1	1	1	1
RS-485 Modbus RTU Slave interface	1	1	1	1
Interface Expansion Capability	-	•	-	•

#1 The easYgen-3500/LS5 communication system allows up to 48 members on the bus. If the easYgen count is reduced from 32, the LS-5 count can be increased (up to 32)

#2 CAN#2 freely selectable during configuration between CANopen or J1939

#3 It is possible to toggle between CAN and Ethernet load share line in STOP mode ("warm redundancy")

#4 Selectable senders: VDO (0 to 180 Ohm, 0 to 5 bar), VDO (0 to 180 Ohm, 0 to 10 bar), VDO (0 to 380 Ohm, 40 to 120°C), VDO (0 to 380 Ohm, 50 to 150°C), Pt100, Pt1000, resistive input (one- or two-pole, 2pt. linear or 9pt. user defined)

#5 Low temperature display variants available (-40 deg. c to 70 deg. c)



	3200XT	3100XT
	P1	P1
MEASURING		
Generator voltage	3-ph	3-ph
Generator current	3-ph	3-ph
Mains voltage	3-ph	3-ph
Mains or ground current	1-ph	1-ph
Busbar voltage	1-ph	1-ph
CONTROL		
Breaker control logic (open and closed transition <100 ms) <i>FlexApp™</i>	2	2
Automatic, Manual, Stop, and test operating modes	•	•
Single and multiple-unit operation	•	•
Mains parallel multiple-unit operation (up to 32 units)	•	•
AMF (auto mains failure) and stand-by operation	•	•
Critical mode operation	•	•
GCB and MCB synchronization (± slipping / phase matching)	•	•
GGB (Generator group breaker) control	-	-
Import / export control (kW and kvar)	•	•
Load-dependent start/stop	•	•
n/f, V, P, Q, and PF remote control via analog input or interface	•	•
Load/var sharing for up to 32 gensets	•	•
Freely configurable PID controllers	3	3
HMI		
Color Display with Softkey operation <i>DynamicsLCD™</i>	•	-
Start/stop logic for diesel / gas engines	•	•
Counters for operating hours / starts / maintenance / active/reactive energy	•	•
Configuration via PC [USB serial connection & ToolKit software (included)]	•	•
Event recorder entries with real time clock (battery backup)	1000	1000
Operating Temperature #5	-20 to 70 °C	-40 to 70 °C
PROTECTION		
	ANSI	
Generator: Voltage / frequency	59 / 27 / 810 / 81U	•
Generator: Overload, reverse/reduced power	32 / 32R / 32F	•
Generator: Synch Check	25	•
Generator: Unbalanced load	46	•
Generator: Instantaneous overcurrent	50	•
Generator: Time-overcurrent (IEC 255 compliant)	51 / 51V	•
Generator: Ground fault (measured ground current)	50G	•
Generator: Power factor	55	•
Generator: Rotation field	•	•
Engine: Overspeed / underspeed	12 / 14	•
Engine: Speed / frequency mismatch	•	•
Engine: D+ auxiliary excitation failure	•	•
Engine: Cylinder temperature	•	•
Mains: Voltage / frequency / Synch Check	59 / 27 / 810 / 81U / 25	•
Mains: Phase shift / rotation field / ROCOF (df/dt)	78	•
I/Os		
Speed input: Magnetic / switching; Pickup	•	•
Discrete alarm inputs (configurable)	12 (10)	12 (10)
Discrete outputs (configurable) <i>LogicsManager™</i>	max. 12	max. 12
External discrete inputs / outputs via CANopen	32 / 32	32 / 32
Analog inputs #4 (configurable) <i>FlexIn™</i>	3	3
Analog outputs: +/- 10 V, +/- 20 mA, PWM; configurable	2	2
External analog inputs / outputs via CANopen	16 / 4	16 / 4
Display and evaluation of J1939 analog values "supported SPNs"	100	100
CAN bus communication interfaces #2,3 <i>FlexCAN™</i>	2	2
Ethernet Modbus TCP Slave interface #3	1	1
USB Serial interface	1	1
RS-485 Modbus RTU Slave interface	1	1

EASYGEN-2000 SERIES

FEATURE OVERVIEW

Genset Controllers



	2500	2300		2200	
	P1	P1	P2	P1	P2
MEASURING					
Generator voltage	3-ph	3-ph	3-ph	3-ph	3-ph
Generator current	3-ph	3-ph	3-ph	3-ph	3-ph
Mains or busbar voltage	3-ph	3-ph	3-ph	3-ph	3-ph
Mains or ground current	1-ph	-	-	1-ph	1-ph
CONTROL					
Different breaker operation modes (None, GCB Open, GCB, GCB/MCB)	•	•	•	•	•
Automatic, Manual and Stop operating modes	•	•	•	•	•
Single unit mains parallel operation	•	•	•	•	•
Multiple-unit island parallel operation (up to 16 units)	•	•	•	•	•
AMF (auto mains failure) and stand-by operation	•	•	•	•	•
Critical mode operation	•	•	•	•	•
GCB and MCB synchronization (slipping / phase matching)	•	•	•	•	•
Open (break-before-make) and closed (make-before-break) transition	•	•	•	•	•
Interchange (import / export control)	•	•	•	•	•
Load-dependent start/stop	•	•	•	•	•
n/f, V, P, Q, and PF remote control via analog input or interface	•	•	•	•	•
Load/var sharing for up to 16 gensets	•	•	•	•	•
HMI					
Monochrome Display with Softkey operation DynamicsLCD™	•	•	•	•	•
Start/stop logic for diesel / gas engines	•	•	•	•	•
Generator kWh meter	•	•	•	•	•
Operating hours/start/maintenance counter	•	•	•	•	•
Configuration via PC	•	•	•	•	•
Event recorder entries with real time clock (battery backup)	300	300	300	300	300
PROTECTION					
	ANSI				
Generator: Voltage / frequency	59 / 27 / 810 / 81U	•	•	•	•
Generator: Overload, reverse/reduced power	32 / 32R / 32F	•	•	•	•
Generator: Unbalanced load	46	•	•	•	•
Generator: Instantaneous overcurrent	50	•	•	•	•
Generator: Time-overcurrent (IEC 255 compliant)	51	•	•	•	•
Generator: Ground fault	50G	•	•	•	•
Generator: Power factor	55	•	•	•	•
Generator: Rotation field	•	•	•	•	•
Engine: Overspeed / underspeed	12 / 14	•	•	•	•
		(via Speed input/ ECU)	-	(via ECU)	(via Speed input)
Engine: Speed / frequency mismatch	•	•	•	•	•
Engine: D+ auxiliary excitation failure	•	•	•	•	•
Mains: Voltage / frequency	59 / 27 / 810 / 81U	•	•	•	•
Mains: Phase shift / rotation field / df/dt (ROCOF)	78	•	•	•	•
I/Os					
Speed input (magnetic / switching; Pickup)	•	-	-	•	-
Discrete alarm inputs (configurable)	10	8	8	8	8
Discrete outputs (configurable) <i>LogicsManager™</i>	11	6	6	6	6
External discrete inputs / outputs via CANopen (maximum)	16 / 16	16 / 16	16 / 16	16 / 16	16 / 16
Analog inputs (configurable) <i>FlexIn™</i>	4	3	3	3	3
Analog outputs (+/- 10V, +/- 20mA, PWM; configurable)	4	2	2	1	1
CAN bus communication interfaces <i>FlexCAN™</i>	2	1	2	1	2
RS-485 Modbus RTU Slave interface	1	1	-	-	-
Service Port (USB or RS-232) - Woodward DPC cable required	•	•	•	•	•

EASYGEN-1000 SERIES

FEATURE OVERVIEW

Genset Controllers



1800



1700



1600



1400

	1800	1700	1600	1400
MEASURING				
Generator voltage	3-ph	3-ph	3-ph	3-ph
Load current	3-ph	3-ph	3-ph	3-ph
Mains voltage	3-ph	3-ph	3-ph	3-ph
Ground current	1-ph	1-ph	-	-
CONTROL				
Mains supply monitoring and automatic changeover	•	•	•	•
GCB and MCB control	•	•	•	•
Start/stop sequence for diesel and gas engines	Diesel / Gas	Diesel / Gas	Diesel	Diesel
Isolated single unit operation	•	•	•	•
AMF (Automatic Mains Failure operation)	•	•	•	•
Stand-by operation	•	•	•	•
Open transition (break-before-make)	•	•	•	•
ATS (Automatic Transfer Switching)	•	•	•	•
HMI, COUNTERS, AND EVENT LOG				
Integral display with tactile buttons	TFT LCD (480 x 272)	Monochrome LCD (240x128)	Monochrome LCD (132 x 64)	Monochrome LCD (132x64)
Customizable power-up text and image	•	•	•	•
Front panel configuration with PIN protection	•	•	•	•
Flush mounting	•	•	•	•
Operating hours/start/maintenance counters	•	•	•	•
Event recorder with real time clock	99 internal; extended data log using SD card	99	50	50
kWh / kvarh	•/•	•/•	•/-	•/-
Switchable parameter sets	•	•	-	-
PROTECTION				
	ANSI			
Generator: Voltage / frequency	59 / 27 / 810 / 81U	•	•	•
Generator: Overload, reverse/reduced power	32 / 32R / 32F	•	•	•
Generator: Ground fault	50G	•	•	-
Generator: Voltage asymmetry	•	•	•	•
Generator: Phase rotation	•	•	•	•
Generator: Current-DT, IDMT	50 / 51	•	•	•
Engine: Overspeed / underspeed	12 / 14	•	•	•
Engine: Speed	•	•	•	•
Engine: Crank disconnect	•	•	•	•
Mains: Voltage / frequency	59 / 27 / 810 / 81U	•	•	•
Mains: Voltage asymmetry	•	•	•	•
Mains: Rotation field	78	•	•	•
Battery voltage	•	•	•	•
I/Os AND INTERFACES				
Discrete inputs	1x E-Stop, 8x configurable	1x E-Stop, 8x configurable	1x E-Stop, 5x configurable	3 (+2 switchable as AI/DI)
Relay outputs	1x Fuel (16A), 1x Start (16A), 6x configurable	1x Fuel (16A), 1x Start (16A), 6x configurable	1x Fuel (16A), 1x Start (16A), 4x configurable	1x Fuel (5A), 1x Start (5A), 4x configurable
Analog inputs	5x resistive	4x resistive, 1x resistive/current/volt	3x resistive	4x resistive (2 switchable as AI/DI)
Speed input (MPU)	•	•	•	•
Aux. excitation (D+)	•	•	•	•
Ethernet (TCP/IP)	•	-	-	-
CAN (J1939)	•	•	•	•
External DI/DO via CAN bus	16 / 16	16 / 16	-	-
USB service port	•	•	•	•
RS485	•	•	•	-
RS232	•	•	-	-
Micro SD card support	•	-	-	-

EASYGEN-100 SERIES

FEATURE OVERVIEW

Genset Controllers



		800	600	400
MEASURING				
Generator voltage		3-ph	3-ph	3-ph
Load current		3-ph	3-ph	3-ph
Ground current		1-ph	-	-
CONTROL				
Isolated single unit operation		•	•	•
Stand-by operation		•	•	•
GCB control		•	•	•
Start/stop sequence for diesel and gas engines		Diesel / Gas	Diesel	Diesel
Tactile buttons to start/stop the genset and open/close the breaker		•	•	•
HMI, COUNTERS, AND EVENT LOG				
Integral display with tactile buttons		TFT LCD (480 x 272)	Monochrome LCD (132 x 64)	Monochrome LCD (132 x 64)
Customizable power-up text and image		•	•	•
Front panel configuration with PIN protection		•	•	•
Flush mounting		•	•	•
Operating hours/start/maintenance counters		•	•	•
Event recorder with real time clock		99 internal; extended data log using SD card	50	50
kWh / kvarh		•/•	•/-	•/-
Switchable parameter sets		•	-	-
PROTECTION				
	ANSI			
Generator: Voltage / frequency	59 / 27 / 810 / 81U	•	•	•
Generator: Overload, reverse/reduced power	32 / 32R / 32F	•	•	•
Generator: Ground fault	50G	•	-	-
Generator: Voltage asymmetry		•	•	•
Generator: Phase rotation		•	•	•
Generator: Current-DT, IDMT	50 / 51	•	•	•
Engine: Overspeed / underspeed	12 / 14	•	•	•
Engine: Speed		•	•	•
Engine: Crank disconnect		•	•	•
Battery voltage		•	•	•
I/Os				
Discrete inputs		1x E-Stop, 8x configurable	1x E-Stop, 5x configurable	3 (+2 switchable as AI/DI)
Relay outputs		1x Fuel (16A), 1x Start (16A), 6x configurable	1x Fuel (16A), 1x Start (16A), 4x configurable	1x Fuel (5A), 1x Start (5A), 4x configurable
Analog inputs		5x resistive	3x resistive	4x resistive (2 switchable as AI/DI)
Speed input (MPU)		•	•	•
Aux. excitation (D+)		•	•	•
Ethernet (TCP/IP)		•	-	-
CAN (J1939)		•	•	•
External DI/DO via CAN bus		16 / 16	-	-
USB service port		•	•	•
RS485		•	•	-
RS232		•	-	-
Micro SD card slot		•	-	-

EASYGEN SERIES

Genset Controllers

RGCP-3400 for mission critical Applications

	Type	Part Number (P/N)
RGCP-3400 product spec. 37560		
RGCP-3400-SU	1 A / 5 A	9900-1029 / 9900-1022
RGCP-3400-MU	1 A / 5 A	9900-1030 / 9900-1028
Optional Remote Panel	-	8446-1057
Optional redundant CAN-Fiber Optic gateway	-	8445-1048

easYgen-3000XT Series for Complex Breaker Applications

	Type	Part Number (P/N)
GC-3000XT Group Control		
GC-3400XT-P1 ¹	-	8440-2228
EASYGEN-3500XT product spec. 37583		
Package P1-K51 ¹	1 A / 5 A	8440-2230
Package P1	1 A / 5 A	8440-2085
Package P1-LT (Low Temperature)	1 A / 5 A	8440-2086
Package P2	1 A / 5 A	8440-2088
Package P2-LT (Low Temperature)	1 A / 5 A	8440-2089
EASYGEN-3400XT product spec. 37583		
Package P1	1 A / 5 A	8440-2084
Package P2	1 A / 5 A	8440-2087
EASYGEN-3200XT product spec. 37582		
Package P1	1 A / 5 A	8440-2082
Package P1-LT (Low Temperature)	1 A / 5 A	8440-2083
EASYGEN-3100XT product spec. 37582		
Package P1	1 A / 5 A	8440-2081

RP-3000XT Remote Panel

	Used for:	Part Number (P/N)
RP-3000XT product spec. 37594	easYgen-3000XT	8446-1061

easYgen-3000 Series for Complex Breaker Applications

	Type	Part Number (P/N)
EASYGEN-3500 product spec. 37523		
Package P1	1 A / 5 A	8440-1935 / 8440-1934
Package P2	1 A / 5 A	8440-1937 / 8440-1936
Asynchron KIT-3000 product spec. 37568	5 A	8923-2073
Marine Package P1 product spec. 37533	1 A / 5 A	8440-2046 / 8440-2047
Rental Package P1 product spec. 37553	1 A / 5 A	8440-2095 / 8440-2030
Rental Package P2 product spec. 37553	1 A / 5 A	8440-2191 / 8440-2192
EASYGEN-3400 product spec. 37523		
Package P1	1 A / 5 A	8440-1956 / 8440-1945
Package P2	1 A / 5 A	8440-2079 / 8440-2078
Marine Package P1 product spec. 37533	1 A / 5 A	8440-2044 / 8440-2045
Rental Package product spec. 37553	1 A / 5 A	8440-2162 / 8440-2163
EASYGEN-3200 product spec. 37258		
Package P1	1 A / 5 A	8440-2049 / 8440-2050
Package P2	1 A / 5 A	8440-2051 / 8440-2052
EASYGEN-3100 product spec. 37258		
Package P1	1 A / 5 A	8440-2055 / 8440-2054
Package P2	1 A / 5 A	8440-2057 / 8440-2056

¹ Ask for availability

² Available by the end of 2018

RP-3000 Remote Panel

	Used for:	Part Number (P/N)
RP-3000 product spec. 37446	easYgen-3100/3200	8446-1048
	easYgen-3400/3500	8446-1048
	easYgen-3400/3500 Marine	8446-1046
	easYgen-3400-P1 Rental	8446-1059
	easYgen-3500-P2 Rental	8446-1062

easYgen-2000 Series for Multiple Unit Operation

	Type	Part Number (P/N)
EASYGEN-2500 product spec. 37548		
Package P1	5 A	8440-1884
	1 A	8440-1860
Asynchron KIT-2000 product spec. 37568	5 A	8923-2074
Rental Package product spec. 37553	5 A	8440-2029
	1 A	8440-2096
EASYGEN-2300 product spec. 37548		
Package P1	5 A	8440-2080
Package P2	5 A	8440-2058
EASYGEN-2200 product spec. 37548		
Package P1	5 A	8440-1855
	1 A	8440-1856
Package P2	5 A	8440-1857
	1 A	8440-1858

easYgen-1000 Series for Single Unit AMF Operation

	Type	Part Number (P/N)
EASYGEN-1800 product spec. 37686		
	5A	8440-3005
EASYGEN-1700 product spec. 37686		
	5A	8440-2233
EASYGEN-1600 product spec. 37686		
	5A	8440-3004
EASYGEN-1500 product spec. 37180		
	5 A	8440-1809
	1 A	8440-1810
EASYGEN-1400 ² product spec. 37686		
	5 A	8440-2232

easYgen-100 Series for Single Unit Auto Start/Stop Operation

	Type	Part Number (P/N)
EASYGEN-800 product spec. 37697		
	5 A	8440-3003
EASYGEN-600 product spec. 37697		
	5 A	8440-2229
EASYGEN-400 ²		
	5 A	8440-2231
EASYGEN-350/X product spec. 37217		
	5 A	8440-1801
EASYGEN-320/X product spec. 37217		
	5 A	8440-1800

RELATED DEVICES

The **LS-5x1/5x2** circuit breaker control and protection device is designed to enable complex power management applications with multiple segments and bus breakers in combination with easYgen-3400XT/3500XT-equipped genset controllers. The LS-5 devices manage synchronization, loading and unloading on each bus segment, and send the required voltage and frequency references via CAN bus to the easYgen-3400XT/3500XT genset controllers. It can be used as a sync-check relay in stand-alone mode without easYgens.



LS-5 SERIES

Woodward's **RP-3000XT** is a touch screen remote control and annunciation panel for use with the easYgen-3000XT series controls. It is particularly useful with the back panel mounted easYgen-3100XT/3400XT, providing control from the front panel with greatly reduced wiring to the access door, while keeping high voltage connections located safely on the back panel.



RP-3000XT

The **easYlite-100** is designed to remotely display the status of a generator control system through a CAN BUS Interface. The easYlite-100 may be used where an additional status display is required, which is directly controlled by the generator control unit e.g. NFPA-110 compliant applications.



EASYLITE-100

The **IKD 1** is an I/O expansion board. It allows an additional eight discrete inputs and eight relay outputs to be connected via CAN bus to the Woodward easYgen series generator set controllers and DTSC-200 automatic transfer switch controllers. It is possible to connect multiple IKD 1 cards. The I/O are displayed in clear text messages on the control's HMI and can be used for further processing.



IKD 1

The **Load Share Gateway (LSG)** is a communication converter specifically designed to operate the easYgen-2000 / easYgen-3000XT Series and any other industrial legacy devices in a load share and enables retrofit applications.



LSG

RELATED DEVICES



LS-5 Series Feature Overview

	LS-521	LS-511	LS-522	LS-512
CONTROL				
Automatic and Manual operating modes	•	•	•	•
Number of controlled breakers	1	1	2 or 1	2 or 1
Breaker synchronization (\pm slipping / phase matching)	•	•	•	•
Vector group adjustment for synchronization	•	•	•	•
Configurable dead bus closure direction	•	•	•	•
HMI				
Configuration via HMI and PC	•	PC only	•	PC only
Event recorder with real time clock (battery backup)	•	•	•	•
Date and Time Synchronization between LS-5 units and easYgen-3400XT/3500XT	•	•	•	•
PROTECTION				
	ANSI			
Over-/undervoltage	59 / 27	•	•	•
Over-/underfrequency	810 / U	•	•	•
Voltage asymmetry	47	•	•	•
Phase shift	78	•	•	•
df/dt (ROCOF)	81	•	•	•
QV monitoring		•	•	•
Sync-check	25	•	•	•
Time-dependent voltage		•	•	•
Mains voltage increase (accord. to VDE-AR-N-4105)		•	•	•
I/Os				
Discrete alarm inputs (configurable)	8	8	8	8
Analog outputs [+/- 10V, +/- 20mA, PWM; Discrete outputs (configurable)]	6	6	6	6
Analog input (+/- 20mA)	-	-	1	1
CAN bus communication interfaces <i>FlexCAN™</i>	1	1	1	1
RS-485 Modbus RTU Slave interface	•	•	•	•

LS-5 Series Circuit Breaker Control & Protection

	Type	Part Number (P/N)
LS-521		
Display, one breaker	product spec 37661	8440-2150
	5 A	8440-2178
Marine	product spec 37545	8440-2075
	5 A	8440-2074
	1 A	
LS-511		
Metal, one breaker	product spec 37661	8440-2152
	5 A	8440-2180
	1 A	
Marine	product spec 37545	8440-2077
	5 A	8440-2076
	1 A	
LS-522		
Display, two breaker	product spec 37665	8440-2151
	5 A	8440-2179
	1 A	
LS-512		
Metal, two breaker	product spec 37665	8440-2153
	5 A	8440-2181
	1 A	

RELATED DEVICES

Genset Controllers

easYlite Remote Annunciator

	Type	Part Number (P/N)
EASYLITE-100 product spec. 37279	-	8446-1023
EASYLITE-200 ¹	-	8447-1007

¹ Available early 2019

actiVgen

	Type	Part Number (P/N)
ACTIVGEN product spec. 03419	-	8440-2100

LSG Load Share Gateway

	Type	Part Number (P/N)
LSG product spec. 37451	Active Power (P)	8444-1075
	Reactive Power (Q)	8444-1074

Other Related Devices

		CLICK FOR MORE INFORMATION
RELATED DEVICES WOODWARD		
ESENET Ethernet Gateway	Application Note 37576	>>
ESEPRO Profibus Gateway	Application Note 37577	>>
EPU-100 Remanence Voltage Converter for Asynchronous Generators	product spec. 37562	>>
IKD 1 Digital I/O expansion board	product spec. 37171	>>
DPC Direct Configuration Cable		>>
IXXAT USB-TO-CAN Converter		>>
Power Generation Learning Module	product spec. 03412	>>
CAN-Fiber Optic Gateways	Application Note 37598	>>
RELATED DEVICES OTHER SUPPLIERS		
NETBITER Remote Communication Gateway - HMS		>>
Thermocouple Scanner - Axiomatic		>>
POWER GENERATION SMALL PARTS		>>

SYNCHRONIZERS & LOAD SHARE CONTROLLERS

The **DSL-2 control** is a microprocessor-based synchronizer and load control designed for use on three-phase AC generators. The DSL-2 control combines synchronizer, load sensor, load control, dead bus closing system, var, power factor and process control, all integrated into one powerful package. Applications allow up to 32 generators to be precisely paralleled and controlled. A dedicated Ethernet system provides seamless communications between DSL-2 and MSLC-2 units. A second Ethernet port is provided for redundant load sharing or customer remote control and monitoring capability using Modbus TCP allowing easy DCS and PLC interfacing. Modbus RTU is available through a separate RS-485 port.



DSL-2

The **MSLC-2 control** is a microprocessor-based load control designed for three-phase electric power generation sites equipped with the DSL-2 digital synchronizer and load control. The original MSLC has been blended with another decade of application experiences to develop the new MSLC-2. The MSLC-2 is a synchronizer, a utility load sensor, an import/export load level control, a power factor control, and a master process control. Applications include power systems which operate in parallel with the utility with single or multiple utility feeds as well as new capabilities for multiple segment and intertie breaker control.



MSLC-2

The **SPM-D2-10 Series** are microprocessor-based synchronizers designed for use on three-phase AC generators equipped with Woodward or other compatible speed controls and automatic voltage regulators. The SPM-D2-10 Series synchronizers provide automatic frequency, phase, and voltage matching using either analog or discrete output bias signals.



SPM-D2 SERIES

DSL-2 | MSLC-2 FEATURE OVERVIEW

Synchronizers & Load Share Controllers

DSL-2 | MSLC-2 Feature Overview



I/Os	DSL-2	MSLC-2
Discrete inputs	23	23
Relay outputs	12	12
Analog inputs / outputs	3 / 2	3 / 0
RS-232 / RS-485 Interface	1 / 1	1 / 1
Ethernet Interfaces (10/100 Mbit/s)	2	2
LED 1	CPU OK	CPU OK
LED 2	Sync Enable	Sync Enable

DSL-2 Digital Synchronizer and Load Control

DSL-2	Type	Part Number (P/N)
product spec. 37493	5 A	8440-1878
	1 A	8440-1978

MSLC-2 Master Synchronizer and Load Control

MSLC-2	Type	Part Number (P/N)
product spec. 37494	5 A	8440-1877
	1 A	8440-1977

SPM-D2 SERIES FEATURE OVERVIEW

SPM-D2 Series Feature Overview



	SPM-D2-10					
	-	X	N	XN	YB	NYB
MEASURING/DISPLAY						
Generator/System A voltage	2-phase	2-phase	2-phase	2-phase	3/2-phase	3/2-phase
Busbar/System B voltage	2-phase	2-phase	2-phase	2-phase	3/2-phase	3/2-phase
CONTROL						
Breaker	1	1	1	1	1	1
Synchronization	2-phase	2-phase	2-phase	2-phase	3/2-phase	3/2-phase
Isolated operation	•	•	•	•	•	•
Dead bus operation	On-demand	On-demand	On-demand	On-demand	Enhanced	Enhanced
CONTROLLER						
Discrete raise/lower: speed	•	•	•	•	•	•
Discrete raise/lower: voltage	•	•	•	•	•	•
Analog output: speed	-	•	-	•	-	-
Analog output: voltage	-	•	-	•	-	-
PWM output: speed	-	•	-	•	-	-

SPM-D2 Series Synchronizer

SPM-D2-10	Type	Part Number (P/N)
product spec. 37622	100 Vac ¹	8440-2166
	400 Vac ²	8440-2164
Package X	100 Vac ¹	8440-2168
	400 Vac ²	8440-2171
Package N	100 Vac ¹	8440-2174
	400 Vac ²	8440-2175
Package XN	100 Vac ¹	8440-2172
	400 Vac ²	8440-2190
Package YB	100 Vac ¹	8440-2167
	400 Vac ²	8440-2176
Package NYB	100 Vac ¹	8440-2177
	400 Vac ²	8440-2189
Package PSY5-FU-D	400 Vac ²	8440-2170
Package PSY5-FU-D-W	400 Vac ²	8440-2173
SPM-D2-11		
product spec. 37623	100 Vac ¹	8440-2165
	400 Vac ²	8440-2169

¹ Adjustable to 120 Vac

² All units with 400 V measuring inputs can also be used for 100 V system voltage

AUTOMATIC TRANSFER SWITCH CONTROLLERS

The **DTSC-200** is the ultimate control for new ATS (automatic transfer switch) builds and retrofits. A complete measurement and protection package, it easily configures to utility-to-generator, generator-to-generator, or utility-to-utility systems for open-, delayed- or closed transition transfer with sync-check to ensure the smoothest possible transfer.



DTSC-200

The **DTSC-50** digital transfer switch controller is an economical controller for open-transition (break before make) automatic transfer switch (ATS) control for emergency standby applications with a single generator.



DTSC-50

DTSC-200 | DTSC-50 FEATURE OVERVIEW



DTSC-200



DTSC-50

	DTSC-200	DTSC-50
MEASURING		
Source voltage	(3phase/4-wire) rated 69/120 Vac	(1phase/2-wire or 3phase/4-wire) rated 480 Vac
- True R.M.S.	max. 86/150 Vac	max. 600 Vac
- FlexRange™	rated 277/480 Vac max. 346/600 Vac	-
Load current (3phase/4-wire, true RMS)	..1 A or ..15 A	-
BREAKER CONTROL		
Open transition (break-before-make)	•	•
Delayed transition (break-before-make) + timed neutral position	•	-
Closed transition (make-before-break)	•	-
APPLICATION		
Utility to generator	•	•
Utility to utility	•	-
Generator to generator (2 start signals)	•	-
FEATURES		
Programmable elevator pre-signal	•	-
Programmable motor load disconnect signal	•	-
Transfer commit	•	-
Test modes	•	-
Transfer mode selector	•	-
Load shed	•	-
Shunt trip enable	•	-
Extended parallel time	•	-
Automated display backlight shutdown selectable	•	-
Daylight saving time	•	-
Source priority selection	•	-
Vector group adjustment for in-phase monitoring	•	-
Fully adjustable timers	•	•
Status LEDs for source availability and breaker state	•	•
ACCESSORIES		
Soft-keys (advanced LC display) <i>DynamicsLCD™</i>	•	•
Configuration via PC	•	•
Event recorder with real time clock (battery backup)	300	-
Flush-mounting (screw or clamp fastening)	•	-
MONITORING		
	ANSI	
Source: voltage	59/27	•
Source: frequency	810/81U	•
Source: voltage asymmetry	47	•
Source: Phase rotation error	47	•
Source: rotation field	-	-
Engine : Start fail monitoring	-	•
Engine : Unintended Stop monitoring	-	•
Load: overload	32	•
Load: overcurrent	50/51	•
Switch: Open/close failure detection	-	•
Switch: plausible switch position	•	-
Switch: transition failure	•	-
Battery: voltage	•	-
Synch check (inphase monitoring)	25	•
Parallel time monitoring	•	-
I/Os		
Discrete inputs (configurable)	12	2
Discrete outputs (configurable) <i>LogicsManager™</i>	9	3
Direct configuration interface	•	•
CANopen communication bus (isolated)	•	-
RS-485 Modbus RTU Slave full/half-duplex (isolated)	•	-

DTSC-200 | DTSC-50

Automatic Transfer Switch Controllers

DTSC-200 Automatic Transfer Switch Controller

	Type	Part Number (P/N)
DTSC-200 product spec 37398	5 A	8440-1868
	1 A	8440-1867

DTSC-50 Automatic Transfer Switch Controller

	Type	Part Number (P/N)
DTSC-50 product spec 37455	-	8440-1894

Related Devices DTSC-200

		CLICK FOR MORE INFORMATION
RELATED DEVICES WOODWARD		
ESENET Ethernet Gateway	Application Note 37576	>>
ESEPRO Profibus Gateway	Application Note 37577	>>
IKD 1 Digital I/O expansion board	product spec 37171	>>
DPC Direct Configuration Cable		>>
IXXAT USB-TO-CAN Converter		>>
RELATED DEVICES OTHER SUPPLIERS		
NETBITER Remote Communication Gateway - HMS		
CAN-Fiber Optic Gateways	Application Note 37598	>>
POWER GENERATION SMALL PARTS		>>

PROTECTION RELAYS

With the **HighPROTEC Line** Woodward offers an outstanding solution for the reliable protection of distribution and generator applications. The innovative device handling and PC tool with plausibility check and internal fault simulator, combined with high flexible hardware minimized commissioning, training costs and setting failures. With the focus to an optimized menu overview not relevant functions could be hidden.

The line is easily applicable for generator, cable and line, and transformer differential protection, directional and non directional feeder protection as well as motor protection. The all in one protection concept for the different application guaranties an high availability of your electrical equipment and your GRID.

The **High Tech Line** consists of modular protection devices for low voltage, medium voltage, and lower high voltage level with numerous and complex protection functions. The protection range includes basic time overcurrent protection, machine protection to high-grade differential protection.

Auxiliary relays are available for lockout, trip circuit supervision and rotor earth fault detection. Devices are designed for door mounting, either in separate housings or in 19" racks. For back panel mounting an adapter is also available.

The **Professional Line** with its digital separate or combined relays provide all common protection functions for low and medium voltage applications, and are designed for DIN rail mounting. Rated voltage and frequency can be set by means of DIP switches; pick-up values and tripping delays via potentiometers. The wide-range power supply for AC and DC make the relays universal. An optionally available interface adapter enables the devices to communicate with your SCADA system.

The **Basic Line** devices are supervision relays for low voltage applications equipped with a precise micro-controller and designed for DIN-rail mounting. They are easy to operate and simple to commission. Advance technology at low price.

All **WI Line** devices are self-powered time overcurrent relays, which means they take their energy from the current transformers. Since they do not require auxilliary power, the WI Line Relays are well suited for use in self-sustaining transfer and distribution stations, local grids, and ring-main-units. Tripping characteristics range from two-stage, independent (DEFT) and dependent (INV) time overcurrent protection, up to special characteristic curves. As further options, we offer some relays with integrated earth fault protection.



HighPROTEC-2 LINE



HIGH TECH LINE



PROFESSIONAL LINE



BASIC LINE



WI LINE

HighPROTEC-2 LINE

FEATURE OVERVIEW

Protection Relays



	ANSI	MCA4-2	MRA4-2	MRI4-2	MRU4-2	MRMV4-2	MRM4-2
PROTECTION FUNCTIONS							
Phase current stages (non-directional)	50/51	-	-	6	-	6	6
Phase current stages (non-directional and directional)	50/51/67	6	6	-	-	-	-
Voltage restrained current protection	51V	•	•	-	-	•	-
Voltage controlled current function	51C	•	•	-	-	•	-
Earth current stages (non-directional)	50N/51N	-	-	4	-	4	4
Earth current stages (non-directional and directional)	50N/51N/67N	•	•	-	-	-	-
Negative sequence stages (current)	46	2	2	2	-	2	2
Overload protection with thermal replica	49	•	•	•	-	•	•
Voltage stages	27/59	6	6	-	6	6	-
Residual voltage stages	59N	2	2	-	2	2	-
Frequency stages	81 U/O	6	6	-	6	6	-
Inrush detection IH2 (2nd harmonic)		•	•	•	-	-	-
Voltage transformer supervision	60FL	•	•	-	•	•	-
Current transformer supervision	60L	•	•	•	-	•	•
Auto reclosing	79	•	•	•	-	-	-
Negative / positive sequence stages (voltage)	47	6	6	-	6	6	-
Lockout function	86	•	•	•	•	•	•
Circuit breaker failure protection	62BF/52BF	•	•	•	•	•	•
Trip circuit supervision	74TC	•	•	•	•	•	•
Frequency gradient df/dt (ROCOF)	81R	•	•	-	•	•	-
Vector surge	78	•	•	-	•	•	-
Power protection: P, Q, Qr, S, Pr	32F, 37F, 32Q, 37Q, 37QR, 32S, 37S, 37R	6	6	-	-	6	-
Power factor cos (φ)	55	2	2	-	-	2	-
QU protection (undervoltage- directional reactive power protection)		•	•	-	-	-	-
UFSL (non-discriminating active power direction depending load shedding)		•	•	-	-	-	-
Synchro check	25	•	•	-	•	-	-
Cold load pick up	37	•	•	•	-	-	-
Switch onto fault		•	•	•	-	-	-
LVRT (low voltage ride through)		2	2	-	2	-	-
Protection parameter sets		4	4	4	4	4	4
Reverse interlocking		•	•	•	•	•	•
Event/fault/disturbance recorder		•	•	•	•	•	•
Start-/trend recorder		•	•	•	•	•	•
CONTROL							
Control functionality up to 6 switchgears		•	-	-	-	-	-
Control functionality of 1 switchgear		-	•	•	•	•	•
Logic (up to 80 equations)		•	•	•	•	•	•
MEASURING FUNCTIONS							
Currents: IL1, IL2, IL3, IE, IO, I1, I2, IL1H2, IL2H2, IL3H2, IEH2		•	•	•	-	•	•
Overload \mathcal{I}		•	•	•	-	•	-
Voltages: VL1, VL2, VL3, VL12, VL23, VL31, VE, VO, V1, V2		•	•	-	•	•	-
Frequency f		•	•	-	•	•	-
Power: P, Q, S, Pr, PF (cos φ), Wp+, Wp-, Wq+, Wq-		•	•	-	-	•	-
HARDWARE							
Number of binary output relays		7 ¹ /13 ¹	7 ¹ /13 ¹	6	6	7 ¹ /13 ¹	6 ¹ /4 ¹
Number of digital inputs		8 ¹ /16 ¹	8 ¹ /16 ¹	8	8	8 ¹ /8 ¹	8 ¹ /4 ¹
Number of analogue in- and outputs ¹		-	-	-	-	0+4	0+1 ¹
COMMUNICATION							
IEC61850 (RJ45 or fibre optic (FO) LC)		○	○	○	○	○	○
MODBUS RTU (via fibre optic (FO) ST or RS485)		○	○	○	○	○	○
MODBUS TCP (RJ45 or fibre optic (FO) LC)		○	○	○	○	○	○
IEC60870-5-103 (via fibre optic (FO) ST or RS485)		○	○	○	○	○	○
PROFIBUS DP (via fibre optic (FO) ST or RS485)		○	○	○	○	○	○
DNP3.0 RTU (via fibre optic (FO) ST or RS485)		○	○	○	○	○	○
DNP3.0 TCP (RJ45 or fibre optic (FO) LC)		○	○	○	○	○	○
IRIG-B interface (time synchronization)		•	•	•	•	•	•

• = standard ○ = optional ¹ = depends on type of device ² = information on availability on request

HighPROTEC-2 LINE

FEATURE OVERVIEW



	ANSI	MCDGV4-2	MCDTV4-2	MRDT4-2	MCDLV4-2	MRB4 ²
PROTECTION FUNCTIONS						
Busbar differential protection	87B	-	-	-	-	•
Generator differential protection	87G	•	-	-	-	-
Generator- Transformer differential protection	87GT	•	-	-	-	-
Transformer differential protection (2 windings)	87T	-	•	•	•	-
Cable/Line differential	87L	-	-	-	•	-
Ground differential protection (high stabilized)	87N (64REF)	2	2	2	2	-
Phase distance protection	21P	•	-	-	-	-
Pole slip protection (OOS)	78PS	•	-	-	-	-
Overexcitation V/Hz	24	•	•	-	•	-
Loss of excitation	40	•	-	-	-	-
100% Stator earth fault protection with 3 Harmonics	59TN/27TN	•	-	-	-	-
Phase current stages (non-directional)	50/51	-	-	6	-	-
Phase current stages (non-directional and directional)	50/51/67	6	6	-	6	-
Voltage restrained / controlled current protection / function	51V / 51C	•	•	-	•	-
Earth current stages (nondirectional)	50N/51N	-	-	4	-	-
Earth current stages (non-directional and directional)	50N/51N/67N	4	4	-	4	-
Negative sequence stages (current)	46	2	2	2	2	-
Overload protection with thermal replica	49	•	•	•	•	-
Voltage stages / residual voltage stages	27/59 / 59N	6 / 2	6 / 2	-	6 / 2	-
Frequency stages	81 U/O / ROCOF	6	6	-	6	-
Voltage transformer supervision	60FL	•	•	-	•	-
Current transformer supervision	60L	•	•	•	•	-
Auto reclosing	79	-	-	-	•	-
Negative / positive sequence stages (voltage)	47	6	6	-	6	-
Lockout function	86	•	•	•	•	-
Circuit breaker failure protection	50 BF	•	•	•	•	-
Trip circuit supervision	74TC	•	•	•	•	•
Vector surge	78	•	•	-	•	-
Power protection: P, Q, Qr, S, Pr	32F, 37F, 32Q, 37Q, 37QR, 32S, 37S, 37R	6	6	-	6	-
Power factor cos (φ)	55	2	2	-	2	-
QU protection (undervoltage - directional reactive power protection)		•	•	-	•	-
UFLS (non-discriminating active power direction depending load shedding)		-	•	-	•	-
Synchrocheck	25	•	•	-	•	-
Inadvertent energization	50/27	1	-	-	-	-
Cold load pick up	37	•	•	•	•	-
Switch onto fault		•	•	•	•	-
LVRT (low voltage ride through)		2	2	-	2	4
Protection parameter sets		4	4	4	4	-
Reverse interlocking		•	•	•	•	-
Event/fault/disturbance recorder		•	•	•	•	•
Start-/trend recorder		•	•	•	•	•
CONTROL						
Control functionality up to 6 switchgears		•	•	-	•	-
Control functionality of 2 switchgear		-	-	•	-	-
Logic (up to 80 equations)		•	•	•	•	•
MEASURING FUNCTIONS						
Currents: IL1, IL2, IL3, IE, IO, I1, I2, IL1H2, IL2H2, IL3H2, IEH2		•	•	•	•	-
Overload S		•	•	-	•	-
Voltages: VL1, VL2, VL3, VL12, VL23, VL31, VE, V0, V1, V2		•	•	-	•	-
Frequency f		•	•	-	•	-
Power: P, Q, S, Pr, PF (cos φ), Wp+, Wp-, Wq+, Wq-		•	-	-	•	-
HARDWARE						
Number of binary output relays ¹		11 ¹ /11 ¹ /11 ¹ /16 ¹	11 ¹ /11 ¹	7 ¹ /13 ¹	7 ¹ /13 ¹ /20 ¹	-
Number of digital inputs ¹		16 ¹ /8 ¹ /24 ¹ /16 ¹	16 ¹ /8 ¹	8 ¹ /16 ¹	8 ¹ /16 ¹ /24 ¹	-
Number of analogue inputs and outputs ¹		0 ¹ /2 ¹ +2 ¹ /0 ¹ /0 ¹	0 ¹ /2 ¹ +2 ¹	-	-	-
COMMUNICATION						
IEC61850 (RJ45 or fibre optic (FO) LC)		○	○	○	○	○
MODBUS RTU (via fibre optic (FO) ST or RS485)		○	○	○	○	○
MODBUS TCP (RJ45 or fibre optic (FO) LC)		○	○	○	○	○
IEC60870-5-103 (via fibre optic (FO) ST or RS485)		○	○	○	○	○
PROFIBUS DP (via fibre optic (FO) ST or RS485)		○	○	○	○	○
DNP3.0 RTU (via fibre optic (FO) ST or RS485)		○	○	○	○	○
DNP3.0 TCP (RJ45 or fibre optic (FO) LC)		○	○	○	○	○
IRIG-B interface (time synchronization)		•	•	•	•	○

• = standard ○ = optional ¹ = depends on type of device ² = information on availability on request

HighPROTEC-2 LINE

Protection Relays

MCA4-2 Directional Feeder Protection

Product Spec DOK-FLY-MCA4-2

		MCA4	-2						
Version 2 with USB, enhanced communication and user options									
DIGITAL INPUTS	BINARY OUTPUT RELAYS	HOUSING	LARGE DISPLAY						
8	7	B2	x	A					
16	13	B2	x	D					
HARDWARE VARIANT 2									
Phase current 5 A/1 A, Ground Current 5 A/1 A				0					
Phase current 5 A/1 A, Sensitive Ground Current 5 A/1 A				1					
HOUSE AND MOUNTING									
Door mounting				A					
Door mounting 19" (flush mounting)				B					
COMMUNICATION PROTOCOL									
Without protocol				A					
Modbus RTU, IEC60870-5-103, DNP3.0 RTU RS485/terminals				B ¹					
Modbus TCP, DNP3.0 TCP/UDP Ethernet 100 MB/RJ45				C ¹					
Profibus-DP optic fiber/ST-connector				D ¹					
Profibus-DP RS485/D-SUB				E ¹					
Modbus RTU, IEC60870-5-103, DNP3.0 RTU optic fiber/ST-connector				F ¹					
Modbus RTU, IEC60870-5-103, DNP3.0 RTU RS485/D-SUB				G ¹					
IEC61850, Modbus TCP, DNP3.0 TCP/UDP Ethernet 100MB/RJ45				H ¹					
IEC60870-5-103, Modbus RTU, DNP3.0 RTU RS485/terminals				I ¹					
Modbus TCP, DNP3.0 TCP/UDP Ethernet 100 MB/RJ45									
IEC61850, Modbus TCP, DNP3.0 TCP/UDP Optical Ethernet 100MB/LC duplex connector				K ¹					
Modbus TCP, DNP3.0 TCP/UDP Optical Ethernet 100MB/LC duplex connector				L ¹					
IEC 60870-5-103, Modbus RTU, DNP 3.0 RTU RS485/terminals									
IEC 61850, Modbus TCP, DNP 3.0 TCP/UDP Ethernet 100 MB/RJ45				T ¹					
HARSH ENVIRONMENT OPTION									
None				A					
Conformal Coating				B					
AVAILABLE MENU LANGUAGES									
Standard English/German/Spanish/Russian/Polish/Portuguese/French/Romanian									

¹ = Within every communication option only one communication protocol is usable.

ANSI: 50, 51, 67, 51C, 51V, 25, 50N, 51N, 67N, 50Ns, 51Ns, 67Ns, 46, 49, 27, 59, 59N, 51Q, 81U/O, 60FL, 79, 86, 50BF, 74TC, 81R, 78, 47, 60FL, 60L, 32F, 37F, 32Q, 37Q, 37QR, 32S, 37S, 37R, 55, 51C, LVRT, Q->V, UFLS

The parameterizing and disturbance analyzing Software Smart view is included in delivery of HighPROTEC devices.

Communication cable USB Type mini-B required (part number 5450-1946).

With control functions for up to 6 switchgears and logic up to 80 equations.



MRA4-2 Directional Feeder Protection

Product Spec DOK-FLY-MRA4-2

		MRA4	-2						
Version 2 with USB, enhanced communication and user options									
DIGITAL INPUTS	BINARY OUTPUT RELAYS	HOUSING	LARGE DISPLAY						
8	7	B2	-	A					
16	13	B2	-	D					
HARDWARE VARIANT 2									
Phase current 5 A/1 A, Ground Current 5 A/1 A				0					
Phase Current 5 A/1 A, Sensitive Ground Current 5 A/1 A				1					
HOUSE AND MOUNTING									
Door mounting				A					
Door mounting 19" (flush mounting)				B					
COMMUNICATION PROTOCOL									
Without protocol				A					
Modbus RTU, IEC60870-5-103, DNP3.0 RTU RS485/terminals				B ¹					
Modbus TCP, DNP3.0 TCP/UDP Ethernet 100 MB/RJ45				C ¹					
Profibus-DP optic fiber/ST-connector				D ¹					
Profibus-DP RS485/D-SUB				E ¹					
Modbus RTU, IEC60870-5-103, DNP3.0 RTU optic fiber/ST-connector				F ¹					
Modbus RTU, IEC60870-5-103, DNP3.0 RTU RS485/D-SUB				G ¹					
IEC61850, Modbus TCP, DNP3.0 TCP/UDP Ethernet 100MB/RJ45				H ¹					
IEC60870-5-103, Modbus RTU, DNP3.0 RTU RS485/terminals				I ¹					
Modbus TCP, DNP3.0 TCP/UDP Ethernet 100 MB/RJ45									
IEC61850, Modbus TCP, DNP3.0 TCP/UDP Optical Ethernet 100MB/LC duplex connector				K ¹					
Modbus TCP, DNP3.0 TCP/UDP Optical Ethernet 100MB/LC duplex connector				L ¹					
IEC 60870-5-103, Modbus RTU, DNP 3.0 RTU RS485/terminals									
IEC 61850, Modbus TCP, DNP 3.0 TCP/UDP Ethernet 100 MB/RJ45				T ¹					
HARSH ENVIRONMENT OPTION									
None				A					
Conformal Coating				B					
AVAILABLE MENU LANGUAGES									
Standard English/German/Spanish/Russian/Polish/Portuguese/French/Romanian									

ANSI: 50, 51, 67, 51C, 51V, 25, 50N, 51N, 67N, 50Ns, 51Ns, 67Ns, 46, 49, 27, 59, 59N, 51Q, 81U/O, 60FL, 79, 86, 50BF, 74TC, 81R, 78, 47, 60FL, 60L, 32F, 37F, 32Q, 37Q, 37QR, 32S, 37S, 37R, 55, 51C, LVRT, Q->V, UFLS

The parameterizing and disturbance analyzing Software Smart view is included in delivery of HighPROTEC devices.

Communication cable USB Type mini-B required (part number 5450-1946).

With control function for 1 switchgear and logic up to 80 equations.



HighPROTEC-2 LINE

Protection Relays

MRI4-2 Non-directional Feeder Protection

Product Spec_DOK-FLY-MRI4-2

MRI4 -2							
Version 2 with USB, enhanced communication and user options							
DIGITAL INPUTS	BINARY OUTPUT RELAYS	HOUSING	LARGE DISPLAY				
8	6	B1	-	A			
HARDWARE VARIANT 2							
Phase Current 5 A/1 A, Ground Current 5 A/1 A				0			
Phase Current 5 A/1 A, Sensitive Ground Current 5 A/1 A				1			
HOUSE AND MOUNTING							
Door mounting				A			
Door mounting 19" (flush mounting)				B			
COMMUNICATION PROTOCOL							
Without protocol				A			
Modbus RTU, IEC60870-5-103, DNP3.0 RTU RS485/terminals				B ¹			
Modbus TCP, DNP3.0 TCP/UDP Ethernet 100 MB/RJ45				C ¹			
Profibus-DP optic fiber/ST-connector				D ¹			
Profibus-DP RS485/D-SUB				E ¹			
Modbus RTU, IEC60870-5-103, DNP3.0 RTU optic fiber/ST-connector				F ¹			
Modbus RTU, IEC60870-5-103, DNP3.0 RTU RS485/D-SUB				G ¹			
IEC61850, Modbus TCP, DNP3.0 TCP/UDP Ethernet 100MB/RJ45				H ¹			
IEC60870-5-103, Modbus RTU, DNP3.0 RTU RS485/terminals				I ¹			
Modbus TCP, DNP3.0 TCP/UDP Ethernet 100 MB/RJ45				I ¹			
IEC61850, Modbus TCP, DNP3.0 TCP/UDP Optical Ethernet 100MB/LC duplex connector				K ¹			
Modbus TCP, DNP3.0 TCP/UDP Optical Ethernet 100MB/LC duplex connector				L ¹			
IEC 60870-5-103, Modbus RTU, DNP 3.0 RTU RS485/terminals				T ¹			
IEC 61850, Modbus TCP, DNP 3.0 TCP/UDP Ethernet 100 MB/RJ45				T ¹			
HARSH ENVIRONMENT OPTION							
None				A			
Conformal Coating				B			
AVAILABLE MENU LANGUAGES							
Standard English/German/Spanish/Russian/Polish/Portuguese/French/Romanian							

ANSI: 50, 51, 50N, 51N, 51Q, 46, 49, 60L, 79, 86, 50BF, 74TC

The parameterizing and disturbance analyzing Software Smart view is included in delivery of HighPROTEC devices.
Communication cable USB Type mini-B required (part number 5450-1946).
With control function for 1 switchgear and logic up to 80 equations.



MRU4-2 Voltage and Frequency Supervision

Product Spec_DOK-FLY-MRU4-2

MRU4 -2							
Version 2 with USB, enhanced communication and user options							
DIGITAL INPUTS	BINARY OUTPUT RELAYS	HOUSING	LARGE DISPLAY				
8	6	B1	-	A			
HARDWARE VARIANT 2							
Standard				0			
HOUSE AND MOUNTING							
Door mounting				A			
Door mounting 19" (flush mounting)				B			
COMMUNICATION PROTOCOL							
Without protocol				A			
Modbus RTU, IEC60870-5-103, DNP3.0 RTU RS485/terminals				B ¹			
Modbus TCP, DNP3.0 TCP/UDP Ethernet 100 MB/RJ45				C ¹			
Profibus-DP optic fiber/ST-connector				D ¹			
Profibus-DP RS485/D-SUB				E ¹			
Modbus RTU, IEC60870-5-103, DNP3.0 RTU optic fiber/ST-connector				F ¹			
Modbus RTU, IEC60870-5-103, DNP3.0 RTU RS485/D-SUB				G ¹			
IEC61850, Modbus TCP, DNP3.0 TCP/UDP Ethernet 100MB/RJ45				H ¹			
IEC60870-5-103, Modbus RTU, DNP3.0 RTU RS485/terminals				I ¹			
Modbus TCP, DNP3.0 TCP/UDP Ethernet 100 MB/RJ45				I ¹			
IEC61850, Modbus TCP, DNP3.0 TCP/UDP Optical Ethernet 100MB/LC duplex connector				K ¹			
Modbus TCP, DNP3.0 TCP/UDP Optical Ethernet 100MB/LC duplex connector				L ¹			
IEC 60870-5-103, Modbus RTU, DNP 3.0 RTU RS485/terminals				T ¹			
IEC 61850, Modbus TCP, DNP 3.0 TCP/UDP Ethernet 100 MB/RJ45				T ¹			
HARSH ENVIRONMENT OPTION							
None				A			
Conformal Coating				B			
AVAILABLE MENU LANGUAGES							
Standard English/German/Spanish/Russian/Polish/Portuguese/French/Romanian							

¹ = Within every communication option only one communication protocol is usable.

ANSI: 25, 27, 59, 59N, 81U/O, 60FL, 47, 86, 74TC, 81R, 81O/U, 78, ROCOF, FRT, 62BF

The parameterizing and disturbance analyzing Software Smart view is included in delivery of HighPROTEC devices.
Communication cable USB Type mini-B required (part number 5450-1946).
With control function for 1 switchgear and logic up to 80 equations.



HighPROTEC-2 LINE

Protection Relays

MRDT4-2 Transformer Differential Protection

Product Spec DOK-FLY-MRDT4-2

MRDT4		-2						
Version 2 with USB, enhanced communication and user options								
DIGITAL INPUTS	BINARY OUTPUT RELAYS	HOUSING	LARGE DISPLAY					
8	7	B2	-	A				
16	13	B2	-	D				
HARDWARE VARIANT 2								
Phase Current 5 A/1 A, Ground Current 5 A/1 A				0				
Phase Current 5 A/1 A, W1 Sen. Gr. Curr. 5 A/1 A, W2 Gr. Curr. 5 A/1 A				1				
Phase Current 5 A/1 A, W1 Gr. Curr. 5 A/1 A, W2 Sen. Gr. Curr. 5 A/1 A				2				
Phase Current 5 A/1 A, W1 Sen. Gr. Curr. 5 A/1 A, Sen. Gr. Curr. 5 A/1 A				3				
HOUSE AND MOUNTING								
Door mounting				A				
Door mounting 19" (flush mounting)				B				
COMMUNICATION PROTOCOL								
Without protocol				A				
Modbus RTU, IEC60870-5-103, DNP3.0 RTU RS485/terminals				B ¹				
Modbus TCP, DNP3.0 TCP/UDP Ethernet 100 MB/RJ45				C ¹				
Profibus-DP optic fiber/ST-connector				D ¹				
Profibus-DP RS485/D-SUB				E ¹				
Modbus RTU, IEC60870-5-103, DNP3.0 RTU optic fiber/ST-connector				F ¹				
Modbus RTU, IEC60870-5-103, DNP3.0 RTU RS485/D-SUB				G ¹				
IEC61850, Modbus TCP, DNP3.0 TCP/UDP Ethernet 100MB/RJ45				H ¹				
IEC60870-5-103, Modbus RTU, DNP3.0 RTU RS485/terminals				I ¹				
Modbus TCP, DNP3.0 TCP/UDP Ethernet 100 MB/RJ45				J ¹				
IEC61850, Modbus TCP, DNP3.0 TCP/UDP Optical Ethernet 100MB/LC duplex connector				K ¹				
Modbus TCP, DNP3.0 TCP/UDP Optical Ethernet 100MB/LC duplex connector				L ¹				
IEC 60870-5-103, Modbus RTU, DNP 3.0 RTU RS485/terminals				M ¹				
IEC 61850, Modbus TCP, DNP 3.0 TCP/UDP Ethernet 100 MB/RJ45				T ¹				
HARSH ENVIRONMENT OPTION								
None				A				
Conformal Coating				B				
AVAILABLE MENU LANGUAGES								
Standard English/German/Spanish/Russian/Polish/Portuguese/French/Romanian								

ANSI: 50, 51, 50N, 51N, 46, 49T, 60L, 86, 50BF, 74TC, 60L, 64REF, 87G, 87T

The parameterizing and disturbance analyzing Software Smart view is included in delivery of HighPROTEC devices.

Communication cable USB Type mini-B required (part number 5450-1946).

With control function for 2 switchgears and logic up to 80 equations.

Optional: Remote temperature detection box is available on request (up to 12 sensors)



MCDTV4-2 Directional Transformer Differential Protection

Product Spec DOK-FLY-MCDTV4-2

MCDTV4		-2						
Version 2 with USB, enhanced communication and user options								
DIGITAL INPUTS	BINARY OUTPUT RELAYS	ANALOG INPUTS- / OUTPUTS	HOUSING	LARGE DISPLAY				
16	11	0/0	B2	X	A			
8	11	2/2	B2	X	B			
HARDWARE VARIANT 2								
Phase Current 5 A/1 A, Ground Current 5 A/1 A				0				
Phase Current 5 A/1 A, W1 Sen. Gr. Curr. 5 A/1 A, W2 Gr. Curr. 5 A/1 A				1				
Phase Current 5 A/1 A, W1 Gr. Curr. 5 A/1 A, W2 Sen. Gr. Curr. 5 A/1 A				2				
Phase Current 5 A/1 A, W1/W2 Sen. Gr. Curr. 5 A/1 A				3				
HOUSE AND MOUNTING								
Door mounting				A				
Door mounting 19" (flush mounting)				B				
COMMUNICATION PROTOCOL								
Without protocol				A				
Modbus RTU, IEC60870-5-103, DNP3.0 RTU RS485/terminals				B ¹				
Modbus TCP, DNP3.0 TCP/UDP Ethernet 100 MB/RJ45				C ¹				
Profibus-DP optic fiber/ST-connector				D ¹				
Profibus-DP RS485/D-SUB				E ¹				
Modbus RTU, IEC60870-5-103, DNP3.0 RTU optic fiber/ST-connector				F ¹				
Modbus RTU, IEC60870-5-103, DNP3.0 RTU RS485/D-SUB				G ¹				
IEC61850, Modbus TCP, DNP3.0 TCP/UDP Ethernet 100MB/RJ45				H ¹				
IEC60870-5-103, Modbus RTU, DNP3.0 RTU RS485/terminals				I ¹				
Modbus TCP, DNP3.0 TCP/UDP Ethernet 100 MB/RJ45				J ¹				
IEC61850, Modbus TCP, DNP3.0 TCP/UDP Optical Ethernet 100MB/LC duplex connector				K ¹				
Modbus TCP, DNP3.0 TCP/UDP Optical Ethernet 100MB/LC duplex connector				L ¹				
IEC 60870-5-103, Modbus RTU, DNP 3.0 RTU RS485/terminals				M ¹				
IEC 61850, Modbus TCP, DNP 3.0 TCP/UDP Ethernet 100 MB/RJ45				T ¹				
HARSH ENVIRONMENT OPTION								
None				A				
Conformal Coating				B				
AVAILABLE MENU LANGUAGES								
Standard English/German/Spanish/Russian/Polish/Portuguese/French/Romanian								

ANSI: 87T, 87N (64REF), 24, 50, 51, 67, 67P, 51V, 51C, 50N, 51N, 67N, 50Ns, 51Ns, 67Ns, 46, 49, 27, 59, 59N, 81U/O, 81R, 78, 47, 32, 55, 60L, 60FL, 86, 50BF, 74TC, 25, 37, LVRT, Q->V, UFLS

The parameterizing and disturbance analyzing Software Smart view is included in delivery of HighPROTEC devices.

Communication cable USB Type mini-B required (part number 5450-1946).

With control functions for up to 6 switchgears and logic up to 80 equations.

Optional: Remote temperature detection box is available on request (up to 12 sensors)



HighPROTEC-2 LINE

Protection Relays

MRM4-2 Motor Protection

Product Spec DOK-FLY-MRM4-2

MRM4 -2												
Version 2 with USB, enhanced communication and user options												
DIGITAL INPUTS	BINARY OUTPUT	ANALOG INPUTS- /	RTD-BOX	HOUSING	LARGE DISPLAY							
8	6	0/0	-	B1	-	A						
4	4	0/1	X	B1	-	B						
HARDWARE VARIANT 2												
Phase Current 5 A/1 A, Ground Current 5 A/1 A							0					
Phase Current 5 A/1 A, Sensitive Ground Current 5 A/1 A							1					
HOUSE AND MOUNTING												
Door mounting							A					
Door mounting 19" (flush mounting)							B					
COMMUNICATION PROTOCOL												
Without protocol							A					
Modbus RTU, IEC60870-5-103, DNP3.0 RTU RS485/terminals							B ¹					
Modbus TCP, DNP3.0 TCP/UDP Ethernet 100 MB/RJ45							C ¹					
Profibus-DP optic fiber/ST-connector							D ¹					
Profibus-DP RS485/D-SUB							E ¹					
Modbus RTU, IEC60870-5-103, DNP3.0 RTU optic fiber/ST-connector							F ¹					
Modbus RTU, IEC60870-5-103, DNP3.0 RTU RS485/D-SUB							G ¹					
IEC61850, Modbus TCP, DNP3.0 TCP/UDP Ethernet 100MB/RJ45							H ¹					
IEC60870-5-103, Modbus RTU, DNP3.0 RTU RS485/terminals							I ¹					
Modbus TCP, DNP3.0 TCP/UDP Ethernet 100 MB/RJ45												
IEC61850, Modbus TCP, DNP3.0 TCP/UDP Optical Ethernet 100MB/LC duplex connector							K ¹					
Modbus TCP, DNP3.0 TCP/UDP Optical Ethernet 100MB/LC duplex connector							L ¹					
IEC 60870-5-103, Modbus RTU, DNP 3.0 RTU RS485/terminals												
IEC 61850, Modbus TCP, DNP 3.0 TCP/UDP Ethernet 100 MB/RJ45							T ¹					
HARSH ENVIRONMENT OPTION												
None							A					
Conformal Coating							B					
AVAILABLE MENU LANGUAGES												
Standard English/German/Spanish/Russian/Polish/Portuguese/French/Romanian												

¹ = Within every communication option only one communication protocol is usable.

ANSI: 46, 48, 49M, 49R, 49S, 50J, 37, 50, 51, 51LRS, 51LR, 50N, 51N, 60L, 66, 86, 50BF, 74TC

The parameterizing and disturbance analyzing Software Smart view is included in delivery of HighPROTEC devices.

Communication cable USB Type mini-B required (part number 5450-1946).

With control function for 1 switchgear and logic up to 80 equations.

Optional: Remote temperature detection box is available on request (up to 12 sensors)



MRMV4-2 Motor Protection with Voltage /Frequency

Product Spec DOK-FLY-MRMV4-2

MRMV4 -2												
Version 2 with USB, enhanced communication and user options												
DIGITAL INPUTS	BINARY OUTPUT RELAYS	ANALOG INPUTS- / OUTPUTS	HOUSING	LARGE DISPLAY								
8	7	0/4	B2	-	A							
8	13	0/4	B2	-	C							
HARDWARE VARIANT 2												
Phase Current 5 A/1 A, Ground Current 5 A/1 A							0					
Phase Current 5 A/1 A, Sensitive Ground Current 5 A/1 A							1					
HOUSE AND MOUNTING												
Door mounting							A					
Door mounting 19" (flush mounting)							B					
COMMUNICATION PROTOCOL												
Without protocol							A					
Modbus RTU, IEC60870-5-103, DNP3.0 RTU RS485/terminals							B ¹					
Modbus TCP, DNP3.0 TCP/UDP Ethernet 100 MB/RJ45							C ¹					
Profibus-DP optic fiber/ST-connector							D ¹					
Profibus-DP RS485/D-SUB							E ¹					
Modbus RTU, IEC60870-5-103, DNP3.0 RTU optic fiber/ST-connector							F ¹					
Modbus RTU, IEC60870-5-103, DNP3.0 RTU RS485/D-SUB							G ¹					
IEC61850, Modbus TCP, DNP3.0 TCP/UDP Ethernet 100MB/RJ45							H ¹					
IEC60870-5-103, Modbus RTU, DNP3.0 RTU RS485/terminals							I ¹					
Modbus TCP, DNP3.0 TCP/UDP Ethernet 100 MB/RJ45												
IEC61850, Modbus TCP, DNP3.0 TCP/UDP Optical Ethernet 100MB/LC duplex connector							K ¹					
Modbus TCP, DNP3.0 TCP/UDP Optical Ethernet 100MB/LC duplex connector							L ¹					
IEC 60870-5-103, Modbus RTU, DNP 3.0 RTU RS485/terminals												
IEC 61850, Modbus TCP, DNP 3.0 TCP/UDP Ethernet 100 MB/RJ45							T ¹					
HARSH ENVIRONMENT OPTION												
None							A					
Conformal Coating							B					
AVAILABLE MENU LANGUAGES												
Standard English/German/Spanish/Russian/Polish/Portuguese/French/Romanian												

ANSI: 46, 48, 49M, 49R, 49S, 50J, 37, 50, 51, 51C, 51V, 51Q, 51LRS, 51LR, 50N, 51N, 50Ns, 51Ns, 27, 59, 59N, 47, 37, 55, 66, 81U/0, 81R, 78, 60L, 60FL, 86, 50BF, 74TC

The parameterizing and disturbance analyzing Software Smart view is included in delivery of HighPROTEC devices.

Communication cable USB Type mini-B required (part number 5450-1946).

With control function for 1 switchgear and logic up to 80 equations.

Optional: Remote temperature detection box is available on request (up to 12 sensors)



HighPROTEC-2 LINE

Protection Relays

MCDGV4-2 Generator Protection with Differential

Product Spec DOK-FLY-MCDGV4-2

MCDGV4 -2										
Version 2 with USB, enhanced communication and user options										
DIGITAL INPUTS	BINARY OUTPUT RELAYS	ANALOG INPUTS- /	HOUSING	LARGE DISPLAY	VOLTAGE INPUTS					
16	11	0/0	B2	X	0-800 V	A				
8	11	2/2	B2	X	0-800 V	B				
24	11	0/0	B2	X	0-300 V	C				
16	16	0/0	B2	X	0-300 V	D				
HARDWARE VARIANT 2										
Phase Current 5 A/1 A, Ground Current 5 A/1 A						0				
Phase Current 5 A/1 A, Sensitive Ground Current 5 A/1 A						1				
HOUSE AND MOUNTING										
Door mounting						A				
Door mounting 19" (flush mounting)						B				
COMMUNICATION PROTOCOL										
Without protocol						A				
Modbus RTU, IEC60870-5-103, DNP3.0 RTU RS485/terminals						B ¹				
Modbus TCP, DNP3.0 TCP/UDP Ethernet 100 MB/RJ45						C ¹				
Profibus-DP optic fiber/ST-connector						D ¹				
Profibus-DP RS485/D-SUB						E ¹				
Modbus RTU, IEC60870-5-103, DNP3.0 RTU optic fiber/ST-connector						F ¹				
Modbus RTU, IEC60870-5-103, DNP3.0 RTU RS485/D-SUB						G ¹				
IEC61850, Modbus TCP, DNP3.0 TCP/UDP Ethernet 100MB/RJ45						H ¹				
IEC60870-5-103, Modbus RTU, DNP3.0 RTU RS485/terminals						I ¹				
Modbus TCP, DNP3.0 TCP/UDP Ethernet 100 MB/RJ45						J ¹				
IEC61850, Modbus TCP, DNP3.0 TCP/UDP Optical Ethernet 100MB/LC duplex connector						K ¹				
Modbus TCP, DNP3.0 TCP/UDP Optical Ethernet 100MB/LC duplex connector						L ¹				
IEC 60870-5-103, Modbus RTU, DNP 3.0 RTU RS485/terminals						T ¹				
IEC 61850, Modbus TCP, DNP 3.0 TCP/UDP Ethernet 100 MB/RJ45										
HARSH ENVIRONMENT OPTION										
None						A				
Conformal Coating						B				
AVAILABLE MENU LANGUAGES										
Standard English/German/Spanish/Russian/Polish/Portuguese/French/Romanian										

¹ = Within every communication option only one communication protocol is usable.
Smart view can be used in parallel via the Ethernet interface (RJ45).

ANSI: 87G, 87GT, 87N (64REF), 21P, 24, 40, 59TN/27TN, 50, 51, 67, 67P, 51V, 51C, 50N, 51N, 67N, 50Ns, 51Ns, 67Ns, 46, 49, 27, 59, 59N, 81U/O, 81R, 78, 78PS, 47, 32, 55, 60FL, 86, 50BF, 74TC, 25, 37, LVRT, Q->V

The parameterizing and disturbance analyzing Software Smart view is included in delivery of HighPROTEC devices.

Communication cable USB Type mini-B required (part number 5450-1946).

With control functions for up to 6 switchgears and logic up to 80 equations.

Optional: Remote temperature detection box is available on request (up to 12 sensors)



MCDLV4-2 Line Differential Protection

Product Spec DOK-FLY-MCDLV4-2

MCDLV4 -2										
Version 2 with USB, enhanced communication and user options										
DIGITAL INPUTS	BINARY OUTPUT RELAYS	VOLTAGE MEASURING	HOUSING	LARGE DISPLAY	VOLTAGE INPUTS					
8	7	X	B2	X	0-800 V	A				
16	13	X	B2	X	0-800 V	D				
24	20	X	B2	X	0-300 V	E				
HARDWARE VARIANT 2										
Phase Current 5 A/1 A, Ground Current 5 A/1 A						0				
Phase Current 5 A/1 A, Sensitive Ground Current 5 A/1 A						1				
HOUSE AND MOUNTING										
Door mounting						A				
Door mounting 19" (flush mounting)						B				
INTERDEVICE COMMUNICATION										
LC duplex connector, mono mode (up to 24 km), multi mode (up to 4 km)						0				
ST connector, BFOC2.5, multi mode (up to 2 km)						1				
COMMUNICATION PROTOCOL										
Without protocol						A				
Modbus RTU, IEC60870-5-103, DNP3.0 RTU RS485/terminals						B ¹				
Modbus TCP, DNP3.0 TCP/UDP Ethernet 100 MB/RJ45						C ¹				
Profibus-DP optic fiber/ST-connector						D ¹				
Profibus-DP RS485/D-SUB						E ¹				
Modbus RTU, IEC60870-5-103, DNP3.0 RTU optic fiber/ST-connector						F ¹				
Modbus RTU, IEC60870-5-103, DNP3.0 RTU RS485/D-SUB						G ¹				
IEC61850, Modbus TCP, DNP3.0 TCP/UDP Ethernet 100MB/RJ45						H ¹				
IEC60870-5-103, Modbus RTU, DNP3.0 RTU RS485/terminals						I ¹				
Modbus TCP, DNP3.0 TCP/UDP Ethernet 100 MB/RJ45						J ¹				
IEC61850, Modbus TCP, DNP3.0 TCP/UDP Optical Ethernet 100MB/LC duplex connector						K ¹				
Modbus TCP, DNP3.0 TCP/UDP Optical Ethernet 100MB/LC duplex connector						L ¹				
IEC 60870-5-103, Modbus RTU, DNP 3.0 RTU RS485/terminals						T ¹				
IEC 61850, Modbus TCP, DNP 3.0 TCP/UDP Ethernet 100 MB/RJ45										
HARSH ENVIRONMENT OPTION										
None						A				
Conformal Coating						B				
AVAILABLE MENU LANGUAGES										
Standard English/German/Spanish/Russian/Polish/Portuguese/French/Romanian										

¹ = Within every communication option only one communication protocol is usable.
Smart view can be used in parallel via the Ethernet interface (RJ45).

ANSI: 87G, 87GT, 87L, 87T, 87N (64REF), 24, 40, 59TN/27TN, 50, 51, 67, 51V, 51C, 50N, 51N, 67N, 50Ns, 51Ns, 67Ns, 46, 49, 27, 59, 59N, 81U/O, 81R, 78, 47, 32, 55, 60FL, 86, 50BF, 74TC, 25, 37, LVRT, Q->V, ULFS

The parameterizing and disturbance analyzing Software Smart view is included in delivery of HighPROTEC devices.

Communication cable USB Type mini-B required (part number 5450-1946).

With control functions for up to 6 switchgears and logic up to 80 equations.



HighPROTEC LINE SERVICES

Protection Relays

HighPROTEC Services

HPTCON	
Creating of the device configuration for the protection in house according to customer data based on check lists per variation and device typ. Programming of the device configuration in house is included	01
Creating of the device configuration for the protection, logic and single line in house. The configuration will be effected after customer clarification according to customer data based per variation and device type. Programming of the device configuration in house is included	02
Programming of the device configuration per device in house	03

HighPROTEC LINE COMMUNICATION & ACCESSORIES

HighPROTEC Communication & Accessories

COMRS232Nullm for HighPROTEC 1 devices with serial interface	
RS232 ZERO MODEM CABLE WITH HANDSHAKE (3 M) ¹ Cable for PC – device communication	
5450-1946 for HighPROTEC 2 devices with USB	
SMART VIEW TO PROTECTION RELAY CONNECTION CABLE Standard USB to 5-Pole [USB-B Mini Male 1.8 M (EDS)]	
HPTDF1	
HIGHPROTEC DISTANCE FRAME	
Frame for B1 housing 60 mm depth	1
Frame for B2 housing 60 mm depth	2
URTD	
UNIVERSAL RESISTOR TEMPERATURE BOX (FOR HIGHPROTEC DEVICES)	
Up to 12 sensors, PT100, Ni100, Ni120, Cu10, 48-240 VAC / 48-250 VDC	01
Up to 12 sensors, PT100, Ni100, Ni120, Cu10, 24- 48 VDC	02
HPTURTDCON	
FIBRE OPTIC CABEL URDT	
Fibre optic cable 5 m	5M
Fibre optic cable 10 m	10M
Fibre optic cable 25 m	25M
The fibre optic cabel is necessary to connect the URDT box with the HighPROTEC devices.	
HPTTERMKIT	
TERMINAL KITS HIGHPROTEC FOR PRE WIRING	
For devices MRI4 / MRM4	1
For device MRU4	2
For devices MRA4D / MRMV4A / MCA4D	3
For devices MRDT4	4
For devices MCDGV4A / MCDGV4B / MCDTV4A / MCDTV4B	5
HPTCTCON1	
KIT - HPT CT SOCKET	
Current Transformer Terminals Socket for HighPROTEC	
HPTCTBLOCK1	
TERMINAL FOR CURRENT MEASUREMENT	
For devices MRI4 / MRM4 / MRMV4 / MRA4 / MCA4 / MCDTV4 / MRDT4 / MCDGV4	
3061-2866	
PLEASE USE THE PDF TEMPLATE ON THE PRODUCT CD FOR LED TEXT INFORMATION	
Transparent Front Foil for Inserts	
CSPHPTADAP	
MOUNTING PLATE	
Mounting plate door CSP to HPT	

HIGH TECH LINE 3

FEATURE OVERVIEW

Protection Relays



High Tech Line 3

		MR	IR
INDIVIDUAL FUNCTIONS			
Phase current (nondirectional)	ANSI 50/51	I ¹	-
Phase current (directional)	50/51/67	I ¹	-
Earth fault (nondirectional)	50N/51N	I ¹	I ¹
Earth fault (directional)	67N	I ¹	-
Circuit breaker failure protection	BF	I ¹	-
Negative sequence (current)	46	S	-
Voltage	27/59	U ¹	U ¹
Residual voltage	59N	U ¹	U ¹
DC voltage	27DC/39DC	-	U ¹
Phase balance (voltage)	47	U ¹	-
Frequency	81	F3	-
Power	32	P	-
Differential protection	87	D ¹	-
Rotor earth fault (DC)	64	R	-
Auto reclosing	79	K	-
Lockout function	86	L	-
Field failure (Impedance)	40	Q	-
Exciter failure (DC)	40/76	R	-
Trip circuit supervision	74 TC	T	-
Phase sequence	47	U ¹	-
COMBINATIONS			
Phase current and earth current (directional or nondirectional)	50/51/67 50N/51N/67N	I ¹	-
Phase current and earth current and CB failure and AR (nondirectional)	50/51/50N/ 51N/BF/79	IK	-
Phase current and earth current and thermal replica (nondirectional)	50/51/50N/ 51N/49	IT ¹	-
Mains decoupling (U/f/vector)	27/59/81/78	N3 ¹	-
Mains decoupling (U/f/df/dt)	27/59/81	N3 ¹	-
Motor protection (various functions)	37/46/48/49/50/51	M ¹	-
Generator protection	27/59/81/78/ 50/51/50N/51N/BF	G ¹	-
LINE FEATURES			
Housing technology 19"/flush mounting		•	•
Panel mounting		◦	◦
Display (measuring values and parameters)		•	-
Indication of primary measuring values		◦ ²	-
Interface		•	-
Setting via buttons		•	-
Setting via DIP-switches		-	•
Fault recorder		•	-
Disturbance recorder, clock, 2 parameter sets		◦ ²	-
Number of output relays		5	1 or 2
Password protection		•	-

• = Standard ◦ = Optional ¹ Various types with this prefix ² with High Tech Line 3 devices type MR_3 only

HIGH TECH LINE 3

MRI3 Time Overcurrent and Earth Fault Current Relay

	MRI3					
3-phase current I>, I>>	none	*				
Rated current	1 A 5 A	I1 I5				
Phase fault directional feature	none	*				
Rated voltage ²	100 V	R1				
Earth current measuring	none	*				
Rated current	standard 1 A 5 A sensitive 1 A 5 A	E1 E5 X1 X5				
Directional feature in earth path	none	*				
Rated voltage ² in earth circuits	100 V	R1				
Housing (12 TE)	19"-rack Flush mounting				A D	
Communication protocol RS485 Pro Open Data; MODBUS RTU						* M

* Please leave box empty if option is not desired (no extra charge).

THE FOLLOWING DEVICE VARIANTS CAN BE ORDERED:

MRI3E1D	MRI3I5E5A	MRI3I1R1E1R1A
MRI3E5D	MRI3I5E5D	MRI3I1R1E1R1D
MRI3E5DM	MRI3I5E5DM	MRI3I1X1R1DM
MRI3I1E1A	MRI3I5X1D	MRI3I1R1X1R1D
MRI3I1E1D	MRI3I5X5D	MRI3I5R1E1R1A
MRI3I1E1DM	MRI3I1R1E1A	MRI3I5R1E5R1D
MRI3I1X1D	MRI3I1R1E1D	MRI3I5R1E5R1DM
MRI3I1X1DM	MRI3I5R1E1D	MRI3I5X1R1DM
MRI3I5E1A		
MRI3I5E1D		
MRI3I5E1DM		

MRI3 Time Overcurrent/Earth Fault Current Relay with Control Function

	MRI3		C	D	M
3-phase current I>, I>>	none				
Rated current	1 A 5 A	I1 I5			
Control and supervision of one circuit breaker					
Rated earth current	1 A 5 A			E1 E5	
Housing (12 TE)	19"-rack				
Communication protocol MODBUS RTU					

THE FOLLOWING DEVICE VARIANTS CAN BE ORDERED:

MRI3I1CE1DM	MRI3I5CE5DM
-------------	-------------

HIGH TECH LINE 3

Protection Relays

MRI3 Time Overcurrent/Earth Fault Current Relay with Harmonic Stabilizing

MRI3			H		D
3-phase current I>, I>> Rated current	1 A 5 A	I1 I5			
Harmonic stabilizing					
Earth current	1 A 5 A			E1 E5	
Housing (12 TE)	Flush mounting				

THE FOLLOWING DEVICE VARIANTS CAN BE ORDERED:

MRI3I1HE1D	MRI3I5HE5D
------------	------------

MRI3 Time Overcurrent/Earth Fault Current Relay with Thermal Replica

MRI3			T			
3-phase current I>, I>> Rated current	1 A 5 A	I1 I5				
Thermal replica						
Rated earth current	1 A 5 A			E1 E5		
Directional feature in earth path Rated voltage in earth circuits	none 100 V				* R1	
Housing (12 TE)	19"-rack Flush mounting				A D	
Communication protocol RS485 Pro Open Data; MODBUS RTU						* M

* Please leave box empty if option is not desired (no extra charge).

THE FOLLOWING DEVICE VARIANTS CAN BE ORDERED:

MRI3I5TE5DM	MRI3I5TE1R1D	MRI3I5TE1R1DM
MRI3I5TE1D	MRI3I5TE5A	

MRI3 Time Earth Fault Current Relay

MRI3		LE5	D	M
Earth current IE>, IE>> - Simple version - No digital inputs - 2 output relays				
Rated current	5 A			
Housing (12 TE)	19"-rack			
Communication protocol MODBUS				

MRIK3 Time Overcurrent/Earth Fault Current Relay with Auto Reclosing Function

MRIK3				D	
3-phase current I>, I>> Rated current	1 A 5 A	I1 I5			
Rated current in earth circuits	1 A 5 A			E1 E5	
Housing (12 TE)	Flush mounting				
Communication protocol RS485 Pro Open Data; MODBUS RTU					* M

* Please leave box empty if option is not desired (no extra charge).

THE FOLLOWING DEVICE VARIANT CAN BE ORDERED:

MRIK3I5E5DM

MRIK3 Time Overcurrent/Earth Fault Current Relay with Auto Reclosing and Control Function

MRIK3			C		D	M
3-phase current I>, I>> Rated current	1 A 5 A	I1 I5				
Control and supervision of one circuit breaker						
Earth current measuring Rated current	standard 1 A sensitive 1 A			E1 X1		
Directional feature in earth path Rated voltage ² in earth circuits	none 100 V				* R1	
Housing (12 TE)	Flush mounting					
Communication protocol RS485 MODBUS RTU						

* Please leave box empty if option is not desired (no extra charge).

THE FOLLOWING DEVICE VARIANTS CAN BE ORDERED:

MRIK3I5CE1DM	MRIK3I5CE1R1DM	MRIK3I5CX1R1DM
--------------	----------------	----------------

HIGH TECH LINE 3

Protection Relays

Combined protection devices without the extended functional scope of the MR3 devices

MRI1 Time Overcurrent Relay with Multi-Characteristic

MRI1					D	
3-phase current I>, I>> Rated current	1 A 5 A	I1 I5				
Earth current standard	1 A 5 A		E1 E5			
Housing (12 TE)	Flush mounting					
Communication protocol RS485 Pro Open Data; MODBUS RTU						* M

THE FOLLOWING DEVICE VARIANTS CAN BE ORDERED:

MRI1I1E1D	MRI1I1E1DM
MRI1I5E5D	MRI1I5E5DM

MRI1 Voltage controlled time overcurrent relay

MRI1		I5			D
3-phase current I>, I>> Rated current	5 A				
Voltage dependent tripping characteristic Rated voltage	100 V 400 V		U1 U4		
Housing (12 TE)	Flush mounting				

THE FOLLOWING DEVICE VARIANTS CAN BE ORDERED:

MRI1I5U1D	MRI1I5U4D
-----------	-----------

MRG3 Generator Protection Relay with Voltage, Frequency, Vector Surge- and df/dt Supervision

MRG3					D
Time overcurrent protection Phase current	1 A rated current 5 A rated current	* I1 I5			
Earth fault protection ¹ Earth current	1 A rated current 5 A rated current		* E1 E5 U0		
Residual voltage					
Directional feature in earth path				* R	
Housing (12 TE)	Flush mounting				
Communication protocol RS485 Pro Open Data; MODBUS RTU					* M

* Please leave box empty if option is not desired (no extra charge).
¹ only in combination with time overcurrent protection

THE FOLLOWING DEVICE VARIANTS CAN BE ORDERED:

MRG3D	MRG3I1U0D	MRG3I1E1RD
MRG3DM	MRG3I5U0D	MRG3I5E5RD
MRG3I1D	MRG3I1E1D	
MRG3I5D	MRG3I5E5D	

MRN3 Mains Decoupling Relay/Interchange Protection

MRN3					
With voltage-, frequency and vector surge supervision Voltage, frequency and df/dt-supervision with voltage back up function according to BDEW guideline voltage (2 flexible voltage time characteristics, 3 standard steps) Frequency (3 steps) Vector surge and df/dt-supervision (1 step)		1 2 3			
Rated voltage	100 V 400 V		1 4		
Housing (12 TE)	19"-rack Flush mounting			A D	
Communication protocol RS485 Pro Open Data; MODBUS RTU					* M

THE FOLLOWING DEVICE VARIANTS CAN BE ORDERED:

MRN311D	MRN314DM	MRN331D
MRN311DM	MRN321D	
MRN311A	MRN321DM	
MRN314D	MRN324D	

MRU3 AC Voltage Relay

MRU3					
Standard incl. measuring of negative-, positive and zero sequence components		1 2			
Rated voltage	100 V 400 V		1 4		
Housing (12 TE)	19"-rack Flush mounting			A D	
Communication protocol RS485 Pro Open Data; MODBUS RTU					* M

THE FOLLOWING DEVICE VARIANTS CAN BE ORDERED:

MRU311D	MRU311DM	MRU321A	MRU321DM
MRU311A	MRU314DM	MRU321D	MRU324D

MRF3 Frequency Relay

MRF3			
Rated voltage	100 V	1	
Housing (12 TE)	19"-rack Flush mounting		A D

THE FOLLOWING DEVICE VARIANTS CAN BE ORDERED:

MRF31A	MRF31D
--------	--------

HIGH TECH LINE 3

Protection Relays

MRP2 Directional Active Power Relay

MRP2		3				
Measuring of reverse power only 2-steps, standard 2-steps, sensitive						
Power measurement	3-phase					
Rated current	1 A 5 A		I1 I5			
Rated voltage	100 V/110 V 400 V			U1 U4		
Housing (12 TE)	19"-rack Flush mounting				A D	
Communication protocol RS485 Pro Open Data; MODBUS RTU						* M

THE FOLLOWING DEVICE VARIANTS CAN BE ORDERED:

MRP23I5U4D	MRP2R3I1U1D	MRP2R3I5U1D	MRP2R3I1U1DM
MRP23I5U1DM	MRP2R3I1U1A		

MRS1 Negative Sequence Relay

MRS1					
Rated current	1 A 5 A		I1 I5		
Housing (12 TE)	19"-rack Flush mounting				A D

THE FOLLOWING DEVICE VARIANTS CAN BE ORDERED:

MRS1I1A	MRS1I1D	MRS1I5D
---------	---------	---------

MRQ1 Field Failure Relay

MRQ1					
Rated current	1 A 5 A		I1 I5		
Rated voltage	100 V 400 V			U1 U4	
Housing (12 TE)	19"-rack Flush mounting				A D

THE FOLLOWING DEVICE VARIANTS CAN BE ORDERED:

MRQ1I1U1D	MRQ1I5U4D	MRQ1I5U1A
MRQ1I5U1D	MRQ1I1U1A	

MRR1 Rotor Earth Fault Relay

MRR1			
Housing (12 TE)	19"-rack Flush mounting		A D

THE FOLLOWING DEVICE VARIANTS CAN BE ORDERED:

MRR1A	MRR1D
-------	-------

MRM3 Motor Protection Relay with Thermal Replica

MRM3		2			D	
With additional features such as: Characteristic curve for the maximal start-up time. Pick-up delay of the thermal overload. Tripping/warning mode of the thermal overload.						
Phase current measuring 3-phase current $I_{>}$, $I_{>>}$ Rated current			I1 I5			
Earth current measuring $I_{E>}$ Rated current	1 A 5 A				E1 E5	
Housing (12 TE)	Flush mounting					
Communication protocol RS485 Pro Open Data; MODBUS RTU						* M

THE FOLLOWING DEVICE VARIANTS CAN BE ORDERED:

MRM32I5E5DM	MRM32I5E5D	MRM32I1E1DM
MRM32I5E1DM	MRM32I1E1D	

HIGH TECH LINE 3

Protection Relays

MRL1 Lock-out Relay

MRL1				
Rated voltage	24 V/DC 48 V/DC 110 V/DC 220V/DC	operating range	18-32 V 30-60 V 66-150 V 150-300 V	24 48 110 220
Housing (12 TE)	19"-rack Flush mounting			A D

MRA1 Trip Circuit Supervision

MRA1				
Housing (12 TE)	Flush mounting			D

MRT1 Test Unit

MRT1				
Test insert individual - appertaining plastic housing with plug block for door installation				T BD

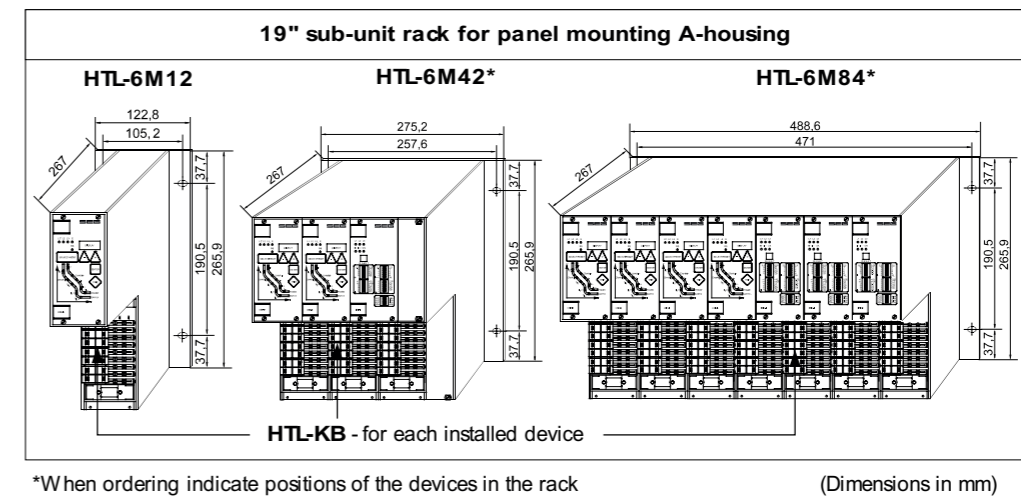
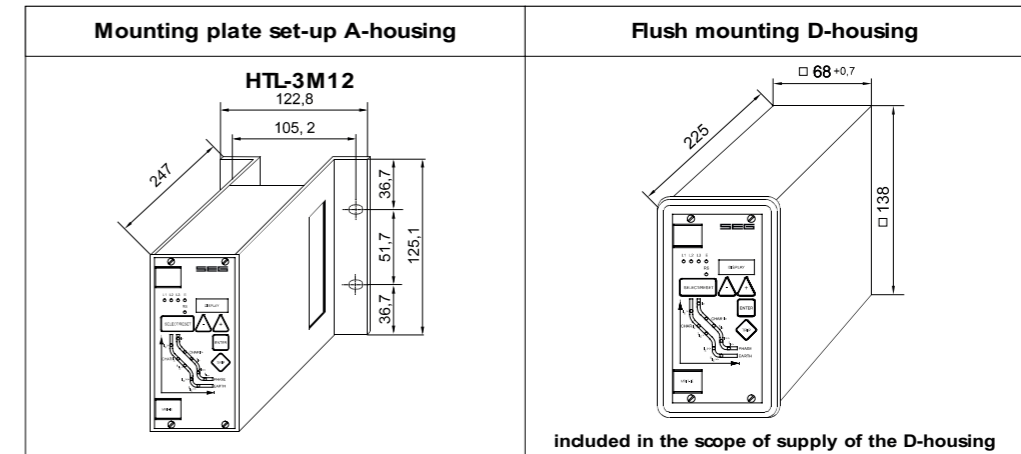

*When ordering indicate positions of the devices in the rack

(Dimensions in mm)

HIGH TECH LINE 3

Protection Relays

HTLTF Partial Space Front Plate 3HE

HTLTF		
For plug-in positions not used	partial front plate 6TE, 3HE (width like ½ MRI) partial front plate 12TE, 3HE (width like 1 MRI)	06 12

HTLAB HTL Contact Block Cover

HTLAB	
Protection against finger access for HTL A and B terminals	

HTL3M12 19" Rack System for Back Panel Mounting

HTL3M12	
Cable entry lateral, 3HE	

HTL6M12 19" Rack System for Back Panel Mounting

HTL6M12	
Connection from the front Module width 12TE (= e.g. 1 MRI1)	

Note: When ordering 6M versions, include one HTL-KB for each installed device in the order!

HTLKB Additional Contact Block for HTL-6M-Housing

HTLKB	
Additional contact block with cable tree for measuring inputs and contact outputs, required for every installed relay, fits all <i>High Tech Line</i> relays with 12 TE	

HTL/PL SOFT Diagnosis and Setting Software for HTL/PL Devices (German/English)

HTL/PLSOFT4	
Nearly (just a few have not yet been integrated) all HighTechLine protection can already set with "Smart view". Those relays need to be set by HTLPL-Soft.	

IRI1 Earth Fault Relay

IRI1		ER			D
Highly stabilized measuring					
Rated current	1 A 5 A		1 5		
Auxiliary voltage	24 V (16 to 60 V AC/16 to 80 V DC) 110 V (50 to 270 V AC/70 to 360 V DC)			L H	
Housing (12 TE)	Flush mounting				

IRU1 AC Voltage Relay

IRU1		UO		H	D
Under- and overvoltage AC					
Rated voltage	100 V 400 V		1 4		
Auxiliary voltage	110 V (50 to 270 V AC/70 to 360 V DC)				
Housing (12TE)	Flush mounting				

PROFESSIONAL/BASIC LINE

FEATURE OVERVIEW

Protection Relays

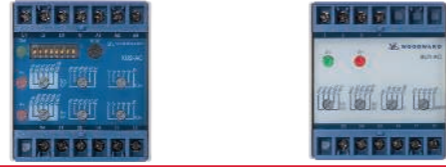

		Prof. Line X	Basic Line B
INDIVIDUAL FUNCTIONS			
	ANSI		
Phase current (nondirectional)	50/51	I ¹	-
Phase current (directional)	50/51/67	RI	-
Earth fault (nondirectional)	50N/51N	I ¹	-
Earth fault (directional)	67N	I ¹	-
Negative sequence (current)	46	S	-
Voltage	27/59	U ¹	U
Residual voltage	59N	U ¹	-
DC voltage	27DC/39DC	U ¹	-
Phase balance (voltage)	47	A	A
Frequency	81	F	F
Vector surge	78	G	-
Power	32	P	-
Differential protection	87	D ¹	-
Rotor earth fault (DC)	64	R	-
Exciter failure (DC)	40/76	E	-
Phase sequence	47	U ¹	-
COMBINATIONS			
Voltage and frequency	27/59/81	UF	-
Voltage and negative sequence	27/59/47	UA	-
Mains decoupling (U/f/vector)	27/59/81/78	RN N ¹	-
Mains decoupling (U/f/df/dt)	27/59/81	RW N ¹	-
Motor protection (various functions)	37/46/48 49/50/51	M	-
LINE FEATURES			
DIN rail installation		•	•
Display (measuring values and parameters)		only RW	RI RN
Interface		○	-
Setting via buttons		only RW	RI RN
Setting via potentiometer		•	•
Setting via DIP-switches		•	-
Number of output relays		2	2
Password protection		with software	-
Parameter software (HTL/PLSoft4)		○	-

• = Standard ○ = Optional ¹ Various types with this prefix

PROFESSIONAL LINE

XIII Time Overcurrent Relay

	XIII	
Rated current	1 A 5 A	1 5

XII Earth Fault Current Relay

	XII			
For resonant or isolated systems for solidly earthed systems		E S		
Without earth fault directional feature			*	
With earth fault directional feature			R	
Rated current	1 A 5 A			1 5

* Please leave box empty if option is not desired (no extra charge).

PROFESSIONAL LINE

Protection Relays

XRI1 Directional Overcurrent Relay (with display and serial interface)

XRI1			
Directional feature			
Rated current	1 A 5 A	I1 I5	
Rated voltage	400 V		R4

XRI1 Combined Time Overcurrent- and Earth Current Relay (with display and serial interface)

XRI1			
Rated current	1 A 5 A	I1 I5	
Rated current for earth current of resonant or isolated systems	1 A 5 A		E1 E5

THE FOLLOWING DEVICE VARIANTS CAN BE ORDERED:

XRI1I1E1	XRI1I5E5
----------	----------

XRI1 Earth Fault Current Relay (with display and serial interface)

XRI1			
Earth current measuring for isolated/compensated systems	Standard Sensitive	E X	
Rated current in earth circuits	1 A		
Directional feature in earth path			
Rated voltage in earth circuits	100 V		
Communication protocol RS485 Pro Open Data; MODBUS RTU			* M

THE FOLLOWING DEVICE VARIANTS CAN BE ORDERED:

XRI1E1R1	XRI1X1R1M
----------	-----------

XN2 Mains Decoupling Relay/Interchange Protection

XN2	
With voltage-, frequency- and vector surge supervision	1
With voltage-, frequency- and df/dt-supervision	2

XRN2 Mains Decoupling Relay/Interchange Protection (with display and serial interface)

XRN2		
With voltage-, frequency- and vector surge supervision		1
Voltage, frequency and df/dt-supervision		2
Rated voltage	100 V 400 V	1 4

XRW1 Mains Decoupling Relay/Interchange Protection for Wind Power Systems (with display and serial interface)

XRW1		
Voltage (8 steps)/frequency (3 steps)/ROCOF (1 step)		4
Rated voltage	400/690 V (direct connection without VT)	7

XUF2 AC Voltage and Frequency Relay 50/60 Hz

XUF2	

XUA1 AC Voltage and Phase Balance Relay

XUA1	

XU2AC AC Voltage Relay 50/60 Hz

XU2AC	

XU1DC DC Voltage Relay

XU1DC		
Rated voltage	100 - 500 V/DC 24 - 60 V/DC	1 2

PROFESSIONAL LINE

Protection Relays

XU1E Earth Fault Voltage Relay

XU1E

XF2 Frequency Relay 50/60 Hz

XF2

XG2 Generator-/Mains Monitor (Vector surge relay)

XG2

XP2R Power and Reverse Power Relay

	XP2R	
Rated current	1 A 5 A	1 5

XS2 Negative Sequence Relay

	XS2	
Rated current	1 A 5 A	1 5

XE2 DC Current Relay (Loss of excitation relay)

XE2

XR1 Rotor Earth Fault Relay

XR1

XM1 Motor Protection Relay

	XM1	
Rated current	1 A 5 A	1 5

XD1 Differential Protection Relay

	XD1				
Generator protection		G			
Primary rated current	1 A 5 A		1 5		
Secondary rated current	1 A 5 A			1 5	
none					*
Latching relay and manual reset					SP
none					*
Extra equipment for reliable functioning during CT saturation ¹					SAT

When ordering, please fill in and send data sheet from the documentation.

* Please leave box empty if option is not desired (no extra charge) ¹ We urgently recommend adding "SAT" with motor and transformer applications.

THE FOLLOWING DEVICE VARIANTS CAN BE ORDERED:

TRANSFORMER PROTECTION	LINE PROTECTION ¹	GENERATOR PROTECTION
XD1T11	XD1L11SP	XD1G11
XD1T11SAT	XD1L55SAT	XD1G11SAT
XD1T55SAT	XD1L55SPSAT	XD1G11SPSAT
XD1T55SPSAT		XD1G55
		XD1G55SAT
		XD1G55SPSAT

¹ The summation C.T.s are not included in price and have to be ordered separately.**XD1GW135** Summation C.T. for Line Differential Protection

	XD1GW135	
XD1-GW135-3 1/1/1/0.145A	1 A	3
XD1-GW135-4 5/5/5/0.145A	5 A	4

XRS1 Interface Adapter RS485

	XRS1	
Serial element in bus line		*
bus termination element (with termination resistor)		A

* Please leave box empty if option is not desired (no extra charge)

HTL/PL SOFT Diagnosis and Setting Software for HTL/PL Devices (German/English)

HTL/PLSOFT4

BASIC LINE

Protection Relays

BU1AC AC Voltage Relay

BU1AC		
Rated voltage	110 V/AC 400/230 V/AC (400 V four-wire-/two-wire-system) 690/400 V/AC (690 V two-wire-system/ 400 V three-wire-system)	110 230 400

BUA1 Voltage- and Voltage Balance Relay

BUA1		
Rated voltage	110 V/AC 230 V/AC 400 V/AC	110 230 400

BU1DC2 DC Voltage Relay

BU1DC2		
Rated voltage	24 V/DC	24

BF1 Frequency Relay

BF1		
Rated voltage	110 V/AC 230 V/AC 400 V/AC	110 230 400

BN1400 Mains Decoupling Relay/Interchange Protection

BN1400		
Combination of:	Voltage frequency vector surge	

WI LINE

FEATURE OVERVIEW

Protection Relays



		WIB1	WIC1	WIP1
SINGLE FUNCTIONS				
ANSI				
Phase current (independent)	50/51	•	•	•
Phase current (multi-characteristic)	50/51	•	•	•
Short circuit protection	50/51	•	•	•
Number of overcurrent elements		•	•	2
Earth current (multi-characteristic)	50N/51N	•	o ¹	•
Number of earth current elements		2	1	2
LINE FEATURES				
DIN rail mounting		-	-	•
Panel mounting		•	•	•
Primary conductor		-	-	-
Display (Measuring values and parameters)		-	-	•
Setting via PC Software		-	o	•
Setting via buttons		-	-	•
Setting via rotary switch		-	o	-
Setting via DIP-switches		•	o	-
Setting via code jumpers		-	-	-
Standard CT (1 A /5 A)		-	-	1 A
Special CT (sec. rated current)		Wide range	Wide range	-
Connection for test winding		o	•	-
LED activation indicator		-	•	-
Rated frequency Hz		50/60	50/60	50/60
Fault recorder		•	•	•
Clock		-	-	•
Password protection		•	•	•
Electro impulse-/Relay contact output		E	E	both
Flag indicator output		2	1	1
Number of output relays W = change-over contact		-	-	3W
Input remote tripping		•	•	•
Interface		•	•	o
RS 485 Interface with <i>Pro Open Data</i> protocol		-	-	o
RS 485 Interface with <i>MODBUS RTU</i> protocol		-	-	o
Additional power supply		-	-	o

• = Standard o = Optional ¹ only DEFT

WI LINE

WIP1 Time Overcurrent Relay with Multi-Characteristic, self-powered

[WI line overview](#)

	WIP1	I1	E1		
3-phase current $I_{>}; I_{>>}$					
Self-powered		1			
Self-powered with additional power supply ¹ for 140 V AC resp. 200 V DC		2			
Self-powered with additional power supply ¹ , with RS485 interface		3			
Rated current	1 A				
With additional earth current measuring $I_{E>}; I_{E>>}$	Rated current 1 A				
Standard (PRO OPEN DATA Protocol)					
Communication with MODBUS RTU Protocol (Possible with interface only)					M
Without Flag Indicator					*
WIP1 plus Flag Indicator WI1-SZ4					SZ4
WIP1 plus Flag Indicator WI1-SZ5					SZ5

* Please leave box empty if option is not desired (no extra charge)

¹ The power pack serves as the device's own supply, it does not supply the tripping energy for the impulse output

Product package WIP1 plus Flag Indicator WI1-SZ4 at special price

Product package WIP1 plus Flag Indicator WI1-SZ5 at special price

	WIP1		
230 V/AC VOLTAGE SUPPLY WIP1-2/3			
230 V/AC Voltage supply	Connection of WIP1-2/3 to 230 V/AC mains		PS

	WIP1		
SPARE BATTERIES			
3.6 V spare battery	WIP1-1 and WIP1-2 to relay version G009		BAT1
3.0 V spare battery			BAT2

WIB1 Time Overcurrent Relay with Multicharacteristic

[WI line overview](#)

	WIB1	2	E		
3-phase current measuring $I_{>}; I_{>>}$					
Self powered					
- parameter setting via DIP switches, second flag indicator output					
Plug in screw terminal					
- with backup protection (trip at micro controller failure)					P
- standard with $I_{>>}$ trip at 20 times highest rated CT current					
- connection for test winding					
Fixed terminal block					
- without backup protection (trip at micro controller failure)					F
- without connection for test winding					
With additional earth current supervision $I_{E>}$					
- standard 0.2 bis 2.5 x I_n (residual earth fault current)					
With protection blocking function settable up to 20 times highest rated CT current					
- applicable for load break switchgears with fuses					B
Without Flag Indicator					*
WIB1 plus Flag Indicator WI1-SZ4					SZ4
WIB1 plus Flag Indicator WI1-SZ5					SZ5

THE FOLLOWING DEVICE VARIANTS CAN BE ORDERED:

WIB12PE	WIB12PEB	WIB12FE

Product package WIB1 plus Flag Indicator WI1-SZ4 at special price

Product package WIB1 plus Flag Indicator WI1-SZ5 at special price

WI LINE

Protection Relays

WIC1 Multi Characteristic Time Overcurrent Relay, self-powered

[WI line overview](#)

WIC1	P	E		
3-phase current measuring I>;I>> Self powered - parameter setting via interface - parameter setting via DIP switches - parameter setting via HEX switches - parameter setting via interface with LED and a second operating interface	1 2 3 4			
Plug in screw terminal				
With earth current supervision ¹ I _E > - standard 0.2 to 2.5 x I _n (residual earth fault current)				
With backup protection (trip at micro controller failure) - Standard with I>> trip at 20 times highest rated CT current - Trip at 0.8 times lowest rated CT current and full energy storage				* W
Without Flag Indicator				*
WIC1 plus Flag Indicator WI1-SZ4				SZ4
WIC1 plus Flag Indicator WI1-SZ5				SZ5

* Please leave box empty if option is not desired (no extra charge)

¹ Can only be used with the 3-phase current measuring I>;I>>

THE FOLLOWING DEVICE VARIANTS CAN BE ORDERED:

WIC11PE	WIC13PE	WIC11PEW
WIC12PE	WIC14PE	WIC12PEW

Product package WIC1 plus Flag Indicator WI1-SZ4 at special price
Product package WIC1 plus Flag Indicator WI1-SZ5 at special price

WIC1	
ACCESSORIES	
USB PC adapter including software	PC3
Watchdog test unit	TU

WIC1			
CURRENT TRANSFORMER (1 PIECE)			
8 – 28 A	SVA 100-100-45	5P40	WE1AS1
16 – 56 A	SVA 100-100-50	10P80	W2AS1
16 – 56 A	SVA 100-100-50	5P80	WE2AS1
32 – 112 A	SVA 100-100-50	5P80	W3AS1
64 – 224 A	SVA 100-100-50	5P80	W4AS1
128 – 448 A	SVA 100-100-50	5P80	W5AS1
256 – 896 A	GSA 120-60-50	5P80	W6AS1

Further designs e.g. supporting type, plug-on type etc. on request.

Note: CT housing in accordance with the customers requirement.

System description: The protection relay WIC1 requires special CTs. The system is based upon an adapted secondary current, which permits it to start from a small primary current and ensures a secure operation.

WI LINE & EASYPROTEC

WI1 Flag Indicator

[WI line overview](#)

WI1	
Small version, front 34 x 23 mm, connection cable 1 m	SZ4
Small version, front 34 x 23 mm, connection cable 1m with bistable signal contact 230 V AC, 3 A	SZ5

The flag indicators can be used with all protection relays of the WI Line.

Flag indicator WI1-SZ4/SZ5

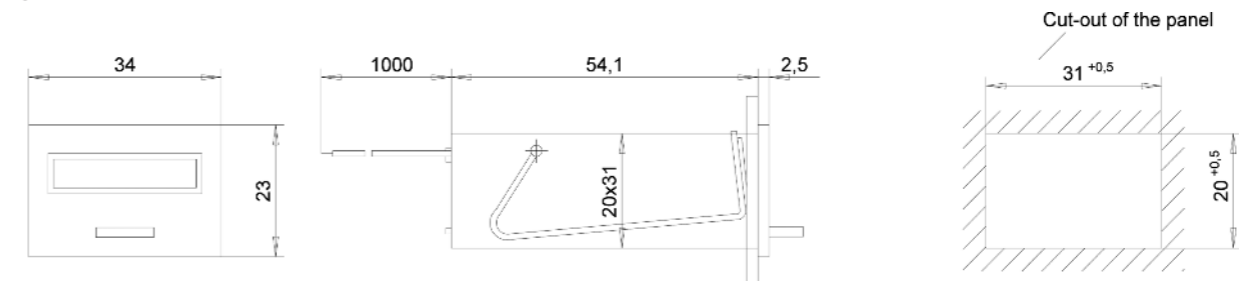

easYprotec Low Voltage Protection Relay

EASYPROTEC	Type	Part Number (P/N)
	100 Vac ¹	8441-1160
	690 Vac	8441-1161

¹ Adjustable to 120 Vac

The easYprotec series is an industrial grade low voltage protection relay that offers voltage and frequency protection features in a single package. Using advanced true RMS measuring the easYprotec offers a high measuring accuracy regardless of harmonics, transients, or disturbing pulses. This is suitable for generator or mains protection.

ACCESSORIES & SERVICES

Woodward provides various high quality accessories dedicated to your application.

Highly qualified staff members in our international offices guarantee customer service at the highest level worldwide. They give information on warranties, downtimes, spare parts, repairs, orders and technical training.

Apart from quality, there are growing expectations in terms of customer care. Maximum availability and operational reliability rank first in the requirements catalogue.

Woodward provides maximum service support worldwide.



ACCESSORIES

Power Generation Related Devices Woodward

	Type	Part Number (P/N)
ESENET ETHERNET GATEWAY	Application Note 37576	
ESENET		8445-1044
ESEPRO PROFIBUS GATEWAY	Application Note 37577	
ESEPRO		8445-1046
EPU-100	product spec 37562	
EPU-100		8445-1045
IKD 1	product spec 37171	
IKD 1	-	8440-2028
Configuration tool for IKD	V1.0002	9927-2094
DPC - DIRECT CONFIGURATION CABLE		
DPC-USB Direct configuration cable	USB connector	5417-1251
DPC-RS-232 Direct configuration cable	RS-232 connector	5417-557
IXXAT USB-TO-CAN CONVERTER		
IXXAT USB-to-CAN converter		8445-1023
POWER GEN. LEARNING MODULE		
Software Kit (USB-stick)	product spec 03412	8447-1012
CAN FIBER OPTIC GATEWAYS		
CAN-Fiber Optic System (Redundant)	DL-CAN-R	8445-1048
CAN-Fiber Optic System	DL-CAN	8445-1049

Power Generation Related Devices Other Supplier

NETBITER REMOTE COMMUNICATION GATEWAY

The Netbiter EasyConnect 250 gateway is available through HMS sales networks. For sales and support enquiries please visit www.netbiter.com/contact.

THERMOCOUPLE SCANNER - AXIOMATIC

The Thermocouple Scanner is available through Axiomatic sales networks. For sales and support enquiries please contact sales@axiomatic.com

ACCESSORIES

Accessories & Services

Power Generation Small Parts

	Part Number (P/N)
BRACKETS¹	
APRANORM housing Type E (Height 72 mm), delivered in a set of two (DIN rail mounting)	8923-1023
DIN Rail mounting metal housing	8923-1746
FIXING CLAMPS	
For all APRANORM housing types (one piece)	LR01543
TERMINAL STRIP KITS	
Kit-Plug Set for SPM-D2	8923-1032
Kit-Plug Set for easYgen-3100XT P1 + 3200XT P1 (green)	8923-2318
Kit-Plug Set for easYgen-3100 P1+P2/-3200 P1+P2 /-3500 P1 (green)	8923-1314
Kit-Plug Set for easYgen-3400 P1 (black)	8928-7371
Kit-Plug Set for easYgen-3400 P2 (black, with 8 plugs)	8923-1919
Kit-Plug Set for easYgen-3500 P2 (green, with 8 plugs)	8923-1918
Kit-Plug Set for easYgen-2200/-2300 and LS-521 (door mount)	8928-7286
Kit-Plug Set for easYgen-2500	8928-7297
Kit-Plug Set for easYgen-1000	8923-1055
Kit-Plug Set for easYgen-350/X and DTSC-50	8923-1158
Kit-Plug Set for LS-511 (back-pan mount)	8928-7336
Kit-Plug Set for DTSC-200	8923-1805
Kit-Plug Set for DSLC-2	8923-1806
Kit-Plug Set for MFR-300 and easYprotec	8923-2139
GASKETS²	
Housing Type D (144x72 mm, e.g. SPM-D, etc.)	8923-1037

¹ Note: The kit consists of 2x brackets, 2x level adjuster, 4x self-drilling screws, 4x back-plate screws, and 1x installation notes.

² Note: Using the gasket improves the protection to IP54 (from front).

Power Distribution Communication

	Part Number (P/N)
INTERFACE CONVERTER (FOR TOP HAT RAIL MOUNTING)¹	
from USB 2.0 to RS485 (with galvanic isolation) ²	RSC2485USB1
INTERFACE CONVERTER (FOR MAINTENANCE PURPOSES)³	
from RS232 to RS485 (without galvanic isolation) ²	RS485232ADAPTER
RS232 ZERO MODEM CABLE WITH HANDSHAKE (3 M)	
cable for PC - device communication	COMRS232Nullm
INTERFACE CONVERTER⁴	
from USB 2.0 to RS232 (without galvanic isolation) ⁵	USB2RS232ADAP
DIAGNOSIS AND SETTING SOFTWARE ⁶	
German / English	WISOFT1.0

¹ Note: The supply of the interface converter requires no plug-in power pack

² The supply of the interface converter requires no plug-in power pack

³ For HighPROTEC, High Tech Line 3, Professional Line and WI Line

⁴ For High Tech Line 3, Professional Line and WI Line

⁵ No supply voltage required

⁶ For WIP1-3

For the PC-device communication via RS232 interface it is necessary to use a cable type COMRS232Nullm.

By use of a USB connection of the PC to the device the converter USB2-RS232 adaptor and a zero modem cable COM-RS232 is necessary.

ACCESSORIES

Accessories & Services

Battery charging units Power Supply and Battery Charging Unit

	BL18	BL20
DIN rail	•	•
Rated output current	18 A	20 A
Parallel operation	•	•
3-phase supply (400 V)	•	•
1-phase supply (230 V)	•	-
12 V / 24 V (switchable)	-	•
12 V or 24 V	•	-
Analogue output for measuring signals (U and I)	-	•
Power Charging/normal charging	-	•
NiCd – batteries	-	•
Pb – batteries	•	•
IU – Standard characteristic	-	•
Power supply operation	•	•

• = Standard

BL18 Power Supply and Battery Charging Unit

	BL18		
Output current	18 A		
Input voltage	230 V, 1-phase 400 V, 3-phases	230 400	
Output voltage	12 V (12 - 13.75 V DC) 24 V (24 - 27.5 V DC)		12 24

BL20400 Power Supply and Battery Charging Unit











	Type	Part Number (P/N)
Output current	20 A	BL20400
Mains supply voltage	400 V AC 3-phase 50/60 Hz	
Rated output voltage switchable	12/24 V DC	
Charging according to IU-Characteristics		
Conservation of charge and balance charge	(Power Charging)	
Thermal overload protection		
2 analogue outputs 0-10 V for measuring signal from output voltage and -current		
Applicable for NiCd and lead-batteries		

SERVICES

Trainings









	Location	Duration
POWER GENERATION		
easYgen-3000XT series product training	Training Center Stuttgart	3 days
easYgen-3500XT + LS-5 product training	Training Center Stuttgart	2 days
POWER DISTRIBUTION		
HighPROTEC Level 1 or Level 2 training	Training Center Kempen	2 days
HighPROTEC Level 1 or Level 2 training	On customer site worldwide	2 days
Customized training for different product lines	Training Center Kempen	2 days
Customized training for different product lines	On customer site Germany	2 days
Customized training for different product lines	On customer site worldwide	2 days

APPROVALS AND CERTIFICATIONS

																	
		BDEW TR3/TR8	BDEW / VDE-AR-N 4110	VDE-AR-N 4105	VDE-AR-N 4120	CEI 0-16	Conformité Européenne	Underwriters Laboratories	Canadian Underwriters Laboratorie	Canadian Standards Association	KEMA Typetest IEC 60255-1	KEMA IEC 61850	EAC	Lloyd's Register-LR (Marine)	DNV - GL (Marine)	American Bureau of Shipping-ABS (Marine)	BV (Marine)
GENSET CONTROLLERS																	
easYgen-3000	Genset controller	•		•			•	•	•	•			•	•		•	
easYgen-3000XT	Genset controller	•		•			•	•	•	•			•	•		•	
easYgen-3000 Marine	Genset controller						•	•	•	•			•	•	•	•	•
easYgen-2000	Genset controller						•	•	•	•			•	•		•	
easYgen-1800	Genset controller for single unit operations						•	•	•	•			•				
easYgen-1700	Genset controller for single unit operations						•	1	1				1				
easYgen-1600	Genset controller for single unit operations						•	1	1				1				
easYgen-1400	Genset controller for single unit operations						•	1	1				1				
easYgen-800	Genset controller for standard solutions						•	1	1				1				
easYgen-600	Genset controller for standard solutions						•	1	1				1				
easYgen-400	Genset controller for standard solutions						•	1	1				1				
easYgen-300	Genset controller for standard solutions						•	•	•				•				
LS-5	Circuit breaker control and protection						•	•	•				•				
LS-5 Marine	Circuit breaker control and protection						•	•	•	•			•	•	•	•	•
EXPANSION MODULES																	
RP-3000	Remote panel						•	•	•				•	•	•	•	•
RP-3000XT	Remote panel						•	•	•				•				
RP-3000 Marine	Remote panel						•	•	•				•	•	•	•	•
easYlite-100	Remote annunciator						•	•	•				•				
IKD 1	Digital I/O expansion board						•	•	•				•				
LSG	Load share gateway						•						•				
SYNCHRONIZERS																	
DSL-2	Digital synchronizer and load control						•	•	•	•			•	•		•	
MSL-2	Master synchronizer and load control						•	•	•	•			•	•		•	
SPM-D / SPM-D2	Synchronizer						•	•	•				•				
AUTOMATIC TRANSFER SWITCH CONTROLLERS																	
DTSC-50	Automatic transfer switch controller						•	•	•				•				
DTSC-200	Automatic transfer switch controller						•	•	•				•				
PROTECTION RELAYS																	
HighPROTEC																	
MCA4	Incoming and outgoing feeder protection	•	•				•	•		•	•	•	•				
MCA4-2	Incoming and outgoing feeder protection	•	•				•	•		•	•	•	•				
MCDGV4 / MCDGV4-2	Generator differential protection		•				•	•		•			•				
MCDTV4 / MCDTV4-2	Transformer differential protection						•	•		•			•				
MRA4 / MRA4-2	Incoming and outgoing feeder protection		•				•	•		•	•		•				
MRDT4 / MRDT4-2	Non-directional transformer differential protection						•	•		•	•		•		•		
MRI4 / MRI4-2	Combined overcurrent time protection and earth fault protection						•	•		•	•		•				
MRM4 / MRM4-2	Motor protection relay						•	•		•	•		•				
MRMV4 / MRMV4-2	Motor protection relay with voltage						•	•		•	•		•				
MRU4 / MRU4-2	AC voltage and frequency relay						•	•		•	•		•				
System Line																	
CMP112	Indication and operating unit for protection systems						•						•				
CSP2L	Cable- and line protection system (Base unit)						•						•				

¹ Available soon

APPROVALS AND CERTIFICATIONS

											KEMA	KEMA					
		BDEW TR3/TR8	BDEW / VDE-AR-N 4110	VDE-AR-N 4105	VDE-AR-N 4120	CEI 0-16	Conformité Européenne	Underwriters Laboratories	Canadian Underwriters Laboratoire	Canadian Standards Association	KEMA Typetest IEC 60255-1	KEMA IEC 61850	EAC	Lloyd's Register-LR (Marine)	DNV - GL (Marine)	American Bureau of Shipping-ABS (Marine)	BV (Marine)
PROTECTION RELAYS																	
High Tech Line																	
MRA1	Trip circuit supervision						•						•			•	
MRG3	Generator protection relay						•						•			•	
MRI1I	Time overcurrent relay with multi-characteristic						•						•			•	
MRI3I_C	Time overcurrent-/earth fault current relay with control function						•						•			•	
MRI3I_H	Time overcurrent-/earth current relay with harmonic stabilizing						•						•			•	
MRI3I_E	Time overcurrent-/earth current relay						•						•			•	
MRI3I_T	Time overcurrent-/earth current relay with thermal replica						•						•				
MRIK3	Time overcurrent-/earth current relay with AR function						•						•			•	
MRL1	Lock-out relay						•						•				
MRM3	Motor protection relay						•						•				
MRN3	Mains decoupling relay						•						•				
MRP2	Directional power relay						•						•				
MRQ1	Field failure relay						•						•				
MRR1	Rotor earth fault relay						•						•				
MRT1	Test unit						•						•				
MRU3	AC voltage relay						•						•				
IRI1E	Earth current protection relay						•						•				
IRU1	AC voltage protection relay						•						•				
WI Line																	
WIB1	Multi characteristic time overcurrent relay						•						•				
WIC1	Multi characteristic time overcurrent relay						•						•				
WIP1	Self-powered time overcurrent relay with multi-characteristic						•						•				
Multifunction Relays																	
easYprotec	Low voltage protection relay						•	•	•								

¹ Approvals/Certifications are not available for every type. Details can be found in the corresponding manuals.

INDEX

WEIGHT AND DIMENSIONS

Unit	Description	Unit incl. package		Page
		Weight (g)	Dimension WxHxD (mm)	
actiVgen	Electronic engine speed controller	540	149 x 52 x 153	18
Asynchron KIT-2000	Genset controller + EPU-100 for asynchron applications	1.100	219 x 171 x 61	15
Asynchron KIT-3000	Genset controller + EPU-100 for asynchron applications	1.850	282 x 217 x 99	14
BF1	Frequency relay	500	145 x 100 x 110	60
BL18	Power supply and battery charging unit	2.000	145 x 100 x 110	70
BL20400	Power supply and battery charging unit; 400 V	4.000	145 x 100 x 110	70
BN1400	Mains decoupling relay	500	145 x 100 x 110	60
BU1AC	AC voltage relay	500	145 x 100 x 110	60
BU1DC2	DC voltage relay	500	145 x 100 x 110	60
BUA1	Voltage and voltage balance relay	500	145 x 100 x 110	60
COMRS232Nullm	RS232 zero modem cable with Handshake (3 m)		¹	41/69
DSL2-2	Digital synchronizer and load control	1.900	250 x 227 x 84	20
DTSC-50	Automatic transfer switch controller	450	158 x 158 x 40	24
DTSC-200	Automatic transfer switch controller	800	219 x 171 x 61	24
easYgen-300	Genset controller for standard solutions	450	158 x 158 x 40	15
easYgen-400	Genset controller for standard solutions	320	135 x 110 x 44	15
easYgen-600	Genset controller for standard solutions	850	209 x 166 x 45	15
easYgen-800	Genset controller for standard solutions	850	237 x 172 x 45	15
easYgen-1400	Genset controller for single unit operations	320	135 x 110 x 44	15
easYgen-1500	Genset controller for single unit operations	800	219 x 171 x 61	15
easYgen-1600	Genset controller for single unit operations	850	209 x 166 x 45	15
easYgen-1700	Genset controller for single unit operations	850	237 x 172 x 45	15
easYgen-1800	Genset controller for single unit operations	850	237 x 172 x 45	15
easYgen-2200	Genset controller for multiple unit operations - plastic housing with display	800	219 x 171 x 61	15
easYgen-2300	Genset controller for multiple unit operations - plastic housing with display	800	219 x 171 x 61	15
easYgen-2500	Genset controller for multiple unit operations - plastic housing with display	1.100	219 x 171 x 98	15
easYgen-3200XT P1	Genset controller for multiple unit operation - plastic housing with display	1.850	282 x 217 x 99	14
easYgen-3200 P1	Genset controller for multiple unit operation - plastic housing with display	1.850	282 x 217 x 99	14
easYgen-3200 P2	Genset controller for multiple unit operation - plastic housing with display	2.170	282 x 217 x 99	14
easYgen-3100 P1	Genset controller for multiple unit operation - metal housing	1.750	250 x 227 x 84	14
easYgen-3100 P2	Genset controller for multiple unit operation - metal housing	2.270	250 x 227 x 84	14
easYgen-3400XT	Genset controller for complex breaker application – metal housing	1.750	250 x 228 x 84	14
easYgen-3400	Genset controller for complex breaker application – metal housing	1.750	282 x 217 x 99	14
easYgen-3500XT	Genset controller for complex breaker application – plastic housing with display	1.850	282 x 216 x 96	14
easYgen-3500	Genset controller for complex breaker application – plastic housing with display	1.850	250 x 227 x 84	14
easYlite-100	Remote annunciator	300	158 x 158 x 40	18
easYprotec	Low voltage protection relay	300	146 x 128 x 50	65
EPU-100	Remanence voltage converter for asynchronous generators		30 x 55 x 75	67
GC-3000XT	Genset controller for complex application	1.750	250 x 228 x 50	14
HTLAB	HTL contact block cover		¹	52
HTL/PLSOFT4	Diagnosis and setting software for HTL/PL-devices (German/English)		CD-ROM	53/59

¹ Device in lined ESD foil

Unit	Description	Unit incl. package		Page
		Weight (g)	Dimension WxHxD (mm)	
HTL3M12	19" rack system for back panel mounting		¹	52
HTL6M	19" rack system for back panel mounting		¹	52
HTLKB	Additional contact block for HTL-6M-housing		¹	53
HTLTF	Partial space front plate 3HE		¹	52
IKD 1	Digital I/O Expansion Board	360	168 x 128 x 51	67
IRI1	Earth fault relay	2.000	315 x 175 x 140	53
IRU1	AC voltage relay	2.000	315 x 175 x 140	53
LS-5	Circuit breaker control and protection	840	219 x 171 x 61	17
LSG	Load Share Gateway	280	141 x 98,5 x 21	18
MCA4-2	Directional feeder protection	4.000	250 x 240 x 200	30
MCDGV4-2	Generator differential protection	4.500	250 x 240 x 200	38
MCDLV4-2	Line Differential Protection	4.500	250 x 240 x 200	39
MCDTV4-2	Directional transformer differential protection	4.500	250 x 240 x 200	35
MRA1	Trip circuit supervision	2.000	315 x 175 x 140	50
MRA4-2	Directional feeder protection	4.000	250 x 240 x 200	31
MRDT4-2	Non-directional transformer differential protection	4.000	250 x 240 x 200	34
MRF3	Frequency relay	2.000	315 x 175 x 140	47
MRG3	Generator protection relay	2.000	315 x 175 x 140	46
MRI1_D	Time overcurrent relay with multi-characteristic	2.000	315 x 175 x 140	46
MRI1_U	Voltage controlled time overcurrent relay	2.000	315 x 175 x 140	46
MRI3I_C	Time overcurrent-/earth fault relay with control function	2.000	315 x 175 x 140	43
MRI3I_H	Time overcurrent-/earth fault relay with harmonic stabilizing	2.000	315 x 175 x 140	44
MRI3I_E/X	Time overcurrent-/earth fault relay	2.000	315 x 175 x 140	44
MRI3I_T	Time overcurrent-/earth fault relay with thermal	2.000	315 x 175 x 140	44
MRI4-2	Combined time overcurrent and earth fault relay	2.900	250 x 150 x 200	32
MRIK3I_C	Time overcurrent-/earth fault relay with auto reclosing function	2.000	315 x 175 x 140	45
MRIK3I_E	Time overcurrent-/earth fault relay with auto reclosing and control function	2.000	315 x 175 x 140	45
MRI3LE	Earth fault relay	2.000	315 x 175 x 140	44
MRL1	Lock-out relay	2.000	315 x 175 x 140	50
MRM3	Motor protection relay	2.000	315 x 175 x 140	49
MRM4-2	Motor protection relay	2.900	250 x 150 x 200	36
MRMV4-2	Motor protection relay with voltage and frequency	4.000	250 x 240 x 200	37
MRN3	Mains decoupling relay	2.000	315 x 175 x 140	47
MRP2	Directional power relay	2.000	315 x 175 x 140	48
MRQ1	Field failure relay	2.000	315 x 175 x 140	48
MRR1	Rotor earth fault relay	2.000	315 x 175 x 140	49
MRS1	Negative Sequence Relay	2.000	315 x 175 x 140	48
MRT1	Test unit	2.000	315 x 175 x 140	50
MRU3	AC voltage relay	2.000	315 x 175 x 140	47
MRU4-2	Voltage and Frequency supervision	2.400	250 x 150 x 200	33
MSLC-2	Master Synchronizer and Load Control	1.900	250 x 227 x 84	20
RP-3000/-3000XT	Remote Panel	2.800	365 x 305 x 120	14
RSC2485USB1	Interface converter (for top rail mounting)	300	160 x 130 x 65	69
RS485232 ADAPTER	Interface converter (for maintenance purposes)	300	¹	69
SPM-D2	Synchronizer	800	144 x 72 x 122	21
USB2RS232ADAP	Interface converter (USB to RS232)		130 x 155 x 70	69
W1SZ	Flag indicator	200	130 x 60 x 60	63
WIB1	Multi characteristic time overcurrent relay	700	200 x 155 x 80	63
WIC1	Multi characteristic time overcurrent relay	700	200 x 155 x 80	64
WIP1	Self-powered multi characteristic time overcurrent relay	1.900	260 x 145 x 110	63
WIP1BAT1	3.6 V spare battery		¹	63
WIP1BAT2	3.0 V spare battery		¹	63
WIP1PS	230 V/AC voltage supply	300	145 x 100 x 110	63
WISOFT				69

¹ Device in lined ESD foil

INDEX

WEIGHT AND DIMENSIONS

Unit	Description	Unit incl. package		Page
		Weight (g)	Dimension WxHxD (mm)	
XD1	Differential protection relay	1.800	260 x 145 x 110	59
XE2	DC current relay (loss-of-excitation relay)	500	145 x 100 x 110	58
XF2	Frequency relay 50/60 Hz	500	145 x 100 x 110	58
XG2	Generator-/Mains monitor	500	145 x 100 x 110	58
XI1E	Earth fault relay	500	145 x 100 x 110	55
XI1I	Time overcurrent relay	500	145 x 100 x 110	55
XM1	Motor protection relay	500	145 x 100 x 110	58
XN2	Mains decoupling relay	500	145 x 100 x 110	56
XP2R	Power and reverse power relay	500	145 x 100 x 110	58
XR1	Rotor earth fault relay	500	145 x 100 x 110	58
XRI1I_E	Combined time overcurrent- and earth current relay	1.800	260 x 145 x 110	56
XRI1E/X	Directional earth fault current relay)	1.800	260 x 145 x 110	56
XRI1I_R	Directional time overcurrent relay	1.800	260 x 145 x 110	56
XRN2	Mains decoupling relay	1.800	260 x 145 x 110	57
XRS1	Interface adapter RS485	200	¹	59
XRW1	Mains decoupling relay for wind power systems	1.800	260 x 145 x 110	57
XS2	Negative sequence relay	500	145 x 100 x 110	58
XU1DC	DC voltage relay	500	145 x 100 x 110	57
XU1E	Earth fault voltage relay	500	145 x 100 x 110	58
XU2AC	AC voltage relay 50/60 Hz	500	145 x 100 x 110	57
XUA1	AC voltage and phase balance relay	500	145 x 100 x 110	57
XUF2	AC voltage and frequency relay 50/60 Hz	500	145 x 100 x 110	57

¹ Device in lined ESD foil

IMPRINT

Publisher

Woodward GmbH
 Handwerkstrasse 29
 70565 Stuttgart, Germany
 Phone: +49 711 7 89 54 510
 Fax: +49 711 7 89 54 100

Woodward Kempen GmbH
 Krefelder Weg 47
 47906 Kempen, Germany
 Phone: +49 2152 145 331
 Fax: +49 2152 200

www.woodward.com

Note

The publication of this document invalidates all previous versions. Dimensions and other data conform to the latest technical standards at the time of publication. We reserve the right to introduce technical modifications at any time. We can accept no responsibility for printing errors. Any reprinting or duplication of this document in any form – in part or in whole – is prohibited without our consent.

CONTACT INFORMATION

Region	Phone	E-Mail
North & Central America	+1 970 962 7272	SalesPGD_NAandCA@woodward.com
South America	+55 19 3708 4760	SalesPGD_SA@woodward.com
Europe Kempen	+49 2152 145 331	SalesPGD_EMEA@woodward.com
Stuttgart	+49 711 78954 510	
Middle East & Africa	+971 2 6784424	SalesPGD_EMEA@woodward.com
Russia	+49 711 78954 515	SalesPGD_EMEA@woodward.com
China	+86 512 8818 5515	SalesPGD_CHINA@woodward.com
India	+91 124 4399 500	Sales_INDIA@woodward.com
ASEAN & Oceania	+49 711 78954 510	SalesPGD_ASEAN@woodward.com

Alternatively,
industrial.support@woodward.com



Peaker Services, Inc.
8080 Kensington Ct.
Brighton, MI 48116

800-622-4224

37666