



## Remote PC Guide Series - Volume 3

### Configuring the NETLAB+ Virtual Machine Infrastructure

Document Version: **2016-11-21**



This guide provides guidance on connecting the vSphere setup to the NETLAB+ environment.

This guide is part of a multi-volume series, designed to provide you with the guidance needed to implement remote PCs on your NETLAB+ system. [Learn more about the Remote PC Guide Series.](#) See the [Documentation Library](#) for a list of all NETLAB+ guides.

Before following the configuration tasks detailed in this guide, please complete all installation and configuration instructions provided in [Remote PC Guide Series - Volume 2, Installation.](#)

Copyright © 2016 Network Development Group, Inc.  
[www.netdevgroup.com](http://www.netdevgroup.com)

NETLAB Academy Edition, NETLAB Professional Edition, and NETLAB+ are registered trademarks of Network Development Group, Inc.

VMware is a registered trademark of VMware, Inc. Cisco, IOS, Cisco IOS, Networking Academy, CCNA, and CCNP are registered trademarks of Cisco Systems, Inc.

1	Background .....	3
2	Registering a Virtual Datacenter in NETLAB+ .....	3
3	Adding ESXi hosts in NETLAB+ .....	7
4	Proactive Resource Awareness.....	10
5	NETLAB+ Virtual Machine Inventory.....	12
5.1	Virtual Machine Roles .....	12
5.2	How Virtual Machines Become Part of the NETLAB+ Inventory.....	13
5.3	Importing VMs into the Virtual Machine Inventory.....	14
5.4	Virtual Machine Cloning.....	16
5.4.1	Golden Masters and Golden Snapshots .....	17
5.4.2	Using NETLAB+ to Clone a Single Virtual Machine .....	17
5.5	Assigning Virtual Machines to Pods .....	21
5.5.1	Configuring Control Switch 802.1q Trunk Ports .....	27
5.5.2	Connecting Virtual Machines to Real Equipment Pods .....	29
5.5.2.1	Creating a Real Equipment Pod.....	30
5.5.2.2	Determining the Base VLAN and VLAN Pool .....	30
5.5.2.3	Creating Port Groups for Pod VLANs on the Inside Network.....	31
5.6	NDG Virtual Machine Topologies.....	31
6	Cloning Virtual Machine Pods.....	32
6.1	Golden Masters and Golden Snapshots.....	34
6.2	Creating a Master Pod.....	34
6.3	Cloning a Virtual Machine Pod Using Linked Clones.....	35
6.4	Tasks to Perform After Pod Cloning.....	38
6.5	Saving Time on Subsequent Pod Cloning.....	38
6.6	Creating a Full Clone of a Virtual Machine Equipment Pod.....	39
6.7	Creating Pods that Run on a Multiple VMware ESXi Hosts.....	40
7	Virtual Machine Operations.....	42
7.1	Delete All Virtual Machines in a Pod.....	43
7.2	Deleting Individual Virtual Machines .....	45
7.3	Changing the Name of a Virtual Machine .....	46
7.4	Changing the Role of a Virtual Machine.....	47
8	Using NDG Automated Pods.....	49
8.1	NDG Real Equipment Topologies .....	49
8.2	Setting the Local System ID When Using Multiple NETLAB+ Systems.....	50

## 1 Background

This guide is designed to help you attach the Virtual Machine Infrastructure you created in: [Remote PC Guide Series - Volume 2, Installation](#).

NETLAB+ maintains a database called the Virtual Machine Inventory. The inventory is a mapping between NETLAB+ remote PCs and virtual machines in one or more vSphere datacenters. The inventory also tracks information about virtual machines that is not stored in vCenter, such as the role each VM plays in NETLAB+ and parent/child relationships between virtual machines.

## 2 Registering a Virtual Datacenter in NETLAB+

In this section, you will add vCenter datacenter(s) created during the Virtual Machine Infrastructure setup to NETLAB+.

1. Login to the NETLAB administrator account.
2. Scroll down and click on **Virtual Machine Infrastructure**.



3. Click on **Virtual Datacenters and Management Agents**.

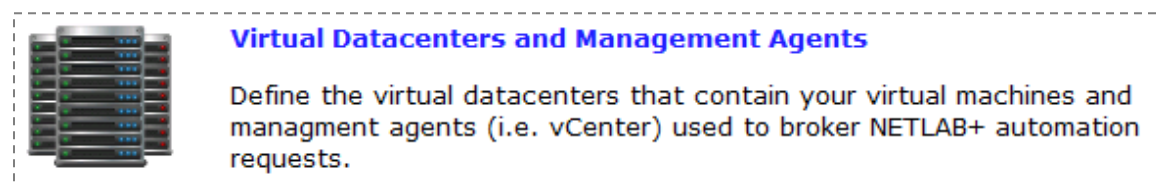

4. Click on **Add Datacenter**.

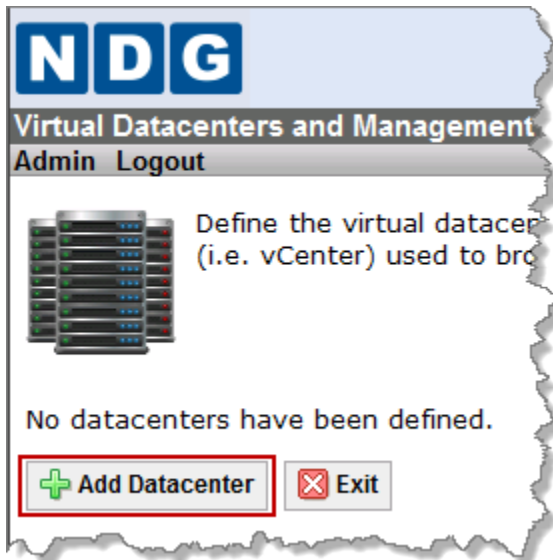

5. Enter the required information for the datacenter you have set up using the vSphere Client. Field descriptions are provided below.

The values for this form may vary based on your local settings.

- a. **Datacenter Name:** The exact name of the **datacenter** as registered in vCenter (see the red box below). This will be **NETLAB** if you used the recommended name when adding a datacenter in vCenter.

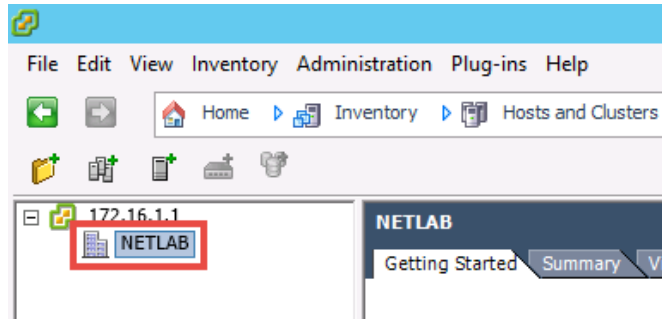

- b. **Agent Hostname:** This value is set to an IP address assigned to your vCenter server. The following table depicts which IP address you should use based on the model you selected.

Network Model	Management Path	IP Address
Single-Homed	OUTSIDE	Campus LAN IP
Dual-Homed	OUTSIDE	Campus LAN IP

- c. **Agent Username:** Enter the username for the account you created when configuring the vCenter Server Appliance. If you followed the guide, this username should be **administrator@your\_domain\_name**. This username will be used when NETLAB+ connects to vCenter.
  - d. **Agent Password:** Enter the password for the account you created when configuring the vCenter Server Appliance. If you followed the guide, this is a custom password. This password will be used when NETLAB+ connects to vCenter.
6. Click **Add Datacenter** to complete the registration.
  7. Click on **OK** to continue.

8. Click **Test** to verify that NETLAB+ can connect to vCenter server using the settings you provided. If the test fails, recheck connectivity and your datacenter settings.

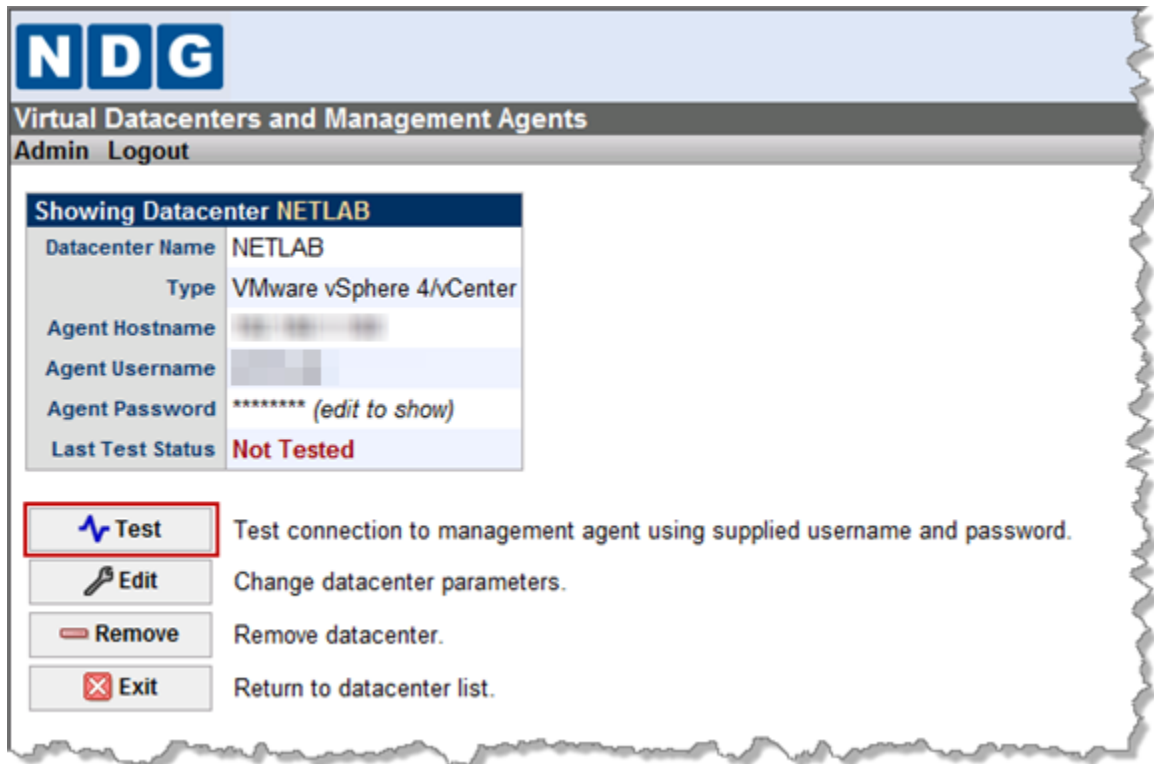

9. Click on **OK** to continue.
10. Click **Exit** to return to the datacenter list.
11. Click **Exit** to leave the datacenter list.

### 3 Adding ESXi hosts in NETLAB+

In this section, we will add the virtual machine host servers in your datacenters to NETLAB+.

1. Login to the NETLAB administrator account.
2. Scroll down and click on **Virtual Machine Infrastructure**.



3. Select **Virtual Machine Host Servers**.

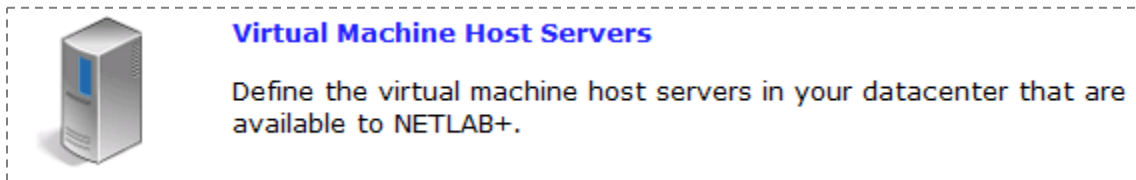

4. Click on **Add Host**.

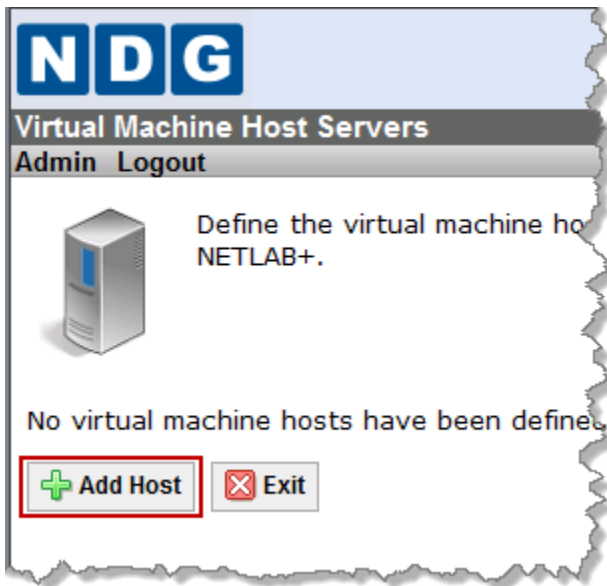

- If you have more than one datacenter defined, you will be prompted to select a datacenter. NETLAB+ scans the datacenter to discover hosts. Hosts that have not been registered in NETLAB+ are displayed. Select the host you wish to add by clicking on the host name.

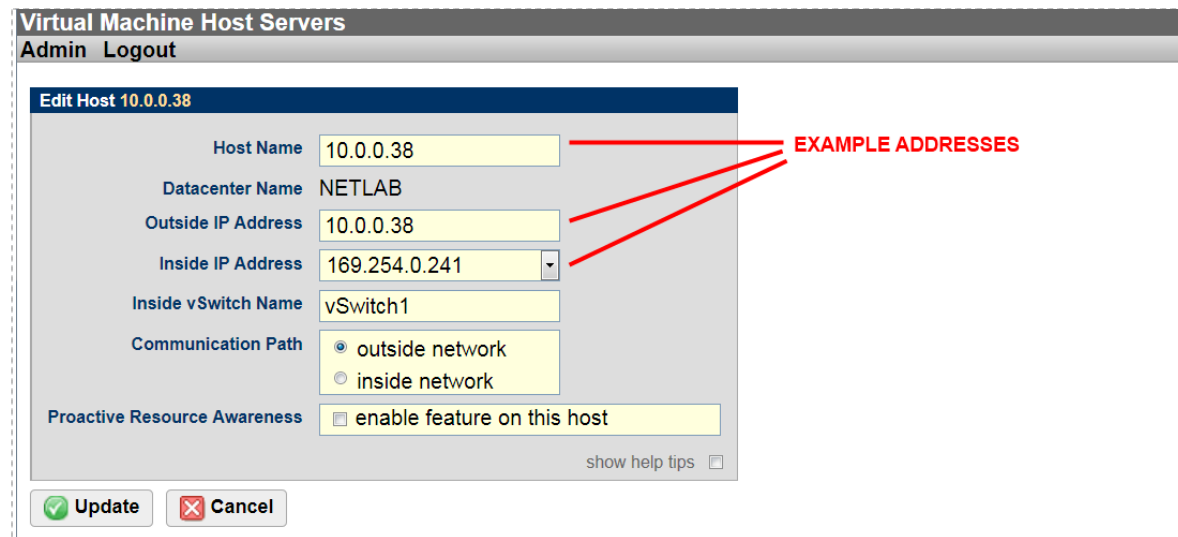
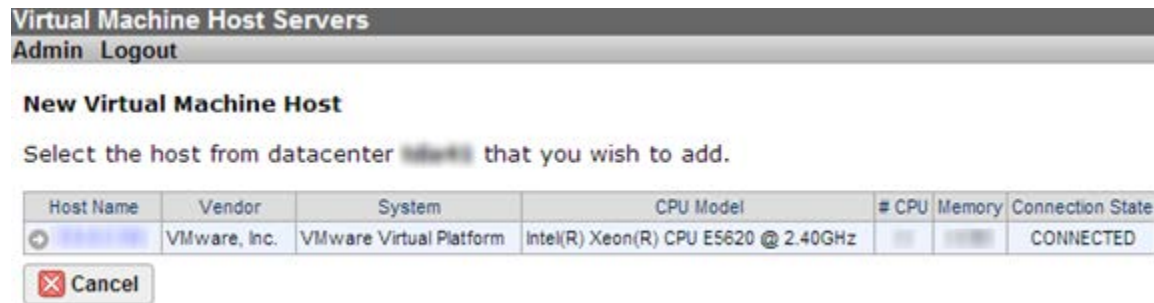

- Enter the settings for this host based on the networking model you have chosen. The table below shows typical settings.

Networking Model	Outside Address	Inside Address	Inside vSwitch	Communication Path
Single-Homed	Campus LAN IP address	Not set	Not applicable	Outside
Dual-Homed	Campus LAN IP address	169.254.0.X	vSwitch1	Outside

**Host Name.** The IP address or fully qualified domain name of the ESXi host. This should be the same value entered in vCenter for the host name.

**Outside IP Address.** The IP address of the ESXi host outside interface.

**Inside IP Address.** The IP address of the ESXi host inside interface. Use the "not set" option for single-homed networking. This setting is only used in the dual-homed environment.



**Communication Path.** This setting determines the network path that is used for remote display connections (proxied by the NETLAB+ server). This will always be set to **outside network**. Inside network was for compatibility with previous networking models.

**Inside vSwitch Name.** This is the name of the virtual switch that connects to your control switch. This is typically "vSwitch1" for dual-homed networking. Leave this setting blank for single-homed networking (which does not connect to a control switch).

The Inside vSwitch Name is case sensitive and must be entered exactly as shown in vCenter. This setting must be correct to use automatic networking on real equipment pods (i.e. MAP, CRP, BRPv2).

**Proactive Resource Awareness.** See the next section for details.

7. Click **OK** to confirm the host has been added.
8. Click **Exit** to return to host list.
9. Repeat this section for each ESXi host in your Virtual Machine Infrastructure.

## 4 Proactive Resource Awareness

Proactive Resource Awareness (PRA) allows you to time-share virtualization servers using the NETLAB+ scheduler. PRA is designed with 3 goals in mind.

1. Ensure a quality lab experience for all trainees by reserving CPU and memory resources on VM servers at the scheduled lab times. This proactively prevents the VM servers from becoming overloaded and unresponsive.
2. Increase the number of trainees that you can run through your training programs by spreading out the trainee lab sessions over time.
3. Reduce costs of your training programs by using fewer virtualization servers.

For each VM server in your inventory, you may set 3 limits.

- Total number of active virtual machines
- Active number of virtual CPUs
- Active maximum memory usage

With these limits defined, the scheduler will proactively manage the server's CPU and memory resources. If scheduling a particular pod would exceed one of the set limits in a 30-minute time slot, the pod cannot be scheduled at that time and the limitation will be clearly indicated on the scheduler.

PRA is enabled in Virtual Machine Host Servers on a per host basis. You can enable PRA when adding a host or editing the host settings of an existing host.

### **Administrator Account > Virtual Machine Inventory > Virtual Machine Host Servers**

The values you set for PRA will depend on your host server specifications and the types of workloads that you run on your servers.

Proactive Resource Awareness is a scheduling algorithm based on workload forecasting; it does not monitor real time workload. PRA assumes that all virtual machines running on a host server are under the control of NETLAB+; it does not account for VMs that are powered on independently of NETLAB+.

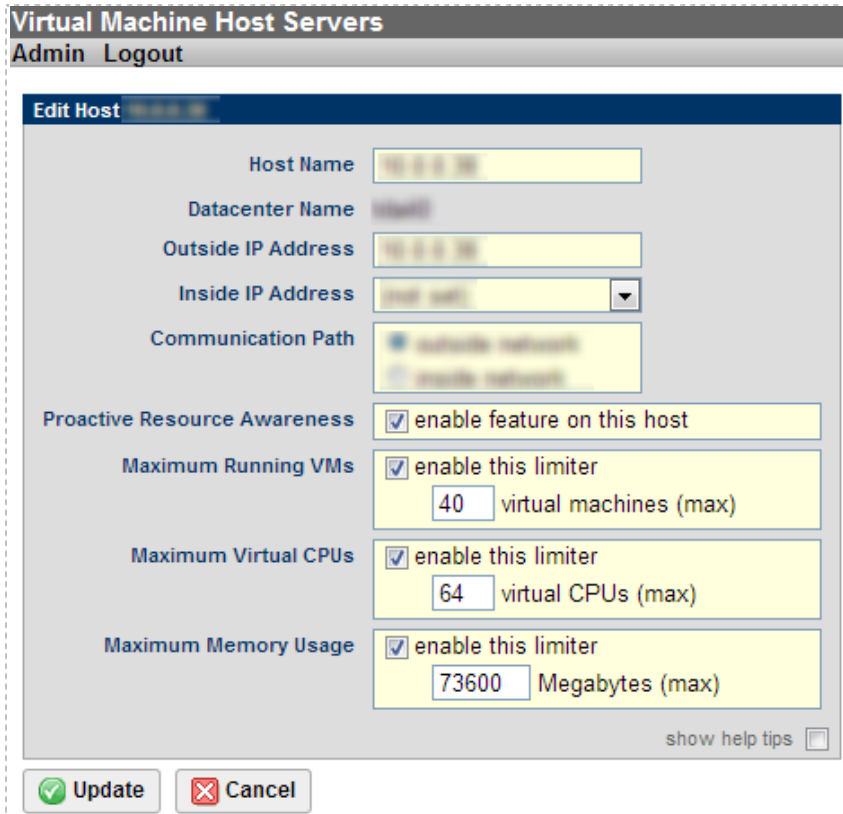

- **Proactive Resource Awareness.** Check this box to enable PRA on this host. Uncheck the box to completely disable PRA on this host.
- **Maximum Running VMs.** To set the maximum number of virtual machines that can be scheduled at one time on this host, check **enable this limiter** and set the number of virtual machines.
- **Maximum Virtual CPUs.** VMware ESXi supports VMs with more than one virtual CPU (vCPU) and Symmetric Multiprocessing. Virtual machines with more than one vCPU typically use more processing power on the host than VMs with only one vCPU. The number of vCPUs assigned to a VM can be seen when viewing the Virtual Machine Inventory table in NETLAB+. By setting Maximum Virtual CPUs, you can achieve more granular control over CPU resources. Check **enable this limiter** and set the number of virtual CPUs that can be running at one time.
- **Maximum Memory Usage.** This setting limits the amount of memory (in **Megabytes**) that can be scheduled for VMs at one time. It is based on the memory assigned to the virtual machines when the VM was created. It does not include overhead memory required for the VMs or the host. For best performance, this value should not be set higher than the physical memory on the host. **A general rule of thumb is to take the total amount of RAM and subtract 8GB or 8192MB.**

## 5 NETLAB+ Virtual Machine Inventory

NETLAB+ version 2011 introduced the Virtual Machine Inventory (VMI). The inventory is a mapping between NETLAB+ remote PCs and virtual machines in one or more vSphere datacenters. The inventory also tracks information about virtual machines that is not stored in vCenter, such as the role each VM plays in NETLAB+ and parent/child relationships between virtual machines.

### Virtual Machine Inventory

Admin Logout



Import, clone, and manage the inventory of virtual machines to be used with NETLAB+.

Virtual Machine Name	Operating System	Role	Datacenter	Runtime Host	CPUs	Memory (MB)	Pod ID	Pod I
2010120613 ICM 4.1 Template esxi-1	VMware ESX(i)	Template	NETLAB		2	2256		
2010120613 ICM 4.1 Template esxi-2	VMware ESX(i)	Template	NETLAB		2	2256		
2010120613 ICM 4.1 Template san no-Win-ISO	Linux	Template	NETLAB		1	1024		
2010120613 ICM 4.1 Template vcenter-1 no-Win-inst	Windows Server 2003	Template	NETLAB		2	3072		
2010120613 ICM 4.1 Template vclient no-Win-inst	Windows XP	Template	NETLAB		1	512		
BackTrack Master	Linux	Master	NETLAB	10.0.0.38	1	768		
Backtrack Pod 2 Standalone PC	Linux	Normal	NETLAB	10.0.0.38	1	768	1071	Backtrack Pod 2
BackTrack Pod1	Linux	Normal	NETLAB	10.0.0.38	1	768	1022	BackTrack Pod1
BT4-R1-template	Linux	Template	NETLAB		1	768		
Empty XP VM 1	Windows XP	Normal	NETLAB	10.0.0.38	1	256		

### 5.1 Virtual Machine Roles

Each virtual machine is assigned a *role* in the NETLAB+ inventory. This is a NETLAB+ specific value that is not stored in vCenter. The role indicates the intended function of the virtual machine in NETLAB+ and influences the operations that can be performed on the virtual machine, as well as default settings during those operations. The following roles are currently defined:

**Template.** A template is a virtual machine that is used to deploy other virtual machines. Templates cannot be assigned to pods, powered on or edited, providing a more secure way of preserving a virtual machine configuration that you intend to deploy many times. A template VM in NETLAB+ is synonymous with a template VM in VMware vCenter. Virtual machines marked as templates in vCenter are always marked as templates in NETLAB+, and vice-versa.

**Master.** By designating a virtual machine as a master, you indicate your intention to use the virtual machine for the purpose of cloning other virtual machines and/or cloning the virtual machine as part of a cloned pod. When you clone VMs from a master, and subsequently choose to clone a VM from that clone, the default selection will be to create the clone from the original that was indicated to be the Master. A master VM differs from a template VM in that can be assigned to run on a host, used in a pod (typically a master pod), and

powered on for the purpose of adding and configuring new software. Once the virtual machine has all the required software components and is thoroughly tested, a *golden master snapshot* is taken and becomes the basis for full or linked clones (discussed later).

 **Normal.** A normal VM is a virtual machine that will be assigned to a production pod. A normal VM may be configured to revert to a snapshot at the beginning and end of a lab reservation, or when the user explicitly invokes the scrub action on the VM or the entire pod. A normal VM is an ideal choice for pods that should always start in the same state, such as VMs in Cisco NetAcad pods.

 **Persistent.** A persistent VM is assigned to a production pod, with the additional characteristic that its state will be retained from one reservation to the next. A persistent VM never reverts to a snapshot. This type of VM is appropriate when the user assigned to the pod is working on a curriculum that carries the result of each lab assignment progressively. An example scenario would be a course where the student performs “Lab One” and then on a subsequent reservation performs “Lab Two”, with the pod in the state it was in at the end of “Lab One”.

## 5.2 How Virtual Machines Become Part of the NETLAB+ Inventory

Virtual machines must first reside in the NETLAB+ Virtual Machine Inventory before they can be assigned to pods and function as NETLAB+ remote PCs. There are three ways virtual machines can become part of the NETLAB+ inventory:

- **Import.** NETLAB+ communicates with vCenter and scans the selected datacenter to identify existing VMs that are available to be added to the NETLAB+ virtual machine inventory. The import function is used to import virtual machines that were created outside of NETLAB+ (i.e. from the vSphere Client or VMware Converter).
- **Clone VM.** NETLAB+ communicates with vCenter and makes a copy of a virtual machine that already exists in the NETLAB+ inventory. When a virtual machine is cloned from the NETLAB+ inventory, the new virtual machine is added to both the NETLAB+ inventory and vCenter in one operation. NETLAB+ also supports linked clones (virtual machines that share disk content with another parent virtual machine).
- **Clone Pod.** If a pod contains only virtual machines, NETLAB+ can clone the entire pod in one operation. Each virtual machine in the source pod is cloned and added to both the NETLAB+ inventory and vCenter in one operation.

### 5.3 Importing VMs into the Virtual Machine Inventory

The following procedure is used to import an existing virtual machine or template from vCenter into the NETLAB+ Virtual Machine Inventory.

1. From the Advanced Virtual Machine Infrastructure Administrator page, select **Virtual Machine Inventory**. All virtual machines in the inventory are listed. If this is your first time importing VMs to the inventory, there is no list displayed.

**Virtual Machine Inventory**  
 Admin Logout

Import, clone, and manage the inventory of virtual machines to be used with NETLAB+.

Virtual Machine Name	Operating System	Role	Datacenter	Runtime Host	CPUs	Memory (MB)
2010120613 ICM 4.1 Template esxi-1	VMware ESX(i)	Template	NETLAB		2	2256
2010120613 ICM 4.1 Template esxi-2	VMware ESX(i)	Template	NETLAB		2	2256
2010120613 ICM 4.1 Template san no-Win-ISO	Linux	Template	NETLAB		1	1024
2010120613 ICM 4.1 Template vcenter-1 no-Win-inst	Windows Server 2003	Template	NETLAB		2	3072
2010120613 ICM 4.1 Template vclent no-Win-inst	Windows XP	Template	NETLAB		1	512
BackTrack Master	Linux	Master	NETLAB	10.0.0.38	1	768
Backtrack Pod 2 Standalone PC	Linux	Normal	NETLAB	10.0.0.38	1	768
BackTrack Pod1	Linux	Normal	NETLAB	10.0.0.38	1	768
BT4-R1-template	Linux	Template	NETLAB		1	768
Empty XP VM 1	Windows XP	Normal	NETLAB	10.0.0.38	1	256

2. Click the **Import Virtual Machines** button at the bottom of the page to add VMs to the inventory. If you have added more than one datacenter to your NETLAB+ system, you will be prompted to select a datacenter.
3. NETLAB+ will scan the datacenter to discover virtual machines that are not currently in the inventory. You may then click the checkbox next to the virtual machine(s) you wish to import and then click **Import Selected Virtual Machines**.

**Import Virtual Machines**

Select the virtual machines from datacenter **tda41** that you wish to import.

Select	Virtual Machine Name	Operating System	CPUs	Memory (MB)
<input type="checkbox"/>	ICM 4.1 Master_v1 esxi-2	Other Operating System (64 bit) (experimental)	2	2256
<input type="checkbox"/>	N3DEV POD107 VC 4.1 TEST	Windows XP Professional	1	384
<input type="checkbox"/>	N3Test ICM Pod 2	Other Operating System (64 bit) (experimental)	2	2256
<input type="checkbox"/>	NESTED ESXi 4.1 10.0.0.139	Other Operating System (64 bit) (experimental)	2	2256
<input checked="" type="checkbox"/>	Test VM 2011 esxi-1	Other Operating System (64 bit) (experimental)	2	2256

4. Select the appropriate configuration settings for each virtual machine.

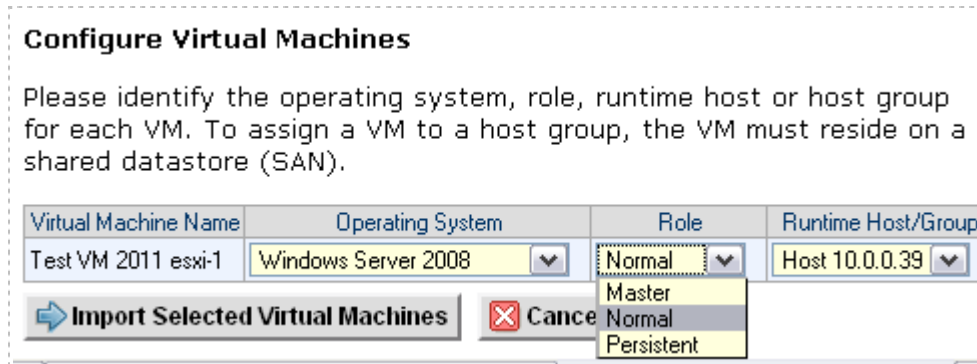

- **Operating System:** This should match the operating system installed on the virtual machine. The default value is usually correct. However, if the virtual machine is running a nested/virtualized instance of VMware ESXi, you should change this value from "Other" to "VMware ESXi".
- **Role:** Select the role that this virtual machine will play in your inventory (see Section 5.1 for definition of roles). If the virtual machine is marked as a **Template** in vCenter, it will also be set to **Template** in NETLAB+ (no selection is provided in this case).
- **Runtime Host/Group:** Select the physical VMware ESXi host that will run the virtual machine. The host currently assigned in vCenter is the default choice for virtual machines that are not marked as templates (master, normal, or persistent VMs). Template VMs cannot be powered on and therefore cannot be assigned to a host.

The runtime host should not be changed unless the virtual machine's disk files reside on a SAN and all physical ESXi hosts have access to the virtual machine disk files.

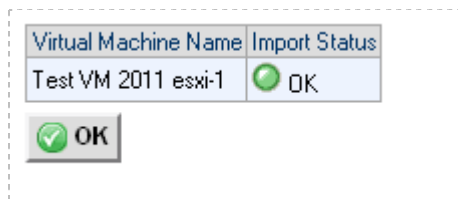

5. After selecting configuration settings and selecting **Import Virtual Machines**, the VMs will be added to the inventory.
6. Select **OK** to return to the virtual machine inventory.

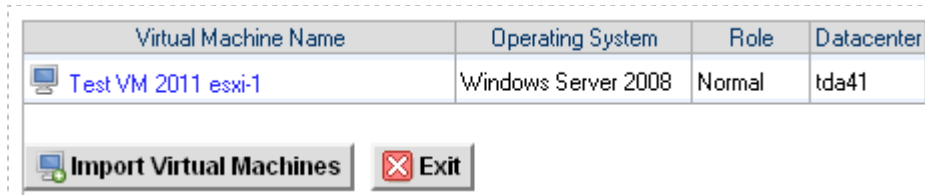

7. The imported VM is now displayed in the virtual machine inventory.



Virtual Machine Name	Operating System	Role	Datacenter
 Test VM 2011 esxi-1	Windows Server 2008	Normal	tda41

 **Import Virtual Machines**  **Exit**

## 5.4 Virtual Machine Cloning

Cloning virtual machines can save you a substantial amount of setup time if you are deploying many similar virtual machines. A *clone* is a copy of a virtual machine. Cloning a virtual machine creates a copy of a virtual machine, including its settings, any configured virtual devices, installed software, and other contents of the virtual machine's disks. You can create, configure and install software on a single virtual machine, and then clone it multiple times.

After a virtual machine is cloned, the clone can be modified as needed. For example, you may wish to change the IP address or client name on several cloned virtual machines. If there is a particular virtual machine configuration that you will want to clone many times, a good strategy is to create a *master VM* or *template VM*. Both roles designate that the virtual machine is to be used to create other virtual machines. A master VM can be part of a pod and can be powered on. A template cannot be powered on or edited, providing a more secure way of preserving a virtual machine configuration that you intend to deploy many times. A template VM in NETLAB+ is synonymous with a template VM in vSphere.

A *full clone* is an independent copy of a virtual machine that shares nothing with the parent virtual machine after the cloning operation. Ongoing operation of a full clone is entirely separate from the parent virtual machine.

A *linked clone* is a virtual machine that shares virtual disks with the parent virtual machine in an ongoing manner. This conserves disk space and allows multiple virtual machines to use the same software installation. Linked clones can be created very quickly because most of the disk is shared with the parent VM.

It is possible to create full clones using the VMware vSphere Client. Keep in mind, however, that cloning operations in NETLAB+ update both VMware vCenter and NETLAB+ inventory in one operation.



### 5.4.1 Golden Masters and Golden Snapshots

Master virtual machines and templates should be thoroughly tested before making production clones (full or linked). A master virtual machine (or template) that has been tested and deemed to be production quality is called a *golden master*. Linked clones also require a pristine snapshot that becomes the base disk for linked clones. This snapshot is called a *golden snapshot*.

Keep in mind the following important rules about golden snapshots.

1. Updates to the golden snapshot only affect NEW clones (full or linked).
2. Updates to the golden snapshot do not affect EXISTING clones (full or linked). Since snapshots operate on disk sectors and not individual files, this would lead to disk corruption and is prevented by vSphere.

It is inevitable that at some point your master VMs will need to be updated, either in response to a defect or to install new files. When this need arises, you must decide whether to update existing clones, or create them over again. Since linked clones can be made very quickly (including pod cloning), it may be easier to simply re-clone from the updated master VMs. Should you decide to update existing clones, be sure to create a new snapshot on each clone if the clone is a normal VM that reverts to snapshot.

### 5.4.2 Using NETLAB+ to Clone a Single Virtual Machine

NETLAB+ provides a convenient way to clone virtual machines. In order to clone virtual machines within NETLAB+, you must first create a source virtual machine to be used as the source for the clone. Creating virtual machines is discussed in detail in [Remote PC Guide Series - Volume 4, Creating and Configuring Virtual Machines for NETLAB+](#). The source virtual machine must also be registered in the NETLAB+ inventory.

1. To clone a virtual machine, select the source virtual machine to be cloned in the NETLAB+ Virtual Machine Inventory. In this example we have selected a virtual machine that has been designated a master. Notice also that since this virtual machine has been assigned to a pod, the pod name and link to the pod management page are available.
2. Begin the cloning process by selecting the **Clone** button.

**Showing VM ICM Master esxi-1**

Virtual Machine Name	ICM Master esxi-1	<b>Rename</b>
Operating System	VMware ESX(i)	
Role	Master	<b>Change Role</b>
Datacenter	tda41	
Runtime Host	10.0.0.39	
Host Group	n/a	
CPU <sub>s</sub>	2	
Memory (MB)	2256	
Pod ID	1000	
Pod Name	ICM Master Pod	
PC Name	esxi-1	
Parent	(no parent)	
Children	30	
Datacenter Unique Identifier	50003a87-c060-3e56-0b48-14070ac1f623	
Datacenter Storage Location	[datastore-37-san-3] ICM Master esxi-1/ICM Master esxi-1.vmx	
Comments		

**Edit** Change virtual machine parameters.

**Clone** Clone this virtual machine.



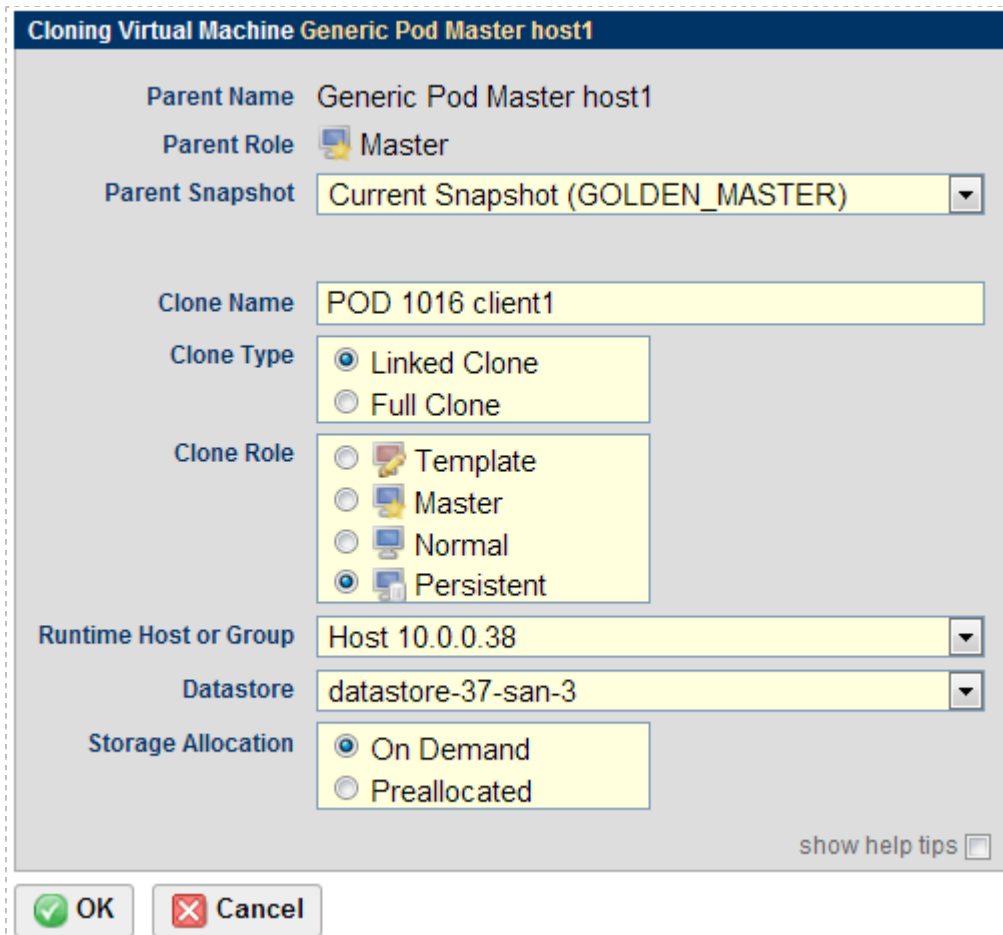

**Remove** Remove this virtual machine from the NETLAB+ inventory (and optionally from the datacenter).

**Exit** Return to inventory.

3. The **Clone Virtual Machine** screen will be displayed. Select the appropriate settings for the fields as described below.



**Cloning Virtual Machine Generic Pod Master host1**

Parent Name: Generic Pod Master host1  
Parent Role:  Master  
Parent Snapshot: Current Snapshot (GOLDEN\_MASTER) ▼  
Clone Name: POD 1016 client1  
Clone Type:  Linked Clone  
 Full Clone  
Clone Role:   Template  
  Master  
  Normal  
  Persistent  
Runtime Host or Group: Host 10.0.0.38 ▼  
Datastore: datastore-37-san-3 ▼  
Storage Allocation:  On Demand  
 Preallocated  
show help tips

OK  Cancel

- **Parent Name:** The name of the existing parent virtual machine. In this example we are making a clone of a virtual machine designated as a master. This master is the parent of the virtual machine.
- **Parent Role:** The role the parent virtual machine plays in the inventory.
- **Parent Snapshot:** A snapshot name on the parent virtual machine from which to base the clone. If this parameter is set, the clone is based on the snapshot point. This means that the newly created virtual machine will have the same configuration as the virtual machine at the time the snapshot was taken. If this property is not set, the clone is based on the virtual machine's current configuration. Linked cloning requires this parameter to be set to a snapshot.
- **Clone Name:** The name of the new virtual machine.

- **Clone Type:** There are two types of clones:
  - **Linked Clone:** A copy of a virtual machine that shares virtual disks with the parent virtual machine in an ongoing manner. This conserves disk space and allows multiple virtual machines to use the same software installation. Linked clones can be created very quickly because most of the disk is shared with the parent VM.
  - **Full Clone:** An independent copy of a virtual machine that shares nothing with the parent virtual machine after the cloning operation. Ongoing operation of a full clone is entirely separate from the parent virtual machine.
- **Clone Role:** Assign the clone to the role it will play in the inventory.
  - **Template:** A pristine virtual machine image used as the basis for cloning many virtual machines. Template VMs cannot be powered on, modified, or assigned to pods.
  - **Master:** A virtual machine used as the basis for cloning other virtual machines. Master VMs can be assigned to pods, modified and powered on.
  - **Normal:** A virtual machine that can be assigned to a pod. A normal VM will typically revert to a specified snapshot at the start of a lab reservation.
  - **Persistent:** A virtual machine that can be assigned to a pod and retains its state between labs. A persistent VM is typically used in conjunction with Pod Assigner to create long-term personal pods.
- **Runtime Host:** The host server where the virtual machine will run.
- **Datastore:** The VMware datastore that will contain the new VM's virtual disk files.
- **Storage Allocation:** Indicate the type of storage allocation to be used for the virtual machine.
  - **On Demand** allocates storage for the new virtual machine as needed; this favors storage reduction at the expense of decreased write performance.
  - **Preallocated** allocates all storage for the new virtual machine in advance; this favors better write performance at the expense of increased storage.

4. Indicate the appropriate selections for each field and then click the **Clone** button to initiate the cloning process. The results of the process will be displayed.

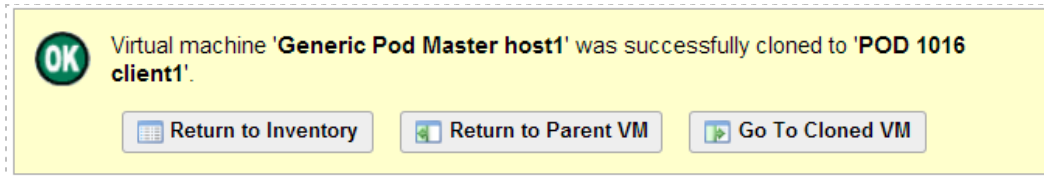

## 5.5 Assigning Virtual Machines to Pods

The virtual machines residing in the Virtual Machine Inventory must be assigned to an equipment pod in order to be available to users for scheduled access. Remote PCs are only available in pods where the network topology indicates the existence of lab PCs.

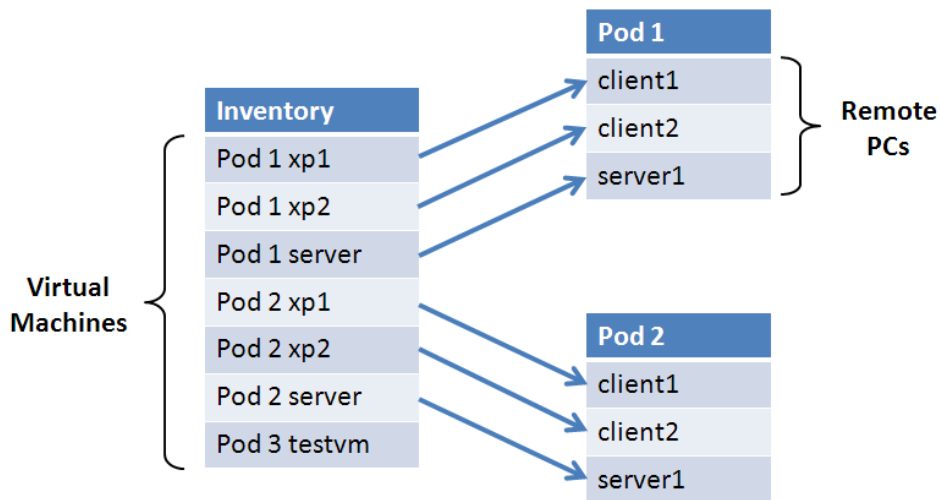

In this section, we will discuss the methods that may be used to assign virtual machines to equipment pods.

1. Select the **Equipment Pods** administrator option. As an example, we will use a newly created equipment pod that is designed to include one PC. For details on creating equipment pods refer to the “Adding New Pods” section of the [NETLAB+ Administrator Guide](#). Notice that the type of the PC/VM is indicated as “ABSENT”. This is the default setting for PCs in new pods.

- To display the PC settings, select the button to the left of the PC name.

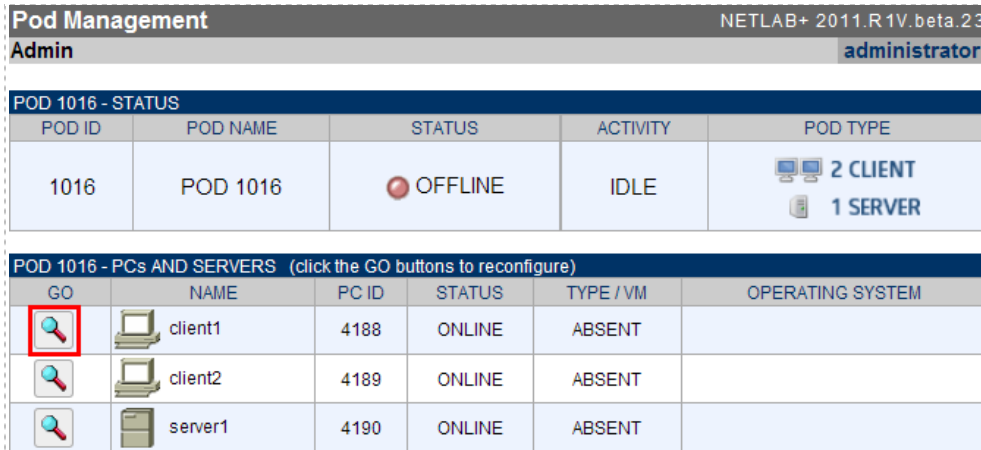



**Pod Management** NETLAB+ 2011.R1V.beta.23  
 Admin administrator

**POD 1016 - STATUS**

POD ID	POD NAME	STATUS	ACTIVITY	POD TYPE
1016	POD 1016	OFFLINE	IDLE	2 CLIENT 1 SERVER

**POD 1016 - PCs AND SERVERS** (click the GO buttons to reconfigure)

GO	NAME	PC ID	STATUS	TYPE / VM	OPERATING SYSTEM
	client1	4188	ONLINE	ABSENT	
	client2	4189	ONLINE	ABSENT	
	server1	4190	ONLINE	ABSENT	

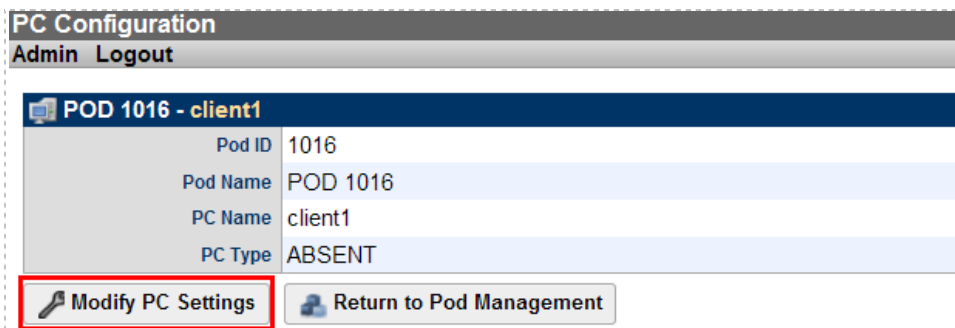

- Select the option to **Modify PC Settings**.



**PC Configuration**  
 Admin Logout

**POD 1016 - client1**

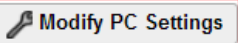
Pod ID	1016
Pod Name	POD 1016
PC Name	client1
PC Type	ABSENT



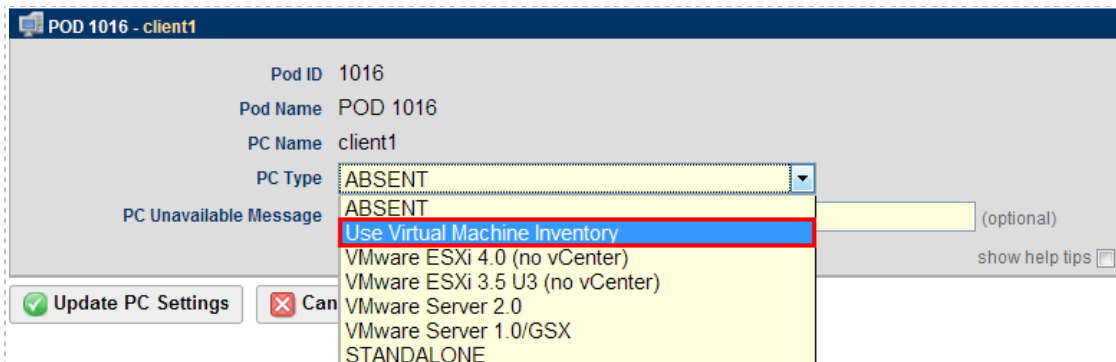

- Set the PC Type to **Use Virtual Machine Inventory**. This will allow you to use a virtual machine defined in the Virtual Machine Inventory (VMI). The other selections are for backward compatibility with other technologies that do not integrate with VMI and vCenter.

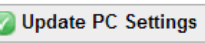

**POD 1016 - client1**

Pod ID	1016
Pod Name	POD 1016
PC Name	client1
PC Type	ABSENT
PC Unavailable Message	ABSENT (optional)

 

show help tips

5. If your system includes more than one datacenter, you will be prompted to select the datacenter where the virtual machine you will be selecting resides.

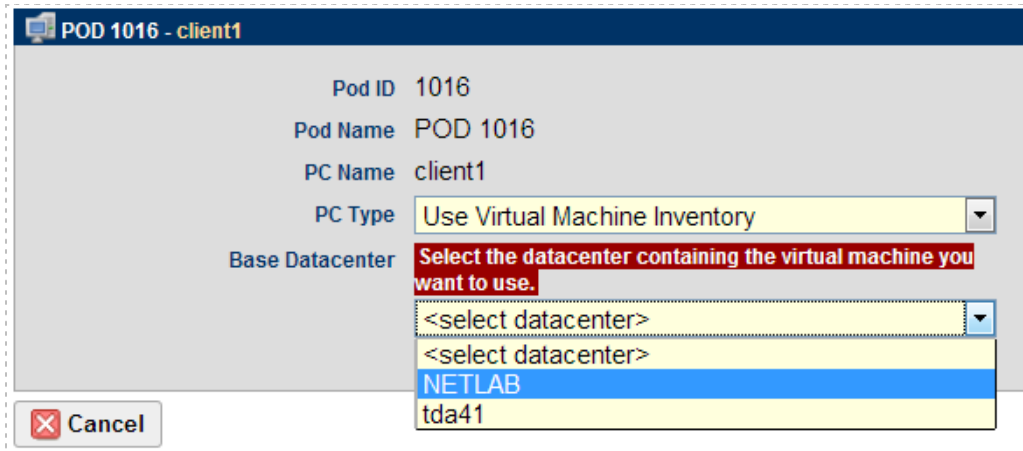

6. Select the virtual machine that you would like to assign to the remote PC. All virtual machines in your Virtual Machine Inventory that have not been assigned to a pod will be available for selection.

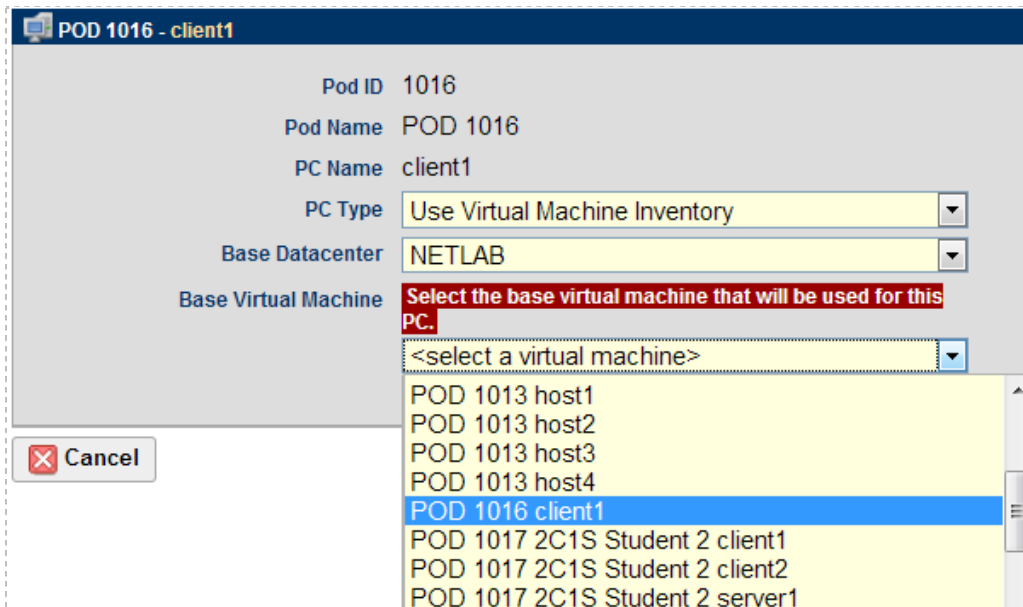

7. After selecting a virtual machine from the inventory list, you will set the PC configuration. Select the settings appropriate for the manner in which you will use the virtual machine. The PC settings are described below.

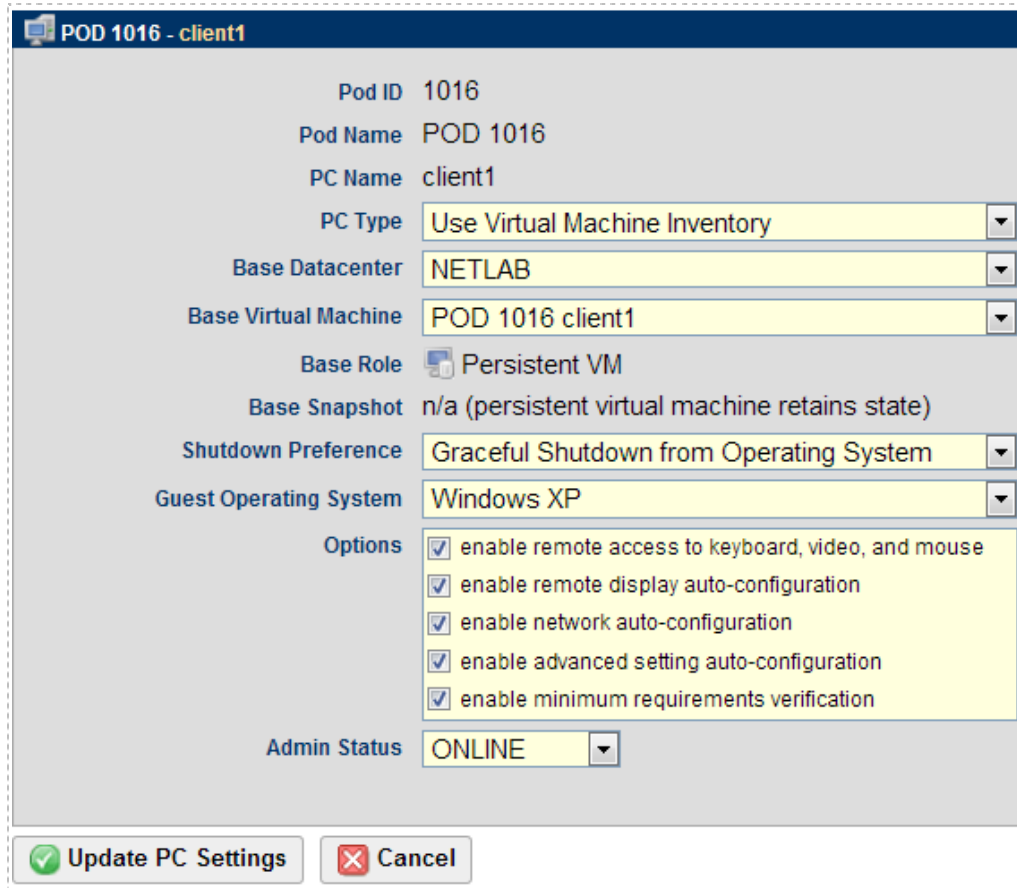

POD 1016 - client1

Pod ID 1016  
Pod Name POD 1016  
PC Name client1  
PC Type Use Virtual Machine Inventory  
Base Datacenter NETLAB  
Base Virtual Machine POD 1016 client1  
Base Role Persistent VM  
Base Snapshot n/a (persistent virtual machine retains state)  
Shutdown Preference Graceful Shutdown from Operating System  
Guest Operating System Windows XP

Options

- enable remote access to keyboard, video, and mouse
- enable remote display auto-configuration
- enable network auto-configuration
- enable advanced setting auto-configuration
- enable minimum requirements verification

Admin Status ONLINE

Update PC Settings Cancel

- **Pod ID:** The NETLAB+ identifier of the pod containing this PC.
- **Pod Name:** The user-defined name of the pod containing this PC.
- **PC Name:** The name of the PC as defined in the pod design.
- **PC Type:** The setting should remain at **Use Virtual Machine Inventory**. This allows you to select a virtual machine defined in the NETLAB+ Virtual Machine Inventory. The VMI offers the most advanced VM configuration and automation capabilities available in NETLAB+.
- **Base Datacenter:** The virtual datacenter that contains the virtual machine to be used for this PC (unless overridden by a lab).
- **Base Virtual Machine:** The virtual machine that will be used for this PC.



- **Base Role:** The pre-assigned role that the base virtual machine plays in the inventory.
- **Base Snapshot:** The snapshot that will be used to revert the base virtual machine to a clean state during pod initialization, user initiated scrub action, and at the end of a lab reservation. This setting does not apply to persistent VMs because that always retain state.
- **Shutdown Preference:** Select the preferred shutdown sequence if the virtual machine is still powered on at the end of a lab reservation. If a base snapshot is configured, it is reverted first. If the virtual machine is still powered on after reverting to the specified snapshot, the preferred shutdown sequence is executed. Otherwise, the final power state will be the same as the snapshot state.
  - **Graceful Shutdown from Operating System:** Perform an orderly shutdown from the operating system if possible (i.e. VMware Tools is supported and installed on the VM). This is best setting in most situations. If an orderly shutdown is not possible, the virtual machine is powered off.
  - **Power Off:** Powers off the virtual machine. Does not perform an orderly shutdown.

This option is not recommended for persistent virtual machines as this may lead to disk corruption.

- **Suspend Virtual Machine:** Suspend the virtual machine in its current state. When powered on, it will resume in the same state without booting.

This option will cause virtual machines memory and page files to be retained on disk. Significant disk space per VM may be required to support this option. Network connection state is not preserved.

- **Keep Running:** The virtual machine is left in the powered on state.

This is rarely desirable since the VM will continue to consume host CPU and memory resources.

- **Guest Operating System:** The operating system running on this virtual machine.
- **Options:** Enable or disable automated features.
  - **Enable remote access to keyboard, video, and mouse:** if enabled, NETLAB+ will allow the virtual machine to be accessed using a built-in remote PC viewers. Keep this option enabled unless you do not want users to access the VM; for example, a special server in the pod that should not be configured by the user.
  - **Enable remote display auto-configuration:** if enabled, NETLAB+ will automatically configure remote display parameters on the VM after a power on or revert to snapshot operation. This option allows VMs to be cloned without manual customization of the remote display settings. Therefore, we recommend you enable this setting and be happy about it.
  - **Enable network auto-configuration:** if enabled, NETLAB+ will automatically bind the virtual machine's network adapters to the correct port group. This option allows VMs to be cloned without manual customization of networking bindings. This option is ignored if the pod type does not support automatic networking. If this setting is disabled and/or the pod type does not support automatic networking, then the virtual machine network adapters must be manually bound to the correct port group(s) using the vSphere client.
  - **Enable advanced setting auto-configuration:** if enabled, NETLAB+ will automatically program advanced virtual machine settings that may be required for a particular pod type. For example, nested VM support for the VMware IT Academy program. It is usually safe to enable this option. It will be ignored if the pod type does not require advanced settings.
  - **Enable minimum requirements verification:** if enabled, NETLAB+ will verify that the current settings of the virtual machine meet or exceed any minimum requirements established for the remote PC to which it is assigned. It is usually safe to enable this option. The setting will be ignored if the pod type does not specify a set of minimum requirements for the remote PC.
- **Admin Status:** Set administrative status to ONLINE to enable this PC. You can temporarily disable this PC by setting the administrative status to OFFLINE.

After updating all PC configuration settings as needed, select **Modify PC Settings**.

9. After the settings have updated, you may continue to the Pod Page or the PC page.

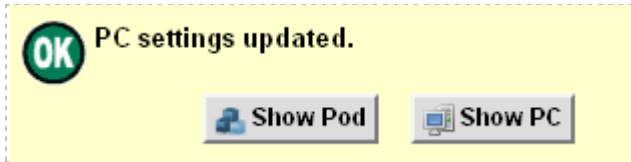

### 5.5.1 Configuring Control Switch 802.1q Trunk Ports

To allow virtual machines to communicate with real equipment pods, configure 802.1q trunk mode on all control switch ports connecting to your ESXi inside vmnics. In addition, all uplinks between control switches must also be 802.1q trunks.

You must console into the control switches to perform this action. The control switch console password is `router`. The enable secret password is `cisco`. These passwords are used by NETLAB+ automation and technical support - please do not change them.

```
interface x/x
description inside connection for ESXi Server
switchport mode trunk
switchport nonegotiate
no switchport access vlan
no shutdown
```

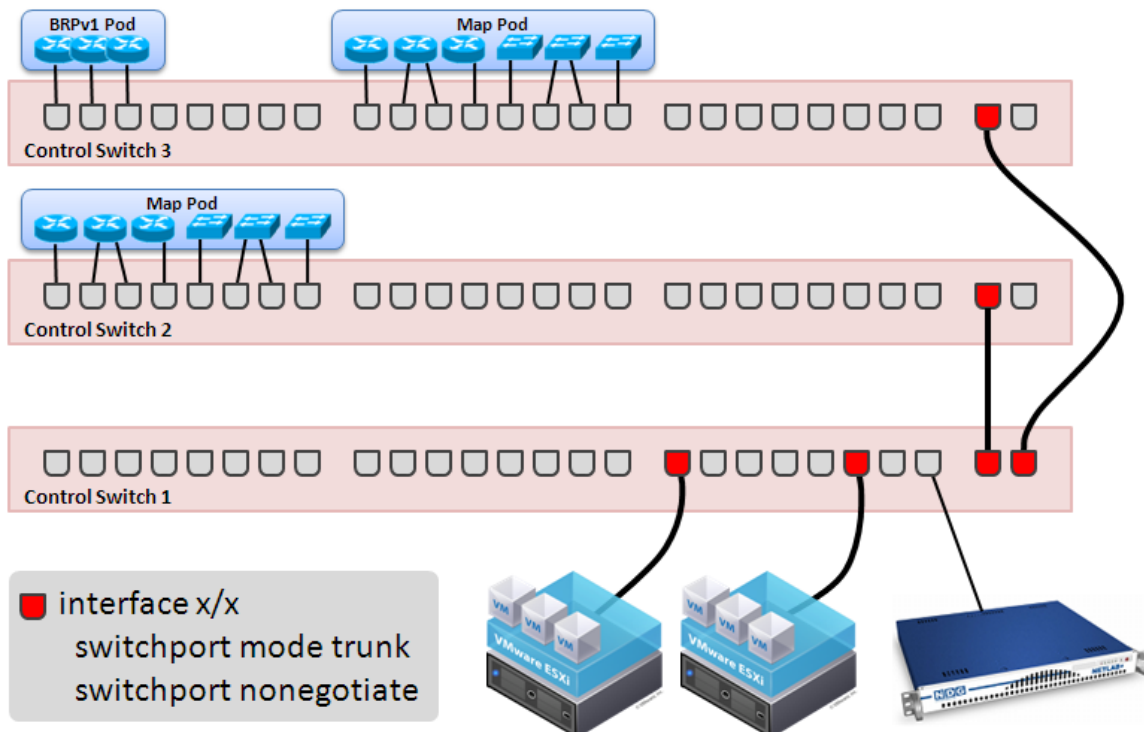

After you have configured the control ports for ESXi inside host connections and inter-switch uplinks, verify that the ports are up and operating in trunk mode.

1. Verify each ESXi host control port and inter-switch uplink is connected and line protocol is up. Substitute the designated interfaces names for x/x.

```
netlab-cs1# show interface x/x  
x/x is up, line protocol is up (connected)
```

2. Verify each ESXi host control port and inter-switch uplink is operating in 802.1q trunk mode.

```
netlab-cs1# show interface trunk
```

Port	Mode	Encapsulation	Status	Native vlan
x/x	on	802.1q	trunking	1
x/x	on	802.1q	trunking	1
x/x	on	802.1q	trunking	1

## 5.5.2 Connecting Virtual Machines to Real Equipment Pods

This section discusses the configuration of networks to communicate between virtual machines and real lab devices in the topology. You can skip this section if your virtual machines do not need to communicate with real lab equipment.

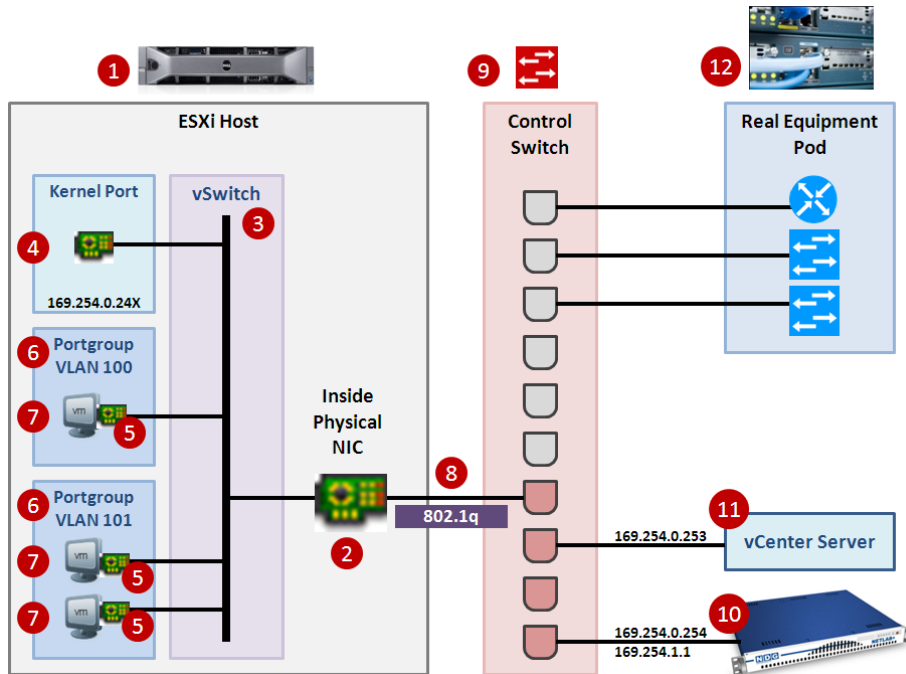

Virtual machines [7] running on an ESXi host talk to real equipment pods [12] using port groups [6], the inside virtual switch [3] and control switches [9]. Inside networking is always used for this purpose. In the last two sections, you established an inside network connection and configured 802.1q VLAN trunking on the link connecting to your control switch [8].

A real equipment pod may have one or more networks. 802.1q virtual LANs (VLANs) are the glue that binds virtual machines [7] and real equipment [12] with the proper pod networks. A unique set of VLAN identifiers for each pod is automatically allocated by NETLAB+ and programmed into the control switches [9] by NETLAB+ when the pod is created. Port groups [6] are assigned to a specific VLAN ID, thereby allowing virtual machine network adapters [5] to be placed in a specific VLAN.

As of version 2011.R2, NETLAB+ will automatically setup and teardown VLAN based port groups on the inside vSwitch on NDG standard pods.

Automatic network setup on NDG standard pods occurs when a pod is reserved. Automatic network teardown on NDG standard pods occurs when a reservation completes. These features are enabled by default but can be disabled on a per pod basis.

Refer to "Appendix A" of the [Remote PC Guide for VMware Implementation Using ESXi versions 4.01 and 4.1 U2 with vCenter](#) for setup of pods that require manual networking, such as custom pods.

### 5.5.2.1 Creating a Real Equipment Pod

Creating a real equipment pod in NETLAB+ should be done first. This will automatically generate the required number of VLANs for the selected pod type, and add those VLANs to the control switches. This should be done before ESXi host networking is configured.

1. Login to the NETLAB+ administrator account.
2. Select **Equipment Pods**.
3. Click the **Add a Pod** button at the bottom of the page.
4. Select the desired pod type. Only pod types that use both real lab equipment and remote PCs are relevant to this section. Our examples use the Multi-purpose Academy Pod, which contains 3 routers, 3 switches, and 3 remote PCs.
5. Complete the **New Pod Wizard**. Please refer to the [NETLAB+ Administrator Guide](#), NDG website pod specific web pages, and NDG pod guides for pod specific installation instructions.

After the pod is created, you will be placed in the Pod Management page. You will notice that all virtual machines are initially ABSENT. You will add virtual machines to the pod later.

### 5.5.2.2 Determining the Base VLAN and VLAN Pool

This is now an automated task for NDG standard pods as of NETLAB+ version 2011.R2. Refer to "Appendix A" of the [Remote PC Guide for VMware Implementation Using ESXi versions 4.01 and 4.1 U2 with vCenter](#) for manual networking setup guidance for custom pods or pods that do not support automatic networking.

### 5.5.2.3 Creating Port Groups for Pod VLANs on the Inside Network

This is now an automated task for NDG standard pods as of NETLAB+ version 2011.R2. Refer to "Appendix A" of the [Remote PC Guide for VMware Implementation Using ESXi versions 4.01 and 4.1 U2 with vCenter](#) for manual networking setup guidance for custom pods or pods that do not support automatic networking.

## 5.6 NDG Virtual Machine Topologies

NDG standard topologies that contain only virtual machines can be replicated and deployed very quickly using a combination of pod cloning, automatic networking and automatic remote display setup features.

The list of NDG automated virtual machine topologies includes:

- 25 automated client/server pods for General IT usage. For details see <http://www.netdevgroup.com/content/generalit>
- Automated topologies are available for a variety of NETLAB+ supported content, developed in collaboration with leading industry training programs, including:
  - VMware IT Academy Program®
  - EMC Academic Alliance®
  - Linux Professional Institute
  - Red Hat® Academy

Once production pods are created using the pod cloning utility, they are ready to go. When an automated pod is scheduled and lab reservation begins, the following automation takes place:

- NETLAB+ will automatically create virtual switches and port groups required for the pod.
- NETLAB+ will bind the virtual network adapters of each VM to the correct port group.
- NETLAB+ will configure remote display parameters automatically.

When the lab reservation is over, NETLAB+ will tear down the virtual switches and port groups created for the pod to free resources on the host.

## 6 Cloning Virtual Machine Pods

The ability to clone entire virtual machine pods is a NETLAB+ feature that greatly reduces the amount of time needed for setup of your system, when the situation calls for several identical equipment pods consisting of virtual machines.

**Pod cloning may be used to clone pods that consist of virtual machines only.** At this time, it is not possible to clone pods that include hardware lab devices (such as routers and switches).

NETLAB+ pod cloning supports *linked clones*. A linked clone is a virtual machine that shares virtual disks with the parent virtual machine in an ongoing manner. This conserves disk space and allows multiple virtual machines to use the same software installation. The pod cloning utility can create linked clones very quickly because most of the virtual disk is shared with the parent VM.

There are two basic pod-cloning strategies, depending on whether your virtual machines will be stored on an ESXi host local disk or on a Storage Area Network (SAN). Both strategies leverage linked clones so that production virtual machine pods can be created quickly with minimum disk space.

**Local Disk Strategy.** If your virtual machines are stored on an ESXi server local disk, you will create one master pod (per pod type) on each ESXi host. Production VMs on each server will link to their respective master pod VMs. Each host requires a master pod because Host A cannot access the disks of Host B, and vice-versa.

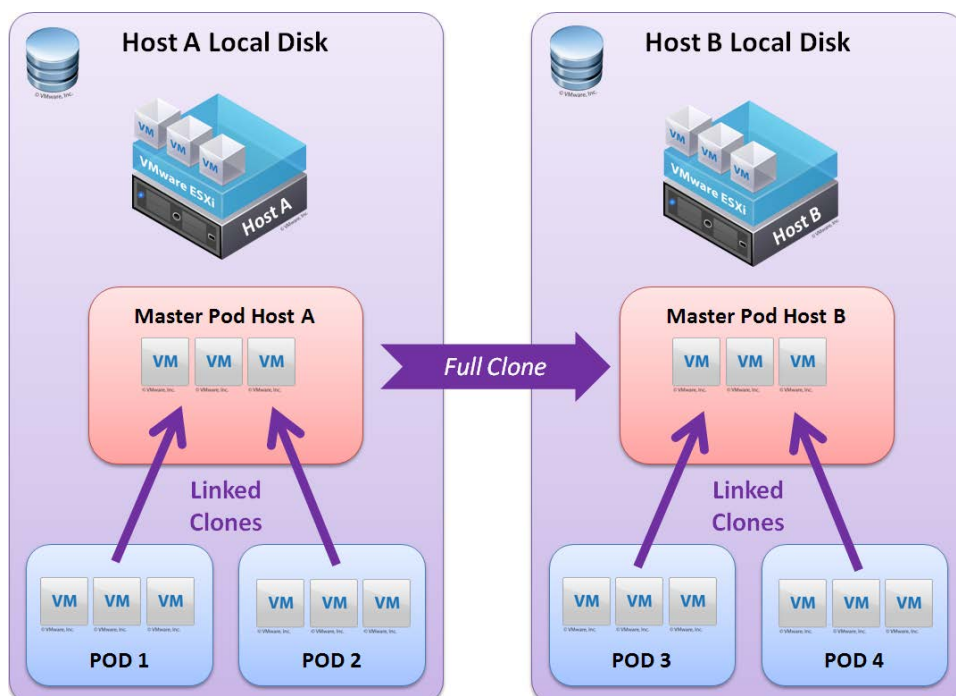



**Storage Area Network Strategy.** Only one master pod (per pod type) is required if your virtual machines are placed on a SAN. Virtual machines in the production pods will link to the virtual machines in the master pod, regardless of which ESXi host the virtual machines have been assigned to run on. This is possible because each ESXi host has access to the storage area network (where all virtual disks reside).

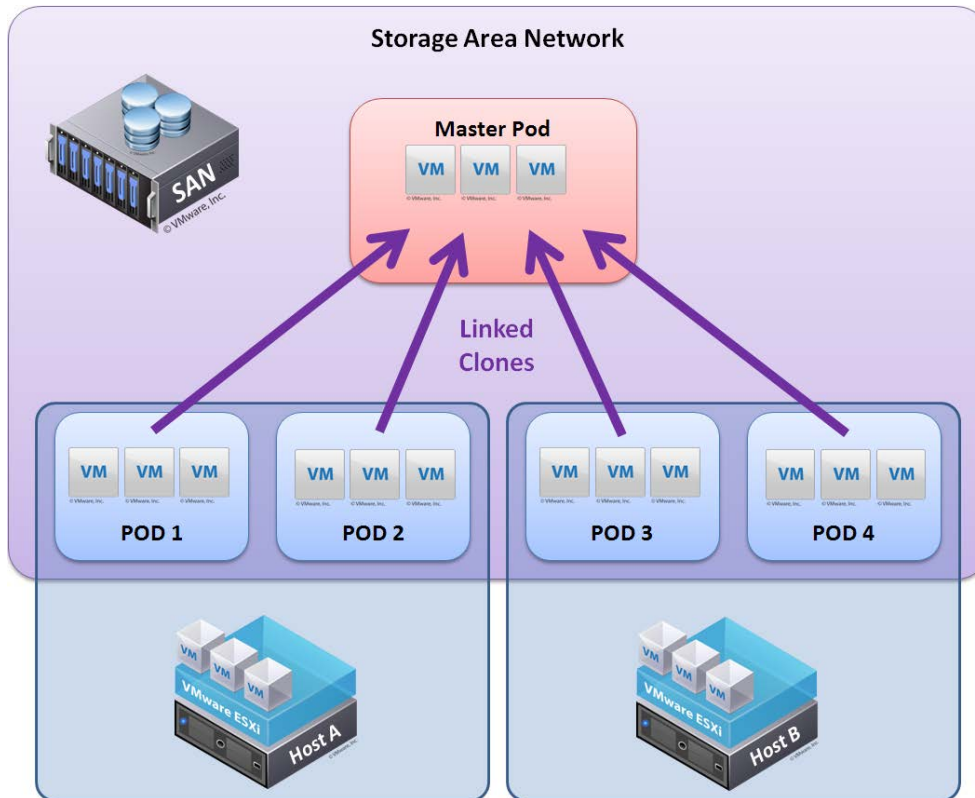

NDG performs all testing on servers with Internal Direct Attached Storage (i.e. RAID arrays and RAID controllers directly attached to each ESXi host server). This is the configuration that most academic institutions are likely to find affordable and adopt. A Storage Area Network (SAN) is a dedicated network that provides access to consolidated, block level data storage that can be used for disk storage in a VMware vSphere environment.

**Currently NDG does not provide benchmarks, guidance or troubleshooting for SAN configurations.** Our documentation may show an optional SAN in the environment, however this is not a recommendation or requirement to deploy a SAN.

**NDG benchmarks and capacity planning guidance do not account for the additional latencies introduced by SAN.**

## 6.1 Golden Masters and Golden Snapshots

Virtual machines in a master pod should be thoroughly tested before pod cloning takes place (full or linked). A master virtual machine that has been tested and deemed to be production quality is called a *golden master*. Linked clones also require a pristine snapshot that becomes the base disk for linked clones. This snapshot is called a *golden snapshot*.

Keep in mind the following important rules about golden snapshots.

1. Updates to the golden snapshot only affect NEW clones (full or linked).
2. Updates to the golden snapshot do not affect EXISTING clones (full or linked). Since snapshots operate on disk sectors and not individual files, this would lead to disk corruption and is prevented by vSphere.

At some point, the VMs in your master pod will need to be updated, either in response to a defect or to install new files. When this need arises, you must decide whether to update existing cloned pods, or create them over again. Since linked clones can be created very quickly, it may be easier to simply re-clone the pod rather than touch every existing clone pod.

## 6.2 Creating a Master Pod

The first step in the pod cloning process is to create a master pod. At this time, the pod type must contain only virtual machines if it is to be cloned using the pod cloning utility. The following steps are used to create a master pod.

1. Create a new pod in NETLAB+ of the desired type. All of the pod VMs will initially be set to ABSENT.
2. Build some virtual machines that will map to each remote PC position for the pod type you are targeting.
  - a. Each virtual machine in the master pod should have its role set to **master**. The role can be set when importing a virtual machine or cloning a virtual machine. You can also change the role of an existing virtual machine to master.
  - b. Whether you are storing VMs on an ESXi local disk or SAN, you should assign the master to run on one of the ESXi hosts so software can be installed on the VMs and the pod tested as a single functional unit.
3. Assign your master virtual machines to the new master pod (Section 5.5).
4. You may wish to use Pod Assigner at this point to prevent others from scheduling the pod. You may assign the pod to an instructor account for this purpose.

5. Many NDG virtual pods support automatic networking. On the other hand, if you are using a custom built pod or other pod that does not have automatic networking support, you should make sure the virtual machines network adapters are bound to the correct networks at this time.
6. Bring the pod online so that it can be tested.
7. Test the master pod.
  - a. Login to an instructor account (use the same account used with pod assigner in step 3 if applicable).
  - b. Scheduled lab reservation in NETLAB+ and test the pod thoroughly including testing all the virtual machines to assure proper configuration.
8. Linked clones in a master pod require a pristine snapshot that becomes the base disk for your production linked clones. This snapshot is called a *golden snapshot*. Once you are **very confident** that the virtual machines in the master pod are free of defects, it is time to create a golden snapshot.
  - a. In most cases, you will want to power down every virtual machine before taking the golden snapshot. You can do this from the NETLAB+ action tab or from the vSphere client.
  - b. Take a snapshot on each master VM using a name such as GOLDEN\_SNAPSHOT. Currently, you must take snapshots using the vSphere client.

Once each virtual machine in the master pod has a golden snapshot, linked clones are possible.



### 6.3 Cloning a Virtual Machine Pod Using Linked Clones







In this section you will learn how clone a master virtual machine pod using linked clones. Let's suppose that the master pod is called pod MP1 and we want to create similar cloned pods called CP1, CP2, CP3, etc. The first time you clone the master MP1 to create cloned pod CP1, you will need to specify some parameters for each virtual machine in CP1. NETLAB+ will keep track of the parameters used to clone CP1. You can then instruct NETLAB+ to "create a CP2 pod like CP1" by cloning from CP1 instead of MP1.

In our first example, we will make clone the master pod for the first time (MP1 to CP1). The 3 virtual machines are master VMs with a golden snapshot. Recall that a golden snapshot on master VM is required to create linked clones.

**Pod Management**
NETLAB+ 2011.R 1V.beta.23

**Admin**
administrator

POD 1020 - STATUS					
POD ID	POD NAME	STATUS	ACTIVITY	POD TYPE	
1020	2C1S Host A Master 1020	OFFLINE	IDLE	 <b>2 CLIENT</b>  <b>1 SERVER</b>	

POD 1020 - PCs AND SERVERS (click the GO buttons to reconfigure)						
GO	NAME	PC ID	STATUS	TYPE / VM	OPERATING SYSTEM	
	 client1	4191	ONLINE	Host A Master client1	Windows XP	
	 client2	4192	ONLINE	Host A Master client2	Windows XP	
	 server1	4193	ONLINE	Host A Master server1	Windows XP	

**Pod 1020 -- Management Options**

Online
Bring this pod ONLINE and make it available for reservations.

Test
Tell me if this pod is working properly.

Clone
Create a new pod based on the settings of this pod.

Rename
Rename this pod.

Delete
Remove this pod from NETLAB.

← Back to Previous Page

If the clone button appears on the pod management screen, the pod can be cloned. If the clone button does not appear, the pod is not eligible for cloning (i.e. it contains real equipment, or contains VMs that do not use the NETLAB+ inventory).

1. We begin the pod cloning process by clicking the **Clone** button.
2. Select a numeric ID for the new pod and click **Next**.

Select an ID for the new pod...

Source Pod ID 1020

Source Pod Name 2C1S Host A Master 1020

New Pod Type NDG 2 Client / 1 Server Pod

New Pod ID

→ Next
✖ Cancel

3. Specify a unique descriptive name for the new pod and click **Next**.

Select an ID for the new pod...

Source Pod ID 1020

Source Pod Name 2C1S Host A Master 1020

New Pod Type NDG 2 Client / 1 Server Pod

New Pod ID 1021

New Pod Name

→ Next
← Previous
✖ Cancel

4. The pod cloning parameter form appears.

Source Pod ID 1020  
 Source Pod Name 2C1S Host A Master 1020

New Pod Type NDG 2 Client / 1 Server Pod  
 New Pod ID 1021  
 New Pod Name 2C1S Host A Pod 1021

PC Name	Source Virtual Machine	Source Snapshot	→	Clone Name	Clone Type	Clone Role	Runtime Host	Clone Datastore	Storage Allocation
client1	Host A Master client1	GOLDEN_SNAPSHOT		Pod 1021 client1	Linked	Persistent	Host 10.0.0.38	datastore-37-san-3	On Demand
client2	Host A Master client2	GOLDEN_SNAPSHOT		Pod 1021 client2	Linked	Persistent	Host 10.0.0.38	datastore-37-san-3	On Demand
server1	Host A Master server1	GOLDEN_SNAPSHOT		Pod 1021 server1	Linked	Persistent	Host 10.0.0.38	datastore-37-san-3	On Demand

Clone Pod
 Previous
 Cancel

5. Verify that each source virtual machine is set to the correct master virtual machine.
6. Verify that each source snapshot is set to the golden snapshot.
7. Set each clone type to **Linked**.
8. Set the role to **Normal** or **Persistent**. Use normal if the VMs will revert to a snapshot to reset state. Use persistent if the VMs will retain state between lab reservations.
9. Set each runtime host to the ESXi server where each VM will run. **This should be set to the same host containing the master VMs unless your VMs are located on a SAN.** If using a SAN, you can change the value as desired.
10. Set the datastore that will be used to store the new VMs. This datastore must be accessible to the runtime host.
11. Verify that the Storage Allocation setting is set to **On Demand**.
12. Click **Next** to start the cloning process.

**Clone Pod**

[Admin](#) [Logout](#)

New Pod ID	New Pod Name	New Pod Type	Pod Clone Progress	Total Errors	Total Warnings
1021	2C1S Host A Pod 1021	NDG 2 Client / 1 Server Pod	DONE	0	0

PC Name	Virtual Machine Name	Progress	Notifications
client1	Pod 1021 client1	DONE	✓ Cloned virtual machine. ✓ Attached virtual machine to pod.
client2	Pod 1021 client2	DONE	✓ Cloned virtual machine. ✓ Attached virtual machine to pod.
server1	Pod 1021 server1	DONE	✓ Cloned virtual machine. ✓ Attached virtual machine to pod.

OK

## 6.4 Tasks to Perform After Pod Cloning

Here are some additional tasks that may be required after pod cloning.

- If you want to restrict access to the new pod, use the Pod Assignment utility. This is often the case with persistent pods where you want to assign virtual machines to a student or team for a long period of time.
- If the pod contains normal VMs that should revert to snapshot, take a snapshot of each new VM using the vSphere client. Make sure each remote PC is set to revert to this snapshot.
- If the virtual pod does not support automatic networking, be sure to bind each VM to the proper port group using the vSphere client. If your VMs will revert to a snapshot, be sure your snapshot is taken after this binding is made.

When you are finished with all tasks, do not forget to bring the pod online, otherwise it will not appear in the scheduler.

## 6.5 Saving Time on Subsequent Pod Cloning

In our last example, we cloned the master pod (MP1) for the first time. We had to change several parameters on the pod cloning form to produce the cloned pod (CP1). You could produce a second and third pod (CP2 & CP3) by cloning MP1 repeatedly. However, you will have to make the same form changes again and again.

A more efficient way to produce CP2 and CP3 is to clone pod CP1. When NETLAB+ sees that CP1 is based on linked clones, it will assume you want to create a similar pod using linked clones based on the same master VMs. The default values will be the same as those you set for CP1, eliminating the need for changes. In most cases, you can click the Clone Pod button without form changes and NETLAB+ will produce the correct result.

## 6.6 Creating a Full Clone of a Virtual Machine Equipment Pod

You can also use the pod cloning utility to create new pods that are full clones of the original. A full clone is an independent copy of a virtual machine that shares nothing with the parent virtual machine after the cloning operation. Ongoing operation of a full clone is entirely separate from the parent virtual machine.

The pod cloning procedure for full clones is similar to linked clones (see Section 6.3). Only the VM cloning parameters will change.

Source Pod ID 1020  
Source Pod Name 2C1S Host A Master 1020  
New Pod Type NDG 2 Client / 1 Server Pod  
New Pod ID 1030  
New Pod Name 2C1S Host B Master 1030

PC Name	Source Virtual Machine	Source Snapshot	→	Clone Name	Clone Type	Clone Role	Runtime Host or Group	Clone Datastore
client1	Host A Master client1	GOLDEN_SNAPSHOT		Host B Master 1030 client1	Full	Master	Host 10.0.0.38	datastore-37-san-3
client2	Host A Master client2	GOLDEN_SNAPSHOT		Host B Master 1030 client2	Full	Master	Host 10.0.0.38	datastore-37-san-3
server1	Host A Master server1	GOLDEN_SNAPSHOT		Host B Master 1030 server1	Full	Master	Host 10.0.0.38	datastore-37-san-3

Clone Pod  Previous  Cancel

1. Set each Clone Type to **Full**.
2. Specify a source snapshot to be used as the starting point of each cloned VM. You may also select **Current State** to clone the current disk state of the parent VM.
3. Specify the role of each new VM.
4. Select the runtime host for each new VM. Since you are making a full copy of each VM, you are free to choose a different runtime host.
5. After selecting the runtime hosts, select the datastores where the new VMs will reside.
6. Click the **Clone Pod** button.

## 6.7 Creating Pods that Run on a Multiple VMware ESXi Hosts

Virtual machines are assigned to run on a specific ESXi host. Virtual machines in the same pod should typically be assigned to the same host to simplify networking; this is required for NDG pods that support automatic networking.

To leverage the compute power of multiple ESXi hosts, you can place pods on each host so that the load will balance on average. When working with multiple ESXi hosts, your pod cloning strategy will depend on whether your virtual machines are stored on an ESXi host local disk or on a Storage Area Network (SAN). **Local Disk Pod Cloning Strategy.** Refer to the diagram below. If your virtual machines are stored on an ESXi server local disk, you will create one master pod (per pod type) on each ESXi host (MPA and MPB). Production pods on each server will link to their respective master pod VMs. Each host requires a master pod because Host A cannot access the disks of Host B, and vice-versa.

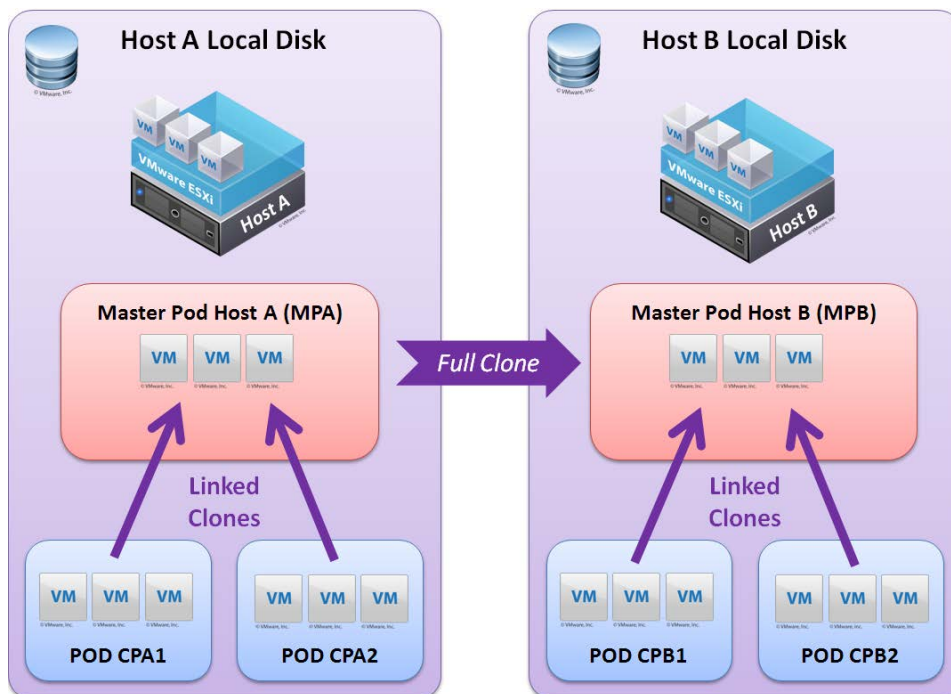

The **local disk pod cloning strategy** is played by using the following moves.

1. Create master pod MPA on host A.
2. Create the first host A production pod CPA1 using linked clones (per Section 6.3).
3. Create additional host A production pods CPA2, CPA3, and so on. Use CPA1 as the source pod to save time (per Section 6).
4. Test your production pods thoroughly on host A before moving on to Host B.
5. Create master pod MPB on host B by performing a full pod clone of master pod MPA on host A. (per Section 6).
6. Create the first host B production pod CPB1 using linked clones (per Section 6.3).



7. Create additional host B production pods CPB2, CPB3, and so on. Use CPB1 as the source pod to save time (per Section 6).

**Storage Area Network Pod Cloning Strategy.** Refer to the diagram below. Only one master pod (per pod type) is required if your virtual machines are placed on a SAN. Virtual machines in the production pods will link to the virtual machines in the master pod, regardless of which ESXi host the virtual machines have been assigned to run on. This is possible because each ESXi host has access to the storage area network (where all virtual disks reside). The only difference between the production pods is the ESXi host their virtual machines will run on.

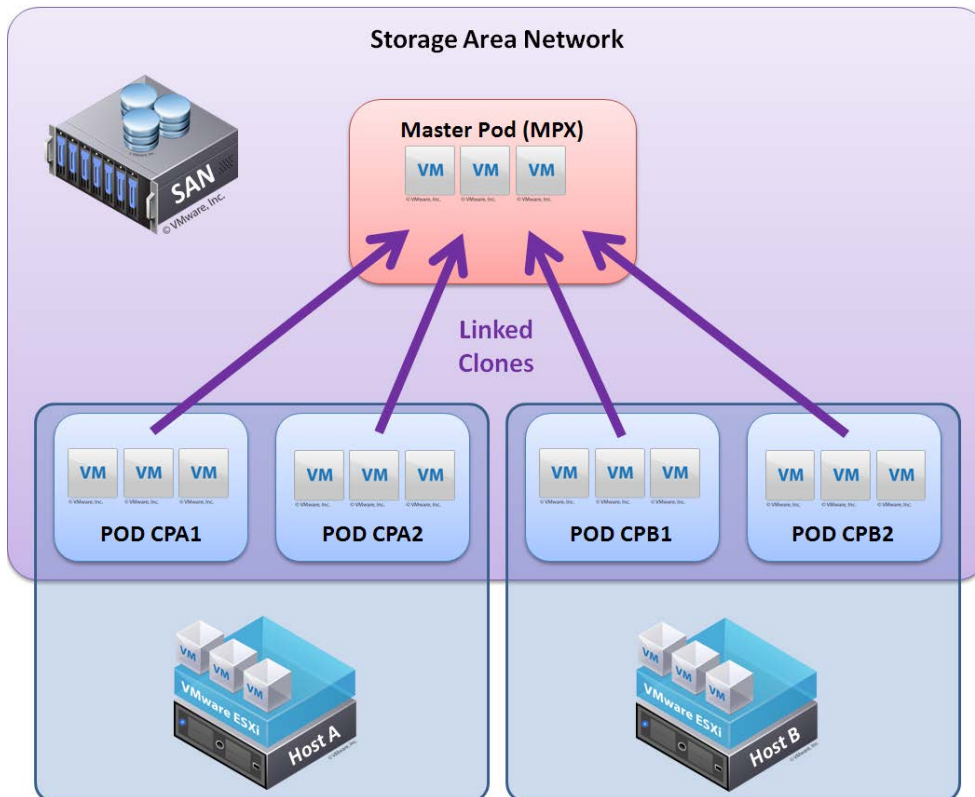

The **SAN pod cloning strategy** is played using the following moves.

1. Create a master pod MPX. Assign it to Host A.
2. Create the first host A production pod CPA1 using linked clones (per Section 6.3).
3. Create additional host A production pods CPA2, CPA3, and so on. Use CPA1 as the source pod to save time (per Section 6).
4. Create the first host B production pod CPB1 using linked clones (per Section 6.3). **This time, change each VM's Runtime Host to Host B.**
5. Create additional host B production pods CPB2, CPB3, and so on. Use CPB1 as the source pod to save time (per Section 6).

## 7 Virtual Machine Operations

This section describes common virtual machines operations and how they should be performed in the NETLAB+ environment.

The following table summarizes which operations can currently be performed in NETLAB+ and which operations must be performed using the vSphere client. This table may change in future versions of NETLAB+.

Operation	Perform Using	Refer to:
Create Virtual Machines From Scratch	vSphere Client	<i>"Creating Virtual Machines from Scratch"</i> , <a href="#">Remote PC Guide Volume 4</a>
Take Virtual Machine Snapshots	vSphere Client	<i>"Virtual Machine Snapshots"</i> , <a href="#">Remote PC Guide Volume 4</a>
Create Port Groups for Real Equipment Pods	vSphere Client	5.5.2
Create Port Groups for NDG Virtual Machine Pods	NETLAB+ (automatic)	8
Clone Individual VMs	NETLAB+	5.4
Clone Entire Virtual Machine Pods	NETLAB+	6
Delete All Virtual Machines in a Pod	NETLAB+	7.1
Delete Individual Virtual Machines	NETLAB+	7.2
Change Virtual Machine Name	NETLAB+	7.3
Change Virtual Machine Role	NETLAB+	7.4
Migrate Virtual Machine to a Different ESXi Host	vSphere Client	<i>"Migrating a Virtual Machine to a Different ESXi Host"</i> , <a href="#">Remote PC Guide Volume 4</a>

## 7.1 Delete All Virtual Machines in a Pod

If a pod contains virtual machines that reside in the inventory, you will have the option to delete those virtual machines in one operation.

**Pod Management** NETLAB+ 2011.R 1V.beta.23

**Admin** administrator

---

**POD 1016 - STATUS**

POD ID	POD NAME	STATUS	ACTIVITY	POD TYPE
1016	POD 1016	OFFLINE	IDLE	2 CLIENT 1 SERVER

---

**POD 1016 - PCs AND SERVERS** (click the GO buttons to reconfigure)

GO	NAME	PC ID	STATUS	TYPE / VM	OPERATING SYSTEM
	client1	4188	ONLINE	ABSENT	
	client2	4189	ONLINE	ABSENT	
	server1	4190	ONLINE	ABSENT	

---

**Pod 1016 -- Management Options**

- Online** Bring this pod ONLINE and make it available for reservations.
- Test** Tell me if this pod is working properly.
- Clone** Create a new pod based on the settings of this pod.
- Rename** Rename this pod.
- Delete** Remove this pod from NETLAB.

**Delete Pod**

**Admin Logout**

---

**You are about to delete pod 1021.**

If you would also like to delete the virtual machines in this pod, please choose a deletion option. This option will apply to all virtual machines in the pod.

- Do not delete any VMs (they will remain in the NETLAB+ inventory)
- Remove VMs from NETLAB+ inventory only (VMs remains in datacenter)
- Remove VMs from NETLAB+ inventory and datacenter (VM files not deleted from disk)
- Remove VMs from NETLAB+ inventory, datacenter, AND delete unshared VM files from disk

**Warning: deleting virtual machines from disk cannot be undone!**

You may choose one of four options. The option will apply to all VMs in the pod.

Option	Delete Virtual Machines From		
	NETLAB+ Inventory	vCenter Datacenter	Disk
Do not delete any VMs	No	No	No
Remove VMs from NETLAB+ Inventory	Yes	No	No
Remove VMs from NETLAB+ Inventory and datacenter	Yes	Yes	No
Remove VMs from NETLAB+ inventory, datacenter, AND delete unshared VM files from disk	Yes	Yes	Yes

Before deleting virtual machines, NETLAB+ will make sure the VMs are powered down. Any automatic networks associated with the pod will also be deleted.

The option to delete virtual machines from disk cannot be undone.

## 7.2 Deleting Individual Virtual Machines

Use NETLAB+ to delete a virtual machine that is registered in the NETLAB+ inventory. This will remove the virtual machine from NETLAB+ and optionally from the vCenter Datacenter and/or disk.

NETLAB+ will not allow an individual virtual machine to be deleted if any the following conditions are true.

- The virtual machine is assigned to a pod. You must first set the remote PC for which it is assigned to ABSENT to remove the association.
- A master virtual machine that is referenced by linked clones. This is to ensure that there is an ongoing record of the parent/child relationship.

Do not use the vSphere client to delete a virtual machine that is registered in the NETLAB+ inventory. This will cause the virtual machine to become orphaned.

Use the following procedure to delete an individual virtual machine.

1. From the administrator account, select **Virtual Machine Infrastructure**.
2. Select **Virtual Machine Inventory**.
3. Select the VM you wish to delete from the inventory.

Virtual Machine Inventory  
Admin Logout

Showing VM Empty XP VM 1

Virtual Machine Name	Empty XP VM 1	Rename
Operating System	Windows XP	
Role	Normal	Change Role
Datacenter	NETLAB	
Runtime Host	10.0.0.38	
Host Group	n/a	
CPUs	1	
Memory (MB)	256	
Pod ID	(VM is not assigned to a pod)	
Parent	(no parent)	
Children	0	
Datacenter Unique Identifier	5027288b-fa22-ab8a-a6d0-c5209e0cbb37	
Datacenter Storage Location	[datastore-37-san-3] Empty XP VM 1/Empty XP VM 1.vmx	
Comments		

Edit Change virtual machine parameters.

Clone Clone this virtual machine.

Remove Remove this virtual machine from the NETLAB+ inventory (and optionally from the datacenter).

Exit Return to inventory.

4. Check the pod id and verify the VM is not assigned to a pod. NETLAB+ will not proceed if the VM is assigned to a pod.

5. Verify the number of children is 0. NETLAB+ will not proceed if this virtual machine is the parent of linked virtual machine.
6. Click the **Remove** button.
7. Select the extent of the deletion. If you choose to delete unshared VM files from disk (third option), the VM disk files are erased and cannot be restored.

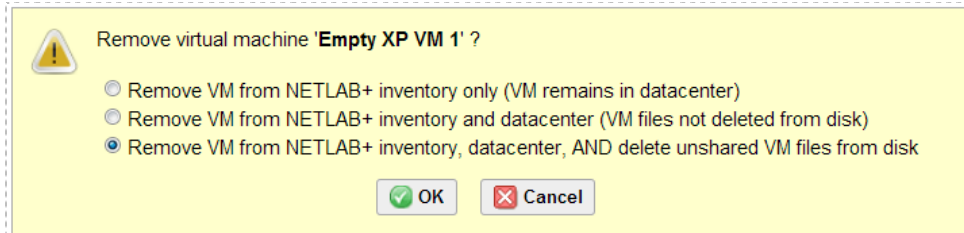

8. Click **OK** to proceed.

### 7.3 Changing the Name of a Virtual Machine

Use NETLAB+ to change the name of a virtual machine that is registered in the NETLAB+ inventory. This will ensure that the virtual machine will be named the same in both NETLAB+ and vCenter.

1. From the administrator account, select **Virtual Machine Infrastructure**.
2. Select **Virtual Machine Inventory**.
3. Select the VM you wish to rename from the inventory.
4. Click the **Rename** button.

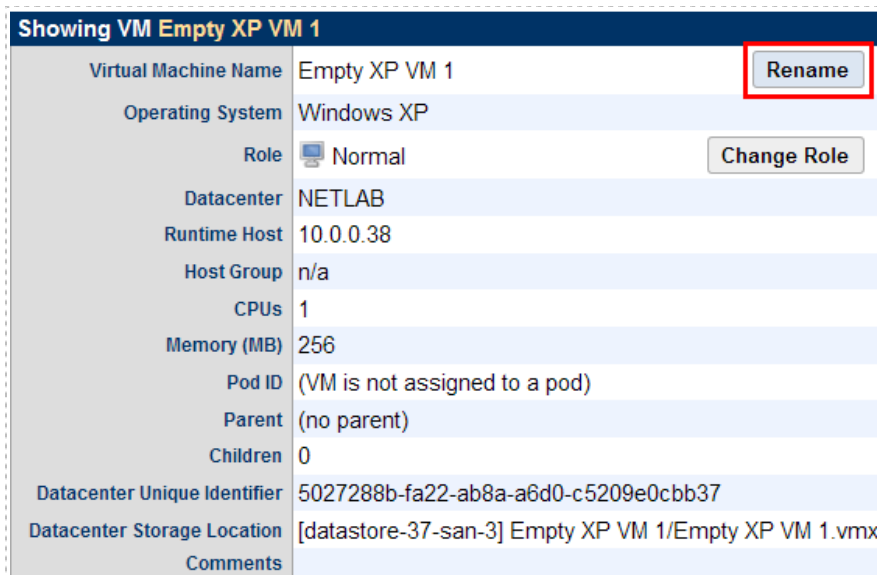

5. Provide a new name for the virtual machine. This name must be unique in both the NETLAB+ inventory and in vCenter.

**Rename Virtual Machine**

Current Name Empty XP VM 1

New Name

6. Click **OK** to complete the rename operation.

## 7.4 Changing the Role of a Virtual Machine

The role of a virtual machine is specific to NETLAB+ and changed using NETLAB+.

1. From the administrator account, select **Virtual Machine Infrastructure**.
2. Select **Virtual Machine Inventory**.
3. Select the VM whose role you wish to change from the inventory.
4. Click the **Change Role** button.

**Showing VM Empty XP VM 1**

Virtual Machine Name	Empty XP VM 1	<input type="button" value="Rename"/>
Operating System	Windows XP	
Role	<input type="button" value="Change Role"/>	
Datacenter	NETLAB	
Runtime Host	10.0.0.38	
Host Group	n/a	
CPUs	1	
Memory (MB)	256	
Pod ID	(VM is not assigned to a pod)	
Parent	(no parent)	
Children	0	
Datacenter Unique Identifier	5027288b-fa22-ab8a-a6d0-c5209e0cbb37	
Datacenter Storage Location	[datastore-37-san-3] Empty XP VM 1/Empty XP VM 1.vmx	
Comments		

5. Select the new role of the virtual machine.

**Change Virtual Machine Role**

Virtual Machine Name Empty XP VM 1

Current Role

New Role

- Persistent
- Master
- Template

If the new role is set to Template, the virtual machine will also be marked as a Template in vCenter, and any ESXi host association will be lost. If the virtual machine is assigned to a pod, NETLAB+ will not allow the role to be changed to Template.

6. If the current role is Template, you must also specify a target runtime host for the virtual machine. This is because non-template VMs are associated with a runtime host. The virtual machine will be set to run on the target host and will no longer be marked as a template in vCenter.

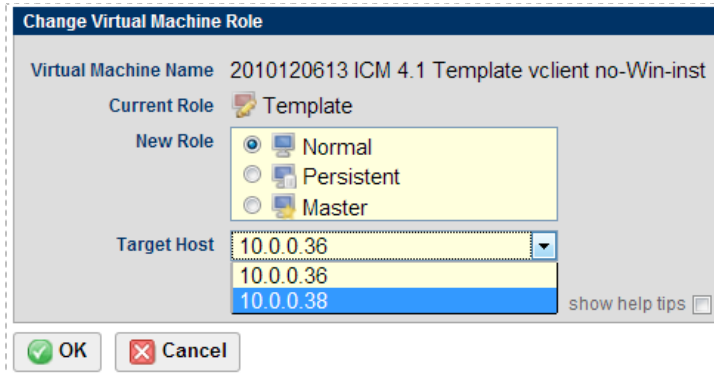

7. Click **OK** to complete the role change.



## 8 Using NDG Automated Pods

NDG provides many standard topologies that support special automation for virtual machines. Pods using these topologies are created using the techniques described earlier in this guide.

The automation described in this section requires VMware vCenter and the NETLAB+ Virtual Machine Inventory features as described in this guide.

### 8.1 NDG Real Equipment Topologies

As of NETLAB+ version 2015.R1.final, automatic networking and automatic remote display setup is supported on the following topologies that are used to support current curriculum offerings:

- Multi-purpose Academy Pod (MAP)
- Multi-purpose Academy Pod with ASA (MAP-ASA)
- IT Essentials Pod
- Cuatro Router Pod (CRP)
- Cuatro Switch Pod (CSP)
- Basic Router Pod Version 2 (BRPv2)
- Basic Switch Pod Version 2 (BSPv2)

When a pod is scheduled and lab reservation begins, the following automation takes place:

- NETLAB+ will automatically calculate the control switch VLANs that are required for the pod.
- NETLAB+ will automatically create VLAN based port groups on the virtual machine host's inside virtual switch.
- NETLAB+ will bind the virtual network adapters of each VM to the correct port group.
- NETLAB+ will configure remote display parameters automatically.

When the lab reservation is over, NETLAB+ will tear down the port groups created for the pod to free resources on the host.

For automatic networking on real equipment pods, you must setup the inside virtual switch on each ESXi host (refer to section, "Inside Network Configuration", [Remote PC Guide Series - Volume 2, Installation](#)).

You must also provide the name of the virtual switch in the NETLAB+ virtual machine host setup (Section 2). Automatic networking will not occur if these tasks are not performed.

## 8.2 Setting the Local System ID When Using Multiple NETLAB+ Systems

If you have more than one NETLAB+ system, particularly if they access a common VMware vCenter and/or ESXi host systems, it is necessary to set the System Local ID of your NETLAB+ systems so that each NETLAB+ system is uniquely identified. This is necessary in order to support pod automation as described in the previous section. If you only have one NETLAB+ system, using default value '001' is sufficient.

System Wide Virtualization Settings are accessed from the Virtual Machine Infrastructure administrator option.

