



Not for
reproduction

YARD KING®

Blower Assembly and Owner's Manual



WARNING! Read this manual before operating your Trimmer



IMPORTANT INFORMATION

Congratulations on your purchase of a high quality Blower Vac.

This instruction manual will aid in the assembly, operation and maintenance of your new Blower Vac. Please read carefully to ensure safety and the long life of your product.



WARNING Read all safety warnings and all instructions before use! Failure to follow the warnings and instructions may result in fire and/or serious injury. Save all warnings and instructions for future reference. Do not operate the unit before reading this manual!

Keep this instruction manual in a safe place for future reference or if service is required on your unit.

Intended use

This Blower Vac is intended for the blowing and vacuuming of leaves, grass clippings and other similar garden debris in domestic use. Do not use for vacuuming stones, bark, fine abrasive and clogging aggregate such as saw dust or sand. All uses other than intended must not be performed such as not using to inflate or deflate objects or not using as an air/gas extraction unit.

IF YOU LOAN SOMEONE THIS UNIT, LOAN THEM THESE INSTRUCTIONS ALSO.

General safety regulations



Warning!



Be careful of objects being thrown out!



Read the directions for use before operating the machine.



Read the manual before carrying out any maintenance work.



Wear safety goggles, a helmet and ear protection.



Wear sturdy, enclosed safety boots.



Wear safety gloves.



Protect the machine from rain and damp. Do not use in rain.



Warning! Rotating parts! Be sure impeller cover is fitted secure.



Bystanders must be at least 15 metres away from operating unit.



Table of Contents

	Safety & Handling		
		Safety Instructions	3
		Hazards	6
		Personal Safety Equipment	6
	Quick Start		
		Quick Start Guide	7
	Features & Definitions		
		Feature Definitions	8
	Assembly Procedures		
		Unit Configuration	10
		Blower Assembly	10
		Vac Assembly	11
		Vac Bag Adjustment	12
		Vac Bag Removal	13
	Operating Instructions		
		Oil Fill Procedures	14
		Fuelling Procedures	14
		Before Starting Machine	15
		Starting Instructions	16
		Stopping Instructions	17
		Blowing Tips	18
		Vac & Mulch Tips	19
	Maintenance & Care		
		Oil	20
		Air Filter	21
		Spark Plug	22
		Maintenance	22
		Cleaning & Storage	23
		Maintenance Chart	24
	Troubleshooting		
		Troubleshooting	25



SAFETY & HANDLING

Safety Instructions

Transporting the blower vac

- Proper handling of the blower vac will reduce the risk of personal injury. When transporting the blower vac make sure to always switch off the blower vac, empty vac bag, remove any fuel and the blower tubes.

Before using the blower vac

- **The operation of any power tool can result in foreign objects being thrown into your eyes, which can result in severe eye damage. Before using the blower vac, always wear goggles or safety glasses with side shield and a full-face shield when needed. Always wear nonslip safety shoes, ear muffs and a dust mask when operating.**
- Do not start the blower until you have studied the instruction manual.
- Know the blower controls and learn how to stop operating the unit quickly in an emergency by pressing the **STOP** switch.
- Before using the blower vac, ensure it is not worn or damaged.
- Ensure all screws and fasteners are tightened before use.
- Discontinue use and switch off blower if operation is irregular. Have the blower vac inspected by an authorised service technician before restarting.



Empty bag of all debris following each use. Fabric will wear and deteriorate under normal usage. Before each use, check bag for wear and replace if worn or torn.



Do not store the machine with debris in the bag. Do not operate the machine without the bag correctly fitted.



Do not modify the bag structure or use non-genuine or alternative product bags.



Do not use the bag for any other purpose other than collecting material from the machine.



Do not vacuum liquids, hot ashes or burning materials. Do not use in wet conditions.



Regular cleaning & dusting of the bag will improve vacuum performance.



Empty bag regularly to avoid fatigue of carrying waste material. If the bag is damaged please replace immediately.



Do not vacuum high wear materials like glass, stones, rocks, sand or sharp objects.



Safety Instructions

Operating the blower vac

- When using the blower vac, hold the handle firmly at all times. Discontinue use if discomfort occurs from vibration. Avoid long exposure without rest periods.
- Keep all body parts away from the nozzle end and vac intake. Make sure the unit is OFF and spark plug is disconnected when clearing jammed material.
- Keep your work area clean and well lit. Operate only in daylight or good artificial light.
- Do not operate power tools in explosive atmospheres, such as in the presence of flammable liquids, gases or dust. Power tools can create sparks which may ignite the dust or fumes.
- Keep children, bystanders and pets away when operating the power tool. Ensure there is a minimum distance of 15 metres. Switch the unit off immediately if approached.
- Dress properly. Do not wear loose clothing or jewellery. Keep your hair, clothing and gloves away from moving parts. Loose clothes, jewellery or long hair can be caught in blower impeller & cause damage or injury.
- Walk with the unit. Never run.
- To maintain full control of the blower vac, keep a proper footing at all times with your weight evenly balanced over both feet and never over reach. Be careful when operating the unit on slippery ground or overgrown terrain. Be attentive for concealed hazards, such as ditches, tree stumps and roots.
- Do not operate on elevated structures such as ladders or roofs.
- Always keep the handle dry and free from oil and grease.
- Always stop the unit and disconnect spark plug if the following conditions apply:
 - if a foreign object enters the blower tube or impeller and the blower begins to vibrate abnormally, STOP the operation and inspect for any damage or blockages.
 - before clearing any blockage.
 - before checking, cleaning or working on the unit.
 - whenever leaving the unit unattended.
 - if the unit becomes jammed.
 - if the unit becomes excessively hot.
- Do not use the blower vac if the switch does not turn it ON and OFF.
- Store blower vac out of the reach of children
- Do not allow persons unfamiliar with these instructions to operate the blower.
- Always use blower with full blower nozzle extension so air stream can be close to the ground. Do not blow or vacuum above shoulder height. Do not operate blower without nozzle attachment securely assembled. See assembly instructions on pages 10-12.
- Keep body away from hot muffler parts.
- Do not stand or step on any part of the unit.
- Do not insert object into impeller cover or use the blower to propel or fire projectiles.
- Hearing protection should be used whenever the noise level seems uncomfortable.
- Never operate the vac without the bag properly fitted. If the bag is not properly fitted, the machine project particles out of the discharge chute. These particles may cause injury.
- Do not cover blower tube end. Do not block modify or insert objects into blower end tube. When handling blower for assembly or maintenance tasks, always wear protective gloves.



Failure to maintain the blower vac is a safety hazard & may cause injury. See pg 18-22.



SAFETY & HANDLING

Safety Instructions



Check the position & operation of controls to ensure you are comfortable before you start using the machine.



Check all components are assembled as per assembly instructions on page 10-14.

Before every use, check the machine for the following:

- Read the instructions carefully. Ensure you are familiar with all controls and learn how to operate the machine properly.
- That there are no leaks in the fuel system
- That engine oil is sufficient
- That all screws are securely fastened
- In Blower mode: Blower nozzles and impeller cover are secured in the correct position
- In Vac mode: Vac intake tube, exhaust tube and bag are fitted
- This blower vac is not suitable for use by children.
- Stay alert and watch what you are doing when operating a power tool. Do not operate the blower vac under the influence of alcohol, drugs or medication or when you are tired or sick.
- Do not operate the unit near open windows.
- Operate the unit at reasonable hours only - not early in the morning or late at night when people might be disturbed. Check with your local council for operation times.
- Do not operate the unit indoors or in confined spaces. Breathing exhaust fumes can kill.
- Use only manufacturer's genuine recommended replacement parts and accessories.
- The actual vibration values during use of the tool can vary and are dependant on the use of the tool. The need to identify safety measures to protect the operator are based on an estimation of exposure in the actual conditions of use (taking account all parts of the operating cycle such as the times when the tool is switched off and when it is running idle in addition to the trigger time).
- Never aim or direct blow or vacuum towards people, animals or property that may get damaged.



Hazards

NOTE : The following safety precautions must be strictly observed to avoid the risk of damage or personal injury.

- Check all fasteners regularly. Always ensure that the unit is in a safe operating condition.
- Never try to clear debris from the blower vac while the unit is in operation.
- Always disconnect the spark plug when cleaning or performing maintenance work on the unit.
- Ensure impeller has come to a complete stop before beginning any maintenance on the product.

Personal Safety Equipment

Recommended safety equipment to wear when working with your blower vac.



Ear muffs



Eye protection



Safety boots



Safety gloves



Dust mask

Not for
Reproduction



QUICKSTART

Quick Start Guide

1 – Get ready...

- Place the Blower on a hard, level surface.
- Press the PRIMER 10 times.

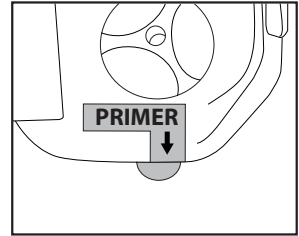

2 – Set

- Set STOP switch to the "ON" position (I)
- Set the choke lever to "COLD" position

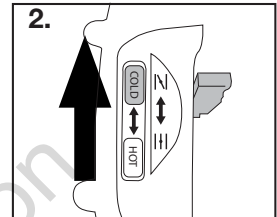
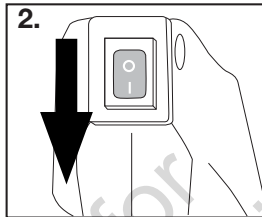

3 – Go!

- Pull the starter cord until you feel it resist. Then tug sharply on the starter cord 2 or 3 times.
- ★ The engine may start or run for a short period set on cold. Choke can be set to hot while the engine is running.
- Now, set the choke lever to the "HOT" position.
- If required, tug sharply on the starter cord 2 or 3 times or until the engine starts
- ★ ★ In cold conditions, the engine may require 5-10 seconds running at idle. Pulling the trigger during warm-up may help starting.

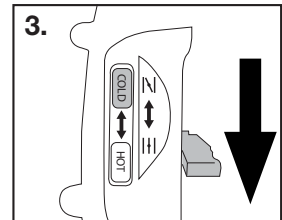

CAUTION! ENSURE FEET, LEGS & HANDS ARE CLEAR OF THE IMPELLER COVER AND BLOWER TUBE/NOZZLE



Machine Layout & Supplied Items

1. Throttle Control
2. Upper Handle
3. Air Filter
4. Choke
5. Primer Bulb
6. Fuel Tank
7. Fuel Cap
8. Starter Cord
9. Lower Handle
10. Spark Plug
11. Blower Nozzle
12. Blower Air Tube
13. STOP Switch
14. Impeller Cover
15. Harness
16. Vac Exhaust Tube
17. Catcher Bag
18. Impeller Cover Knob
19. Upper Vac Intake Tube
20. Lower Vac Intake Tube

Not for
Reproduction

WARNING

- If any part is missing or damaged do not operate the product until the part has been repaired or replaced.



FEATURES & DEFINITIONS

Unit Details

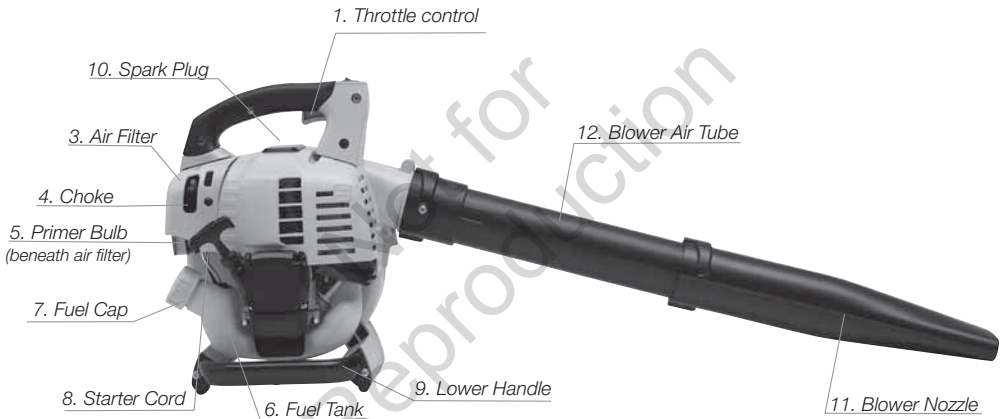
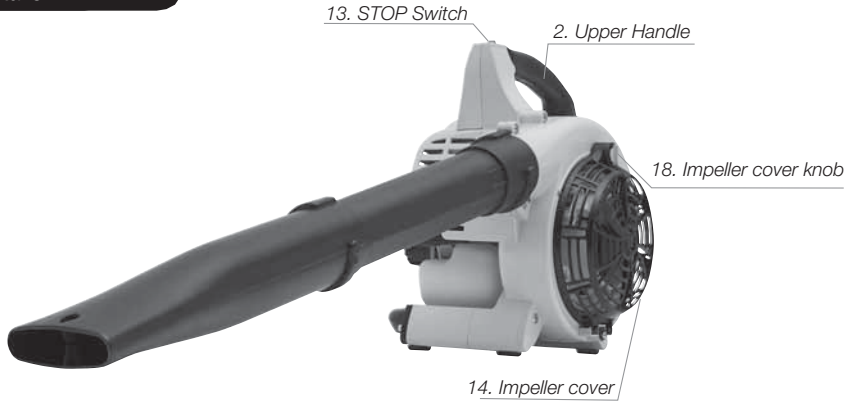

**Shown in blower configuration*

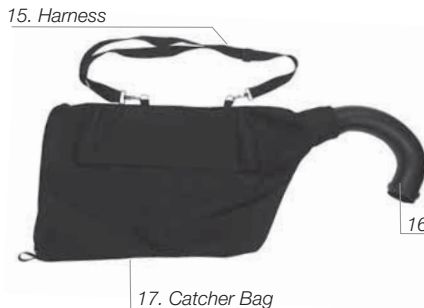



Unit Configuration

Assembly

The unit requires assembly before use. This unit works as both a vacuum and a blower. Both configurations require different assemblies. The following steps explain how to configure the unit as a blower and the steps on page 11 explain how to configure the unit as a vacuum.

Blower Assembly

The following instructions are to assemble for blow mode use.

Ensure that the engine is in the OFF position before assembly.

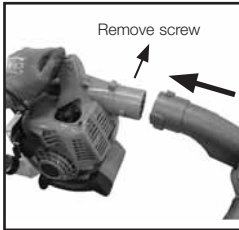

1. Remove screw from blower housing and align the bayonet fitting as shown.



2. Slide the blower air tube into place.

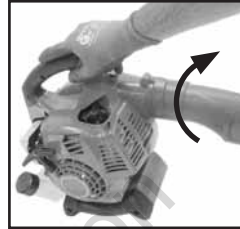

3. Turn clockwise to secure blower air tube.



4. Note: Bayonet fitting key to be assembled so that the blower air tube will align with the centre of the machine.



5. Fasten screw to lock blower air tube to the blower housing.

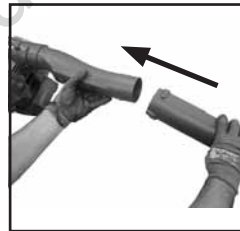

6. Align the bayonet fitting of the blower nozzle with the blower air tube outlet.

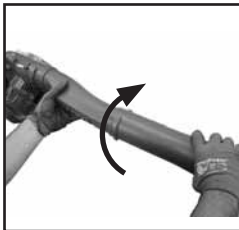

7. Slide the blower nozzle into place and turn clockwise. The blower nozzle does not require a screw fastener.



8. The correct assembly should align the blower nozzle with the upper nozzle of the unit.



ASSEMBLYPROCEDURES

Vac Assembly

Remove blower tube as needed before assembling into vac configuration. The following instructions are to assemble for vacuum mode use.

Ensure that the engine is in the OFF position before assembly.

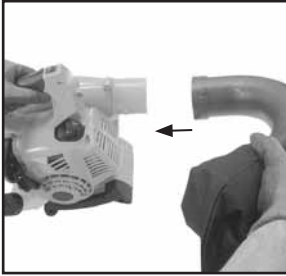

1. Turn stop switch off and ensure engine is stopped - slide the vac exhaust tube into place.

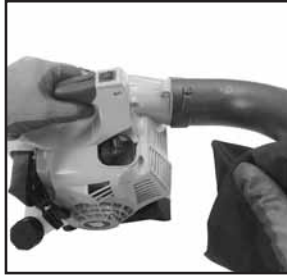

2. Ensure the vac exhaust tube is lined correctly into place.



3. Turn anti-clockwise to secure vac exhaust tube. Never use the vac without the bag attached.



4. Fasten screw to lock vac exhaust tube into place.

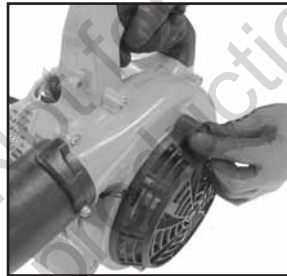

5. Turn impeller cover knob anticlockwise to unlock impeller cover.

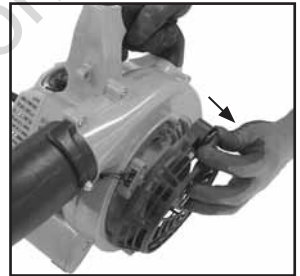

6. Pull the impeller cover back.

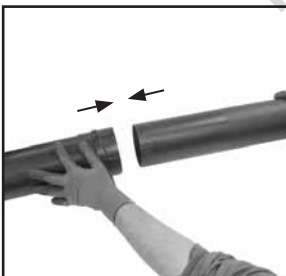

7. Align the bayonet fitting of the lower vac intake tube with the upper vac intake tube outlet and slide into place.

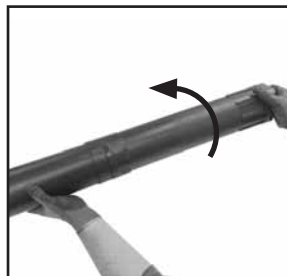

8. Turn clockwise. The vac nozzle does not require a screw fastener.

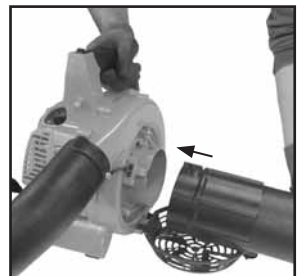

9. Slide the upper vac intake tube into place.

Vac assembly continued on next page.



**The engine will not start with fan cover open.
Do not pull the engine cord with fan cover open.**



Vac Assembly Cont'd



10. The correct assembly should align the vac tube with the upper handle of the unit.



11. Turn clockwise to secure vac tube. Ensure all screws are securely fastened before turning the unit on.

Adjusting Vac Bag Shoulder Harness

While standing in the operating position adjust the length to fit the operator's size. Pull the tab (1) to lengthen, pull the strap (2) to shorten.

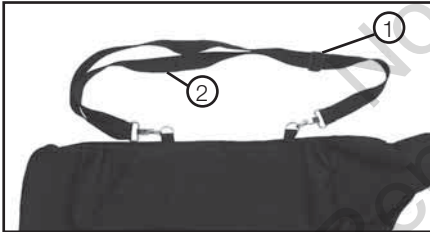

**Strap supports bag only.
Does not support machine.**

Emptying Bag

- When the bag is full, switch off the unit.
- Once all mechanical parts have stopped moving, detach exhaust tube and bag from vac.
- Unzip bag over bin.
- Shake bag over bin to empty contents.
- If material becomes stuck in the bag, turn the bag inside out.
- Always wear eye protection when cleaning the bag.



Do not run without bag fitted and zipper fully closed.



Do not run without both upper and lower intake tubes assembled.



ASSEMBLYPROCEDURES

Vac Bag Removal

Remove vac bag when full.



1. Screw anticlockwise to unlock exhaust tube/bag.



2. Turn clockwise to release exhaust tube/bag.

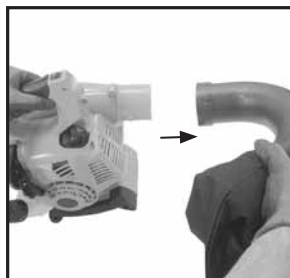

3. Slide the exhaust tube/bag off.

See steps 1 to 4 in the vac assembly section (page 11) for instructions to reassemble vac bag.

Not for
Reproduction



Oil

Recommended oil



Product is supplied without oil. To avoid damage and engine failure, fill with correct oil grade and amount before use as specified below.

Before using the product for the first time, add 70 mL of high quality SAE 10W30 oil of API classification, SF or higher.

Do not fill beyond upper indicator on oil gauge;
To add oil;

1. Place Blower on flat, even ground
2. Locate the oil dipstick and remove (Fig. 1)
3. Fill oil bottle (provided) with 70mL of oil
4. Use the bottle to fill engine (Fig. 2)
5. Replace dipstick

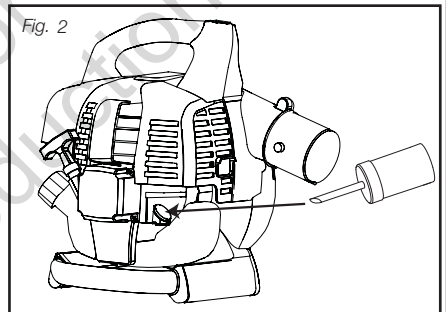
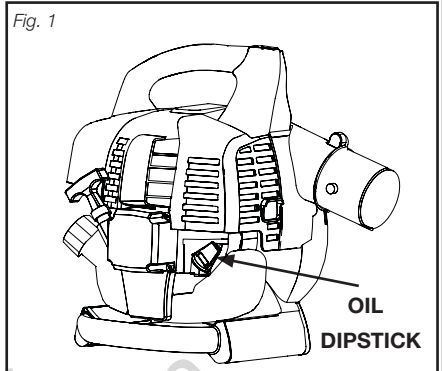
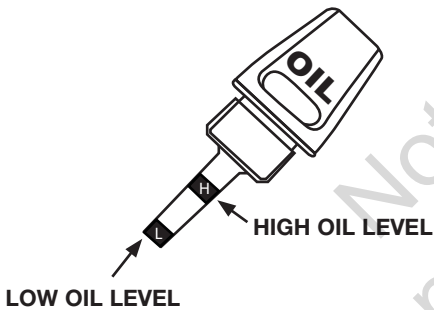

Fuel

Recommended fuels

- Use clean unleaded fuel only. Do not add oil to fuel.
- Start the machine at least 3 metre away from the refuelling site to avoid the possible risk of fire.
- Do not smoke whilst refuelling or working with the machine.
- Do not use the trimmer near inflammable liquids or gases. This could result in an explosion and/or fire.



Only use containers designed and approved for the purpose to transport and store fuel.

- Add 500ml of fuel into fuel tank and secure cap.

NOTE: Blower may need to be reprimed if it has run out of fuel.



OPERATING INSTRUCTIONS

Before Starting Machine



Check the position & operation of controls to ensure you are comfortable before you start using the machine.



Check all components are assembled as per assembly instructions on page 10-12 before starting the machine.

Check the machine for the following each time before use:

- That there are no leaks in the fuel system.
- That all screws are securely fastened.
- Blower air tube, blower nozzle, impeller cover, vac intake tubes and vac bag are secured in the correct position.
- That engine oil is sufficient

NOTE: Do not use the blower unless fully assembled as per assembly instructions.

Not for
Reproduction



Starting Instructions-Cold Engine Start

Starting the engine

Note: The starting procedure for the engine will vary slightly depending on your engine temperature and the ambient temperature.

The following is the recommended starting procedure if the engine is **cold**.

A cold engine can be: - an engine that has not been started for a period of time
- an engine in cold ambient temperatures

Cold Start

- (1) Set the machine down on a hard, level surface.
- (2) Press the fuel pump primer 10 times
(This is found underneath the air filter housing)
- (3) Ensure the "STOP SWITCH" is set to the "ON" position (I).
- (4) Set the choke lever to the "COLD" position.
- (5) Pull out the starter cord until you feel it start to resist.

Then tug sharply on the starter cord 2 or 3 times

- ★ The engine may start or run for a short period set on cold.
Choke can be set to hot while the engine is running.
 - Now, set the choke lever to the "HOT" position.
 - If required, tug sharply on the starter cord 2 or 3 times or until the engine starts.
- ★ ★ In cold conditions, the engine may require 5-10 seconds running at idle. Pulling the trigger during warm-up may help starting.
 - If the engine fails to start, repeat the process from step (3)

Never allow the starter cord to snap back. This may damage the machine.

Note: Adjustment of the choke lever between "HOT" and "COLD" position may be required during engine warm-up. Engine warm-up may take several minutes until the engine is running hot and engine speed is stable.

If the engine slows down or stops, adjusting the choke lever towards the "COLD" position may be required during warm-up. Return the choke lever to the "HOT" position, before proceeding with operating the machine.

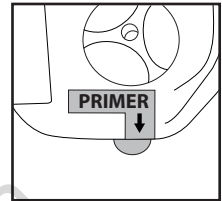

2.

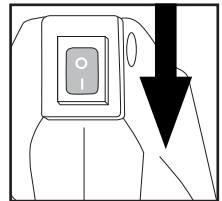

3.

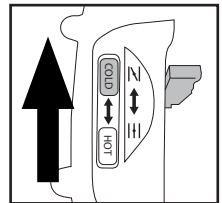

4.

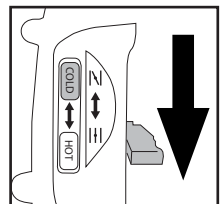

5.



OPERATING INSTRUCTIONS

Starting Instructions-Hot Engine Start

Starting the engine

Note: The starting procedure for every engine will vary slightly depending on your engine temperature and the ambient temperature.

The following is the recommended starting procedure if the engine is **hot**.

A hot engine can be:

- an engine that has just stopped running
- an engine in hot ambient temperatures

Hot Start

- (1) Set the machine down on a hard, level surface.
- (2) Ensure the 'STOP SWITCH' is set to the 'ON' position (I).
- (3) Set the choke lever to the "HOT" position.
- (4) Pull out the starter cord until you feel it start to resist.

Then tug sharply on the starter cord 2 or 3 times or until the engine tries to start.

- If the engine fails to start, Go to "COLD" start Procedure.

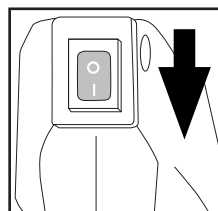

2.

**Never allow the starter cord to snap back
This may damage the machine!**



If the engine does not start up after several attempts, read the section on trouble shooting.



**Always pull the starter out in a straight line.
IF THIS IS NOT FOLLOWED, STARTER CORD
WILL BE FRAYED AND CORD WILL BREAK!
This is not covered by the product Warranty.**

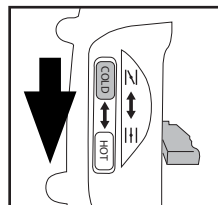

3.

Stopping - Switching Off The Engine

Emergency Stop Procedure

- If it becomes necessary to stop the machine immediately, let go of the throttle lever and move and hold the stop switch to the OFF position (o).

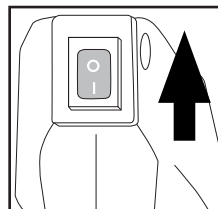

**Do not allow the blower vac to run continuously on idle.
Turn OFF the blower when not in use.**



Blowing Tips

Blower

When using your blower always hold the unit with a minimum distance of 15 cm between you and the blower at all times.

The blower tube should always face forward, always keep the blower tube in front and pointed away from yourself when in use.

Work in one direction. Using the blower in one direction will stop you from back tracking or blowing leaves into areas you have already cleared.



Blower sweeping technique

The sweeping method is achieved when the blower is swayed back and forth from left to right while the unit is held slightly in front.



- Use a rake or broom to loosen debris before blowing.
- It is recommended to slightly dampen surfaces or use a mister attachment in dusty conditions.



OPERATING INSTRUCTIONS

Vac & Mulch Tips

Vac

Hold the vac firmly, tilting the vac tubes and use a sweeping action to collect light debris. The debris will flow into the bag. Items such as small leaves and twigs will be mulched as they pass through the fan housing. Emptying the bag often will prolong bag life and increase performance.

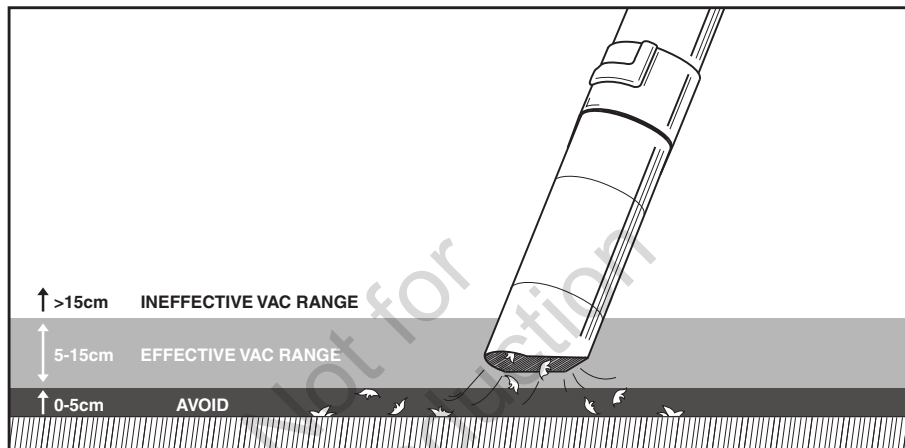

Depending on operator height, the harness strap may need adjustment in order to support use in the effective vac range. See page 12 for vac bag adjustment.

Vac sweeping technique

The sweeping method is achieved when the vac is swayed back and forth from left to right while the unit is held slightly in front.





Maintenance - Oil

Maintenance of oil

- Check oil level before every use
- Replace oil after the first 4 hours of operation
- Refill oil when level reaches lower indicator on oil guage
- Do not fill beyond upper indicator on oil guage
- Replace oil after every 20 hours of operation
- Replace oil if it is dirty or contaminated

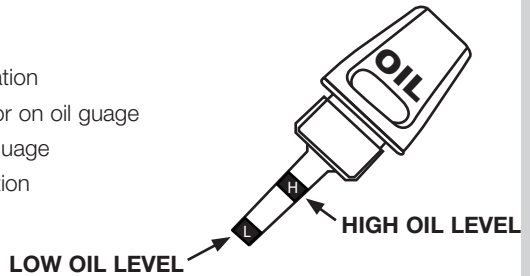

Blower Vac Maintenance

Maintaining the blower vac

- Periodically check the unit for correct assembly, breakage of parts and any other condition that may affect its operation. If damaged, have the unit repaired before use.
- Store the unit in a well ventilated area, away from any naked flames such as those found in gas hot water heaters.
- recommends that all maintenance, repair and inspection work be carried out by a Authorised Service Centre.
- Check blower tubes, impeller cover and vac intake tubes are correctly attached before and after each use.

Not for
Reproduction



MAINTENANCE & CARE

Maintenance of the Air Filter

Always switch off the machine and disconnect spark plug H.T. lead before carrying out any maintenance work.

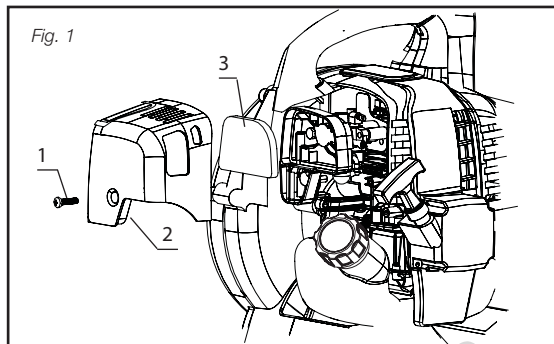

NOTE: Dirty air filters reduce the engine output by supplying too little air to the carburettor.

Regular checks are therefore essential. The air filter should be checked monthly and cleaned if necessary. If the air contains a lot of dust, the air filter should be checked more frequently.

1. Remove the retaining screw (1) from air filter cover (2).
2. Remove the filter cover.
2. Remove the filter element (3).
4. Clean the filter element by washing in soapy water and allowing it to dry completely.
5. Soak in oil and squeeze off excess.
6. Assemble in reverse order.



Never clean the air filter with petrol or inflammable solvents.



Make sure Air Filter is fitted correctly, (warranty will be void if engine is damaged due to incorrect fitment)



Do not run engine without a clean filter and cover fitted.



Maintenance of the Spark Plug

Torch CMR6A

Spark plug gap = 0.7 mm

Tighten the spark plug with a torque of 15 - 22 Nm.

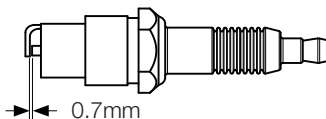

1.



2.

Check the spark plug for carbon deposits after 10 hours of operation and if necessary clean. Thereafter service the spark plug after every 25 hours of operation.

1. Pull off the spark plug boot by twisting side to side gently.
2. Remove the spark plug with the supplied spark plug tube spanner.
3. Assemble in reverse order.

Maintenance & Storage

Keep all nuts, bolts and screws tight to be sure the appliance is in safe working condition.

Check the blower frequently for wear or deterioration.

Replace worn or damaged parts.

Use only genuine replacement parts and accessories.

Store the appliance only in a dry place.

Do not store unit upside down or on its side. Always store upright.

MAINTENANCE SAFETY

- Stop the engine and disconnect the spark plug H.T. lead before clearing blockages, checking or working on the unit.
- Stop the engine, disconnect the spark plug H.T. lead and inspect the unit if it begins to vibrate abnormally.
- Use only genuine replacement parts.

CLEARING AN INLET BLOCKAGE

Foreign material may cause a blockage in the inlet chute of your blower vac. Ensure the impeller cover is not blocked or covered.

If necessary open impeller cover and clear blockage as required.

When clearing blockages;

- switch your Blower off using the STOP switch.
- disconnect the spark plug H.T. lead.
- wear safety gloves.



MAINTENANCE & CARE

Cleaning & Storage

- Carry out all the maintenance work.
- Drain the fuel out of the tank.
- When the fuel has been drained, start the engine and allow the engine to run at idling speed until it stops. This will clean the remainder of the fuel out of the carburettor.
- Allow machine to cool before storing.
- Clean the exterior of the blower thoroughly using a soft brush and cloth.
Note: Do not use water, solvents or polishes.
- Store the blower in a dry secure place out of reach of children.
- Fertilizers and other chemical garden products often contain substances that accelerate the rate of corrosion of metals. Do not store the machine on or near fertilizers or other chemicals.
- Do not place any other objects on top of the blower.
- Use only genuine replacement parts made and guaranteed.
Insist on them from your parts and service dealer.

For your safety, use only genuine replacement parts made and guaranteed. Insist on them from your parts and service dealer.

NOTE: Have your blower vac serviced at a approved service centre using only identical replacement parts. This will ensure that the safety of the blower vac is maintained.

Clearing a Blocked Impeller/Tube



To avoid serious personal injury, be sure the unit is off and the spark plug is removed before clearing the impeller/tube .



To avoid serious personal injury, always wear gloves to protect yourself from the impeller & mulching blades or other sharp objects.

- Turn the unit off and wait until it comes to a complete stop.
- Remove the spark plug.
- Open the impeller cover or remove the blower vac tube and bag.
- Carefully remove material blocking the tube or fan.
- Clear the blockage. A garden hose can be used to push out any material that is blocking the tube. Water pressure may help with this.
- Inspect the impeller and mulching blades to ensure no damage has occurred. Rotate the impeller blades by slowly pulling the starter cord to ensure the blockage is completely cleared. Keep hands away from the impeller when rotating it.
- Reinstall the blower tube or vac tubes and the bag.
- Insert the spark plug into the unit.



Maintenance Chart

Refer to the following table for routine maintenance.

Features	Requirements	Before use	After finish	Refuelling	Monthly	Yearly	If damaged	As required
Whole unit	Visual inspection (leaks)	●		●				
Throttle lever	Check operation	●						
Throttle trigger interlock	Check	●						
Stop switch	Check	●						
Fuel tank	Clean		●					
Blower housing/impeller cover	Check & clean		●					●
Vac bag	Clean		●					●
	Replace							●
Engine Oil	Check and fill	●						
	Replace							●
Air filter	Check				●			
	Clean				●			●
	Replace (Depending on conditions)						●	●
Cowling	Clean		●					
Cylinder fins	Clean							●
Spark plug	Clean & re-adjust gap					●		●
All accessible fasteners	Retighten	●						●
Muffler	Inspect	●			●			
	Inspect spark arresting screen					●		●
	Clean or replace						●	●



Always stop the engine before any maintenance is done on the unit. When all parts have stopped rotating, disconnect the spark plug lead to begin maintenance work.



Never attempt maintenance that is not outlined in this manual. All repair work must be carried out by a Authorised Service Centre.



Before performing any maintenance ensure product is switched off & has come to a complete stop.



TROUBLESHOOTING

Troubleshooting

The following chart lists problem symptoms causes and corrective actions if your blower does not operate properly.

Problem	Possible cause	Remedy
Engine will not start	Electrode is wet or fouled	Dry spark plug or replace
	Carbon deposit on electrode	Clean spark plug or replace
Spark plug (no spark)	Cracked insulator	Replace spark plug
	STOP SWITCH in OFF position	Switch to ON
	Too small or large electrode gap	Adjust gap to 0.7mm
	Burned electrode	Replace spark plug
Ignition system (no spark)	Coil burned out, coil insulation failure	Contact Service Centre or replace
	Break in coil wire, transistor burned out	Contact Service Centre or replace
Engine won't start - Good compression, sufficient fuel (with spark)	Engine flooded	Discharge excess fuel by setting choke lever to hot and pull cord whilst depressing throttle trigger
	Excessively thick fuel	Contact Service Centre or replace fuel
	Use of incorrect fuel	Drain and replace with correct fuel
Poor compression, sufficient fuel (with spark)	Excessive wear on cylinder, piston, rings	Contact Service Centre
	Loose spark plug	Tighten spark plug
No fuel in carburettor (with spark)	No fuel in tank	Refuel
	Loose fuel line fitting	Contact Service Centre
	Clogged fuel line	Contact Service Centre
	Plugged air vent in fuel tank	Clean vent or replace
	Run out of fuel after use	Refuel and reprime as necessary
	Fuel filter blocked	Replace fuel filter
Incorrect assembly	The blower/vac tubes, or vac bag are not correctly installed	Check all tubes and/or bags for correct assembly
	The fan cover is not closed	Check the fan cover is fully shut
Insufficient power	Clogged air filter	Clean or replace
	Valve lash out of spec	Contact Service Centre
Blockages	Carbon build up in muffler	Contact Service Centre
	Fuel line/passage clogged	Contact Service Centre
	Piston seizure, diaphragm inoperative	Contact Service Centre
	Water in fuel	Change fuel
Overheating	Excessively lean fuel mixture	Contact Service Centre
	Carbon deposits on piston	Contact Service Centre
	Machine is overworked	Operate properly – do not overload
	Fan cover, cylinder fins, etc. dirty	Clean and remove dirt and debris

Troubleshooting

Problem	Possible cause	Remedy
Engine makes knocking noise	Cylinder overheating Use of incorrect fuel	Clean fins Replace with correct fuel
Poor acceleration	Fuel filter clogged Valve lash out of spec	Contact Service Centre or replace Contact Service Centre
Fuel system clogged	Excessively low idle Excessively lean carburettor setting Clogged air filter	Speed up idle/Contact Service Centre Contact Service Centre Clean filter
Air leakage	Loose carburettor Loose fuel pick up tube	Contact Service Centre Insert firmly/Contact Service Centre
Engine stops during operation	Stop switch is set to off position	Ensure stop switch is set to on
Engine stops abruptly	Shorting of spark plug Piston scored, ignition failure	Clean spark plug or replace Contact Service Centre
Miscellaneous	Fuel tank empty Carburettor or fuel tank clogged Impeller clogged	Refuel Contact Service Centre Remove blockage
Engine is difficult to shut off	Overheated engine	Run at idle before switching off
Overheating or electrical fault	Overheated spark plug Defective stop switch Poor contact of ground wire	Clean & adjust gap 0.7mm Contact Service Centre or replace Contact Service Centre
Unit main body	Loose impeller	Contact Service Centre
Irregular vibration	Bent main shaft Worn shaft bearings Damaged impeller Loose engine mounts	Contact Service Centre Contact Service Centre Contact Service Centre Retighten engine mount screws
Can not assemble blower air tube or vac tube to main body	Screw still in main body Debris on main body and/or blower air/vac tube	Refer to assembly procedures Clean blower main body and blower air/vac tube
Oil Leaking	Oil build up in air filter	Clean air filter
Vacuum bag, fan & tubes	Tube or bag is blocked	Clear the blockage following the procedure in the manual.
Unit will not blow or vacuum	Fan is blocked Vac bag is dirty Vac bag is torn or punctured	Clear the blockage following the procedure in the manual. Clean the Vac bag. Replace the Vac bag.

If running difficulties continue, please contact your closest Authorised Service Centre on: 1800 356 632 or refer to the Lawnmower section of your local yellow pages. New Zealand Customers Phone (09) 912 0747.

Not for
Reproduction

©2017 Briggs & Stratton Australia Pty Ltd

Yard King is a trademark of Briggs & Stratton Australia Pty Ltd

All rights reserved. No part of this booklet may be reproduced by any means without prior written permission. All information herein is subject to change without notice.

LR02617A-A

2112	A	PLC	BK	REVISION	01/06/17
ECR	Rev	Own	Chk	Release	Date