

MHI
Copy 3

FM 23-8

DEPARTMENT OF THE ARMY FIELD MANUAL

*Replaces FM 23-8
May 65*

U. S. RIFLE

7.62-MM

M14

RESCINDED

FOR HISTORICAL USE ONLY



HEADQUARTERS, DEPARTMENT OF THE ARMY
DECEMBER 1959

FIELD MANUAL
U.S. RIFLE, 7.62-MM, M14

FM 23-8
CHANGES No. 1

HEADQUARTERS,
DEPARTMENT OF THE ARMY
WASHINGTON 25, D.C., 20 May 1960

FM 23-8, 7 December 1959, is changed as follows:

1. Purpose and Scope

* * * * *
b. Marksmanship training is covered in FM 23-5, FM 23-15, and FM 23-71.

3. Description of Rifle

a. The M14 rifle * * * installing a selector. **The M14 with bipod attached (fig. 1.1) and the selector installed is designed primarily for automatic fire.**

* * * * *
e. (Added) The final production model of the rifle (fig. 1.1) will be equipped with a slotted handguard and a hinged butt plate.

4. General Data

a. *Weights in Pounds.*

* * * * *
(Added) Bipod, M2----- 1.7

10. Disassembly of the Bolt

* * * * *
b. *Bolt in Rifle.* Rescinded.

11. Assembly of the Bolt

* * * * *
b. *Bolt in Rifle.* Rescinded.
Figures 15 (1) and (2). Rescinded.
Figure 17. Rescinded.



Figure 1.1. (Added) M14 rifle with bipod.

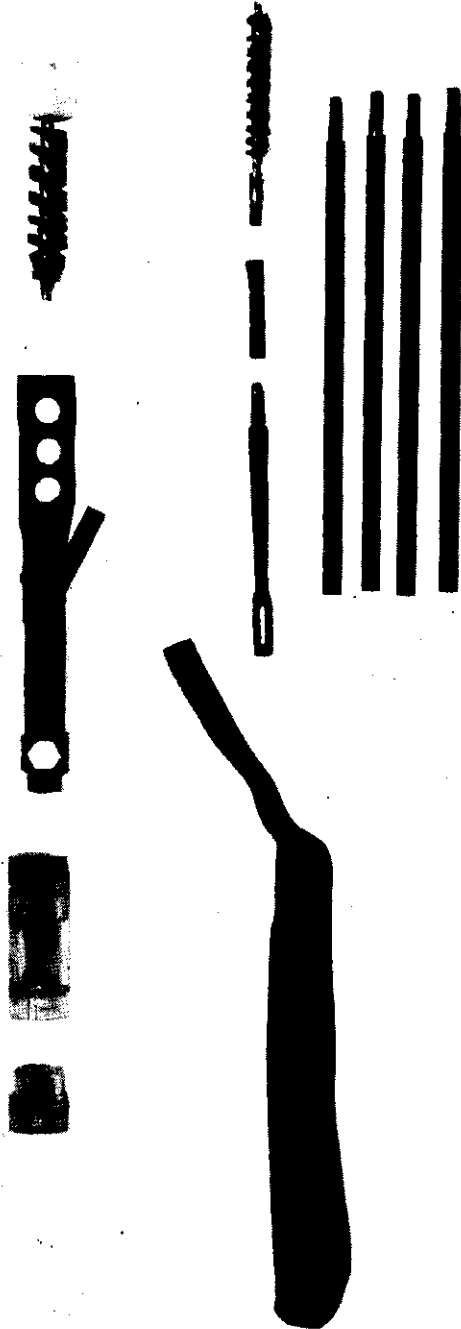

Figure 47. (Superseded) Maintenance equipment.

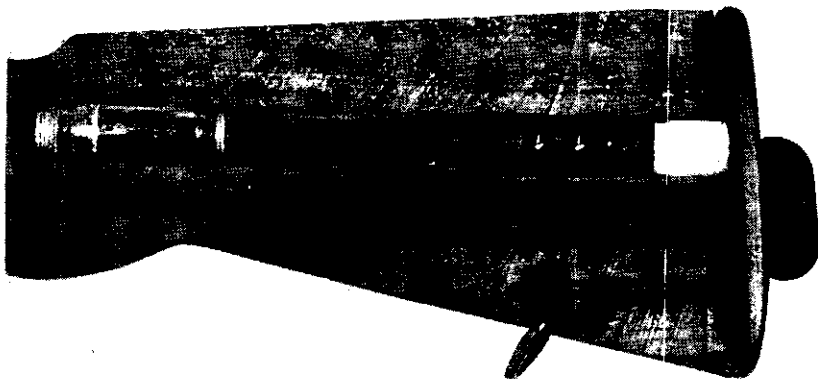

Figure 52. (Superseded) Stowage of accessories in butt stock.

[AG 474.2 (25 Mar 60)]

By Order of *Wilber M. Brucker*, Secretary of the Army :

L. L. LEMNITZER,
General, United States Army,
Chief of Staff.

Official :

R. V. LEE,
Major General, United States Army,
The Adjutant General.

Distribution :

Active Army:

To be distributed in accordance with DA Form 12-7 requirements for FM 23-series (unclassified) plus the following additional formula :

Tech Stf, DA (1)	Armd Bn (3)
US ARADCOM (2)	ADA Bn (3)
US ARADCOM Rgn (2)	MP Bn (3)
MDW (5)	Inf Co (5)
Div (5) except Armor Div (20), (15 each Armd Combat Comd)	Armd Co (3)
Bde (3)	Abn Inf Co (5)
Engr Gp (3)	Btry (3)
Inf BG (5)	Cml Co (3)
Combat Comd (3)	Ord Co (3)
Armd Cav Regt (3)	QM Co (3)
Arty Gp (3)	MP Co (3)
Cml Bn (3)	Cav Trp (3)
Engr Bn (3)	USAIS (1575)
Arty Bn (3)	USAAIS (1200)
Ord Bn (3)	USAES (10)
QM Bn (3)	USA Ord Sch (50)
Sig Bn (3)	USASCS (49)

NG: State AG (3).

USAR: Units same as Active Army except allowance is two copies for each unit. For explanation of abbreviations used, see AR 320-50.

TAGO 5973B

FIELD MANUAL

U.S. RIFLE, 7.62-MM, M14

FM 23-8

CHANGES No. 2

HEADQUARTERS,
DEPARTMENT OF THE ARMY
WASHINGTON 25, D. C., 15 August 1962

FM 23-8, 7 December 1959, is changed as follows:

4. General Data
(Superseded)

a. Physical and Mechanical Characteristics.

Weights:

Complete with full magazine (steel), cleaning equipment and selector	11.34 pounds
Complete with full magazine (steel), cleaning equipment, selector, and bipod	13.09 pounds
Empty magazine (steel)50 pound
Full magazine (steel, with ball ammunition)	1.50 pounds
Cleaning equipment63 pound,
Bipod M2	1.75 pounds

Length:

Overall with flash suppressor	44.31 inches
-------------------------------------	--------------

Sights:

Front	Fixed
Rear	Adjustable. One click of elevation or windage equals one minute of angle.

Trigger pull:

Minimum	5.5 pounds
Maximum	7.5 pounds

Ammunition

See chap. 6.

b. Firing Characteristics.

Muzzle velocity (approximate)	840 meters per second
Cyclic rate of fire	700-750 rounds per minute

Rates of fire: (The following rates of fire can be maintained without danger to the firer or damage to the weapon.)

Semiautomatic:

1 minute	40 rounds
2 minutes	40 rpm (80 rd total)
5 minutes	30 rpm (150 rd total)
10 minutes	20 rpm (200 rd total)

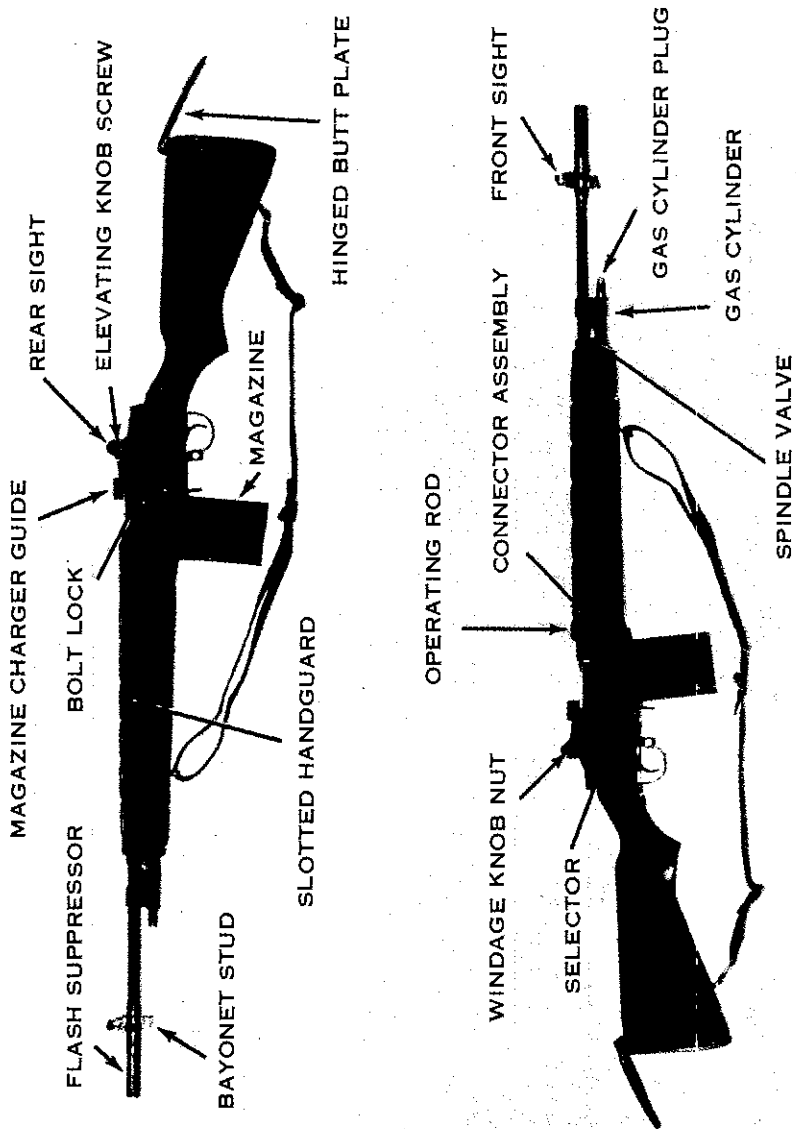

Figure 1. (Superseded) The M14 rifle.

15 minutes -----	20 rpm (300 rd total)
20 minutes -----	20 rpm (400 rd total)
30 or more minutes -----	15 rpm

Automatic:

1 minute -----	60 rounds
2 minute -----	50 rpm (100 rd total)
5 minutes -----	40 rpm (200 rd total)
10 minutes -----	30 rpm (300 rd total)
15 minutes -----	30 rpm (450 rd total)
20 minutes -----	25 rpm (500 rd total)
30 minutes or more -----	20 rpm

Range:

Maximum effective (semiautomatic without bipod)	460 meters
Maximum effective (semiautomatic with bipod)	700 meters*
Maximum effective (automatic with bipod)	460 meters**
Maximum (M59 ball ammunition)	3725 meters

c. Definitions.

Cyclic rate -----	The rate at which the weapon fires automatically.
Maximum effective range -----	The greatest distance at which a rifleman can be expected to fire accurately to inflict casualties or damage.

6. Separation of the Three Main Groups

Place the safety in the SAFE position (inside the trigger guard). Place the butt of the rifle on your left hip or thigh with the sights to the left, and loosen the sling. Grasp the magazine with your right hand so the thumb is against the magazine latch and the fingers are around the front of the magazine. Push the magazine latch with the thumb; then push forward, pulling the magazine out of the magazine well (fig. 2). Next, turn the rifle so the sights are to the right. Place the cutting edge of the right hand against the operating rod handle and push it all the way to the rear. While holding it to the rear, reach across the receiver with the thumb of the right hand and press the bolt lock in. Release the pressure against the operating rod handle. Insure that the bolt and bolt lock are engaged. Inspect the chamber to insure it is clear. Pull back on the operating rod handle, release it, and allow the bolt to move forward.

a. Turn the rifle so the sights are to the left. To remove the * * * firing mechanism assembly.

* * * * *

22. Loading the Magazine

* * * * *

b. To load the magazine using a filler, slide the filler over the top

* The addition of the bipod adds much to the stability of the rifle and enables the automatic rifleman to effectively engage targets semiautomatically in excess of 460 meters.

** Enemy squad formations and hasty crew-served weapons emplacements may be effectively engaged up to this range; bunker apertures, windows, and like targets which require precise accuracy can best be engaged by using semiautomatic fire.

rear portion of the magazine (fig. 34.1). Insert a 5-round * * * the magazine filler.

Page 56.

Chart 2. Stoppages: Their Causes and Remedies

Stoppage	Cause	Remedy
Failure to feed -----	Defective or worn parts. * * *	Replace parts. * * *
* * *	* * *	* * *
Failure to lock -----	Weak operating rod spring. * * *	Replace spring. * * *
Failure to fire -----	* * *	* * *
Failure to unlock -----	* * *	* * *
* * *	Insufficient gas. Spindle valve closed. * * *	Tighten gas cylinder plug. Open valve. * * *

38. Description

(Superseded)

The types of ammunition are easily identified by their individual markings.

a. *Ball.* The M59 ball cartridge has a boattailed bullet (the rear of the bullet is tapered). The bullet consists of a gliding metal jacket, a steel core, and a lead antimony point and base filler. The M80 ball cartridge bullet consists of a gliding metal or gilding metal clad steel jacket with a lead antimony slug. Ball ammunition is unpainted.

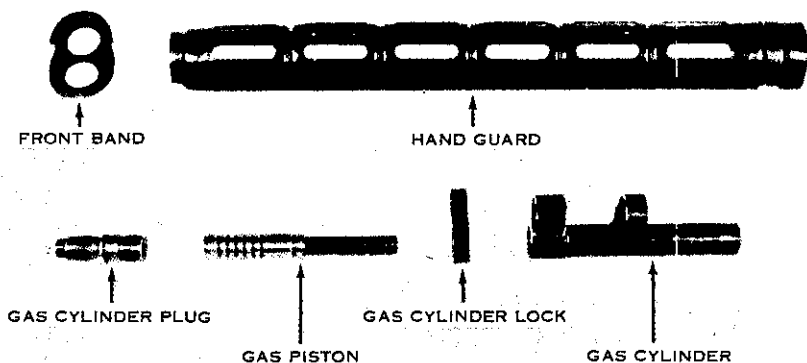

Figure 19. (Superseded) Parts of the gas system, handguard and front band.

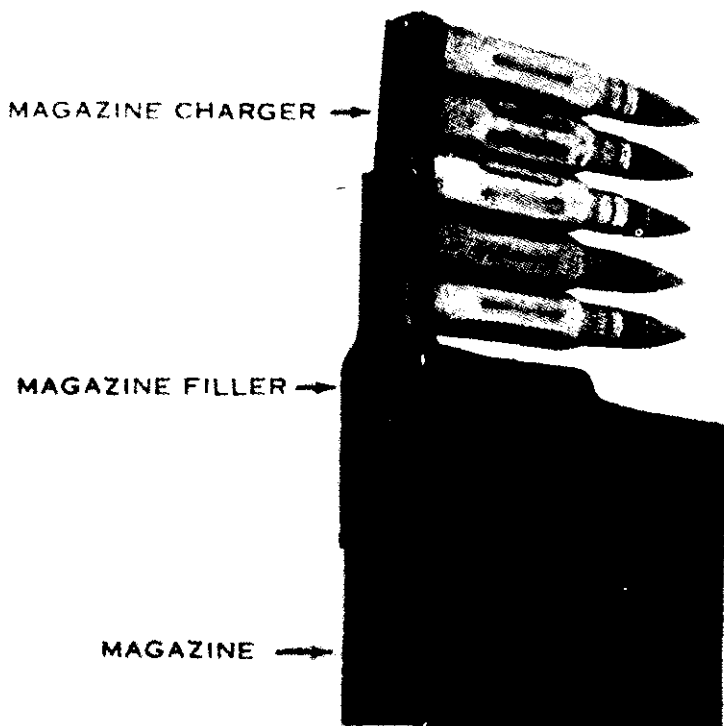

Figure 34.1. (Added) Loading the magazine using a filler.

b. Armor Piercing. The armor piercing cartridge has a boat-tailed bullet which consists of a gilding metal clad jacket, a steel core, and a lead antimony base and point filler. The cartridge can be identified by the black bullet tip.

c. Tracer. The bullet of a tracer cartridge is boattailed and consists of a gilding metal clad steel jacket, a lead antimony point, a tracer, a subigniter and igniter composition, and a closure cap. The tip is painted orange.

d. Blank. This cartridge consists of a primer and propellant in a brass case which is shaped to conform approximately to the configuration of a bulletted combat cartridge. The propellant is held in the cartridge by a wad. The mouth of the cartridge is

sealed with a drop of red lacquer and then crimped to protect against air and moisture.

e. Dummy. The dummy cartridge case has six longitudinal corrugations approximately one-third the length of the case. There are no markings on the bullet.

f. Cartridge, Grenade. The grenade cartridge has a five petal rose crimp on the mouth of the cartridge case and does not contain a bullet. It is designed for use in the M14 rifle for projecting grenades.

39. Ballistic Data

Specific data on 7.62-mm ammunition is contained in FT 7.62-A-2, January 1962. The approximate maximum range and average muzzle velocity of ball ammunition are shown below.

<i>Cartridge</i>	<i>Max range (meters)</i>	<i>Average muzzle velocity (meters per second)</i>
Ball M59	3725	839.7
Ball M80	3549	839.7

APPENDIX REFERENCES

*	*	*	*	*	*	*	*
FM 23-5	US Rifle, Caliber .30, M1.						
FM 23-15	Browning Automatic Rifle, Caliber .30, M1918A2.						
FT 7.62-A-2	Gun, Machine, 7.62-MM, M60 on Mount, Machine Gun, 7.62-MM, M122 and Rifle, 7.62-MM, M14.						

BY ORDER OF THE SECRETARY OF THE ARMY:

G. H. DECKER,
*General, United States Army,
Chief of Staff.*

Official:

J. C. LAMBERT,
*Major General, United States Army,
The Adjutant General.*

Distribution:

Active Army:

DCSPER (2)	ARADCOM Rgn (2)
ACSI (2)	USCONARC (5)
DCSLOG (2)	LOGCOMD (2)
DCSOPS (2)	MDW (5)
ACSRC (2)	Armies (5)
CRD (1)	Corps (3)
COA (1)	Div (2) (CC (1))
CINFO (1)	Bde (1)
TIG (1)	Regt/Gp/bg (1)
TJAG (1)	Bn (5)
TPMG (1)	Co/Btry (5)
Tech Stf, DA (1) except	USATC (5)
CofOrd (5)	Instl (1)
ARADCOM (2)	

NG: None.

USAR: Same as active Army except allowance is one copy to each unit.

For explanation of abbreviations used see AR 320-50.

☆ U. S. GOVERNMENT PRINTING OFFICE: 1962-650514

FIELD MANUAL }
 No. 23-8 }

HEADQUARTERS,
 DEPARTMENT OF THE ARMY
 WASHINGTON 25, D. C., 7 December 1959

U.S. RIFLE
7.62-MM, M14

	Paragraph	Page
CHAPTER 1. INTRODUCTION		
Purpose and scope.....	1	3
Importance of mechanical training.....	2	3
Description of rifle.....	3	3
General data.....	4	5
2. MECHANICAL TRAINING		
Section I. DISASSEMBLY AND ASSEMBLY		
General.....	5	7
Separation of the three main groups.....	6	7
Assembly of the three main groups.....	7	9
Disassembly of the barrel and receiver group.....	8	10
Assembly of the barrel and receiver group.....	9	15
Disassembly of the bolt.....	10	17
Assembly of the bolt.....	11	19
Disassembly of the rear sight.....	12	22
Assembly of the rear sight.....	13	23
Disassembly of the gas system and handguard.....	14	24
Assembly of the gas system and handguard.....	15	26
Disassembly of the firing mechanism assembly.....	16	26
Assembly of the firing mechanism assembly.....	17	28
Disassembly of the magazine.....	18	32
Assembly of the magazine.....	19	32
II. CONVERSION FOR SEMIAUTOMATIC AND AUTOMATIC FIRE.		
Converting to fire selectively.....	20	34
Converting to fire semiautomatically only.....	21	35
CHAPTER 3. OPERATION AND FUNCTIONING		
Section I. OPERATION		
Loading the magazine.....	22	40
Loading the rifle.....	23	40
Top loading with 5-round magazine charger.....	24	41
Unloading and clearing the rifle.....	25	41
Firing the rifle.....	26	41

	Paragraph	Page
Section II. FUNCTIONING		
Semiautomatic.....	27	43
Automatic.....	28	54
CHAPTER 4. STOPPAGES AND IMMEDIATE ACTION		
Stoppage.....	29	56
Immediate action.....	30	56
5. MAINTENANCE		
General.....	31	59
Cleaning materials, lubricants, and equipment.	32	59
Cleaning the rifle.....	33	62
Normal maintenance.....	34	68
Special maintenance.....	35	68
Storage.....	36	70
CHAPTER 6. AMMUNITION		
General.....	37	71
Description.....	38	71
Ballistic data.....	39	71
Packaging.....	40	72
Care, handling, and preservation.....	41	72
Storage.....	42	73
APPENDIX. REFERENCES.....	--	74

CHAPTER 1

INTRODUCTION

1. Purpose and Scope

a. This manual is a guide for commanders and instructors in presenting instruction and training in the mechanical operation of the M14 rifle. It includes a detailed description of the rifle and its general characteristics; procedures for detailed disassembly and assembly; an explanation of functioning; a discussion of the types of stoppages and the immediate action applied to reduce them; a description of the ammunition used; and instructions on the care, cleaning, and handling of both the weapon and ammunition.

b. Marksmanship training is covered in FM 23-5 and 23-71.

2. Importance of Mechanical Training

The rifle is the infantryman's basic weapon. It gives him an individual and powerful capability for combat. To get the most out of his individual combat capability, the infantryman must develop two skills to an equal degree—he must be able to fire his weapon well enough to get hits on battlefield targets and he must know enough about its working parts to keep them operating smoothly so the rifle will never fail him. The infantryman gets his firing skill on known distance and TRAINFIRE ranges and he learns how to keep his rifle working from the mechanical training that is detailed in this manual.

3. Description of Rifle

a. The M14 rifle is a 7.62-mm, magazine fed, gas operated, air-cooled, semiautomatic, shoulder type weapon. The front sight is mounted on the flash suppressor. The M14 (fig. 1) is designed primarily for semiautomatic fire, but it can be converted to fire automatic fire by installing a selector.

b. The wide rib on the bottom of the flash suppressor reduces muzzle climb and lessens the amount of dust raised by muzzle blast. There is a lug on the rear of the flash suppressor to accommodate a bayonet and a grenade launcher. The spindle valve (fig. 1) is used when launching a grenade to prevent gas operation of the rifle, thus avoiding possible damage to moving parts and the discharge of unburned powder near the firer's face.

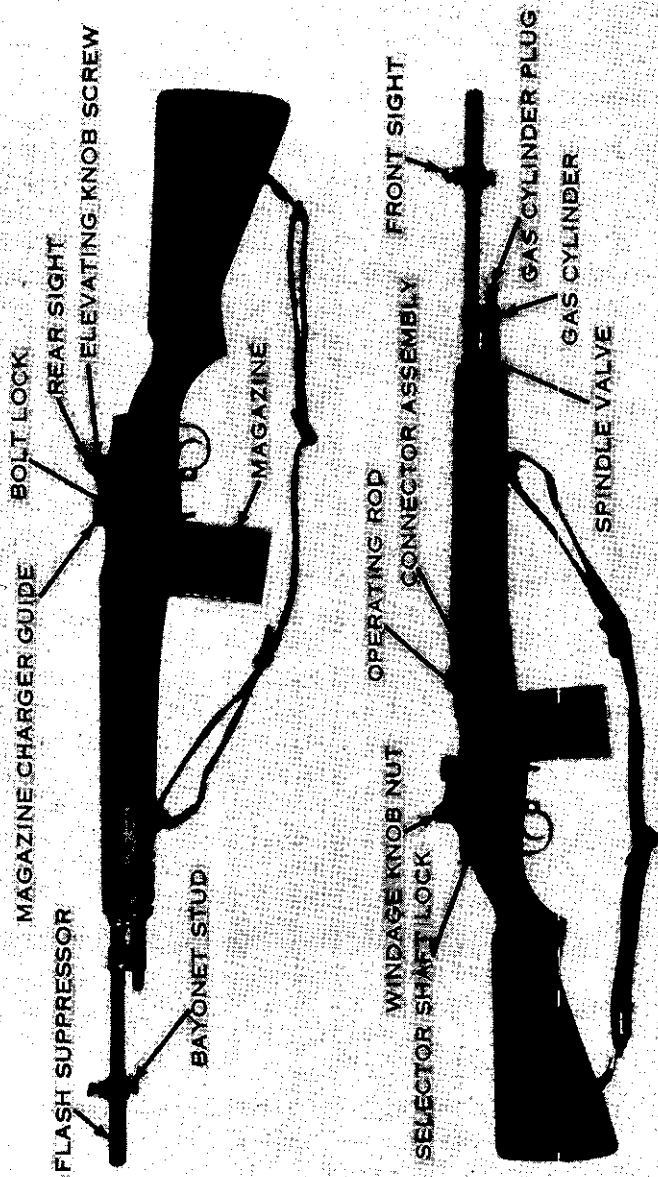

Figure 1. The M14 rifle.

c. The sear release, selector shaft, and connector assembly, mounted on the right side of the receiver and positioned by the selector shaft lock, do not operate during semiautomatic firing.

d. The web sling is used for firing on the distance range and for carrying the weapon. Each rifleman adjusts his sling according to individual need.

4. General Data

a. Weights in Pounds.

Rifle without magazine and sling.....	8.33
Empty magazine (aluminum alloy).....	.27
Full magazine (20 rounds).....	1.07
Sling.....	.31
Cleaning equipment.....	.61
Firing weight (fully loaded, with sling)....	10.32

b. Lengths in Inches (Approximate).

Rifle, overall, with flash suppressor.....	44.14
Barrel.....	22.00

c. Mechanical Features.

Rifling.....	four grooves, right hand twist.
Sight.....	elevation graduated in meters; windage graduated in clicks.
Trigger pull:	
Maximum.....	7.5 lb.
Minimum.....	5.5 lb.
Loading devices.....	20-round magazine and 5-round magazine charger.
Method of operation.....	gas.
Type of mechanism.....	rotating bolt.
Method of feeding.....	magazine, 20-round capacity.
Chamber pressure.....	50,000 p.s.i.
Cooling.....	air.

d. Ammunition.

Caliber.....	7.62-mm
Type.....	see chapter 6.

e. Firing Characteristics.

Muzzle velocity (approximate).....	2,800 f.p.s.
Cyclic rate of fire.....	700-750
Maximum rate of fire:	
Semiautomatic.....	40-60
Automatic.....	120-150
Sustained rate of fire.....	8-10*
Maximum effective rate of fire:	
Semiautomatic.....	20-30*
Automatic.....	40-60*
Maximum range.....	3,750 meters
Maximum effective range.....	460 meters

*Based on limited tests.

f. Definitions.

- Cyclic rate-----the rate at which the weapon fires automatically.
- Maximum rate of fire-----the fastest rate at which a well-trained rifleman can fire.
- Sustained rate of fire-----the rate at which a weapon can fire indefinitely without seriously overheating.
- Maximum effective rate of fire-----the maximum number of rounds the average rifleman can fire and still get a reasonable number of hits on the target.
- Maximum range-----the greatest distance the weapon can fire.
- Maximum effective range-----the greatest distance at which a rifleman can be expected to fire accurately to inflict casualties or damage.

CHAPTER 2

MECHANICAL TRAINING

Section I. DISASSEMBLY AND ASSEMBLY

5. General

a. The individual soldier is authorized to disassemble his rifle to the extent called field stripping. Chart 1 shows the parts he is permitted to disassemble with and without supervision. The amount of disassembly he is allowed to perform without supervision is adequate for normal maintenance.

b. *The frequency of disassembly and assembly should be kept to a minimum consistent with maintenance and instructional requirements.* Constant disassembly causes excessive wear of the parts and leads to their early unserviceability and to inaccuracy of the weapon. It is impossible to fire effectively with an inaccurate rifle and any loss of effectiveness reduces the soldier's confidence in himself and his weapon.

c. The rifle has been designed so that it can be taken apart and put together easily. No force is needed if it is disassembled and assembled correctly. The parts of one rifle (except the bolt) may be interchanged with those of another when necessary. Bolts should never be interchanged for safety reasons, and because such an exchange can affect the rifle's zero as well as its operating efficiency.

d. As the rifle is disassembled, the parts should be laid out on a clean surface, in order, from left to right. This makes assembly easier because the parts are assembled in the reverse order of disassembly. The names of the parts (nomenclature) should be taught along with disassembly and assembly to make further instruction on the rifle easier to understand.

6. Separation of the Three Main Groups

Pull the operating rod handle to the rear and inspect the chamber to insure that it is clear. While holding the operating rod to the rear with the edge of the right hand, depress the magazine follower with the right thumb so the bolt can move forward over the follower. As the bolt moves forward over the rear of the follower, remove the right thumb, regrasp the weapon with the left hand, and release the operating rod handle. Place the safety

in the safe position. Next, place the butt of the rifle on your left hip or thigh with the sights to the left and loosen the sling. Grasp the magazine with your right hand so that the thumb is against the magazine latch and the fingers are around the front of the magazine. Push the magazine latch with the thumb, then pull the magazine out of the receiver (fig. 2).

Chart 1. Disassembly Authorization

Part	Individual	Disassembly supervised by		Noncommissioned off or armorer	Ordnance personnel
		Noncommissioned off or armorer	Commissioned off		
SEPARATION: INTO THREE MAIN GROUPS.	X				
DISASSEMBLY: BARREL AND RECEIVER GROUP.	X				
Except:					
Front sight.....					X
Rear sight.....			X		
Flash suppressor.....					X
Valve spindle.....					X
Sear release.....				X	
Selector & selector shaft lock.				X	X
Connector assembly (spring and plunger).					X
Bolt lock.....				X	
Magazine charger guide.....					X
Operating rod guide.....					X
Barrel from receiver.....					X
STOCK GROUP:					
Stock liner.....					X
Upper sling swivel bracket.....					X
Stock ferrule.....					X
MAGAZINE GROUP.....	X				
BOLT GROUP.....		X			
Except:					
Bolt roller from bolt stud.....					X
FIRING MECHANISM ASSEMBLY.	X				
Except:					
Magazine latch.....					X
Sear from trigger.....					X
CONVERTING RIFLE TO FIRE SELECTIVELY.				X	

a. To remove the firing mechanism assembly, grasp the rear of the trigger guard with the thumb and forefinger of your right hand and pull downward and outward as far as the guard will go (fig. 3). Lift out the firing mechanism assembly.

b. Lay the weapon on a flat surface with the sights up and muzzle to the left. Grasp the receiver with the left hand over the bolt and raise the rifle a few inches. With the right hand, strike down on and grasp the small of the stock, separating the stock group from the barrel and receiver group.

c. The three main groups are shown in figure 4.

7. Assembly of the Three Main Groups

a. Place the barrel and receiver group on a flat surface, sights down. Pick up the stock group and engage the stock ferrule in

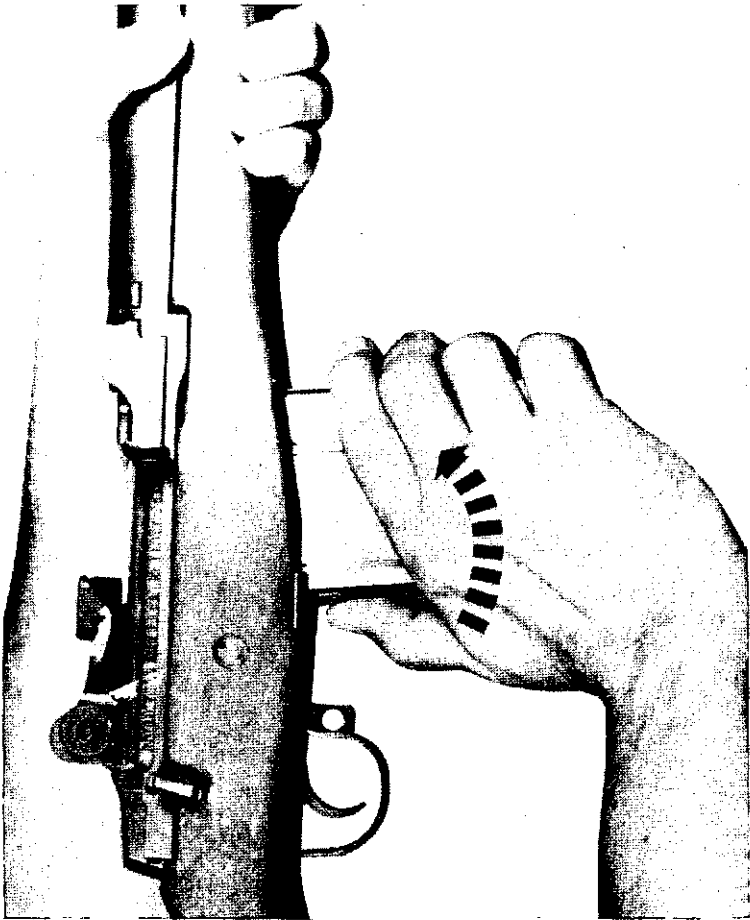

Figure 2. Removing the magazine.

the front band, then lower the stock group onto the barrel and receiver group.

b. Unlatch and open the trigger guard. Place the firing mechanism assembly straight down into the receiver, making sure that the guide rib on the assembly enters the recess in the receiver (fig. 5). Close and latch the trigger guard.

8. Disassembly of the Barrel and Receiver Group

- a. (1) *Removing the connector assembly.* Turn the barrel and receiver group on its left side with the operating rod handle up and the muzzle away from you. On rifles modified for selective firing press in and turn the selector until the face marked A is toward the windage knob (fig. 6). With the bolt closed, place the right thumb,



Figure 3. Opening the trigger guard.

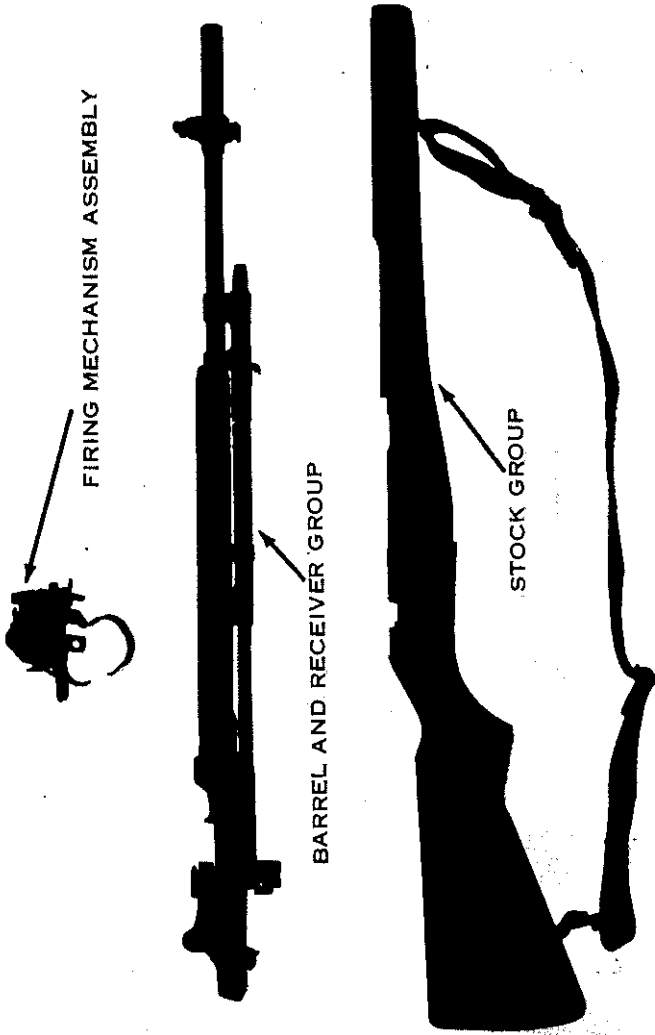

Figure 4. The three main groups.

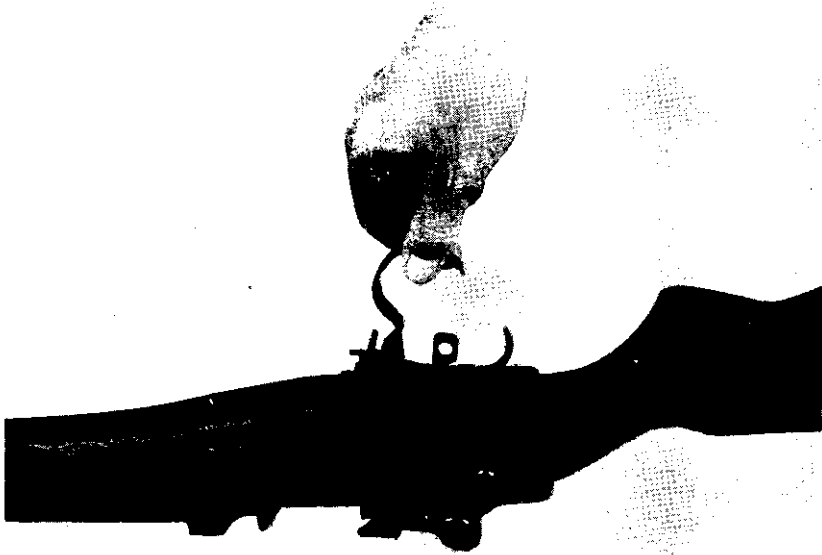

Figure 5. Replacing the firing mechanism assembly.

on the rear of the connector assembly and the first finger (or the first and second fingers) inside the rear of the receiver (fig. 7(1)). Push forward with the thumb until the forward end of the assembly can be lifted off the connector lock (fig. 7(2)). (Note that the rifle shown in figs. 7(1)–(3) has not been modified for selective firing.) Turn the connector assembly clockwise as shown in figure 7(3) until the slot in the rear end is aligned with the elongated stud of the sear release. Lower slightly the front end of the connector assembly and lift the rear end off the elongated stud of the sear release.

Caution: Do not bend the connector assembly or damage the overhang of the sear release when removing the connector assembly.

- (2) *Removing the operating rod spring and operating rod spring guide.* Place the barrel and receiver group on a flat surface, sights down, muzzle to the left. With your left hand, pull toward the muzzle on the operating rod spring to relieve pressure on the connector lock (fig. 8(1)). With your right forefinger, push the connector lock toward you and disconnect and remove the operating rod spring and guide (fig. 8(2)).
- (3) *Removing the operating rod.* Turn the barrel and re-

ceiver group so the sights are up and the muzzle is pointing away from you. Pull back the operating rod handle until the guide lug on its inside surface is aligned with the disassembly notch on the right side of the receiver (fig. 9). Rotate the operating rod downward and outward, then pull it to the rear, disengaging it from the operating rod guide.

- (4) *Removing the bolt.* Grasp the bolt by the roller and, while sliding it forward, lift it upward and outward to the right front with a slight rotating motion.

b. The rifle is now field stripped and basic assemblies such as the bolt may be disassembled, if required.

c. The parts of the barrel and receiver group in their order of disassembly are shown in figure 10.

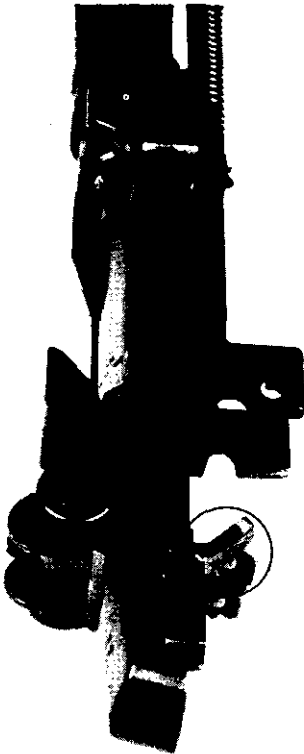

Figure 6. Position of the selector for removing the connector assembly (rifle modified for selective firing).



Figure 7. Removing the connector assembly (1).



Figure 7—Continued. (2)



Figure 7—Continued. (3)

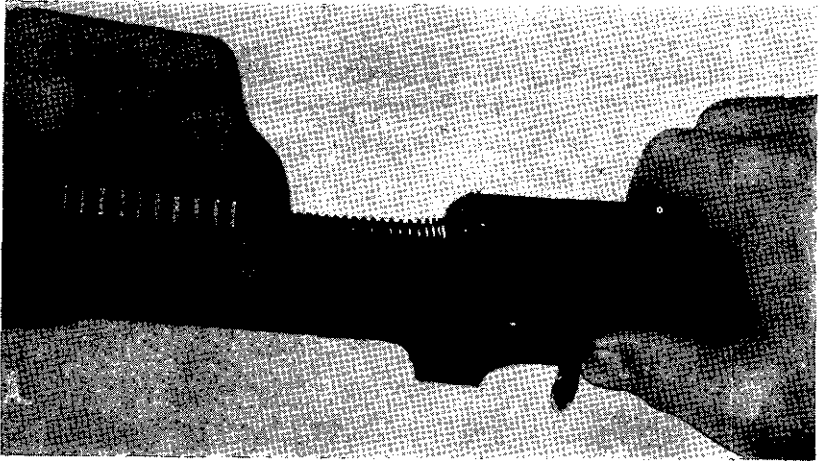

Figure 8. Removing the operating rod spring and operating rod spring guide. (1)

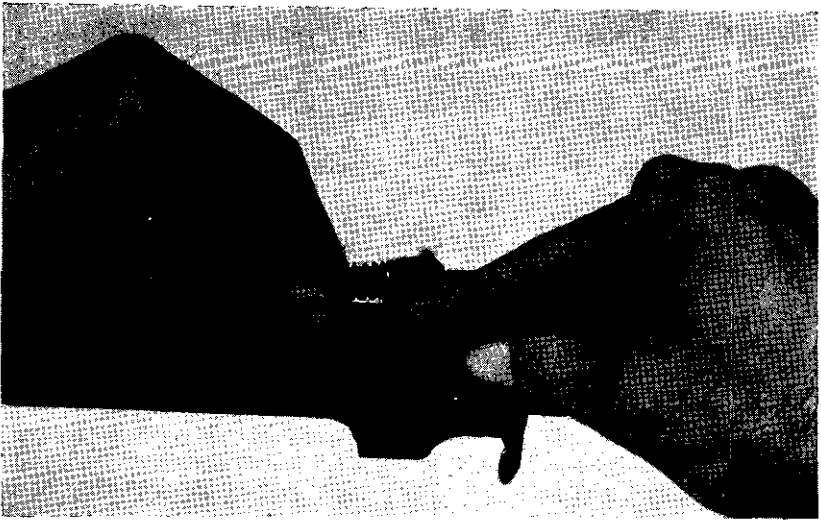

Figure 8—Continued. (2)

9. Assembly of the Barrel and Receiver Group

a. Replacing the Bolt. Lay the barrel and receiver on the table, sights up, muzzle pointing away from you. Hold the bolt by the roller and locking lug and place the rear end on the bridge of the receiver firing pin tang pointed down. Turn the bolt counterclockwise as far as necessary to let the tang of the firing pin clear the bridge. Guide the left locking lug of the bolt into its groove on the left side of the receiver. Lower the right locking lug on its bearing surface and slide the bolt halfway to the rear.

b. Replacing the Operating Rod. Hold the operating rod at the handle, place the front end into the operating rod guide, and position the rod so that the recess in the hump fits over the bolt roller. Turn the operating rod to the left until the guide lug will fit in the disassembly notch on the receiver as shown in figure 9, then move the operating rod forward until the bolt is closed.

c. Replacing the Operating Rod Spring and Operating Rod Spring Guide. Turn the barrel and receiver over so the sights are down and the muzzle is to the left. Place the operating rod spring guide into the operating rod spring, hump end up, and place the spring and guide inside the operating rod. Grasp the spring and guide with the left hand and compress the spring until the hole in the guide can be aligned with the connector lock. Lower the guide and push the connector lock in with the right thumb (fig. 11).

d. Replacing the Connector Assembly. Turn the barrel and receiver on its side with the operating rod handle up, muzzle away from you. Place the hole in the rear end of the connector assembly on the elongated stud of the sear release (fig. 12(1)). Place the right thumb on the rear of the connector assembly, the index finger on the sear release bracket, and the middle finger in the rear of the receiver. Push toward the muzzle with the right

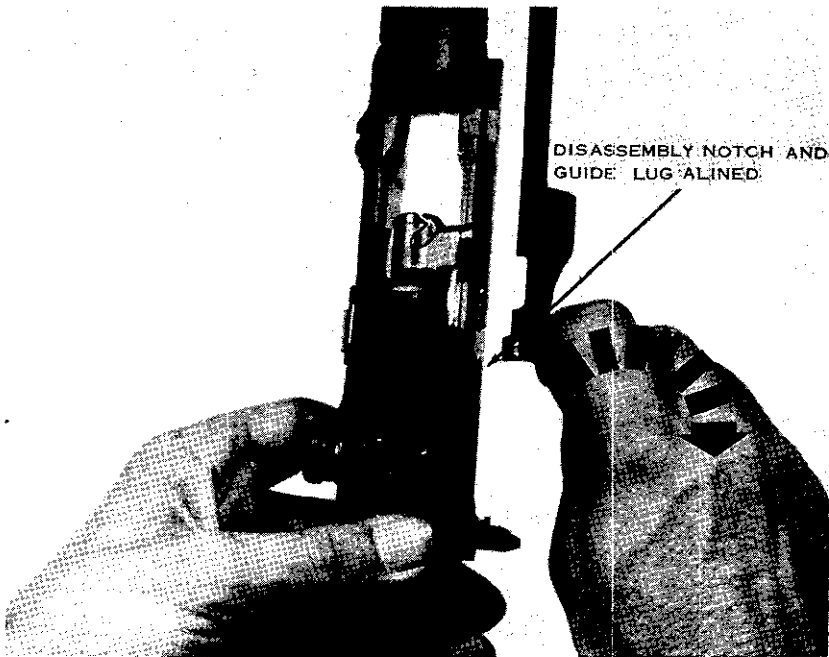

Figure 9. Removing operating rod.

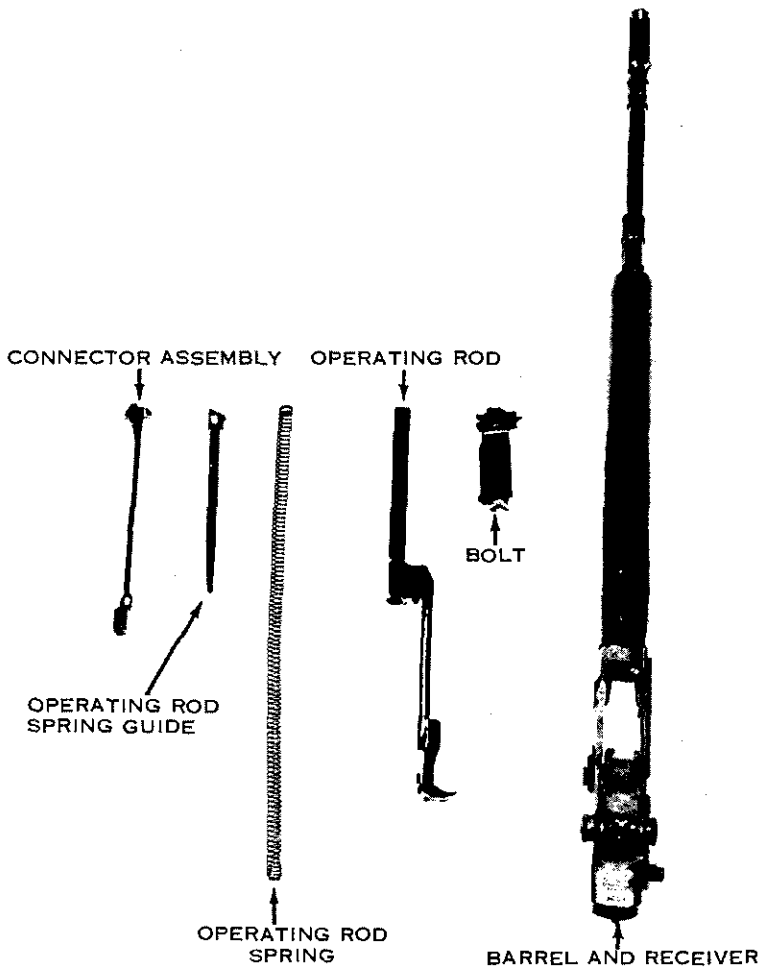

Figure 10. Parts of the barrel and receiver group in the order of disassembly.

thumb and, at the same time, turn the front of the assembly counterclockwise until it can be lowered onto the connector lock (fig. 12(2)).

10. Disassembly of the Bolt

a. Bolt Out of Rifle. Holding the combination tool as shown in figure 13, push it into the face of the bolt with the screwdriver blade beneath the extractor. Turn the tool clockwise, maintaining pressure against the ejector and spring. Lift the extractor from the bolt. When the extractor is clear, allow the ejector to slowly push the combination tool away from the face of the bolt until it is no longer under spring pressure. Remove the ejector

and spring. Lift out the extractor spring and plunger. Do not separate the ejector from its spring nor the extractor spring from its plunger. Remove the firing pin from the rear of the bolt. Do not disassemble the bolt roller from the stud. The parts of the bolt in the order of disassembly are shown in figure 14.

b. *Bolt in Rifle.* The wrench head portion of the combination tool is used to remove the extractor, extractor spring and plunger,

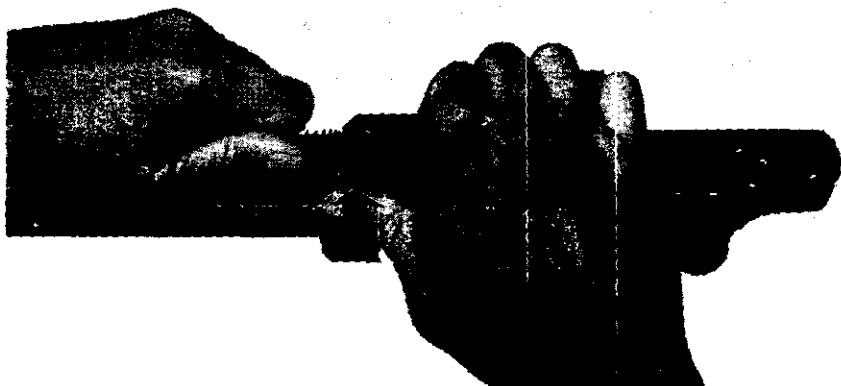

Figure 11. Replacing the operating rod spring and operating rod spring guide.



Figure 12. Replacing the connector assembly. (1)

and the ejector and spring. To do this, insert the wrench head into the chamber with the screwdriver blade beneath the extractor as shown in figure 15(1). Allow the bolt to close slowly against the wrench. Insert one cleaning rod section into the socket and turn the rod section counterclockwise as shown in figure 15(2) until the extractor is free. (It may be necessary to hold the bolt

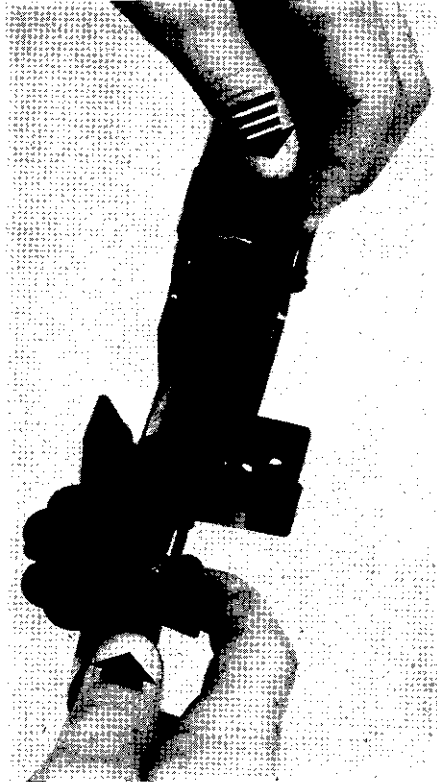

Figure 12—Continued. (2)

forward during this operation so that the screwdriver blade will engage properly with the extractor.) Lift out the extractor. Allow the bolt to move to the rear and remove the ejector and spring and the extractor spring and plunger.

X11. Assembly of the Bolt

a. *Bolt Out of Rifle.* Insert the firing pin, making sure that the tang fits into the recess on the rear of the bolt. Hold the bolt in the left hand with the bolt roller in the up position and to the right. Replace the ejector and ejector spring so that the cut on the ejector is toward the bolt roller. Replace the extractor spring

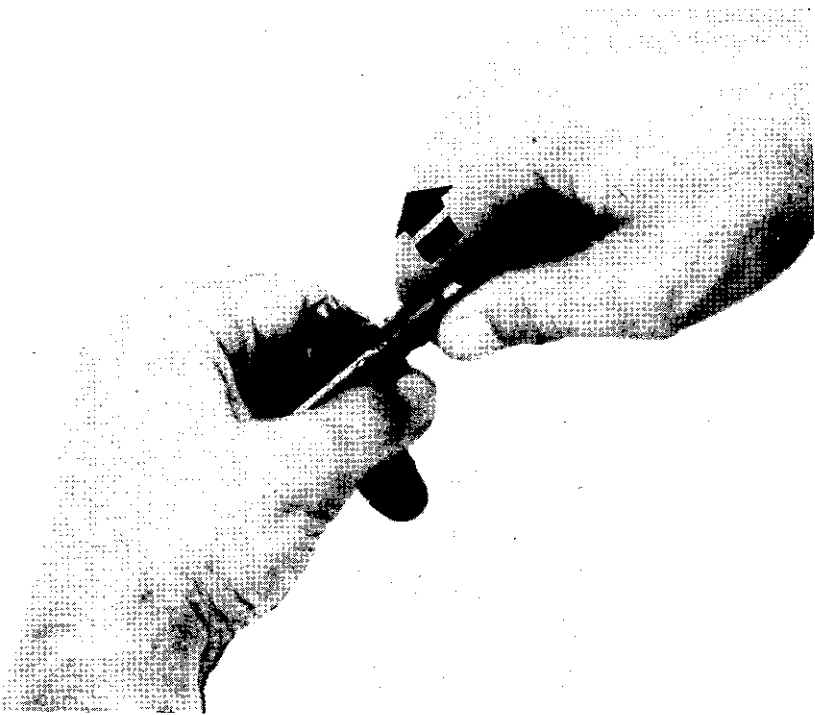

Figure 13. Unseating extractor (bolt out of rifle).

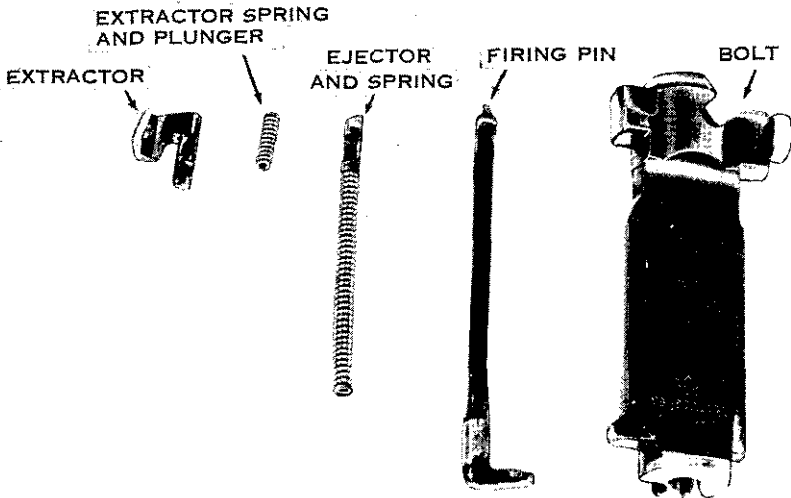

Figure 14. Parts of the bolt in the order of disassembly.

and plunger. Engage the ejector with the combination tool as shown in figure 16 being careful to push the ejector into position with the tools. When the tool is against the face of the bolt, push



Figure 15. Unseating extractor (bolt in rifle). (1)

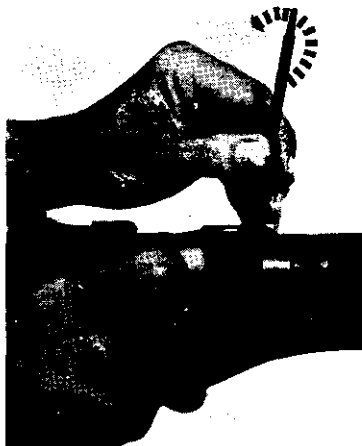

Figure 15—Continued. (2)

the extractor into position and allow the tool to turn as the extractor pushes on the screwdriver blade.

b. Bolt in Rifle. Insure that the tang of the firing pin is seated in the recess in the rear of the bolt. Install the ejector and ejector



Figure 16. Replacing extractor and ejector (bolt out of rifle).

spring so that the cut on the ejector is toward the bolt roller. Replace the extractor spring and plunger. Insert the extractor into position and insert the wrench head into the chamber with the screwdriver blade in position as shown in figure 17. Slowly close the bolt on the wrench until the wrench is fully seated. As the bolt closes, the ejector will contact the wrench first. Take care to prevent the ejector from slipping off the wrench. Holding the bolt forward, push the extractor down into position. If necessary, push the extractor with a rod section to fully seat it in the bolt.



Figure 17. Replacing extractor and ejector (bolt in rifle).

Note. In disassembling and assembling the bolt, hold the rifle muzzle down to keep the firing pin in the bolt. If the firing pin is to be replaced, take the bolt out of the rifle and disassemble it as described in paragraph 10a.

12. Disassembly of the Rear Sight

a. Place the barrel and receiver group on the table with the sights up and muzzle pointing away from you. Lower the aperture as far as it will go. If the rifle has been zeroed, check the

reading on the elevating knob and write it down. You will need this reading when you replace the elevating knob.

b. Unscrew the nut in the center of the windage knob with the screwdriver blade of the combination tool. (Be careful not to damage the slot in the nut.) The nut will become loosened but it cannot be removed. Unscrew the windage knob counterclockwise until the windage knob assembly can be removed. Push forward lightly on the right side of the rear sight base and remove the rear sight elevating pinion assembly by withdrawing it to the left. Pull the aperture up about one-half inch and place your right thumb underneath it, then push forward and upward, removing the aperture, cover, and base.

c. The parts of the rear sight are shown in figure 18.

13. Assembly of the Rear Sight

a. Assemble the rear sight cover and base into one unit. Place the front lip of the sight cover in the slot at the front end of the sight housing. Raise the base slightly and push forward and downward with the screwdriver blade of the combination tool against the rear part of the sight cover, seating it in its slot in the rear of the sight housing. Replace the windage knob assembly

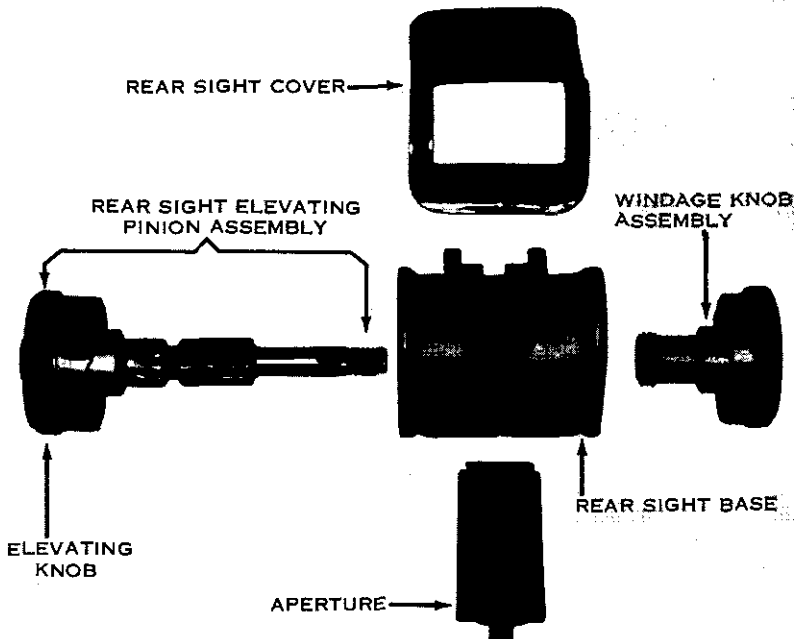

Figure 18. Parts of the rear sight (exploded view).

and screw it in until it draws the base to the center position on the windage gage. Push forward, lightly, on the right rear of the base while inserting the elevating pinion assembly from the left, meshing the pinion with the teeth on the aperture until the threaded end of the pinion contacts the windage knob. Tighten the nut in the center of the windage knob until you feel a stiffening resistance. When it is tight, back it off one complete turn. This should give the correct tension. Make sure that the reading that was on the elevating knob before disassembly is opposite the index mark on the receiver when the aperture is at its lowest position. Then tighten the elevating knob screw.

b. Obtaining the proper tension is extremely important; without it, the sight will not hold its adjustment in elevation. If you cannot hear clear, sharp clicks when you turn the elevating knob, or if the aperture drops when the rifle is fired, check the tension as follows:

- (1) Run the aperture up about 20 clicks.
- (2) Press down on top of the aperture with the thumb.
- (3) If the aperture drops, the tension must be adjusted.

c. To adjust the tension, first make sure that the elevating knob screw is tight. Next, tighten the windage knob nut one click at a time. Test the tension as described in (1) and (2) above after each click and continue the process until the aperture does not drop. If the proper tension cannot be set by doing this, the sight must be repaired or replaced.

d. When sight tension is properly applied, the windage knob may be hard to turn. This may be overcome by pressing inward on the elevating pinion assembly with the left thumb while turning the windage knob with the right hand.

14. Disassembly of the Gas System and Handguard

a. Using the wrench of the combination tool, loosen and remove the gas cylinder plug. Tilt the muzzle down and remove the gas piston from the gas cylinder. Unscrew the gas cylinder lock and slide the lock and cylinder forward so that the gas port is exposed. Slip the front band forward toward the front sight. Push the handguard toward the front sight and lift it from the barrel.

Note. The sharp edges of the grooves and other surfaces on the piston help to permit proper functioning of the gas system. Do not dull these sharp edges. Also, *NEVER* use any abrasive material to clean any components of the gas system. Tolerances are close and must not be altered. Remember, a clean system is *not* necessarily a shiny one.

b. The parts of the gas system, and the handguard and front band are shown in figure 19.

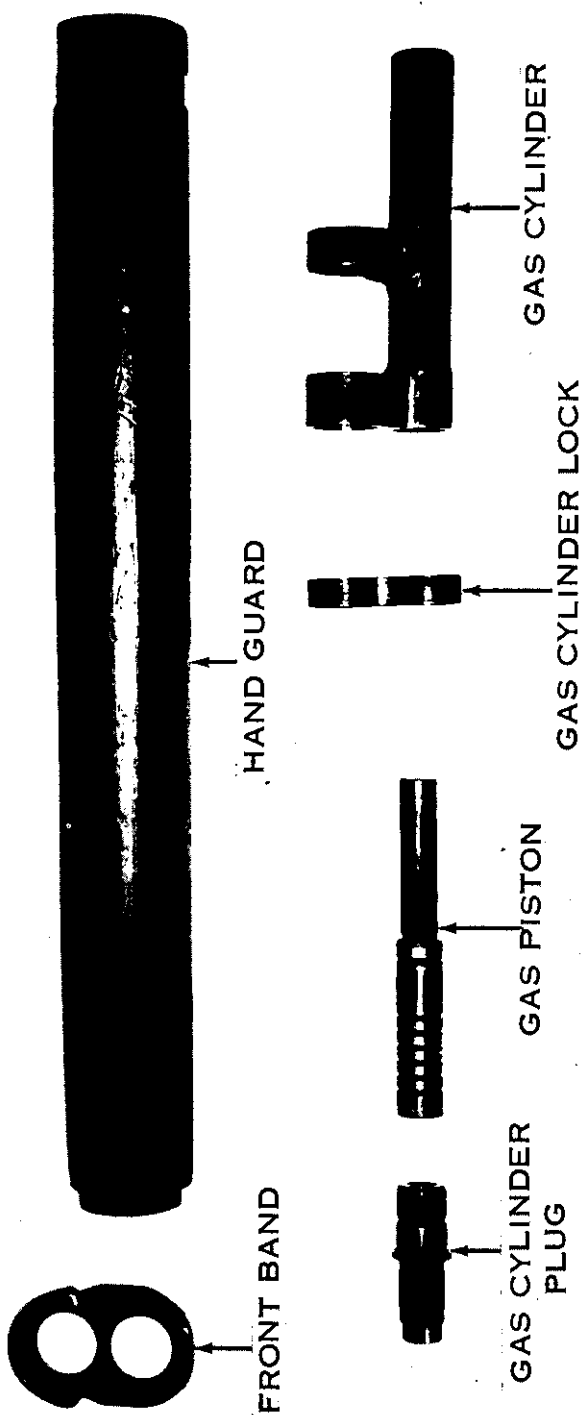

Figure 19. Parts of the gas system; handguard and front band.

15. Assembly of the Gas System and Handguard

Place the rifle on a flat surface, sights up and muzzle to the right. Engage the ends of the band on the handguard with the front (muzzle) end of the slots that are on the rear of the barrel and *slide* the handguard rearward. (Do not *snap* the handguard into its installed position.) Replace the front band. Slide the gas cylinder rearward through the front band. Tighten the gas cylinder lock by hand to its fully assembled position, then back it off until the loop is alined with the gas cylinder. Replace the gas piston, the flat part toward the barrel and the open end toward the muzzle. Replace the gas cylinder plug and tighten it securely with the wrench of the combination tool.

Note. Before tightening the gas cylinder plug, be certain that the piston moves freely and protrudes through the cylinder. Then, tighten the gas cylinder plug, making certain it is secure.

16. Disassembly of the Firing Mechanism Assembly

a. Close and latch the trigger guard. Place the safety in the off position and press the trigger, allowing the hammer to go forward. Hold the firing mechanism assembly in your left hand with the vertical face to the left and the open face against your palm. With the tip of a cartridge, apply pressure on the trigger pin until its head is unseated (fig. 20). Next, hold the firing mechanism assembly with your right hand, open face up, trigger

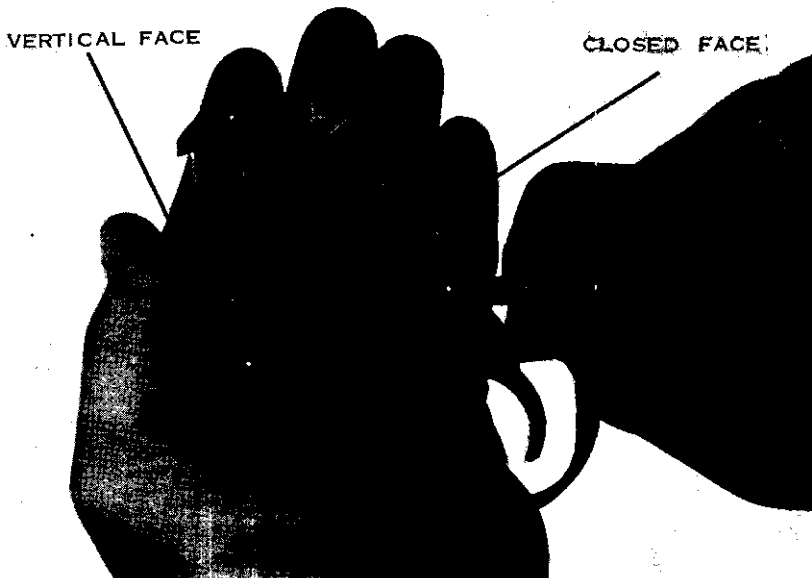

Figure 20. Unseating the trigger pin.

guard to the left, forefinger over the sear, thumb on the vertical face, and apply a pinching pressure with the thumb and index finger as shown in figure 21 and remove the trigger pin. Slowly release the pressure, allowing the hammer spring to expand.

b. Transfer the firing mechanism assembly to your left hand with the vertical face still toward your body and the open face up. With your right hand, remove the trigger and sear assembly, hammer spring housing, hammer spring, and hammer spring plunger.

c. Unlatch and open the trigger guard. Hold the firing mechanism assembly in your left hand with the vertical face away from



Figure 21. Removing the trigger pin.

your body and the open face down. Push out the hammer pin with the tip of a cartridge (fig. 22). Turn the trigger housing over; move the hammer slightly to the rear and lift it out.

d. Leave the trigger guard unlatched. Turn the trigger housing over so the open face is down and push the stud of the safety from its hole with the tip of a cartridge. Remove the safety and safety spring by lifting them out of the trigger housing.

e. Hold the rear of the trigger housing with the left hand as shown in figure 23. Grasp the trigger guard with your right hand and slide it to the rear until the hammer pin holes in the wings of the trigger guard are just forward of the safety stud hole. Cant the guard to the right, push it forward and up, and remove it from the trigger housing.

f. The magazine latch should not be removed from the trigger housing.

g. The parts of the firing mechanism assembly in the order of disassembly are shown in figure 24.

17. Assembly of the Firing Mechanism Assembly

a. Hold the rear of the trigger housing with your left hand, the vertical face away from you, open face to the right. Place the

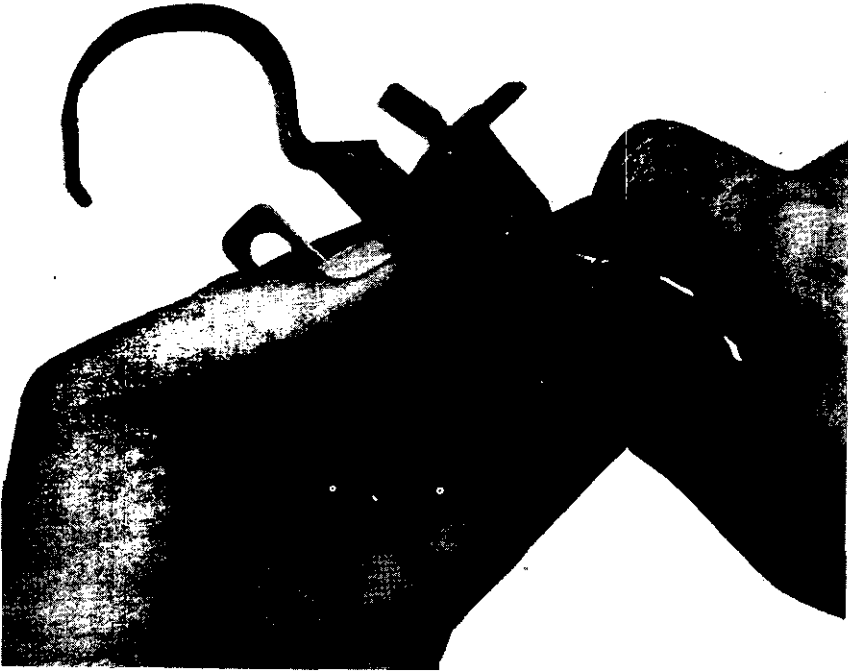

Figure 22. Removing the hammer pin.

hammer stop on the trigger guard on the floor of the trigger housing just forward of the safety slot, then rotate the trigger guard down and to the left.

b. Hold the trigger housing with your left hand, vertical face to the left, open face up. Place the loop of the safety spring on its stud in the trigger housing (fig. 25) and rotate it clockwise into position. (The short arm of the spring should be along the base of the trigger housing.)

c. Place the right forefinger over the safety spring stud to hold the safety spring in place. Insert the finger piece of the safety through its slot in the base of the trigger housing and turn the trigger housing over so the open face is down. Seat the safety stud in its hole in the trigger housing with the left hand by forcing the safety down against the pressure of the safety spring (fig. 26).

d. Hold the trigger housing in your left hand, the vertical face away from you and the open face up. Place the safety in the off

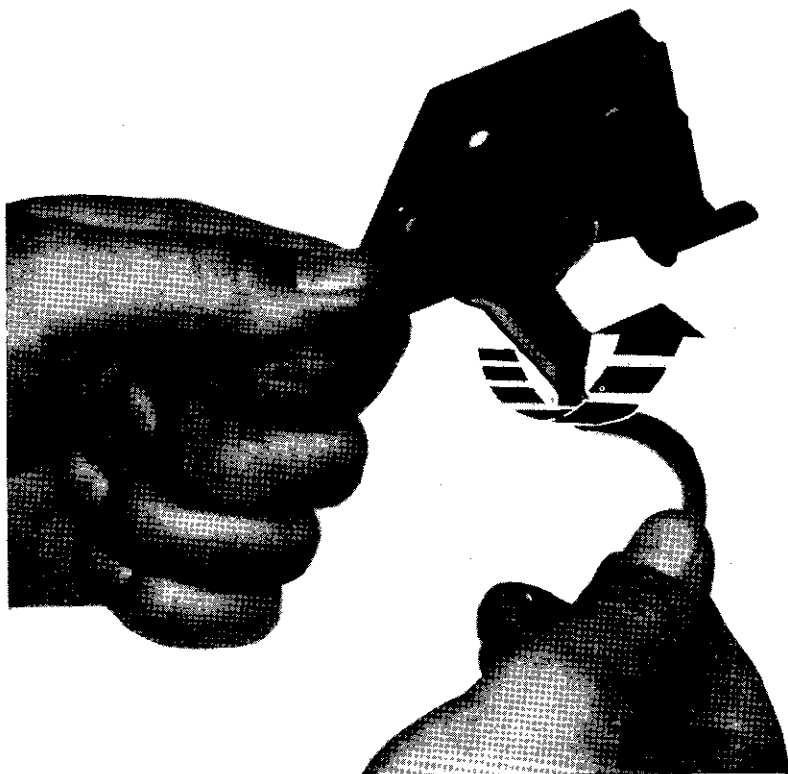

Figure 23. Removing the trigger guard.

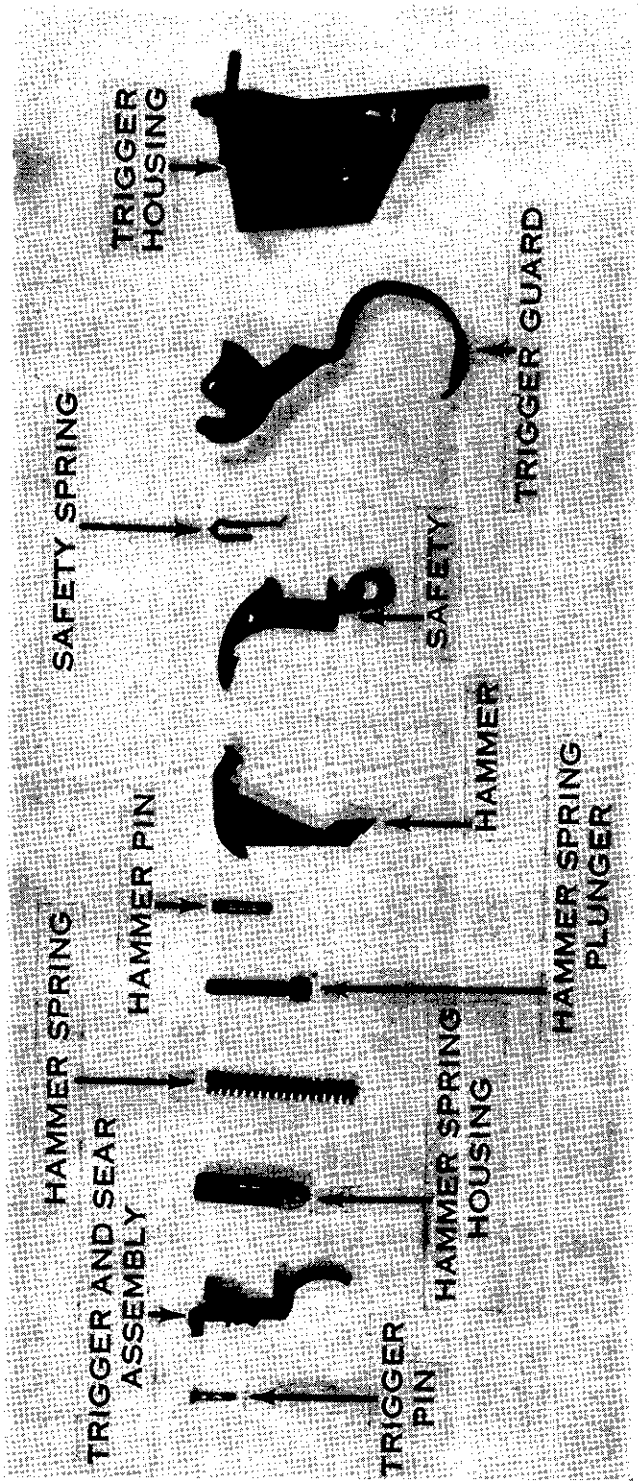

Figure 24. Parts of the firing mechanism assembly in the order of disassembly.

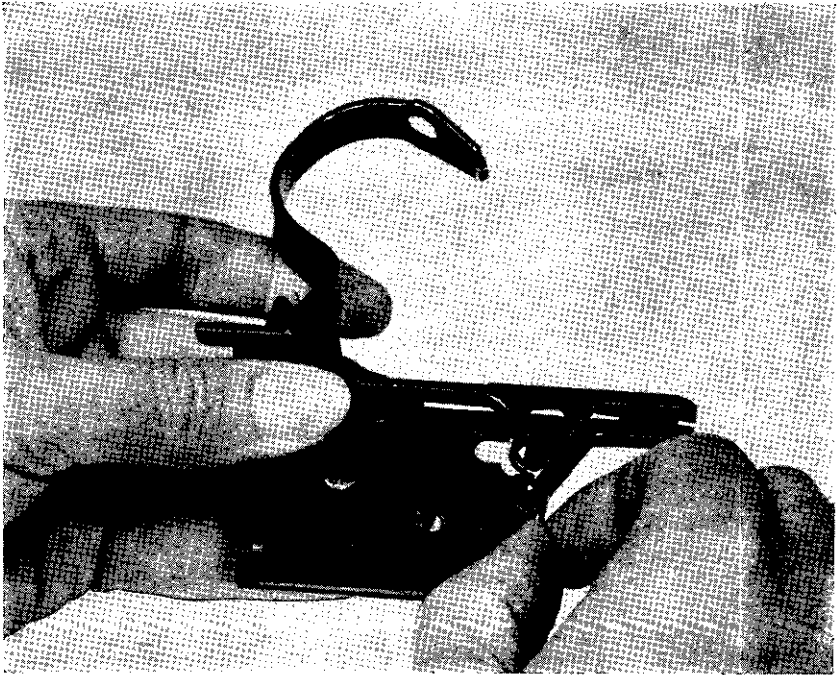

Figure 25. Replacing the safety spring.

position. Place the hammer in position, holding it halfway between the cocked and fired positions. Be sure that the hammer toe is in front of the hammer stop on the right wing of the trigger guard. Aline the hammer pin hole in the hammer with the holes in the trigger housing and trigger guard. The trigger guard should not be latched. Replace the hammer pin from the top and seat it.

e. Assemble the hammer spring plunger, hammer spring, and hammer spring housing into one unit. Hold the trigger housing in your left hand with the vertical face toward you and the open face up. Place the plunger in its seat on the hammer. Make sure that the cut-away portion of the hammer spring housing is toward the safety. Hold these parts in place with your left thumb and insert the trigger into the trigger slot so that the notch at the curved rear surface of the finger piece bears against the rear of the slot in the trigger housing. Place the wings of the hammer spring housing astride the sear pin. With your right forefinger hooked over the sear and your right thumb on the vertical face, apply pressure to compress the hammer spring and aline the holes for the trigger pin. Insert the trigger pin as far as its head (fig. 27).

f. Apply pressure with your right hand in the directions shown

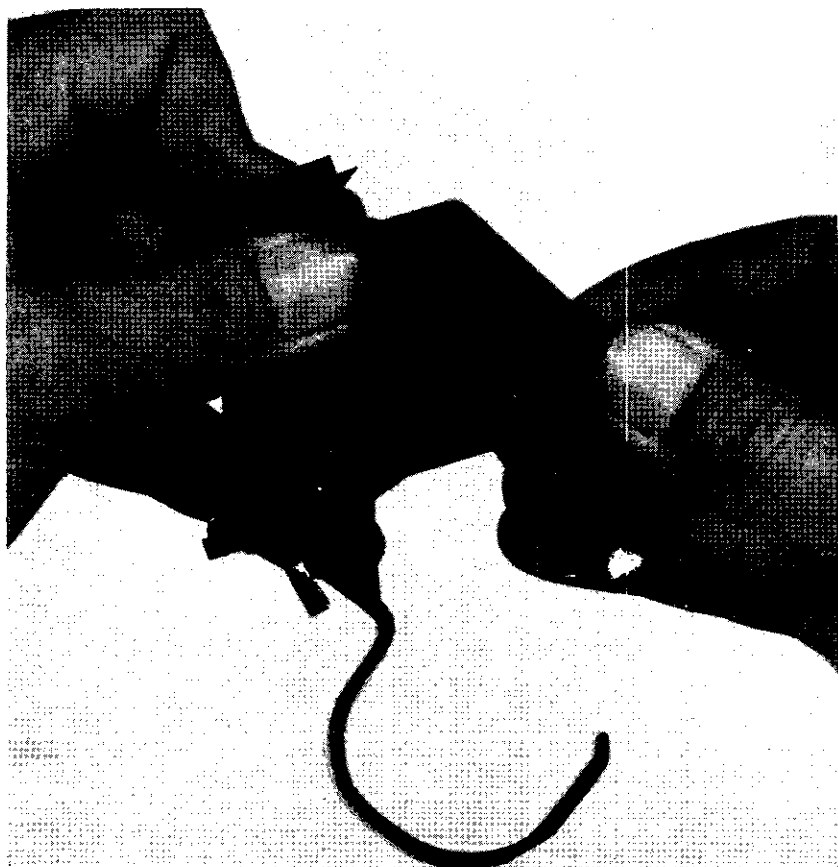

Figure 26. Replacing the safety.

in figure 28 and seat the head of the trigger pin by pressing on it with the left thumb.

18. Disassembly of the Magazine

a. Use the point of a cartridge to raise the front of the magazine base (fig. 29) until its indentation is clear of the magazine. Grasp the magazine with either hand, with one finger of that hand covering the base. Remove the base with the other hand while the finger of the grasping hand controls the expanding spring.

b. Remove the magazine spring and the magazine follower and separate them. Figure 30 shows the parts of a magazine.

19. Assembly of the Magazine

Reposition the spring inside the follower with the rectangular-shaped end of the spring against the rear of the follower, and

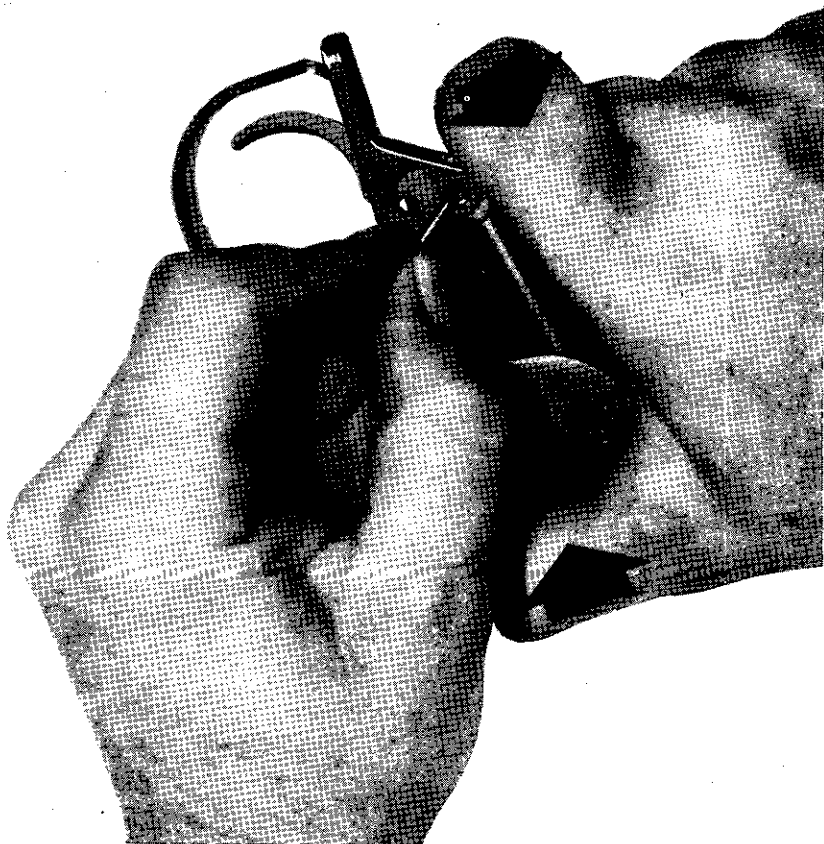

Figure 27. Replacing the trigger pin.

replace the follower and spring inside the magazine. Be sure to fully seat the follower. Place the top of the magazine down on a flat surface and compress the spring with both hands. Holding the spring with the left hand, replace the magazine base with the right hand (fig. 31).



Figure 28. Seating the trigger pin.

Section II. CONVERSION FOR SEMIAUTOMATIC AND AUTOMATIC FIRE

20. Converting to Fire Selectively

a. When the M14 is issued, it is equipped to fire semiautomatically only. It can be converted to fire selectively (either semiautomatic or automatic fire) by removing the selector lock and replacing it with a selector and selector spring.

b. To make this conversion, separate the rifle into the three main groups and remove the connector assembly. Lay the barrel and receiver group on the table, sights up, muzzle pointing away from you. With a suitable drift or a flat-faced punch, drive out the selector shaft pin which secures the selector lock (fig. 32). Remove the selector shaft lock. Hold the selector shaft in place and turn the rifle over so the sights are down. *Do not remove the shaft.* Place the selector spring and selector on the selector shaft, compress the spring on the shaft while rotating the selector until the point of the selector shaft engages in the recess of the selector. In this position the holes in the selector and shaft will be in

alinement. Replace (insert) the selector shaft pin (fig. 33). Replace the connector assembly and assemble the rifle. The rifle can now be fired either semiautomatically or automatically by turning the selector to the desired setting. When the A faces the firer as he holds the weapon in firing position, it will fire automatically. The selector's position may be determined in darkness by touch; when set on automatic, the lug end of the selector is up.

21. Converting to Fire Semiautomatically Only

Separate the rifle into the three main groups and remove the connector assembly. Lay the barrel and receiver group on a flat surface, sights up, muzzle pointing away from you. Drift out the selector shaft pin. Hold the selector shaft in place and turn the rifle over so the sights are down. Remove the selector and selector spring. (The selector spring is not used with the selector shaft lock.) Hold the selector shaft in place with the right hand

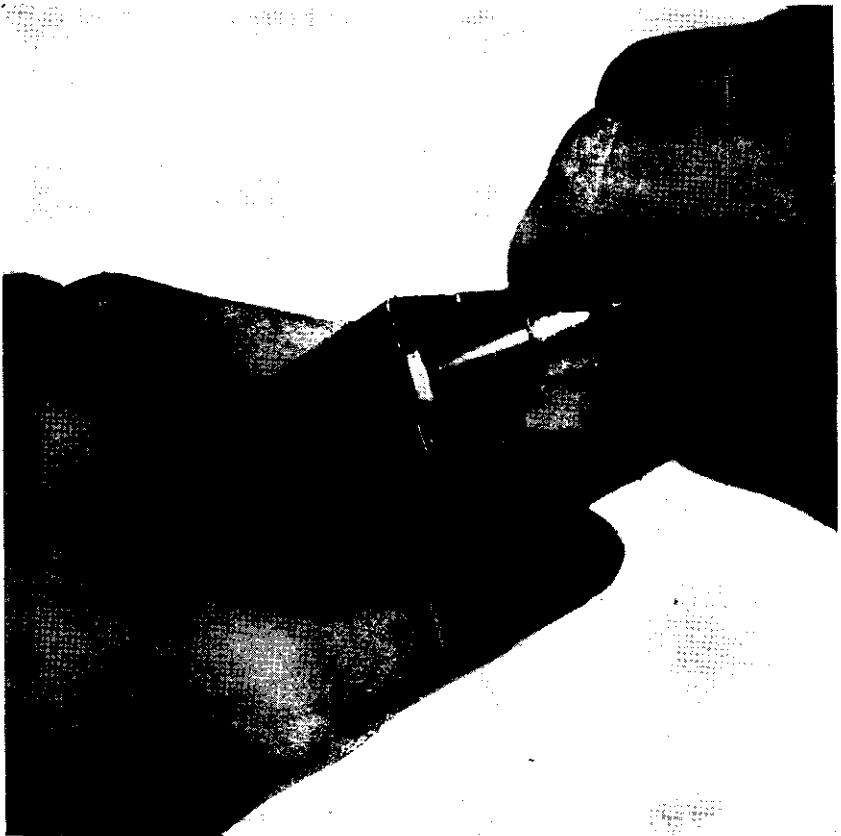

Figure 29. Removing the base of the magazine.

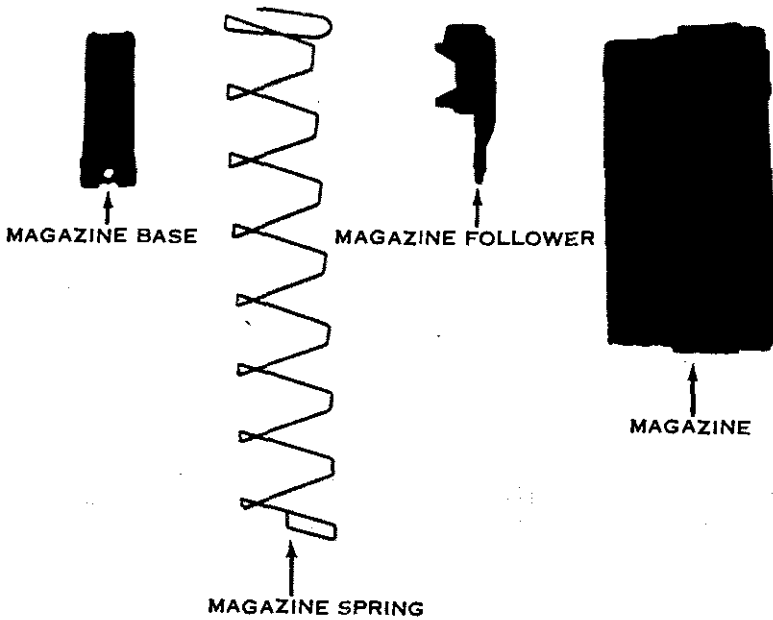

Figure 30. Parts of the magazine.

and place the selector shaft lock on the shaft. Press the selector shaft lock and shaft together while rotating the lock until the point on the selector shaft engages in the recess of the lock. Replace the pin. Replace the connector assembly and assemble the rifle. The rifle will now fire semiautomatically only.



Figure 31. Replacing the magazine base.

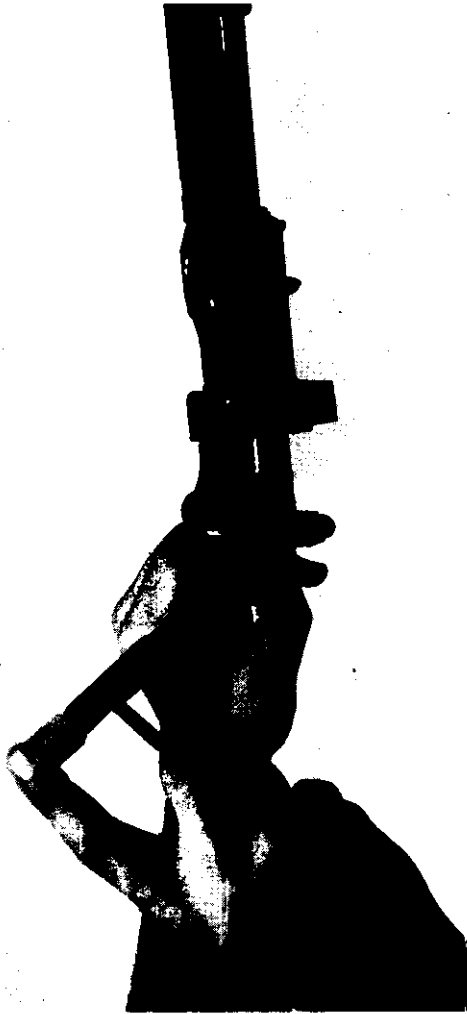

Figure 32. Removing the selector shaft pin.



Figure 33. Replacing the selector shaft pin.

CHAPTER 3

OPERATION AND FUNCTIONING

Section I. OPERATION

22. Loading the Magazine

a. Hold the magazine as shown in figure 34. Insert the rounds with the bullet ends toward the front of the magazine (front end has square hole).

b. To load the magazine with a filler, slide the filler over the top rear portion of the magazine. Insert a 5-round magazine charger in the filler. Place either thumb on the top round and push the 5 rounds into the magazine. Remove the magazine charger and repeat the process until 20 rounds have been loaded into the magazine, then remove the magazine filler.

23. Loading the Rifle

a. *Single Round (No Magazine in Rifle).*

- (1) Place the safety in the safe position (inside the trigger guard).
- (2) Pull the operating rod all the way to the rear and press in the bolt lock with your right thumb. Hold the muzzle below the horizontal; place a round into the chamber and seat it with the thumb. Pull back on the operating rod handle and release it; the bolt will go forward.

b. *Single Round (Magazine in Rifle).* To load a single round with the magazine in the weapon, place the safety in the safe position and seat a round in the chamber. Next, depress the magazine follower with the right thumb and, at the same time, press back on the operating rod handle with the edge of the hand. This will release the bolt lock and allow the bolt to go forward.

c. *Loaded Magazine.*

- (1) Place the safety in the safe position.
- (2) Insert a loaded magazine into the magazine well, top front first, until the operating rod spring guide engages the magazine (fig. 35(1)), then pull backward and upward until the magazine latch snaps into position (fig. 35(2)). A click will be heard which indicates that the

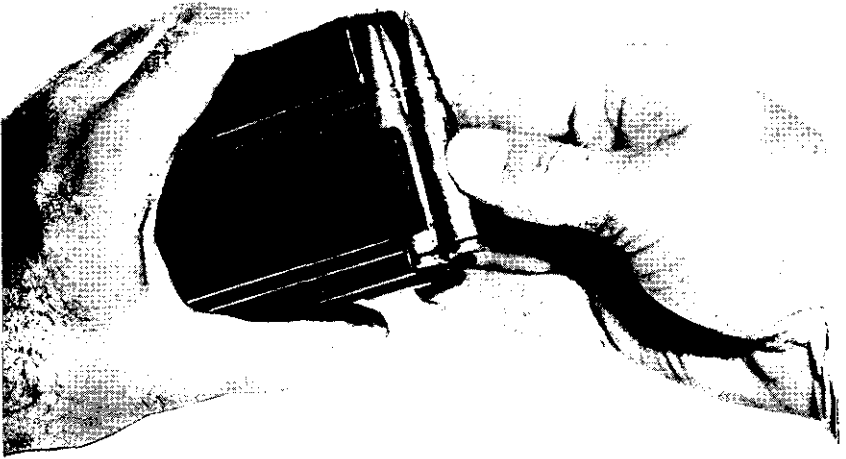

Figure 34. Loading the magazine.

magazine is fully seated. Pull back and release the operating rod handle, allowing the bolt to strip the top round from the magazine and load it in the chamber.

24. Top Loading With 5-Round Magazine Charger

An empty magazine in the weapon can be loaded through the top of the receiver with a 5-round magazine charger. To do this, place either end of the charger in the magazine charger guide, place either thumb on top of the ammunition while grasping the side and bottom of the receiver with the other hand and then exert pressure on the top round, forcing the 5 rounds into the magazine (fig. 36). Remove and discard the magazine charger.

25. Unloading and Clearing the Rifle

- a. Place the safety in the safe position (inside the trigger guard).
- b. Remove the magazine as described in paragraph 6.
- c. Pull the operating rod rearward to extract and eject a chambered round. Press in the bolt lock.

26. Firing the Rifle

- a. The trigger must be pressed to fire each round when the selector is set for semiautomatic fire. When the last round has been fired, the magazine follower will push up on the bolt lock, causing the bolt to be held to the rear.

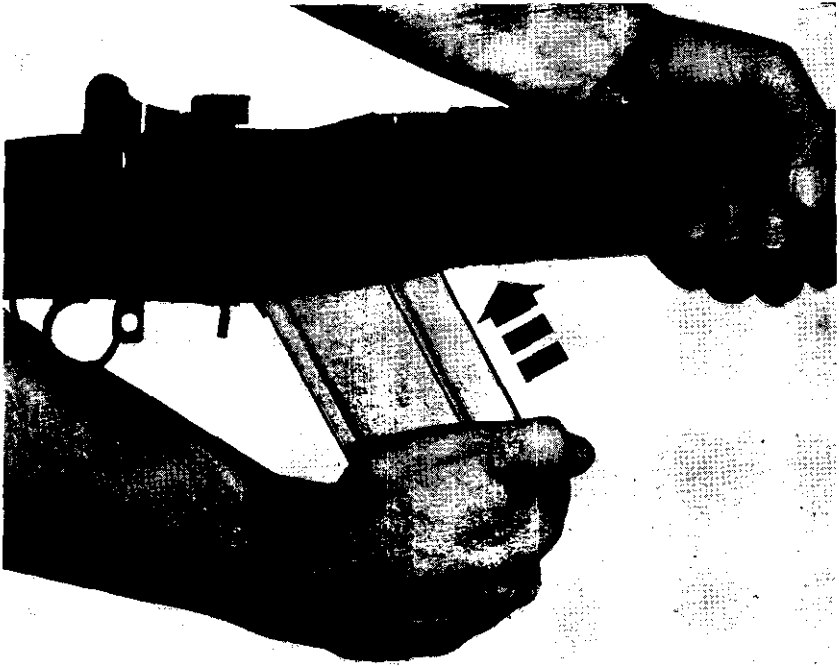

Figure 35. Loading the magazine into the rifle. (1)

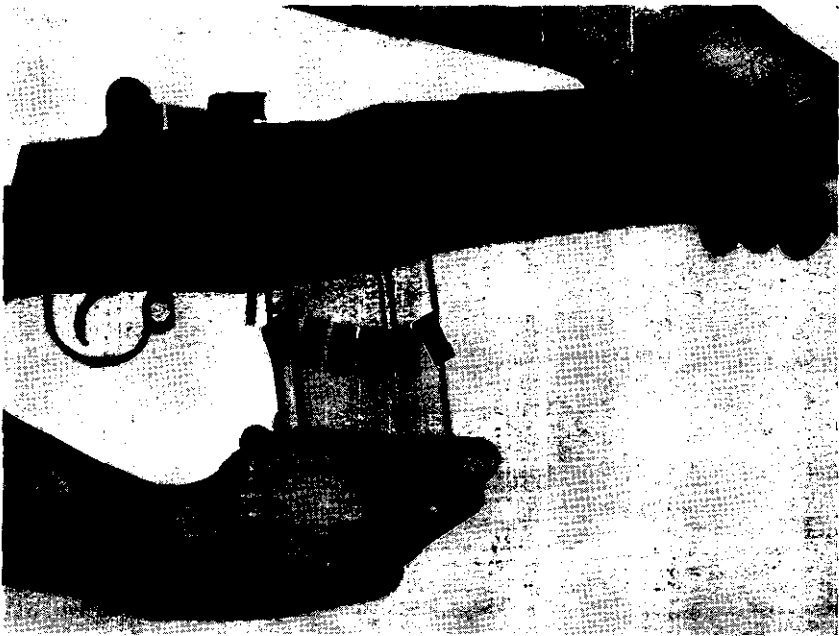

Figure 35—Continued. (2)



Figure 36. Top loading.

b. When the rifle is set for automatic fire, it will fire as long as the trigger is held to the rear and there is ammunition in the magazine. When the last round is fired, the bolt is held to the rear by the bolt lock.

c. The spindle valve must remain in the open position (the slot in the valve spindle head perpendicular to the barrel) during all firing except when using a grenade launcher.

d. When you press the trigger, the round is fired, the empty case ejected, the hammer cocked, a new round inserted into the chamber, and the rifle is ready to fire again—all in about one eight-hundredth of a minute. This rapid mechanical action allows the rifleman to deliver a large number of aimed shots in a short time.

Section II. FUNCTIONING

27. Semiautomatic

a. Each time a round is fired, many parts inside the rifle work in a given order. This is known as the *cycle of operation*. The cycle is similar in all small arms. A knowledge of what happens inside the rifle during the cycle of operation will help you to understand the cause of and remedy for various stoppages.

b. The cycle of operation is broken down into eight steps. These steps are listed below, together with a brief description of what occurs inside the rifle during each. With the selector set for semiautomatic fire (the blank face of the selector facing the firer), assume that a full magazine has been loaded in the rifle and that the first round has been fired and the bolt is to the rear (fig. 37).

- (1) *Feeding.* Feeding takes place when a round is forced into the path of the bolt. The top round is forced into the path of the bolt by the magazine follower which is under pressure of the magazine spring.
- (2) *Chambering.* Chambering occurs when a round is moved into the chamber. This takes place as the bolt goes forward under pressure of the expanding operating rod spring. The bolt picks up the top round in the magazine and drives it forward into the chamber (fig. 38). Chambering is complete when the extractor snaps into the extracting groove on the cartridge and the ejector is forced into the face of the bolt.
- (3) *Locking.* Locking occurs when the bolt is fully closed. This prevents the loss of gas pressure until the bullet has left the muzzle. The bolt is locked by the rear camming surface in the hump of the operating rod forcing the bolt roller down. This engages the locking lugs on the bolt with the locking recesses in the receiver (fig. 39).
- (4) *Firing.* Firing occurs when the firing pin strikes the primer. When the trigger is pressed, the trigger lugs are disengaged from the hammer hooks and the hammer is released. The hammer moves forward under pressure of the hammer spring and strikes the tang of the firing pin, driving the firing pin against the primer, activating it and firing the round (fig. 40).
- (5) *Unlocking.* Unlocking occurs after the firing of the round. As the bullet is forced through the barrel by the expanding gases, a small amount of gas enters through the gas port into the hollow gas piston and the inside of the gas cylinder plug. The gas inside the piston and plug expands and, when it builds up enough pressure to overcome the tension of the operating rod spring, the piston starts its rearward movement, driving the operating rod and bolt with it. When the piston has traveled slightly less than 5 thirty-seconds of an inch,

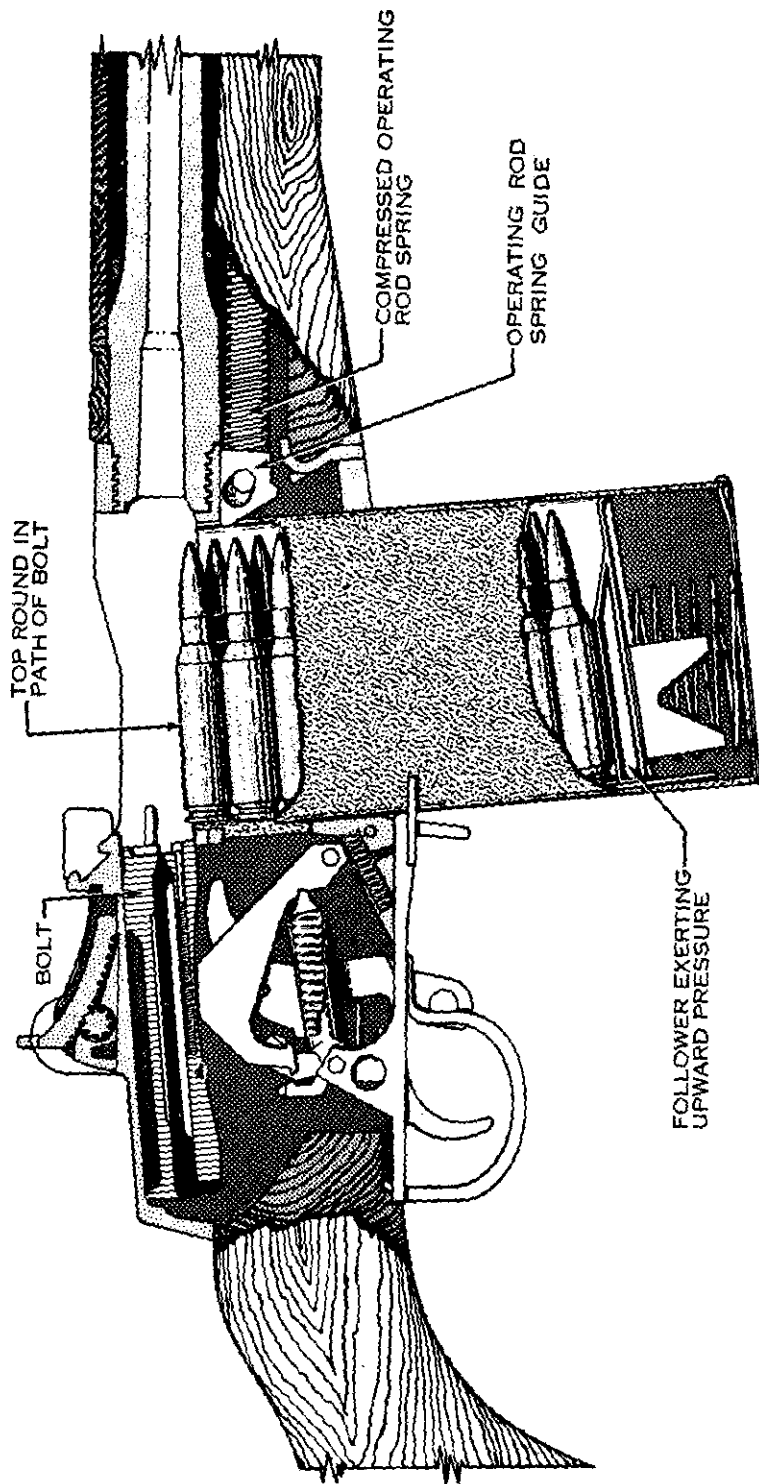

Figure 37. Position of parts when the bolt is to the rear.

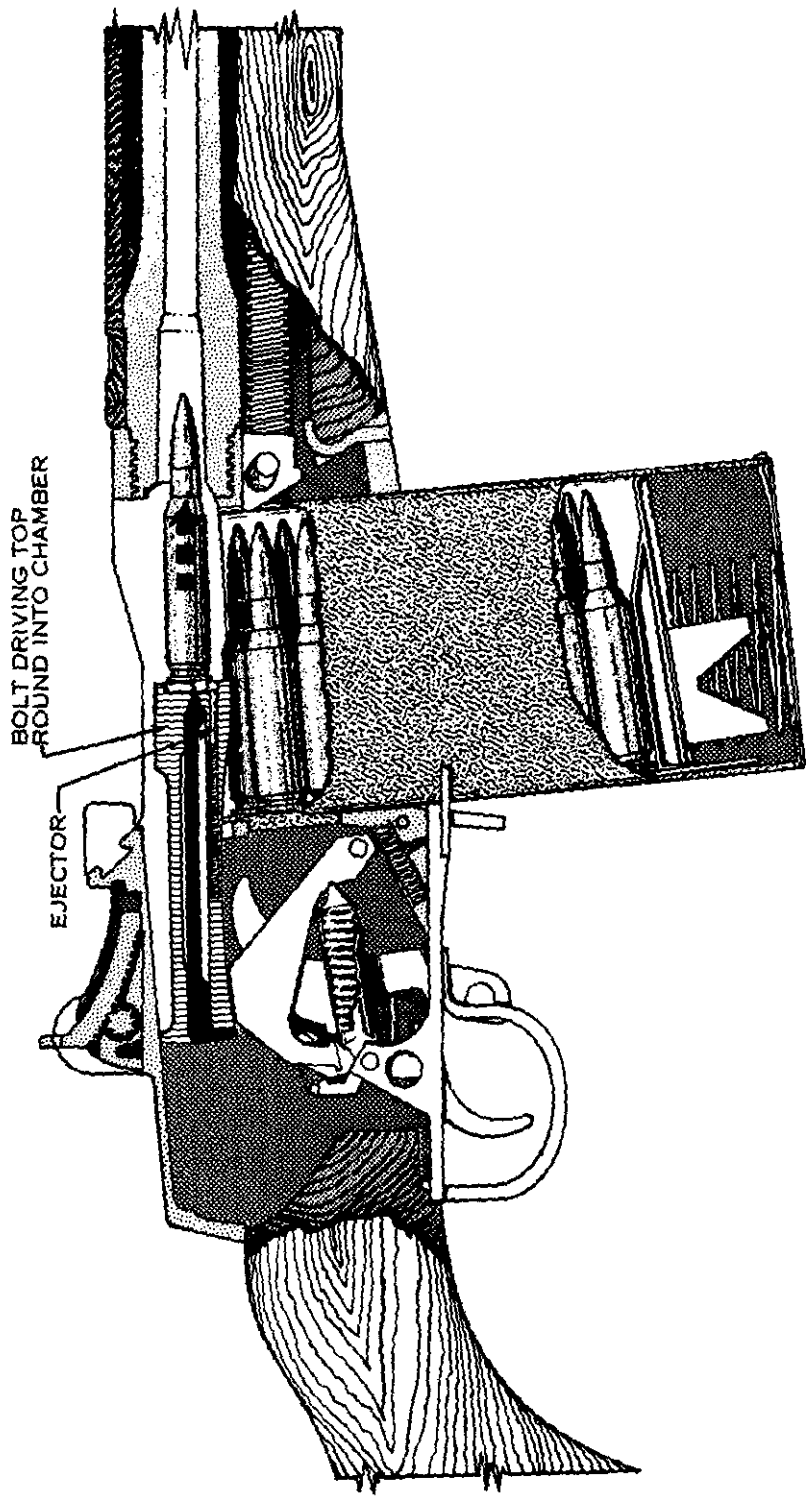

Figure 38. Chambering.

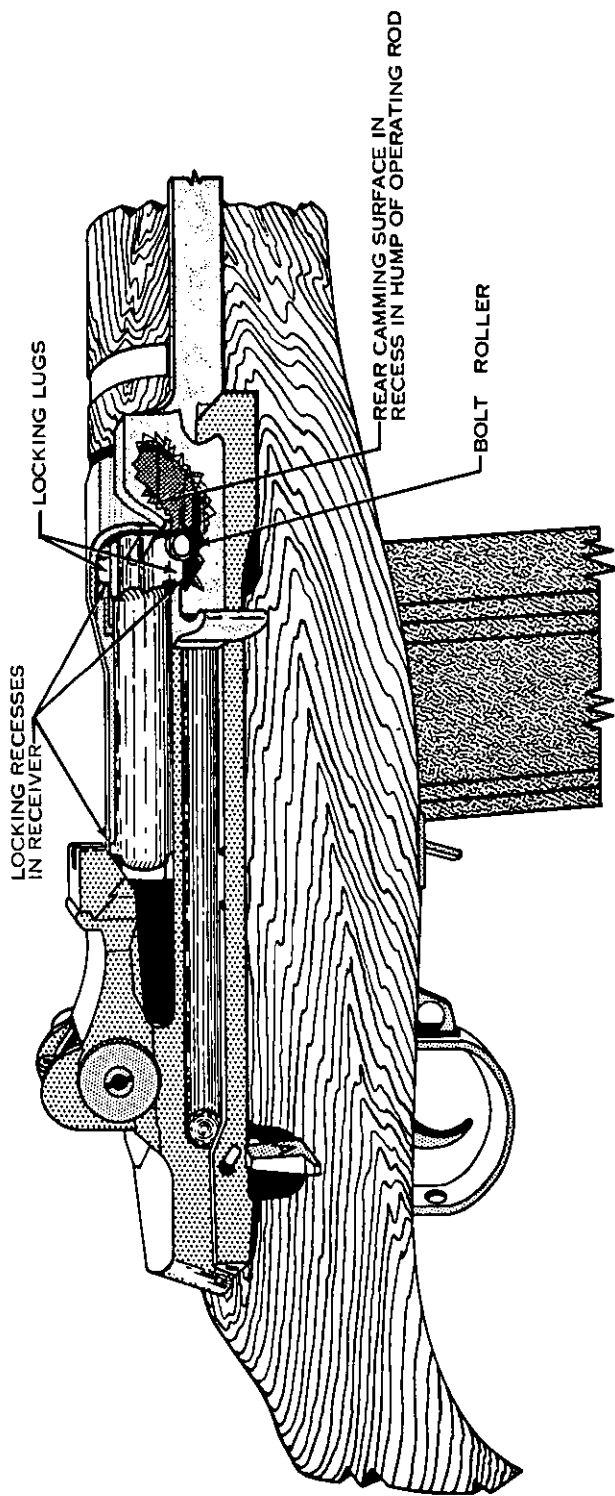

Figure 39. Locking.

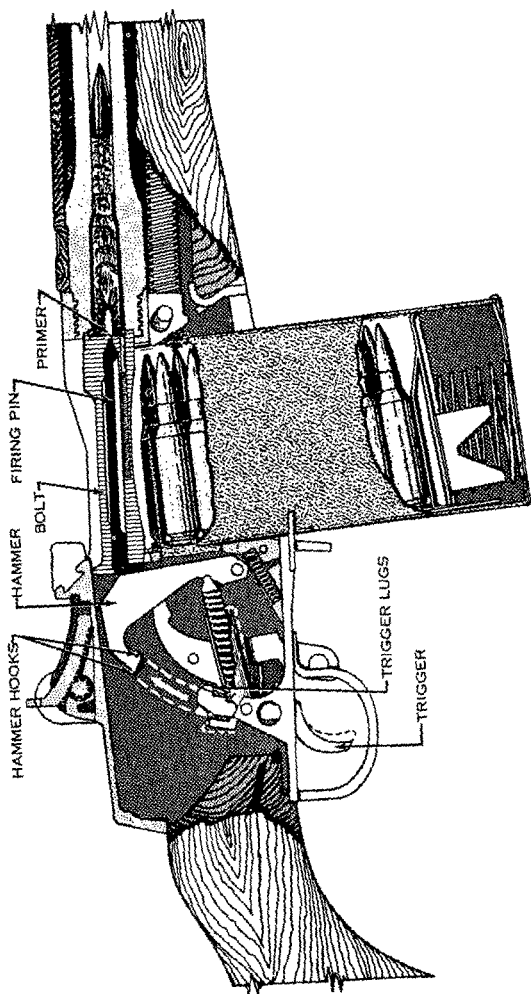

Figure 40. Firing.

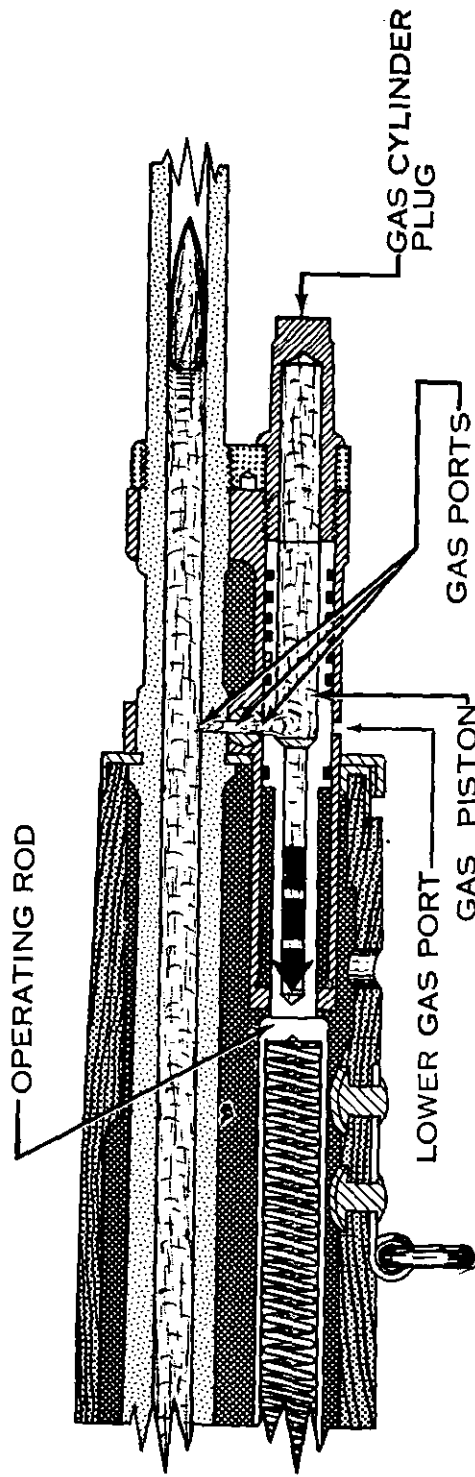

Figure 41. Action of the gas.

the gas ports are no longer alined and no more gas can enter the piston (fig. 41). The remaining gas in the barrel follows the bullet out of the muzzle. There is about three-eighths of an inch rearward movement of the operating rod before unlocking begins. This is a safety feature to insure that all the unneeded gas has gone out the barrel before unlocking begins. After the operating rod has moved this short distance, the camming surface inside its hump forces the bolt roller upward, disengaging the locking lugs on the bolt from the locking recesses in the receiver. The bolt is thus unlocked and ready to be moved to the rear (fig. 42). Any gas that is left in the gas cylinder or piston after the bolt is all the way to the rear escapes through the lower gas port in the cylinder.

- (6) *Extracting.* Extracting is pulling the empty cartridge from the chamber. As the bolt unlocks, slow initial extraction takes place. When the bolt is moved to the rear, it pulls the empty cartridge with it (fig. 43).
- (7) *Ejecting.* Ejecting is throwing the empty cartridge out of and away from the receiver. As soon as the bolt has withdrawn the empty cartridge case clear of the chamber, the force of the ejector spring and plunger pushes the bottom edge of the cartridge base away from the bolt face. This causes the front (neck) of the cartridge case to move upwards and to the right. The rapid rearward movement of the bolt causes the cartridge case to strike the angle on the lower right corner of the magazine charger guide as the cartridge case is turned sideways. The rapid forward movement of the operating rod handle causes the leading edge of the "camming hump" to strike the cartridge case with the angle on the outer edge of this "hump" continuing the movement of the empty case to the right front. When the last round has been fired and the bolt is held in the rearward position by the bolt lock, the ejector propels the last round out and away from the receiver (fig. 44).
- (8) *Cocking.* Cocking occurs when the hammer is forced into the proper position for firing the next round. This happens as the bolt continues to the rear. The rear end of the bolt forces the hammer back and rides over it. The hammer is caught by the sear if the trigger is still held to the rear, but by the trigger lugs if the trigger pressure has been released (fig. 44).

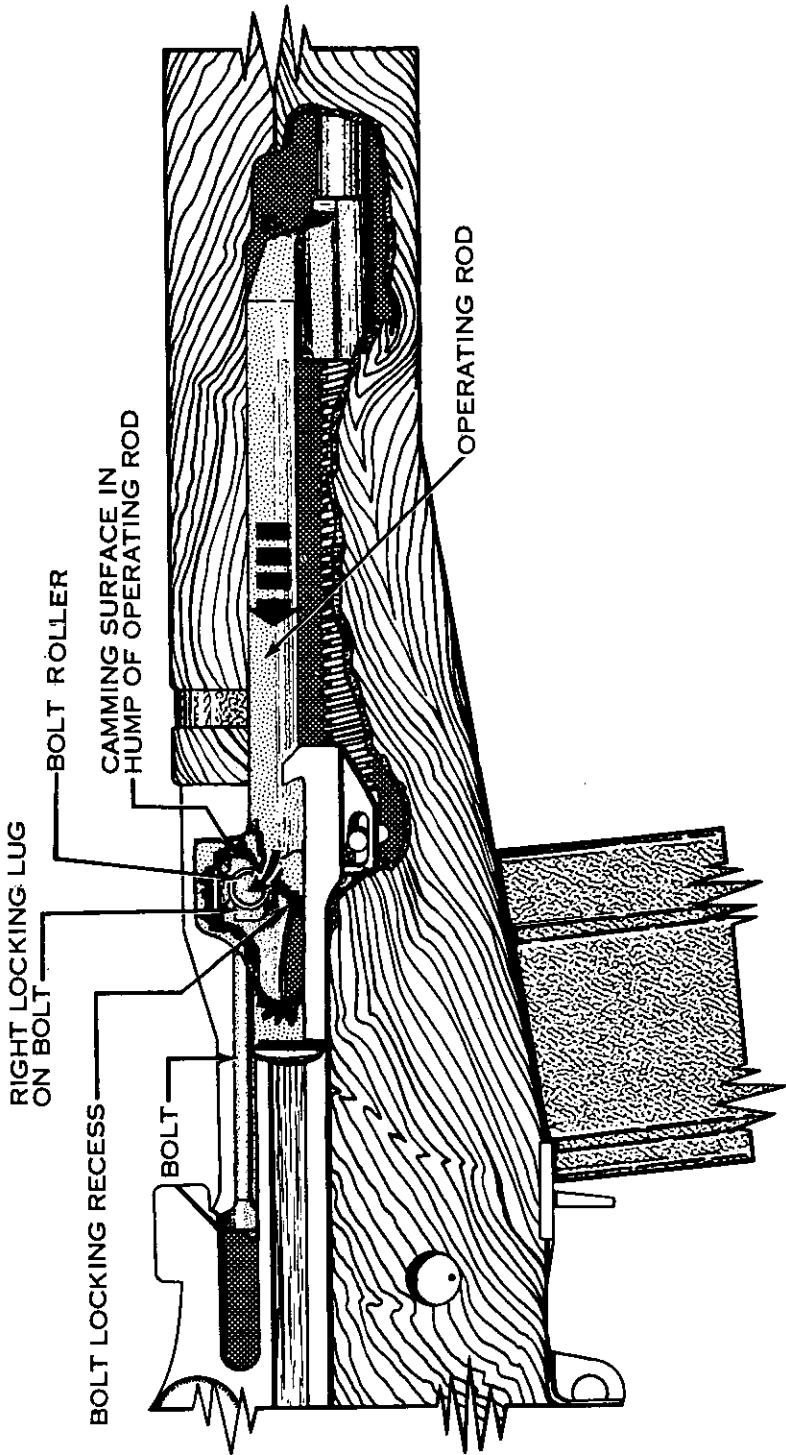

Figure 42. Unlocking.

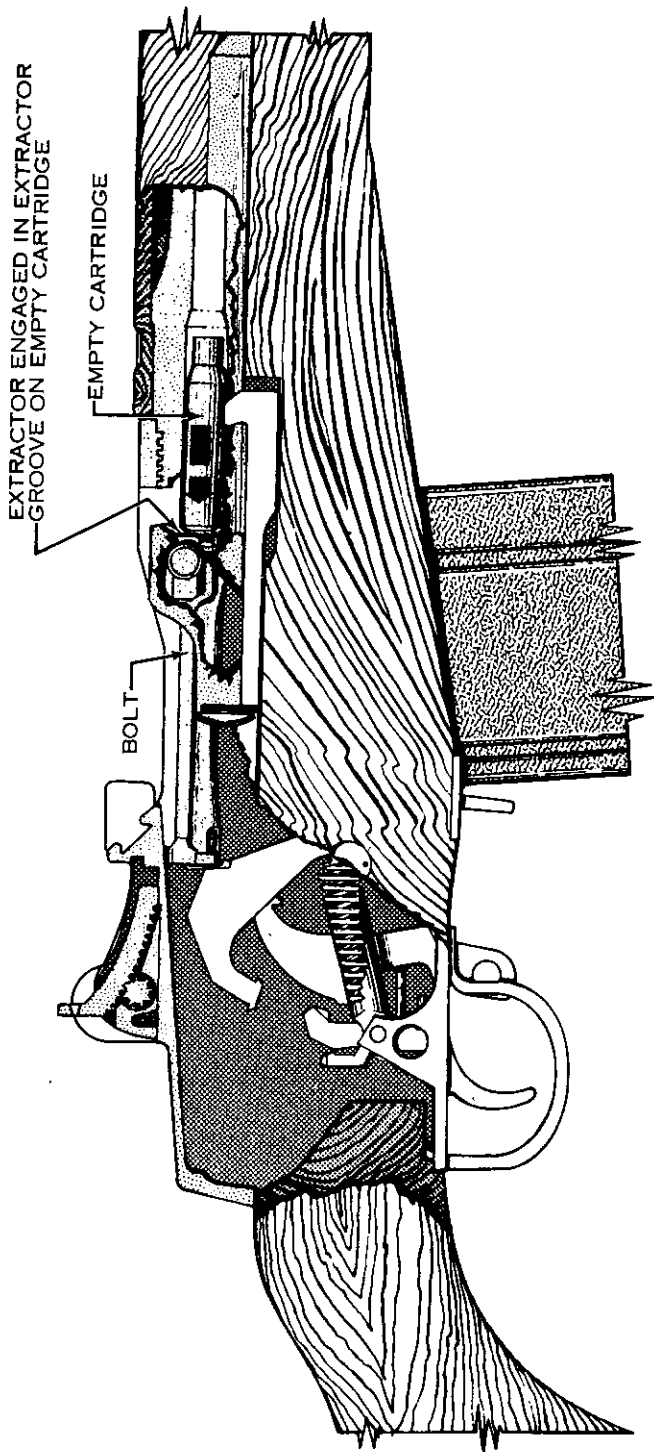

Figure 43. Extracting.

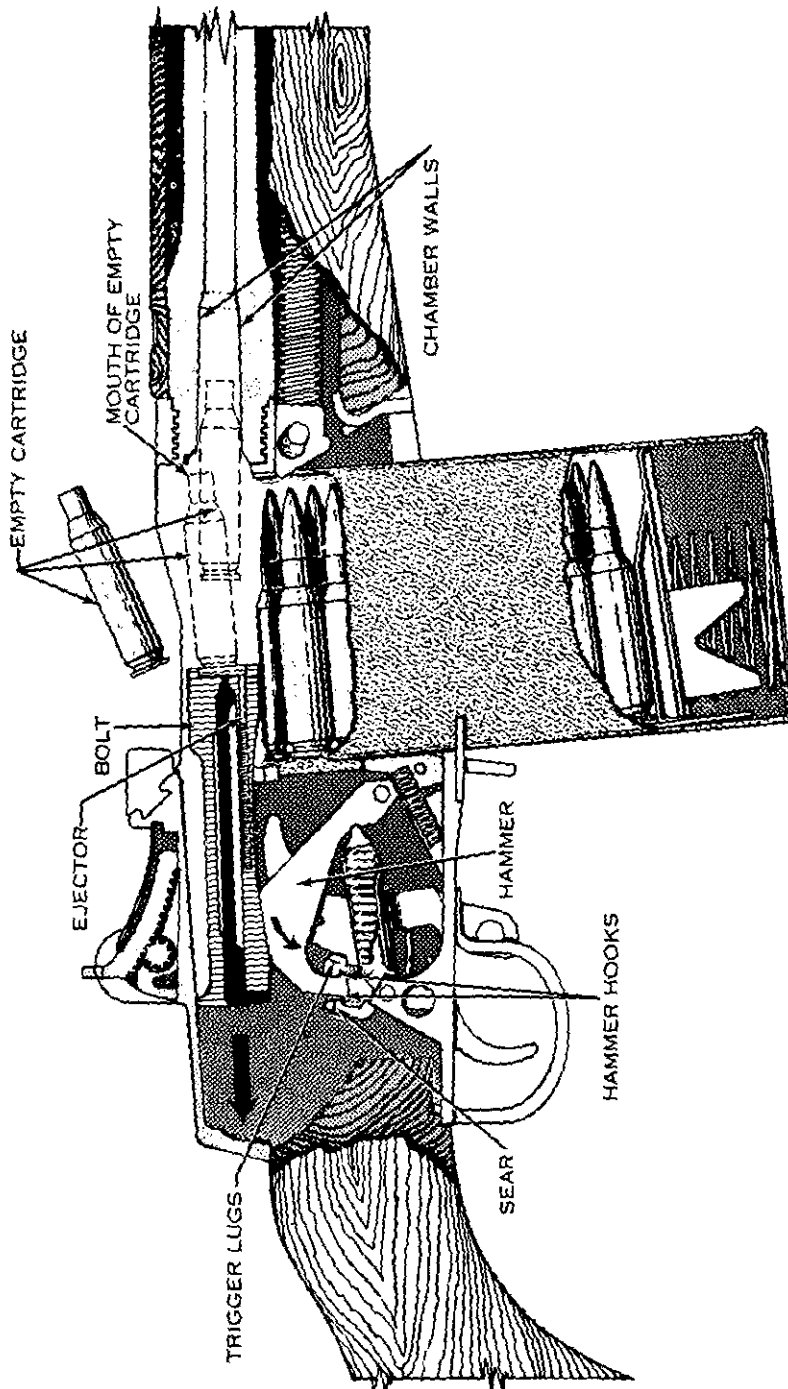

Figure 44. Ejecting and cocking.

28. Automatic

a. The selector must be set for automatic fire (the A facing the firer). Turning the selector to automatic rotates the sear release until it is in a position to make contact with the sear.

b. After the first round has been fired (and with the trigger held to the rear), the operating rod starts its rearward movement under pressure of the expanding gases. As it moves to the rear, the connector assembly moves rearward one-eighth of an inch under pressure of the connector assembly spring. The movement of the connector assembly rotates the sear release on the selector shaft so that the flange on the sear release allows the sear to move forward into a position where it can engage the rear hammer hooks (fig. 45). Then, when the bolt drives the hammer to the rear, the sear engages the rear hammer hooks and holds the hammer in the cocked position.

c. After the bolt moves forward and locks, the shoulder on the operating rod engages the hook of the connector assembly and forces it forward one-eighth of an inch. This rotates the sear release on the selector shaft, causing the flange on the sear release to push the sear to the rear, disengaging it from the rear hammer hooks (fig. 46). The hammer will then go forward if the trigger

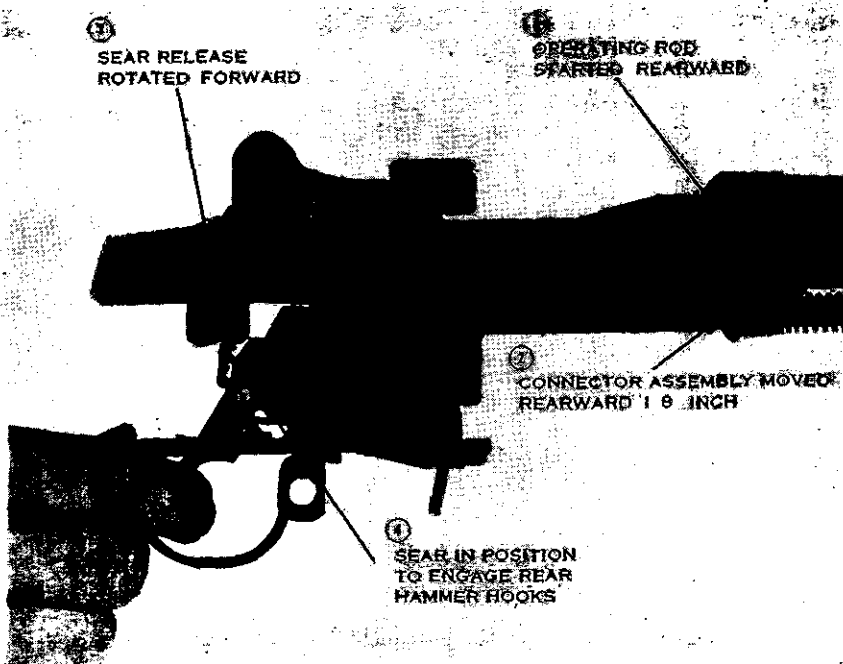

Figure 45. Effects of rearward movement of connector assembly.

is held to the rear. If the trigger is released at any time prior to the firing of the last round, the hammer will be held in the cocked position by the trigger lugs, and automatic actuation of the sear release by the connector assembly will not release the hammer to fire the chambered cartridge.

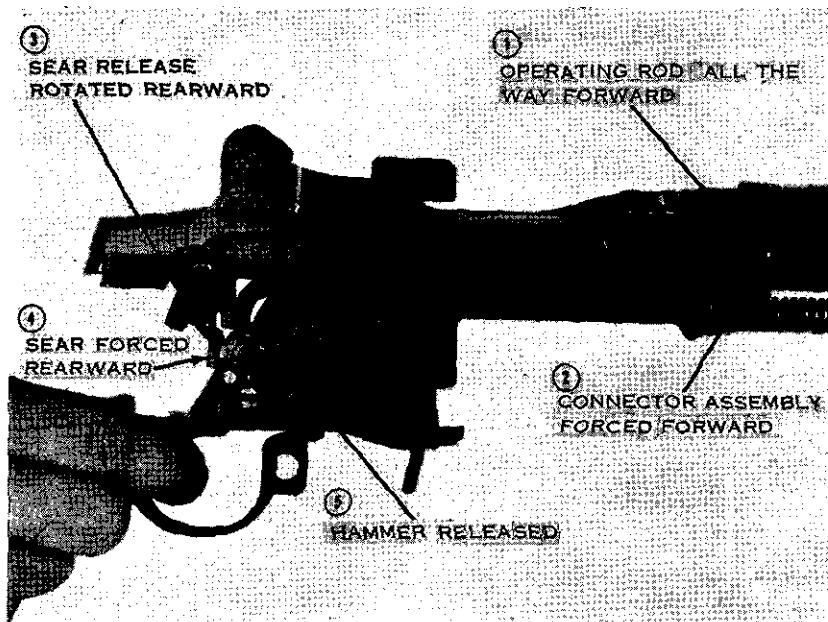

Figure 46. Effects of forward movement of connector assembly.

CHAPTER 4

STOPPAGES AND IMMEDIATE ACTION

29. Stoppage

a. A stoppage is any unintentional interruption in the cycle of operation. It may be caused by faulty ammunition, a faulty magazine, or by improper functioning of the rifle (a malfunction). When a stoppage occurs, the firer immediately takes certain steps to reduce it without considering the cause. This is known as immediate action.

b. The M14 rifle will function efficiently if it is properly cared for. Most stoppages occur because of dirty, worn, or broken parts. The firer must watch for these defects and correct them *before* they cause a stoppage. Some of the more common stoppages, their usual causes, and remedies are shown in chart 2.

30. Immediate Action

Many stoppages can be prevented before they occur if the rifle, magazine, and ammunition are cared for properly. Some stoppages may still occur, but a knowledge of immediate action will enable the firer to take the necessary steps to reduce them. Immediate action is taught in two phases.

a. The first phase is taught as a drill so that the rifleman learns to perform it quickly and instinctively without thought as to the cause of the stoppage. To apply the first phase, pull the operating rod handle all the way to the rear with the right hand, palm up, then release it. Next, aim the rifle and attempt to fire.

b. If the first phase of immediate action fails to reduce a stoppage, make a detailed examination of the rifle to determine the cause. The five key words used to help you remember the steps in the second phase are: TAKE, LOOK, PULL, LOCATE, and REDUCE.

Chart 2. Stoppages: Their Causes and Remedies

Stoppages	Cause	Remedy
Failure to feed-----	Lack of lubrication of operating parts. Defective or worn parts.	Clean and lubricate parts. Replace parts.

Chart 2. Stoppages: Their Causes and Remedies—Continued.

Stoppages	Cause	Remedy
Failure to feed— Continued	Dirty or dented magazine.	Replace magazine.
Failure to chamber----	Loose gas cylinder plug.	Tighten plug.
	Lack of lubrication of operating parts.	Clean and lubricate parts.
Failure to lock-----	Defective ammunition.	Replace ammunition.
	Dirty chamber-----	Clean chamber.
	Lack of lubrication of operating parts.	Clean and lubricate parts.
	Dirty locking recesses.	Clean recesses.
Failure to fire-----	Weak operating rod spring.	Replace spring.
	Spindle valve closed---	Open valve.
	Defective ammunition---	Replace ammunition.
	Broken firing pin-----	Replace firing pin.
	Defective or broken parts in firing mechanism assembly.	Replace parts or entire firing mechanism assembly.
Failure to unlock-----	Dirty chamber-----	Clean chamber.
	Lack of lubrication of operating parts.	Clean and lubricate parts.
	Insufficient gas-----	Tighten gas cylinder plugs.
Failure to extract-----	Dirty chamber-----	Clean chamber.
	Dirty ammunition-----	Replace ammunition.
	Broken extractor-----	Replace extractor.
Failure to eject-----	Broken ejector or weak ejector spring.	Replace faulty part.
Failure to cock-----	Defective or broken parts in firing mechanism assembly.	Replace parts or entire firing mechanism assembly.

- (1) TAKE the rifle from your shoulder.
- (2) LOOK in the receiver.
- (3) PULL the operating rod handle slowly to the rear.
- (4) LOCATE the stoppage by observing, as you pull the operating rod handle to the rear, what is in the chamber, and what has been ejected.
- (5) REDUCE the stoppage and continue to fire.

c. Hangfires and misfires will occur rarely. Normally, the firer will instinctively apply immediate action which in most instances reduces the stoppage even when caused by a hangfire or misfire. If it is determined that there is a hangfire or misfire, follow this procedure.

- (1) Remove the magazine.
- (2) Place the safety in the safe position.
- (3) Wait 10 seconds.
- (4) Apply immediate action as stated in *b* above.

d. The normal cause of a misfire is faulty ammunition. Therefore, further use of ammunition from that lot should be suspended and reported to ordnance for withdrawal and replacement.

CHAPTER 5

MAINTENANCE

31. General

Maintenance includes all measures taken to keep the rifle in top operating condition. This includes normal cleaning, inspection for defective parts, repair, and lubrication.

32. Cleaning Materials, Lubricants, and Equipment

a. Cleaning Materials.

- (1) Bore cleaner is used for cleaning the bore, chamber, and gas cylinder. It also provides temporary protection from rust.
- (2) Hot, soapy water or plain hot water is a substitute for bore cleaner.
- (3) Dry-cleaning solvent is used for cleaning rifles which are coated with grease, oil, or corrosion-preventive compounds.

b. Lubricants.

- (1) Special preservative lubricating oil is used for lubricating the rifle at normal and low temperatures.
- (2) Medium preservative lubricating oil is used instead of special preservative oil when the rifle is exposed to high temperature, high humidity, or salt water.
- (3) SAE 10 engine oil or castor oil may be used as a field expedient under combat conditions when the oils prescribed in (1) and (2) above cannot be obtained. However, as soon as possible the weapon should be cleaned and lubricated with the proper, authorized lubricants.
- (4) "Lubriplate" rifle grease should be applied to working surfaces in extremely humid weather or whenever there is a likelihood that the rifle will be subjected to immersion in either fresh or salt water. After immersion the weapon should be cleaned and lubricated as described in paragraphs 33 and 35b.

c. Preservatives. A medium corrosion-preventive compound is used to protect the metal parts of the rifle during storage, and

raw linseed oil is applied to the wooden parts to prevent their drying.

d. Equipment.

- (1) A complete set of maintenance equipment (fig. 47) is composed of—
 - (a) Combination tool.
 - (b) Chamber cleaning brush.
 - (c) Oiler case.
 - (d) Grease container.
 - (e) Cleaning rod case w/spacer.
 - (f) 4-section cleaning rod.
 - (g) Patch holder.
 - (h) Rifle bore brush.
- (2) (a) The combination tool can be used as either a 20° offset screwdriver or as a gas plug wrench (figs. 48 and 49). The wrench head is stowed in the handle of the combination tool which is fitted with a plastic cap. The cap serves as a protection for the hand. To assemble the combination tool, make sure that the flat surface on the wrench mates with the rivet in the handle. Insert the wrench head into the handle until the retaining ring makes contact, then firmly push the wrench head in until it is fully seated. The

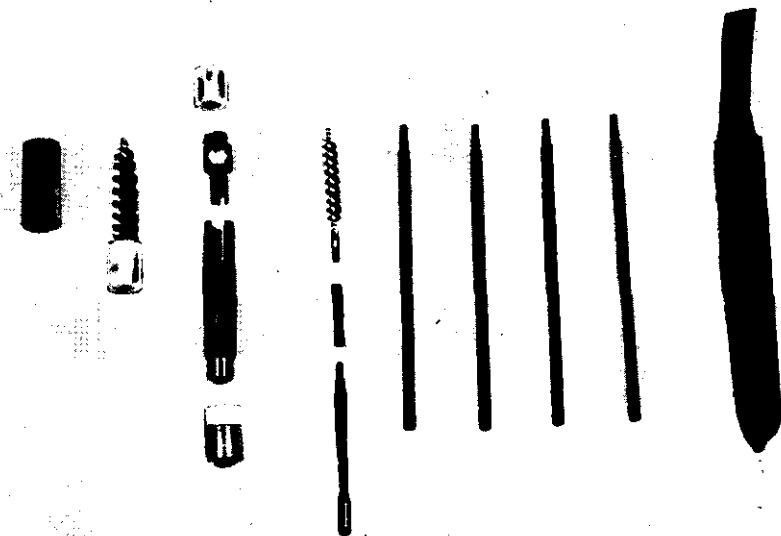

Figure 47. Maintenance equipment.

screwdriver blade is an extension of the wrench head. Although the tool may be used without the cap, it is better to use it to prevent the slotted end of the handle from digging into the palm of the hand.

- (b) The handle of the combination tool is also used as the cleaning rod handle. To do this, allow the cleaning rod extension of the tool to fall from the tool handle so that it hangs perpendicular. Assemble the four sections of the cleaning rod and screw into the threaded hole in the cleaning rod extension. Either the bore brush or the cleaning patch holder may be attached to the end of the cleaning rod.
- (c) The plastic oiler case (fig. 50) holds about 7 cubic centimeters of oil. The case is closed with a screw cap which has a stem (applicator) attached that is used to apply oil drop by drop. The cap is fitted with a gasket to prevent oil leakage.
- (d) The grease container (fig. 51) is also a plastic unit. It consists of a standard grease cup with a cap. One end of the grease cup cap screws onto the grease cup. The other end fits over the end of the handle of the combination tool (fig. 47) for storage. Inside the cap is a bent stem (applicator) that is used to apply the grease. The stem is bent to make it easier to



Figure 48. Combination tool used as offset screwdriver.



Figure 49. Combination tool used as wrench.

remove the last bit of grease from the cup. The container holds about 3 cubic centimeters of grease. Maintenance equipment is stored in the butt stock (fig. 52).

33. Cleaning the Rifle

a. The rifle must be cleaned after it has been fired because firing produces deposits of primer fouling, powder ashes, carbon, and metal fouling. The ammunition has a noncorrosive primer which makes cleaning easier, but no less important. The primer still leaves a deposit that may collect moisture and promote rust if it is not removed. The cleaning described below will remove all deposits except metal fouling which is relatively uncommon and is removed by ordnance personnel.

b. The rifle should be field stripped and cleaned in the following manner after it has been fired:

- (1) *Bore.* Run patches dampened with bore cleaner or hot, soapy water back and forth through the bore several times. Next, attach the rifle bore brush to the cleaning rod and run it back and forth through the bore one or two times. Follow this with more wet patches. Run several dry patches through the bore and inspect each



Figure 50. Oiler case (in right hand), cap and stem (in left hand).

patch as it is removed. The bore is clean when a dry patch comes out clean with no evidence of fouling. Finally, run an oily patch through the bore to leave a light coat of oil inside the barrel.

Note. The patch or brush must be pushed all the way through the bore before it is withdrawn.

- (2) *Chamber.* Screw one cleaning rod section into a threaded hole of the chamber cleaning brush until bottomed, being careful not to cross threads.

Caution: DO NOT SCREW THE ROD SECTION IN TIGHT.

Note. There are four threaded holes in the brush unit. Do not use a hole whose threads have been stripped. When all four holes are stripped, get a new chamber cleaning brush.

- (a) Place the brush into chamber and allow the bolt to close against it. Push the operating rod forward until the brush is fully seated. Using the rod section as a handle, turn the brush back and forth sev-



Figure 51. Grease container (in right hand), cap and stem (in left hand).

eral times (clockwise and counterclockwise) about 100° (fig. 53).

- (b) To remove the brush from the chamber, grip the rod as shown in figure 54 as close to the bolt as possible (without gripping the operating rod handle). With the bolt remaining against the brush, pull the unit rearward sharply until the brush clears the chamber. Lock the bolt in the rearmost position and remove the brush.
- (c) To wipe the chamber free of oil, wrap a cleaning patch around the brush, insert it in the chamber, and

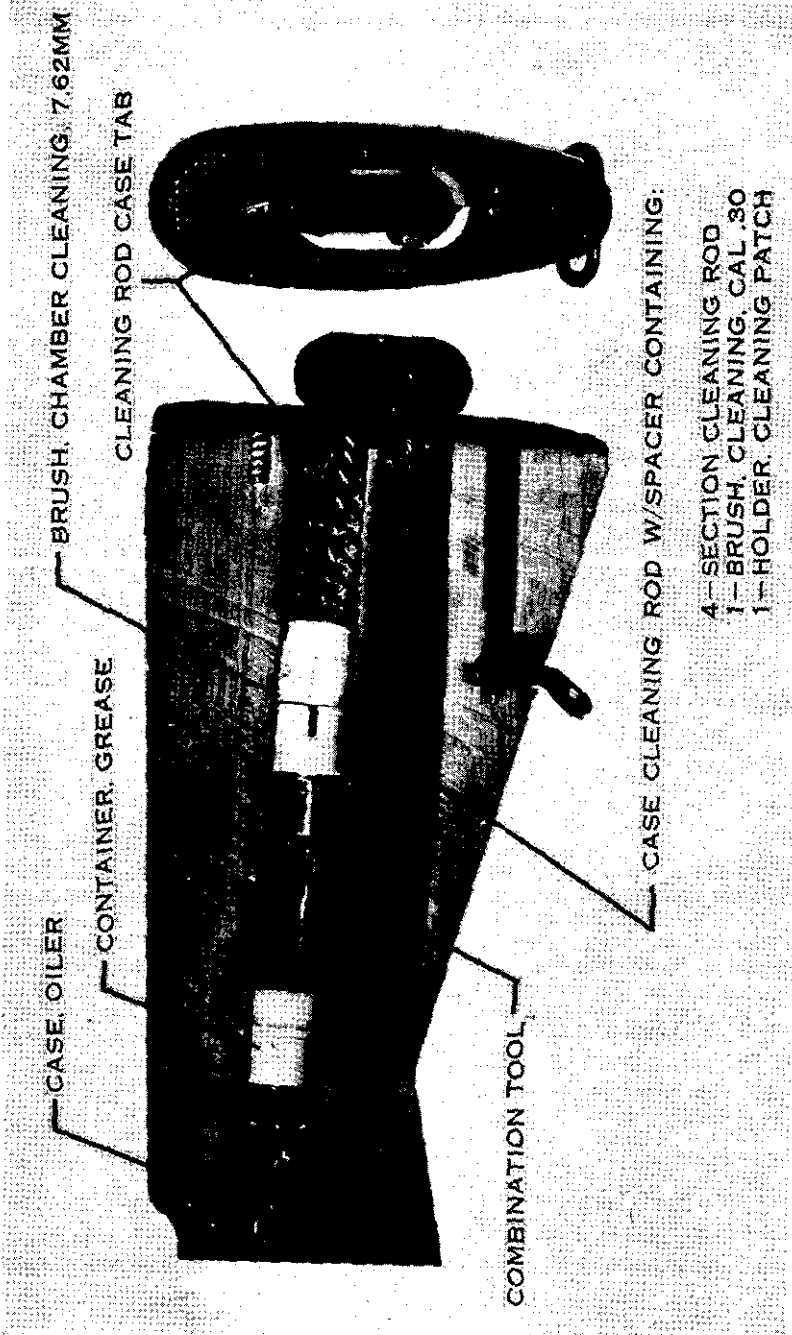

Figure 52. Storage of accessories in butt stock.

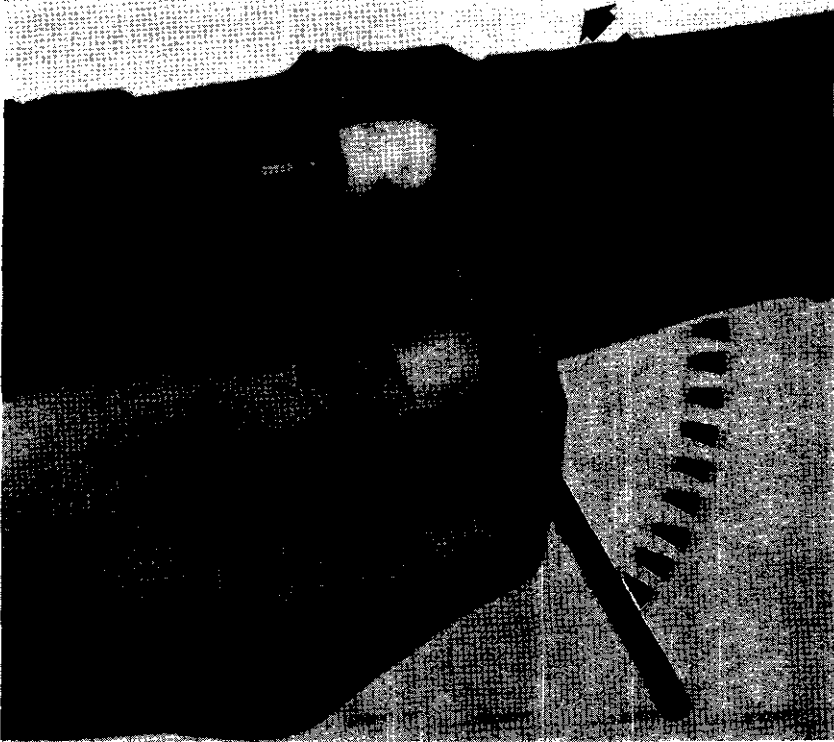

Figure 53. Rotating brush to clean chamber.

turn it back and forth several times as described in (a) above.

- (3) *Gas cylinder plug.* Pour a small quantity of bore cleaner in the plug, insert the bore cleaning brush and rotate it. Remove the brush, clean and dry the plug with patches.
- (4) *Gas cylinder.* Install the patch holder on a section of the cleaning rod. Put two patches in the holder, moisten them with bore cleaner and swab the cylinder bore. Dry the cylinder bore with clean patches. *Use no abrasives in cleaning the cylinder and do not oil the interior surfaces.* The cylinder is made of corrosion resistant steel and will not rust.
- (5) *Gas piston.* Saturate patches with bore cleaner and wipe the exterior surface of the piston as clean as possible. Install the bore cleaning brush on a section of the cleaning rod. Moisten the brush with bore cleaner and clean the interior of the piston. Wipe the piston dry, *but do not oil.* The piston is made of corrosion resistant

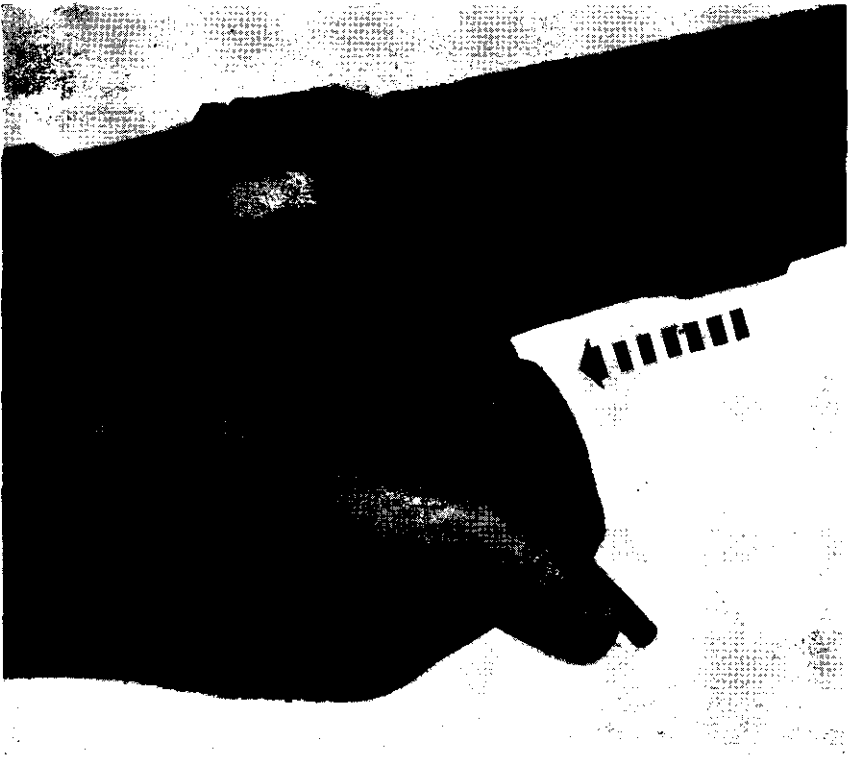

Figure 54. Removing brush from chamber.

steel and will not rust. The gas system incorporates a self-cleaning section and functions within very close tolerances. A piston does not have to be shiny to function properly. *Do not use abrasives to clean the piston.*

- (6) *Face of the bolt.* Clean the face of the bolt with a patch and bore cleaner. Remove the bore cleaner with dry patches and oil the part lightly.
- (7) *Magazine.* Inspect the interior of the magazine by depressing the follower with the thumb. If the interior is dirty, disassemble the magazine and clean it, then lightly oil the component parts. Otherwise, merely wipe the magazine assembly clean and dry, then oil it.
- (8) *Spindle valve.* Depress the valve and rotate it several times after each day's firing. Do not disassemble it.
- (9) *All other parts.* Use a bristle brush and a dry cloth to remove all dirt or sand from other parts and exterior surfaces. Apply a light coat of oil to the metal parts and rub raw linseed oil into the wooden parts. Care

must be taken to prevent linseed oil from getting on metal parts, or these parts will become sticky or gummy.

c. The rifle must be cleaned no later than the evening of the day it is fired. For three consecutive days thereafter check for evidence of fouling by running a clean patch through the bore and inspecting it. The bore should then be lightly oiled.

34. Normal Maintenance

a. The rifle should be inspected daily for evidence of rust and general appearance. A light coat of oil should be maintained on all metal parts, except the gas piston, interior of the gas cylinder, and the gas plug.

b. The daily inspection should also reveal any defects such as burred, worn, or cracked parts. Defects should be reported to the armorer for correction.

c. A muzzle plug should never be used on the rifle. It causes moisture to collect in the bore which causes the bore to rust.

35. Special Maintenance

a. Before firing the rifle, the bore and the chamber should be cleaned and dried. A light coat of oil should be placed on all other metal parts except those which come in contact with ammunition (and except the gas piston, interior of the gas cylinder, and the gas plug).

b. Rifle grease should be applied before firing to the parts indicated in figure 55. This is particularly important when the rifle is exposed to rain or salt water. A small amount of grease is taken up on the stem of the grease container cap and is applied at each place. Rifle grease is *not* used in extremely cold temperatures or when the rifle is exposed to extremes of sand and dust (*c* and *e* below).

c. In cold climates (temperatures below freezing) the rifle must be kept free of moisture and excess oil. Moisture and excess oil on the working parts cause them to operate sluggishly or fail completely. The rifle must be disassembled and wiped with a clean dry cloth. Dry cleaning solvent may be used if necessary to remove oil or grease. Parts that show signs of wear may be wiped with a patch lightly dampened with special preservative lubricating oil. It is best to keep the rifle as close as possible to outside temperatures at all times to prevent the collection of moisture which occurs when cold metal comes in contact with warm air. If the rifle is brought into a warm room, it should

CAMMING SURFACES IN
HUMP OF OPERATING ROD

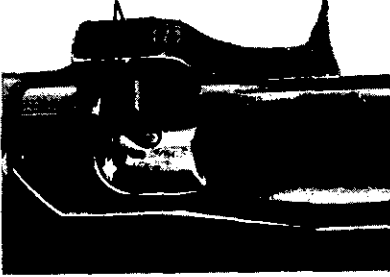

LOCKING RECESSES

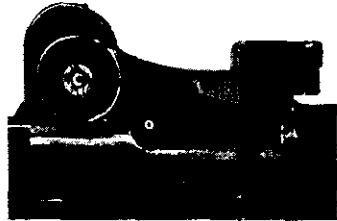
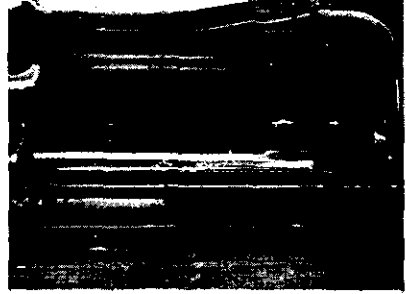

BOLT
CAMMING LUG

LIP OF
RECEIVER

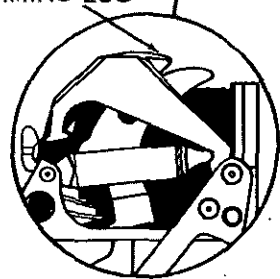
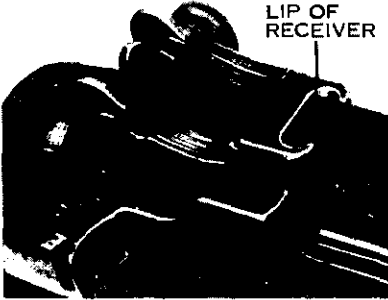

Figure 55. Points to apply rifle grease.

be allowed to reach room temperature so that condensation will appear before the weapon is cleaned.

d. In hot, humid climates the rifle must be inspected thoroughly each day for signs of moisture and rust. It should be kept lightly oiled with special preservative lubricating oil or, if it is exposed to salt water or salt water atmosphere, with medium preservative lubricating oil. If the rifle is to be fired under these conditions, rifle grease should be applied to the points shown in figure 55. Raw linseed oil should be frequently applied to the wooden parts to keep out moisture and prevent swelling.

e. In hot, dry climates, the rifle must be cleaned daily or more often to remove sand and/or dust from the bore and working parts. In sandy areas, the rifle should be kept dry to prevent the collection of sand. The muzzle and receiver should be kept

covered during sand and dust storms. Wooden parts must be kept oiled with raw linseed oil to prevent drying. The rifle should be relubricated when sandy or dusty conditions decrease or when it begins to show rust.

f. Special instructions on caring for the rifle when it is subject to nuclear, biological, or chemical contamination may be found in FM 21-40.

36. Storage

a. *Preparation for Storage.* Thoroughly clean and then completely dry the bore, all parts of the mechanism, and the exterior of the weapon. In damp climates, make sure that the rags used for cleaning are dry. After metal parts have been dried, be careful not to touch them with the bare hands. Coat them with either medium preservative lubricating oil or, if the weapon is to remain in storage for a very long time, medium rust preventive compound. Before placing the rifle in the packing chest, paint the weapon supports for the butt and muzzle with rust preventive compound. Never store a rifle in a cloth or similar cover and never plug the bore. Such articles collect moisture that causes the rifle to rust.

b. *Cleaning When Rifles Have Been in Long-Term Storage.* Weapons received from long-term storage usually have a coat of light or medium preservative oil and are inclosed in a volatile corrosion inhibitor (VCI) type, sealed aluminum foil, barrier type bag. These weapons can be fired as soon as the VCI tube is removed from the bore, but they should normally be cleaned and lubricated as prescribed in paragraphs 33-35.

CHAPTER 6

AMMUNITION

37. General

The M14 rifle fires several types of ammunition. The rifleman should be able to recognize them and know which type is best for certain targets. He should also know how to care for the ammunition.

a. Figure 56 shows the parts of a typical cartridge.

b. The term "bullet" refers only to a small arms projectile; the term "ball" was originally used to describe the ball-shaped bullet of very early small arms ammunition. The term "ball ammunition" now refers to a cartridge with a general purpose solid core bullet intended for use against personnel and material targets.

38. Description

The four types of ammunition are easily identified by their individual markings.

a. Ball. The M59 ball cartridge has a boat-tailed bullet (the rear of the bullet is tapered) and weighs 147 grains. It is composed of a gilding metal jacket, a soft steel core, a lead antimony base, and a point filler. The tip of the bullet is not colored.

b. Armor Piercing. The M61 armor piercing cartridge has a boat-tailed bullet, weighs 147 grains, and is composed of a gilding metal-clad jacket, a hardened steel core, a lead antimony base, and a point filler. The tip of the round is painted black.

c. Tracer. The M62 tracer cartridge has a boat-tailed bullet and weighs 141 grains. It is composed of a gilding metal or gilding metal-clad steel jacket, a lead antimony core, a tracer, sub-igniter and igniter composition, and a closure cap. The tip of the round is painted orange.

d. Dummy. The M63 dummy cartridge is identifiable by the six longitudinal flutes in the case.

39. Ballistic Data

The approximate maximum range and average muzzle velocity of the ammunition are shown below.

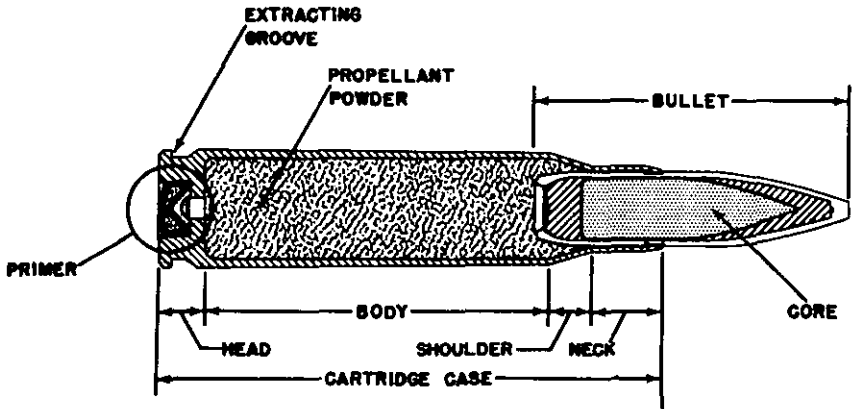

Figure 56. Parts of a cartridge.

Cartridge	Max range (meters)	Average muzzle velocity (meters per second)
M-59 Ball	3,750	853
M-61 Armor Piercing	2,900	844
M-62 Tracer	3,100	838

40. Packaging

a. *5-Round Magazine Charger.* Ammunition is prepacked in 5-round magazine chargers. Twelve chargers are packed in a cloth bandoleer.

b. *Magazine Filler.* The magazine filler is an adapter which fits over the top of an empty magazine (when the magazine is not in the weapon) and makes it easier to load. One magazine filler is packed in each case of ammunition.

41. Care, Handling, and Preservation

The ammunition is not dangerous to handle, but there is a correct way to handle it.

a. Take care to prevent ammunition boxes from becoming broken or damaged.

b. Protect ammunition from mud, sand, and water. If it gets dirty, wipe it off. Light corrosion should be wiped off as soon as it is discovered.

c. Do not expose ammunition to the direct rays of the sun. If the powder is heated, excessive pressure may develop. This condition will affect ammunition performance.

d. Do not grease or oil ammunition; dust and other abrasives that collect on greasy ammunition damage the operating parts of the rifle.

42. Storage

Small arms ammunition is not an explosive hazard, but under poor storage conditions it may become a fire hazard. It should be stored away from radiators, hot water pipes, and other sources of heat.

APPENDIX REFERENCES

- AR 320-5 Dictionary of United States Army Terms.
AR 320-50 Authorized Abbreviations and Brevity Codes.
FM 21-5 Military Training.
FM 21-6 Techniques of Military Instruction.
FM 21-30 Military Symbols.
FM 21-40 Small Unit Procedures in Atomic, Biological,
and Chemical Warfare.
FM 23-5 U.S. Rifle, Caliber .30, M1.
FM 23-71 Rifle Marksmanship Course, TRAINFIRE I.
DA Pam 108-1 Index of Army Motion Pictures, Film Strips,
Slides, and Phono-Recordings.

By Order of *Wilber M. Brucker*, Secretary of the Army:

L. L. LEMNITZER,
General, United States Army,
Chief of Staff.

Official:

R. V. LEE,
Major General, United States Army,
The Adjutant General.

Distribution:

Active Army:

Tech Stf, DA (1)	Sig Bn (3)
Tech Stf Bd (2)	Armor Bn (3)
USCONARC (25)	ADA Bn (3)
USA Arty Bd (2)	MP Bn (3)
USA Armor Bd (2)	Inf Co (5)
USA Inf Bd (2)	Armor Co (3)
USA AD Bd (2)	Cml Co (3)
USA Abn & Elet Bd (2)	Ord Co (3)
USA Avn Bd (2)	QM Co (3)
USATB (2)	MP Co (3)
US ARADCOM	USMA (30)
(Incl ea Rgn) (2)	PMST Sr Div Unit (2)
OS Maj Comd (10)	PMST Jr Div Unit (2)
OS Base Comd (5)	PMST Mil Sch Div Unit (2)
Log Comd (5)	Mil Msn (1)
MDW (5)	USATC (10) except
Armies (10) except	USATC (Inf) (25)
First US Army (12)	Svc Colleges (5)
Corps (5)	Br Svc Sch (5) except
Div (8) (ea CC) (3)	USAIS (1000)
Bde (3)	USAAMS (1200)
Engr Gp (3)	USAES (10)
Inf Bg (5)	USA Ord Sch (50)
Arty Gp (3)	USASCS (49)
Cml Bn (3)	Mil Dist (1)
Engr Bn (5)	Sector Comd (Res) (1)
Arty Bn (3)	USA Corps (Res) (1)
Ord Bn (3)	Units org under fol TOE:
QM Bn (3)	17-52 (3)

NG: State AG (3); units—none.

USAR: Units—same as Active Army except allowance is two (2) copies to each unit.

For explanation of abbreviations used, see AR 320-50.