

Resident Camping for Cub Scouting



Where "Let's Pretend" is Easy

CONTENTS

Purposes of Cub Scouting

Camping for Scouts—A Philosophy	1
Scouting's Outdoor Program— Ever-Increasing Challenge Out of Doors	2
What Is Camping for Tiger Cubs, Cub Scouts, Webelos Scouts, and Parents?.....	3
Why Camping for Tiger Cubs, Cub Scouts, Webelos Scouts, and Parents?.....	3
Types of Cub Scout/Webelos Scout Camping	3

The Plan

Points to Consider Before Starting.....	7
How to Get Started.....	8
Site and Facilities Needed.....	8
National Standards for Cub Scout and Webelos Scout Resident Camps.....	8
Factors for Success: Planning, Promoting, and Presenting.....	8
Common Sense for Cub Scout Camping.....	9
Safety, Sanitation, Medical Service, and Insurance	9
Financial Planning.....	10
Registration Procedures	10
Marketing the Program	11
Policy on Male and Female Arrangements for Youth and Adults.....	18

Personnel

A Plan to Develop and Train Staff	19
Qualities of a Good Camp Director	19
Camp Staff Organization Chart.....	19
Council Camp Staff and Unit Responsibilities	21
Employment Practices.....	24

Program

Your Camping Program.....	25
Sampling of Resident Camp Themes	26
Program Theme Activities.....	27
Theme: Sea Adventure	27
Theme: Space Station.....	29
Theme: Athlete	31
Theme: Knights	33
Theme: Folklore.....	35
Theme: The World Around Us.....	37
Theme: Frontier Adventure	38
Games.....	41
Campfires.....	43
Nature and Conservation.....	51
Quiet Activities.....	55
Activities to Let Off Steam.....	57
Water Games	58
Super Events	59
A Disabilities Awareness Experience for Webelos Scouts	61
Handyman Events.....	64
Shooting Sports in the Cub Scout Camping Program	67
Sports and Fitness	68
Areas of Safety Concern	69
Horsemanship Guidelines.....	69
Camp Achievements and Awards	69
World Brotherhood Day.....	69
Religious Emblems	70
Sample Graces	70

Appendix

Suggested Timetable	71
Supply Division Helps	73
Accounts for Developing Camp Budget.....	74
Camp Budget Worksheet	75
Personal Health and Medical Record Form	76
Cub Scout/Webelos Scout Equipment List	78
Daily Camp Program Schedule	79
Sample Reservation Forms	80
Sample Camp Activities Schedule	81
Program Activities That Might Be Used in Cub Scout Resident Camp.....	82
Cub Scout World.....	83

PURPOSES OF CUB SCOUTING

Since 1930, the BSA has helped younger boys through Cub Scouting. Cub Scouting (including Tiger Cubs) is a year-round family-oriented part of the BSA program designed for boys who are in first through fifth grades (or are 7, 8, 9, and 10 years old). Parents, leaders, and organizations work together to achieve the 10 purposes of Cub Scouting:

- Character development
- Spiritual growth
- Good citizenship
- Sportsmanship and fitness
- Family understanding
- Respectful relationships
- Personal achievement
- Friendly service
- Fun and adventure
- Preparation for Boy Scouts

Camping for Scouts— A Philosophy

A common thread of purpose and method runs through every part of the Scout camping program. Our aim is to clearly define that thread in each part of our camping program so that the purposes of Scouting will be made clear and the common methods that are followed will unify our units as teams dedicated to the highest ideals of camping and service.

Organized camping is a creative, educational experience in cooperative group living in the outdoors. It uses the natural surroundings to contribute significantly to physical, mental, spiritual, and social growth.

- Camping contributes to good health through supervised activity, sufficient rest, good fun, and wholesome companionship.
- Camping helps develop self-reliance and resourcefulness by providing learning experiences in which campers acquire knowledge, skills, and attitudes essential to their well-being.

- Camping enhances spiritual growth by helping campers recognize and appreciate nature and the handiwork of God in nature.
- Camping contributes to social development by providing experiences in which campers learn to deal practically and effectively with living situations.
- Camping is an experience in citizenship training, providing campers with the medium for democratic participation in making decisions, planning, and carrying out activities at their own level, while improving understanding within the family.
- Camping at the Cub Scout level introduces boys to and helps them develop skills to be applied and learned more thoroughly as a Boy Scout.

Character Development

Since its origin, the program of the Boy Scouts of America has been an educational experience concerned with values. In 1910, the first Scouting activities were designed to build character, physical fitness, practical skills, and service. These elements were a part of the original Cub Scout program and continue to be part of Cub Scouting today.

Just as character development should extend into every aspect of a boy's life, so character development should extend into every aspect of Cub Scouting. Cub Scout leaders should strive to use Cub Scouting's 12 core values throughout all elements of the program, including resident camp.

Cub Scouting's 12 Core Values

Citizenship	Honesty
Compassion	Perseverance
Cooperation	Positive attitude
Courage	Resourcefulness
Faith	Respect
Health and fitness	Responsibility

Scouting's Outdoor Program—Ever-Increasing Challenge Out of Doors

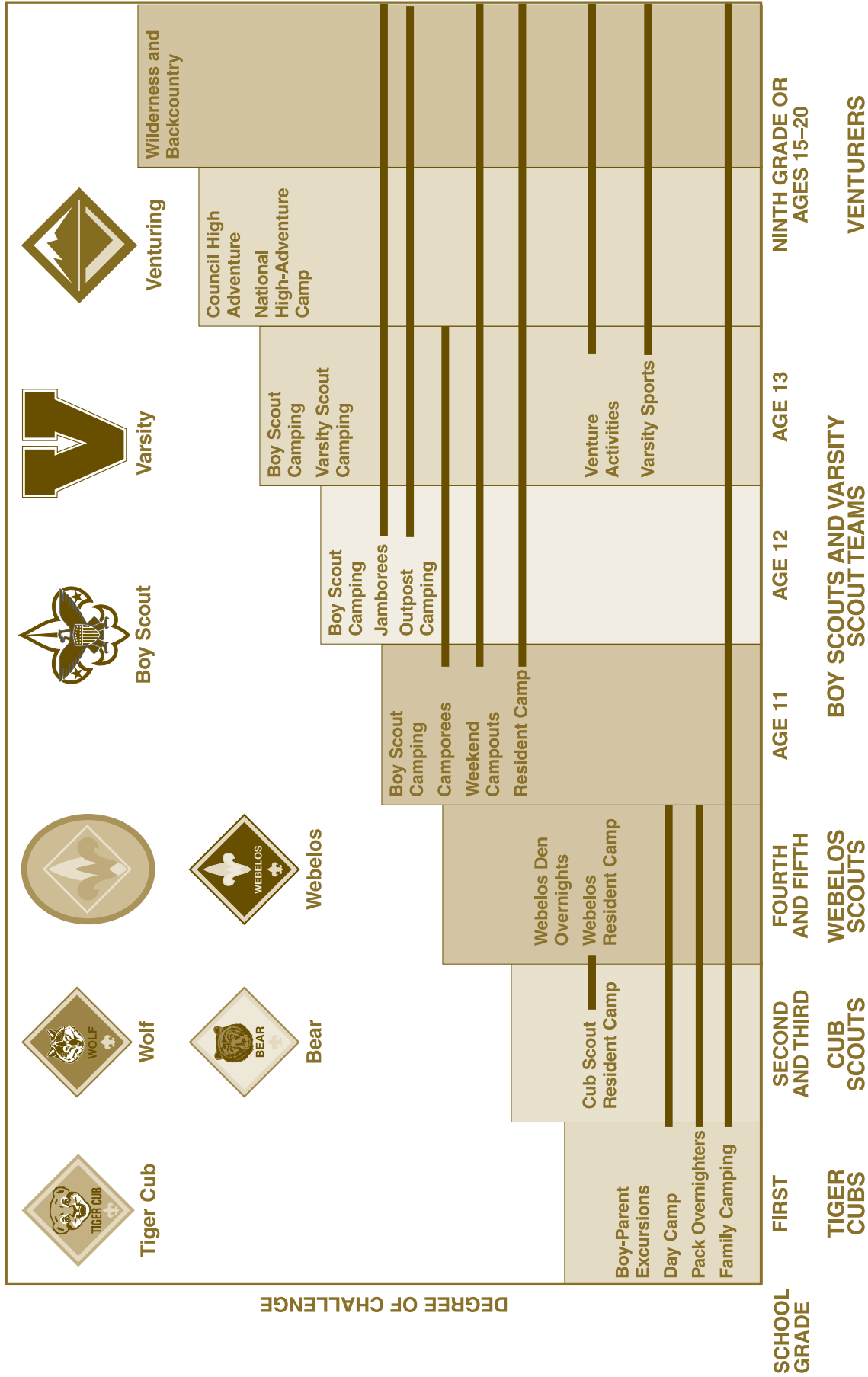

What Is Camping for Tiger Cubs, Cub Scouts, Webelos Scouts, and Parents?

Camping is the great outdoor adventure of the Boy Scouts of America.

As a Cub Scout becomes accustomed to the out-of-doors with his den, he unconsciously absorbs some of the greatness of nature itself—the quiet of the forest, the cheerfulness of the mountain stream, the breadth of the ocean, the openness of the sky, the freshness of the wind, the beauty of the sunset.

In working with nature to help provide food and comfort, a boy learns some of the skills, resourcefulness, and self-reliance of the pioneer. The woods, the streams, the trail, and the wild creatures that inhabit them become his friends, and the out-of-doors a lifelong source of recreation.

The ideal method of camping for Cub Scouts involves parents and the pack by dens.

Why Camping for Tiger Cubs, Cub Scouts, Webelos Scouts, and Parents?

Camping is an opportunity for the continuation of Cub Scouting throughout the summer (and acquisition of the National Summertime Pack Award). The camp program is designed to meet the needs and interests of Tiger Cubs, Cub Scouts, Webelos Scouts, and parents; therefore, preparation for achievements, electives, and activity badges should be continuous and consistent with the program in the pack.

Resident camping for Cub Scouts, Webelos Scouts, and parents can and should help boys maintain the interest generated the rest of the year and also strengthen den and pack organization for better year-round operation.

All of Scouting is an educational program, and since education consists primarily of determining the individual's learning needs and proceeding to satisfy those needs, we have every reason to promote a meaningful and educational year-round program for the Cub Scouting segment of the Boy Scouts of America membership.

Types of Tiger Cub, Cub Scout, and Webelos Scout Camping

Cub Scout Day Camp

Day camp is an organized one- to five-day program for Tiger Cubs, Cub Scouts and Webelos Scouts conducted by the council under certified leadership at an approved site. Day camps are conducted during daylight or early evening hours. Day camps do not include any overnight activities.

Certification of the day camp director and program director is provided through the National Camping School. **All day camps shall be conducted in accordance with established standards as provided in National Standards for Cub Scout/ Webelos Scout Day Camps, No. 13-108.**

Reference

Cub Scout Day Camp, No. 13-33815

Cub Scout/Webelos Scout Resident Camp

Cub Scout/Webelos Scout resident camping is a council-organized, theme-oriented overnight camping program. Cub Scout/Webelos Scout resident camp runs for at least two nights and is conducted under certified leadership at a camp approved by the council. Tiger Cubs are not eligible to attend resident camp.

Resident camping typically includes, but is not limited to, the following outdoor program areas:

- Showmanship
- Sportsmanship
- Craftmanship
- Waterfront
- Fitness
- Campcraft
- Nature

Each year, councils change their overall theme to offer different adventures. Examples of themes include Sea Adventure, Space Adventure, Athletes, Knights, Circus Big Top, American Indian Heritage, Folklore, and the World Around Us.

Certification of the resident camp director and program director is provided through the National Camping School. **All Cub Scout/Webelos Scout resident camps shall be conducted in accordance with established standards as provided in National Standards for Cub Scout/Boy Scout Resident Camps, No. 19-108.**

Webelos Den Overnight Camping

Webelos Scout overnights introduce the boy and his parent to the basics of the Boy Scout camping program. These campouts are conducted under the leadership of a trained Webelos den leader. In most cases, the Webelos Scout will be under the supervision of a parent or guardian. In all cases, each Scout is responsible to a specific adult. BSA health and safety and Youth Protection guidelines apply.

Webelos Scout dens are encouraged to visit Boy Scout district camporees and klondike derbies. The purpose of this visit should be for the boys to look ahead with anticipation to their future as Boy Scouts and observe troops they may potentially join. Webelos Scout dens should not compete against or participate in activities designed for Boy Scouts. Webelos Scout dens should not spend the night as participants at the event if the program is Boy Scout-based.

References

Cub Scout Leader Book, No. 33221, “Webelos Overnight Campouts”

Webelos Leader Guide, No. 33853A

Cub Scout Family Camping

Cub Scouts can experience overnight activities in venues other than accredited resident camping. There are two categories of Cub Scout overnights:

Council-Organized Family Camp

Council-organized family camps are overnight events involving more than one pack. The local council provides all of the elements of the outdoor experience, such as staffing, food service, housing, and program. These are often referred to as parent/pal or adventure weekends. Council-organized family camps should be conducted by trained leaders at sites approved by the local council. In most cases, the youth member will be under the supervision of a parent or guardian. In all cases, each youth participant is responsible to a specific adult.

Overnight activities involving more than one pack must be approved by the council. Council-organized family camps must be conducted in accordance with established standards as given in *National Standards for Council Family Camping*, No. 13-408.

Pack Overnights

These are pack-organized overnight events involving more than one family from a single pack, focused on age-appropriate Cub Scout activities and conducted at council-approved locations (councils use Site Approval Standards, No. 13-508). If nonmembers (siblings) participate, the event must be structured accordingly to accommodate them. BSA health and safety and youth protection guidelines apply. In most cases, each youth member will be under the supervision of a parent or guardian. In all cases, each youth participant is responsible to a specific adult.

Adults giving leadership to a pack overnighter must complete Basic Adult Leader Outdoor Orientation (BALOO) (No. 34162) and be present on campouts. BALOO trains participants to properly understand the importance of program intent youth protection guidelines, health and safety, site selection, age-appropriate activities, and sufficient adult participation. Packs use Local Tour Permit Application, No. 34426.

References

A Guide to Safe Scouting, No. 34416

Camping Program and Property Management, No. 20-920

Basic Adult Leader Outdoor Orientation (BALOO), No. 34162A

Cub Scout/Webelos Scout Resident Camping Formats

Second- and Third-Grade Cub Scout Resident Camping

Resident camping is geared toward an introduction to the outdoor program of the Boy Scouts of America by providing council facilities and certified camp staff to Cub Scout packs.

1. The objective is to provide Cub Scouts, parents, and other volunteer leadership with a meaningful, enjoyable experience and to strengthen parent-son relationships.
2. The length of camp can be from two to five nights. A camp of three days, including two nights, is recommended.
3. The camp must provide a dining hall.
4. The camp ratio of adults to boys is set by the council, but each boy is responsible to one designated adult.

5. Program facilities are to be developed around Cub Scout needs and skills and should be imaginative and theme-oriented.
6. The program literature is designed to provide a fun-filled, four-year program theme cycle capable of keeping the degree of challenge in perspective for second- and third-grade boys and their parents. When Cub Worlds are used, certain program villages are designed for Wolves and Bears. Webelos Scouts attend other villages.

Fourth- and Fifth-Grade Webelos Scout Resident Camping

Geared toward an introduction to Boy Scout camping and an overnight program for Webelos Scouts and their parents, resident camping is approved for councils electing to provide the following conditions:

1. The length of camp will be from two to seven days and two to six nights. Experience has shown that three days and two nights works best. This allows two camping periods each week, so more boys and adults can attend.
2. The camping facility should be the best the council has available and meet all Cub Scout camping standards.
3. A Cub Scouting-trained staff member is to be employed or asked to volunteer for the Webelos Scout resident camping program.
4. The Webelos Scout resident camp literature provides a four-year program cycle, keeping the degree of challenge in perspective for the boy and adult. When Cub Worlds are used, Webelos Scouts are scheduled for program villages designed for themes and programs appropriate to Webelos Scouts.

THE PLAN

Points to Consider Before Starting

Before setting up any resident camping program, review your program resources, personnel, potential participants, and activity needs. Begin by reviewing the following questions, using this book as a guide to your needs:

- What kind of program can we offer?
- What kind of facilities will this program require?
- Where will the camp be located?
- What specific facilities are available?
- What will we do about transportation?
- What will we do about meals and other food?
- What must we do to guarantee safety?
- Can we meet the minimum national BSA camp standards and state and local requirements with our selected location, program, and staff?
- What will be our detailed, day-by-day program?
- How long will we run our camp (number of days and weeks)?
- When will we conduct our camp?
- What staff will be required?
- From where will we recruit our staff? How and when will we train our staff?
- What is the range of fees that could be charged?
- What will our camp budget be?
- What are the sources of income to meet this budget?
- How will we promote attendance?
- How many packs will participate? What leadership is expected or required from each pack?
- How are parents involved?
- How many Cub Scout dens can we anticipate?
- How many participants can we accommodate?
- Can we coordinate all camps across the council in order to have consistent fees, share resources, and avoid scheduling conflicts?
- Are we ready and able to give our Cub Scout families and their volunteer leaders a worthwhile outdoor experience that will help achieve Cub Scouting's objectives? If not, what must we do to qualify ourselves?

Tips From Successful Councils for Cub Scout/Webelos Scout Resident Camp

- Involve Cub Scout volunteers in the entire development and action phases.
- Ensure that the camp program site is within one hour of travel for most families.
- Involve parents and adults in the camp program. (Parental involvement builds stronger packs and builds relationships within families.)
- Schedule sessions for two nights and three days (most successful sessions are this length).
 - Two per week: Sunday afternoon through Tuesday afternoon and Thursday afternoon through Sunday afternoon.
 - Weekend use is attractive to parents.
 - Camps lasting less than 72 hours use the Personal Health and Medical Record, Class 1 (No. 34414).
- Use Cub Scout volunteers to market the program.
- Use theme development for the program.
 - Use unique and popular programming.
 - Create camp awards.
 - Use age-appropriate camp crafts.
- Use Cub Scout volunteers on staff, especially if Boy Scout camp staff is still the main camp staff.

Themes Make the Difference

Camp themes make the difference. Consider the following:

- Use imagination.
- Offer a wide range of program development with the theme.
- Implement a four-year cycle—a new *adventure* each year (not the same old thing).
- Ensure that theme materials are cost-effective, fireproof, and safe.
- Give the same property a different use and appearance.
- Involve community resources.

- Create with themes an environment for boys to learn and participate in learning skills they ordinarily would not experience.
- Leave the advancement aspects for the Cub Scout pack operation.
- Plan and organize theme development in a reasonable time. **Use Cub Scout volunteers.**
- Reflect the theme in every aspect of the camp.
- Keep to the Cub Scouting program.
- Reflect Cub Scouting in the camp program—songs, mealtime programs, and campfires.
- Use age-appropriate programming.
- Use equipment and facilities appropriate to the age of Cub Scouts.
- Stock items in the trading post that are appropriate for Cub Scouts.
- Use all of the above as a retention-building idea.

How to Get Started

The executive staff and Scout executive of the council should become thoroughly familiar with this manual; it outlines the purposes, program, and costs of resident camping.

An announcement should be made in Cub Scout leader roundtables to get leader reaction, interest, and suggestions for guidelines on the type of summertime program to be offered.

A motion for approval of this activity should be considered by the council executive board.

The council camping subcommittee, including experienced Cub Scout adult leaders, or the Cub Scout committee should then draw up tentative plans for a Cub Scout summertime camping program, including type, dates, promotion, registration procedures, program elements, staff requirements, budget, and per-boy costs. Guidance for this subcommittee by professional staff will be necessary and helpful.

A director (who can be either a volunteer or professional) of the Cub Scout resident camp should be secured at an early date (November-December) to select the necessary staff. The camp director must be certified by a National Camping School.

See the Suggested Timetable in the appendix.

Site and Facilities Needed

The only acceptable site for a resident camp is a properly staffed council camp that meets national camp standards and state and local laws.

Such a site will have either cabins or tent sites, sanitary facilities, potable water, shelter for group usage if it rains or if it is too hot, and dining hall food service.

8-The Plan

Today's youth and adults need and want private (individual) showers and flush toilets within the camp. This is a very important issue.

The site may have a sheltered craft area, archery area, hiking trails, campfire area, first aid station, theme program areas, and trading post.

Facilities for swimming, boating, and fishing are not required, but they are desirable.

The council camp provides food, housing, waterfront coverage, health and safety, and staff support as needed. The council leadership provides the Cub Scouting program. Pack leadership provides Cub Scout supervision.

National Standards for Cub Scout and Webelos Scout Resident Camps

(Refer to *National Standards for Resident Camp Accreditation: Cub Scouting and Boy Scouting*, No. 19-108.)

Standards are established so that each council can realistically appraise its facilities, equipment, staff, service, and program. The standards must be met.

Early in each calendar year, the standards for the approaching camp season are available in print. Those responsible for the camping program should obtain copies and be sure through planning that standards will be met so that boys will have a safe and worthwhile experience.

Using the standards as a guide, a precamp inspection should be made. During the actual operation of the camp, a regional accreditation team should visit the site and conduct an accreditation inspection. The region will send the appropriate recognition.

Factors for Success: Planning, Promoting, and Presenting

The motivation and purposes of Scouting are important factors in influencing boys of Cub Scout age as they take part in your camp. The activities of the program, in addition to being fun and adventuresome for the boy, should embody the basic objectives of the Boy Scouts of America—character development, citizenship training, and mental and physical fitness. The camp should complement and strengthen the Cub Scouting program of the den and pack if it is to be a success.

Refer to this brief list often to assess progress and avoid last-minute difficulty:

1. Involve the camping committee.
2. Follow a timetable.
3. Check state and local laws and national camp standards.
4. Plan a budget and promote the camp.
5. Plan transportation.
6. Check camp facilities and hazards.
7. Check rainy-day facilities and shelter from sun and wind.
8. Arrange for water certification.
9. Check equipment needs—tables, tents, flies, first aid log, emergency vehicle, etc.
10. Notify fire and police departments of your plans; make arrangements for any medical emergency.
11. Arrange for campers to submit a health history *in writing*. Use a Class 1 or 2 health form.
12. Secure storage for craft and sports equipment and locked storage for records and valuables.
13. Plan a themed program and recruit a staff.
14. Involve the council professional staff; make them feel that they are a part of it, even if they are not directly responsible.
15. Be sure the staff is Cub Scouting oriented.

Common Sense for Cub Scout Camping

1. Conduct Cub Scout camping when Boy Scout camping is not going on at the same time.
2. Conduct the Cub Scout camp using smaller facilities than those used for Boy Scouting, i.e., the archery range and obstacle course must be Cub Scout size.
3. Operate with adults from dens or packs; use the pack plan and some Boy Scouting staff.
4. Arrange for sufficient staff for the attendance expected. Occupancy of 100 percent is no problem with enough staff and program areas.
5. Vary the program so that the boys will want to return. Each den should have new program elements scheduled every day and be given the chance to repeat favorites.
6. Keep the program simple and Cub Scout-related. Make sure it is fast-moving. Cub Scouts do not sit and listen—they act! KISMIF!
7. Conduct a staff hazard hunt for poisonous plants, old bridges, unsafe buildings, glass, old wells, etc., *before* camp opens.

Safety, Sanitation, Medical Service, and Insurance

(Refer to *National Standards for Resident Camp Accreditation: Cub Scouting and Boy Scouting*, No. 19-108.)

The complete safety of campers is your top priority. Staff members and campers *must* observe certain ground rules, such as

1. Swimming is always conducted by *trained qualified supervisors* following all Boy Scout aquatics regulations. The Safe Swim Defense is as applicable to pack swims as it is for any Boy Scout troop. Use the buddy system at all times.
2. All archery and field sports must be conducted by trained, qualified supervisors.
3. Boating must follow the Safety Afloat regulations as to swimming ability, use of personal flotation devices, number of people per boat, etc.
4. *Any activities not typically a part of Cub Scouting should be avoided*, e.g., climbing on buildings, climbing banks or cliffs, contact sports (tackle football, etc.), diving and use of high-diving boards, rifle marksmanship (22-caliber, shotgun, etc.), and so on.
5. Any hazards in the camp area should be off limits; avoid cliffs or steep bank areas, bridges, maintenance areas, electrical installations, old vehicles and buildings, dumps, etc.
6. Follow camp safety rules regarding flammability of tents. Tent material is not fireproof and can burn when exposed to heat or fire. *No liquid-fuel stoves, heaters, lanterns, candles, matches, or other flame sources should be used in or near tents*. Do not use flammable chemicals near tents, such as charcoal lighter, spray cans, insect killer, and insect repellent. Extinguish cooking fires and campfires properly, and obey all fire regulations in your area. If an adult must smoke, do so in safe, prescribed areas ONLY.
7. *No smoking while working with boys. No alcohol on camp property.*

Sanitation. Sanitation for any camp must comply with all Scouting standards as well as with all related local ordinances. Toilets must be clean; wash water and drinking water must be easily accessible. Refuse pickup and disposal must follow a regular schedule. Cub Scouts should “police” their own areas.

All drinking water and swimming water must be laboratory tested and meet local standards.

First Aid. A competent, currently certified health officer should be available for treating minor injuries at camp. For more serious emergencies, a medical doctor or emergency medical service should be available and on call. Your council *must conform to state and local requirements for first aid and medical personnel.*

Insurance. Many councils consider health and accident insurance for resident camp a moral obligation.

Emergencies. All camp staff personnel should be completely briefed about the action to take in case of emergencies and should know the location of the nearest telephone. Possible emergencies include serious cut, swimming or boating accident, camper lost or left camp without permission, sudden seizure or illness, flood, fire, or windstorm. Know boys' phone numbers and the location of and how to contact parents in case of an emergency.

Physicals. All campers, youth and adult, must submit a current health history and physical examination form (No. 34414 for youth, see the Appendix, and No. 34412 for adults).

Parent Authorization. Obtain parent authorization for each youth camper (see Sample Reservation Forms in the Appendix).

Financial Planning

The budget for a Cub Scout resident camp must be prepared and approved by both the council Scout executive and the council executive board. It is important that they know the project will be at least self-supporting. A camp budget form and worksheet are included in the Appendix.

You should make a *full financial report* to the council camping committee and executive board at the close of the camp. Key staff should make an *evaluation and report* in writing about the camp operation, including specific recommendations for the following year.

Keep a *complete itemized inventory*, and submit it to the director at the close of the camp. This must be done by departments and include the location, condition, and storage of all tools, materials, and other equipment. Three copies are needed: one filed at camp, another filed at the council office, and the third kept by the camp director. Trading post operation should be in line with procedures set forth in the *Camp Program and Property Management*, No. 20-920, Section II.

Registration Procedures

An efficient procedure for registering packs and Cub Scouts must be in place. It is important to know how many campers you'll have so that you can be prepared as well as gain the confidence of your parents and pack leaders. After you receive the reservation forms, immediate acknowledgment is a matter of courtesy and good business. Include the medical form to be completed and brought to camp by the boys.

There are two types of reservation forms used in Cub Scout camp programs—one for the pack and one for the individual boy, according to the type of camping program you are providing. Samples of each type are in the Appendix.

Customer service is very important, so long check-in and registration lines at camp should be avoided.

Marketing the Program

Define the Values of Each Camping Program

Before you can develop a year-round marketing plan to promote year-round camp attendance, you need to define the values of each camping program your council offers. What does each camp experience have to offer Cub Scouts and their parents?

A. Evaluate present values

List aspects of your camp program's unique and personal philosophy—things you expect a camper to be able to do (the desired outcomes you want campers to have):

1. Day camp _____
2. Resident camp _____
3. Family camp _____
4. Pack camping _____

Write what it is that your program offers to each camper (the value your customers receive):

1. Day camp _____
2. Resident camp _____
3. Family camp _____
4. Pack camping _____

List major strengths and needs for each type of camping opportunity: day camp, resident camp, family camp, or pack camping. (For additional information, see *Local Council Strategic Planning—Benchmarks for Success*, No. 14-985C.)

	Strengths	Needs
Facilities	_____	_____
Program	_____	_____
Staff	_____	_____

B. Establish progressive, age-appropriate programming

Define programming that you would like to have a camper achieve during his time at camp.

	Each year (Tiger Cub, Wolf, Bear, and Webelos)	3–4-year period (repeats)
Day camp	_____	_____
Resident camp	_____	_____
Webelos overnights	_____	_____
Family camp	_____	_____
Pack camping	_____	_____

C. Review camping attendance and participation levels

See the following page.

Cub Scout Camping Study Worksheet

Council _____	Actual Record			Projected Objectives				
	12/31 20__	12/31 20__	12/31 20__	Year 1 20__	Year 2 20__	Year 3 20__	Year 4 20__	Year 5 20__
Cub Scouts/Webelos Scouts at day camp								
Cub Scouts at resident camp								
Webelos Scouts at resident camp								
Cub Scouts and Webelos Scouts at family/pack camp								
Total Cub Scouts—all camping programs								
Cub Scouts registered June 30								
Percent Cub Scouts registered June 30—all camping programs								
Number of packs represented at day camp								
Number of packs represented at Cub Scout resident camp								
Number of packs represented at Webelos resident camp								
Number of packs represented at family/pack camps								
Total packs represented at one or more camping programs								

Target Your Audience

When decisions have been made regarding which Cub Scout camp program will be offered, you need to consider the audiences to which you are selling and which methods will be used to attract the greatest involvement. The local council in Rochester, New York, did an excellent job of target marketing and this sample of an edited piece may provide you additional support.

Type of Program Package*	Chartered organizations	Cub Scout pack leaders (Divide according to level of participation expected)	Parents	Tiger Cubs	Cub Scouts	Webelos Scouts	Families
Day camp (D)							
Resident camp (R)							
Family camp (F)							
Council bulletin							
Council service center							
Special mailings							
Newspaper							
Radio							
TV							
Slide show/digital presentation							
Video							
Telephone							
E-mail							

*Packaging your program—place the letter in the appropriate columns you plan to target.

Develop a Plan of Action

A. The Responsibilities of the Council Camping Committee

The council camping committee has the primary purpose of helping units succeed.

The council camping committee needs to provide outdoor programs with ever-increasing degrees of challenge. As the boy and his parents are drawn into the outdoors as Cub Scouts, it is important for Cub Scout leaders to be part of the outdoor program planning process.

Council camping responsibilities fall into four categories:

1. Outdoor program
2. Properties and maintenance
3. Conservation
4. Promotion

This suggested committee structure provides overall leadership for all of the Cub Scout outdoor program opportunities offered by the council. This structure also provides coordination among all the outdoor program levels and promotion efforts for all Tiger Cubs, Cub Scouts, Webelos Scouts, and families.

B. Suggested Cub Scout Camping Committee Structure (may be a subcommittee of the council camping committee)

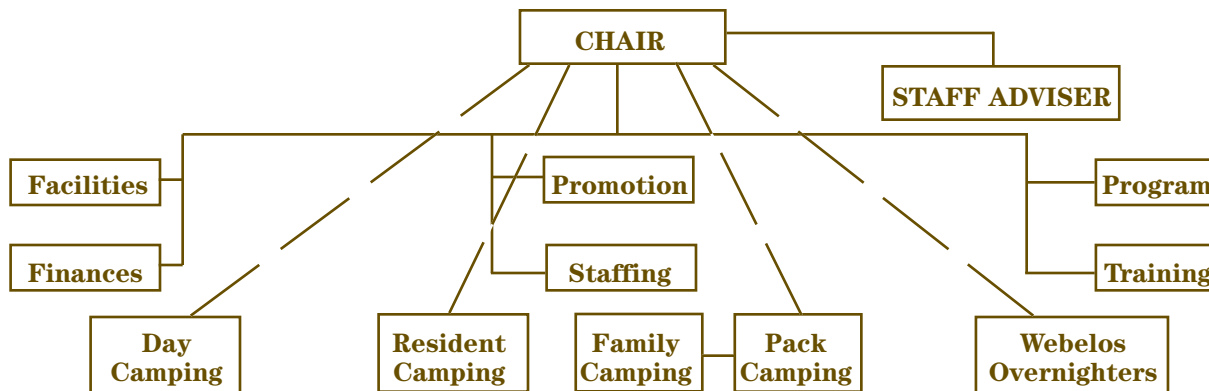

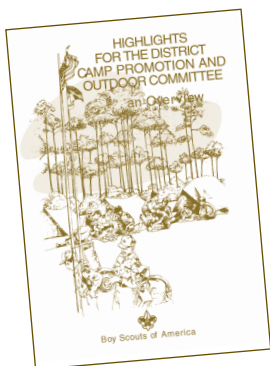

Resource: *Highlights for the District Camp Promotion and Outdoor Committee—An Overview, No. 34725*

Establish Promotional Methods

When your Cub Scout outdoor program has been approved by your camping committee and executive board, you are ready to begin promotion.

Brochures and Other Promotional Tools

First impressions are lasting ones, so do a good job as you prepare the folder or information for the council bulletin that tells your story. Your neatly printed brochure should include the following:

1. Aims and objectives of the camp
2. Description of program features (include pictures)
3. Description of staff members and their qualifications; staff-boy ratio
4. Location of the camp, with directions
5. What to bring, cost insurance, transportation
6. General schedule—daily and date (when)
7. Reservation form
8. Health form (can be provided when reservation form is returned)

This information should be developed to tell the story about your growing Cub Scout summer program and to promote it among Cub Scouts and their parents. Include the basic information in your council bulletin so your entire Scouting family knows about it. Provide copies to the heads of your chartered organizations so they know of the growing service your council is providing for their Cub Scouts, parents, and pack leaders.

Announce Cub Scout outdoor program plans in your local news media. Plan, publicize, and hold an open house at your campsite ahead of time so parents can see the camping facilities. Have several camp staff members present to help with the program. Put pro-

motional posters in schools, shopping centers, and other places boys go. Visit schools and invite all first-through fifth-grade boys to join a pack and attend camp. Plan a special emphasis for Webelos Scout camping.

You might hold a Cub Scout summer adventure sign-up day at the local council service center in January, with refreshments and a camp mug for the Cubmaster. Videos and digital presentations of the program and facilities are effective to show at all appropriate meetings. Be sure to take pictures for next year's promotion (use a digital camera or have the photos scanned). Many councils have a Web site on the Internet.

A happy experience for the Cub Scout sells the Cub Scout camp adventure to him for next year also.

Additional Methods of Promotion

- Digital presentations or videotapes for pack meetings
- Newspaper stories
- Radio spots
- Roundtables
- Blue and gold placemats with a camp application form in the corner
- Council bulletin
- Web site of council
- Web site of nearby councils who do not have summer camp
- Television
- Order of the Arrow
- Fliers and brochures
- District committees
- Commissioner's staff
- Postcards with camp pictures
- Early sign-up recognition for Cub Scouts

Sample —For Council Newsletter

It's Off to Resident Camp for All Cub Scouts Next Summer

Leaders and parents: Get out your calendars and circle a date. . . you've got an important appointment in (month).

That's when the (council name) Council plans to operate its resident camp for Cub Scouts—a ()-day, ()-night adventure session designed specifically for all Cub Scouts and Webelos Scouts. The date(s): (start date) through (end date). (List other session dates if appropriate.)

Cost: \$. It includes (tent, cabin) accommodations, all meals in a camp dining hall, training staff, (most) program material, insurance, (list other items included, such as transportation).

Location: (camp name), (location).

Our camp session(s) will be directed by (name), who (some familiar ID). (S)He will be assisted by a staff of (number).

Cub Scouts should be accompanied by a parent or guardian.

The theme this season is (theme). The program features will include (program highlights).

For more information or for brochures on the (council name) Council's Cub Scout resident camping week(s) at (camp name), contact (contact person with phone or address or both).

Sample—For Council Newsletter

(Name) to Head Cub Scout Resident Camp

(Full name), of (hometown), will direct the three-day (or appropriate figure) Cub Scout and Webelos Scout resident camp next summer at (camp name). Long active in Scouting, (last name) has served as (list appropriate Scouting background).

(She/He) has spent (number) summers on the staff of Camp (name). Assisting (him/her) in key slots will be:

(name and identify several other key staff members).

An expected (number) boys will attend the special Cub Scout and Webelos Scout program at camp this summer with their parents. Dates are (list dates).

Packs that have not yet made their reservations are urged to contact (name and how to contact). Cost is \$ per person (or per parent/son unit), and a reservation fee of \$ will hold a space for you until (date).

This is a great opportunity to share some quality time with your son(s).

Sample —For Council Newsletter

(Theme) Theme Set for Cub Scout Camp

(Theme) is the theme of the (council name) Council's Cub Scout summer camp session(s) at Camp (camp or reservation name), according to Scout Executive (full name).

"We are hoping for a capacity turnout of (number)," said (Scout executive's last name) as preparation moves ahead for this premier season of camping for Cub Scouts of all ages.

The program supplements the Webelos summer overnight camping program, which has been a popular parent/son activity for the past (number) years.

Under the (theme) theme, Cub Scouts and a parent or responsible adult will enjoy fun, learning, and challenging activities in sportsmanship, crafts, nature, fitness, campcraft, the waterfront, and showmanship.

This summer's program is under the direction of (name, and some ID if appropriate).

Summer camp dates: _____. Cost is \$ _____. Reservations are made through packs on a unit basis. If your reservation isn't yet firm, now is the time to act!

For further information on resident camping for Cub Scouts, Webelos Scouts, and families/packs, contact (name and contact information).

Work the Plan

Communicate With Packs Each Month

This year's camper needs to begin to look forward to next year's camp the day after this camp closes. This year's memories help. Develop monthly communication with all packs. All year long, boys, parents, and leaders need to pause and remember the good times they enjoyed at camp and plan to participate next year. The boys need to share the fun with their buddies. Parents need to reinforce other parents, and leaders need to actively promote pack participation.

Appropriate Follow-Up Procedures Are Needed

Appropriate follow-up procedures will make the investment of time and money pay off. Sending out an announcement isn't enough; consider personal contact, phone calls, and second notices. Send postcards and e-mail messages.

Maintain Current and Increase New Campers

An organized, systematic approach is necessary for maintaining current campers, increasing new camper potential, and strengthening your camp's image.

Some Ideas for Maintaining or Establishing the Camp Image

- Build the image of camp as something "precious."
- All literature must be of the highest quality possible within budget limits.
- Send a special camp edition of the council newsletter to last year's campers and this year's prospects.
- Providing a quality program this year will help next year's attendance.
- Build a relationship with this year's pack leaders and campers.
- An increase in the number of campers will affect the physical plant, the water system, sewage, electrical systems, and buildings.
- Provide council office telephone operator or receptionist with information on camp programs and sign-up procedures.
- Keep volunteers informed as to sales results.
- Growth of staff is more challenging than growth of campers.

- Size of staff should be one year ahead of growth projections, and facilities can be one year behind.
- Offer special incentives to make staff membership more important.
- Consider recognizing staff for a year-round job rather than just during camp seasons.
- Consider: The larger the attendance, the greater the need for better delivery of a quality program.
- Have some telephone counselors communicate with all families during the week.
- Each time the camp becomes larger, lower the den size in relation to adults.
- Provide a feeling of intimacy to campers and families. Be visible—show you care.

Reach Out to New and Past Campers

Consider the following:

- Hold an open house for pack leaders and parents.
- Advertise.
- Hold camp fairs and Scouting shows.
- Make school contacts before summer.
- Contact past campers and staff members to secure returns and recommendations for new campers.
- Hold camper reunions.
- Send birthday greetings from camp to last year's campers.
- Have a newsletter.
- Make yearbooks or calendars.
- Make and distribute T-shirts.
- Collect memorabilia.

Policy on Male and Female Arrangements for Youth and Adults

To support the BSA policy of two-deep leadership on all trips or outings, we must address the sleeping arrangements of male and female leaders.

All leaders are expected to reflect high moral standards established by custom, traditional values, and religious teachings.

Male and female leadership require separate sleeping facilities. Married couples may share the same quarters if appropriate facilities are available.

Male and female youth participants will not share the same sleeping facility. When staying in tents, no youth will stay in the tent of an adult other than his or her parent or guardian.

If housing other than tents is used, separate housing must be provided for both male and female participants. Adult male leaders must be responsible for the male participants; adult female leaders must be responsible for the female participants.

Adult leaders need to respect the privacy of youth members in situations such as changing into swimming suits or taking showers and intrude only to the extent that health and safety require. They also need to protect their own privacy in similar situations.

Although it is not mandatory, councils are strongly encouraged to have shower and latrine facilities for women and girls separate from those for men and boys. In camps where separate facilities are not available, schedule and post times for male and female shower use, and use the buddy system for latrines by having a person wait outside the entrance, or use "Occupied" and "Unoccupied" signs and/or inside door latches.

PERSONNEL

A Plan to Develop and Train Staff

Factors that affect your planning process:

- Facility—meeting national standards, rainy-day shelter
- Length of camp
- Number of packs you plan to have participate in the program
- Leadership needed
- Size of area you will be drawing your staff from (council or district)

First action step—finding staff members:

- Use the resources of your group. (Develop a list of names.)
- Packs: Ask den leader coaches and Cubmasters.
- Roundtable and staff.
- Scout troops (den chiefs, Eagle Scouts, OA members).
- Council/district training participants (pow wow, den chief conference).
- Training records for former unit leaders (den leaders, etc.).
- Training committee.
- Community special-interest groups.
- Previous camp staff lists.

Second action step—training:

- Personal resource questionnaire for placement related to skill and ability.
- Use “Staff Training and Parent Orientation Guide for Cub Scout/Webelos Scout Resident Camp,” No. 13-167. This booklet has a special section titled “Preparing Pack Leaders and Parents for Outdoor Programs.”

Qualities of a Good Camp Director

- Maturity
- Competence
- Healthful attitudes
- Imagination
- Understanding of boys’ needs
- Enthusiasm

- Pertinent experience and background
- Patience
- Commitment
- Administrative ability
- Sense of public relations
- Agreeable personality
- Sense of humor
- Adaptability
- Good appearance
- Extensive knowledge
- Disciplinary skill
- Sense of responsibility
- Compassion
- Tact
- Loyalty

Camp Staff Organization Chart

This chart shows the chain of command in an ideal Cub Scout/Webelos Scout resident camp. In this situation, Cub Scouts, their leaders, and their parents camp three or more nights in a council camp during the camp’s summer schedule.

The camp, through the support staff, provides food, housing, a trading post, health, safety and security, and supplemental help as requested.

The Cub Scout program staff provides for waterfront activities, crafts, nature awareness, sports, BB gun practice, archery, etc.

The camp commissioner coordinates the pack leadership in supervising and disciplining Cub Scouts, Webelos Scouts, and their family members in attendance. This is a full-time position.

With this organization, the session program is already structured before the dens arrive, and it is repeated throughout the camp season. The support staff is on the job for the entire camp season. The pack adult or den leader who accompanies the den to camp is the leader of that den in camp for that session. Staff members of each program area function as a team, with the director of that area leading the team to get the job done, using personnel and resources in the best possible way to benefit the boys and their leaders.

Council Executive Board

Scout Executive

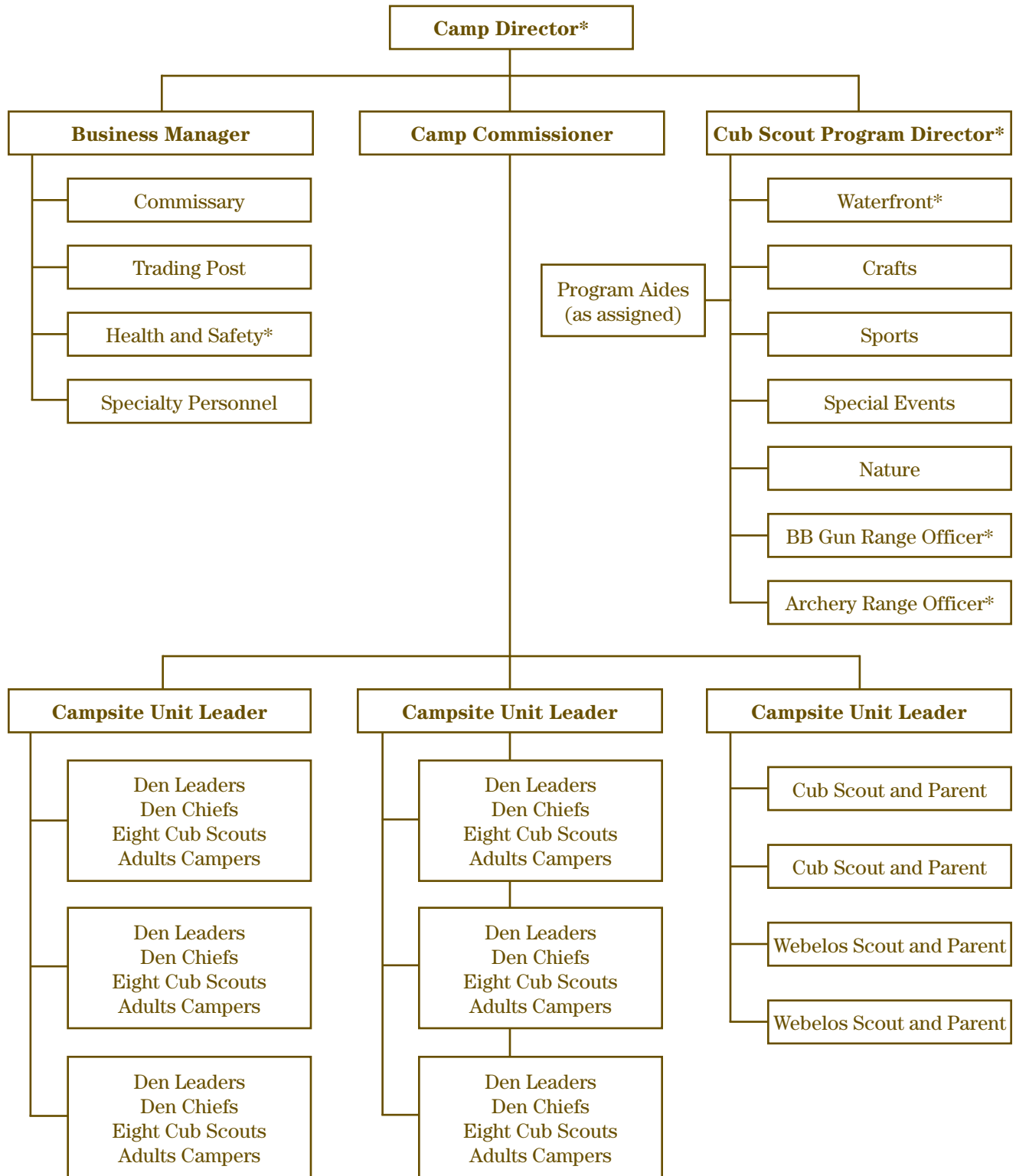

*Certified (see standards).

Council Camp Staff and Unit Responsibilities

Camp Administrator—The professional on the council staff responsible for planning, promoting, presenting, and reporting on all Cub Scout camps in the council.

Council Camp Director—The volunteer or professional on the site conducting the Cub Scout camp. The camp director shall be 21 years of age or older, currently trained in camp management by the National Camping School with at least two seasons of prior administrative or supervisory experience, and of well-known good character and ability. The camp director shall

1. Be responsible to the camp administrator.
2. Supervise the personnel and operating details of the camp.
3. Conduct, in cooperation with the program director, a camp staff training course before the opening of camp to familiarize the staff with the camp program.
4. See that high standards for leadership, program activities, and health and safety are maintained.
5. Be responsible for staff who work in housing, feeding, the trading post, and health and safety, as well as for specialty personnel.
6. Possess and display a maximum of the qualities of a good camp director listed previously.
7. Be currently certified by a National Camping School.
8. Lives on site and shall hold no other position.

Council Camp Business and Physical Arrangements Manager*—Shall be 18 years of age or older and of well-known good character and ability. The business manager shall

1. Be responsible to the camp director.
2. Prepare a list of required materials and facilities for the camp and submit it to the camp director.
3. Keep accurate records of income and expenses and submit financial records and bills for payment to the council office at regular intervals.
4. Set up and maintain the petty cash account.
5. Purchase supplies as authorized by the camp director.
6. Arrange and oversee the camper transportation system.
7. Coordinate the food issue.
8. Be responsible for the trading post operation.

Camp Health and Safety Officer—Shall be registered, licensed, or certified as state laws require, and shall meet qualifications set by the national standards for Cub Scout/Webelos Scout resident camp.

Cub Scout/Webelos Scout Resident Camp Program Director—The volunteer or professional on the site responsible for the Cub Scout/Webelos Scout camp program. The program director shall be at least 21 years old and of well-known good character and ability. The program director, in addition to being certified at a National Camping School, shall

1. Be responsible to the camp director.
2. Be familiar with Cub Scouting and its achievements and electives and with Webelos Scouting and its activity requirements.
3. Get the best staff members for the jobs.
4. Give activity directors the freedom to plan their activities but help them plan their programs if they want or need it.
5. Have a copy of each activity area's daily project plan.
6. Prepare a schedule for camp, submit copies to leaders and program people, and post a copy.
7. Work with the camp director in preparing a budget for the programs.
8. Help activity directors with the budgets in their areas and see that they have the supplies needed for their programs.
9. Be responsible for maintaining inventories of program materials.
10. Train and supervise the program staff, making use of the current theme(s).
11. Cooperate with the camp commissioner to help unit leaders plan and carry out successful camp experiences through personal coaching, training, and effective use of the program staff.
12. Keep the camp records of recognitions, electives, and activities completed by campers as recorded by leaders and activity directors.
13. With others, promote the camp at roundtables, pack meetings, and other Scouting events.
14. Work with the promotions director.
15. Recruit an assistant.
16. Live on site and hold no other position.

Council Camp Waterfront Director—Shall be 21 years of age or older, hold certification as a BSA Aquatics Instructor, and be currently certified in CPR-BLS by the American Red Cross or the American Heart Association.

Cub Scout Aquatics Supervisor—Shall be 21 years of age or older; hold current BSA Lifeguard, American Red Cross Lifeguard, or YMCA Lifeguard certification; have successfully completed a three-day National Camping School Cub Scout Aquatics training program; and be currently trained in American Red Cross standard first aid, which includes cardiopulmonary resus-

*In some councils, the camp director may perform these duties.

citation (CPR), or National Safety Council first aid and CPR Level I. The aquatics director holds no other position. *Note:* If boating is included in the program, ARC Lifeguard or YMCA Lifeguard certification alone are not sufficient. BSA Lifeguard training includes boating safety. If the supervisor is not BSA Lifeguard certified, then he or she should participate in and satisfactorily complete training and orientation in BSA Safety Afloat conducted by a certified BSA Lifeguard or BSA Aquatics Instructor.

Cub Scout Campcraft Director—Shall be 18 years of age or older, of well-known good character, and have a demonstrated ability to work with and instruct others in crafts. The campcraft director shall

1. Be responsible to the program director.
2. Plan and carry out a constructive campcraft program in cooperation with the program director and den leaders.
3. See that a list of supplies needed for campcraft projects is submitted to the business manager.
4. Help the den leaders teach the skills necessary for completing the selected Cub Scout-level projects.
5. Supervise the use and storage of equipment and materials.

Cub Scout Camp Sports Director—Shall be 18 years of age or older, of well-known good character, and have a demonstrated ability to work with and instruct others in sports and physical fitness. The sports director shall

1. Be responsible to the program director.
2. Plan and give leadership to an appropriate sports and fitness program in cooperation with the program director and den leaders.
3. Be sure that the sports program is designed at the Cub Scout level, using only approved sports.
4. Submit a list of sports and fitness equipment to the business manager.
5. Help the den leaders and parents teach fitness skills.
6. Supervise the use and storage of equipment.

Cub Scout Camp Nature Director—Shall be 18 years of age or older, of well-known good character, and have a demonstrated ability to instruct others in the nature program. The nature director shall

1. Be responsible to the program director.
2. Plan and give leadership to an appropriate nature program in cooperation with the program director and den leaders.
3. Submit a list of nature program supplies to the business manager.

4. Help the den leaders and parents teach the nature activities.
5. Be sure that the nature program is designed at the Cub Scout level.

Cub Scout BB Gun Range Officer—Shall be 18 years of age or older, of well-known good character, and have a demonstrated ability to work with and instruct Tiger Cubs, Cub Scouts, and Webelos Scouts in BB gun safety. Certification must be given by the local council with the help of a National Camping School-certified shooting sports director or National Rifle Association (NRA) instructor. The BB gun range officer shall

1. Be responsible to the program director.
2. In cooperation with the program director, plan and give leadership to a BB gun safety program, allowing boys and adults to participate actively.
3. Supervise the use and storage of equipment.
4. Have certification that is good for two years.

A BB gun (rifle) safety and marksmanship for program use in Cub Scout camp requires a BB gun range officer who has been certified by the local council *with the help of a National Camping School-certified field sports director or an National Rifle Association (NRA) instructor*. The BB gun range officer must

1. Read and understand the requirements for a range in *Camp Program and Property Management* (No. 20-920), Section V: Samples of Shooting Sports.
2. Be familiar with “BB Gun Safety and Training Program” (below) and take part in a walk-through of the safety and training program conducted by a certified field sports director or NRA instructor.
3. Be at least 18 years of age.

A 150-minute training session must be provided for BB gun range officers conducting the safety and marksmanship program at Cub Scout camp. For planning purposes, use the outline of the “BB Gun Safety and Training Program” included below.

The local council should issue a pocket training certificate (No. 33767) and keep a record of the people who have been certified. Certification must be renewed every two years.

Cub Scout Camp Archery Range Officer—Shall be 18 years of age or older, of well-known character, and have a demonstrated ability to work with and instruct others in archery. Certification must be given by the local council-certified shooting sports director or National Archery Association instructor. The archery instructor shall

1. Be responsible to the program director.

2. In cooperation with the program director, plan and conduct a safe and enjoyable archery range, allowing all boys and adults to participate.
3. Supervise the use and storage of equipment.
4. Have certification that is good for two years.

Evening and Special Events Director—Shall

1. Be responsible to the program director.
2. Have suggestions and supplies prepared to help den leaders with evening programs that can be performed in individual campsites.
3. Plan campfires for the entire camp—one for the first night and one for the last night.
4. Plan one religious activity.
5. Plan evening activities or special afternoon activities for the entire camp, such as scavenger nature hunt, watermelon seed counting contest, raingutter regatta, super giant sundae building, talent contest, Helicopter Egg Drop (described on page 59), a special theme activity, etc.
6. Be prepared for rain.
7. Prepare a written daily schedule.
8. Write a report on how the events went and include any suggestions and ideas for next year.
9. Be innovative and make each activity memorable.

Program Aide—Shall be a capable Life Scout or Eagle Scout at least 15 years of age and able to demonstrate and teach skills to Cub Scouts and Webelos Scouts. The program aide shall

1. Be responsible to the specific activity director.
2. Help take care of supplies and equipment.
3. Be an “example setter” that Cub Scouts and Webelos Scouts look up to.
4. Help the activity director with any necessary paperwork.
5. Carry out assigned duties.

Cub Scout Camp Commissioner—The Scouter on staff shall be at least 18 years of age and of well-known good character and ability. The camp commissioner shall

1. Be responsible to the camp director.
2. Be familiar with Cub Scouting and its achievements and electives and with Webelos Scouting and its activity requirements.
3. Assist the program director by being sure den leaders and activity staff members have and understand schedules, program activities, and recordkeeping chores.
4. Help with camp training and with supervising unit leadership.

5. Help unit leaders plan and carry out successful camp experiences through personal coaching, training, and effective use of program staff.
6. With others, promote the camp at roundtables, pack meetings, and other Scouting events.
7. Be flexible, friendly, and helpful.
8. Write a report on the camp program, including suggestions for next year.

Unit Leader—Shall be at least 21 years old, of mature judgment, and have the ability to exert strong leadership. Unit leaders shall

1. Be responsible to the camp commissioner.
2. Carry out the camp program in the unit with the advice of the camp commissioner and the help of program staff.
3. Introduce campers to camping skills and appreciation of the outdoors.
4. Coordinate unit activities with those of the entire camp.
5. Supervise the unit staff—delegate jobs, guide the unit staff in their work.
6. Supervise unit housekeeping, sanitation, and camper health and safety.
7. Be knowledgeable of the appropriate program, either Cub Scouting or Webelos Scouting.

Den Leader—Shall be at least 21 years old and of well-known good character and ability. Den leaders shall

1. Be responsible to the unit leader.
2. Carry out duties as assigned by the unit leader.
3. Assist and supervise the boys in the den.
4. Assist in program areas as needed so that boys make the most of their opportunities.
5. Be concerned for camper safety.
6. Be knowledgeable of the appropriate program, either Cub Scouting or Webelos Scouting.

Den Chief—Shall be a First Class Scout or Venturer capable of serving as den chief. The den chief shall

1. Be responsible to the den leader.
2. Escort Scouts to various activity areas.
3. Help with beads, totems, etc.
4. Be an “example setter.”
5. Assist the den leader and carry out assigned duties.

Employment Practices

The camp director should know the state laws or regulations governing employment, such as minimum pay, hours and conditions of work, time off, employee privileges, etc. Such laws or regulations are not standard among the states; therefore, you need to know about all legislation affecting camping in the state in which your camp is located.

The camp director should draft a letter of agreement covering the terms of the agreement and stating specifications of the job: period of employment; salary or wages; Scouting's stand regarding alcohol, drugs, and smoking; conduct; appearance; time off; uniform; requirements; and special privileges. Deliver this letter to each camp employee before employment and retain a copy in the executive or camp director's file. Acknowledgment of acceptance should be made in writing by the employee.

All problems of employment cannot be solved by a standard statement. They must be judged in light of the local conditions and needs of the camp. These problems include items such as transportation, days off, use of personal cars, permission to leave camp, personal time each day, relationship to camps nearby, and personal visitors in camp. All such items must be discussed openly and must be in writing so misunderstanding can be avoided. *All camp staff members must fill out an application* so that a record of employment will be on file.

The staff application, letter of agreement, and job description are required for all staff members, regardless of whether they are paid or volunteer.

PROGRAM

Your Camping Program

All items mentioned previously in this book prepare camp staff to provide campers with a fun-filled, meaningful program that helps achieve the purposes of Cub Scouting.

The council should review the seven suggested yearly themes in this section and select a four-year theme cycle. More than 200 different themes are used each year in various camps.

Each year during this four-year cycle, a Cub Scout or Webelos Scout and parent(s) attend camp. They should find the experience to be progressively challenging. Cub Worlds usually rotate the Cub Scouts and Webelos Scouts into program themed villages that have age-appropriate activities.

The seven program areas of showmanship, sportsmanship, craftsmanship, nature, fitness, waterfront, and campcraft are included in each year's camp program theme.

Sampling of Resident Camp Themes

PROGRAM AREAS	SEA ADVENTURE	SPACE STATION	ATHLETE	KNIGHTS	FOLKLORE	THE WORLD AROUND US	FRONTIER ADVENTURE
SHOWMANSHIP	Sea stories, rope tricks, sea log, musical instruments, ceremonies, skits	NASA tapes, Apollo flight log, skits	Lives of great athletes, Olympic ceremonies, skits and pantomimes, Feets of Skill, den activities	Magic tricks, skits, songs, and musical instruments; Crusades—religious awareness discussion; The Knight's Code	Tom Sawyer Days, Becky Thatcher's Picnic, Parson's Meeting, intercampsite campfire with marsh-mallows, family barbecue and closing campfire, tall tales, paper bag puppet show	Skits and puppet shows, history of the community, My History Record, campfire tales and other projects	American Indian dancing, stories, songs, musical instruments, makeup and attire, special closing
SPORTSMANSHIP	Fishing, marbles, den games	Reaction time model, aeronautics, ultimate, space games	Cub Scouts Sports tournaments	Archery, den and pack games	Indian Joe's Shooting (archery), Twin's Games, Shootin' Irons (BB guns), Country Fair (marbles), Huck's Derby II	Badminton, table tennis, bicycling tournament, tennis	American Indian games, archery, BB gun range, marbles, horseshoes, Covered Wagon Races, den games
FITNESS	Walk the Plank	Time reaction test, food in space, fitness testing, walk on a pair of stilts	Backyard Gym, test skills and individual exercise program for each Cub Scout, write goals and time schedule, rotate exercise to sport of interest, Say "No" to drugs, Den Obstacle Course	Exercises, games/tournament	Funmin' Around	Backyard Gym, swimming, archery, bicycling, soccer, badminton, personal fitness	Test of skills, running, T-Stick Rolling
CRAFTSMANSHIP	Use of pocket knives, costumes, sand sculpture, building projects	Space shuttle glider model, paper rockets, kites/hot air balloons, build a flying model, solar system mobile, other den projects	Trophy making, homemade exercise equipment	Family crest or flag, shields, knight's armor, work with metal	Paper bag puppets, Jim's Whittin' Store, Skimin', folklore neckerchief slide, tissue masks	Make an electric lamp, make a simple electric motor, build a crystal radio, sundial neckerchief slide	Sand painting, sketch scenes in camp, costumes, leather and wood items, birdhouses
NATURE	Weather and wind observations, navigating by the stars, collecting and mounting shells, Tree Hut	Space team to study weather, stars, gravity, motion, geology, rocks, and minerals; rocket power experiments	Learn to swim, water carnival	The Moat	Grave Diggin', Cavalieros	Weather station, Leave No Trace	Johnny Elmseed, box gardens, sundials
WATERFRONT	Swimming, rowing, games, lifesaving skills	Splashdown and Re-entry, swimming	Obstacle course building, first aid demonstrations	Dragon Hunt, building fires	Instructional swimming/boating, rafting, Rafting to Skull Island, Ole "Miss" Water Carnival	Rafting, fishing, boating, swimming	Canoeing, swimming, fishing
CAMPSCRAFT	Knot-tying, Treasure Hunt	Compass and map, Solar Cooker	Obstacle course building, first aid demonstrations	Dragon Hunt, building fires	Lost in the Caves, Aunt Polly's Kitchen, Hannibal Hank's Skills, The Medicine Show	Family Alert, family outdoor living skills, cooking	Leathercraft, family cooking, shelter building

Program Theme Activities

Theme: Sea Adventure



The sea has always been—and still is—the scene of some of humankind’s greatest adventures. Mention sea adventures, and most of us think of John Paul Jones, Captain Cook’s voyages, Magellan’s trip around the world, or the lore of the great explorers who found the New World.

That’s all exciting history. But today the adventure goes on. Now it’s more likely to be deep-sea divers seeking lost treasure, oceanographers trying to unlock the mysteries of the sea, or submariners sailing beneath the surface for weeks at a time.

This theme is wide open for imaginative fun for Cub Scouts.

Showmanship

SEA STORIES

ROPE TRICKS

SEA LOG

MUSICAL INSTRUMENTS

CEREMONIES

CRAFT: Make a periscope from milk cartons.

SKITS

- A scene from *Treasure Island*, *Mutiny on the Bounty*, *Moby Dick*, or other sea stories.
- Sea life: Boys costumed as fish and other marine creatures telling an oceanographer about their lives. See library books for ideas.

- A scene from the life of a famous pirate—Blackbeard, Henry Morgan, Captain Kidd, Jean Lafitte, etc. See library books for ideas.
- “Show and Tell” collections of shells or other marine life.

Sportsmanship

FISHING

COLLECTING

DEN GAMES

Fitness

WALK THE PLANK

Craftsmanship

USE OF POCKET KNIVES

(Use the Whittlin’ Chip rules.)

COSTUMES

SAND SCULPTURES

Den Games

FISH IN THE SEA. All players except one stand behind a line. “It” stands between that line and another line about 40 feet away. He calls “Fish in the ocean, fish in the sea, don’t get the notion, you’ll get by me.” The “fish” then leave their line and try to cross the other line without being tagged. Players who are tagged join “It” to tag others in the next round.

STORMY SEA. Form two-boy teams. One team is “Whales” and is positioned standing in the center. All other teams select the names of various fish and are seated in chairs. The Whales walk around the room calling out names of fish—perch, bass, cod, catfish, flounder, etc. When its fish name is called, each team must get up and follow the Whales around the room. When the Whales shout, “Stormy sea!” all boys run for their seats. The Whales also try to find seats. The two boys who don’t get seats are the next Whales.

SUBMARINES AND DESTROYERS. Divide the den into two teams, “Submarines” and “Destroyers.” Give the Submarines an inflated balloon, which they bat in the air, trying to keep it away from the Destroyers. The Destroyers try to pop the balloon with their hands or feet (no sharp articles can be used). When the balloon pops, change sides and start with another balloon.

BLUB, BLUB, BLUB. Boys sit in a circle. The leader walks around in the center and suddenly points to a seated player, saying, “Blub, blub, blub.” The player must say, “Blub,” before the leader has finished the third “blub.” If he fails, he receives a point. If the leader points at a boy but does not say, “Blub,” the player must remain silent. If the player says, “Blub,” a point is counted. At the end of the allotted time, the boy with the fewest points is the winner.

Building Projects

SPYGLASS. Use three cardboard tubes from paper towels or aluminum foil. Slit two of them lengthwise. Overlap their edges so that they slide easily onto the unslit tube in the center. Tape the slit edges to hold in position.

SHIP IN A BOTTLE. Cut a clear plastic liquid detergent bottle in half lengthwise. Fill one half with plaster, and set a small ship model in it. When the plaster is dry, paint it to look like water. Fit bottom and top together, and fasten them with bright plastic tape. Glue the bottle to a wooden base.

PERSONAL TREASURE CHEST. Make from a salt container and a large-size matchbox with a drawer. Glue a lightweight cardboard collar around the matchbox to increase the depth about a half-inch. Paint or decorate with wood-grained contact paper.

PIRATE SHIP. The hull, forecastle, and cabin are balsa or other soft wood. Masts can be made from toothpicks. The centerboard is a penny glued into a slot in the bottom of the hull. Sails are $\frac{3}{4}$ -inch wide and cut from white writing paper.

SUBMARINE. Fill a vial half full of water. Hold a finger over the opening, turn the vial upside down, and lower it into a jar brimming with water. Remove your finger. The vial should float just below the surface. If it sinks, remove a few drops from the vial. If it rides high, add a few drops. Now, stretch a balloon over the top of the vial so that the rubber is tight. Make the submarine dive by squeezing on the balloon. It should rise when you release the pressure.

Nature

WEATHER AND WIND OBSERVATIONS

NAVIGATING BY THE STARS

COLLECT AND MOUNT SHELLS

TREE HUT



Unlike modern-day builders who standardize everything into 2-foot modules, nature builds trees to be as different as possible from one to the next. Therefore, it is impossible to explain exactly how to build this particular hut because so much of it depends on the peculiarities of the tree you choose to build in.

Waterfront

SWIMMING

ROWING

Games

PIRATES' GOLD HUNT (for nonswimmers). Use pennies, or paint $\frac{3}{4}$ -inch iron washers gold. Scatter them over an area of water that is between waist- and knee-deep. On a signal, the boys try to recover as many “gold pieces” as they can within the allotted time.

USE YOUR HEAD (for nonswimmers). Boys line up in waist-deep water. Give each an inflated balloon. On a signal, they place their balloons in the water and try to propel them to shore without using their hands.

LIVE LOG (for swimmers). Establish a goal at one end of the pool. One boy is the “log.” He floats on his back in the center of the pool. The others swim around him. At any time, the “log” can roll over and chase the others, who must race for the goal. A player who is tagged becomes a second “log,” and the game resumes. Continue until only one boy has not been tagged.

PADDLE WHEEL DUAL CONTEST (for beginners). A kick board with a boy at each end is placed in the water. On a signal, both boys kick as hard as they can to force their opponent backward.

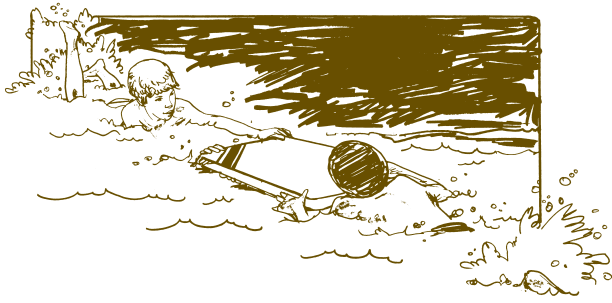

CORK RETRIEVE (for swimmers). Scatter a dozen or more corks or blocks of wood on the far side of the pool. On a signal, boys dive in and try to retrieve the corks, bringing them back to the starting point one at

a time. The winner is the boy with the most corks after all have been retrieved.

WATER SPUD (for either nonswimmers or swimmers, depending on the depth of the water). Use a soft rubber ball. The leader throws the ball into the pool and calls out a player's name. That player recovers the ball while the others scatter around the pool. When the player whose name was called gets the ball, he tries to hit another player with it. He can swim or walk toward the others, but they can duck underwater to avoid being hit. When a player is hit, one spud is counted against him. Three spuds take a player out of the game.

Campercraft

KNOT-TYING

TREASURE HUNT

Theme: Space Station



In 1969, American astronauts Neil Armstrong and Buzz Aldrin became the first humans on the moon. Since then, probes have been sent to the far reaches of the solar system and we have gathered pictures from the surface of Mars.

Today's Cub Scouts are bound to have an interest in space and a knowledge of space flight that astounds leaders of the "Star Wars" generation. Through the Space Station theme, we can enhance boys' knowledge and interest in space as well as provide a lot of fun.

Showmanship

NASA VIDEOS. Videos about the space program are available through your NASA regional film libraries.

APOLLO FLIGHT LOG. An "Apollo flight log" may become the Cub Scout's personal diary of his time at camp.

SKITS

- Prepare a skit about stars in the insignia of the Boy Scouts of America—the Star Scout badge, service stars, and the two stars on the universal emblem.
- Prepare a skit about landing on the moon. Make a "spider" moon landing vehicle out of scrap wood.

Sportsmanship

REACTION TIME MODEL

AERONAUTICS

ULTIMATE (CUB SCOUT SPORTS)

Space Games

CAPSULE RECOVERY. You need a small juice can, a soup can, a No. 2 can, a No. 2½ can, and a craft stick with a string tied around it slightly off-center. In turn, the boys try to nest the cans by lowering the stick into the second largest can, wedging the stick against the lip, lifting the can, and lowering it into the largest can.

Continue with the next largest can, etc., until all cans are nested. This is a speed contest.



Fitness

REACTION TIME TEST

FOOD IN SPACE

FITNESS TESTING

WALK ON A PAIR OF STILTS

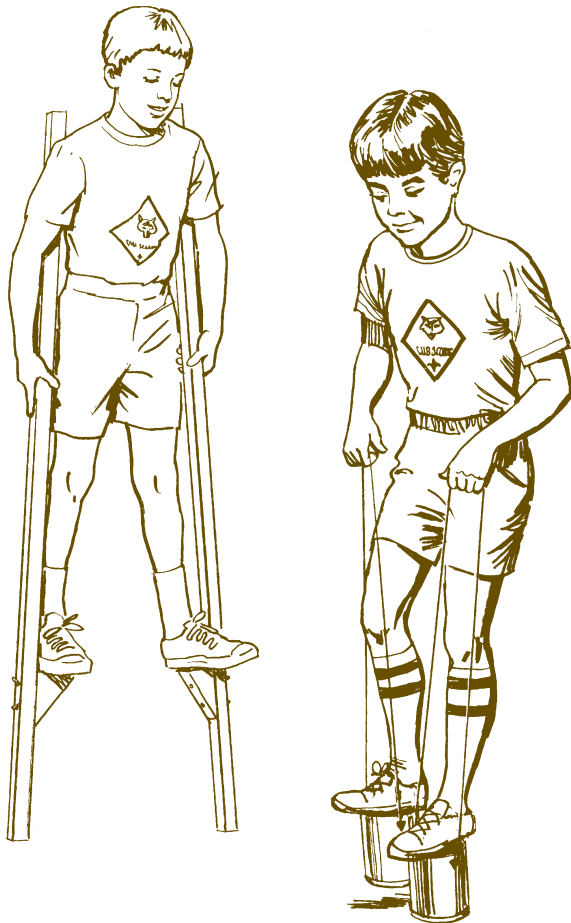

Craftsmanship

WIND CHIMES

PAPER ROCKETS

KITES/HOT AIR BALLOONS

BUILD A FLYING MODEL

SOLAR SYSTEM MOBILE

OTHER DEN PROJECTS. Make a pinhole planetarium (frozen juice or soup cans are best) with a constellation's outline in the closed end made with a pick or nail. (See the Space elective in the *Bear Cub Scout Book*.)

Decorate the ceiling of the den meeting place with constellations made of luminous stars. Make the stars of luminous paper, or paint them with luminous paint (available from stationery, hardware, or paint stores). Ceiling star kits are available from some game, toy, and stationery stores.

From ready-made star charts, or better, from the Cub Scouts' own observations, develop a chart showing the easily recognized constellations.

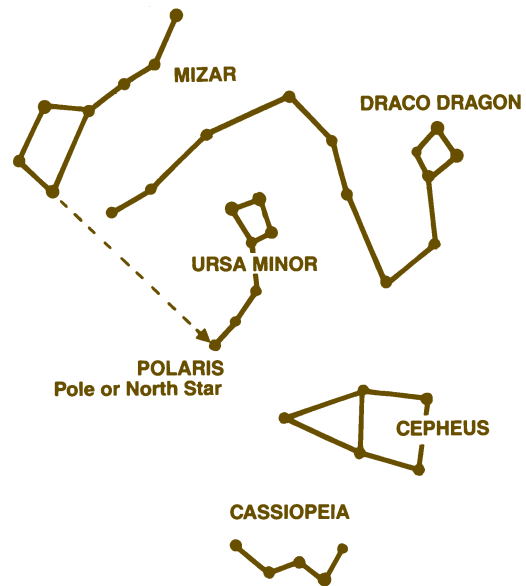

Nature

SPACE TEAM TO STUDY WEATHER, STARS, GRAVITY, MOTION, GEOLOGY, ROCKS AND MINERALS

ROCKET POWER EXPERIMENTS. Blow up a balloon and pinch its neck with your fingers. When you release it, the balloon darts around the room. Its power is caused by the fact that the air pressure opposite the hole is greater than the pressure at the hole and thrusts the balloon in the opposite direction.

Another experiment showing how rocket and jet power works requires a soda bottle, a cork stopper, vinegar, bicarbonate of soda, facial tissue, and two pencils. Fill the soda bottle half full with vinegar. Next, wrap some bicarbonate of soda in a piece of facial tissue: make it small enough to fit through the bottle neck. Put the package in the bottle and immediately insert the stopper. Lay the bottle across two parallel pencils. The vinegar and bicarbonate of soda begin reacting to form carbon dioxide gas. When the gas builds up enough pressure, the cork will pop. The reaction to the release of the gas will jolt the bottle forward on its rollers.

Waterfront

SPLASHDOWN AND RE-ENTRY

SWIMMING

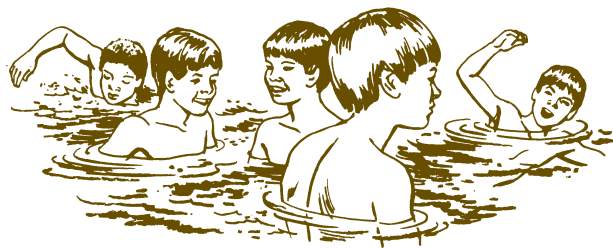

Campercraft

COMPASS AND MAP

SOLAR COOKER

Theme: Athlete

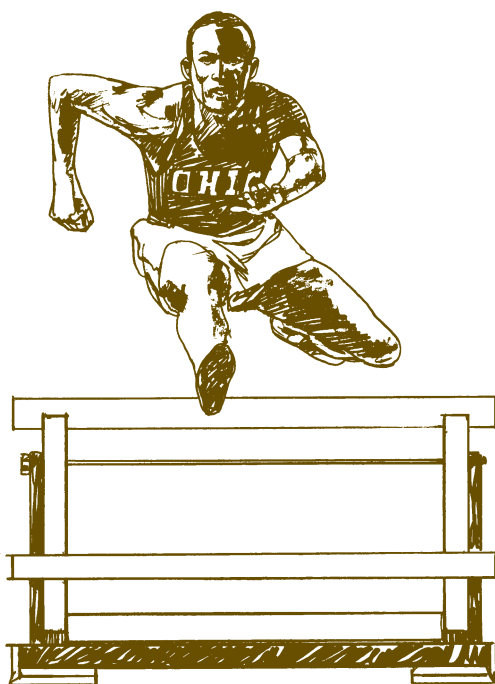

Most boys of Cub Scout age love activities involving physical skills and long to be good athletes. The athlete theme offers plenty of opportunities to satisfy their desires with games and contests. At the same time, it helps their physical development and teaches good sportsmanship.

See page 68 for other sports and fitness ideas.

Showmanship

DEN ACTIVITIES. Do a charade of a track meet.

LIVES OF GREAT ATHLETES

FEETS OF SKILL CEREMONIES

SKITS AND PANTOMIMES. Have a circus strong-man pantomime using fake weights.

Put on a skit using balloon “muscles.” The muscles gradually grow larger as a Cub Scout appears from behind a screen three or four times while the denner talks about a miracle muscle-building substance the boy has been eating.

Hold a demonstration of skills involved in the Feets of Skill and fitness achievements.

FEETS OF SKILL. Cut “feet” from cardboard, fiberboard, or wood. Paint them any bright color. Cut out Cub Scout figures from the same material, and then paint and tack on the “feet” board as requirements are passed.

Sportsmanship

CUB SCOUT SPORTS

TOURNAMENTS. Hold den championship tournaments for arm wrestling and hand wrestling. The den champions will compete in a pack championship.

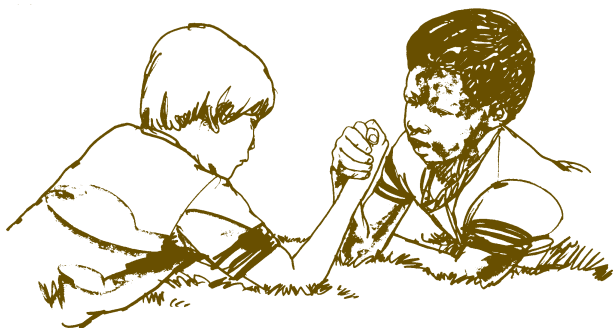

To get as many boys as possible involved, it is recommended that different members represent the den in each event. For example, the den champion in arm wrestling would not represent the den in the other two events, even if he is the den's best at them. In short, share the glory.

Fitness

BACKYARD GYM

TEST SKILLS AND INDIVIDUAL EXERCISE PROGRAM FOR EACH CUB SCOUT

WRITE GOALS AND TIME SCHEDULE

ROTATE EXERCISE TO SPORT OF INTEREST

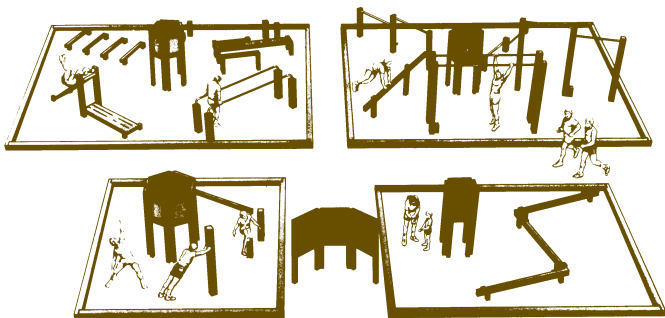

DEN OBSTACLE COURSE. Use your camp's terrain and natural features, plus a little ingenuity, to make an obstacle course. Here are possible obstacles and feats to perform:

- Ring a bell that is hanging 6 feet off the ground.
- Crawl through cardboard carton tunnels.
- Using a water glass, transfer a full bucket of water into another bucket.
- Shoot three baskets from 10 feet away.
- Jump a 3-foot hurdle.
- Walk a 12-foot two-by-four while balancing a hard-boiled egg on a spoon held in your mouth.

Craftsmanship

TROPHY MAKING

HOMEMADE EXERCISE EQUIPMENT. Your Cub Scouts can make this gear with their parents during camp.

Barbells and Dumbbells. Use lengths of stick or 1-inch dowels, fruit and soup cans, and concrete mix with nails to reinforce the concrete.

Bleach Bottle Weights. Fill old bleach bottles with sand for easy-to-make dumbbells.

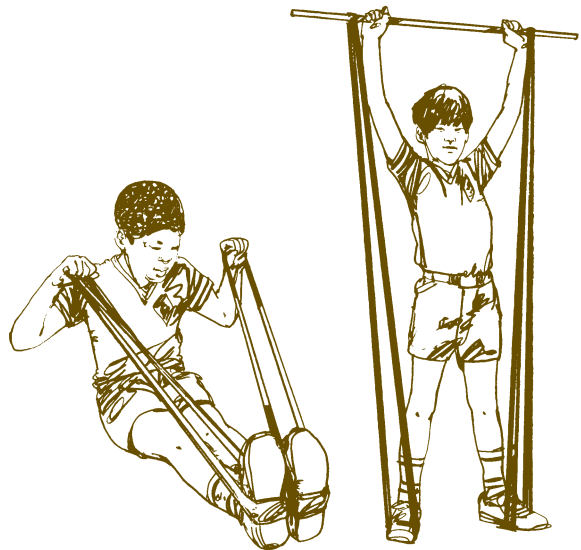

Rubber Tube Gym. Use a discarded bicycle tube and a length of broomstick. If the tube is too tough for your Cub Scouts, slit it lengthwise down the middle to make two exercisers.

Waterfront

LEARN TO SWIM

WATER CARNIVAL. Your water carnival will depend on the camp location. If you have a waterfront area, you will be able to have games and demonstrations involving boats. If you have a pool, boats will be out.

Preopening. Have Cub Scouts and their parents enjoy open swimming. Be sure to observe the safeguards of the Safe Swim Defense plan.

Near the waterside, set up a display area where Cub Scouts can exhibit their collections of water wildlife, shells, and track casts. In another area, Webelos Scouts can demonstrate snorkeling equipment.

Opening. Gather by dens (and families) at poolside and have a Webelos honor guard present the U.S. flag and lead the Pledge of Allegiance. Lead the group in singing "America the Beautiful."

Balloon Relay. Dens line up relay fashion in waist-deep water. Each den is given a balloon. On a signal, the first boy in each den swims or walks to a turning line and back, pushing the balloon with his head. He may not touch it with his hands. The second boy repeats the action, and so on, until all have run. The first den to finish wins.

ROWING DEMONSTRATIONS. Using two or more rowboats, a den demonstrates rowing skills or conducts a race.



SNORKELING DEMONSTRATION. A Webelos den shows its skill at snorkeling.

EGG AND SPOON RACE. Dens line up relay fashion in chest-deep water. Each boy has a spoon, and each den has one egg. On a signal, the first boy in each den puts the egg on the spoon and holds the spoon with his teeth. He then swims or walks about 15 feet to a turning line and returns. If the egg falls off, he must stop and replace it before continuing. The second boy then repeats the action, and so on, until all have run. The first den to finish wins.

PARENT-AND-SON BALLOON TOSS. This is for teams of two. Give each team a balloon and tell them to fill it half full with water. They then stand about 10 feet apart and begin tossing the balloon back and forth. Each time a catch is made, the catcher takes

one step back. When the balloon is missed, the team is eliminated. Continue until only one team is left.

SAVE ME. About 25 feet in front of each den, a T-shirt and pair of shorts is weighted and sunk in chest-deep water. The den is given a 30-foot rope. On a signal, the best swimmer in each den swims to his den's bundle, retrieves it from the bottom, and dons the clothing. He then calls out "Save me!" whereupon the other den members throw the coiled rope to him. He may not swim or walk to reach it. When he grasps the rope, the other den members pull him to shore. The first den that rescues its "victim" is the winner.

RESCUE DEMONSTRATION. A Webelos den demonstrates the "Reach, Throw, and Go with support" methods of water rescue.

CANDY HUNT. Scatter hard candies wrapped in aluminum foil or other waterproof material on the bottom of a pool. Let all Cub Scouts join in the hunt, and watch the fun.

Campercraft

OBSTACLE COURSE BUILDING

FIRST AID DEMONSTRATIONS

Theme: Knights

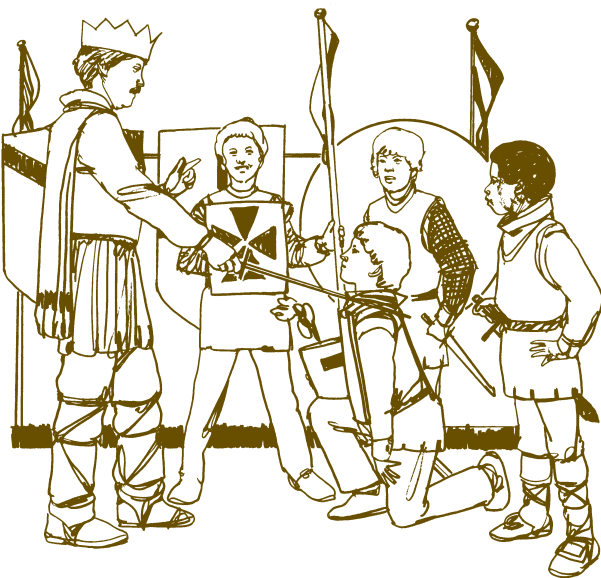

Knights may not be jousting and following their adventures today, but their romance lingers on. The daring and chivalry of the legendary Knights of the Round Table still capture boys' imaginations today, so themes like this one are among the most popular in Cub Scouting.

This theme will give your boys a chance to dress in exciting costumes and make believe that they are lone adventurers seeking to right wrongs and help the helpless. From the leader's viewpoint, the theme offers an opportunity to teach boys courtesy, honesty, and honor without mounting a soapbox because knights lived by a special code that stressed these values.

Sportsmanship in this theme features contests of strength and skill similar to the tournaments held by real knights from the ninth to the 14th centuries. Ceremonies stress knightly values—values that are still valid in today's world.

(A copy of the illustrated classic *Knights of the Round Table* will be helpful as you plan your activities for this theme.)

Showmanship

MAGIC TRICKS

SONGS

MUSICAL INSTRUMENTS

CRUSADES—RELIGIOUS AWARENESS DISCUSSION

THE KNIGHT'S CODE. Explain the Knight's Code, giving examples of how the code is relevant today.

- Defend the poor and help those who cannot defend themselves.
- Do nothing to hurt or offend anyone.
- Be prepared to fight in the defense of your country.
- At whatever you are working, try to win honor and a name for honesty.
- Never break your promise.
- Chivalry requires that youth be trained to perform the most laborious and humble offices with cheerfulness and grace, and do good unto others.

SKITS. Perform a skit about how Arthur was chosen to be king.

Sportsmanship

ARCHERY

DEN AND PACK GAMES

SPEAR THE RING. All boys take part. Suspend the ring from a frame about 6 inches above your tallest Cub Scout's head. In turn, each boy gallops by on his den's "horse" and tries to pick off the ring with a spear or lance. Successful knights compete again with the ring hanging higher and higher until a pack champion is chosen.

SLAY THE DRAGON. All boys take part. Mount the dragon head on a 6-foot pole. An adult slowly swings it back and forth. The boys gallop past and take one swing at the dragon with their swords. Each hit counts as one point for the den. The winner is the den that scores the most hits.

BATTLE ROYAL. All boys take part. Each den is divided into "horses" (larger boys) and "riders" (smaller boys). The rider hops onto his horse's back and wraps his legs around him. He may not hold onto the horse with his hands.

On a signal the battle begins. Horse and rider pairs from each den try to upset those of other dens. Whenever any part of a rider touches the ground, the horse and rider are eliminated. Riders may use their hands to push and pull other riders, but horses may not use their hands. The winning den is the one with the last horse and rider team still standing. (Note: In dens with odd numbers, one boy stays out of the battle until a horse-rider team from his den is upset. He then joins one boy from that team to form a new team.)

TEETERBOARD JOUSTING. Den champions only. (See the illustration for equipment.) When any part of a knight's body touches the ground, he is eliminated. Don't permit boys to swing the padded lance. They may use it *only* to push.

Fitness

EXERCISES

Craftsmanship

FAMILY CREST OR FLAG

SHIELDS

KNIGHT'S ARMOR

WORK WITH METAL

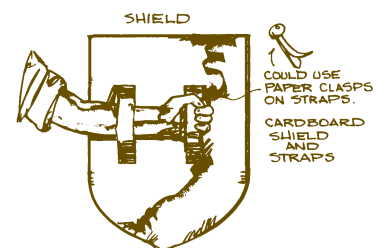
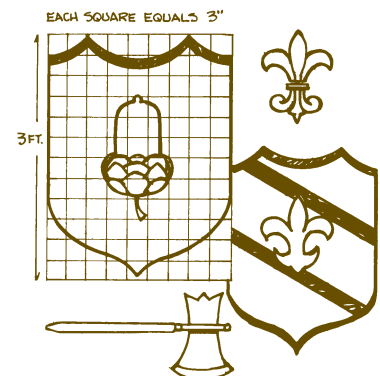
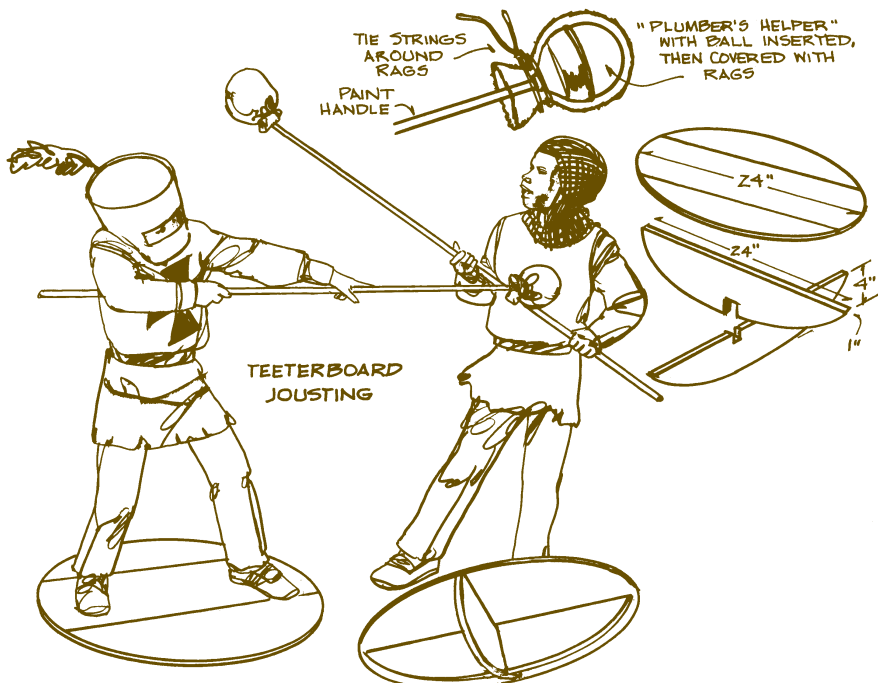

Nature

SHERWOOD FOREST

Waterfront

THE MOAT

ROWING/CANOEING

SWIMMING

Camcraft

DRAGON HUNT

COOKING AND FIRE BUILDING

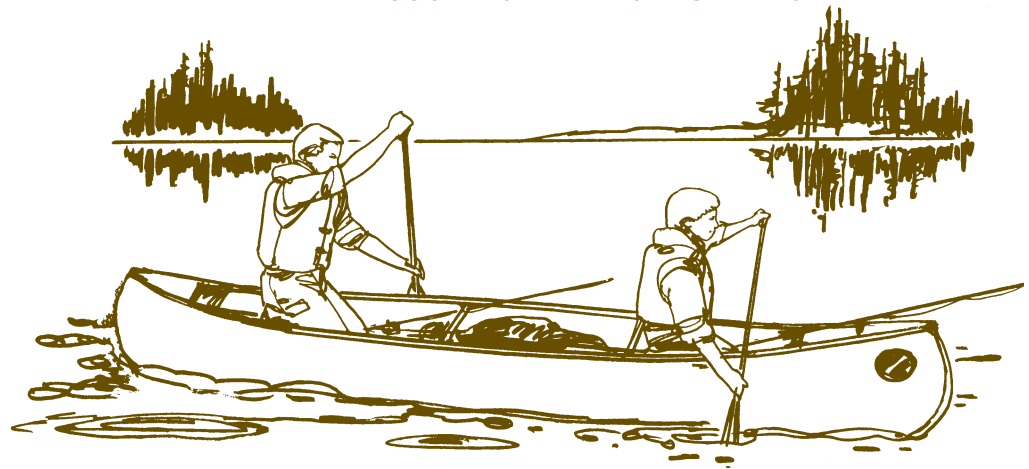

Theme: Folklore



This is the theme for “Let’s Pretend” and “S’posin’ If.” Most Cub Scout-age boys are dreamers and hero-worshippers. The resident camp with a folklore theme will give them a chance to act out their fantasies and, along with their parents, have plenty of fun. Let their imaginations have wide range. They may find characters they would like to be in America’s rich folktales and in *Boys’ Life* and other books and magazines with stories of adventure and derring-do.

Each boy should choose a folklore character for himself. Before camp he can make his costume. In addition, special props and costumes might be needed for a den skit, stunt, or puppet show. It will obviously be easier on you and the boys if the den members can agree on a den act that accommodates the characters

chosen by all the boys. (It’s hard to fit Paul Bunyan into a skit about astronauts.) If you run into conflicts, the easiest solution may be to let the boys be any make-believe characters they like and give a puppet show for their den. Many simple puppets are shown in the *Cub Scout Leader How-To Book*. You’ll also find scripts in that book that can be adapted to fit the folklore theme. For others, check the public library and your local historical society.

Showmanship

TOM SAWYER DAYS

BECKY THATCHER’S PICNIC

PARSON’S MEETING

INTERCAMPSITE CAMPFIRE WITH
MARSHMALLOWS

FAMILY BARBECUE AND CLOSING CAMPFIRE

Tall Tales

Following is an assortment of stories and characters from history, legends, and just plain tall tales that may spur your thinking:

- Paul Bunyan, the mightiest lumberjack
- Ichabod Crane and the headless horseman
- Casey Jones, a real locomotive engineer who became a legend
- Davy Crockett, frontier man and soldier
- Blackbeard, the pirate
- The Mormon trek across the continent
- Buffalo Bill Cody and his Wild West Show

- John Henry, the steel drivin' man
- Tom Sawyer and Huckleberry Finn
- Captain Ahab pursuing Moby Dick, the great white whale
- Johnny Appleseed, who wandered for 40 years planting appleseeds

PAPER BAG PUPPET SHOW. Write a three-minute narration for your puppet show that one of your boys can read while others manipulate the puppets behind a card table stage. The puppets can be of Paul Bunyan, his blue ox Babe, and Johnny Inkslinger. See books on folklore and encyclopedias for pictures and stories of other folk heroes or heroines.

Sportsmanship

INDIAN JOE'S SHOOTING (archery)

TWIN'S GAMES

SHOOTIN' IRONS (BB guns)

COUNTRY FAIR (marbles)

HUCK'S DERBY II

Fitness

FUNNIN' AROUND

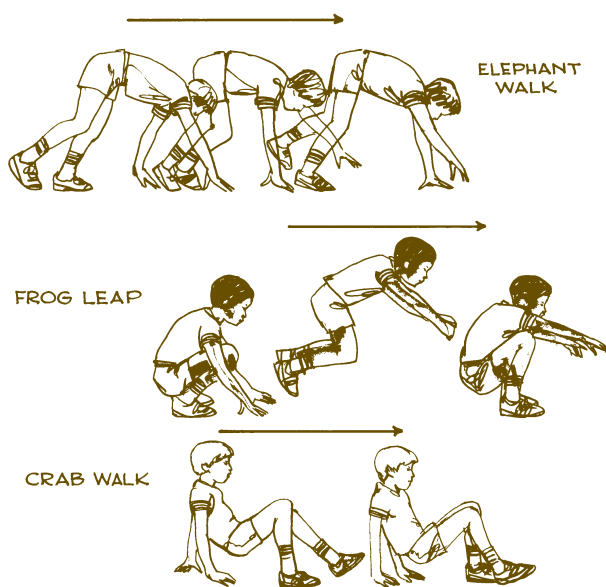

Craftsmanship

PAPER BAG PUPPETS

JIM'S WHITTLIN' STORE (wood or soap whittling)

SKINNIN' (leathercraft)

FOLKLORE NECKERCHIEF SLIDE. Cut out silhouettes of folklore characters from light cardboard and paint them. For the neckerchief ring, cut a 1-inch piece from a toilet tissue roll. Glue or staple it to the back of the figure.

TISSUE MASKS. Blow up a balloon to the size of an average human head. Tape it to a stand, i.e., a cup or a cardboard collar. Mix ½-cup of liquid starch with 1 cup water. Dip facial tissues in the mixture and lay them over the balloon. Use one layer of wet tissues, one layer of dry. Build up 10 or 15 layers. Let dry. Then break the balloon and cut the ball in half to make two masks. Decorate the masks as desired with paints or felt pens.

Nature

GRAVE DIGGIN' (star hike, nature scavenger hunt)

CAVALIEROS (frogs)

Camcraft

"LOST IN THE CAVES" (map and compass orienteering)

AUNT POLLY'S KITCHEN (cooking)

HANNIBAL HANK'S SKILLS (tent setup)

THE MEDICINE SHOW (first aid)

Waterfront

INSTRUCTIONAL SWIMMING/BOATING

RAFTING

RAFTING TO SKULL ISLAND

OLE "MISS" (water carnival)

Theme: The World Around Us

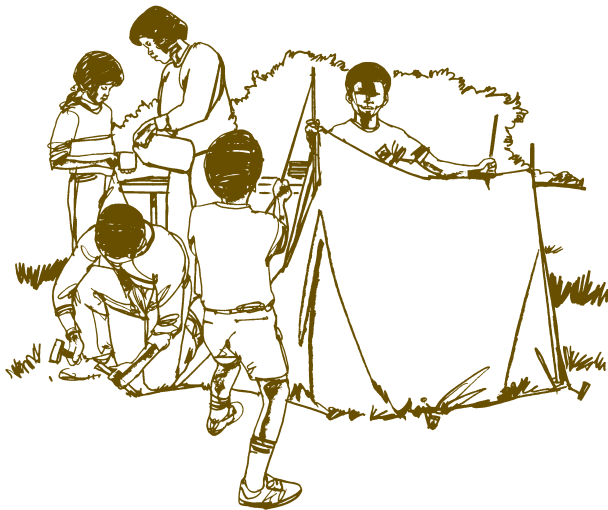

Adventure is always at hand to a boy of Cub Scout or Webelos Scout age. *Boys' Life* magazine helps awaken that spirit of adventure monthly. You are invited to review past issues and bring them to focus during this program theme in your resident camp for Cub Scouts, Webelos Scouts, and parents.

Showmanship

SKITS AND PUPPET SHOWS

HISTORY OF THE COMMUNITY

MY HISTORY RECORD

CAMPFIRE TALES AND OTHER PROJECTS.

Feature stories become tales to tell around the campfire. Dens can develop magic acts.

Sportsmanship

BASEBALL

SOCCER

BICYCLING TOURNAMENT

TENNIS

Fitness

BACKYARD GYM

SWIMMING

ARCHERY

BICYCLING

SKATING

BASKETBALL

PERSONAL FITNESS

Craftsmanship

MAKE AN ELECTRIC LAMP

MAKE A SIMPLE ELECTRIC MOTOR

BUILD A CRYSTAL RADIO

SUNDIAL NECKERCHIEF SLIDE. This slide not only looks good, but it also tells time. It's a fully working sundial, or "sun watch." Sundials have been telling time for thousands of years and are still useful today, especially if you're away from clocks. Outdoorsmen will appreciate both the historic and practical value of this project.

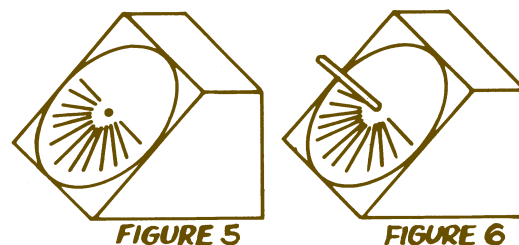
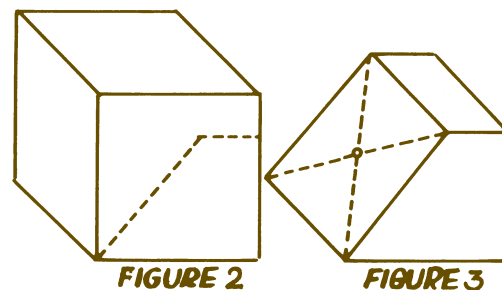
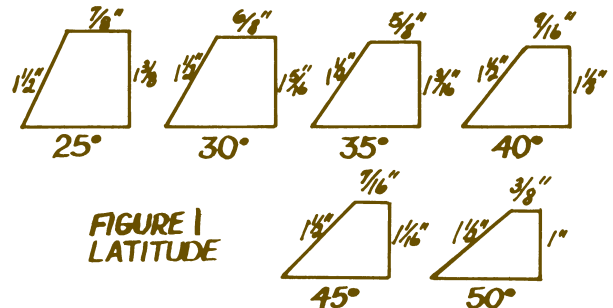

You will need:

- 1½-by-1½-inch block of pine
- ⅛-inch dowel about ¾ inch long
- Coping saw or other small saw
- Drill with ⅛-inch bit

- Wood glue, sandpaper, and shellac (or other finish)

- Leather loop

1. For your sundial to tell proper time, you need to shape it according to the latitude of the place you live. (A sundial made in New York, for example, will not work well in Miami.) Find the closest latitude to your own in Figure 1. The block shape in the figure corresponding to that latitude will be the shape of your sundial.
2. Transfer the dimensions of your particular sundial shape onto one side of your pine block. (See Figure 2.)
3. Put the block into a small vise, and saw the sides to size. (See Figure 3.) Sand any rough edges.
4. Find the center of the dial face by drawing two crossing lines from corner to corner. Drill a $\frac{1}{8}$ -inch hole about $\frac{1}{4}$ -inch deep into the center of the face. (See Figure 3.)
5. Trace or cut out the dial face (Figure 4) and glue it to the block so that noon is at the bottom of the dial face. (See Figure 5.)
6. Put a few drops of glue into the hole, and insert the dowel. Be sure the fit is tight. (See Figure 6.)
7. After the glue dries, apply shellac.
8. After the finish dries, glue or tack the leather loop onto the back of the sundial.

To use your slide to tell time, place it on a flat, level surface and point the dowel north. Read the time from the middle of the shadow cast by the sun.

The sundial gives only actual local time and does not take into account daylight saving or time zones. It will work accurately between March 20 and September 23.

To use the sundial as a direction finder, rotate the dial until the dowel's shadow displays the actual local time. Now the dowel is pointing north.

Nature

WEATHER STATION

NATURAL RESOURCES

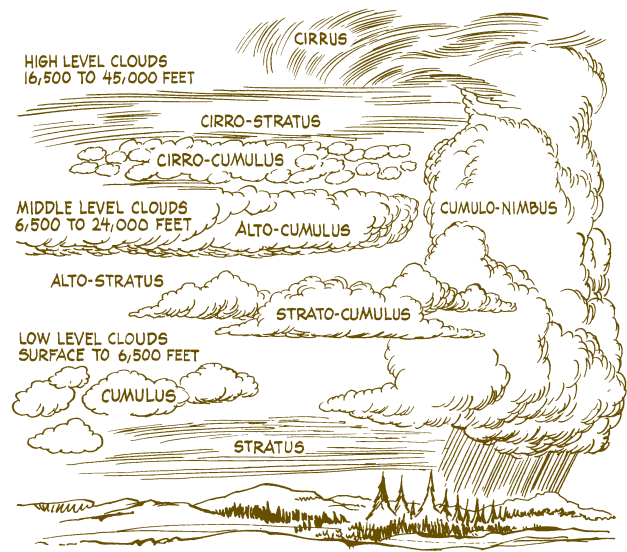

Waterfront

RAFTING

FISHING

ROWBOATING

CANOEING

SWIMMING

Campcraft

FAMILY ALERT FIRST AID

FAMILY OUTDOOR LIVING SKILLS

COOKING

Theme: Frontier Adventure



Wherever you live, your area was once occupied by native people who lived there before Europeans arrived. Many areas in the United States today have lands where native Americans still live. Try to introduce the Cub Scouts to local American Indians or other native American culture, past and present.

Find out who the tribe leaders were (and are) and what they did for their tribe.

America's pioneer period stretched from about 1600 through the late 1800s, but the games, crafts, and attire shown on these pages are appropriate for most of that period. There were local variations, of course. Check the local public library or historical society for things that were popular in your area's pioneer period.

Showmanship

DANCING

STORIES

SONGS

MUSICAL INSTRUMENTS

MAKEUP AND ATTIRE



SPECIAL CLOSING. The den chief or den leader leads the boys in the following prayer with gestures:

May the spirit of Scouting (Boy Scout sign)
And the light of Akela (Cub Scout sign)
Be with you and me (pointing to each person)
Until our paths (spread arms)
Cross (cross arms)
Again (fingers in Cub Scout sign touch wrist of other arm, then elbow, then shoulder).

Sportsmanship

AMERICAN INDIAN GAMES

ARCHERY

BB GUN RANGE

COVERED WAGON RACES

HORSESHOES

FISHING

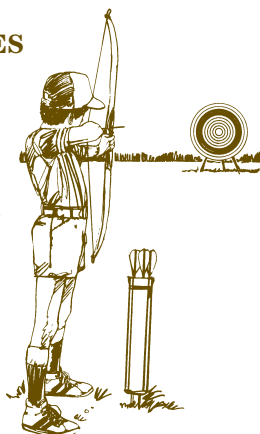

DEN GAMES. Pioneer boys played marbles, tag, leapfrog, hopscotch, and top-spinning. Wrestling and archery were also popular sports in pioneer days.

HOP, SKIP, AND JUMP. This is a contest to see how far a boy can travel with a hop, skip, and jump. (Hop on one foot, skip once, and jump with both feet.) Choose a den champion. You can also play this contest outdoors as a den relay, with each player beginning where the last left off. The winning team is the one that goes the farthest distance.

Fitness

TEST OF FITNESS SKILLS

RUNNING

T-STICK ROLLING

Craftsmanship

SAND PAINTING

SKETCH SCENES IN CAMP

MODELS OF INDIAN HOUSES

INDIAN ATTIRE



LEATHER AND WOOD ITEMS

BIRDHOUSES

HOPI INDIAN DOLLS

Nature

JOHNNY APPLESEED

BOX GARDENS

SUNDIALS

Waterfront

CANOEING

SWIMMING

FISHING



Camcraft

LEATHERCRAFT

FAMILY COOKING



SHELTER BUILDING

MAKING BUTTER. A half pint of whipping cream will make $\frac{1}{2}$ cup of butter. Place the cream in a churn. Let the boys take turns moving the dasher up and down. After 20 or 30 minutes, butter will begin solidifying on the dasher. Shake until all small pieces of butter form one larger piece. Pour off the buttermilk. With a wooden spoon, stir and press the butter to remove excess water. Rinse the butter under running tap water to remove more water and keep the butter from tasting sour. If the finished product tastes too sweet, blend in a pinch or two of salt.



JOHNNYCAKE RECIPE. Corn was the staple food for most pioneers. Often it was served three times a day. For breakfast, it might be served as johnnycakes. Here's a recipe:

1½ cups cornmeal
1 tsp. salt
1 tbsp. flour
2 tbsp. vegetable oil
1 tsp. soda
2 eggs, beaten
1½ cups milk

Mix all ingredients together with a few swift strokes. Drop the batter by spoonfuls onto a hot, oiled griddle. Fry until golden brown on each side.

Games

Three-Legged Soccer

Set up for a regular game of soccer: teams, goals, boundaries, etc. You might want to make the field a bit smaller, though, and have about 20 players on each side. The only modification to regular soccer rules is that the players on each team must pair up and tie their ankles together in three-legged race fashion. Players can kick the ball with either their free feet or their “big foot.”

The goalie might be two people tied back-to-back at the waist.

To add another dash of random craziness, use a rubber football from a variety store. Why not have two balls—one for each team—going simultaneously? Three teams? One goal in the center? Try anything!

Catch the Dragon’s Tail

It’s one thing when a puppy chases its tail—and quite another when a dragon tries it. The difference you’ll find in these “tails” is more than just size.

You’ll need a good-sized area for this game, clear of holes in the ground and trees. About eight to 10 people line up, one behind the other. Everyone puts his arms around the waist of the person in front of him. (You can’t be ticklish around dragons.) The last person in line tucks a handkerchief in the back of his belt. To work up steam, the dragon might let out a few roars.

On a signal, the dragon begins chasing its own tail, the object being for the person at the head of the line to snatch the handkerchief. The tricky part of this struggle is that the people at the front and the people at the end are clearly competing—but the folks in the middle aren’t sure which way to go. When the head finally captures the tail, who’s defeated and who’s the victor? Everyone! The head dons the handkerchief and becomes the new tail, and the second from the front becomes the new head.

Two dragons trying to catch each other’s tails can be formidable—and also a great game. How about a whole field full of tail-chasing dragons?

Standup

Sit on the ground, back-to-back with a partner, knees bent and elbows linked. Now, simply stand up together. With a bit of cooperation and practice, this shouldn’t be too hard.

After you have this mastered, add a third person. Have him join you on the ground, and all three of you try to stand up. Now, add a fourth person. Four people

standing up together might be a tremendous accomplishment.

By this time, you should realize that there’s more struggling, stumbling, and giggling each time you add another person. This game guarantees lots of spectators ready to join in the fun and help you get off the ground.

A gracefully executed mass standup (any number greater than five) is like a blossoming flower—but a more rare event. To achieve it, start by sitting close and firmly packed. Then, all stand up quickly and at precisely the same moment.

Standoff

This one-on-one battle for balance can be played almost anywhere and anytime, and the only equipment needed is you! To play the game, two players stand face-to-face on a level surface at arm’s length. (If one player’s arms are shorter or longer than the other’s, split the difference.) Each player’s feet must be side-by-side, together. The players present their hands with palms facing their partners. The object of Standoff is to cause your partner to lose balance, making contact with your hands only.

If your partner moves one or both feet while you retain your stance, you get one point. If he lunges forward and wraps himself around you in an impromptu “abrazzo,” that’s also a point for you. If both of you lose balance, no one gets a point. The game is won by the player who scores two out of three points.

It is permissible to dodge and feint with your hands, but at no time during the game may players make contact with any part of their partner’s body other than the hands. If such contact is made, no penalties are imposed, but the offending player should reflect upon the real point of the game.

Another version of standoff is inspired by the graceful martial art of Aikido. The players start with their palms together and keep them in contact through each round. The object is still to make your partner lose balance, but sudden moves are not permissible. Played this way, the game becomes a beautiful slow-motion act that looks far more like a dance than a contest.

Note: A long session of standoff can make your arms sore and leaden. *Remember, you can always stop playing.*

Blob

The blob begins innocently enough as a mere game of tag. As soon as a boy catches someone, they join hands. Now the second boy is part of the blob, and they set out, hand-in-hand, in search of victims. Everyone the blob catches (only the outside hand on either end of the blob can snatch players) joins hands with it and becomes part of the lengthening protoplasmic chain. And so the insidious blob keeps growing.

Unlike your run-of-the-mill mad scientist-created blobs, this one is not content merely to ooze along, seeking its prey. It gallops around the field, cornering stray runners and forcing them to join up. (You'll have to agree on boundaries for this game; some people will go to any lengths to avoid being caught.)

Moreover (horrors!), the blob can split itself into parts and, with its superior communal intelligence, organize raiding parties on the lone few who have managed to escape. The thrilling climax occurs when only one player is left to put up a heroic last-ditch stand on behalf of humanity. But alas, there is no defense against the blob, and humanity succumbs. (If that seems unfair, well, that's the plot.)

If time permits, you can have the last person caught start the blob for the next game.

Caterpillar

Get everyone lying on their stomachs, side-by-side. Be sure you're packed closely together and have any little people squeeze between two big ones. Now, have the person on the end of the line roll over onto his neighbor and keep rolling down the corduroy road of bodies. When he gets to the end of the line, he lies on his stomach, and the next person at the other end starts rolling.

Once the momentum is going, there'll be no stopping the human caterpillar as it advances over meadows and hills. How about assembling two caterpillars for a cross-country race?

Hunker Hawser

This game is sure to prove that “the bigger they are, the harder they fall.” If you like one-on-one competition, here it is—along with a real surprise as to what can knock you off your pedestal.

Pedestals are about 6 inches high and small enough so that players can't move their feet without losing balance. (A good mount might be a block of wood or plastic foam, a tree stump, or an overturned cooking, flower, or chimney pot.)

Players hunker down on their platforms, which are set about 6 feet apart, each holding one end of a rope about 1 inch in diameter and at least 15 feet long. The excess rope lies coiled between the players—but not for long.

On a signal, the players begin reeling in the ropes. The object is to cause your opponent to lose balance by tightening or slackening the rope. Sound simple? “Oh, I'll just give a good pull and...” Suddenly your opponent relaxes his hold, and over you go in a spectacular backward somersault—defeated by your own energy. In fact, the more aggressive you become, the more vulnerable you are. The whole idea of how to win becomes as topsy-turvy in this game as the pot on which you're standing.

Knots

Knots is a game that gets people together by pulling them apart. About a dozen players can “tie on” a good one.

To form the knot, stand in a circle, shoulder-to-shoulder, and place your hands in the center. Now, everyone grabs a couple of hands. If you ever want to get out of this, be sure that no one holds both hands with the same person or holds the hand of a person right next to him. It might take a bit of switching around to get the knot tied correctly. (If you have too much trouble tying the knot, you might want to quit before you try untying it!)

Now comes the true test. You'll probably notice that there are two basic approaches to untangling the knot. Some dive right into the problem—under, over, and through their teammates—hoping they'll hit upon the solution. Others might well hit upon the solution firmly rooted, hands locked in a dignified tableau, carefully surveying the situation before instructing each player precisely where to move and in what order.

Because you're all in the same tangle together, you'll have to come to some agreement as to which approach to follow. (Note: Pivoting on your handholds without actually breaking your grip will make it smoother and eliminate the need for a chiropractor.) When at last the knot is unraveled (hurrah!), you will find yourselves in one large circle or, occasionally, two interconnecting ones.

Every once in a while, someone will discover the one tangle that prevents the knot from resolving itself. At this point, no other remedy being possible, it may be necessary to administer emergency “knot-aid” (a momentary break in hands) so that you can get on to the next game.

Campfires

A campfire can be big or little; formal or informal (usually the latter); a setting for storytelling, drama, mystery, or American Indian lore; a guest night, stunt night, or songfest. Its purpose should be entertainment, adventure, education, inspiration, action, fellowship, or leadership development. The location and construction are important, but most of all, it's the program that counts. Use the Campfire Program Planner (No. 33696) to plan each campfire.

Program Planning

1. Determine who?, what?, where?, when?, and how?
2. Develop a *written* program, including even the titles of songs to be sung.
3. Check all items in advance—offensive, off-color, or questionable songs, jokes, and stunts have no place in a Cub Scout campfire program.
4. Use Scouting literature:
 - Cub Scout Songbook* (No. 33222)
 - Group Meeting Sparklers* (No. 33122)
 - Cub Scout Magic* (No. 33210)
 - Cub Scout Leader How-To Book* (No. 33832)
 - Webelos Leader Guide* (No. 33853)
5. Use the four S's to plan a successful campfire:

Songs. You can quickly change the mood at a campfire by choosing one of these song categories: Cub Scouting/Webelos Scouting songs, peppy songs, action songs, special-occasion songs, novelty songs, quiet songs.

Stunts. A stunt can be the main event of the campfire, or it can be used to build on the theme of the main event. Types of stunts that can be used include action stunts, physical or mental contests, humorous stunts, mixers, “magic,” and special mechanical and chemical firelighting (careful—firelighting can be dangerous if precautions are not taken).

Stories. Adventure stories, hero stories (biographical), nature stories, science fiction, ghost stories (use common sense)—all are popular at campfires. The Cubmaster's Minute can be inspiring.

Showmanship. Use showmanship to give sparkle and life to the campfire. Dress up the setting and plan for costumes when appropriate. Plan an opening ceremony that sets the right tone for the campfire program. Vary the pace and timing of activities to keep interest high—plan for lots of pep when the fire leaps high. Make sure everyone participates; encourage enthusiasm, but maintain discipline at all times. Plan for a closing ceremony that will be quiet and inspirational as the embers of the campfire die.

Suggestions for a Campfire Program

Your camping attendance will determine whether or not you conduct one large campfire program or several smaller ones. When an amphitheater-type arrangement is not available, a group should not exceed 60 people. This will allow everyone to see and hear what is going on.

Because this is a Cub Scout event with adults attending, discipline might not be the challenge it can become with Boy Scout events; however, don't count too heavily on the parents if you allow the group to get too large.

Setup of the campfire program and the physical arrangements for building, lighting, and cleanup should be an “adult only” function, handled and determined in advance by the staff.

Give Webelos dens assignments for skits, songs, or cheers.

Storytelling can be successful with Webelos Scouts, providing the storyteller knows how to command and hold the audience's attention.

The master of ceremonies should be a staff member selected for the ability to handle boys and a strong, clear voice.

“Cheers” and “howls” should be encouraged; “boos” must not be permitted. Stop the first “boo” or catcall, and you won't have any more.

Sample Campfire Program

Opening: A torch carrier dressed in American Indian costume is one way to light your campfire; there are other ways, depending on whether you want to start on a serious or humorous note. (An arrow wrapped in gauze at the center can be dipped in isopropyl alcohol, lighted and held aloft, and with appropriate words, used to light the fire.)

Song: Open the program with a song sung by the staff. Use songs from the *Cub Scout Songbook* that are well-known, such as “I've Got That Cub Scout Spirit.”

The rest of the program should alternate songs, stunts, and cheers until the fire begins to die down.

Story: As the fire begins to die down, bring out your storyteller. If relating an American Indian story, have the storyteller dress in native costume.

Closing: Conclude with a short inspirational message by one of the staff. (See *Cub Scout Ceremonies for Dens and Packs*.)

After everyone is gone, be sure the fire is out!

Campfire Stories

(Excerpted from *The Boy's Entertainment Book*, by Bob Smith.)

Anyone who tells stories should know them well and should go all out to set the proper mood for the occasion by insisting on the following:

- Dim lighting (a dying campfire); complete darkness is not a good idea.
- Absolute silence and complete attention. Any tendencies to wisecrack must be promptly checked lest the story be spoiled for both the storyteller and the audience. The right mood depends on good rapport between narrator and listeners, which must start at the very beginning of the story and grow with it.
- The best effort to tell it in a “story” manner. The storyteller must get in the mood first, “feel it,” and then tell the story so as to build up a solemn acceptance of things unreal, which increases to total involvement (with ghost stories, to a tense, flesh-creeping excitement). If the story has a “Boo!” ending, the final buildup must be full of scary breathlessness until all are “on the edges of their seats” for the sudden “GOTCHA!” A jump toward a section of the listeners is a recognized and acceptable part of the act that boys enjoy.

The story ending is usually followed by dead silence, and, when voices begin, they are likely to be subdued, in keeping with the effect that has been created. After a short pause, close the evening with a quiet song or other serious note. Young listeners of campfire stories relish this sensation. It gives them such a satisfying sense of participation in something thrilling that whatever else may have transpired, the evening is a big success and one that will be remembered and talked about.

The Old Ones

(A Tale of Burning Fox)

The Great Cold Bear of the North was growling through the forest and shaking the lodges of the Towedoes, but within the boys' council lodge were warmth, and friendship, and a happy feeling of well-being.

No other lodge in all the village was so well built or so skillfully designed as this second home of the young braves-to-be of the Towedoes. A large fire burned in the center, yet a strange thing was seen. For despite the winter wind that howled all around and over the lodge, the smoke still flowed up and out of the smoke hole.

The boys knew that in their own lodges the breath of the Great Cold Bear oftentimes drove the smoke back into their faces. How he must rage to know that Burning Fox, the Teller of Tales, had outwitted him.

The boys sat cross-legged, watching the flames slowly fall back into a great glowing heap of embers. They had sung their tribal songs and boasted of their deeds in contest and hunt and the things they had seen and done in the forest. They had danced and acted out their tales of adventure, even as did the braves of the tribe in the Warriors' Council Lodge.

Now a great stillness descended upon them as each boy sat wrapped in the golden dreams that come only to those who sit before the fire of friendship. They knew Burning Fox would not speak until the chosen moment, and there must be no sound to disturb his spirit's sitting in council.

As living embers flamed and faded within the mass of glowing coals, creating wondrous pictures of animals and birds and human beings, the chosen moment came for Burning Fox to speak.

“Braves-to-be of the Towedoes, mighty men of the future, fathers of the people-who-will-be, I would speak of Singing Arrow.”

“Speak to us of Singing Arrow,” said the boys, all eyes upon him. “Burning Fox, we wait for you.”

“Then listen well, and I will tell you of Singing Arrow and the Old Ones before his name was Singing Arrow; when he, as you, was still a youth, a brave-to-be, a not-yet-warrior. Listen well and I will tell you.

“Long, long ago before the days of the fathers of our fathers' fathers, there lived a young brave-to-be of the Towedoes, known to all as Singing Beaver. Mischief-loving, happy-hearted, friend to all was Singing Beaver.

“It was the time of snows, and the Great Cold Bear was on the prowl through the forest, even as he is now. His cold, icy breath was bringing snow and wind from the North, and there was much hurrying to and fro in the village of the Towedoes.

“The lodges prepared to meet the full rage of the Great Cold Bear, the children gathered in, and the hunters returned from their hunting. Some came back to the village bowed by the weight of game; others walked straight with all their arrows and empty hands. All were glad to seek the shelter of their own lodges.

“It was even then that Singing Beaver went out into the forest alone, into the very teeth of the Great Cold Bear of the North. For Singing Beaver had heard of the Old Ones, who had been left to die in the Halfway Cave where the River of Pines came down the Black Mountains.

“The Old Ones were not of the Towedoes. They were members of a wandering tribe from a land far into the sunset, and now, too old to earn their place by the fire, they had been left behind to die when their people moved on. Singing Beaver heard some of the returning hunters speak of the leaving of the Old Ones, and his heart quickened with anger and sorrow.

“How could they leave behind them the Old Ones, who through so many moons and snows had kept the fire burn-

ing for others? It was a very bad thing to do, and nothing good could come of it.

“But the Towedo hunters would not heed his words.

“‘It is not of our doing,’ they told him. ‘They have never sat before our fires. They are not of the Towedoes.’

“‘But they are children of the Great Spirit,’ cried Singing Beaver. ‘They have kept the fire when they were able. They should be warmed and fed now that they are old.’

“‘Trouble us not,’ said the returning hunters, impatient to get to their own lodges. ‘We have our own people to warm and feed. Those Old Ones will soon sleep. The Great Cold Bear will see to that. He will come for them. Never fear.’

“So the hunters brushed the boy aside and went their way to their lodges.

“Singing Beaver hurried to his father’s lodge, but only to get food, warm robes, and bows and arrows. Buffalo pack and quiver on his back, bow in hand, he stole quietly away, and no one marked his going.

Never before had he taken leave of his father’s lodge without his father’s word, and his heart was heavy within him. Yet, he dared not risk the question that might bring the words of refusal he could not disobey.

“So, Singing Beaver went out to follow the River of Pines through the forest to where it comes falling down the Black Mountain close by the Halfway Cave.

“Ever more fiercely the Great Cold Bear growled as Singing Beaver made his way, head bowed against the wind and driving snow. If the snow breath of the Great Cold Bear were not so thick, he would have taken another, shorter trail he knew, but he dared not leave the river. As long as the river lay on his bow side, all was well, he reasoned.

“Later, he wondered if even this could be true, as the Great Cold Bear roared with such fury he feared he might lose the river itself. Once he almost plunged into it when he suddenly found it right before him. His body grew colder at the very thought of falling into its icy waters.

“But now he was nearing the Halfway Cave. The trail by the River of Pines was twisting upward, and there were rocks against which he stumbled...and fell. Suddenly, a glowing eye winked at him through the snow. It was the faint, flickering fire of the Old Ones. They had been left without food or warm robes and now sat huddled before their dying fire, waiting patiently for the coming of the Great Cold Bear of the North.

“Singing Beaver wrapped warm robes around them and then went out to find more wood. Piece by piece he wrestled precious fuel from the very jaws of the Great Cold Bear. He fed the fire until its warmth brought new life to the Old Ones. He brought more wood to keep the fire during the long night.

“Though cold and weary from his journey along the River of Pines against the full wrath of the Great Cold Bear, Singing Beaver worked hour after hour to find enough wood to keep the fire, however great might grow the fury of the Great Cold Bear.

“Then he fed the Old Ones from the food he had brought with him. And then, with the fire standing guard against the cold and the snow, Singing Beaver lay down and slept

beside the Old Ones. The three slept together under the warm robes the boy had brought from his father’s lodge.

“By morning, the growling of the Great Cold Bear had ceased, and all was still as the forest lay sleeping under its heavy blanket of snow.

“While sharing his food before the fire, the Old Ones told Singing Beaver he should not have come. ‘You have saved us once from the Great Cold Bear of the North,’ they told him, ‘and our hearts are grateful. Yet, we must die. You cannot stay with us; you must return to your father’s lodge. Our people have forsaken us. Our time has come.’

“‘Not so,’ said Singing Beaver. ‘The Towedoes will welcome you to their lodges. You will find warmth and food and shelter with us. You shall be as our own Old Ones, honored and respected.’ Yet his heart was cold within him, for he feared his people would not receive the Old Ones, for they were not of the Towedoes.

“Singing Beaver brought in more wood, seeking it out under its cover of snow. Then he went in search of game.

“Down where the River of Pines stretched away from the Black Mountains was a hollow thick with pine, fir, and hemlock. There, the boy came upon a deer, struggling to escape through the snow. Singing Beaver’s arrow sped true, and the deer’s lifeblood leaped forth to darken the snow.

“Singing Beaver bowed his head to ask forgiveness of the deer’s spirit and to give thanks to the Great Spirit of All Life.

“Then he prepared to drag the deer back to the Halfway Cave. He cut branches of fir and bound them together until he had enough to support the deer. He placed the deer upon this fir drag and made it secure with another deerskin thong from his belt pouch.

“Then he bent his shoulder to the task of dragging the deer up through the snow to the Halfway Cave. The Old Ones came out to meet him. The old man helped him skin the deer while the old woman busied herself cooking the fresh meat. Then they feasted and rested.

“The gaunt, grey wolves were almost upon them before the three sensed their danger. Maddened by the scent of the freshly killed deer, the hungry wolves had forgotten their natural fear of humans and now came charging up the slope toward the cave. Singing Beaver and the Old Ones knew these terrible wolves would not stop for the fire that burned in the cave’s mouth.

“The boy strung his bow with the sure speed his father, Great Bow, had taught him. The old man handed him an arrow. With one swift motion, the youth bent the bow, and the arrow fairly sang its way into the first wolf.

“The old man was ready with a second arrow, and again the bow bent swiftly, as this arrow, too, sped true to its mark. But the wolf pack had reached the mouth of the cave, and Singing Beaver and the old ones might have gone down before them had not the old woman seized several burning brands and flung them into the faces of the hungry wolves. Howling with pain and fright, the wolf pack broke and fled. Before they could come on again, Singing Beaver heard shouts from down the slope. His father, Great Bow, was hurrying toward them with several other hunters. The wolves quietly vanished into the forest.

“Singing Beaver went forth to meet his father. The Old Ones hastened to rebuild the fire and cook more meat.

* * * * *

“In the Council Lodge of the Towedoes, Singing Beaver came before the assembled people of the Towedoes.

“Singing Beaver’s father went with him to the Council Lodge of the Towedoes, but once inside, Great Bow took his place among the others. Singing Beaver stood straight as a young pine, waiting for some sign of recognition.

“Loping Wolf, Leader of the Towedoes, turned his head toward One-Eyed Owl, the Healer, who beckoned to Singing Beaver. Singing Beaver came forward and stood before One-Eyed Owl.

“As an arrow, you went forth into the storm from the lodge of Great Bow, your father,” said One-Eyed Owl. “Straight and true you went to save the Old Ones from the Great Cold Bear of the North. With courage and skill you fought your way through the wind and snow. With arrows that sang you slew the deer for food and the wolves that would drag down you and the Old Ones.

“The boy that was Singing Beaver is no more. He is gone from us forever. You are now a brave-in-being; you are now Singing Arrow, one who dares to fight for what he knows to be right; one who stands strong for what is good and true. You are a worthy son of your father, Great Bow. May he ever be as proud of his Singing Arrow as he is this day. May the blessing of the Great Spirit of All Life be ever with you, Singing Arrow, as you go your way along the trail your soul shall lead you to.”

“Singing Arrow knelt before One-Eyed Owl, and the Healer placed around his neck a necklace from which hung bright arrows of porcupine quills. The Healer took his place, and Loping Wolf placed a scarlet feather in the scalp lock of Singing Arrow. Then the leader touched the shoulder of the new brave of the tribe, and Singing Beaver grew into Singing Arrow.”

All was still in the Boys’ Council Lodge as Burning Fox finished his tale. All eyes shone brightly with the dreams of those who would also be as Singing Arrow—people who dared to fight for what they knew to be right, who would stand strong for all that was good and true.

The Ghost of the Lost Hunter

There is no reason you can’t teach a lesson with a ghost story, and this one is really out to accomplish something for those organizations with “firewood” trouble. Because it has several endings, you can tell it differently each time.

It is traditional among hunters and campers to leave a pile of wood for the next person or group that may use a campsite after they have gone. The next campers may arrive tonight or in the rain, and a ready supply of wood can mean a great deal. Moreover, it is ordinary out-of-doors courtesy—a part of the code of the woods.

Indeed, a good woodpile is one of the surest signs of real campers. They check their wood supply when they arrive and from then on make sure that it is always adequate and protected from bad weather. Campers are particularly careful that there is enough wood for the night and the following

morning. Only greenhorns run out of firewood and move on without leaving a neat pile for those who follow.

But there *are* greenhorns—poor campers who know no better, or knowing, don’t care. Thus comes the tale of the Lost Hunter.

It was in the summer of 1925 that Al and Jack were sitting by a campfire near Eaglesmere in the Allegheny Mountains of Pennsylvania, with some 90 other Boy Scouts from Philadelphia who were getting a summer of camping by caddying for their board.

Al and Jack had made sleeping bags of their blankets and ponchos and had stowed them behind a tree near the campfire circle so that they might spend the night there, in the woods, instead of returning to camp with the others. This was to be one of their nights in the open for their Camping merit badge.

However, Al and Jack were a little sorry they had picked that particular night as they watched the flashlights of their brother Scouts move farther away down the winding trail to Camp Kerodoko. The closing story had been a creepy one, so that as sure as they were that there were no such things as ghosts, they couldn’t help wishing the night were not quite so dark and that they did not feel so awfully far away and alone up there in the woods by themselves. Besides, were they *really* certain there were no ghosts or other creepy creatures in the woods?

Those fire tenders had soaked the fire down so carefully that there was not one single spark left. A few glowing embers would have been so cozy. Their pleas of “We’ll watch it carefully” had been countered with “You’re going to sleep like good Boy Scouts, so why do you need a fire?”

And so, there they were in the dark—except for their flashlights. There was really nothing to do but go to bed, so they placed their improvised sleeping bags side-by-side, took off their sneakers, loosened their socks, and crawled in.

“Well, anyhow,” said Al, “we can be as loud as we want because they won’t hear us up here, taps or no taps.”

“Yeah,” Jack agreed, “we don’t have to talk in whispers.”

Yet strangely enough, that is exactly what they did. Perhaps it was habit, or maybe they were tired and sleepy. Or could it have been because they didn’t care to be heard by anyone, or anything, that might be prowling around in those woods? But then, there was nothing in the woods that would harm them—or was there?

Whatever the reason, they talked in whispers and listened to all the sounds around them—the wind rustling through the branches, the katydids, and a whippoorwill. Soon, even the whispering ceased.

Suddenly Jack started as a hand brushed across his face.

“Just wanted to make sure you were still there,” whispered Al nervously. “It’s so dark and creepy, I’m scared.”

“You’re not the only one,” said Jack.

The boys wriggled inside their blankets until they could feel the outline of each other’s bodies. They whispered a bit more and then were silent, listening to each other’s breathing. Finally, they fell asleep.

It was sometime later during the night when Al woke up. Forgetting where he was, he sat up, feeling for the familiar board side of his tent platform but finding nothing more substantial than air. Then he remembered. He could hear Jack's even breathing beside him. This calm evidence of his friend's nearness reassured him somewhat, but it was so dark and still. If only he could see something! But there was not a star in the sky, not one tiny bit of light anywhere.

And then, almost as if in answer to his unspoken wish, the clouds parted abruptly, and the light of the full moon came down through the trees to light up the campfire circle.

And that's when Al saw it!

A figure moved silently around the far side of the council ring, stepping carefully over the logs the Scouts used as seats. The figure was carrying something in both arms. Oddly enough, it appeared to Al as though the figure were carrying a load of firewood. Al's instinctive fear was mingled with astonishment as he watched this mysterious figure make his way to the place where they kept their supply of wood for the campfire, where he slowly knelt to place the load he was carrying between the beech tree and the two stakes that had been driven into the ground to serve as the other end of this outdoor woodbin.

In the bright moonlight, Al could plainly see that it was a heavyset man, dressed for cold weather and wearing a hat such as his grandfather wore on the farm in an old picture in the family album. The man seemed to be looking around as though he had lost something or wasn't quite sure where he was. He rubbed the back of his hand across his forehead and eyes.

Then he started to leave but paused to pick up several pieces of wood that were lying scattered on the ground. These he placed neatly with the wood he had brought. Then he silently left the way he had come.

Al woke Jack as quickly as he could, holding one hand over his friend's mouth, but by the time Jack had struggled into a sitting position, the mysterious figure had vanished.

"But there was somebody," Al insisted to his sleepy and dubious friend. "I saw him carry a load of firewood and set it down right where we always store wood for the campfire. You know, over there by the beech tree. I saw him as plain as anything."

"In that case, the wood must be there now," said Jack, "and I can tell if it is because I was sitting right next to that woodpile. There were only three or four pieces left, and they were scattered around where somebody dropped them. So, we'll just go take a good look."

Clouds now obscured the moon once more, leaving the campfire circle in darkness.

The boys groped for their flashlights, crawled out of their warm blankets, and stepping gingerly in their stocking feet, made their way over to the beech tree.

Their flashlights clearly revealed a neat pile of wood where only several loose sticks had been left when they had turned in for the night. Even these loose sticks had been placed on the pile, just as Al had claimed. Al and Jack stared at each other in alarm. How do you explain a thing like that? Who or what did it? And why?

They played their lights around them but saw nothing other than the trees and shrubs and the logs around the campfire circle. It was now so still in the woods one might think that everything was listening with them.

"Do you think we'd better go back to camp?" Jack asked.

"N-no," said Al, trying to convey a firmness he was far from feeling. "We'd just have the pants laughed off us, and besides, whoever it was didn't do anything but leave some firewood. No harm in that, is there?"

"No, I guess not," Jack agreed, "if that's all he does."

Two thoughtful boys climbed back into their blankets and lay listening quietly in the darkness. Admittedly frightened, they nevertheless stayed where they were and, in the morning, agreed to say nothing about it to the others. Al was positive about what he saw; Jack was just as certain the wood wasn't there when they turned in, but it was all so fantastic.

So they keep it secret until a year later, when two other Scouts, sleeping out by the campfire circle, had come running back into camp at night, scared stiff and claiming they had seen a man dragging a log through the woods.

When they calmed down a little, Al questioned them closely about the man's appearance. Their description, though a little confused because of their obvious fear and poorer light than Al had had the year before, tallied somewhat with his own observation.

Al, Jack, and some of the other Scouts went back with the two boys who had seen the figure, to check on the log. They found a log right where the boys said the mysterious figure had left it, which was the exact place they always chopped their wood for campfires, but there was some disagreement as to whether or not it was there before.

It was then that Al told the story of what he had seen the year before. Completely bewildered, the Scouts returned to camp—some skeptical, some scared, the others not certain what to think.

The next day Al mentioned both incidents to an old mountaineer who worked on the grounds of the golf course, and from him he got the story of the Ghost of the Lost Hunter.

It was back about the turn of the century, according to the story, when four hunters made camp one December day near Laporte, across the mountain from Eaglesmere. It was late in the afternoon when they arrived at the cabin that served as their camp, and, to their dismay, discovered little firewood on hand.

As a storm was obviously brewing, they had no time to lose. While one of the Lane brothers started a fire and got supper under way, the other hunters scattered to bring in more wood. They had hardly begun this chore when the snow began to fall.

After several trips back with wood, it suddenly occurred to the Lane brothers and Jerry Anderson that none of them had seen Jordan Bates for some time. Charles Lane recalled seeing him dragging a small log along a gully about the second time he had gone out for wood. No one else recalled seeing him at all. It was not quite dark, and the snow was falling heavily.

Worried, the men went out to search for Jordan, calling his name continually in the hope that he might hear them,

and also to keep in contact with one another. Once Jerry Anderson thought he heard a faint “hallo” in the distance, but he got no reply to his shouts and was unable to definitely fix any point of origin for the voice he thought he heard.

Taking turns watching the fire, the men continued to search until exhausted. In the morning they sought help, and a posse formed to comb the woods. The snow was very thick by this time, and with the passing of another day, there remained little hope of finding the lost hunter alive. Still they continued the search for two more days, after which they generally agreed that there was little likelihood of finding Jordan’s body until the snow melted in the gullies and hollows.

As a matter of fact, no trace of Jordan Bates was ever found; that is, no one ever discovered his body, or clothing, or any personal effects. But it was not the end of the story of Jordan Bates.

For it wasn’t long until hunters began to tell strange stories of seeing a man who looked like Jordan dragging a log through the woods, sometimes appearing around camps. When seen in camps, he would usually be bringing firewood, and more than once, men swore that firewood had actually been left, piled neatly, where little or none had been when they turned in for the night—just as Al and Jack had claimed about the figure Al saw at Camp Kerodoko.

The first few years after his disappearance, Jordan, if it was him, seemed to confine his activities to the region right around Laporte and Eaglesmere, but it wasn’t long before his wanderings took him farther afield, although he always returned to his old stamping grounds. As the years went by, the stories of the Ghost of the Lost Hunter came from all over Pennsylvania and New York, and then from surrounding states, until reports came from as far west as the Rockies.

Apparently, there was no method or reason behind his wanderings, other than a never-ending search for wood to replenish neglected supplies, and perhaps an equally fruitless search for wood to replenish neglected supplies in the snow so many years before.

That wood had really appeared where none was known to have existed at bedtime is a matter of much dispute. There are those who assert that it is true, and there are those who swear it simply cannot be.

And then, there is a further question as to whether the Lost Hunter has ever been heard. Some have said he mutters to himself while dragging a log through the woods, or that he mumbles threats against campers who have let the woodpile get low. It has been said that at such times his face is dark, like a thundercloud, and woe to anyone who crosses his path!

From the earliest days, it has been rumored that it was the blackness of his anger that led to Jordan’s getting lost. It seems reasonable to believe that the Ghost of the Lost Hunter has little patience with those who fail to keep a good supply of firewood on hand.

Some scoff at this, but one thing is sure: No report has ever come of the Ghost of the Lost Hunter where a good pile of firewood sits neatly in its place, which may explain why some veteran hunters and campers have never seen him, while others have seen him more than once.

Still he searches for firewood and the campsite he can never find. Sometimes his faint “Hallo” may be heard out in the woods at night. If you should ever hear it, answer him, and if it is indeed the Ghost of the Lost Hunter, you will get no reply. Nor will you see him if you have a good woodpile.

(Assume a creepy tone, speaking slowly, in a low voice.)

But campers who turn in for the night with their woodpile low may receive a visit from the Ghost of the Lost Hunter. He comes silently in the dark—a heavysset figure in an old-fashioned hat, groping his way through the woods into your camp.

(Three endings are given for the storyteller’s selection.)

He...is looking...searching...FOR YOU!

(or)

If you see him, lie still; don’t shine your light in his face, because...IT’S NOT POLITE!

(or)

If you have neglected your firewood supply, close your eyes and repeat slowly to yourself, “I will never, never neglect the woodpile again. So, Ghost of the Lost Hunter, go away—go away.”

Repeat this three times—slowly. Then open your eyes—and the Ghost of the Lost Hunter will be gone.

(Voice dies away at the end, but, if you wish, you can suddenly yell, “or he will grab you!” Those who enjoy “big boo” endings like to be fooled by the storyteller: You may get comments such as “Gee, I was all set for you to jump at us, and then I thought it was going to be a creepy, die-away ending, and then—boy, was I scared.”)

Great Tribe of Webelos Tribal Fire

The opening campfire is important in setting the stage for what’s to happen during camp. An American Indian theme of the Great Tribe of Webelos can be the highlight of camp.

When the Webelos Scouts arrive at camp the first day, each is given an honor necklace. This tells the boy’s name and den. As the week progresses, he receives beads in recognition of achievements at camp. The boys can bring back their necklaces each year and have beads from their old necklaces put onto new ones. The boys also make a headdress each year as part of their craft session.

The parents and sons assemble after supper and are led to the amphitheater, where a regular campfire of songs, skits, etc., is conducted. This is where the tribe is explained to the parents and they are given a parent necklace. This keeps people grouped and occupied while they start the Trail of Promises. The trail is run totally by the junior staff and den chiefs. Each staff member is dressed in full Indian costume,

and the Webelos Scouts are wearing their headdresses. Everyone who has a role in the ceremony must have the part memorized.



The dens are sent down the trail at two-minute intervals, with the parents following each den. The den chief leads the way, and they go silently. As they approach each station, the den chief turns off the flashlight so that the only light comes from a torch by each location. After the dens finish the trail, they arrive at the campfire ring to the sound of a drum. There they sit in silence until all have finished the trail. The leader of the tribe (who is the camp director) is standing with arms folded. When the signal is given that all have arrived, the leader begins the ceremony.

Tribe Membership

All Webelos Scouts and parents who attend Webelos camp will become members of the Great Tribe of Webelos. Cub Scouts and Webelos Scouts will become warriors, and parents will become honorary warriors. To become members, they must hike the Trail of Promises, attend the tribal campfire, and prove their dedication by silent service.

Positions

All members of the Webelos camp staff hold positions in the tribe. These positions and individuals are very important as they represent the primary line of example-setting influences in the tribe. The positions are:

Leader of the tribe. This is the highest position in the tribe. It is held by the Webelos Scout camp director.

Leader of the promise. Three staff members hold this position. One is in charge of each of the stations on the Trail of Promises.

Leader of the warriors. This is the highest position a youth member of the Webelos Scout camp staff can hold in the tribe. This position is held by the den chief coordinator.

Head of the Warriors. Each den chief holds this position in the tribe. It is a continuation of the den chief's responsibility for the den during the Webelos Scout camp.

Head of the Clan. On the final day of camp, the Webelos Scouts in each den will elect a clan leader. This position is the highest position a Webelos Scout can hold in the tribe.

Guardian of the great flame. On the final day of camp, the Webelos Scouts in each den will elect a guardian of the great flame. This position is the second-highest position a Webelos Scout can hold in the tribe.

Tribal Symbols

ARROW OF LIGHT. The main symbol of the Great Tribe of Webelos is the Arrow of Light. The Arrow of Light Award is the highest rank in Cub Scouting.

HONOR NECKLACE. The honor necklace is the second symbol of the Great Tribe of Webelos. Initially, it recognizes the individual as a candidate of the tribe. As he proceeds through the Webelos camp program, it recognizes him for doing his best and for living up to his Cub Scout Promise and the Law of the Pack. After becoming a member of the great Tribe of Webelos, it is a permanent reminder of his experiences at Webelos Scout camp and the promises he made when joining the tribe. The bear claws and crow beads on the honor necklace are important symbols of the tribe. The bear claw represents the Bear who is strong and seldom retreats. There are three colors of crow beads, which represent the three promises. The three colors are the colors of our country's flag (red, white, and blue). Additional special beads are worn to signify very special honors.

INDIAN HEADDRESS. The third symbol of the Great Tribe of Webelos is the Indian headdress. It symbolizes the closeness of the Indian to the earth as the Great Spirit created him.

BODY PAINT. During the Trail of Promises, candidates will have body paint (the fourth symbol of the Great Tribe of Webelos) put on them by the leader of the promise at each station:

First station (promise to God)—white paint to symbolize purity of mind and body.

Second station (promise to country)—red paint to symbolize the blood shed to keep our country free.

Third station (promise to others)—blue paint to symbolize the heaven that covers all of us as a family in Scouting.

Silent Service

The candidates will remain in an attitude of silence from the time they start the Trail of Promises until the sun rises the next morning. During the period of silence, the candidates are instructed to clean up all trash in the area of the dining lodge.

Trail of Promises

As they hike the Trail of Promises, candidates stop at three stations. At these stations, they promise to do their best to do their duty to God (first station), country (second station), and others (third station).

PROMISE TO GOD. The leader of the promise speaks to the warriors: “Warriors of the Great Tribe of Webelos must observe their religious duties with their families. If you are to be warriors, you must be faithful to your religion, you must respect the beliefs of others, and you must be reverent toward God. A warrior treats others as he would want them to treat him, he does not use bad language, and he takes care of his body. If you promise to do your best to do your duty to God, take one step forward.” (Place white paint on forehead.)

“You will now follow the leader of the warriors to the next station. You will remain silent.”

PROMISE TO COUNTRY. The leader of the promise speaks to the warriors: “Warriors of the Great Tribe of Webelos must help their country. If you are to be warriors, you must serve your community and your country. A warrior obeys the laws of his country. A warrior does not ask what his country can do for him, but what he can do for his country.

“If you promise to do your best to do your duty to your country, take one step forward.” (Place red paint on left cheek.)

“You will now follow the leader of the warriors to the next station. You will remain silent.”

PROMISE TO OTHERS. The leader of the promise speaks to the warriors: “Warriors in the Great Tribe of Webelos must help other people. A warrior does not wait to be asked. A warrior is always looking for ways to help others and ways to help other boys to be good Cub Scouts.

“If you promise to do your best to do your duty to help other people, take one step forward.” (Place blue paint on right cheek.)

(To the parents:) “Honorary warriors may now break silence in order to give the Parent’s Promise. Please recite after me: I will help my son/in observing the rules of the Boy Scouts of America/and in living up to the Cub Scout Promise/and the Law of the Pack./I will do my best to help my son/and his brother Cub Scouts/

to gain the most from their Cub Scout experience by/ helping my son in his Cub Scout advancement,/attending monthly pack meetings,/taking part in other den and pack activities,/and helping den and pack leaders.

“You will now follow the leader of the warriors to the tribal campfire. You will remain silent.”

Tribal Fire

The leader of the tribe speaks to the assembled tribe: “Guardians of the great flame, add wood to our fire to symbolize the knowledge that you and your clan have added at Webelos Scout camp.

“Leader of the great flame, light the tribal fire. Guardians of the flame, return to your clans.

(All stand.)

“If anyone will not do his best to keep the promises he made on the Trail of Promises, he is to leave this fire and return to the flag poles.

(All be seated.)

“Clan leaders, come forward with your clan flags.

“Clan leaders, you may now break silence to take this pledge. Recite after me: I will do my best/to help the warriors/in my clan/to earn the Arrow of Light and follow the trail to Eagle Scout.

“Leaders of the warriors, come forward and take the clan flags.

“Leaders of the warrior, you are to take the flag of your clan and hang it in the dining lodge before the sun rises tomorrow morning. Return to your clans.

“Your clan flags will be hung in the dining lodge as a permanent reminder of your promises and a reminder that we are waiting for each of you to attend the Scout reservation as a Boy Scout and an Eagle Scout.

“Everyone is to pick a blade of grass. Each honorary warrior and warrior are to come forward together.

“You are growing closer together tonight as the grass has grown. Honorary warriors, exchange your blade of grass with your son.

“Honorary warriors, stand behind your sons and place your hands on their shoulders. Warriors, remember always this night and that your parents love you. Return to your clans.

“Everyone, put your blade of grass in your pocket. This blade of grass is a reminder of this fire and that you have done what only the best could do. When you leave the tribal fire, you are to drop your blade of grass along the road, making a trail from the past to our promises of the future.

“It is now time to rejoice. Warriors, come forward.

“Warriors, you will be released from your silence when the drum begins. When the drum ends, you will again be silent. If you have an honorary warrior here, you will go and sit together when the drum ends. If you don’t have an honorary warrior here, you are to sit with your warrior leader.

“When the drum begins, you may dance to rejoice in the fellowship of the Great Tribe of Webelos.

(Begin the drum.)

(End the drum.)

“Warriors, join your honorary warrior or your warrior leader.

“Warriors and honorary warriors, it pleases me as leader of the tribe to welcome all of you into the Great Tribe of Webelos.

“From now until the sun rises tomorrow, you are to remain in silence. To help you remember that a member of the Great Tribe of Webelos can obey rules, I will give

each of you a piece of candy as you leave. Place it in your mouth and, as it melts, remember the promises you have made to God, to country, and to others. Let it melt slowly to remind you that you are to remain silent and to serve the tribe by picking up trash around the dining lodge. The Arrow of Light is the symbol of our camp. This is the Great Tribe of Webelos because its warriors have the greatest potential to advance in Scouting and the most years in which to fulfill their promises. There are two times when you may break your silence tonight: in an emergency, and to say “I love you” and “good night” to your mother, father, or son.

“When you leave the tribal fire, go to the dining lodge area and perform your silent service. When the lights on the dining lodge porch are put out, it is your signal to go to bed.

“Warriors and honorary warriors of the Great Tribe of Webelos, rise, pass before me, and leave this tribal fire.”

Nature and Conservation

If camping is defined as a group living experience in an outdoor environment, then that environment must be a significant part of the program and not back-ground only.

Don’t let your camp be one where the nature program is full of misinformation or too much technical information for an 8-year-old boy. Don’t let the nature program be the feeble flaw in an otherwise great camp program.

The curiosity of 7-, 8-, 9-, and 10-year-old boys gives them receptive minds, which a skillful staff member or den leader can fill with marvelous insights. Always consider a Cub Scout’s viewpoint! We’re not too old to see nature with eyes of wonder and delight

Conservation service projects are one of the most popular program features at some Cub Scout camps. The boys work so eagerly that it is hard to find enough for them to do! Choose projects that are within their strengths and abilities—and ones where they can see their accomplishments.

Resource: *Delta Education Hands-on Science Catalog*; phone 800-442-5444.



Leave No Trace Awareness Award Program



Conduct Cub Scouting's Leave No Trace Awareness Award program. This award may be earned by Tiger Cubs, Cub Scouts, Webelos Scouts, and Cub Scout leaders. Leave No Trace for Cub Scouts acquaints them with frontcountry guidelines for traveling lightly on the land, even in parks, on school grounds, in the backyard, or anywhere else where Cub Scouts are around plants and animals. Refer to Leave No Trace Frontcountry Guidelines, No. 13-032, for more information, including how the Leave No Trace Awareness Award may be earned.

Nature Hikes

Hikes can become more meaningful to Cub Scouts if they hike with a specific purpose in mind. Following are a few suggestions for memorable hikes. Remind boys that they are *observing* nature—not disturbing it; for instance, if they touch a baby animal or its home, the parents may abandon it.

Home Hike—Look for homes of different insects and animals, such as spider webs, nests, holes, and cocoons.

Tracks or Signs—Look for any signs that animals have been in the area.

Baby Hike—Gather or list all babies seen (birds, ferns, leaves, snails, etc.).

String Hike—Follow a string along the trail. Scattered along the way are objects to identify.

Mud Puddle Hike—As long as boys have proper rain gear if needed, go ahead and hike in wet weather. Note how animals and insects take cover.

Color Hike—List all objects of a selected color—who can find the most?

Snoop Hike—Explore, be aware, notice unusual things, be snoop. Look for both natural and manmade things. Pick up litter.

52-Program

Craft Hike—Hike to gather specific nature items to use in crafts projects.

Listening Hike—Hike quietly and listen for the sounds of nature—wind, rustling leaves, birds, crickets, etc.

Learning About the Sun

Anyone who has had a sunburn, walked through a greenhouse, hung clothes on the line to dry, or watched spring arrive recognizes the power of the sun. In a two-week period, the sun transmits more energy to the earth's surface than all the energy stored in the earth's known reserves of coal, oil, and natural gas. And each year, more than 500 times as much energy is radiated from the sun to the surface of the United States than we consume in all conventional forms of energy. The sun is the most inexhaustible and the cleanest source of energy known. Its heat and light arrive week in and week out—free.

Such a monumental power source deserves special recognition, which you can give successfully in the outdoor classroom.

SUNNY-SIDE UPS. Some people think we have spring and summer because the earth is closer to the sun at different times of the year. The real reason is that the earth tilts on its axis. Therefore, one part of our world receives more concentrated sunlight than another. This makes the difference between summer and winter. You can show this with two tin can lids, flat black paint, cardboard or clay stands, and the sun. Cut the top and bottom out of a soup can. Paint the ends dull black. Roll clay balls for stands, or use triangles of cardboard with a slit in each. Set the lids so that one's black side faces the sun squarely and the other so that its black side receives the sun's rays at a slant. Think of them positioned on the globe. After about 10 minutes, test them for heat on the inside of your arm. Which one represents summer?

TRANSFORMING MUDDY WATER. How much clean water can the sun get out of a pan of muddy water in a single day? For this experiment you need

- a large pan or tub
- clear plastic wrap
- rock
- masking tape
- muddy water
- drinking cup or glass

Fill the pan to a depth of 2 inches with muddy water. Place the drinking cup in the middle, and cover the pan with clear plastic. (You may have to put a weight in the cup to keep it from floating.) Tape the plastic firmly! Put a rock on the plastic wrap to make it sag in the middle, but don't let the rock touch the cup. Place the pan in the sun for a day. As the water evaporates,

notice the tiny drops that condense on the cool plastic wrap. Are the drops that condense and fall into the cup clear or muddy?

SIDEWALK SHADOWS. A fun way to show the illusionary movement of the sun in the sky is to trace the boys' shadows on the ground on a bright, sunny day. Powdered chalk will quickly wear away in the rain. Be sure to outline the feet so that each boy can reposition himself in the same spot for multiple drawings at different times of the day. Try one drawing in the morning, one near noon, and one in the afternoon. For display purposes, it is fun to draw the outline of these shadow poses on butcher paper and then cut them out.

SHADOW CLOCKS. There are very simple ways for a boy to make a sundial. The sundial can make him aware of the sun's regular daily movement through the sky, associate this movement through the sky with times of the day, and learn a method of telling time. Materials to use are small stakes such as tongue depressors, craft sticks, or pencils to be used as markers; file cards; tape; and pencils. On a sunny day, place one stake firmly in the ground. At the end of the stake's shadow, insert a "marker" stake in the ground. Mark the time of day on a file card, and tape it to the marker stake. At intervals throughout the day, mark the location of the shadow with additional marker stakes, being sure to record the time of day on a file card for each one. You now have a shadow clock! Try a portable variety of this simple sundial. Insert a pencil into the upper middle area of a plastic foam block about the size of a shoe box lid. As the pencil casts its shadow across the block, mark the end of the shadow with a toothpick. Small flags attached to the toothpicks can be used to indicate the time.

WHICH COLOR IS THE HOTTEST? Here's an interesting way to test the amount of heat that different colors absorb. You'll need four juice cans, poster paint (white, black, green, and red), water, and four thermometers. Paint each can a different color, and fill each with the same amount of water. Put a thermometer in each, and set them all in the sun. At the end of a half hour, check the temperature of the water in the different cans. Are they the same or different? Which color can has the warmest water? Which color reflects the most heat? You might also try to test the temperatures at various intervals, perhaps every five minutes, and graph the trends for the different-colored cans.

Sun Safety

Too much sun can be dangerous. Follow these tips from the American Academy of Dermatology to stay safe in the sun:

- Try to stay out of the sun between 10 A.M. and 4 P.M. when the sun's rays are the strongest.
- Use lots of sunscreen with a sun protection factor (SPF) of at least 15. Put on more every two hours when you're outdoors, even on cloudy days.
- Wear protective, tightly woven clothing, such as a long-sleeved shirt and pants.
- Wear a 4-inch-wide broad-brimmed hat and sunglasses with lenses that protect you against the sun's ultraviolet rays (called UV protection).
- Stay in the shade whenever you can.
- Stay away from reflective surfaces, which can reflect up to 85 percent of the sun's damaging rays.

Nature Alphabet

Provide each den with a notebook, with each page labeled with a letter of the alphabet. During the week, Cub Scouts collect, mount, and identify specimens on the appropriate pages. It would be helpful to have reference books available to help boys identify specimens.

Tree Study

Each den adopts a tree in the camp area. Give the den a card with the points the den is to look for listed on it, such as the one below.

Tree Study

- Where is the tree growing?
- What kind of tree is it?
- What shape is it? Make a sketch.
- Do the branches grow upward, sideways, or downward?
- Is the trunk straight or bent, single or divided?
- Describe the bark. Is it rough or smooth?
- Does the tree have any particular color?
- Is there any moss or lichen growing on it? If so, collect a sample.
- Measure the distance around the trunk 3 feet from the ground.
- Does the tree have flowers?
- Does the tree have fruit?
- What plants grow under the tree?
- Make bark and leaf rubbings.

A Terrarium

A TERRARIUM IS AN INDOOR HOME FOR THAT PET TURTLE, SNAKE, NEWT, TOAD, OR SALAMANDER THAT YOU CAUGHT OUTDOORS. A WELL-MADE TERRARIUM, PLANTED WITH THE NATURAL SURROUNDINGS OF YOUR PET, WILL MAKE A COMFORTABLE HOME FOR IT AND GIVE YOU LOTS OF FUN OBSERVING IT.

AN OLD FISH TANK MAKES A FINE TERRARIUM. IT DOESN'T MATTER IF IT LEAKS BECAUSE YOU'RE NOT GOING TO FILL IT WITH WATER.

TO MAKE YOUR OWN TERRARIUM FROM WINDOW PANES, FOLLOW THESE EASY STEPS:

1.

TAPE FOUR PIECES OF GLASS TOGETHER WITH ONE-INCH WIDE MASKING TAPE.

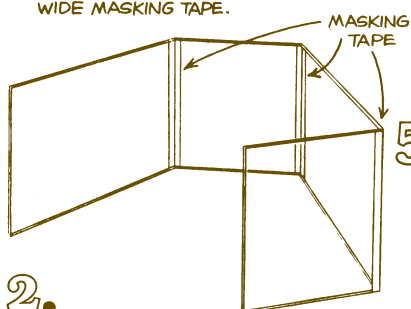

2.

PUT TOGETHER AS A GLASS-SIDED BOX

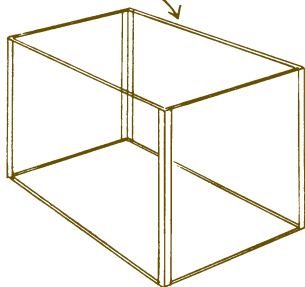

3.

PLACE ON BOARD, MARK OUTLINE OF GLASS SIDES AND CUT 1/4" GROOVE TO SET SIDES

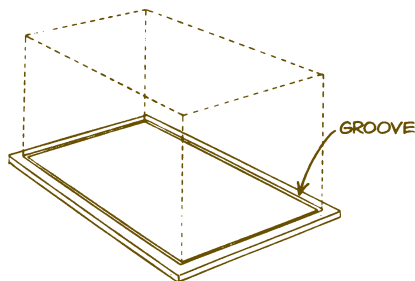

IF YOU USE AN OLD FISH TANK, PLACE A GLASS TOP ON IT OVER RUBBER WASHERS TO ALLOW AIR SPACE BETWEEN TOP AND SIDES.

5.

NEXT, PLACE DIRT, STONES, ETC., IN TERRARIUM, AND PLANT GROWING PLANTS THAT WILL DUPLICATE THE NATURAL SURROUNDINGS OF YOUR PET.

MAKE YOUR PET FEEL AT HOME. FEED IT REGULARLY WITH THE FOOD IT LIKES BEST, AND BE SURE TO PLACE A SMALL DISH IN THE TERRARIUM FOR DRINKING OR SWIMMING WATER.

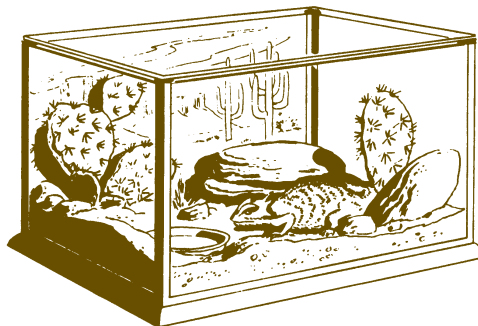



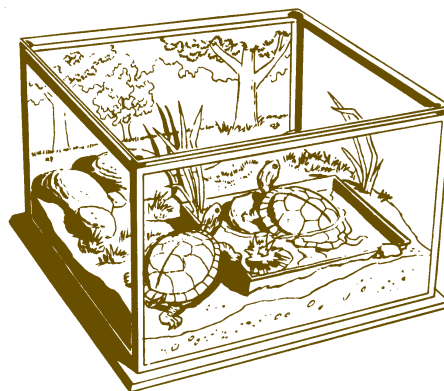
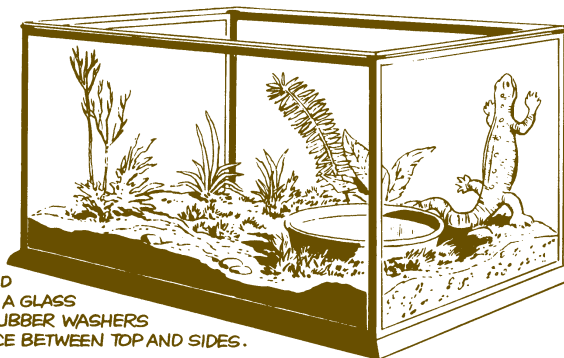
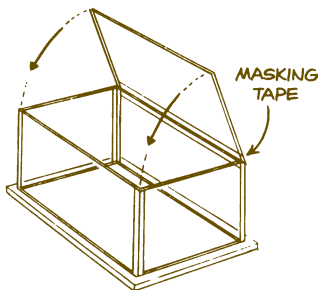

PAINING A SCENE ON THE BACK OF THE TERRARIUM ADDS MUCH TO ITS APPEARANCE. OR YOU CAN CUT OUT APPROPRIATE SCENES FROM A MAGAZINE AND PASTE THEM ON (PAINT OR PASTE SCENES ON THE OUTSIDE OR YOUR PET WILL SCRATCH AND SOON RUIN IT).

4.

TAPE A GLASS LID SO THAT YOU CAN RAISE AND LOWER IT.



Cub Scout Camp Weather Chart					
	July 1	July 2	July 3	July 4	July 5
Conditions					
Wind Direction					
Use the following weather condition symbols:					
rain		clear sky		fog	
cloudy sky		cloudy sky with sunny periods			

Weather Observations

Furnish each den with a weather chart such as the one shown. Ask them to record their observations at the same time each day for an accurate comparison. To help Cub Scouts with their weather observation charts, you might like to set up a wind vane, a rain gauge, and a barometer. See the Bear electives for ideas.

Trails

Set up several trails for the boys to enjoy by laying signs or leaving marks at regular intervals, about 20 paces apart. Lay all the signs on the same side of the path. Use signs that will not become litter, i.e., sand, stones, crushed chalk, or pinecones. Tell the boys a story as they walk the trail to make it more exciting. You could be explorers discovering a hidden jungle, astronauts exploring Mars, or pirates following a trail to buried treasure. Make a “Matchstick Madness” trail by painting used matchsticks in bright colors and leaving them as trail markers. Cub Scouts will need sharp eyes to spot them. Be sure to leave no litter. A special treat could await boys at the end of the trail.

Nature Hut

You might like to set up a nature hut or tent with nature displays for the boys to see—birds’ nests, rock collections, seeds, leaves, snake skins, small animals, etc. A knowledgeable leader should be on hand to answer questions and explain the displays. This could be a spare-time activity or worked in as a part of the day’s program.

Insect Hunt

Boys can make bug jugs during crafts period and then go on an insect hunt to collect specimens. Call it a “Big Game Hunt.” Be sure the captured insects are given food and water. Turn them loose at the end of the day.

Amazing Miniature World

Furnish each den with a magnifying glass and let it look at a world we rarely see: the inside of a flower, insect eggs laid on leaves or bark, the head of a caterpillar, a spider in a web, a honey bee in a flower, seeds, rocks, grasses, etc.

Quiet Activities

Moon Rock Collection

Ask boys to collect three small rocks from the camp area. Examine rocks with a magnifying glass. Look for fossils, unusual colors, or patterns in the rock formation. Try to identify the types of rocks.

Mars Oddities

In advance, arrange the play area with oddities such as an oak leaf on a pine tree, a pinecone on a maple tree, a flower bloom on a nonflowering bush, etc. You will need eight to 10 of these oddities. Then tell the boys that they are exploring Mars, which is similar to Earth

but has some unusual differences. Ask them to hunt in pairs and make notes of the oddities on Mars. A time limit can be set, with a prize for the winning team.

The Guessing Table

This can be used as a daily spare-time activity. Change the items to be guessed each day, and award a prize to the daily winner. Some examples: How many moon eggs (marbles) are in a jar? How many squirts are in a water pistol? How many hairs are on a witch’s tail (a painted pine bough)? How much does a jar of kryptonite (green-colored water) weigh? How many BBs are in a paper cup?

Kim's Game

In advance, arrange a group of natural objects on a table—leaves, rocks, bark, feathers, shells, etc. Allow the boys to look at the display briefly, and then cover the table. They try to describe from memory what they saw or answer questions about the objects. You can also play this game by asking boys to identify hidden objects by their touch or smell.

Resuscitation Demonstration

In advance, make "Bill Blow," as shown. Enlist the help of a qualified person to give the demonstration, and then let the boys practice. You'll need these materials:

- 1 plastic bleach bottle (1½ gallon with hollow handle)
- 1 rubber finger cot (ventilated)
- 1 piece rubber tubing (12 inches, ½-inch diameter)
- 1 small tube of latex rubber adhesive
- 1 bottle of black model dope or enamel (½ ounce)
- 1 plastic refrigerator bag (2 to 4 quarts)
- 2 heavy rubber bands (5 inches and 6 inches)
- 1 T-hinge (6 inches)
- 1 cork (½-inch diameter)
- 1¾-by-2½-by-8½-inch wood strip
- 1 9-by-16-inch wood board
- 2 nails (¾-inch) or pushpins
- 1 box or roll of flexible plastic food wrap or plastic food bags
- 1 book (3 to 4 pounds)
- Alcohol and cotton swabs (to clear between uses)

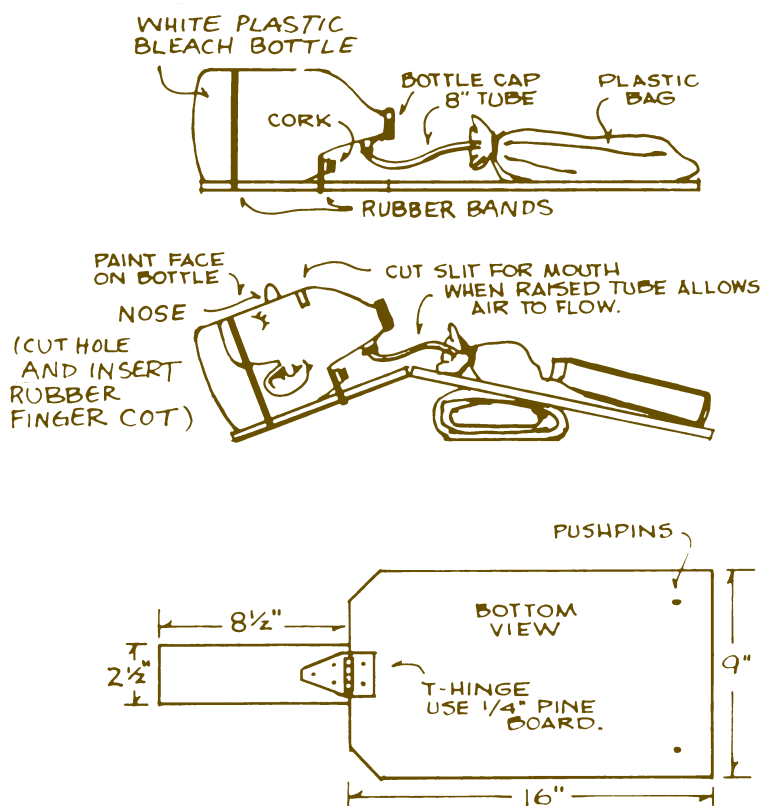

Demonstrations by Special Visitors

Invite special guests to give demonstrations such as the ones listed below. Be sure to send them a thank-you note afterward.

- A smoke jumper from the Department of Forestry
- A Venturer in scuba gear
- An Arrowman in American Indian costume to teach the boys a dance
- A zoo official with live animals
- A member of the sheriff's department with trained dogs
- A member of the local highway patrol for a safety briefing, complete with patrol car with flashing red lights and police radio turned up
- A karate expert
- A black powder expert
- A well-known local race car driver with car
- Firefighters sounding a blast on the siren as they roll in with a ladder truck
- A well-known local athlete to show boys how to kick, pass, punt, bat, etc.

Watermelon Seed Spitting Contest

After a watermelon treat, let the boys spit seeds for distance and accuracy. Award prizes for various accomplishments.

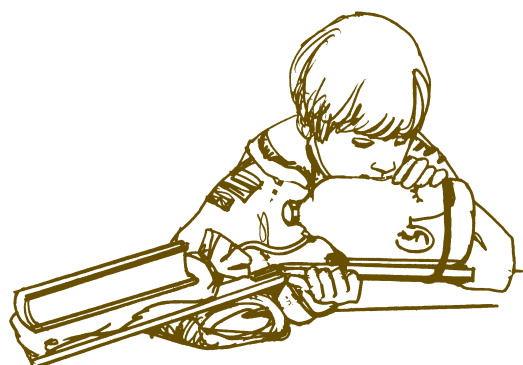

Activities to Let Off Steam

Try these games and activities to help your Cub Scouts get rid of a little excess energy. You can also try some of the games mentioned in the “Games” section.

Log-Rolling Contest

Boys make “logs” from cardboard tubes (approximately 11 inches long) by covering the ends with brown paper glued in position. Pieces of dead trees can also be used for logs. Several players can compete; each will need a log and a stick (approximately $\frac{3}{4}$ -inch by 30 inches). At the word “Go,” each player must roll his log from the starting line to the finish line with the stick. Logs may not be touched with the hands. No hitting is allowed, and players must remain behind their logs. The first boy to cross the finish line wins.

Push-Out

Draw a circle about 8 feet in diameter. “It” stands inside the circle. All players except “It” must fold their arms across their chests and hop on one foot. “It” does not have to do either. The others try to push “It” out of the circle without using their hands or arms. “It” dodges them, and he can push the hoppers out of the ring using his hands or arms. When a hopper is pushed out, unfolds his arms, or puts both feet down, he is out of the game. The game continues until either all hoppers are disqualified or “It” is pushed out of the circle.

Corner Ball

The playing area is marked into four 8-foot squares. Dens line up as shown by the X’s in the illustration. The server in square 1 hits a volleyball so that it bounces into square 3. The player for square 3 hits it on the first bounce to either square 2 or 4. The game continues with each player hitting the ball so that it bounces into either of the two squares from which the ball did not come. It cannot be returned to the square from which it came. After each player hits, he goes to

the end of his den’s line, and the front boy moves into the square and becomes the player for his den. The den with the fewest misses after the time limit is the winner.

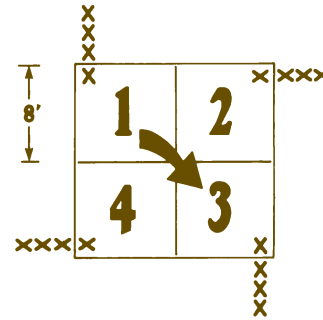

Kite Messenger Race

Boys can make kites during crafts period or bring them from home. Use equal lengths of the same type cord on each kite for flying. Kites are run out to the end of the measured cord. The “messenger” can be any device selected by the player, such as a cardboard disk with an eyelet in the center or a plain sheet of heavy paper with a hole punched through the center. The object is to make the messenger slide, when driven by the wind, from the ground up to the kite bridle. Start the messenger on the “Go” signal, and let it slide with the wind up the kite string. The first messenger that reaches the kite bridle wins the race. *Note:* Be sure the kite-flying area is away from trees and electric wires.

Missile Launch

Boys can make paper airplane “missiles” during crafts period. Suspend a hula hoop from a tree branch. Boys try to throw their missiles through the hoop from a distance. Each boy gets two or three turns to launch his missile. The same type of activity can be played by hurling throwing disks through the hula hoop.

Water Games

Shark Tag

Play this game in waist- to chest-deep water. The boys line up on one side of the pool. “It” is about 20 feet in front of them. When he yells “Shark,” all players swim or walk to the other end while “It” tries to tag them. Those who get tagged join “It” in trying to tag the others. The last player tagged is the winner.

Steal the Turtle

Play in waist- to chest-deep water. Divide boys into two equal teams that line up facing each other, 20 feet apart. Give each team member a number. A leader tosses a large rubber ball into the middle of the play area and calls out a number. The opposing players with that number race for the ball. The player who gets it and returns to his place without being tagged by the opposing player scores one point. When both boys are back at their places, the leader calls out another number. For a real scramble, call all the numbers at once.

Yacht Race

Line up the boys at one end of the swimming area, giving each racer a soda straw and a small sailboat made from a flat piece of board, an upright stick, and a paper sail. (Sailboats can be made by boys during crafts period and should be as much alike as possible so that everyone has an equal chance of winning.) On a signal, the swimmers must begin to blow their yachts forward by puffing through their soda straws. Using hands to put the boats back on course is forbidden. Whoever blows his boat across the finish line first is the winner.

Turtle Float

Each boy pretends he is a turtle. Start by standing in a circle in waist-deep water. At a signal, boys take deep breaths, grasp their ankles, and pull their knees up against their chests. If the chin is kept on the chest, a boy will float with his back out of the water. Demonstrate for the boys and allow them to practice until they learn how to keep their bodies floating.

Table Tennis Ball Relay

Divide the boys into two equal teams. Give each team a table tennis ball. On a signal, the first player on each team starts blowing the ball ahead of him as he swims or walks to the turning point about 15 feet away. He may not touch the ball with any part of his body. At the turning point, he returns to the starting line, and the second player repeats the action. Continue until all have raced.

Sharks and Whales

This game can be played with two teams of five or more players each. One team is called the Sharks, the other the Whales. The teams line up facing each other in parallel lines. Each team has a home base about 10 feet behind them. One player, chosen to be the leader, calls “Sharks.” The Whales turn around and run to their home base (which might be the side of the pool), while the Sharks chase them. Any Whales tagged become Sharks. The leader then calls “Whales,” and the situation is reversed. The team having the greatest number of players at the end of a given time is the winner.

Water Dodge Ball

Play this game with two teams of five or more players each. Team One forms a large circle around Team Two. A beach ball is given to Team One, and its members try to hit players on Team Two with the ball. Team Two players may duck, dive, dodge, or stay underwater to avoid being hit, but they must remain inside the circle. When a player is hit, he joins Team One and helps eliminate Team Two players. When all Team Two members are eliminated, the players change places so that Team Two forms the circle and Team One is in the center.

Balloon-Pushing Relay

Split each den into two equal groups about 30 feet apart in chest-deep water. Give an inflated balloon to the lead Cub Scout in each group. On a signal, he begins pushing the balloon in front of him with his hands, arms, and head toward the other group. He may not hold the balloon. When he gets to the other group, the lead Cub Scout there pushes the balloon back toward the other group. Continue until all have had a turn. The first den finished wins.

Super Events

Coffee Can Ice Cream

- 1 cup milk
- 1 cup whipping cream
- ½ cup sugar
- ½ teaspoon vanilla
- 1 one-pound clean, empty coffee can (with plastic lid)
- 1 three-pound clean, empty coffee can (with two plastic lids)
- Ice
- Rock salt
- At least two Cub Scouts

Combine milk, whipping cream, sugar, and vanilla in the one-pound can. Mix well. Cover tightly with the plastic lid. Place can in the three-pound can. Fill the empty space with alternating layers of ice and rock salt. Cover with the plastic lid and place can on its side. (It will roll more smoothly if you put the second plastic lid on the bottom of the three-pound can.) The two Cub Scouts sit down on the floor or ground, facing one another, about four feet apart. They roll the can back and forth rapidly for 10 minutes. Open the three-pound can and empty it of water. Replace with more ice and rock salt, and put back the plastic lid. Roll again for 5 minutes. Open. You have ice cream!

Water Balloon Catapult

Enlist the help of some Webelos Scout parents to build a 6-foot wooden catapult. Use the catapult to toss water-filled balloons at the boys, who stand a distance away. Any boy who catches a balloon without bursting it (and covering himself with water) is entitled to a prize.

Carnival

Set aside approximately 2 hours on the final day for a carnival staffed by the camp personnel, with activities such as a sponge toss, ball toss, balloon throw, etc. This can be followed by a den cookout, with the menu selected and cooked by the den.

Helicopter Egg Drop

Have boys pack a single, fresh, hen's egg so well that when it is dropped from a helicopter it will not break. Enlist the help of the Air National Guard or a TV station's traffic reporting staff to land a helicopter at the campsite, pick up the eggs that the boys have packaged, hover over the site at approximately 125 feet, and drop the packages one by one. See that all boys and parents receive a copy of the following rules in advance:

1. Use only a fresh chicken egg. It cannot be cooked. Every egg will be checked to see that it is uncooked.
2. Do not coat the egg with any material such as a chemical, rubber latex, cement, etc. In other words, the packing may not be "fused" to the egg.
3. You may use some type of suspension system as long as it is not fused onto the egg. Or you may just pack the egg in some type of packing, such as gelatin, popcorn, crushed newspaper, plastic foam peanuts, etc.
4. Use a parachute if you wish, but more often than not, the parachute drives the package to the ground more quickly because of the downdraft of the helicopter propeller. Some do float, however, so it is your decision.
5. The overall size of the container may not be more than 8 by 8 by 8 inches. This is very important. If it is any larger, there won't be room in the helicopter to carry all the packages. All boxes will be measured, and those too large will not be dropped.
6. Put your name on the outside of the package.
7. You must stay back from the helicopter when it is taking off and landing. You must also stay back until all the packages are dropped and the signal is given that it is safe to retrieve your package.
8. After the "All's safe" signal is given, get your package and check to see whether your egg is broken. Packages must be opened over the garbage containers placed in the field for that purpose. If the egg is still intact (not broken), take it to one of the people in charge, who will take your name and give you a memento.
9. Be sure you don't leave any part of your package on the ground. See to it that your packaging does not litter. The area will need to be clean before you leave.
10. Good luck!

Catapult Egg Drop

Instead of dropping eggs from a helicopter, use a 6-foot wooden catapult put together with bolts and heavy elastic cord for easy dismantling and rebuilding. During the week, the boys can work with the catapult and practice throwing softballs or other "missiles" from it. On the day of the super event, they bring packaged eggs (see the Helicopter Egg Drop above) and hurl them from the catapult.

Contest Day

The final day can include a period of games, contests, and tests that will reflect what the boys have learned during the week in the various program areas. Use a point system where each boy contributes to a team (tribe, den, etc.) total, with the winning team being announced at the campfire that night. This reinforces the activities during the week and adds an incentive for learning.

American Indian Pow Wow

Each day's activities could include at least one related to American Indian lore—games, pottery, dancing, leathercraft, etc. The super event, held on the final day, is an Indian pow wow, with a campfire, American Indian games, dances, skits, and songs. This ties together the week's activities into a special final event.

Field Events

Set aside about two hours one day for field events that result in prizes for the winners. Suggestions are: Egg Relay, Cracker Relay, Bean Relay, Watermelon Relay, Tin Can Relay, Spoon Relay, Chair Relay, Marshmallow Relay, Tire and Water Relay, Gum and Glove Relay.

Special Days at Camp

You might like to identify at least one day as a “special” day, when boys come dressed in appropriate costumes and take part in related activities. This could be the day when a super event takes place. Or you may wish to make every day a “special” day. Some suggestions are given below. Draw on the imagination and creativity of your camp staff for additional ideas:

Wright Brothers Day

Boys can come dressed in tight-fitting caps to resemble flight helmets, goggles made from old sunglasses, a Red Baron-type scarf around the neck, and long pants with legs tucked into boots. Activities could include the Helicopter Egg Drop and paper airplane games such as the Missile Launch (described in “Activities to Let Off Steam”).

Superman Day

Boys can come in costumes if desired. Activities could include the Kryptonite Gamble balloon toss game, fitness and skill competitions, a kite messenger race or kite-flying contest, and a demonstration by a karate expert or weight lifter.

Buffalo Bill Day

Boys can wear fringed shirts, coonskin caps made from fabric or a paper sack, and long pants. Activities

could include a hike, rope lashing, a log-rolling contest, and a demonstration by a black powder expert.

Blackbeard the Pirate Day

Boys can wear cutoff, fringed jeans; bright-colored sashes around waists; striped T-shirts; and black eye patches. Activities could include a treasure hunt, walking the plank (a fitness activity), a raingutter regatta, or a Water Balloon Catapult (described in “Super Events”).

Huck Finn Day

Boys can wear plaid shirts; straw hats; fringed, cutoff jeans or shorts; or bib overalls. Activities could include fishing (if available), a picnic lunch, a tire-rolling relay or tire games, the 80-Foot Banana Split (described in “Super Events”), and, of course, swimming in the “old swimming hole.”

Spiderman Day

Boys bring T-shirts to silk-screen or stencil with a “web” design. Activities could include a spider hunt (with bug jugs), an obstacle course, or a display of insect collections.

Tarzan Day

Boys can wear fringed, cutoff jeans (with a shirt, please). Activities could include a wild animal hunt (with bug jugs), or a visit from zoo personnel with live animals—including a chimpanzee. You might need to set some rules about swinging from trees.

Water Fun Day

On this special day, emphasize fishing with the help of a local fishing club. Activities could include a fishing derby, water games and contests, a Water Balloon Catapult (described in “Super Events”), a raingutter regatta, tying of nautical knots, and boat rides. You could invite a fire department to come and “hose 'em down!”

International Day

Enlist the help of volunteers who are not already on the camp staff, as this is a big responsibility. Two or more people should be responsible for each station on a particular country. Each station has food (which the boys can help prepare), games, crafts, or other activities related to that particular country. Boys spend about 45 minutes at each station. Some suggestions follow:

- Mexico—Boys make Ojos de Dios with yarn and sticks, break a piñata, eat tacos and tostados, and sing Mexican songs (with guitar accompaniment if possible).

- England—Boys make jumping jacks (simple wooden puppets with strings), play English games, and eat English cookies or cakes (such as crumpets or scones).
- Germany—Boys make simple wooden toys, hear stories about Germany, learn a German song, and eat potato pancakes and applesauce.
- Japan—Boys make origami figures and sit on the ground at a low table to have rice with steamed vegetables and tea.

- Africa—Boys tie-dye T-shirts, take part in a “safari” through the “jungle,” and eat bananas and coconut cookies.
- Greece—Boys decorate burlap peasant bags with yarn, take part in Olympic contests, and eat Greek candy.

Remember to collect for the World Friendship Fund at the end of the day.

A Disabilities Awareness Experience for Webelos Scouts

For an awareness experience to be successful, familiar activities and achievements must confront the Webelos Scout while one or more of his senses, his dexterity, or his mobility is impaired. After he has completed the tasks, he must be debriefed to help him understand his experience.

Resource: *Including People With Disabilities in Camp Programs: A Resource for Camp Directors*, edited by Glenn Roswal, Karen J. Dowd, Jerry W. Bynum (American Camping Association, 1998)

Suggested Activities

- Brushing his teeth
- Combing his hair
- Shining his shoes
- Tying his shoes
- Tying up a package
- Tying three knots
- Pounding a nail into a board
- Removing a nail from a board
- Assembling bolt, washer, and nut
- Eating a sandwich
- Drinking cocoa
- Chewing celery
- Walking along a two-by-four
- Walking up several steps
- Shooting baskets

Impairments

Sight: Cravat blindfold

Hearing: Cottonballs and cravat

Smell: Ointment in nostrils

Touch: Cotton workgloves

Taste: Suck a menthol lozenge before eating

Dexterity: Tie working arm to belt in back

Mobility: Tie both ankles together loosely

Orientation

Purpose

To help dens participate efficiently in the awareness experience.

Preparation

All dens will sit down, get quiet, and wait for instructions.

Equipment

- Bullhorn
- Whistle
- Bulletin board with tacks

Personnel

Two people to give instructions, one to supervise and the other to serve as a timer.

Introduction

(To be read to participants)

“Did you know that one person out of 10 in this nation is disabled in some significant way? These people don’t go through life as easily as others who aren’t disabled. Sometimes, they are sheltered or kept apart from others in daily life, and the majority of people just don’t become involved with them, learn to under-

stand them, or more important, have a chance to become a *friend to them*.

“Have you ever thought about what it would be like to be physically disabled? Or mentally retarded? Or deaf? Or blind? You are going to experience these disabilities.”

Event Directions

Assign one den to each station, and tell them to rotate numerically at the sound of the whistle...the den at Station 1 will rotate to Station 2, 2 to 3, 3 to 4, 4 to 5, and 5 to 1.

Conclusion

Webelos Scouts and their leaders have a need and a challenge set before them—to take the opportunity to get to know disabled youths, to invite them into their units, and to help them become the best people they can become. Cub Scouting can do so much for them! And they in return can teach us much about the Golden Rule, caring for others, and give us the opportunity to develop some of the best friends we'll ever meet on the road through life.

Obstacle Course

Purpose

To show how simple events on an obstacle course become serious obstacles when a person is disabled. The Webelos Scout will appreciate the greater efforts and abilities a disabled person needs to get through each day.

Preparation

Each den will sit down in front of the leader, get quiet, and wait for instructions.

Equipment

- 12 used automobile tires
- One 2-inch-by-4-inch-by-12-foot board, anchored by stakes driven beside it (laid with 4-inch side to the ground)
- Three 2-by-4-by-16-inch beam supports (laid under the 2-by-4-inch board for height)
- One 10-by-10-foot tarp
- Four 55-gallon oil barrels (clean on the outside) arranged and set in 8-inch holes for stability
- Two white canes, two pair of crutches, two blind-folds, two slings, two ear muffs

Personnel

Two people to help boys put on disabilities, supervise events, and be alert to possible injuries.

62-Program

Introduction

(To be read to participants)

“I'm sure you have all been through an obstacle course at one time or another. But how does a blind person walk through tires that are randomly placed on the ground? Or how does a person with only one leg crawl under a tent? An easy obstacle course for people with everything going for them becomes extremely difficult when you are disabled in some way, as you will soon see.”

Event Directions

(To be read to participants)

“Everybody will be disabled in some way for the obstacle course: blindfolded, made deaf with ear muffs, have your eating arm put in a sling, or have one leg bent up and be on crutches. This event will call for teamwork when you realize your buddy has difficulty ‘seeing’ where the next event is or has other problems. Only the den leader is permitted to speak.”

Assign two boys to each of the four disabilities.

Potential Problems

The “blind” will have difficulty going from obstacle to obstacle and might need help from their den leader.

Conclusion

Have each boy remove his disabling equipment carefully; help if needed. Ask for reactions to being disabled and how they feel now about other people who have to endure these hurdles their entire lifetimes.

Beep Ball Bunting

Purpose

To experience in a fun game the difficulties of being blind. The Webelos Scout will learn to substitute timing and hearing for sight.

Preparation

Each den will sit down in front of the leader, get quiet, and wait for instructions.

Equipment

- Two beep balls
- Two softball bats
- Two 1-inch-by-4-inch-by-12-foot stakes
- Two whistles
- Two catcher's masks

Personnel

Two people to help boys put on disabilities, supervise events, and be alert to possible injuries.

Introduction

(To be read to participants)

“Beep Baseball is a growing team sport throughout the country, not only for the visually impaired but for the sighted as well. It is a sport that stresses teamwork and timing between the sighted pitcher and the blind batter. Beep ball gives you an outstanding example of how people with disabilities are more like other people than they are different.”

Event Directions

(To be read to participants)

“In this event, each batter will wear a catcher’s mask that has been blocked out to simulate blindness. Unlike regular baseball, the sighted pitcher and the batter are on the *same team*. In order to bunt the ball, the most important consideration is a consistent throw by the pitcher and a consistent swing by the batter. In addition to pitcher and batter, there will be a fielder and a catcher. We will rotate in an orderly fashion so that everyone can participate. Remember, the pitcher and batter are on the same team.”

Potential Problems

Boys might try to swing aggressively at the ball. The batter might also try to step in front of the plate in a traditional bunting stance.

Conclusion

Ask boys how it felt to have an object coming toward them that they could not see. Did sounds, smells, etc., distract them? Get reactions and generate a discussion.

Pioneering Project

Purpose

To experience some of the difficulties of people who have mental retardation related to memory, comprehension, concentration, and application.

Preparation

Each den will sit down in front of the leader, get quiet, and wait for instructions.

Equipment

- One 8-foot pole
- Two 10-foot poles

- One 8-by-8-foot canvas (or fly or tarp)
- One each: red, blue, white, yellow, and green tent pegs
- Seven ¼-inch ropes, each 15 feet long
- One maul (3-pound hammer)
- One compass
- One clipboard

Introduction

(To be read to participants)

“People with mental retardation face some difficulties that are well-expressed by a sign in the library of a special school: ‘We see but do not read, we hear but do not understand, we do and we learn.’ This event is not a contest—there is no scoring, but when you finish, we will tell you how many instructions you followed and how many you missed. This calls for memory, comprehension, concentration, and application. See how perfectly you can follow these instructions.”

Event Directions

(To be read to participants)

“Webelos Scouts, assemble this pioneering project in the following manner:

“Lash two poles together in the center with a square lashing. These two poles should be at right angles to each other. Lash these two poles to a third pole with any lashing, 2 feet from the end of the third pole and at the intersection of the other poles. Stand the third pole vertically with the longer end touching the ground. Place canvas over the three poles and tie the corners to the first two poles near their ends. Guide the ends to the tent pegs, which are 10 feet from the center pole and an equal distance apart. The pegs should be placed in reference to the center of the pole: red—south, green—east, blue—north, white—west. All Webelos Scouts then assemble under the canvas and repeat the Cub Scout motto backward.”

Potential Problems

1. Webelos Scouts might forget some of these instructions.
2. Webelos Scouts might not understand the instructions if they hear them only once.
3. Webelos Scouts might see other dens completing this project and simply try to copy them.

Conclusion

Examine the completed project, and tell the Webelos Scouts how many instructions they followed correctly. Ask boys for their reactions to being mentally retarded and how they feel now about other people who deal with these kinds of difficulties their entire lifetimes.

Wheelchair Volleyball

Purpose

To experience in a fun game a different mobility technique used by individuals with disabilities.

Preparation

Divide den evenly into two groups and quiet them for instructions. Then station them on each side of the net.

Equipment

- Eight wheelchairs
- Two volleyballs
- Two whistles
- One net
- Two posts
- Stakes, tape, rope

Personnel

At least one person to supervise and count volleys.

Introduction

(To be read to participants)

“Today, we’ll play wheelchair volleyball a little bit differently, because using a wheelchair properly is a skill you probably haven’t developed. The idea is to get the ball over the net as many times as possible in a single round of volley. We will post the record of the den with the highest number of volleys.”

Conclusion

Lead a discussion about architectural barriers, and list examples.

Handyman Events

Nail Driving

Items Needed

- Sawhorse
- Hammer (If using more than one, they must be identical; 10-ounce size is suggested.)
- 16-penny common nails (approximately 12 per pound)
- 2-by-4-inch board (nailed to sawhorse)
- Colored marker
- Watch

Procedure

The adult supervising this event starts about six nails into the two-by-four nailed to the sawhorse. The Cub Scout is given the command to start and has to drive in one nail completely. If it bends, he can move on to another one, and so on, until he nails one in or reaches the maximum time of 1½ minutes (90 seconds). The adult marks the boy’s time in seconds on his score sheet with a specific colored magic marker and initials it. The Cub Scout takes back his sheet, moves to the next event of his choice, and presents his sheet at that event.

Safety Notes

1. Adults work with *one* Cub Scout at a time.

2. The Cub Scout must
 - a. Keep both hands on the hammer, or
 - b. Keep one hand on the hammer and the other hand behind his back, and
 - c. Wear safety glasses

Handsawing

Items Needed

- A vise bolted to a 1-by-6-inch board, 12 inches long
- Two “C” clamps (to clamp the vise to a heavy table)
- Sufficient quantity of ¾-by-1-inch wood to be cut (approximately 2 inches to cut off plus 12 inches to be held in the vise)
- Handsaw
- Colored marker
- Watch

Procedure

Leave a few inches of wood protruding from the side of the vise. Give the Cub Scout the command to start, and time him as he cuts completely through the wood. Maximum time is 1½ minutes (90 seconds). The adult marks the Cub Scout’s time in seconds on the boy’s score sheet with a specific colored marker and initials it. The Cub Scout takes back his sheet, moves to the next event of his choice, and presents his sheet at that event.

Safety Notes

1. The adult might have to sit on the table or rest a foot on it while the Cub Scout is sawing to limit movement.
2. The Cub Scouts keeps either
 - a. both hands on the saw, or
 - b. one hand on the saw and the other hand behind his back (Saws tend to bind and jump out of saw kerf.)

Drilling

Items Needed

- Drilling brace and bit ($\frac{3}{4}$ -inch bit suggested)
- Piece of $\frac{1}{4}$ -inch plywood, approximately 2 by 3 feet
- Backer board of $\frac{3}{4}$ -inch plywood, approximately 2 by 3 feet (backer board is placed under $\frac{1}{4}$ -inch plywood to protect damage to bit)
- Colored marker
- Watch

Procedure

Place $\frac{1}{4}$ -inch plywood on $\frac{3}{4}$ -inch plywood, which is set on floor. Give the Cub Scout the command to start. He must drill only one hole through the $\frac{1}{4}$ -inch plywood. (The $\frac{3}{4}$ -inch plywood will lift up approximately 1 to 2 inches when the bit is through.) He is timed until completely finished. Maximum time is 1½ minutes (90 seconds). The adult marks the boy's time in seconds with a specific colored magic marker and initials it. The Cub Scout takes back his sheet, moves to the next event of his choice, and presents his sheet at that event.

Safety Notes

An adult must advise the Cub Scout to stabilize the boards and himself with his foot or feet if he desires.

Shingle Pulling

Items Needed

- Plastic sled
- Bundle shingles (approximately 40 pounds weight)
- Rope approximately 10 feet long to pull sled
- Colored marker
- Watch

Procedure

The adult supervising this event marks off a specific course. (A straight line of about 15 feet is a good distance.) The Cub Scout receives the command to start

and must pull the weighted sled from start to finish as fast as possible. If the sled dumps shingles, the Cub Scout must replace them in the sled and continue to the finish line. A maximum of 1½ minutes (90 seconds) is allowed. The adult marks the boy's time in seconds on his score sheet with a specific colored marker and initials it. The Cub Scout takes back his sheet, moves to the next event of his choice, and presents his sheet at that event.

Safety Notes

1. Keep away from downhill runs.
2. Watch for a fallen boy getting hit by a runaway sled.

Nuts, Bolts, and Washers

Items Needed

- Five different sizes of nuts, bolts, and washers
- Board, drilled to accept bolts (attach a bolt to the board with one of the nuts)
- Colored marker
- Watch

Procedure

Place the board on a table (or on the floor). (Washers and nuts should be placed in line, but randomly, on the board and their shape outlined with a colored marker so that every Cub Scout starts with items placed in the same location.) When the Cub Scout is given the command to start, he must first place the washers on the appropriate bolts. Next, he must put the proper nuts on the bolts and start threading. It is not necessary to thread very far, but nuts must not be just set on. The Cub Scout is timed until finished or until he reaches the maximum of 1½ minutes (90 seconds). The adult marks the boy's time in seconds on his score sheet with a specific colored marker and initials it. The Cub Scout takes back his sheet, moves to the next event of his choice, and presents his sheet at that event.

Light the Match

Items Needed

- Stool, board, or log with many holes
- Hatchet
- Wooden matches (approximately three per Cub Scout plus extras)
- Colored marker
- Watch

Procedure

The adult places about 12 matches in various holes in top of the stool. When the Cub Scout receives the command to start, he must light any *one* match in a chop-type motion with the hatchet. If he breaks one or decides one won't light, he moves to another until he lights one or until he reaches the maximum time of 1½ minutes (90 seconds). The adult marks the boy's time in seconds on his score sheet with a specific colored marker and initials it. The Cub Scout takes back his sheet, moves to the next section of his choice, and presents his sheet at that event.

Safety Notes

1. Adult works with *one* Cub Scout at a time.
2. The Cub Scout must keep both hands on the hatchet or he is disqualified.
3. The hatchet must not be swung. It is used only in a slight chopping motion.

Scoring and Awards

After the Cub Scout finishes all six events, he turns in his score sheet, with all events scored by an adult. (Be sure he has his name on the sheet.) Adults add up the total time used. The winner overall is the Cub Scout who used the least amount of time. Winners can be decided for each event, or you can just have overall winners. Scoring can also be by age groups 7–8, 9, and 10–11. If you determine three winners in each event from the different age groups, one in each event for all age groups, plus an overall winner, you can have 25 different winners.

The entire procedure goes quickly, as boys can select or be directed to events that are not overcrowded. Each Cub Scout must complete each event. (Otherwise, the Cub Scout receives the maximum time allowed.) Scoring can be done as Cub Scouts finish, so the total results will be known about five minutes

after the conclusion of all events. The event can take place indoors or outdoors. Prizes should be in the Handyman theme. Some suggestions include

- Flashlight
- Tape measure
- Screwdriver
- Ruler or yardstick
- Certificate

Helpful Hints

An additional event to keep Cub Scouts and family members busy before or after the competition is guessing the number of nails in a large pickle jar (about ½ gallon). Any person so desiring can fill out one guess slip on the number of nails in the jar. *One* adult counts and records the quantity on paper and attaches it to the lid inside the jar before the event. Guess slips can be given out to all at the same time as score sheets are given to the Cub Scouts. Use a coffee can with a slot in its plastic lid to contain guesses. Items needed include

- Guess sheet
- Pencils to record guesses
- Coffee can
- Jar
- Nails
- Tables and chairs (optional)
- Prizes (optional)

How about other games, such as

1. Guessing the distance in inches between two points
2. Guessing the size of a nail: 6-penny? 10-penny?
3. Showing a chart of screws and determining which has a round, flat, or oval head
4. Identifying tools

Shooting Sports in the Cub Scout Camping Program

BB Guns

Intelligent, supervised use of sporting gear such as firearms and airguns is consistent with our principle of "safety through skill." Approval has been given for a smoothbore BB gun safety and marksmanship program in Cub Scout camps. **Cub Scouts are not permitted to use any other type of handgun or firearm.**

Important: A council wanting to use BB guns as a part of the Cub Scout day camp program must follow the policies and guidelines. See *Cub Scout Shooting Sports*, No. 13-550.

Archery

Archery provides a colorful, interesting, and worthwhile activity for boys. The beginner gets immediate satisfaction yet finds a continuous challenge as he develops into a skilled archer. This activity provides good physical exercise and develops powers of concentration and coordination.

The goal is to teach Tiger Cubs, Cub Scouts, and Webelos Scouts how to use the bow and arrow safely. See *Cub Scout Shooting Sports*, No. 13-550.

Suggested Range Layout

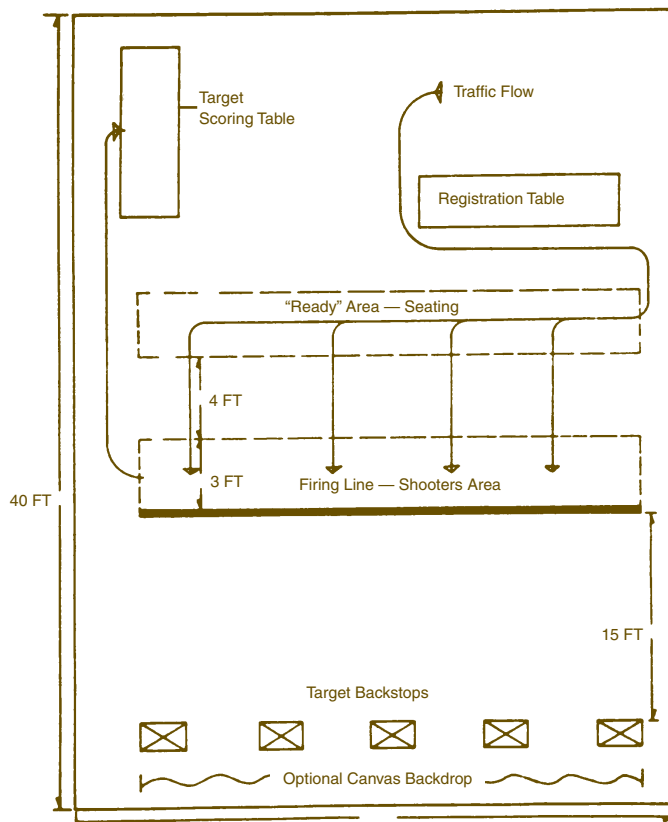

Sports and Fitness

A camp with the Athlete theme should provide programs to reinforce habits of good physical fitness and sportsmanship.

The program should include

- Stretching
- Exercising
- Instructions in specific sports skills
- Practice time
- Tournaments
- Measurements of strengths at the beginning and end of camp
- Involvement of adult teammates in exercise and practice of individual sports

Establish an area that becomes the gym. It should look like a gym and contain

- Mats
- Ladder for overhand walk
- Chinning bars for development of arms and shoulders
- Rope swings
- Tires for running
- Stopwatches for timing
- Inner tubes and barbells for exercise
- Pitcher target
- Standing broad jump area

The individual sport playing area can be established nearby for each sport.

Obstacle Course

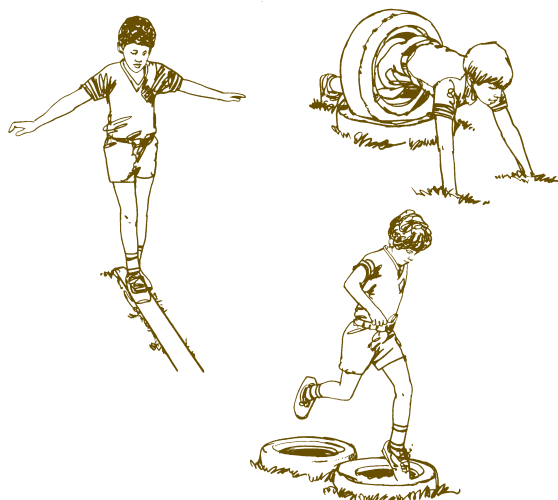

The obstacle course should be set up as a foot rally with a definite trail as the Cub Scouts and Webelos Scouts go from one obstacle to another. The adults

may want to participate if the course is sturdy enough, but be sure all the boys get to participate.

Balance Beam

Stake down a standard 8-foot two-by-four with tent stakes. The Webelos Scouts run across the edge of the board. If they fall, they must start over.

Box Tunnel

Nail, tape, or staple several open-ended cardboard boxes to form a tunnel to run through.

Rope Web

Drive six long stakes into the ground and make a web by weaving a rope from one stake to another about 16 to 20 inches above the ground. The boys must crawl from one end to the other.

Postman's Bridge

Tie two large ropes between trees. The ropes should be parallel, about 4 feet apart and about 3 feet off the ground. Step on the lower rope, and use the upper rope as a handrail.

Lily Pad Relay

Make two "lily pads" with $\frac{1}{2}$ -inch plywood about 3 feet in diameter. Connect the two pads with a 6-foot piece of rope. The boys must travel down a course by throwing out the lily pads and jumping or stepping from one pad to another. The course should be about 50 feet long.

Tire Race

Lay out two lines of old tires. The boys must run down the course and put a foot in every tire.

Areas of Safety Concern

Swimming and Boating

To help you organize your safety measures on water outings, these resources have been developed:

Safe Swim Defense Plan, No. 34370
Safety Afloat, No. 34159
Camp Program and Property Management,
No. 20-920

Archery Range

Consult *Cub Scout Shooting Sports* (No. 13-550) safety measures on your archery range.

BB Gun Range

If you choose to have a marksmanship program for Cub Scouts, it is most important to ensure safety for all participating. Guidelines are provided in this booklet and in *Cub Scout Shooting Sports* (No. 13-550).

Horsemanship Guidelines

Horsemanship activities in Scouting include merit badge activities, arena rides, and multiday trips (including treks and cavalcades) and *Cub Scout familiarization rides*.

Each sponsoring council should take care to design age-appropriate and activity-appropriate procedures, and guidelines for each equine activity. It is not possible or appropriate to dictate each aspect of every program. See the Health and Safety Guide No. 34415.

Camp Achievements and Awards

The Cub Scout advancement program was planned to encourage the natural interests of boys in a natural way. The badge is recognition for doing one's best, and the real satisfaction should come from the *doing*, not the getting. These principles are also applicable in the Cub Scout camp program.

Awards can be controversial. Recognition for achievement is one of the driving urges of Cub Scout-age boys, but the award should only recognize doing one's best, and not foster excessive competition.

In general, awards that make the happiest Cub Scout campers are

- Den treats, such as a watermelon feed
- Special privileges, e.g., an extra swim period or raising the flag
- Formal recognition at a flag ceremony or campfire
- Awards based on self-improvement

One council has been successful with a leather-belt totem and big beads to be put on thongs from the totem for improvement and campwide participation. These beads are awarded in the activity areas. Winning events and completing camp award requirements calls for immediate recognition. The aim is for every boy to receive at least one bead during camp.

World Brotherhood Day

Add some "international flavor" by having a World Brotherhood Day at your Cub Scout camp.

1. Use any international Scouter on your staff as the coordinator or focal point of World Brotherhood Day.
2. Flag ceremonies should include the purple and white World Scouting flag and the U.S. flag.
3. Have international menus in the camp dining hall or at the campsites. There is no need to have fancy, expensive foods. Just give international names to the standbys, e.g., Canadian bacon, Swiss chocolate, French toast, Swedish pancakes, etc.

4. Have all staff members dress in costumes of other countries (not Scouting uniforms because they are not easily available). Costumes can be simulated with items that are readily available and not expensive.
5. Sing international songs in the dining hall, e.g., "Alouette," "Going Gang Gooli," "Frère Jacques," etc.
6. Decorate the dining hall or campsites with flags from around the world made by Cub Scouts, or make your own flags.

7. Include international games and contests in the program schedule, e.g., English-style rugby or cricket, archery (William Tell–style, using balloons instead of apples on a nonhuman target), orienteering (Scandinavian), etc.
8. Ask your international camp staff member to tell about his or her country, its flag, national song, food, culture, etc. Fly the flag of the staff member’s country along with the American and World Scouting flag.
9. Conclude World Brotherhood Day festivities with a good campfire program featuring songs, skits, and stunts from other lands. Take a collection for the World Friendship Fund after someone has explained what it is and what it does.
10. You might want to invite local international service clubs, such as Rotary, Kiwanis, Lions, etc., to visit camp on World Brotherhood Day. They might be surprised to learn how “international” Scouting is.
11. Be creative—use your own ideas! Use local resources such as museums, libraries, colleges, and universities that have international programs, students, etc.
12. Inquire at your local council service center about international display items; some are free of charge, and some are for sale.

Religious Emblems

Many religious organizations offer religious emblems programs for their young people who are involved in Scouting. Here are some resources that can be useful in introducing religious emblems programs to Tiger Cubs, Cub Scouts, Webelos Scouts, and parents and in developing a presentation to help them fulfill the requirements for their religious emblems in a camp setting. These items can be obtained from your local BSA council.

- Duty to God quick reference poster, No. 05-879A
- Fact sheets and brochures on various faiths from the Relationships Division at the BSA national office
- Specific religious emblems requirements books (usually cost items; some faiths provide them at no charge)
- Copies of graces for meals (songs)
- An information folder to take home (for parents and clergy) developed by the council

For additional information on the God and Country program and many other religious emblems programs, contact Programs of Religious Activities with Youth (P.R.A.Y.) at the address shown below.

References

Religious Relationships, S326
 Boy Scouts of America
 1325 West Walnut Hill Lane
 P.O. Box 152079
 Irving, TX 75015-2079

Programs of Religious Activities With Youth (P.R.A.Y.)
 P.O. Box 6900
 St. Louis, MO 63123
 800-933-PRAY

Sample Graces

‘Neath These Tall Green Trees

‘Neath these tall green trees we stand
 Asking blessings from thy hand
 Thanks we give to thee above
 For thy help and strength and love.

Before the Night

Before this day is over,
 Before the night begins,
 Help me protect the planet;
 Be one of its caring friends.
 I thank you for all your blessings.
 May I earn the right
 To live in harmony with them
 Before the night.

APPENDIX

Suggested Timetable, 72

Supply Division Helps, 73

Accounts for Developing Camp Budgets, 74

Camp Budget Worksheet, 75

Personal Health and Medical Record Form, 76

Cub Scout/Webelos Scout Equipment List, 78

Daily Camp Program Schedule, 79

Sample Reservation Forms (Pack, Individual), 80

Sample Camp Activities Schedule, 81

**Program Activities That Might Be Used in
Cub Scout Resident Camp, 82**

Cub Scout World, 83

Suggested Timetable

September

Critique meeting of summer's resident camp(s). Plan meeting dates for next summer's resident camp(s).

October

Cub Scout/Webelos Scout resident camp meeting—discuss location, program, theme, dates, staff, budget, fees, etc.

November

Resident camp director and program director selected, plans made to attend National Camping School.

December

Plans on theme, artwork finalized.

January

Leader information written and printed in time to mail for blue and gold banquets. Promotion team recruited and trained.

February

Key staff recruiting planned.

Promotion presentations scheduled and begun.

Precamp inspection to determine that required standards will be met.

March

Key staff recruited.

Address fliers, recruit staff, make roundtable presentations, begin recruiting boys for Cub Scout resident camp.

April

Continue staff recruiting, pack visits, and promotion.

Resident camp meeting; plan booth for Scouting show.

Attend resident camp National Camping School.

May

Complete staff recruiting and continue promotion.

Scouting show booth.

Resident camp meeting—finalize staff training, preview manual.

Staff development—all staff members.

June

Recheck all preparations, conduct onsite training.

July/August

Resident camp in operation.

Conduct resident camp visitation during camp.

Staff evaluation sheets returned on last day of each session.

August

Resident camp staff recognition dinner.

September

Resident camp review.

Start planning for next year.

Supply Division Helps

Throughout this manual, references are made to equipment needs, resale merchandise for trading posts, program aids, and promotional items such as T-shirts, embroidered emblems, etc. Following is a list of source material to help you in securing these goods.

No. 70-013—Custom Design Catalog. Features T-shirts, emblems, mugs, and a line of specialty items that can be custom designed with your Cub Scout camp emblem or any other custom design emblem and/or message.

No. 70-010—Camp Equipment Catalog. Features a full line of camping equipment, rowboats, archery equipment, waterfront equipment, and special literature needs.

No. 70-054—Camp Trading Post Resale Order Form, including Cub Scout day camp items. Price list and order form to assist you in ordering some of the most popular trading post items.

No. 70-051—Official Retail Catalog. A complete line of handicraft projects for Scouts of all ages is included in this catalog.

All these catalogs and price lists, and the merchandise within these catalogs, are available through the Supply Division, Boy Scouts of America.

Special Cub Scout day camp and resident camp trading post package plans offer you a balanced assortment of merchandise, along with new items for camp. And it's so easy to order because the amount of merchandise in each package has been predetermined for 100 Tiger Cubs, Cub Scouts or Webelos Scouts. Just anticipate your attendance, indicate the number of packages needed, and you're in business!

When ordered in sufficient quantity for your anticipated attendance, the package qualifies for deferred billing privileges, with payment due in full no later than August 31. Another package benefit includes waiving the normal 15 percent handling charge for merchandise returned in saleable condition on or before an October date. Refer to the Deferred Payment Plan Agreement, No. 70-601, for additional details.

The Scouting Seal Is Your Guarantee of Quality, Excellence, and Performance

Boy Scouts of America Supply Division, National Distribution Center, 2109 Westinghouse Blvd., Charlotte, NC 28241-7143; 800-323-0732



Accounts for Developing Camp Budget

Income	Prior		Current		Budget Next Year
	Budget	Actual	Budget	Actual	
Camp fee					
Camping—rental revenue					
Sale of meals					
Program fees					
Camping—food and other commissary supplies sold					
Vending machine commissions					
Transportation fees					
Recycling revenues					
Government subsidies					
Government surplus food					
Trading post sales					
Trading post cost of sales					
Vending machine sales					
Vending machine cost of sales					
Other income					
Total Income					
Expenses					
Professional staff salaries					
Camp staff salaries					
Social security taxes					
Unemployment taxes					
Workers' compensation insurance					
Temporary disability taxes					
Other payroll taxes					
Medical, health, and safety supplies					
Program supplies					
Food—commissary supplies expense					
Sanitation and cleaning supplies					
Office supplies					
Catering and food service					
Expendable unit supplies					
Expendable kitchen supplies					
Other supplies					
Telephone					
Fax					
Postage					
Outbound freight charges					
Inbound freight charges					
Site or facility rental					
Electricity					
Gas (cooking, heating)					
Water and sewer costs					
Contract services					
Buildings and grounds maintenance					
Equipment rental					
Equipment maintenance					
Printing					
Photography					
Outside printing					
Gas and oil (vehicles)					
Auto allowance					
Hotels, meals, incidentals					
Short-term vehicle rental					
Transportation fees					
National Camping School					
Staff training					
Recognitions and awards (adults)					
Recognitions and awards (campers)					
Recognitions and awards (units)					
Recognitions and awards (staff)					
Liability insurance					
Campers' insurance					
Camp—license fees and inspection fees					
Purchase discounts					
Total Expenses					

Camp Budget Worksheet*

For _____ Cub Scouts—Estimated Income \$ _____ at \$ _____ per boy a week
 \$ _____ per adult a week

- I. STAFF SALARIES** (\$ _____/wk) \$ _____
- 1. Program director \$ _____
 - 2. Aquatics director \$ _____
 - 3. Sports director \$ _____
 - 4. Nature director \$ _____
 - 5. Quartermaster/clerk \$ _____
 - 6. Crafts \$ _____
 - 7. _____ Jr. staff \$ _____
 - 8. Camp director \$ _____
 - 9. First aid \$ _____
 - 10. Cook and kitchen \$ _____
 - 11. Business manager \$ _____
 - 12. Training—National Camping School \$ _____

- II. PROMOTION**
- 1. Printed brochure mailed to all registered Cub Scouts
 - 2. Roundtables
 - 3. Other media—TV, radio, papers

- III. INSURANCE AND MEDICAL** (\$ _____/wk) \$ _____
- 1. Individual insurance \$ _____/wk
 - 2. Medical supplies \$ _____

- IV. FOOD/BEVERAGES** (\$ _____/wk) \$ _____
- \$ _____ per day per Cub Scout or adult

- V. RECOGNITION ITEMS** (\$ _____/wk) \$ _____
- 1. Patches _____ ea. \$ _____
 - 2. Ribbons _____ pcs. \$ _____
 - 3. Certificate—Staff \$ _____

- VI. PROGRAM SUPPLIES** \$ _____
- 1. Archery _____ sets
 - 2. Fishing _____ sets
 - 3. Other field sports equipment

- VII. CRAFTS** (\$ _____/wk) \$ _____
- 1. Craft materials
 - 2. Nature crafts supplies

- VIII. AQUATICS** \$ _____
- 1. Pool fees—\$ _____/wk
 - 2. Equipment—\$ _____

- IX. GAMES** (\$ _____/wk) \$ _____
- 1. Game supplies

TOTAL BUDGET \$ _____

- I. Capital Equipment \$ _____
- II. Other weekly expenses \$ _____

Grand Total _____ weeks, expenses for approximately _____ Cub Scouts \$ _____
 _____ Adults \$ _____
 Individual cost. \$ _____/wk. \$ _____

*Costs and fees will vary from area to area and from season to season.



PERSONAL HEALTH AND MEDICAL RECORD

CLASS 1 AND CLASS 2

Class 1 (update annually for all participants). Activity: Day camp, overnight hike, or other programs not exceeding 72 hours, with level of activity similar to that of home or school. Medical care is readily available. Current personal health and medical summary (history) is attested by parents to be accurate. This form is filled out by all participants and is on file for easy reference.

Class 2 (required once every 36 months for all participants under 40 years of age). Activity: Resident camp or any other activity such as backpacking, tour camping, or recreational sports involving events lasting longer than 72 consecutive hours, with level of activity similar to that at home or school. Medical care is readily available.

Note: Some states require an **annual** precamp medical evaluation. Your BSA local council service center can advise you about the requirements for your state.

If your child has had a medical evaluation (**physical examination**) within the last 36 months, a copy of the results of this examination must be attached to the health history for all participants in a camping experience lasting longer than 72 consecutive hours. If a copy is not available, a physical examination (using the Class 2 section of this form) must be scheduled by a *licensed health-care practitioner. This medical evaluation (physical examination) also is required if your child is currently under medical care, takes a prescribed medication, requires a medically prescribed diet, has had an injury or illness during the past 6 months that limited activity for a week or more, has ever lost consciousness during physical activity, or has suffered a concussion from a head injury.

*Examinations conducted by licensed health-care practitioners, other than physicians, will be recognized for BSA purposes in those states where such practitioners may perform physical examinations within their legally prescribed scope of practice.

THIS FORM IS NOT TO BE USED BY ADULTS OVER 40, BY HIGH-ADVENTURE PARTICIPANTS (USE FORM NO. 34412A), OR FOR NATIONAL SCOUT JAMBOREE (USE FORM NSJ-34412-01).

CLASS 1 PERSONAL HEALTH AND MEDICAL HISTORY

(To be filled out annually by all participants)

To be filled out by parent, guardian, or adult participant. Please print in ink.

IDENTIFICATION

Name _____ Date of birth _____ Age _____ Sex _____

Name of parent or guardian _____ Telephone _____

Home address _____ City _____ State _____ Zip _____

Business address _____ City _____ State _____ Zip _____

If person named above is not available in the event of an emergency, notify

Name _____ Relationship _____ Telephone _____

Name _____ Relationship _____ Telephone _____

Name of personal physician _____ Telephone _____

Personal health/accident insurance carrier _____ Policy No. _____

I give permission for full participation in BSA programs, subject to limitations noted herein.

In case of emergency, I understand every effort will be made to contact me (if participant is an adult, my spouse or next of kin). In the event I cannot be reached, I hereby give my permission to the licensed health-care practitioner selected by the adult leader in charge to secure proper treatment, including hospitalization, anesthesia, surgery, or injections of medication for my child (or for me, if participant is an adult).

Date _____ Signature of parent/guardian or adult _____

Some hospitals require the parent/guardian signature to be notarized. Check with your BSA local council.

NAME

TROOP

CAMP SITE

Check all items that apply, **past or present**, to your health history. Explain any "Yes" answers.

ALLERGIES: Food, medicines, insects, plants Yes No Explain: _____

GENERAL INFORMATION: Yes No Y es No Yes No

ADHD (Attention-Deficit Hyperactivity Disorder)	<input type="checkbox"/>	<input type="checkbox"/>	Convulsions/seizures	<input type="checkbox"/>	<input type="checkbox"/>	Hemophilia	<input type="checkbox"/>	<input type="checkbox"/>
Asthma	<input type="checkbox"/>	<input type="checkbox"/>	Diabetes	<input type="checkbox"/>	<input type="checkbox"/>	High blood pressure	<input type="checkbox"/>	<input type="checkbox"/>
Cancer/leukemia	<input type="checkbox"/>	<input type="checkbox"/>	Heart trouble	<input type="checkbox"/>	<input type="checkbox"/>	Kidney disease	<input type="checkbox"/>	<input type="checkbox"/>

Explain: _____

Please list ALL medications taken in the 30 days **prior** to arrival at the Scouting activity where this form is to be used: _____

List any medications to be taken at camp: _____

List any physical or behavioral conditions that may affect or limit full participation in swimming, backpacking, hiking long distances, or playing strenuous physical games: _____

List equipment needed such as wheelchair, braces, glasses, contact lenses, etc.: _____

Immunizations: (Give date of last inoculation.)

Tetanus toxoid _____	Measles _____	Polio _____
Diphtheria _____	Mumps _____	_____
Pertussis _____	Rubella _____	_____

CLASS 2 MEDICAL EVALUATION
(Read additional requirements outlined on front of form.)

Name _____ Age _____

NOTE TO LICENSED HEALTH-CARE PRACTITIONERS*: The person being evaluated will be attending one or more weeks of camp that may include sleeping on the ground and participating in strenuous activities such as hiking, boating, and vigorous group games. Please review the health history with the participant for any interim changes. **Explain any "abnormal" evaluations.**

PHYSICAL EXAMINATION (To be filled out by a licensed health-care practitioner*)

Height _____ Weight _____ BP _____ / _____ Pulse _____

VISION: Normal _____ Glasses _____ Contacts _____

HEARING: Normal _____ Abnormal _____ Explain _____

Check box:	N	Abn		N	Abn		N	Abn
Growth development	<input type="checkbox"/>	<input type="checkbox"/>	Teeth	<input type="checkbox"/>	<input type="checkbox"/>	Genitalia	<input type="checkbox"/>	<input type="checkbox"/>
Skin	<input type="checkbox"/>	<input type="checkbox"/>	Cardiopulmonary system	<input type="checkbox"/>	<input type="checkbox"/>	Musculoskeletal	<input type="checkbox"/>	<input type="checkbox"/>
HEENT	<input type="checkbox"/>	<input type="checkbox"/>	Hernia	<input type="checkbox"/>	<input type="checkbox"/>	Neurobehavioral	<input type="checkbox"/>	<input type="checkbox"/>

Explain: _____

Limitations

Activity restrictions _____

Diet restrictions _____

Signature _____ Date _____

Licensed health-care practitioner*

Address _____ Phone _____

City, State, Zip _____

***Examinations conducted by licensed health-care practitioners, other than physicians, will be recognized for BSA purposes in those states where such practitioners may perform physical examinations within their legally prescribed scope of practice.**

INTERVAL RECORD	SCREENING EXAMINATION	
Date, Time, Place, Etc.	(Findings, diagnoses, treatment, instructions, disposition, etc.)	By _____
PHOTOCOPYING THIS FORM IS PERMITTED.		

#34414A



7 30176 34414 0

34414A
2002 Printing

NAME

TROOP

CAMP SITE

Cub Scout/Webelos Scout Equipment List

Please reproduce these lists and distribute to all campers so they will come to resident camp prepared. Quantities may vary depending on the length of stay.

Required Equipment

- | | |
|--|--|
| <input type="checkbox"/> Flashlight and batteries | <input type="checkbox"/> Neckerchief and slide |
| <input type="checkbox"/> Swimsuit | <input type="checkbox"/> Sleeping bag or three warm blankets |
| <input type="checkbox"/> Two towels | <input type="checkbox"/> Scout T-shirts |
| <input type="checkbox"/> Wolf/Bear/Webelos handbook | <input type="checkbox"/> Personal Health and Medical Form |
| <input type="checkbox"/> Pencils/pens and paper | <input type="checkbox"/> Extra pair of shorts |
| <input type="checkbox"/> Jacket or sweater | <input type="checkbox"/> Two pair of sneakers |
| <input type="checkbox"/> Pillow | <input type="checkbox"/> Three pair of pants |
| <input type="checkbox"/> Sleeping pad or cot | <input type="checkbox"/> Raincoat or poncho |
| <input type="checkbox"/> Cub Scout or Webelos Scout uniform | <input type="checkbox"/> Pajamas |
| <input type="checkbox"/> Three sets of underwear | <input type="checkbox"/> Shower shoes |
| <input type="checkbox"/> Canteen/water bottles | <input type="checkbox"/> Mosquito net or repellent |
| <input type="checkbox"/> Personal toiletry articles (toothbrush, soap, toothpaste, comb) | |

Optional Equipment

- Knife—**only** if requested by resident camp leader
- Camera and film, or digital camera
- Fishing pole and tackle
- Musical instrument
- Bible or other book important to religious observations

Leaders' Equipment Suggestions

In addition to the list of equipment above, leaders may want to consider having the following items:

- Lawn chair
- Clipboard or folding notebook with a clipboard for carrying notes and handouts
- Knapsack for carrying den's raingear during camp
- Camp lantern
- Songbooks and books of skits
- Sleeping pad or cot

What to Leave Home

You will want to leave a number of items home rather than bringing them with you. The following items are *not* allowed at camp: knives, firearms and ammunition, pets, axes and other woods tools, drugs, alcohol, archery equipment, and fireworks. (Camp staff will provide program equipment as needed.)

We discourage boys from bringing radios, televisions, CD players, electronic games, comic books, and other items that will distract them from the Cub Scout camp program.

Daily Camp Program Schedule

Daily Program	Hour							
	6:00							
Reveille	7:00							
Breakfast	7:30							
Raise colors	8:45							
Activity period	9:00 to 10:30							
	10:30 to noon							
	Noon							
Lunch and rest								
Activity period	2:00 to 3:30							
	3:30 to 5:00							
Supper	6:00 to 7:00							
Lower colors	7:15							
Activity period	7:30 to 8:30							
Evening program	8:30 to 10:00							
Call to quarters	10:15							
Taps	10:30							

Sample Reservation Forms

PACK RESERVATION

Pack _____ District _____ would like to make a camp reservation for _____ boys and _____ adults and leaders on _____ (date). Enclosed is \$_____ per person (20 percent discount on all fees paid in advance).

Adult in charge _____ Phone (_____) _____
Address _____ City and state _____ Zip _____
Mail to _____ Council _____
Your address

Refunds will be given with proper notification only. (Insert your council's refund policy here.)

----- Cut off and return immediately -----

INDIVIDUAL CUB SCOUT RESERVATION

Cub Scout Summer Adventure—(camp name, your council address)

Cub Scout _____ Pack _____ Town _____
Age _____ Address _____ Zip _____ Phone _____

Period enrolling for (check one):

____ July 1–12

____ July 15–19

____ July 22–August 3

Bus pickup place:

First choice _____

Second choice _____

Enclosed find refundable deposit check for \$_____ made payable to _____ Council, BSA.
Final payment to be made one week before starting date.

Date _____ Parent's signature _____

When your den or pack decides which period to go to camp, give this form and deposit to your den leader.

Refunds will be given with proper notification only. (Insert your council's refund policy here.)

Sample Camp Activities Schedule

Sunday or Thursday

- 1:00 P.M. Arrival and check-in at camp office
- 2:00 Settle in to campsite; medical check
- 3:00 Camp tour, swim check
- 5:30 Prepare for dinner
- 6:00 Assembly, flag ceremony
- 6:15 Dinner
- 8:00 Opening campfire
- 10:00 Leader orientation and cracker barrel*
- 10:30 Lights out

Monday or Friday

- 7:00 A.M. Rise and shine
- 8:00 Breakfast
- 9:00 Activity in your program center
- 10:00 Archery
- 11:00 Nature
- 12:15 P.M. Lunch
- 1:00 Rest period, trading post opens
- 2:00 Swimming
- 3:00 BB gun range
- 4:00 Sports
- 5:00 Activity in your program center
- 6:00 Assembly, flag ceremony
- 6:15 Dinner
- 7:00 Scout's Own service
- 8:00 Activities and campfire in your program center
- 10:00 Lights out

Tuesday or Saturday

- 7:00 A.M. Rise and shine
- 8:00 Breakfast
- 9:00 Activity in your program center
- 10:00 BB gun range
- 11:00 Fishing
- 12:15 P.M. Lunch
- 1:00 Rest period, trading post opens
- 2:00 Archery
- 3:00 Swimming
- 4:00 Sports
- 5:00 Activity in your program center
- 6:00 Assembly, flag ceremony
- 6:15 Barbecue picnic
- 7:30 Free time
- 8:00 Closing campfire
- 9:00 Safe trip home

*Cracker barrel is the Scouting name for an evening snack and fellowship activity.

Program Activities That Might Be Used in Cub Scout Resident Camp

Physical Activities	Wolf	Bear	Webelos Scout
Obstacle course	Running jump	Stake run	Hurdle jump
	Belly crawl	Time obstacle	Ball toss
	Hurdle	Balance	
		Donut crawl	
Physical fitness	Curl-ups	50-yard dash	
	Shuttle run	Push-ups	
	Standing long jump		
Fun Activities	Toss in can	Ring toss	Shoe kick
	Blindfold balance	Bean bag toss	Sock race
	Putting game		Hopping sort
Wood crafts			
Knots (tying things)			
Nature			
Archery/BB guns			
Swimming	Boat safety	Swimming skills	
	Fishing skills	Buddy system	
Sports	Baseball	Flag Football	Derbies
	Soccer	Kite flying	
	Volleyball		

Also include foil cooking; Cracker Barrel; campfires; opening and closing ceremonies; skits, songs, cheers, and yells; hiking; and picnics.

Plan three indoor activities for inclement weather.

Cub Scout World

Where “Let’s Pretend” Is Easy

- The themes used at Cub Scout Worlds spark interest among Cub Scouts and their adult partners and provide a medium for adventure and excitement.
- Cub Scout World participants range from Tiger Cubs, to Wolf and Bear Cub Scouts, to Webelos Scouts.
- There are many reasons why boys attend Cub Scout World, with **fun** being **number one!** In addition, World adventures provide the means for boys to learn physical, mental, and social skills through hands-on activities. Scouts develop trust in others, self-confidence, and a determination to do their best. Cub Scout World is like a giant playground filled with adventure, challenges, and friendships.
- Today, lots of Cub Scout Worlds are in operation, or are being developed. Forts, gold mines, space sta-

tions, castles, ships, American Indian villages, and others provide new worlds to youth members.

- The fabulous themes of Cub Scout worlds could include
 - Bobcat Pavilion
 - Bear Valley
 - Baloo’s Place
 - Fort Akela
 - Mowgli Muscles
 - Huckleberry Finn Rafts
 - U.S.S. *Webelos*
 - A Wild Mountain Village
- Guidance and program support materials are always available from the Cub Scout Division, S208 at the national office. A listing of all Cub Scout worlds is available for local councils.

Notes