



Resolving Vibration Issues of Diesel Engine Driven Fire Water Pumps in QP Offshore

Case Study

By

Isham Sudardjat
Reliability Engineer
QP Offshore Operation

and

Sherief Mekawey
Principal MDS Engineer
GE-Bently Nevada



Contents

- Introduction to QP Offshore
- Background
- Technical Data and Acceptance Criteria
- Contractual Vibration Points
- Vibration Measurement Locations at Field
- Analysis
- Conclusions from Investigation
- Proposed Actions
- Final Vibration Results
- Lessons Learnt

Introduction to QP Offshore

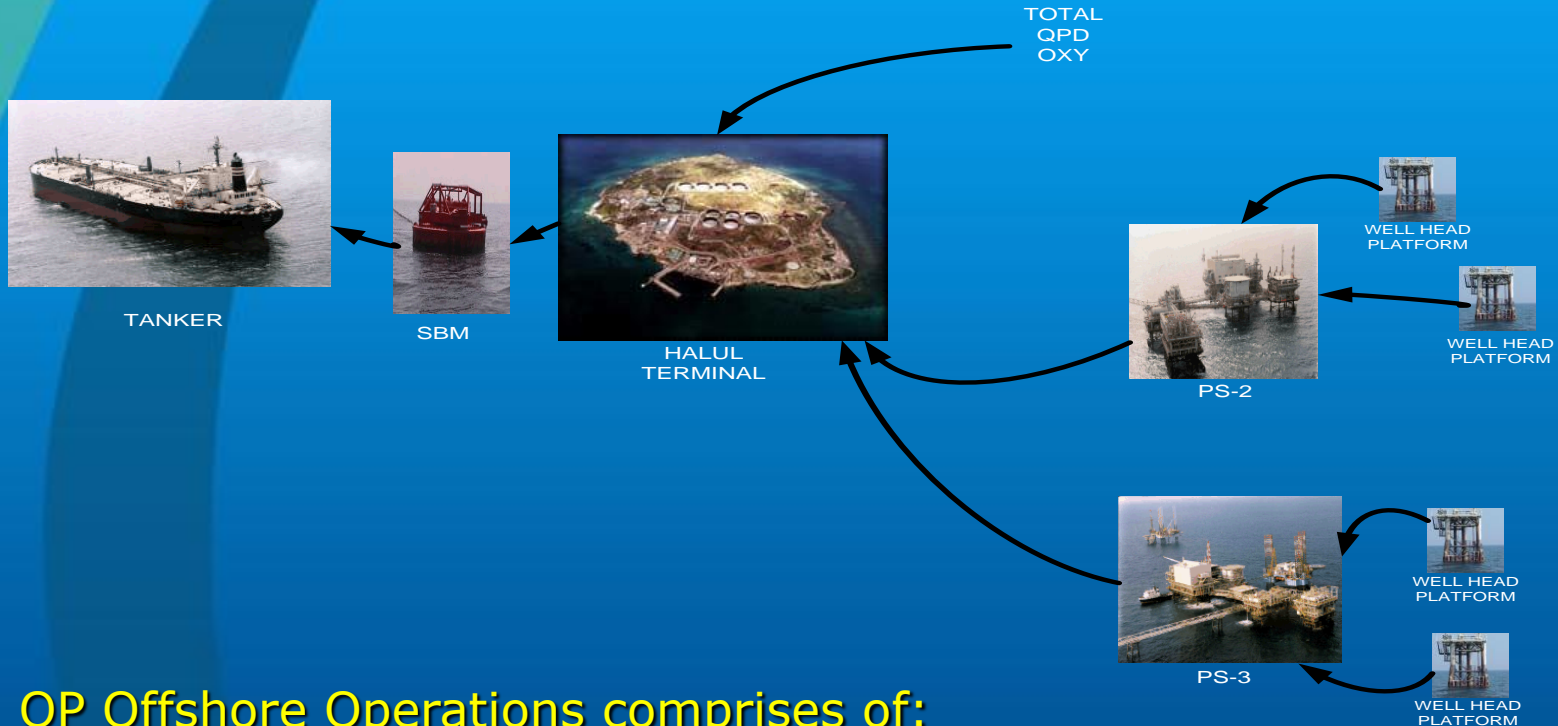

QP Offshore Operations comprises of:

- Halul Storage and Loading Terminal
- 2 Production Platforms:
 - Maydan Mahzam (MM): PS-2
 - Bul Hanine (BH) : PS-3

Background

- Project was started in 2004
- The scopes were engineering, procurement, installation, and commissioning of:
 - 2 jockey pumps (motor driven vertical pumps)
 - 2 sea water utility pumps (motor driven vertical pumps)
 - 4 fire water pumps (diesel engine driven vertical pumps with right angle gearbox)
- Jockey and Sea Water Pumps passed SAT while Fire Water Pumps failed to pass SAT in 2006 due to high vibration.
- 2 vibration consultants were involved to solve the problems without success
- 3rd vibration consultant was involved in Oct 2009, implementation of recommendations started in 2010, hand over in 2012.

Technical Data and Acceptance Criteria

- **Pump:**

- Vertically suspended centrifugal pump, 3 stages
- 1750 rpm, water lubricated, 880 cu.m/hr

- **Drive Shaft :**

- Double Universal Joint Cardan Shaft

- **Gearbox:**

- 750 HP, 1750 RPM,
- 1:1 Ratio, Right Angle
- Threaded Coupling Type

- **Diesel Engine:**

- 12 Cylinders, DITA, 800HP, 1750 RPM

- **Acceptance Criteria:**

- As per NFPA 20 article 7.6.1.5 which refers to Hydraulic Institute Standard (5.84 mm/s rms) at Pump Head

Contractual Vibration Points

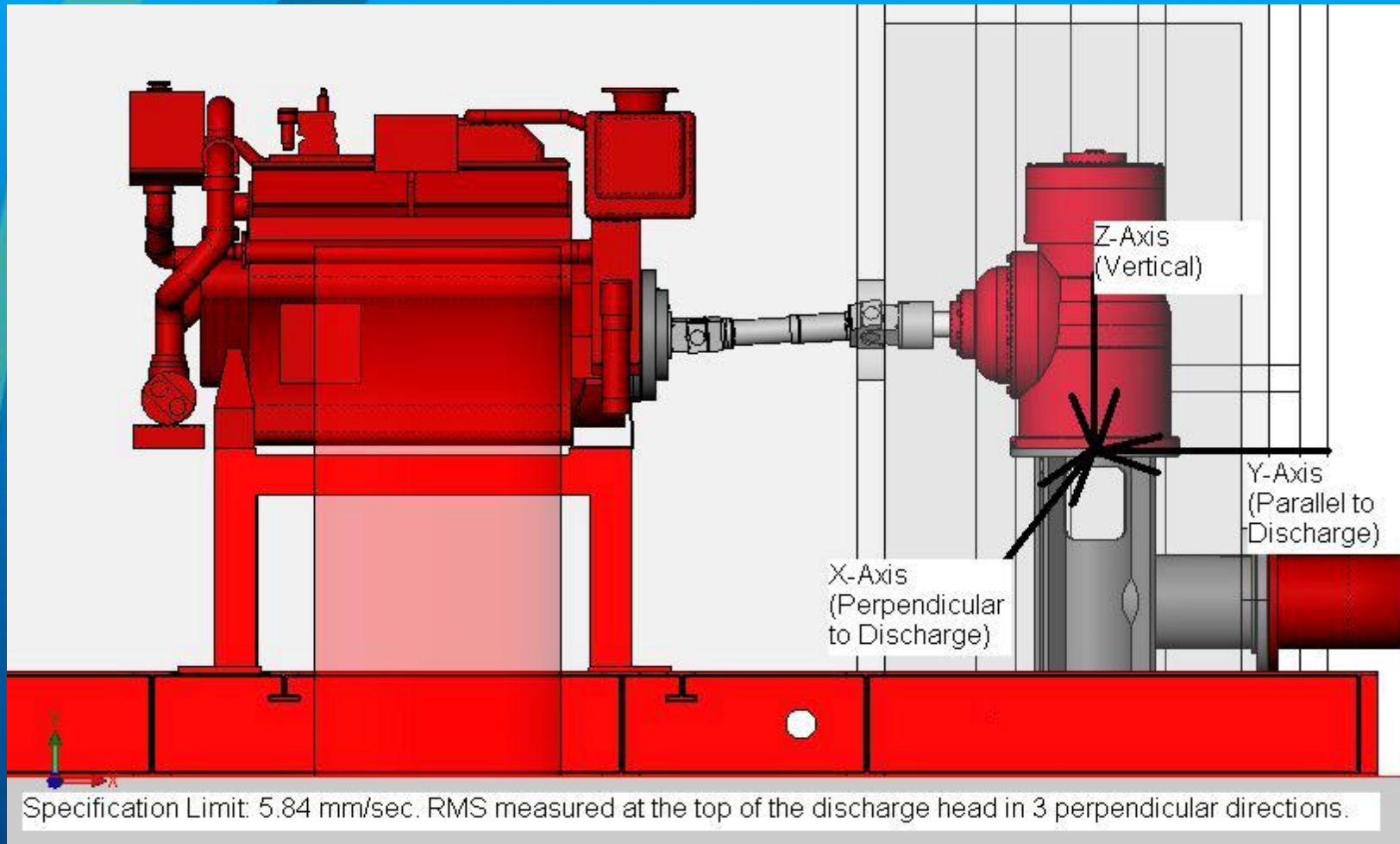

Vibration Measurement Locations at Field

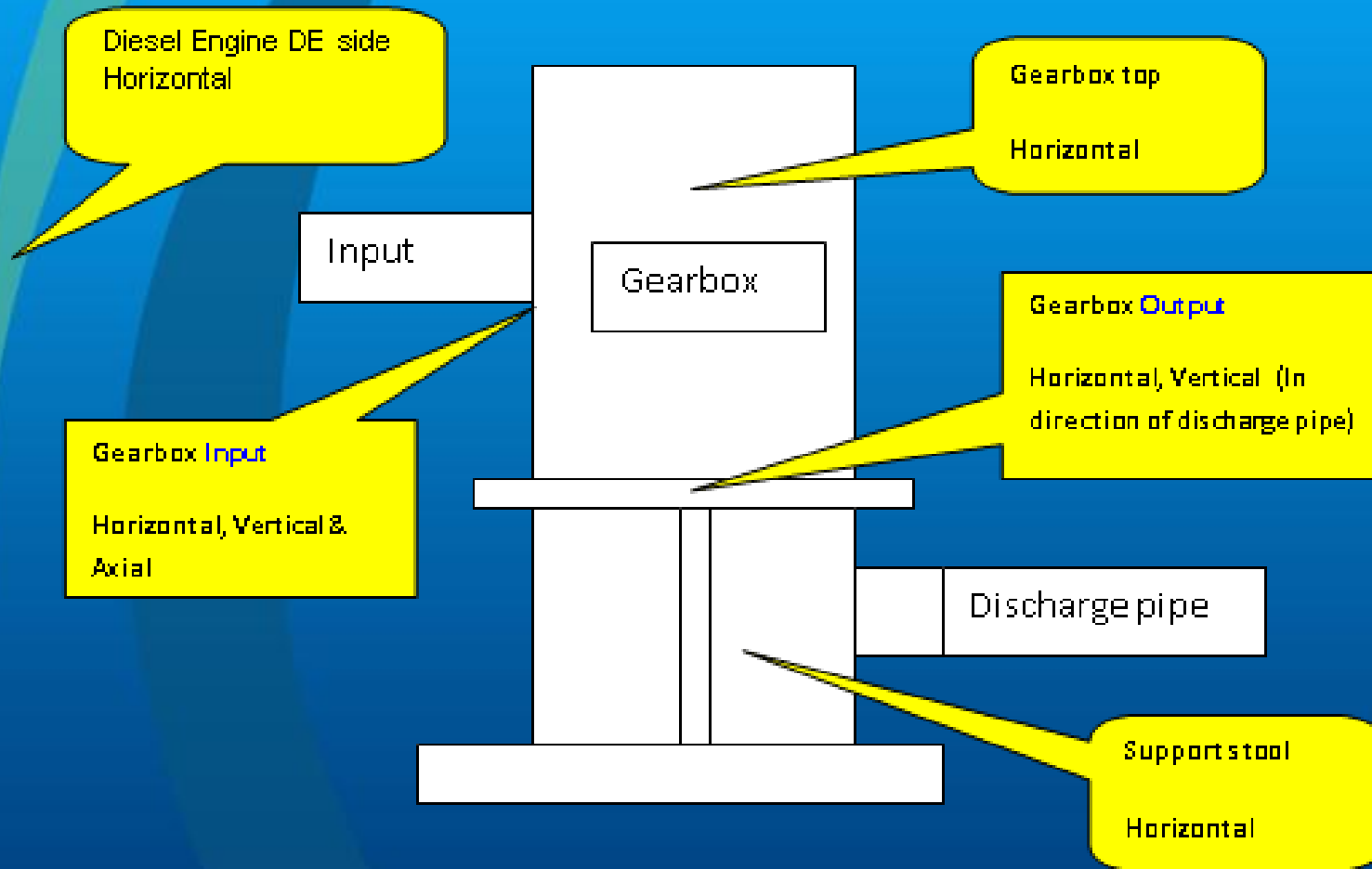

Analysis

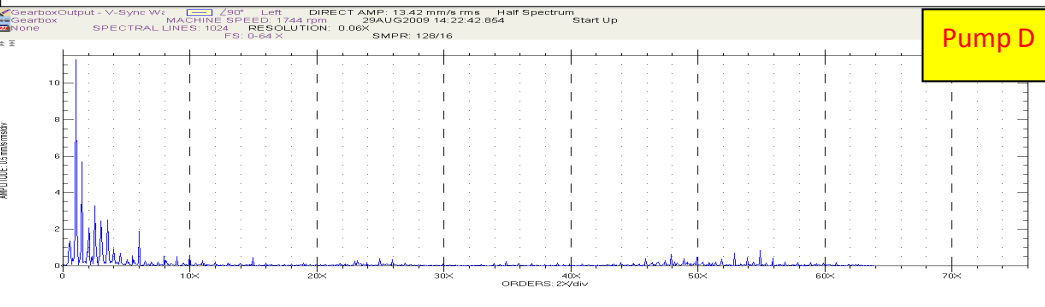
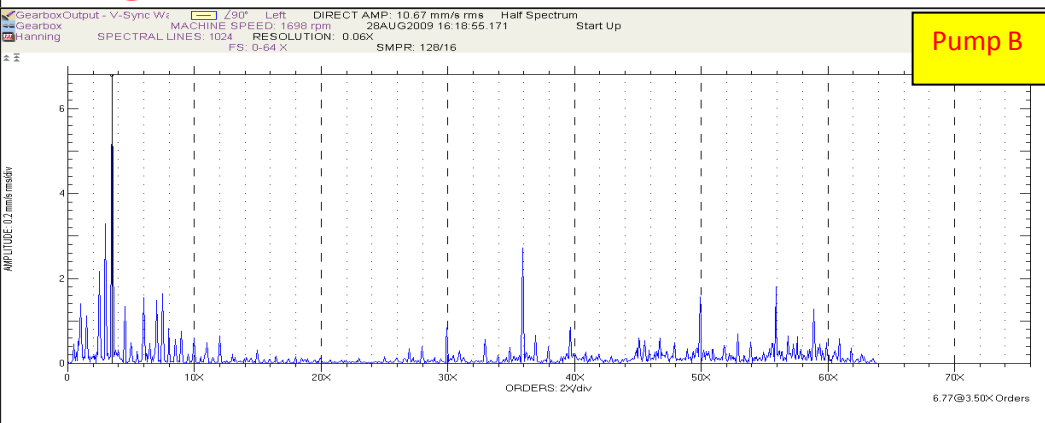
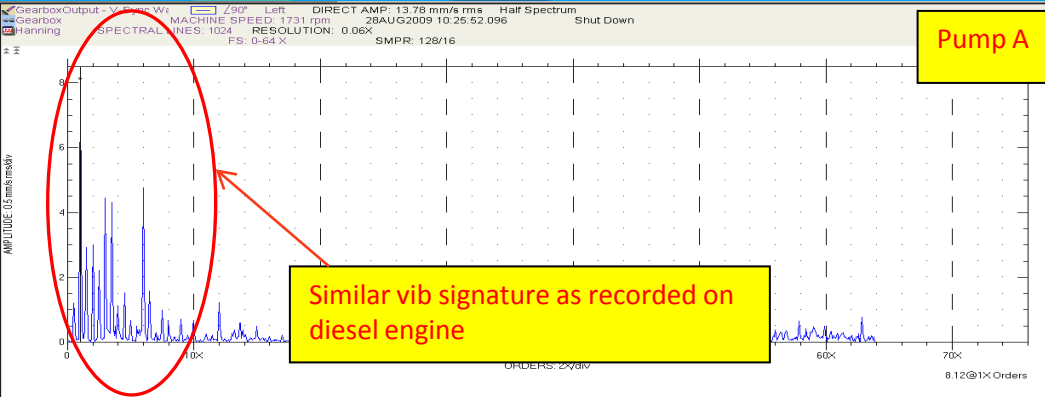

Comparison of vibration signatures of Pumps A, B & D for the GB output Vertical location

Observation-1: Vibration signature on Gearbox indicated that a significant energy getting transmitted from the Diesel Engine components of 3X, 3.5X and 6X other than the dominant 1X

Reason could be: vibration isolators are not installed either under the engine feet nor under the frame on which the engine is mounted.

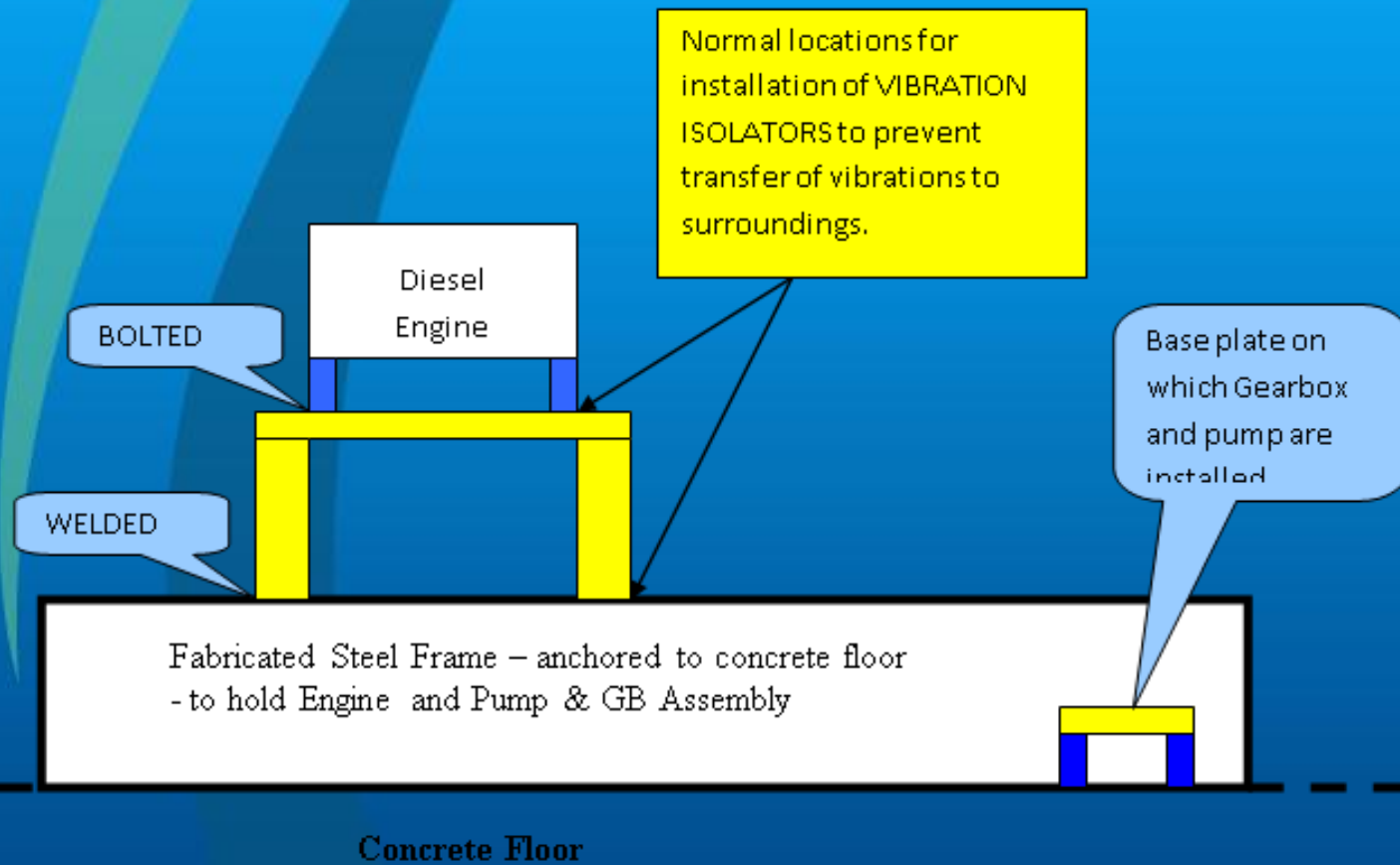

Foundation/supporting arrangement for Diesel Engine, Gearbox and Pump.

Observation: 2 Startup/coast down waterfall indicated resonance in the speed range 1200 to 1400 rpm – Most likely from the cordon shaft or coupling hub

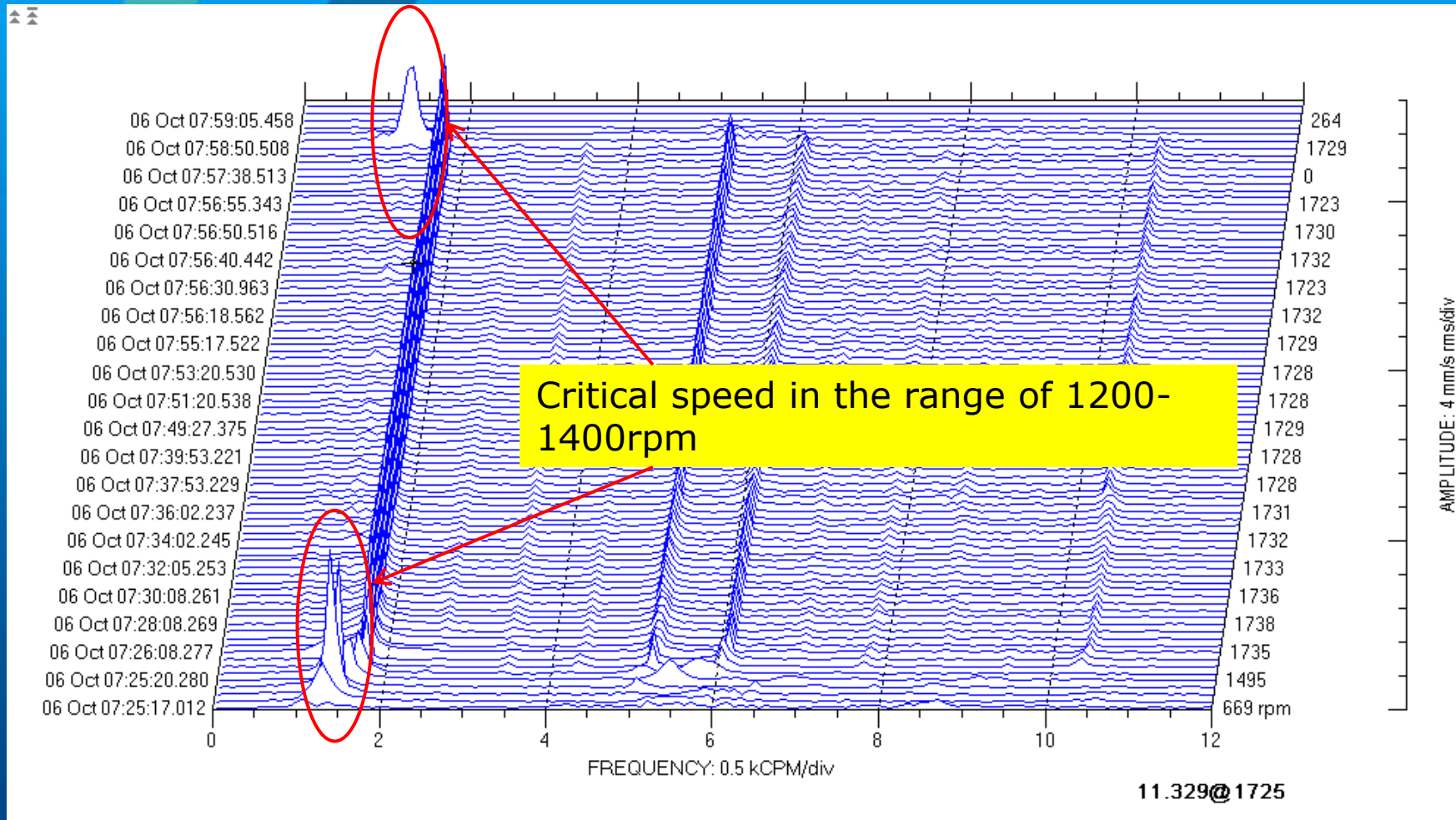

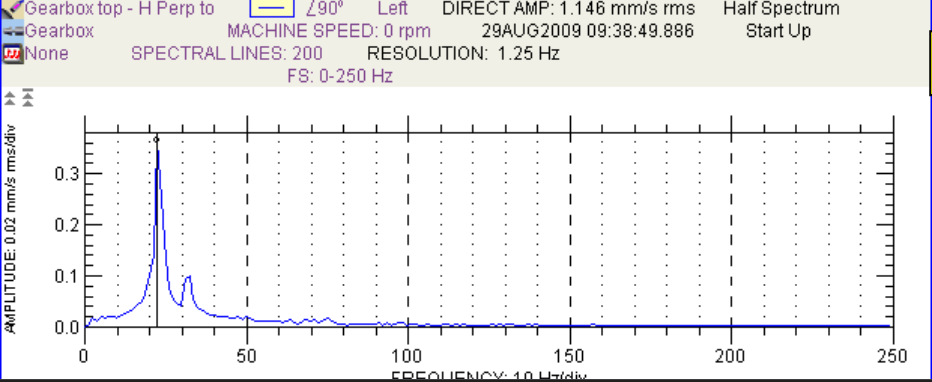

Pump-A

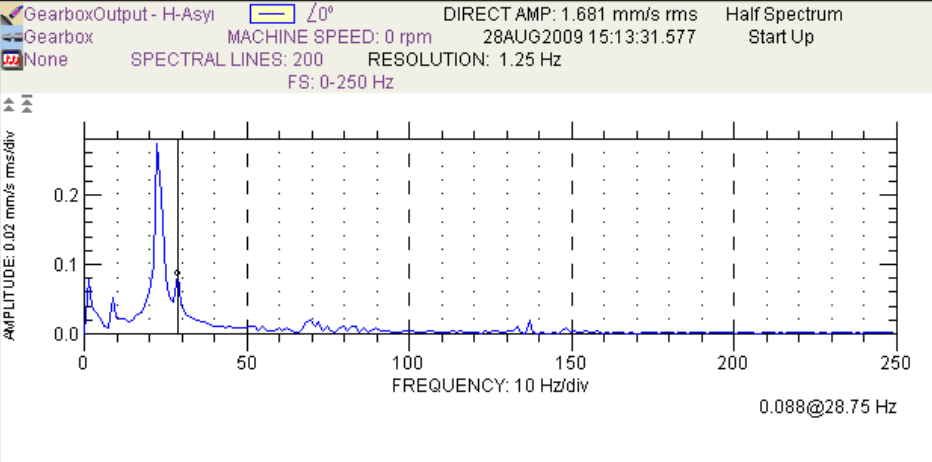

Pump-B

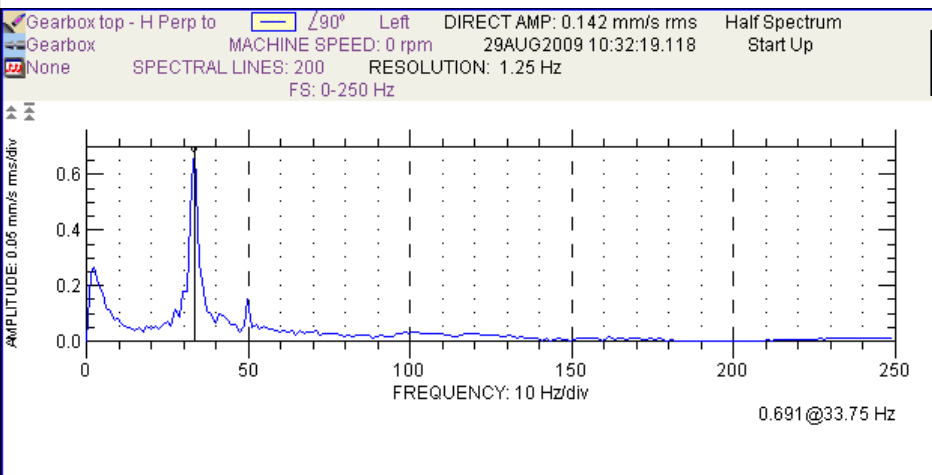

Pump-D

Observation: 3 Bump test data on the Gearbox structure indicated a resonance at 22.5Hz and 33 Hz, which is less than 20% separation margin (Pump Running speed 28.75Hz)



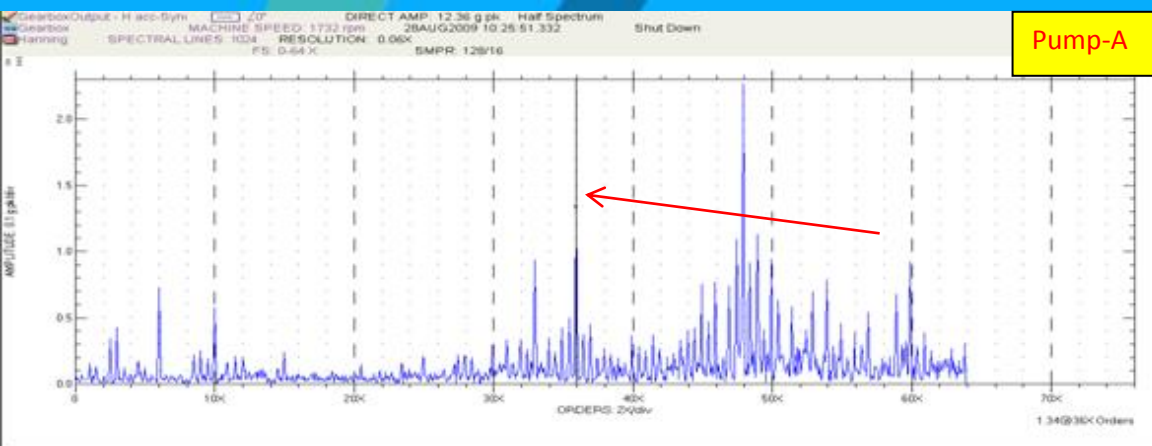

Pump-A

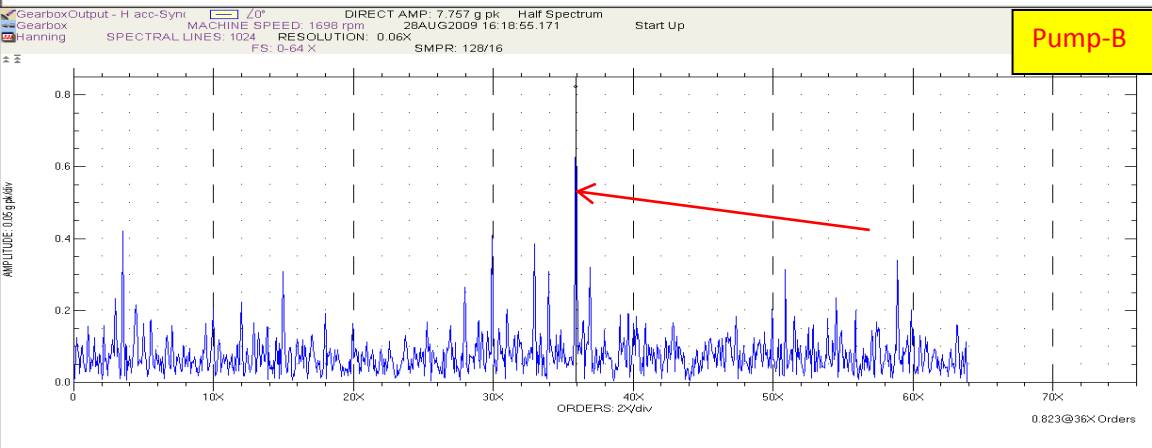

Pump-B

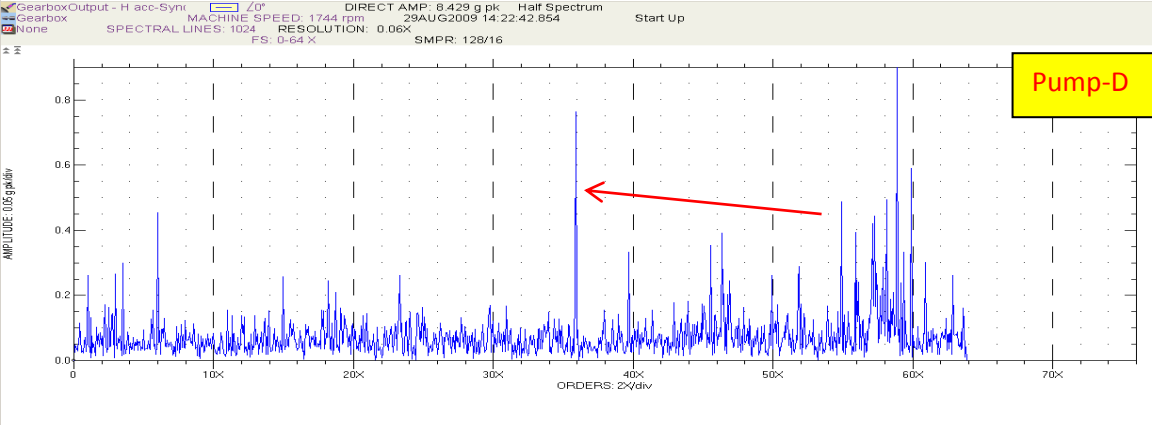

Pump-D

Observation:4 High frequency spectrum indicated 1X GMF with sidebands, indicated premature wear of gear teeth/excessive backlash.



Conclusions from Investigation

- Unbalance of Gearbox cordon shaft or coupling hub mounted at gearbox input shaft
- Transfer of vibrations from diesel engine to the gearbox and pump assembly
- Structural resonances from gearbox support assembly.
- Premature wear of gear teeth / excessive backlash.

Proposed Actions

- In situ balancing of gearbox cordon shaft and GB O/P shaft.
- Installation of vibration isolators below the engine feet or the base frame
- Modify the Gearbox structure to shift the natural frequency with 30% separation margin.
- Inspection of Gearbox for excessive gear wear/backlash.

Actions in Sequence

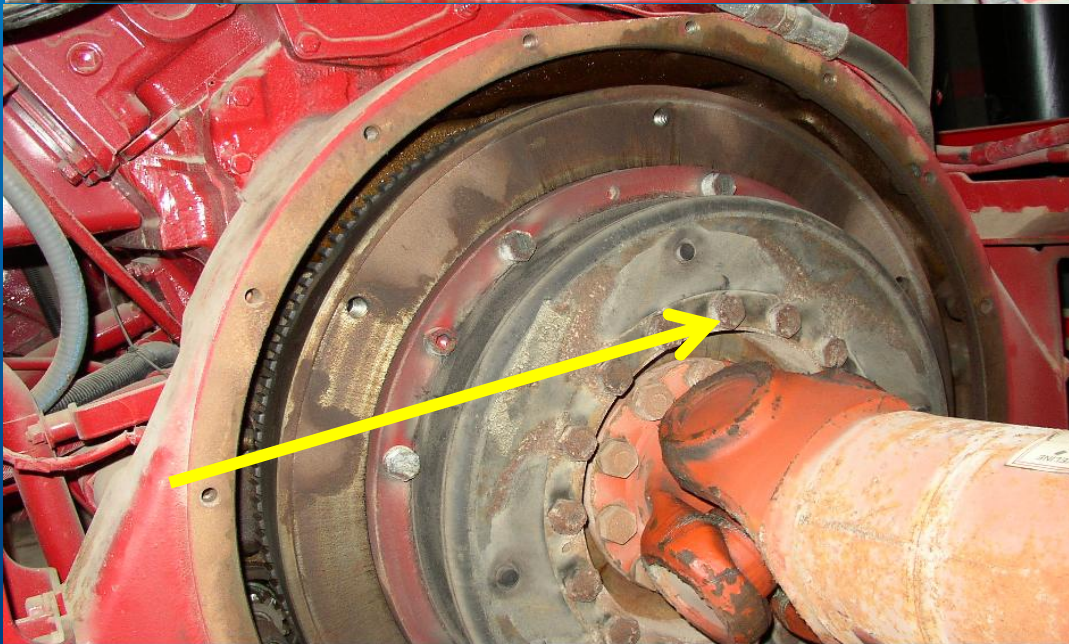
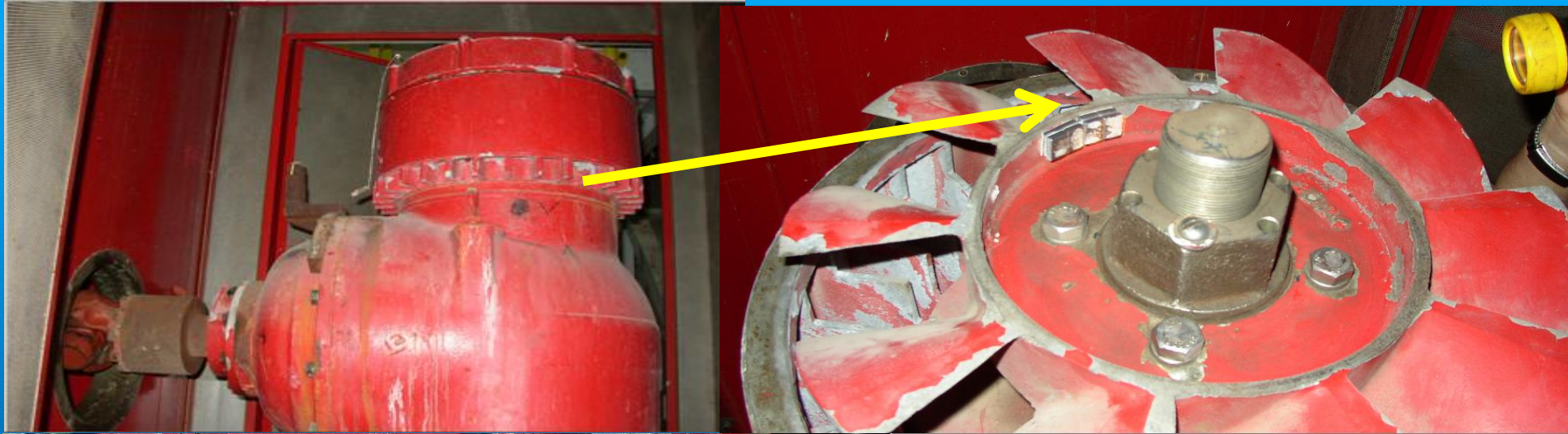

Action-1: Balancing attempted on GB I/P and GB O/P shaft to reduce unbalance on cordon shaft and to reduce excitation on the GB structure respectively. (coupling between Engine and GB used to balance the GB I/P shaft. GB fan at the top used to balance the GB O/P shaft).

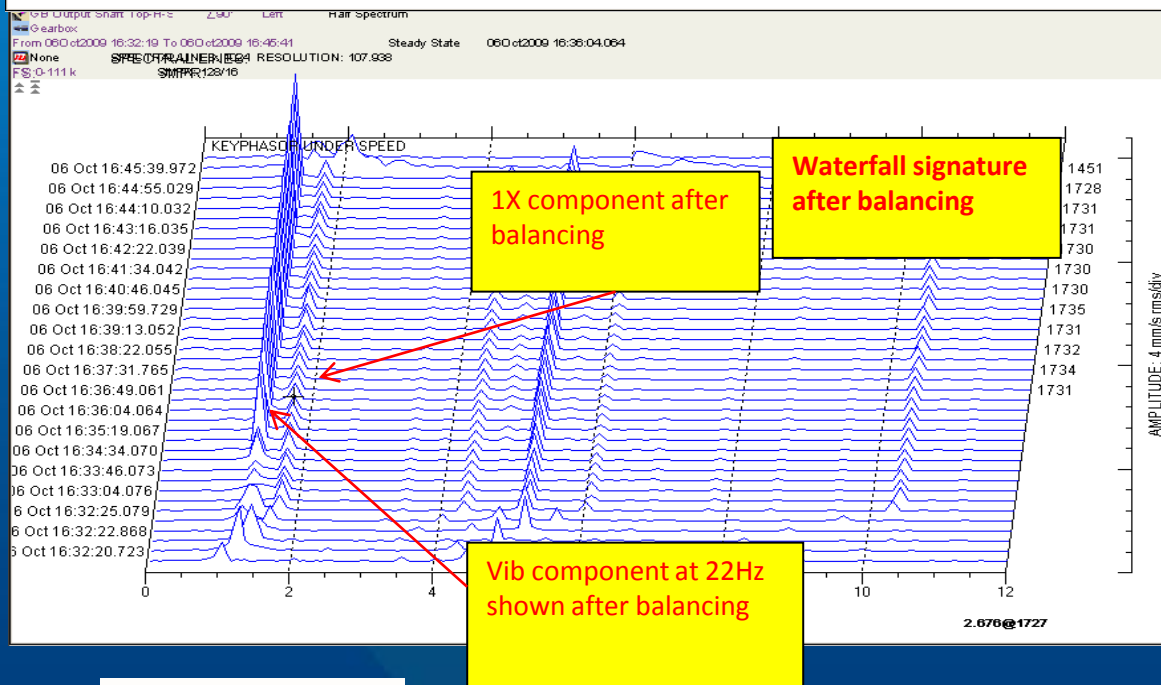
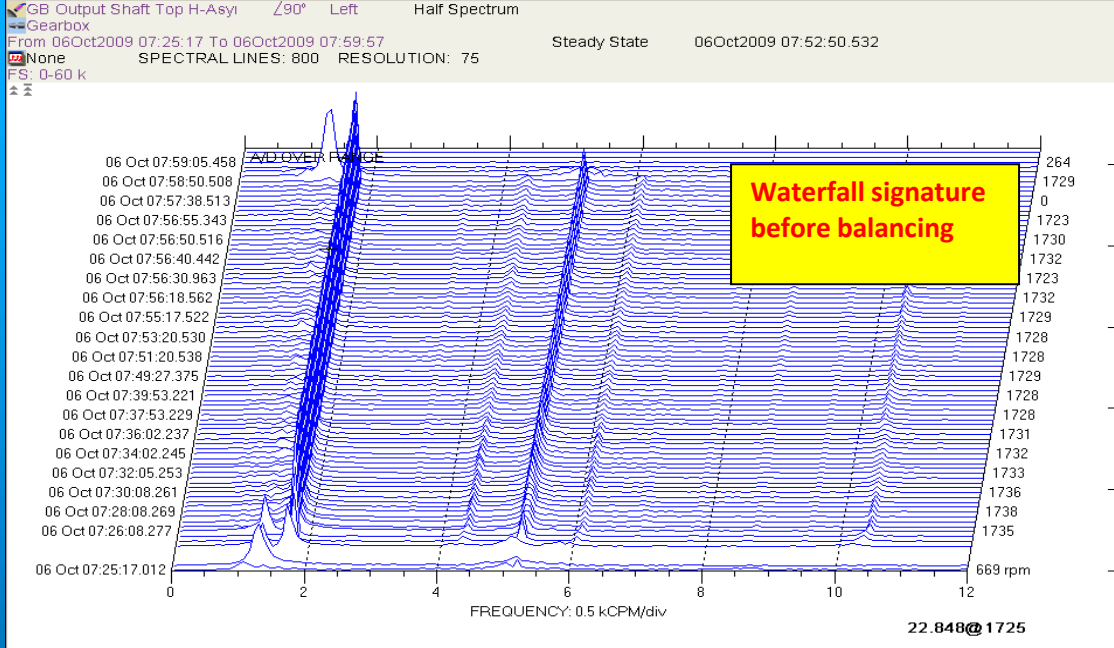

Action-1 (contd): In-situ balancing resulted in reduction of 1X. However the amplitude shifted to the frequency of 22 Hz (0.8X).

Action-2: The engine stand was replaced with a new stand with vibration isolators

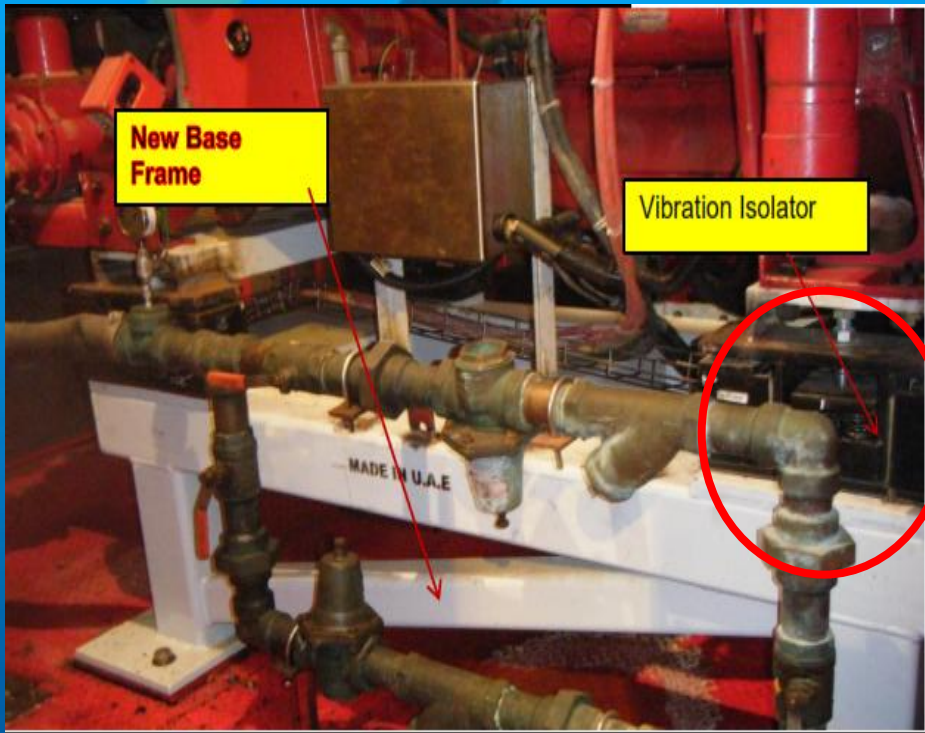

Comparison of vibration spectrum before and after the modification of engine base frame with vibration isolators

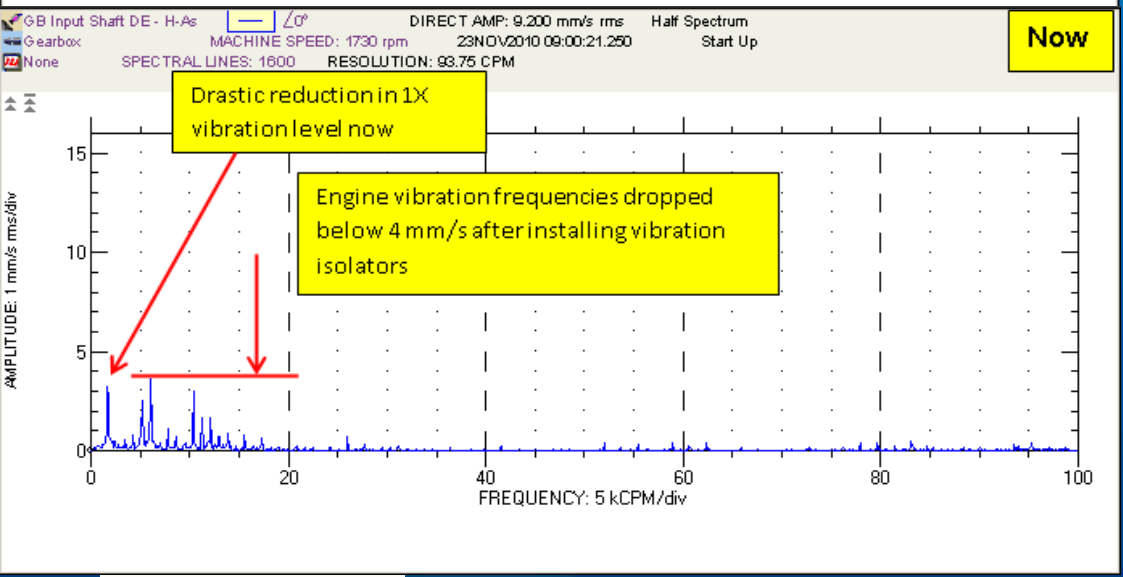
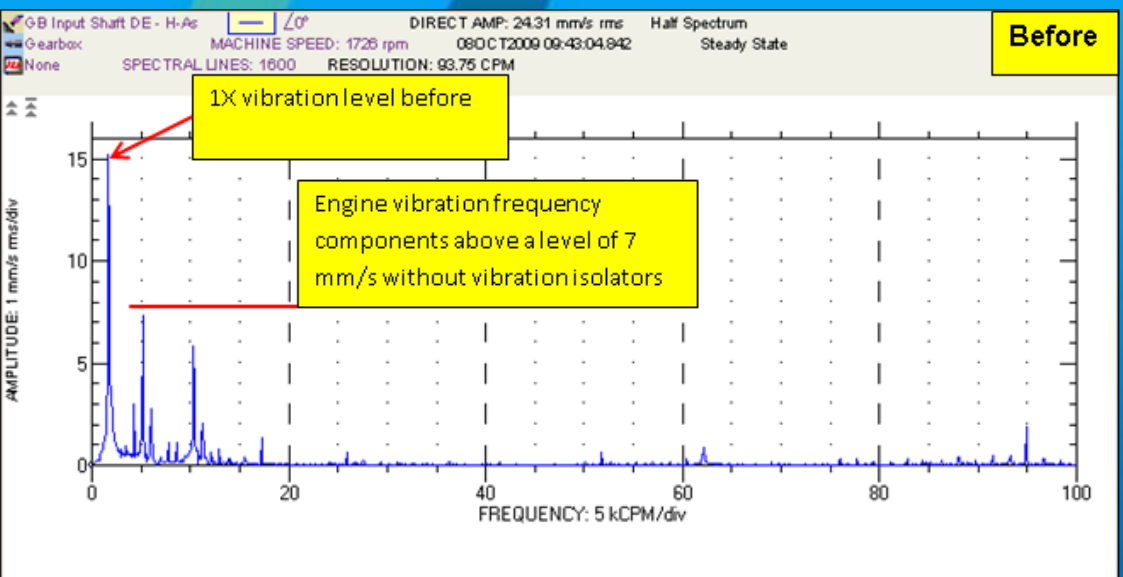

Action-3: Pump Head/Gearbox structure modified



Old Pump head

New Pump head

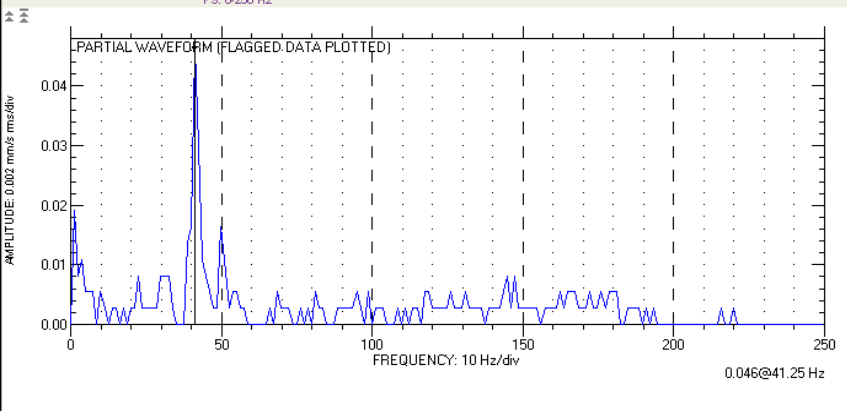
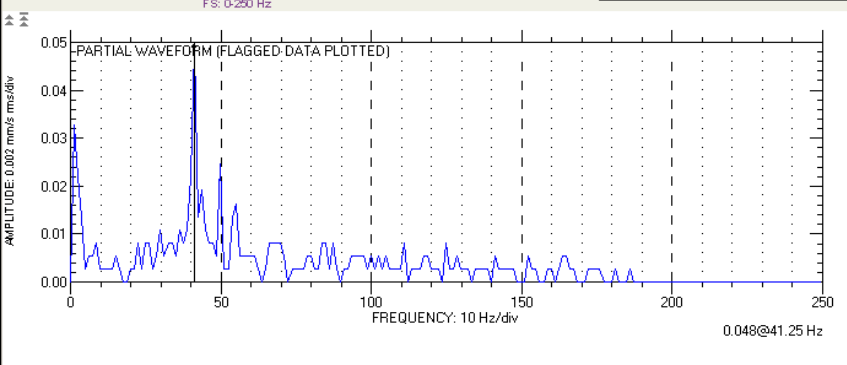
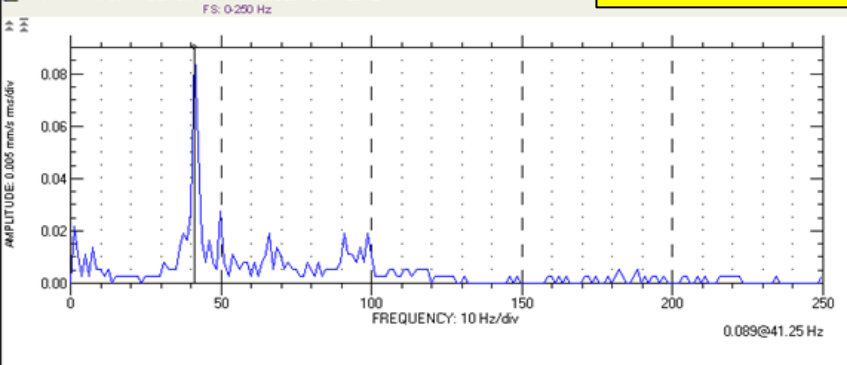

Bump test on the GB and pump head (with modified head) showed natural frequency at 41.25 Hz (achieved 41% separation margin)



Action-4: Gearbox inspected and found only 70% teeth contact. GB OEM brought to site, gear backlash was checked and adjusted to conform to OEM specifications

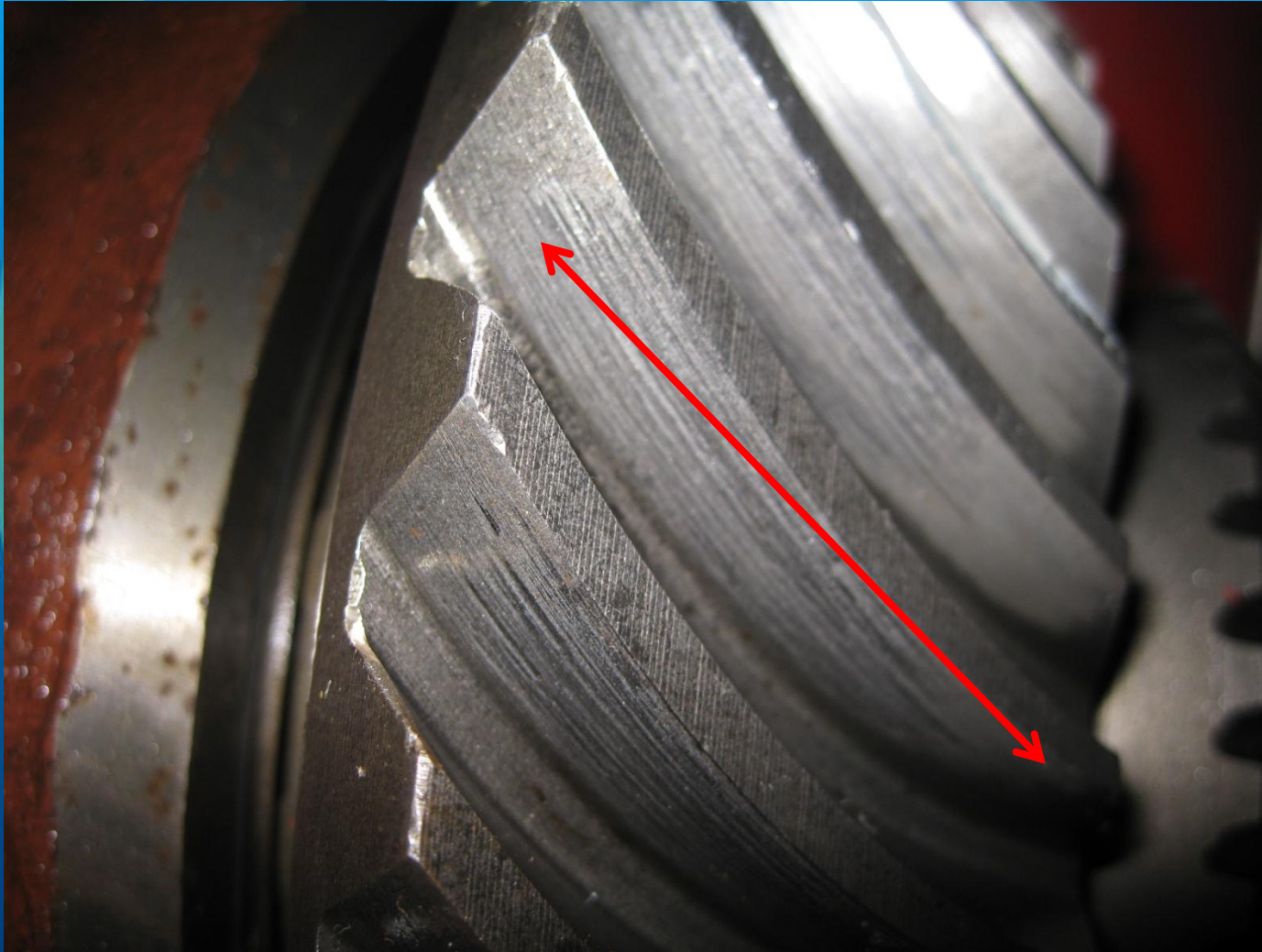

Comparison of vibration spectrum before and after the backlash adjustment on the Gearbox

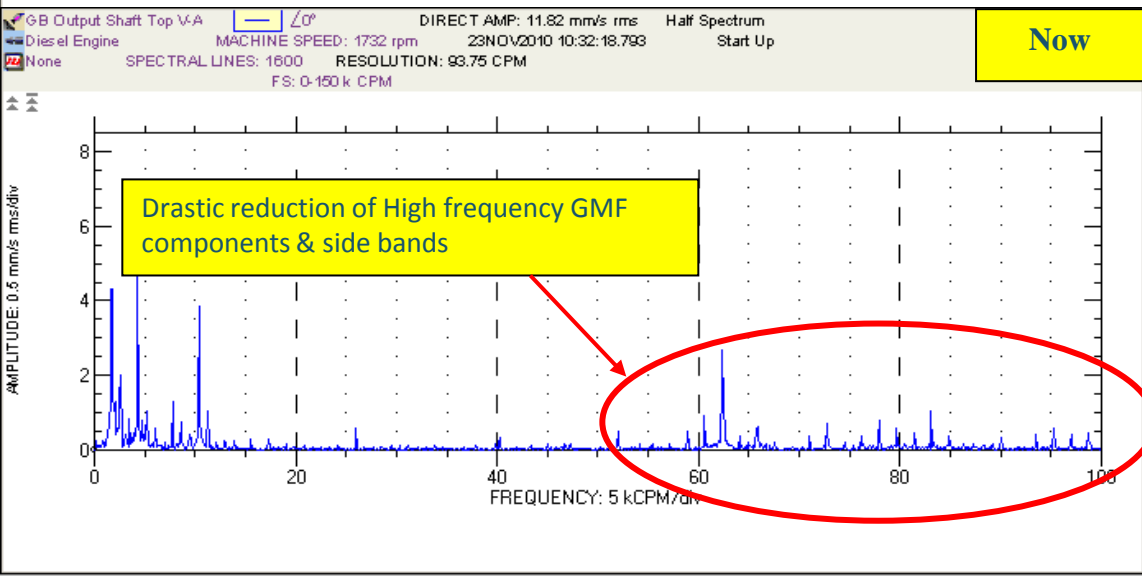
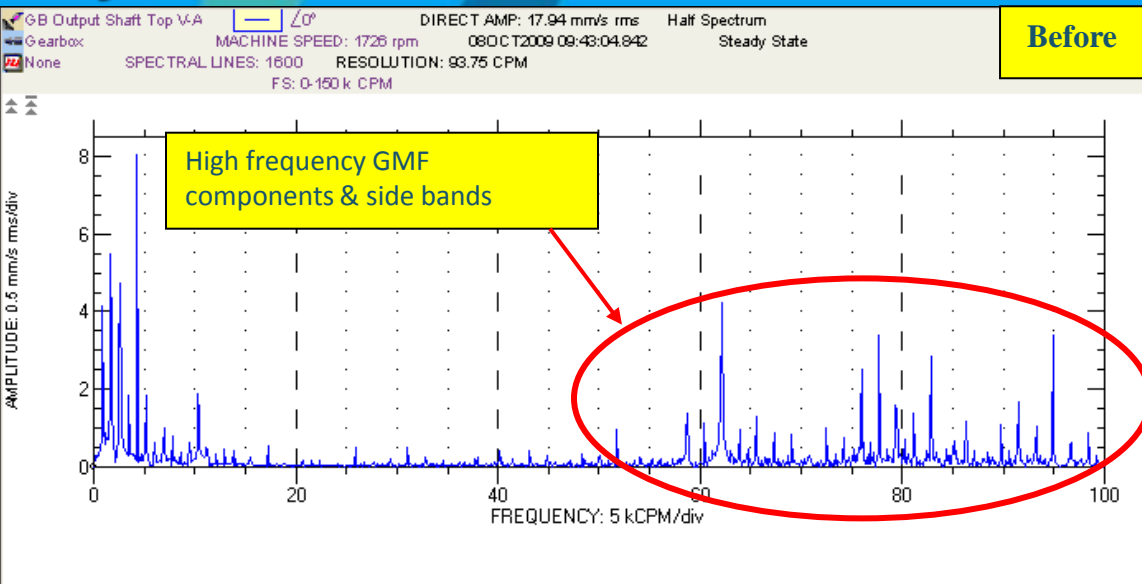

Final Vibration Results

Pump-D selected as pilot, implemented all the mentioned action items and resulted in great improvement. Red highlighted in table below is the contract specified location (Limit 5.84 mm/s rms)

| Location | Before the modification in Oct' 2009 | | After the modification in Nov' 2010 | |
|-----------------------------|---|------------------------------------|---|------------------------------------|
| | Vibration value - Overall in mm/s (rms) | Vibration value - 1X in mm/s (rms) | Vibration value - Overall in mm/s (rms) | Vibration value - 1X in mm/s (rms) |
| Engine DE-H | 14.2 | 2.6 | 11.5 | 1.8 |
| GB Input shaft DE H | 21.1 | 16.2 | 9.2 | 4.5 |
| GB Input shaft DE V | 8.8 | 3.6 | 7.0 | 2.0 |
| GB Input shaft DE A | 18.0 | 14.2 | 8.1 | 5.3 |
| GB Output Top Horizontal | 22.0 | 20.3 | 11.0 | 5.1 |
| GB Output Top Vertical | 19.0 | 13.3 | 12.1 | 6.7 |
| GB Output Bottom Horizontal | 12.5 | 9.3 | 4.7 | 2.2 |
| GB Output Bottom Vertical | 11.1 | 9.9 | 5.7 | 3.1 |
| GB Output Bottom Axial | 5.3 | 4.8 | 3.7 | 1.0 |
| Pump Horizontal | 6.3 | 6.5 | 3.6 | 1.3 |

Lessons Learned

- All contractual limits must be carefully acknowledged during design and verified during FAT.
- Solving the problems in factory is much easier than doing it on site.
- Get the right consultant involved at the first chance.
- Understand the size of problem since beginning could save time, cost and efforts.
- Major modifications might be a solution whenever the problem is complex.