

RESOURCE: ACTIVITY BOOKS

# ALPHABET LETTER BOOKS

ALPHABET KNOWLEDGE



1. Trace the mountains.

2. Trace the waves.

3. Write uppercase letter A.

lowercase letter a.

www.readingeggs.com

6. Color things that begin with a.

www.readingeggs.com

Reggie's  
Letter  
Aa  
Book

www.readingeggs.com



BROUGHT TO YOU BY THE **TEACH WITH READING EGGS** TEAM

www.readingeggs.com

# LEARNING TO READ WITH READING EGGS

Thank you for choosing this **Reading Eggs** packet. Research tells us handwriting is a complex skill to master. It involves cognitive, linguistic, perceptual, and motor components. Using this print and go packet, children will build essential handwriting and alphabet skills as they practice the letters of the alphabet and work through the fun activities. Though complex, we know that correct letter formation is crucial for young learners. Alphabet knowledge skills include being able to



- ✓ learn letter names (letter/name knowledge)
- ✓ hear the sound that matches the letter (letter/sound knowledge)
- ✓ write letters and words (letter/shape knowledge).

Alphabet knowledge is foundational for

- ✓ Beginning readers
- ✓ Struggling readers
- ✓ ELL

Using this packet, children will build essential handwriting and alphabet skills as they practice the letters of the alphabet. This packet contains 26 x letter books, one for each letter of the alphabet.

## WHY ALPHABET KNOWLEDGE ALONGSIDE LETTER FORMATION?

Alphabet knowledge is having an awareness of the names and sounds of the letters of the alphabet. It is a strong predictor of reading success and therefore a very important early literacy skill. Alphabet knowledge becomes crucial as children move into the early stages of reading and writing. By combining the two, you give children the opportunity to reinforce both skills.

The **Reading Eggs** team are passionate about helping children learn to read so we're always adding resources to help at home and in the classroom. To find more resources for phonological awareness and other key reading skills visit **Teach with Reading Eggs on Teachers Pay Teachers**.

*Katy Pike*

**Katy Pike and  
The Reading Eggs Team**

Happy  
Eggsploring!



[www.readingeggs.com](http://www.readingeggs.com)

I know how much you care about giving your child a great start in reading, because I had the EXACT same feeling, too. I remember life before Reading Eggs. Like you, I was determined to give my four kids the BEST start in life, and that meant helping them learn to read.

The problem was that reading is complicated. There are so many skills they need to learn. From phonological awareness, phonics, sight words, and vocabulary to comprehension and fluency; it's hard to know where to start. And most children need lots of time and a whole lot of repetition to get all these skills in place. If you're busy, this can get very challenging very quickly.

We knew there had to be an easier way. So I used my 25 years of experience in educational publishing, along with the most solid scientific research on reading instruction and child motivation, to create the online Reading Eggs program. This reading program completely transformed the way millions of children around the world learned to read. 10 MILLION children to be exact (and counting)!

Reading Eggs works because it's built on the five pillars for reading success. The program is used in thousands of schools because it's so effective. And kids love it. And you will too as you watch children make real progress in the most important skill they need for future academic success.

I hope you enjoy the reading journey,

Katy Pike



## WHERE CHILDREN BECOME GREAT READERS!

The online reading program for 2–13 year olds.

**Reading Eggs** is the multi-award winning reading program that has been used by over 10 million children worldwide. Children have fun learning **phonics and essential reading skills** with interactive games, activities, and e-books.

Over 91% of parents using **Reading Eggs** report a noticeable improvement within weeks.



Ages 2–4

### First Steps

Delight your toddler with fun games and activities that build alphabet knowledge and ready-to-read skills.



Ages 3–7

### Learning to Read

Children follow structured, one-on-one lessons that teach phonics, sight words, and reading skills.



Ages 7–13

### Building Confidence

Older children can continue building key literacy skills that will help them succeed.



[www.readingeggs.com](http://www.readingeggs.com)

# READING EGGS IN THE CLASSROOM

It's so easy to get started with **Reading Eggs**.

## 1 Placement test

Have your class take the Reading Eggs placement test. This will ensure each student begins at the appropriate level. Let the reading begin!



## 2 120 Reading lessons

Your students can be starting their personalized reading journey in minutes and with 120 lessons, games, songs, and hundreds of books, you know they will be on the right track to reading success.



## 3 Connect with parents and guardians

Send home letters to give students access from home. They should aim to complete three 15-minute sessions per week. Printable parent letters are



quick to set up, giving your students access to the program from home.

## 4 Allocate lessons and homework

Worksheets and teaching notes are available for every lesson, giving you the ability to allocate lessons and written homework.



## 5 Assess and review results

Keep track of progress with the easy-to-read reports in your teacher dashboard. See time on task, reading lessons, and quizzes completed, as well as the many, many books read by your students!



## SCIENTIFICALLY PROVEN TO WORK!

In an independent study conducted in 2017, students using **Reading Eggs** outperformed students that didn't use the program. Student engagement with the program was high because of the variety of lessons, fun activities, songs, and rewards.

Students using **Reading Eggs** for 60 minutes per week made significant improvements in their phonics skills, reading levels, and reading proficiency. In fact, 93% of students increased at least one reading level over the six weeks.

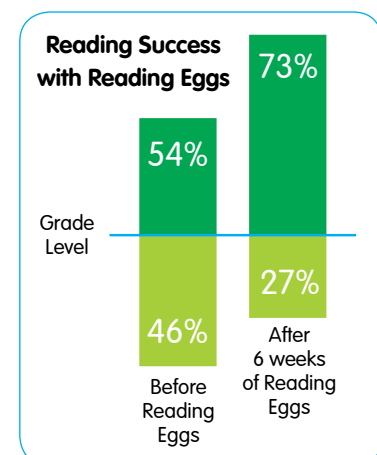

# HOW TO USE

## What's included?

- ✓ 26 × 2-page letter books

## Setting it up

- 1 Print pages double-sided and select to flip on the short edge.
- 2 Photocopy the required number for your class.
- 3 Students use the fold line to create a single double-sided letter book.

# TEACHING IDEAS

- 1 Write the letters of the alphabet around the rim of a paper plate. Write the letters of the alphabet on 26 clothes pegs. Ask children to match them up.



- 2 Choose five letters and write each on a large sheet of poster paper. Put the letters out in the playground in five different spots. Review each letter. Then put on some music. When the music stops, shout out a letter and the children need to move to that letter.

- 3 Use string and alphabet beads to make letter necklaces. The threading action is excellent for hand-to-eye coordination and fine-motor skills.

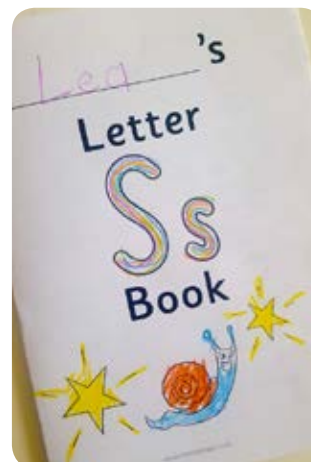

- 4 Children can practice each letter by writing the letter on the cover page with pencils of every color of the rainbow.

- 5 Cut butchers paper or poster paper into strips. Write the lowercase letters of the alphabet along the strip. Write the uppercase letters on post-it notes. Students can match and stick uppercase letters to the lowercase letters.



# RESOURCE LISTING

Letter	Page
Aa	7
Bb	9
Cc	11
Dd	13
Ee	15
Ff	17
Gg	19
Hh	21
Ii	23
Jj	25
Kk	27
Ll	29
Mm	31
Nn	33
Oo	35
Pp	37
Qq	39
Rr	41
Ss	43
Tt	45
Uu	47
Vv	49
Ww	51
Xx	53
Yy	55
Zz	57

6. Color things that begin with *a*.

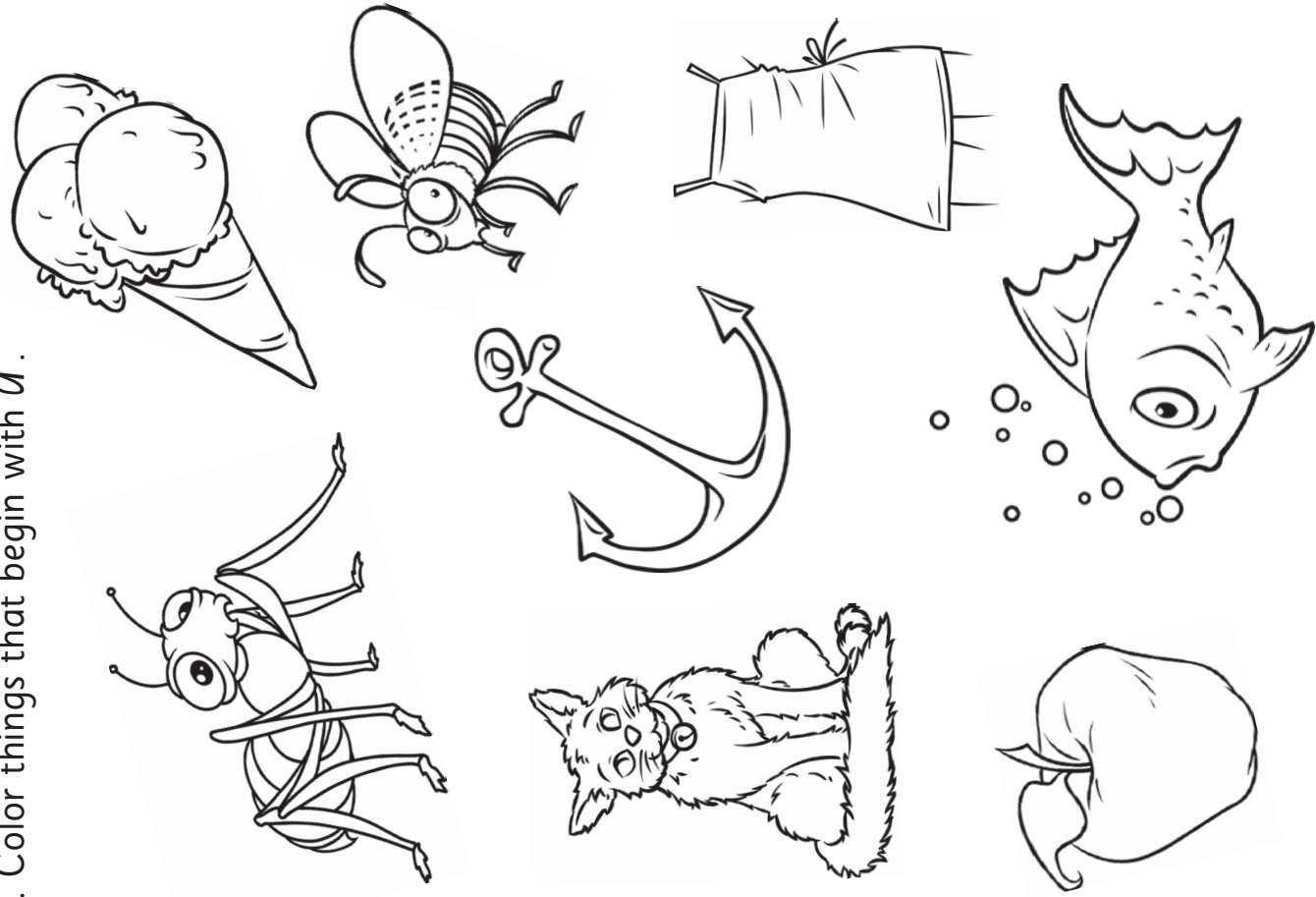

's

# Letter Aa Book

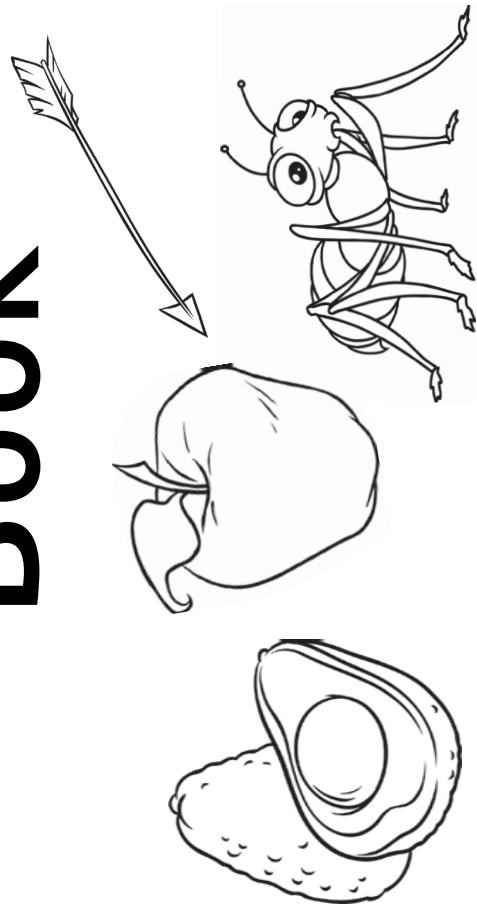

1. Trace the mountains.

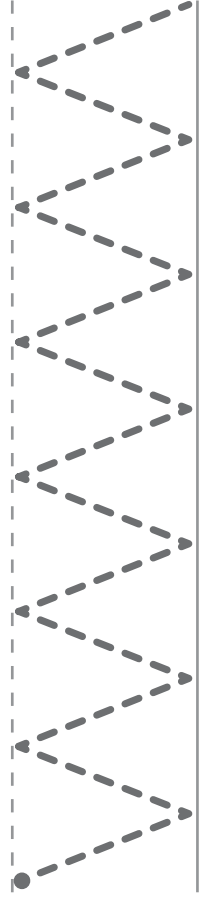

2. Trace the waves.

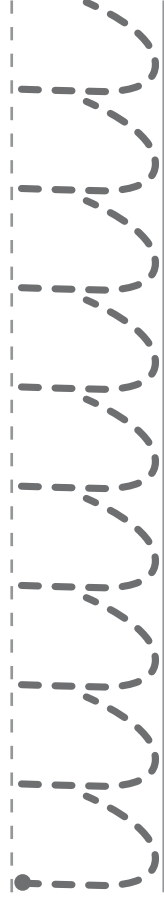

3. Write uppercase letter A.

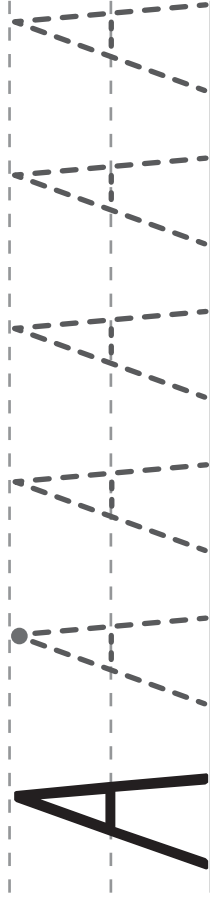

4. Write lowercase letter a.



5. Color uppercase letter *A* and lowercase letter *a*.

<i>a</i>	U	X	A	m
<i>ke</i>	p	<i>e</i>	h	+
A	<i>b</i>	r	<i>a</i>	A
<i>a</i>	U	s	<i>e</i>	l
<i>d</i>	s	<i>p</i>	<i>a</i>	n
<i>a</i>	f	z	A	<i>a</i>



6. Color the balloons that begin with *b*.

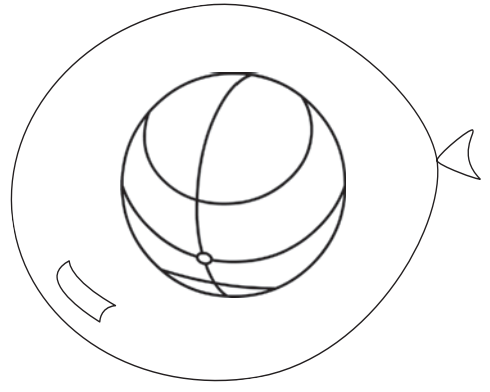
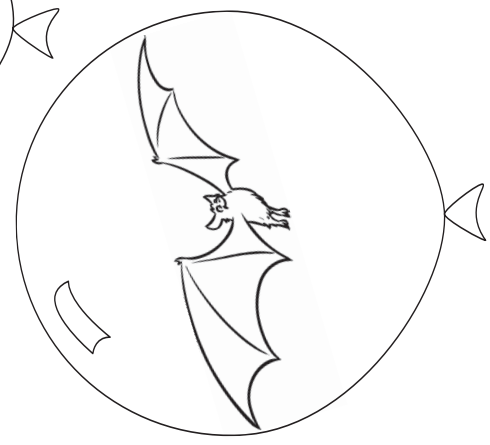
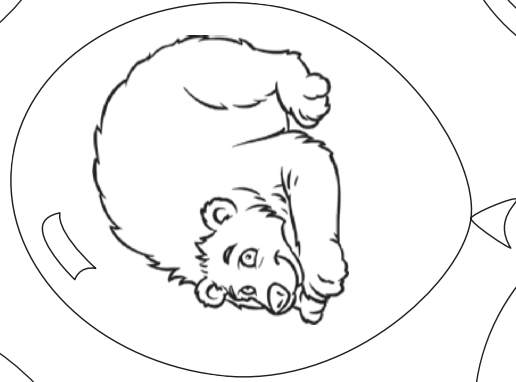
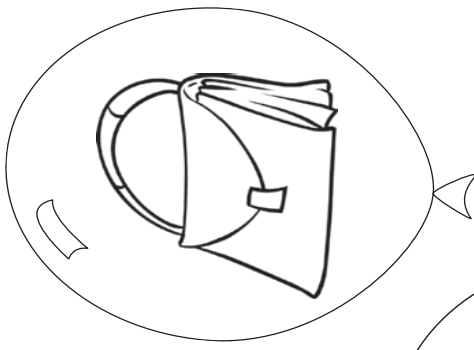
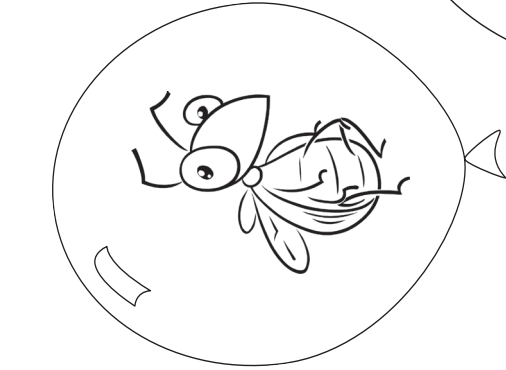

\_\_\_\_\_ ,s

Letter

Bb

Book

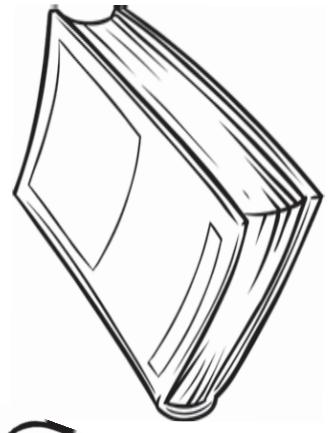

1. Trace the loops.

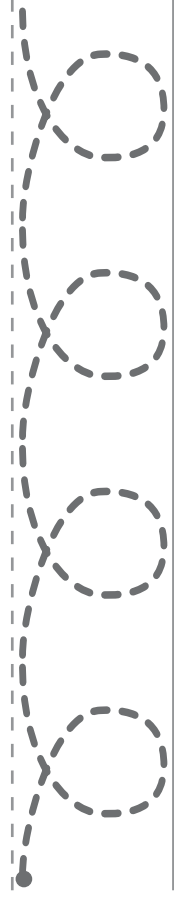

2. Trace the lines.

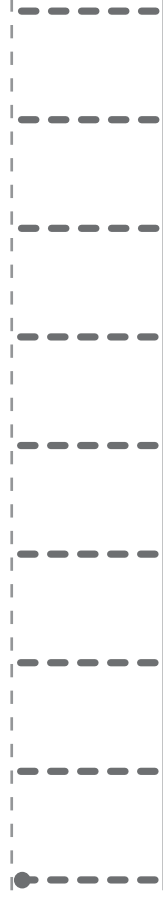

3. Write uppercase letter *B*.

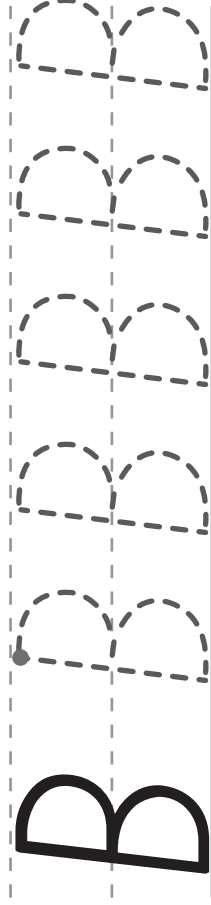

4. Write lowercase letter *b*.

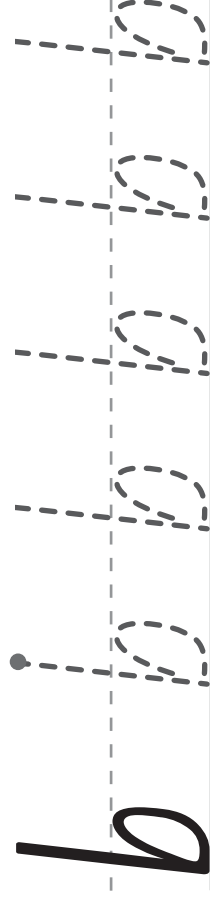

5. Color uppercase letter *B* and lowercase letter *b*.

<i>b</i>	<i>S</i>	<i>f</i>	<i>n</i>	<i>d</i>
<i>x</i>	<i>e</i>	<i>l</i>	<i>k</i>	<i>w</i>
<i>B</i>	<i>b</i>	<i>r</i>	<i>b</i>	<i>B</i>
<i>b</i>	<i>P</i>	<i>u</i>	<i>i</i>	<i>o</i>
<i>v</i>	<i>c</i>	<i>ρ</i>	<i>b</i>	<i>q</i>
<i>b</i>	<i>Y</i>	<i>f</i>	<i>B</i>	<i>b</i>

6. Color things that begin with C.

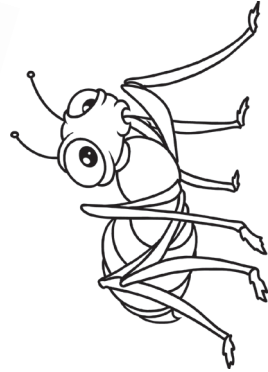
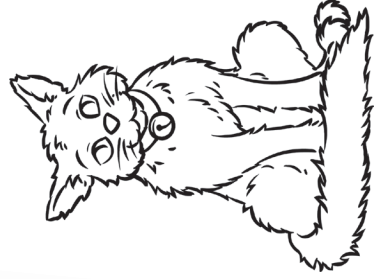
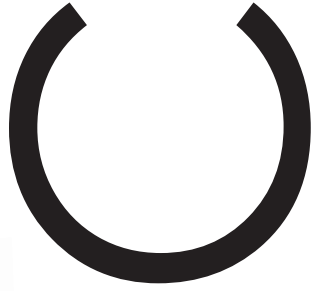

'S

Letter

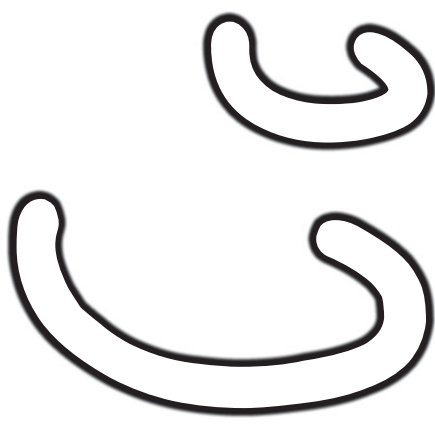

Book

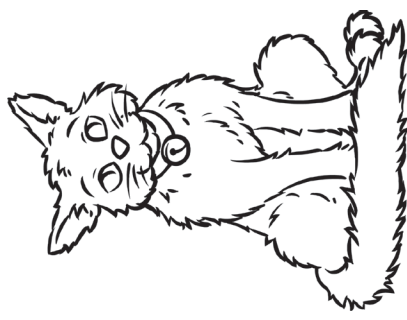

1. Trace.

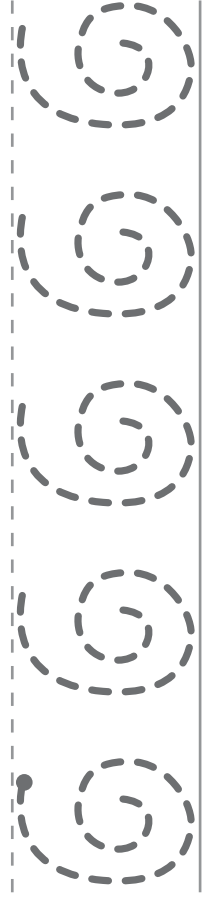

2. Follow the waves.

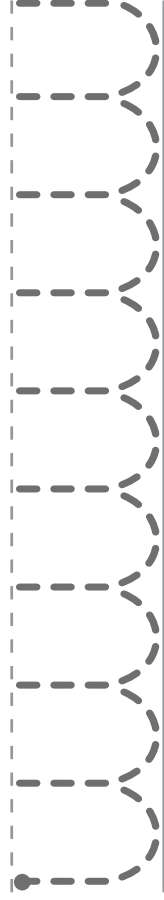

3. Write uppercase letter C.

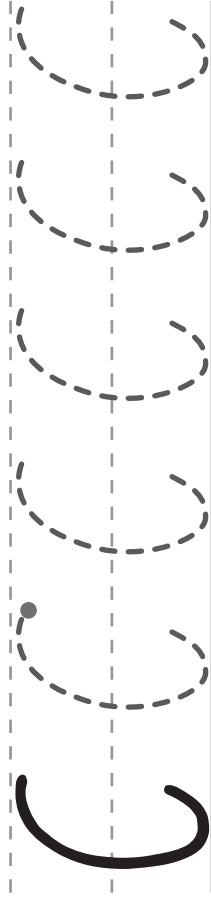

4. Write lowercase letter c.



5. Color uppercase letter C and lowercase letter c.

c	l	j	c	k
d	h	g	f	a
C	e	e	c	C
c	w	r	t	u
y	i	p	e	o
c	x	n	C	c

6. Add *d*. Say the word.

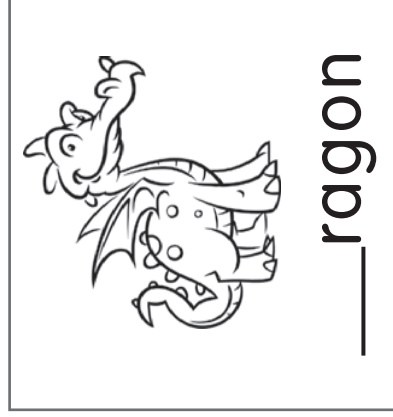
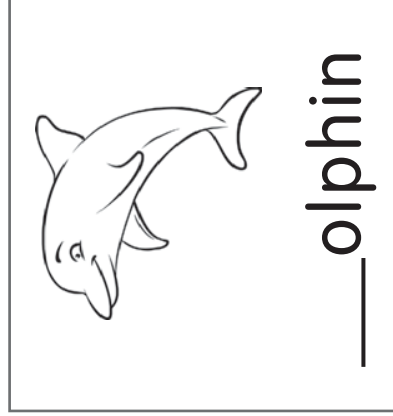
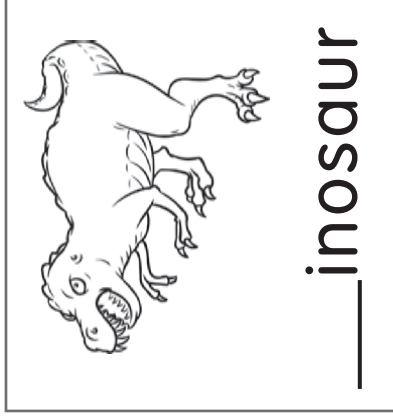
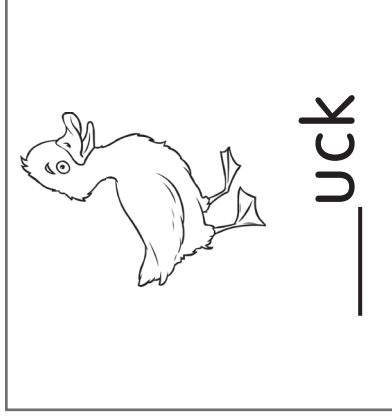
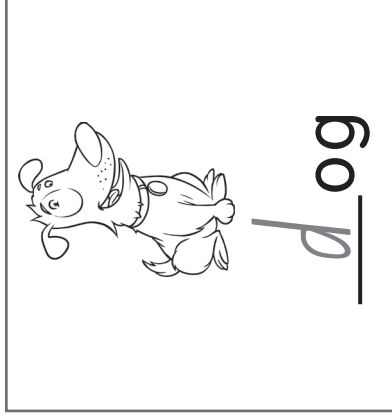

's

# Letter D d Book

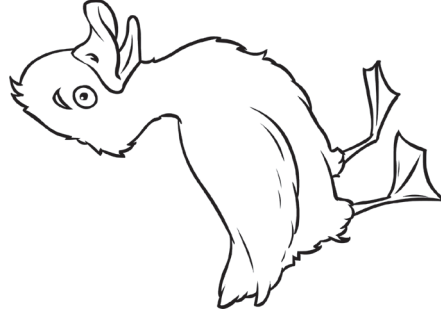

1. Trace.

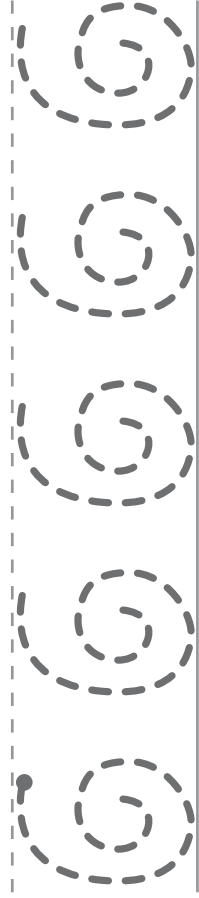

2. Follow the lines.

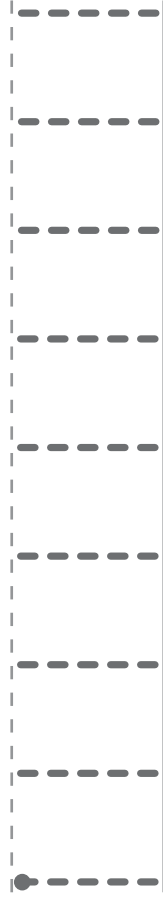

3. Write uppercase letter *D*.

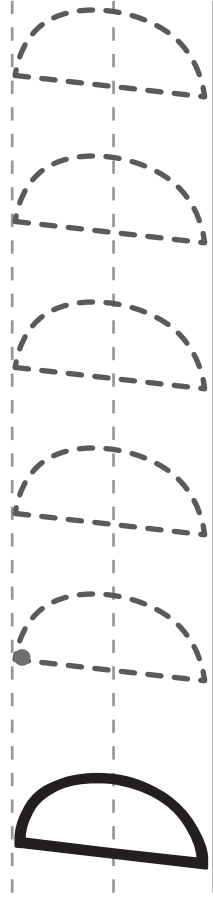

4. Write lowercase letter *d*.

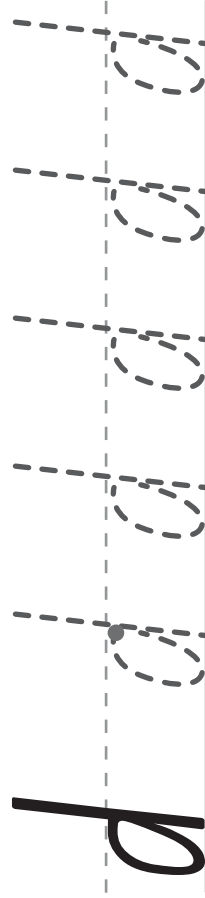

5. Color uppercase letter *D* and lowercase letter *d*.

<i>d</i>	S	r	f	m
<i>g</i>	h	e	k	l
<b>D</b>	v	b	d	<b>D</b>
<i>d</i>	n	p	o	m
<i>d</i>	z	c	d	h
<i>d</i>	Y	x	<b>D</b>	<i>d</i>

6. Color things that begin with *l*.

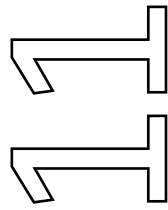
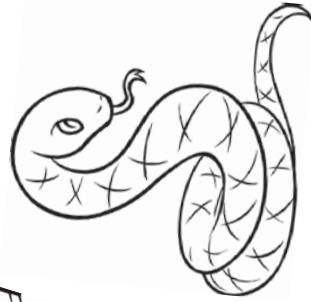
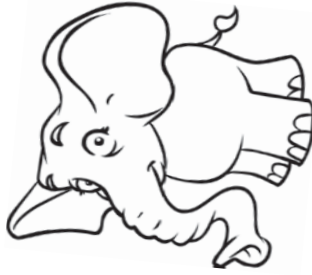
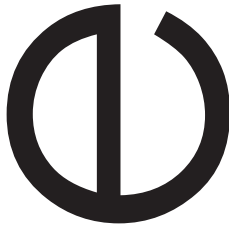
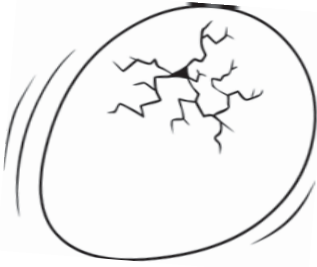

,s

Letter

l e

Book

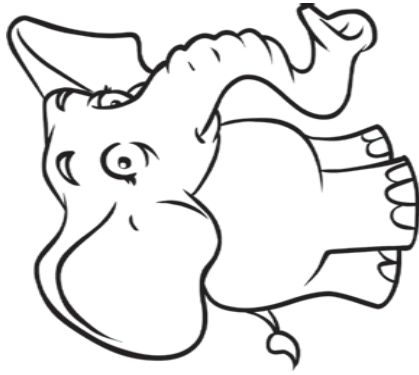

1. Trace.

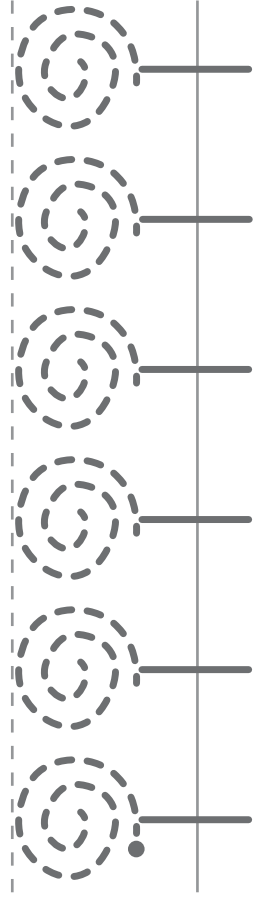

2. Trace.

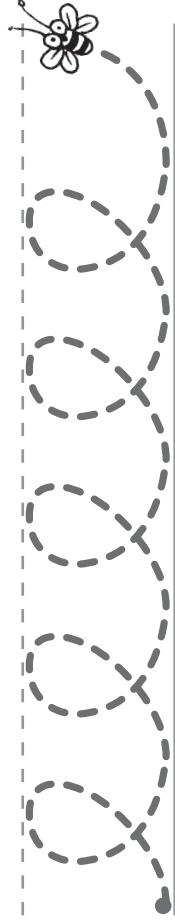

3. Write uppercase letter E .

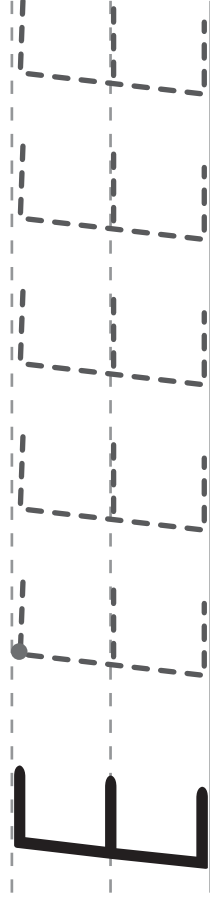

4. Write lowercase letter e .



5. Color uppercase letter E and lowercase letter e .

e	S	r	f	m
g	h	e	k	l
E	v	b	e	E
e	n	p	o	m
e	z	c	e	h
e	Y	x	E	e



6. Add *f*. Say the word.

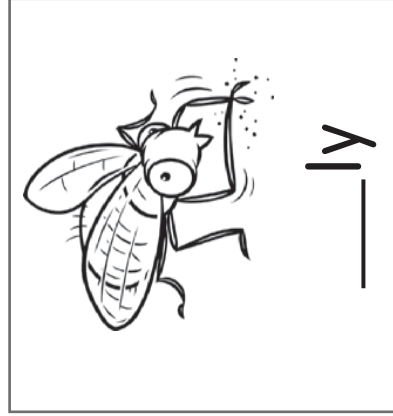
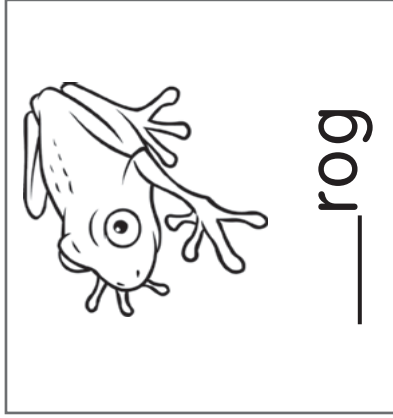
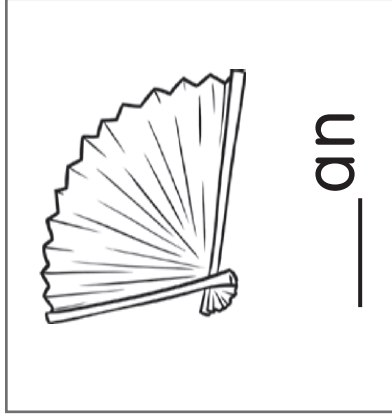
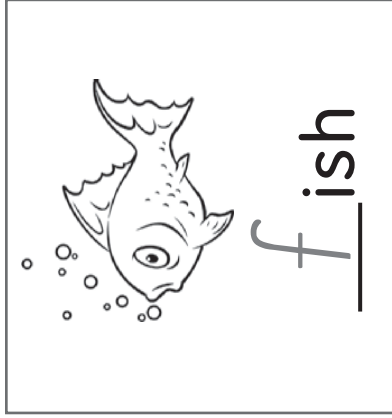

's

Letter

Ff

Book

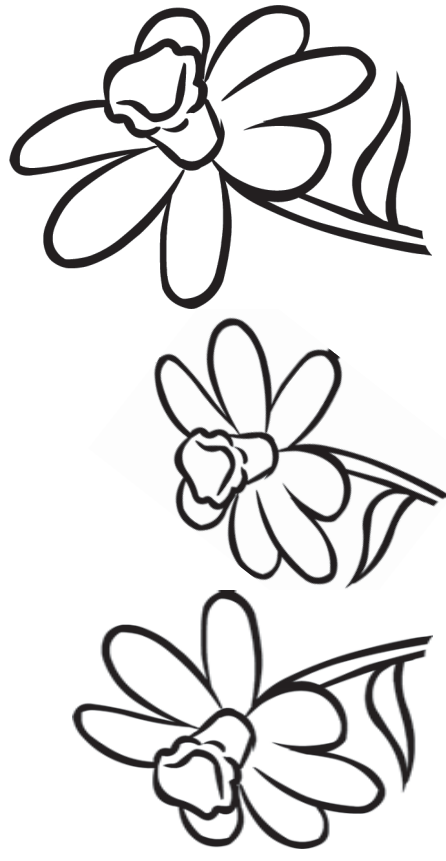

1. Trace.

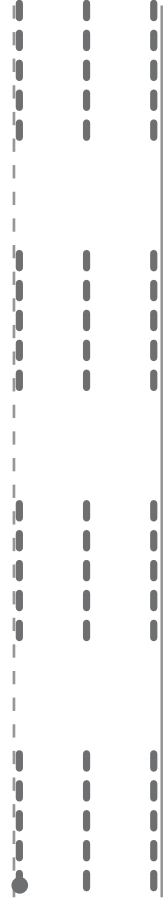

2. Follow the line.

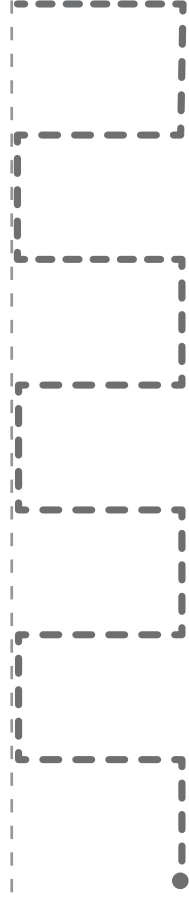

3. Write uppercase letter F.

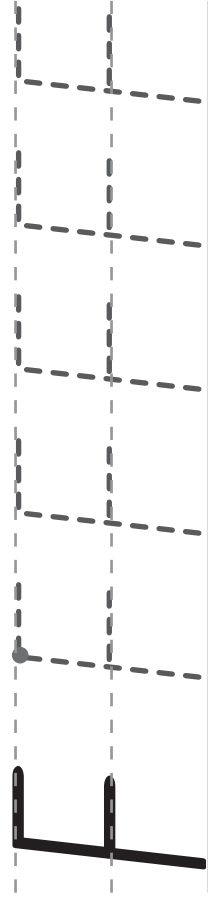

4. Write lowercase letter f.

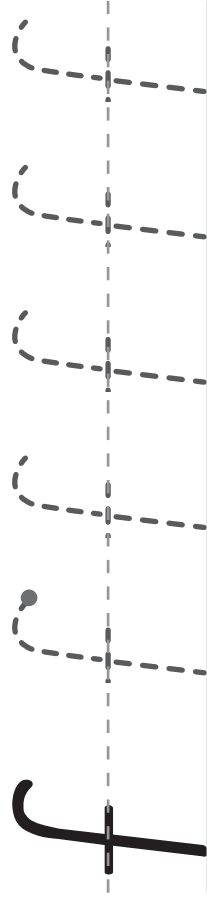

5. Color uppercase letter **F** and lowercase letter **f**.

d	f	r	f	m
g	h	n	k	l
F	v	b	f	F
f	a	p	o	m
f	z	c	f	h
o	Y	x	F	f

6. Add *g*. Say the word.

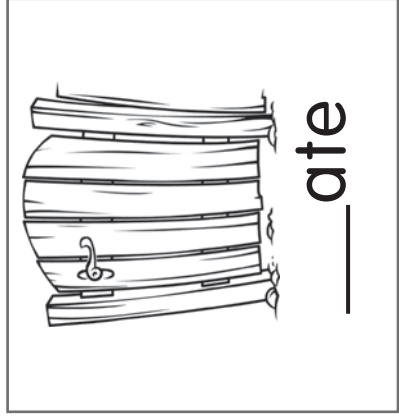
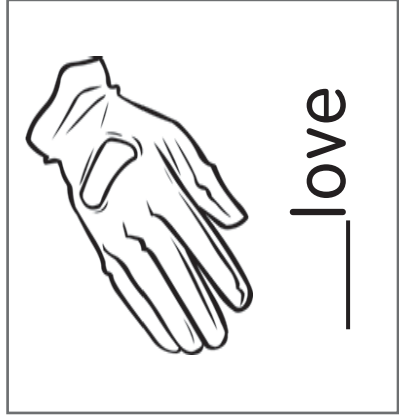
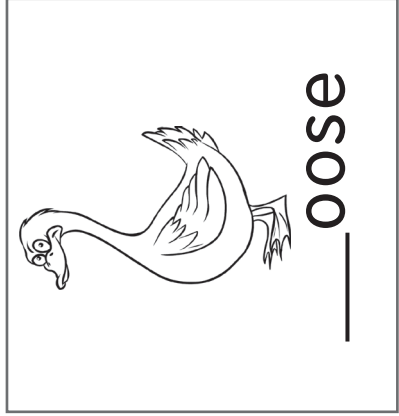
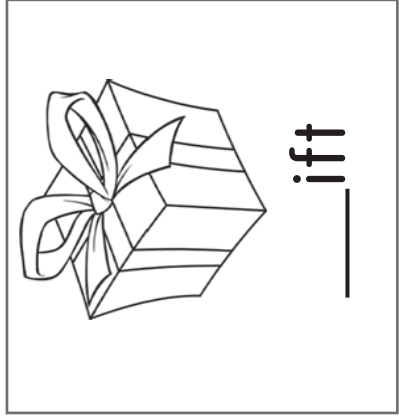
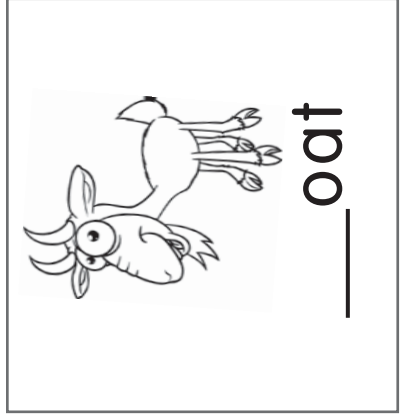

,s

Letter

Gg

Book



1. Follow the loops.

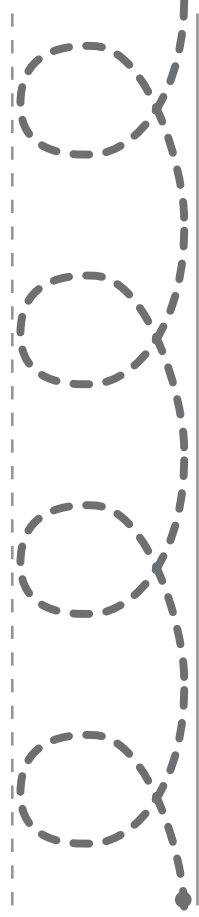

2. Trace the waves.

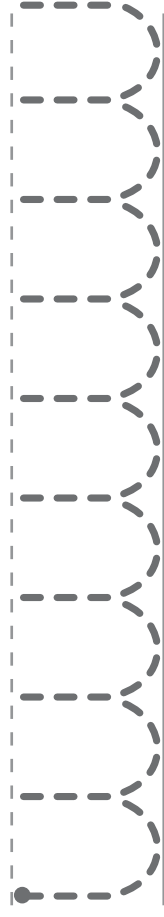

3. Write uppercase letter G.

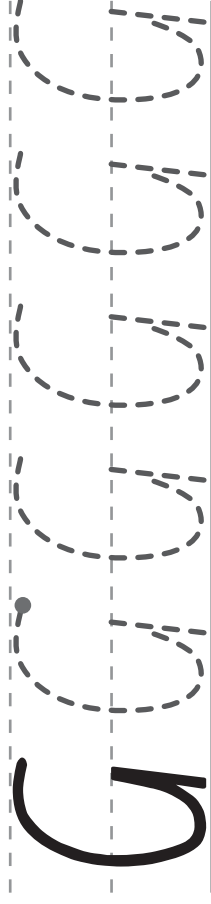

4. Write lowercase letter g.

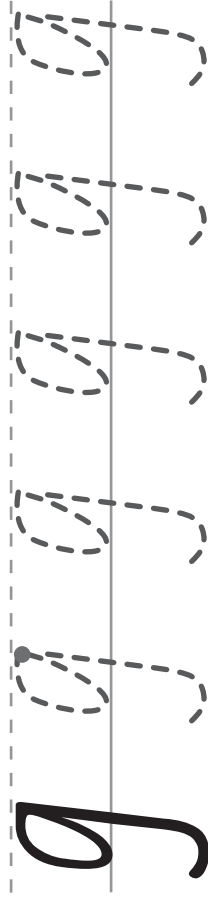

5. Color uppercase letter G and lowercase letter g.

S	g	r	g	g
m	h	g	k	l
G	v	b	i	G
r	n	g	o	m
g	z	c	g	h
y	g	x	p	s

6. Color things that begin with *h*.

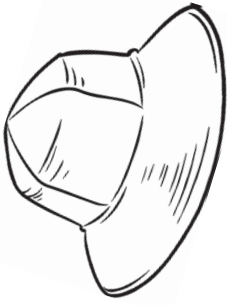
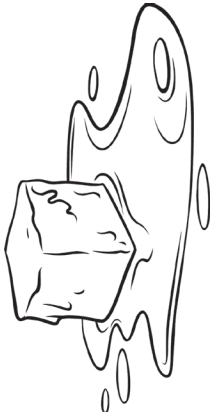

**h**

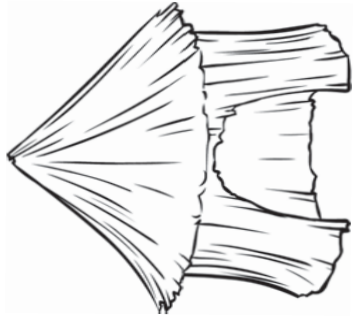
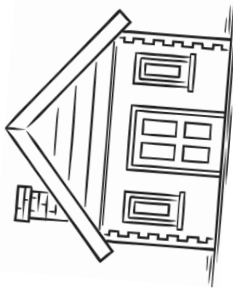
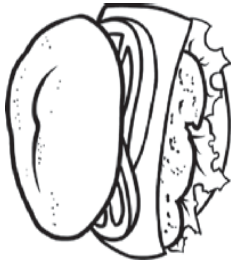

# Letter Hh Book



1. Follow the line.

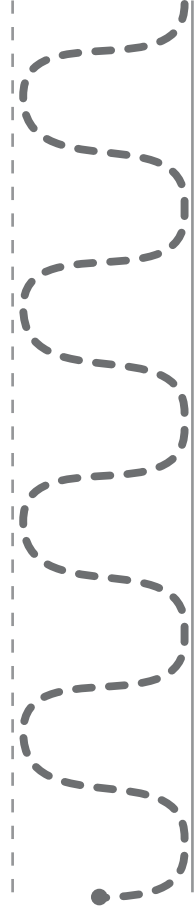

2. Trace.

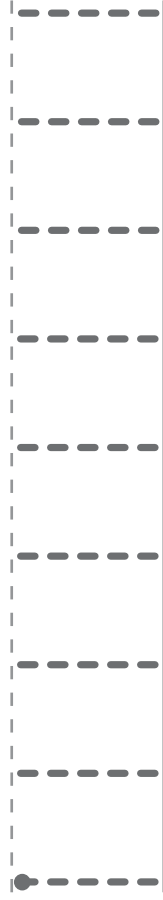

3. Write uppercase letter H.

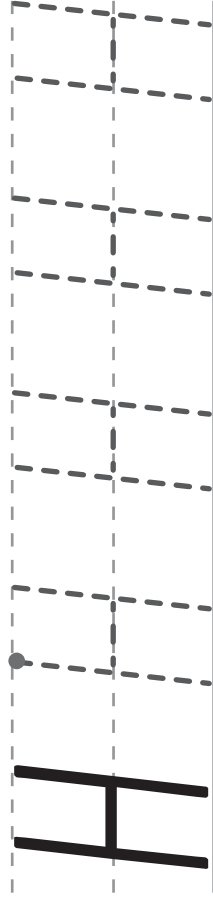

4. Write lowercase letter h.

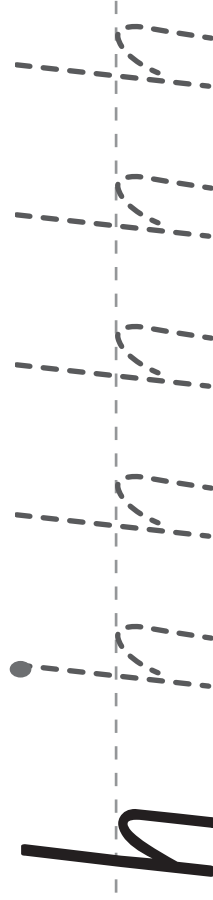

5. Color uppercase letter *H* and lowercase letter *h*.

d	s	r	f	h
g	a	y	m	l
e	v	b	h	k
k	n	p	o	m
H	z	c	h	H
h	k	x	H	w

6. Color things that begin with *i*.

's

# Letter *i* Book

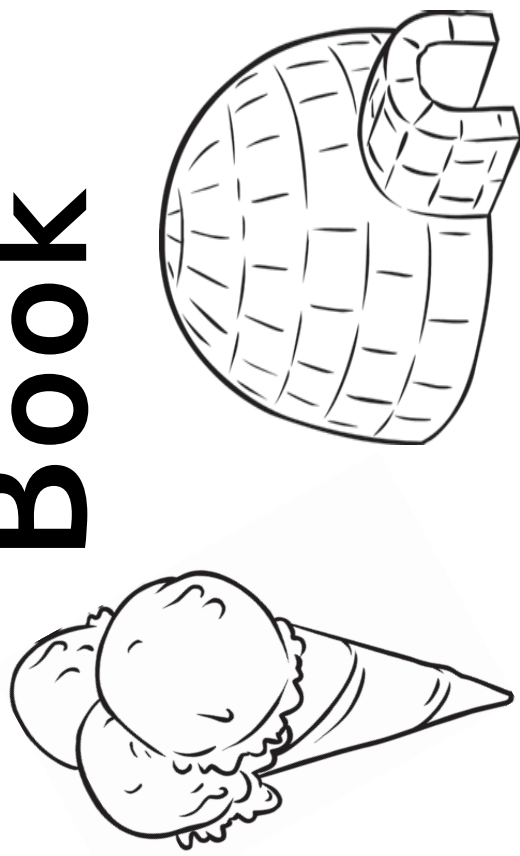
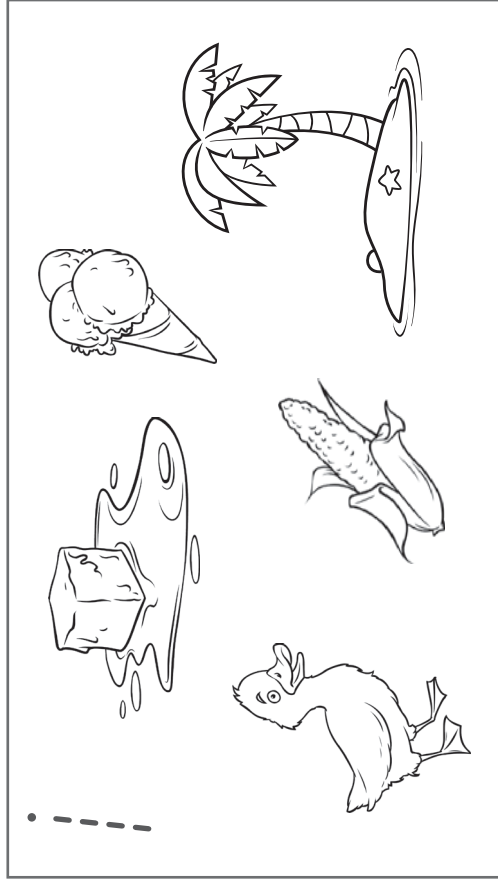
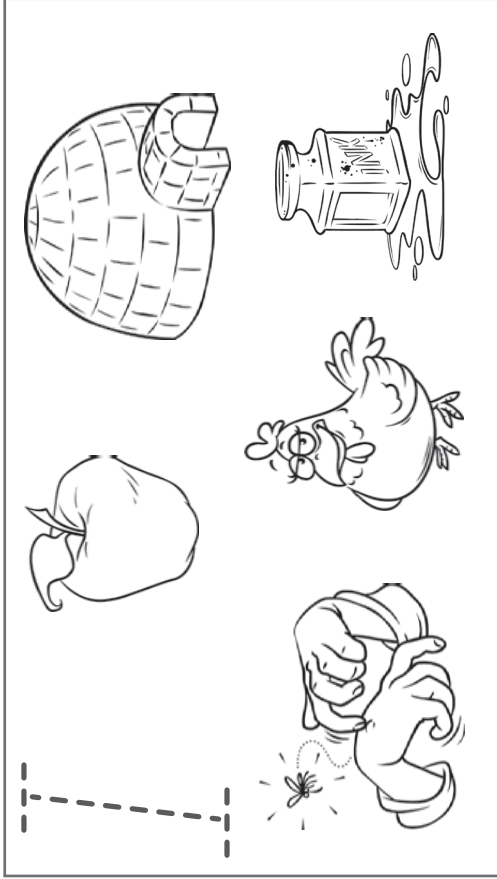

1. Trace.

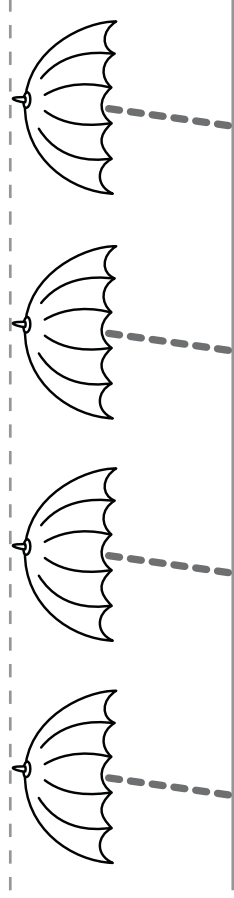

2. Trace.

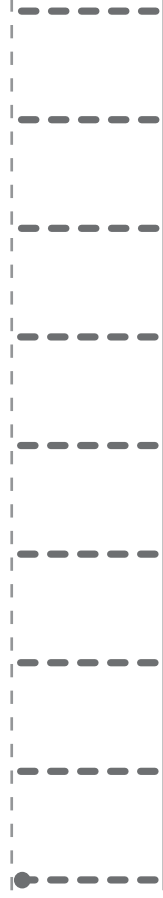

3. Write uppercase letter **I**.

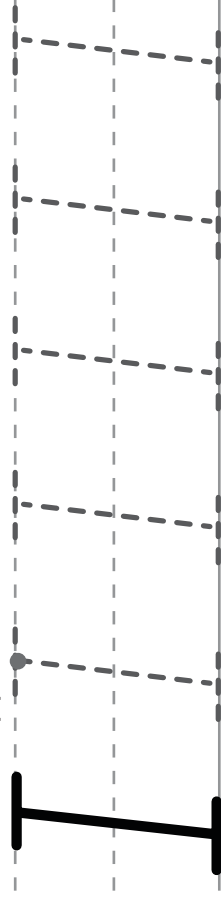

4. Write lowercase letter **i**.

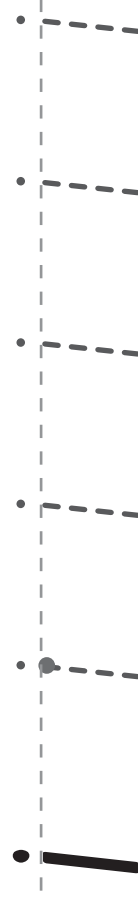

5. Color uppercase letter **I** and lowercase letter **i**.

<b>P</b>	<b>i</b>	<b>r</b>	<b>m</b>	<b>i</b>
<b>g</b>	<b>h</b>	<b>i</b>	<b>k</b>	<b>e</b>
<b>I</b>	<b>v</b>	<b>b</b>	<b>i</b>	<b>I</b>
<b>h</b>	<b>n</b>	<b>i</b>	<b>o</b>	<b>i</b>
<b>i</b>	<b>z</b>	<b>c</b>	<b>s</b>	<b>i</b>
<b>i</b>	<b>y</b>	<b>x</b>	<b>I</b>	<b>m</b>



6. Add j. Say the word.

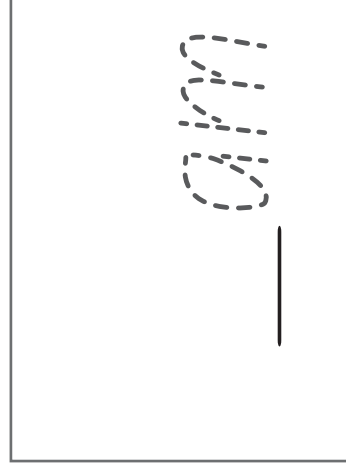
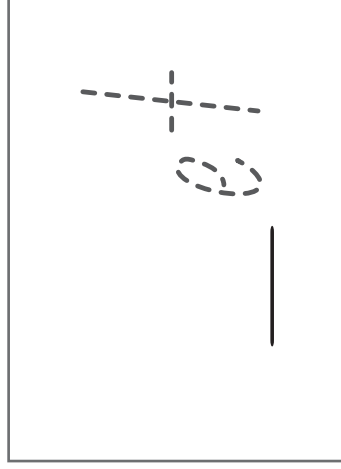
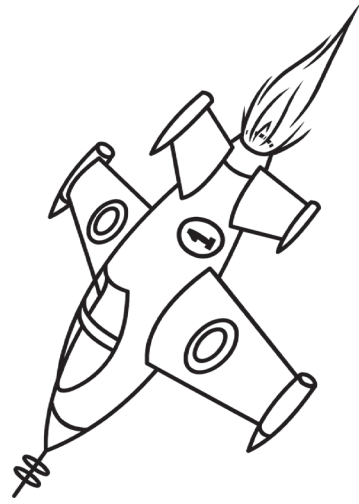
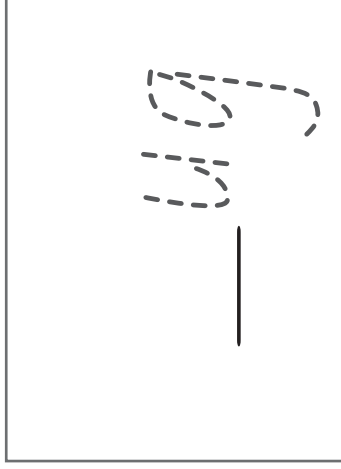

's

Letter

Jj

Book

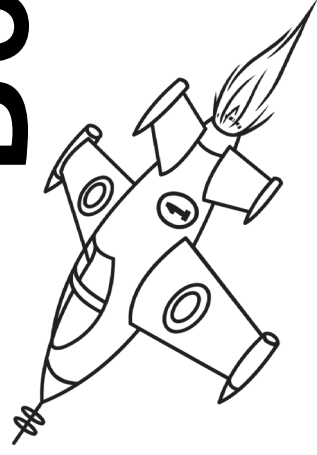

1. Trace.

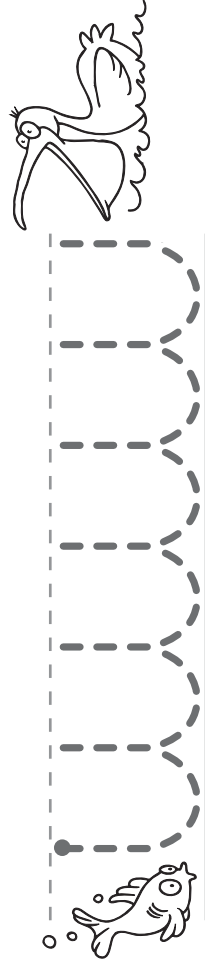

2. Trace.

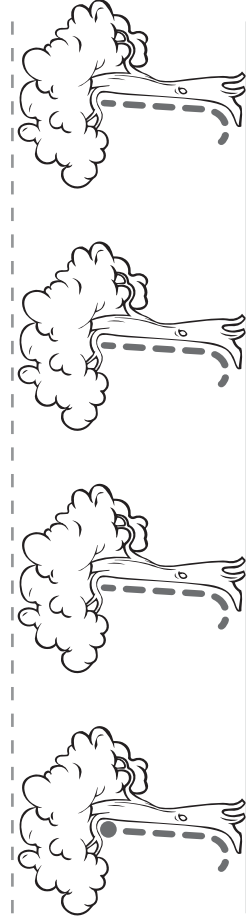

3. Write uppercase letter J.

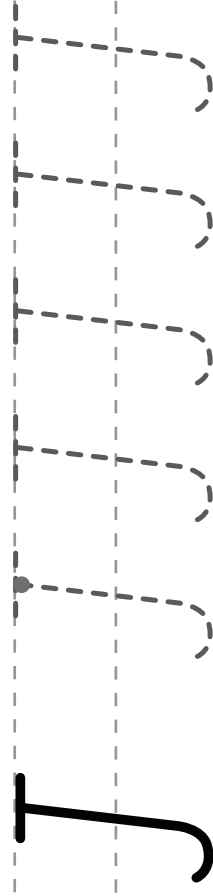

4. Write lowercase letter j.

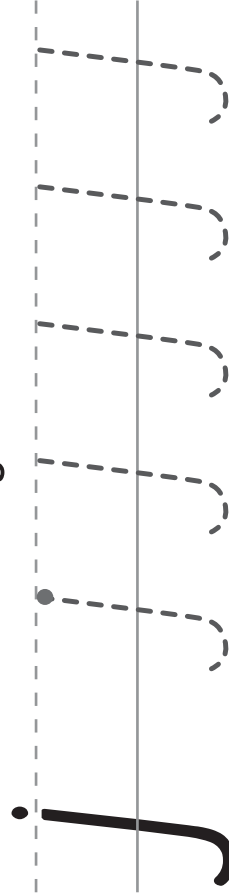

5. Color uppercase letter J and lowercase letter j.

j	S	r	j	m
g	h	J	k	j
J	v	b	e	J
j	n	p	o	m
e	z	c	j	h
a	Y	J	x	J

6. Color the beginning sound.



k

b

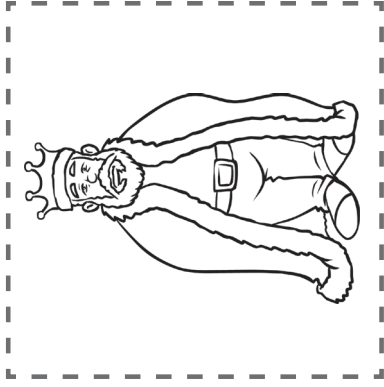

k

s

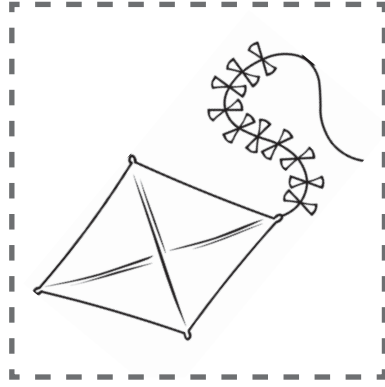

t

k



m

k

's

# Letter Kk Book

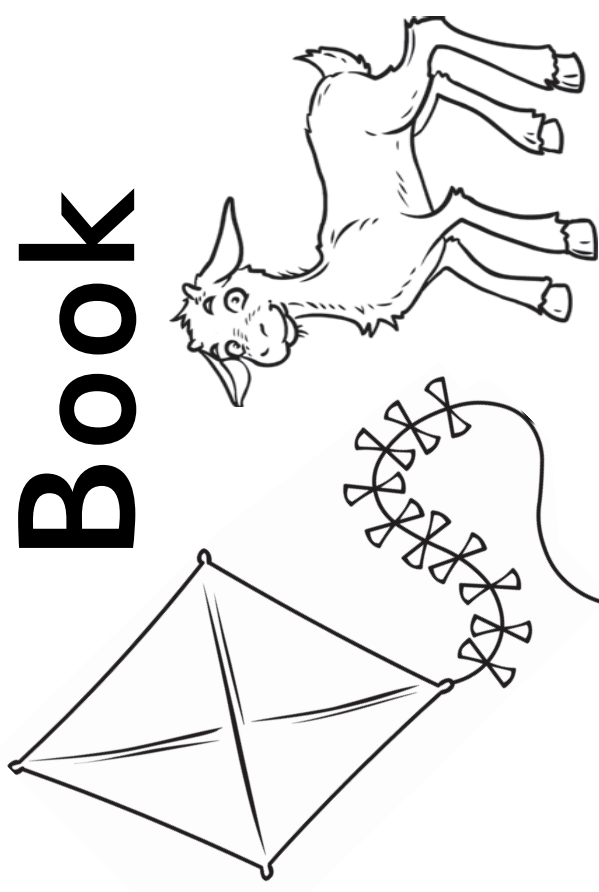

1. Give each koala a kite.

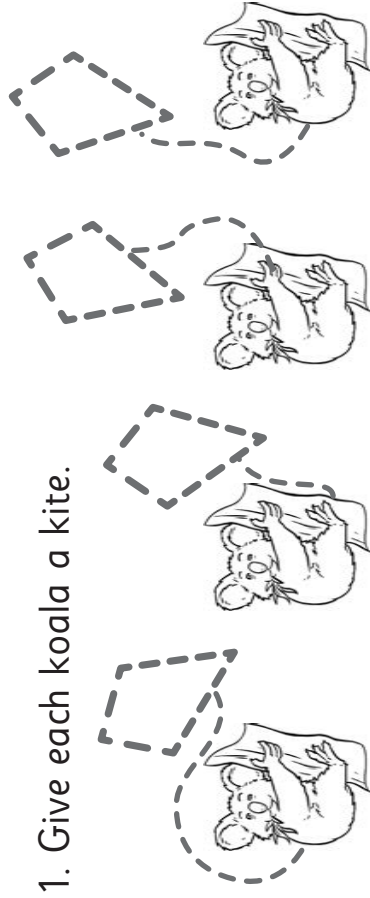

2. Trace.



3. Write uppercase letter K.

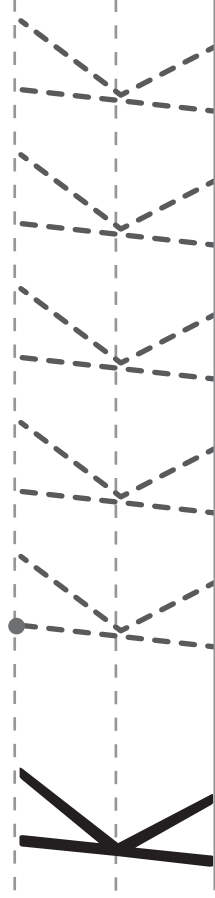

4. Write lowercase letter k.

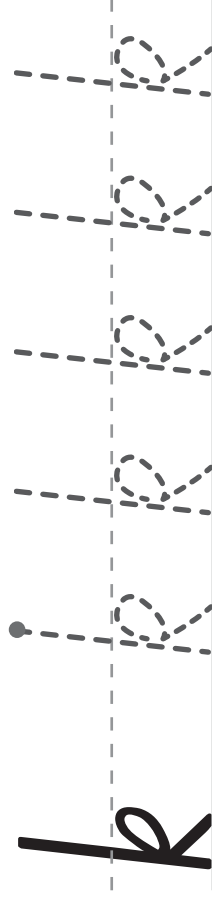

5. Color uppercase letter **K** and lowercase letter **k**.

k	S	r	k	m
g	h	p	e	l
K	v	b	r	K
K	n	K	o	m
k	z	c	e	h
a	Y	x	K	e

6. Add *l*. Say the word.

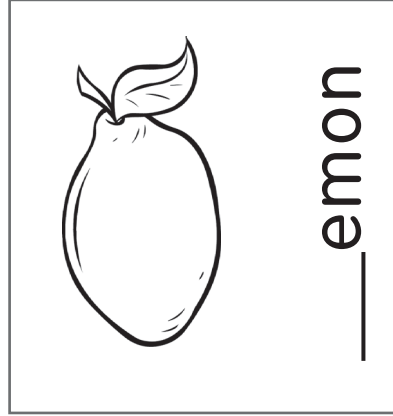
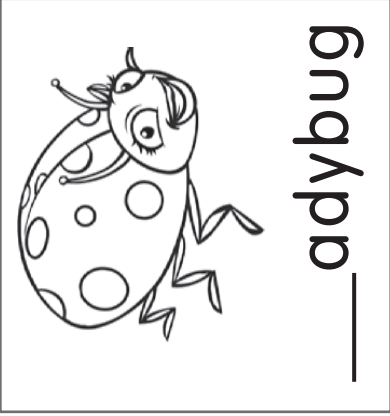
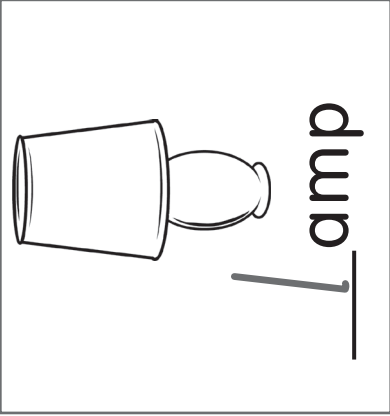

's

# Letter ll Book



1. Trace.

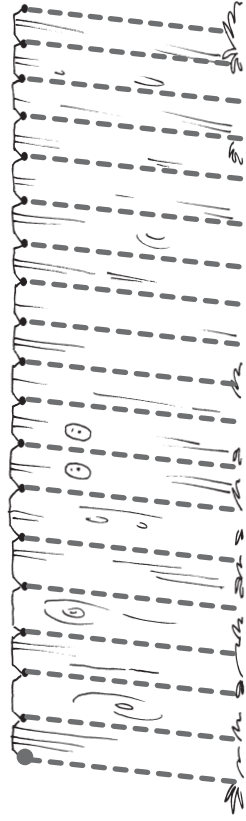

2. Trace.

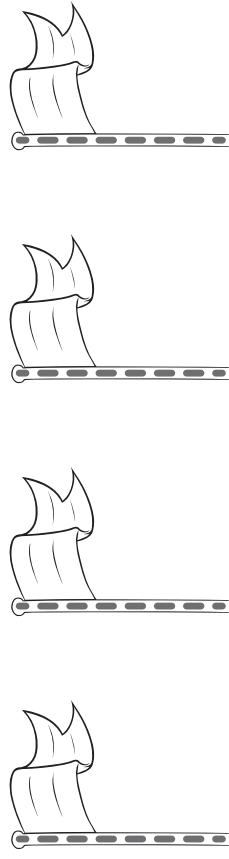

3. Write uppercase letter L.

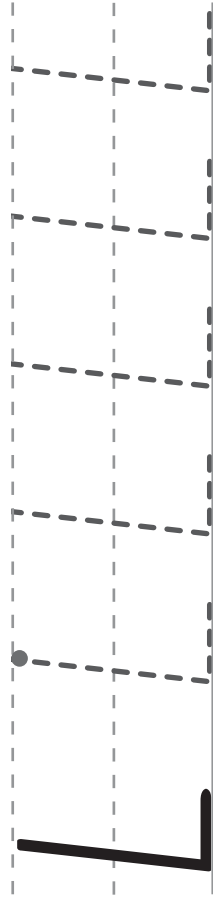

4. Write lowercase letter l.

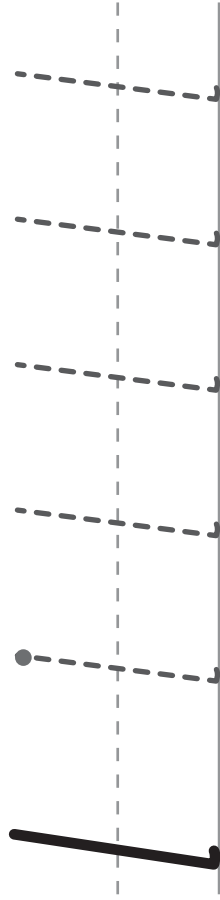

5. Color uppercase letter L and lowercase letter l.

l	S	u	r	m
L	h	l	k	l
g	v	b	l	L
e	n	p	o	m
l	z	c	L	h
l	y	L	x	c

6. Add **M** . Say the word.

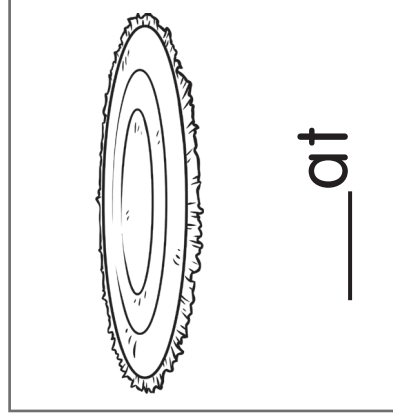
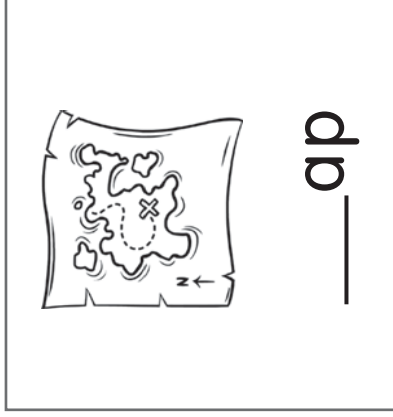
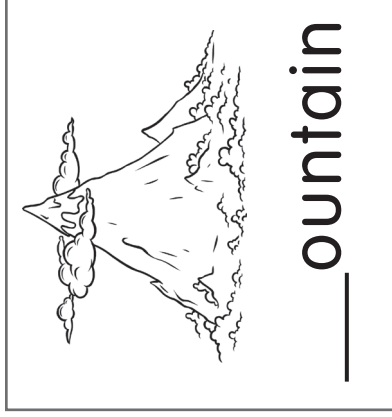
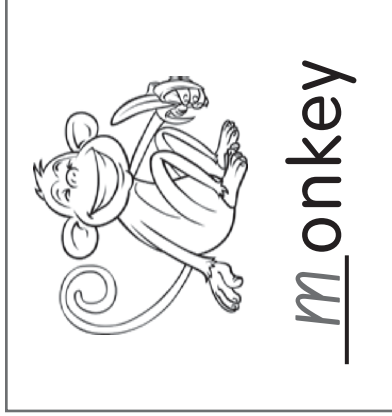

**'s**

Letter

**M M**

Book

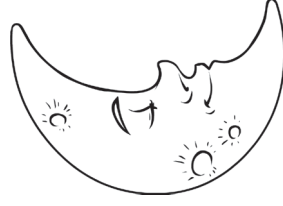

1. Follow the zigzag.

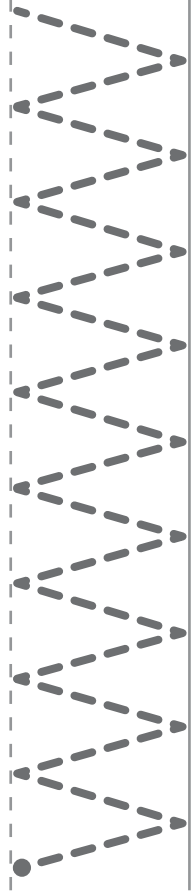

2. Hop.

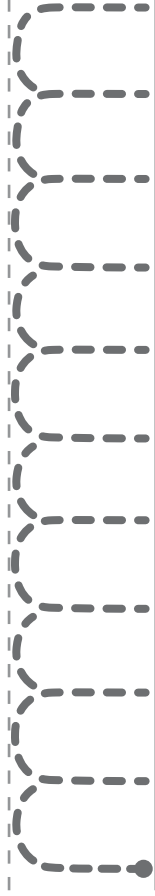

3. Write uppercase letter M.

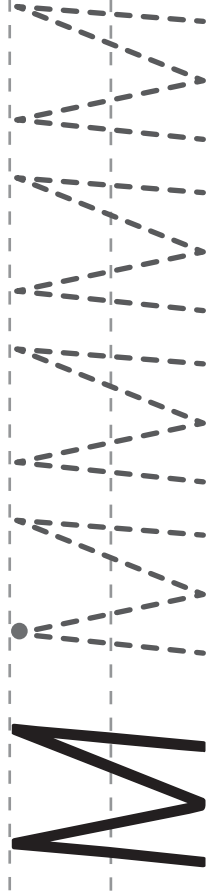

4. Write lowercase letter m.



5. Color uppercase letter *M* and lowercase letter *m*.

A	S	m	a	S
m	I	B	M	t
s	m	T	I	i
M	t	b	m	M
a	s	i	m	B
M	T	b	<b>M</b>	t



6. Circle the matching word.



nest

ladder

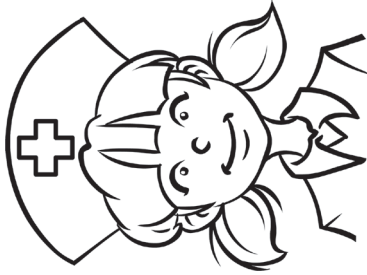

log

nurse

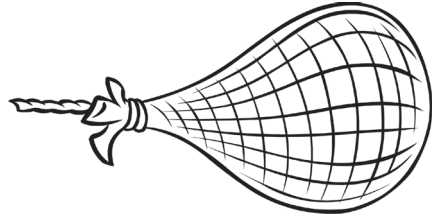

nail

net

's

Letter

W N

Book



1. Trace.

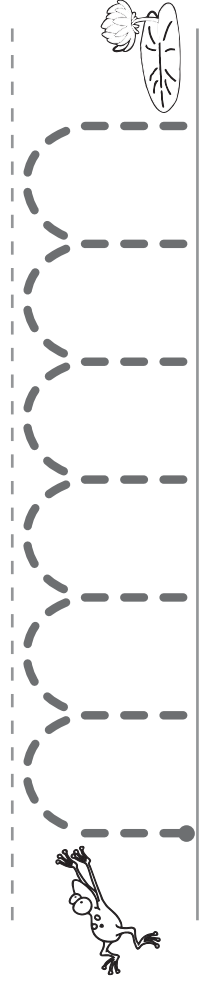

2. Trace.

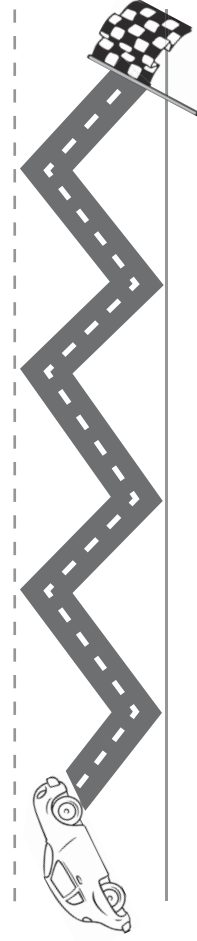

3. Write uppercase letter *N*.

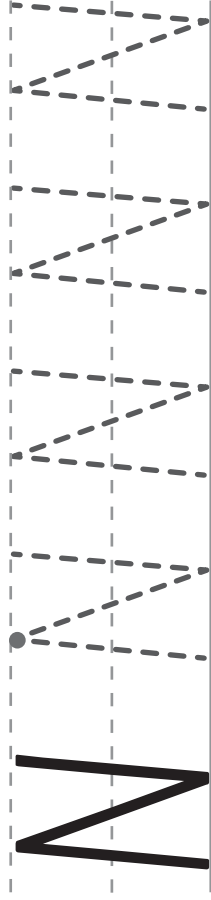

4. Write lowercase letter *n*.



5. Color uppercase letter *N* and lowercase letter *n*.

n	s	r	n	m
g	h	n	k	l
N	v	n	b	N
t	n	p	o	m
n	z	c	a	h
e	n	x	y	n

6. Color the beginning sound.

's

# Letter

# oo

# Book

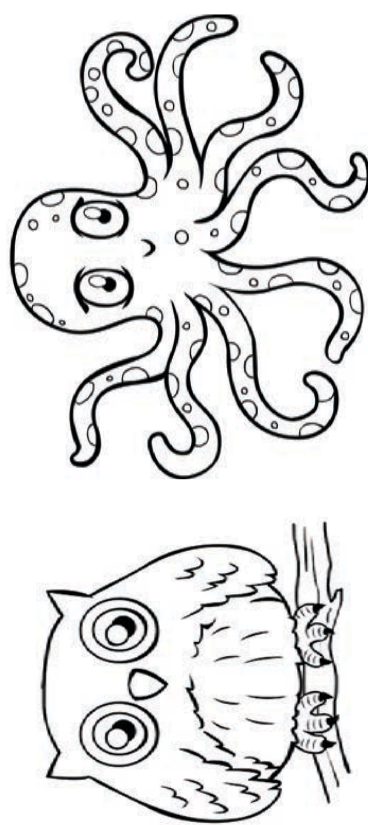
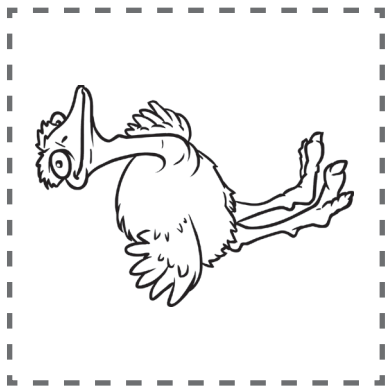
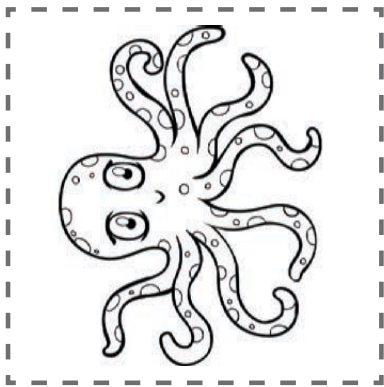

1. Trace.

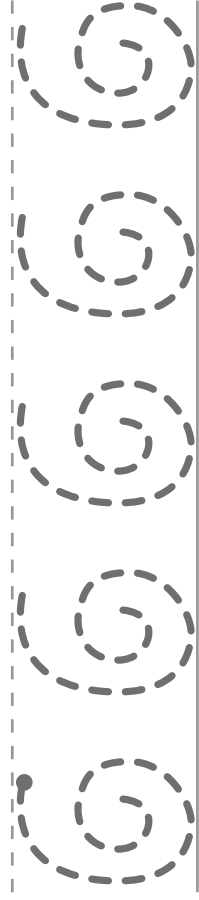

2. Trace.

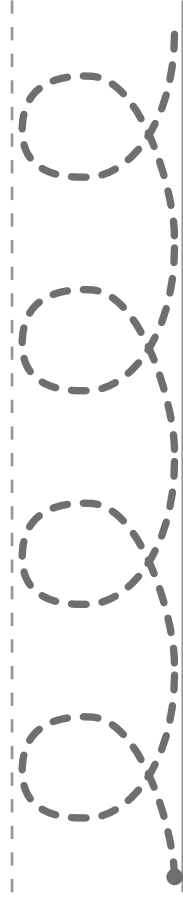

3. Write uppercase letter O.

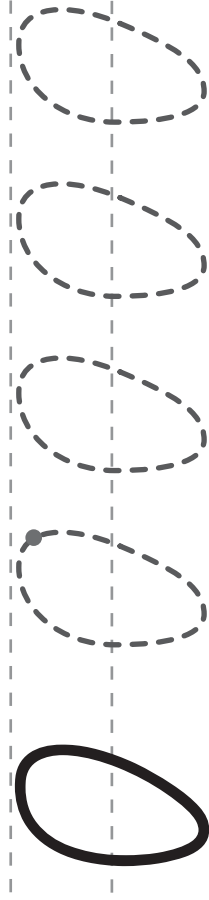

4. Write lowercase letter o.



5. Color uppercase letter O and lowercase letter o.

o	S	r	a	O
g	o	o	k	l
s	v	b	o	O
O	n	p	o	m
O	z	c	o	h
r	U	x	m	O

6. Circle the *p*'s in the sentence.

**I pat Pedro the puppy.**

**“Good puppy, Pedro.”**

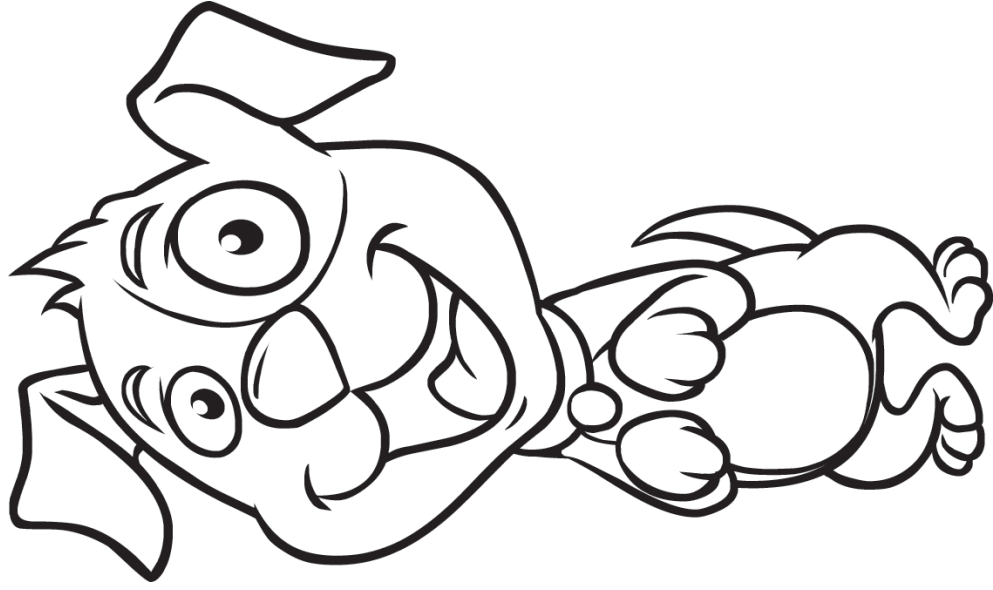

\_\_\_\_\_ ,s

**Letter**

**Pp**

**Book**

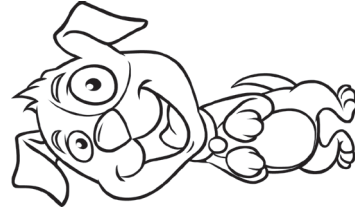

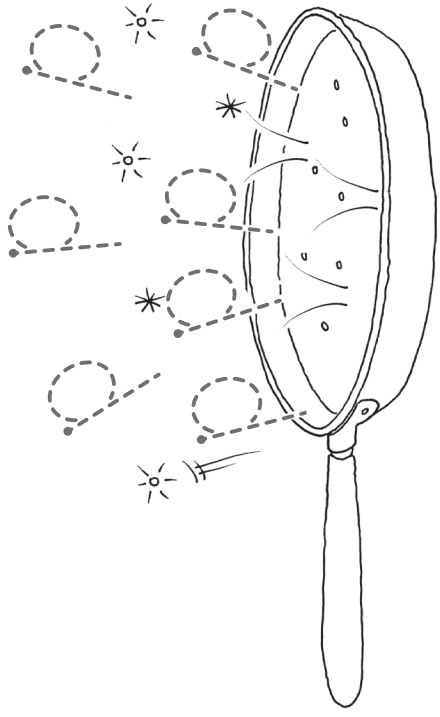

1. Trace.

2. Trace.

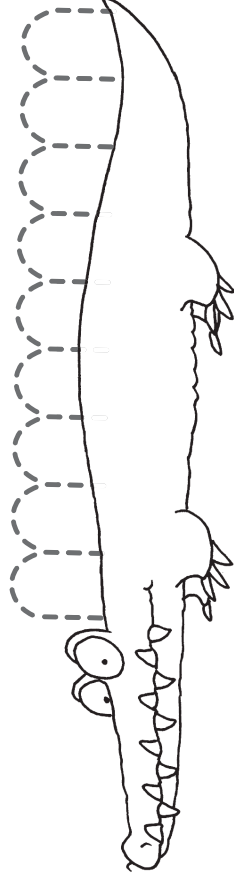

3. Write uppercase letter P.

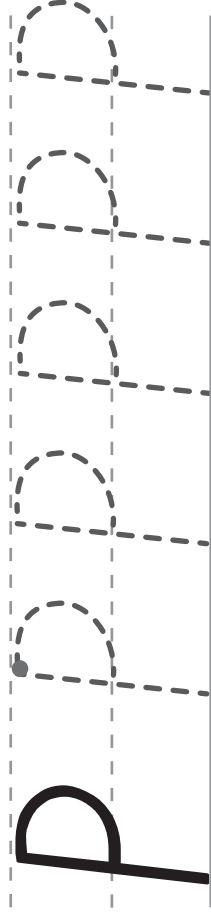

4. Write lowercase letter p.

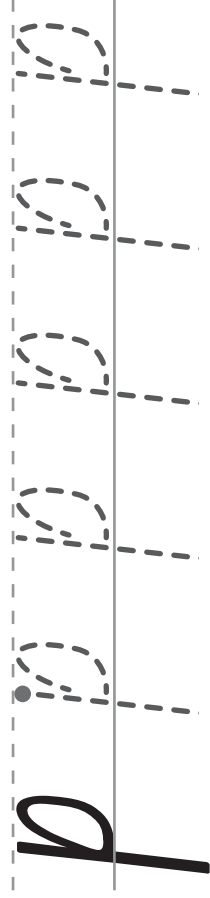

5. Color uppercase letter P and lowercase letter p.

d	S	r	p	m
g	h	ρ	k	l
P	v	b	P	P
p	n	P	o	m
ρ	z	c	P	h
P	y	x	u	k

6. Trace the queen's crown. Add letter Q.



\_\_\_ ueen

's

Letter

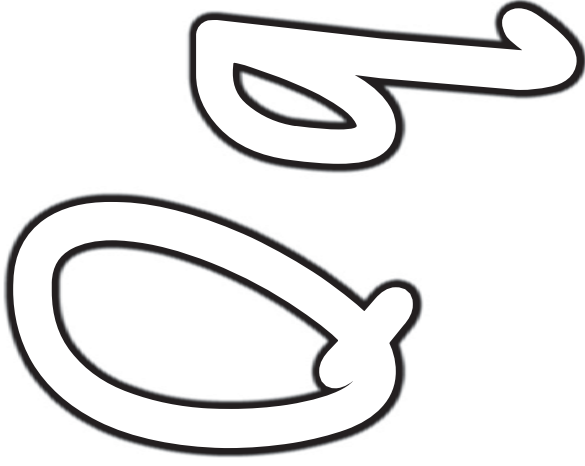

Book



1. Follow the waves.

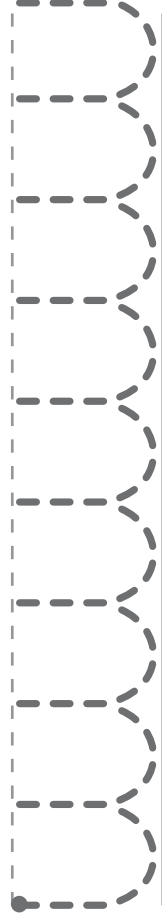

2. Follow the ducks



3. Write uppercase letter Q.

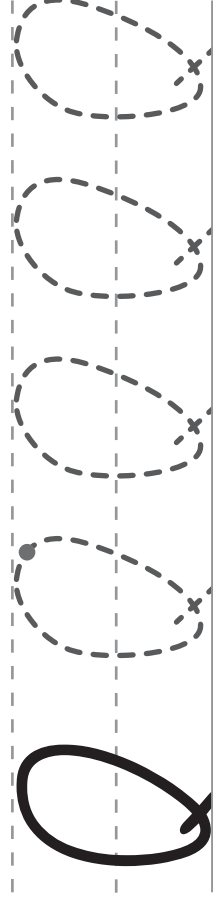

4. Write lowercase letter q.

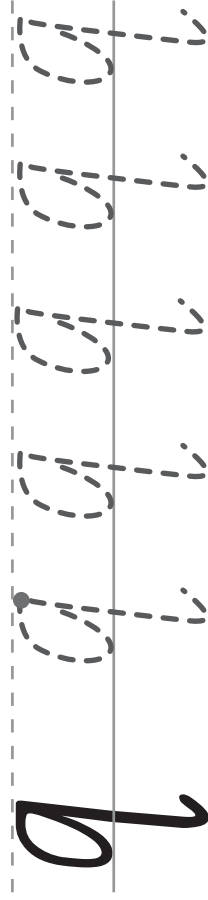



5. Color uppercase letter Q and lowercase letter q.

q	S	r	Q	Q
g	h	q	k	l
Q	v	b	q	Q
W	n	P	o	m
i	z	c	q	h
q	y	x	Q	a



6. Circle the beginning sound.

	<table border="1"><tr><td>+</td><td>r</td></tr></table>	+	r
+	r		

	<table border="1"><tr><td>+</td><td>r</td></tr></table>	+	r
+	r		

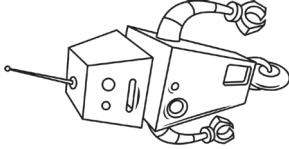
	<table border="1"><tr><td>r</td><td>s</td></tr></table>	r	s
r	s		

	<table border="1"><tr><td>r</td><td>s</td></tr></table>	r	s
r	s		

	<table border="1"><tr><td>a</td><td>r</td></tr></table>	a	r
a	r		

	<table border="1"><tr><td>a</td><td>r</td></tr></table>	a	r
a	r		

,s

# Letter Rr Book

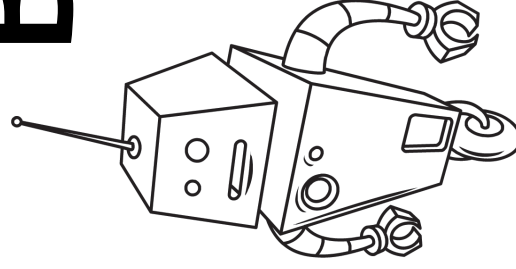

1. Follow the hops.

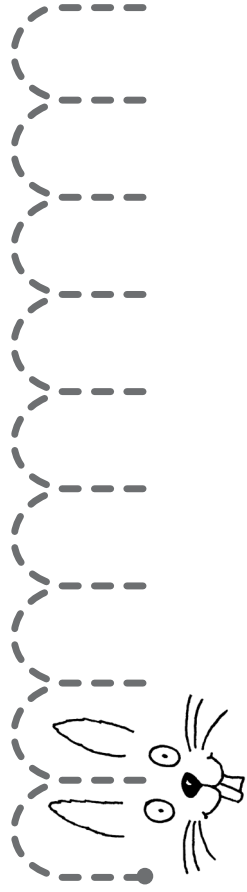

2. Follow the hops.

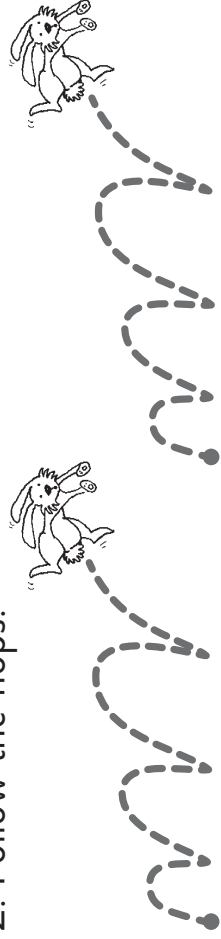

3. Write uppercase letter R.

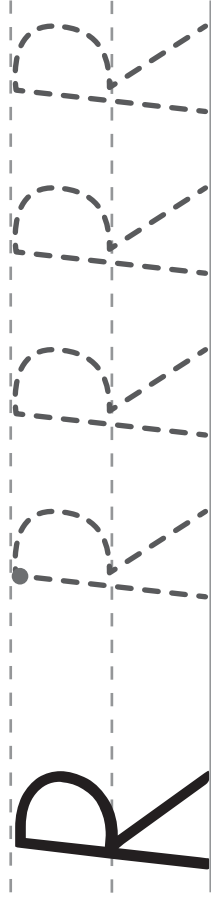

4. Write lowercase letter r.



5. Color uppercase letter **R** and lowercase letter **r**.

R	S	r	u	m
g	h	e	k	l
i	v	q	r	R
r	n	p	o	e
R	z	c	r	h
r	y	x	R	R

6. Color things that begin with S.

'S

# Letter S Book

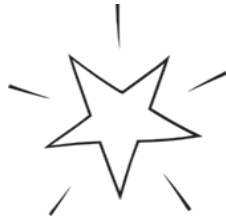
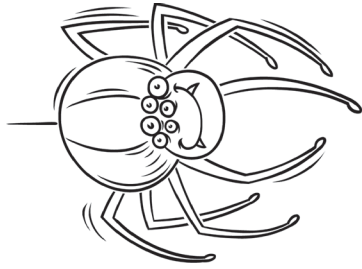
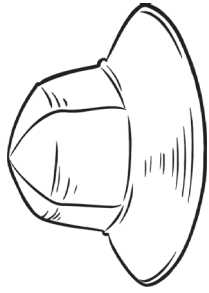
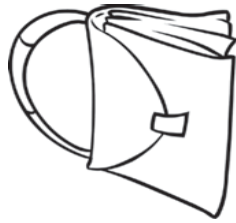

1. Follow the snail!

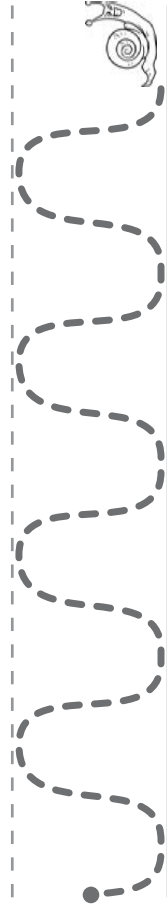

2. Trace.



3. Write uppercase letter S.

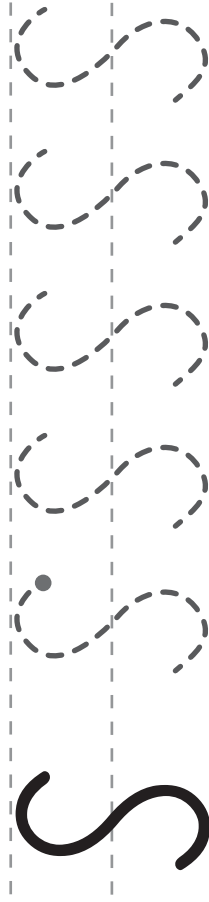

4. Write lowercase letter s.



5. Color uppercase letter S and lowercase letter s.

e	S	r	s	m
g	h	s	k	l
S	v	b	e	S
s	n	p	o	m
a	z	c	s	h
S	y	x	S	s

6. Add **t**. Say the word.

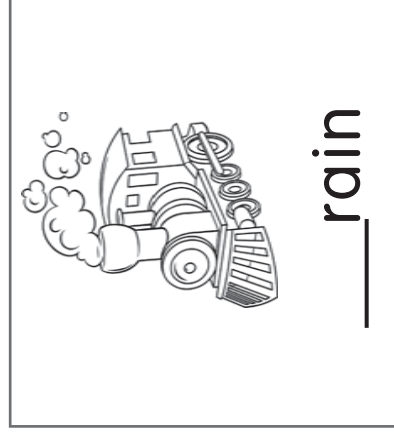
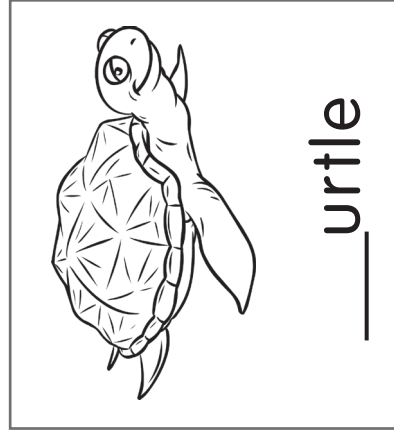
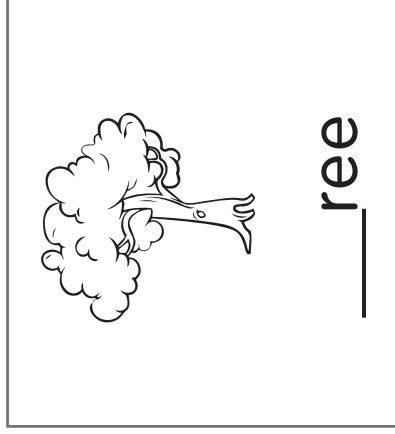
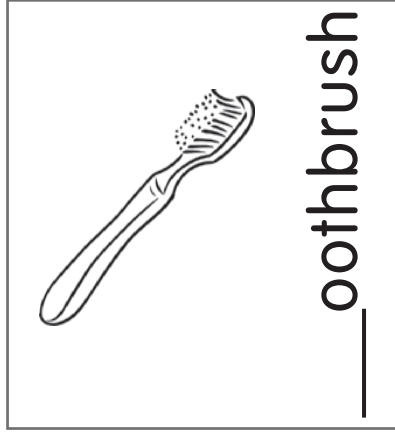
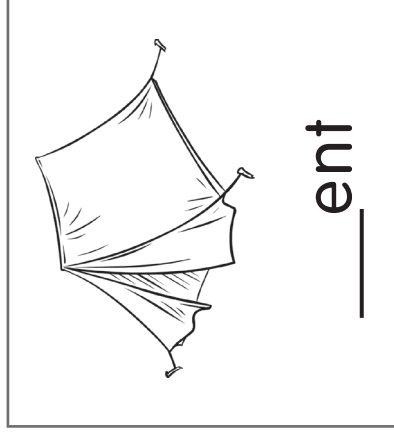
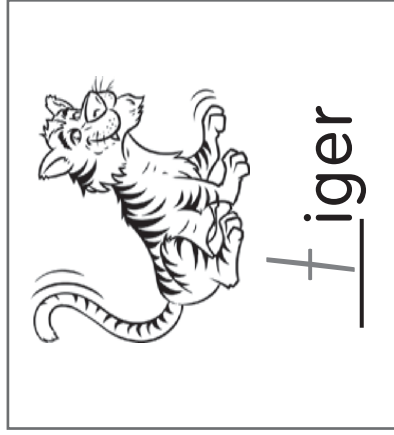

's

# Letter **Tt** Book



1. Trace.

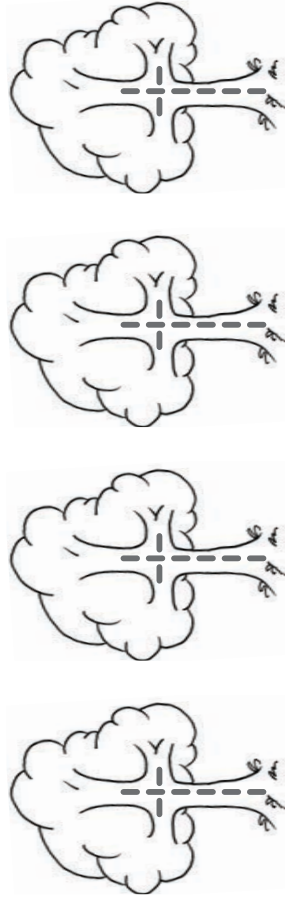

2. Trace the lines.

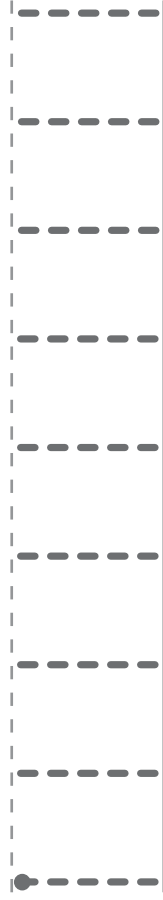

3. Write uppercase letter T.

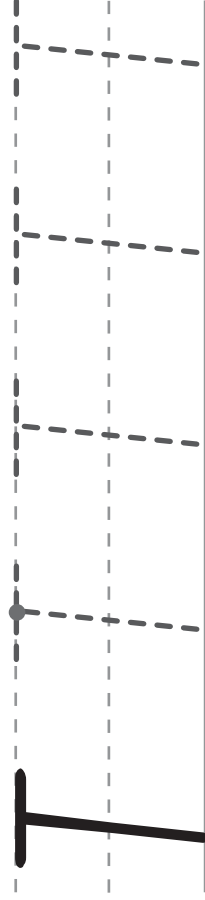

4. Write lowercase letter t.

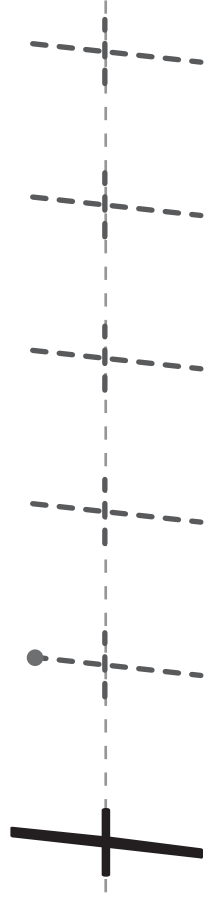

5. Color uppercase letter T and lowercase letter t.

t	S	r	l	m
g	h	t	k	t
T	v	b	t	m
n	e	p	o	T
t	z	c	t	h
t	y	x	o	t

6. Write letter *U*. Color the picture that begins with *U*.

'S

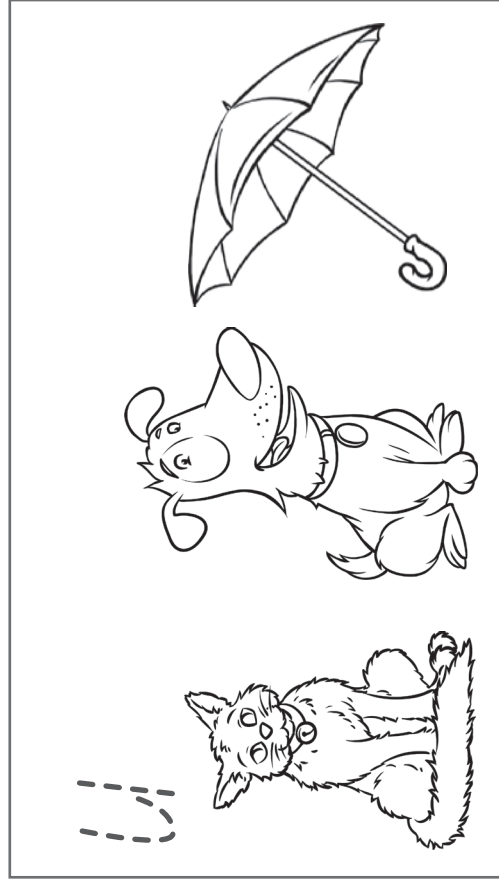
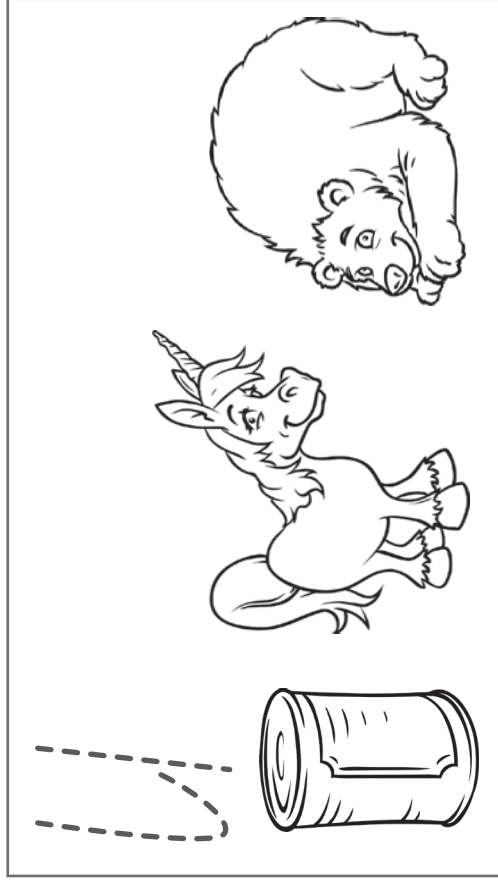

# Letter U U Book



1. Draw the umbrellas.

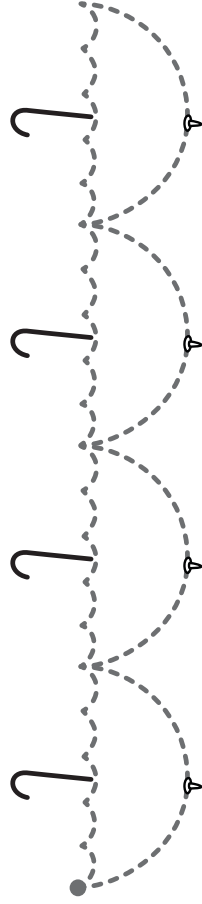

2. Follow the waves.



3. Write uppercase letter U.

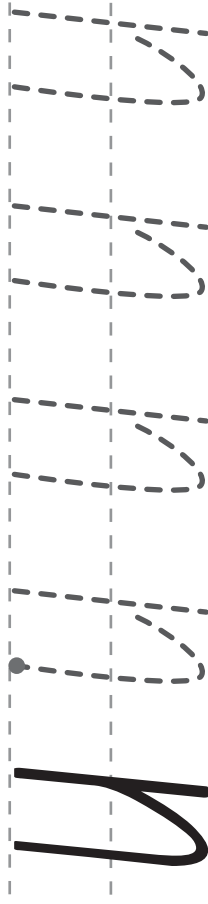

4. Write lowercase letter u.



5. Color uppercase letter *U* and lowercase letter *u*.

u	S	r	u	u
g	h	e	k	l
U	v	b	u	U
U	n	p	o	m
u	z	c	f	h
U	y	x	m	u



6. Color things that begin with *v*.



\_\_\_\_\_ ,s

# Letter V Book



1. Follow the zigzag.

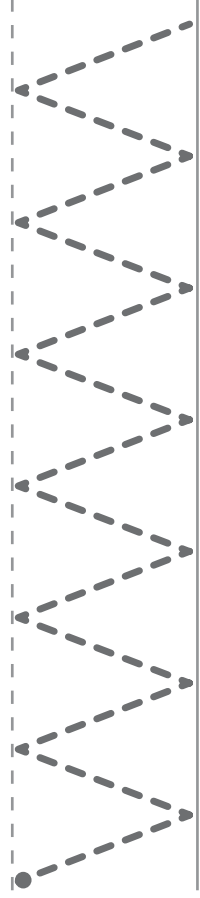

2. Follow the waves.

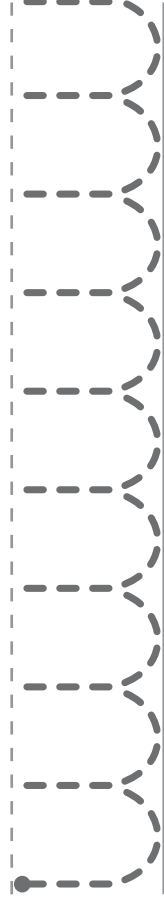

3. Write uppercase letter V.

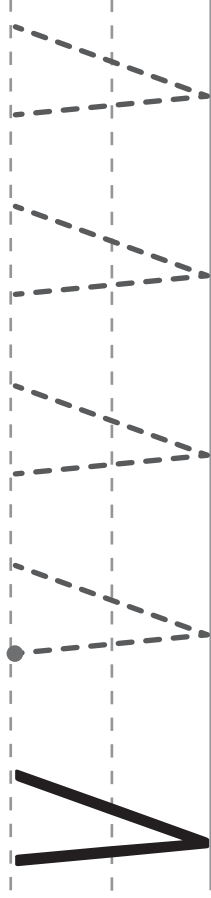

4. Write lowercase letter v.



5. Color uppercase letter V and lowercase letter v.

y	S	r	v	m
g	h	v	k	l
U	v	b	v	V
v	n	p	o	m
Q	v	c	e	h
v	Y	x	o	v

6. Color things that begin with *W*.

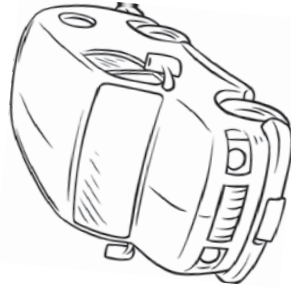

**W**

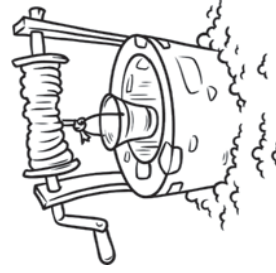
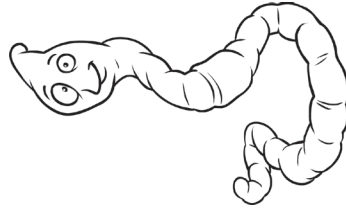

**'S**

**Letter**

**W**

**Book**

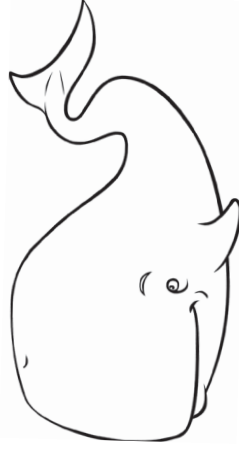
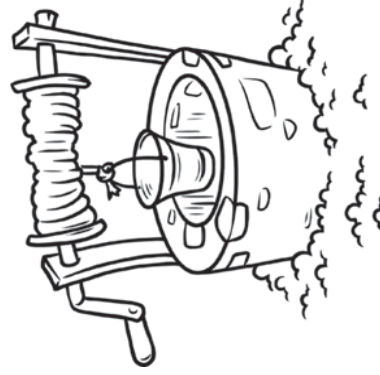

1. Follow the zigzag.

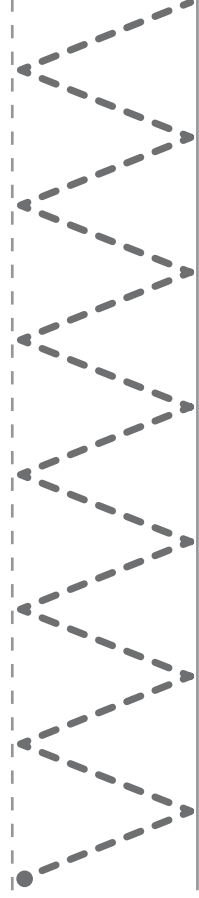

2. Trace.

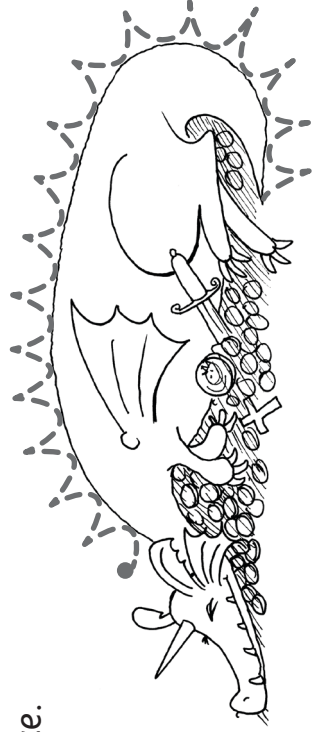

3. Write uppercase letter *W*.

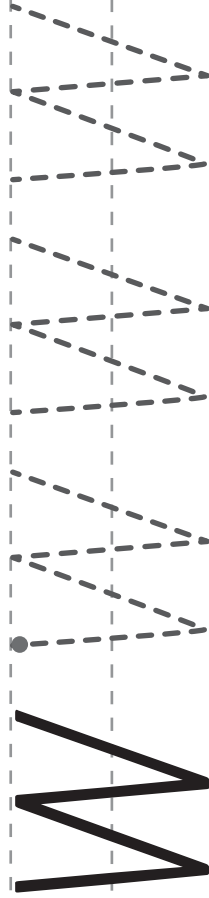

4. Write lowercase letter *w*.



5. Color uppercase letter *W* and lowercase letter *w*.

w	S	r	w	m
g	h	w	k	l
W	v	b	a	W
W	n	p	o	m
w	z	c	W	h
w	y	x	e	w

6. Finish each word with X . Say the word.

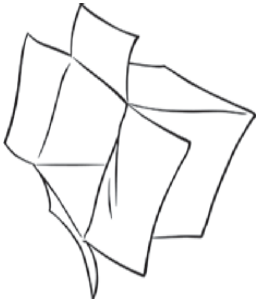

bo\_\_



fo\_\_

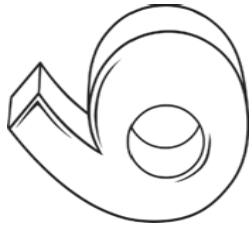

si\_\_



\_\_ray

's

Letter

X X

Book



1. Trace.

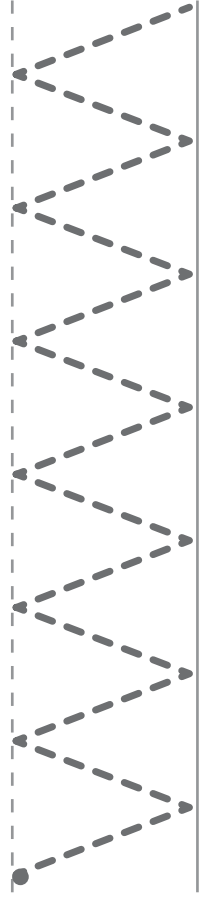

2. Trace.

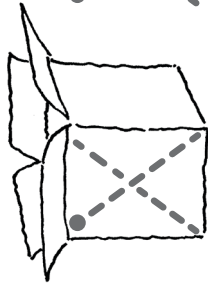

3. Write uppercase letter X.

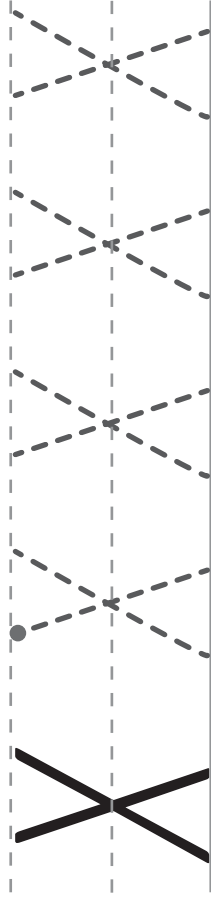

4. Write lowercase letter X.



5. Color uppercase letter X and lowercase letter x.

S	x	r	x	X
g	h	x	l	X
X	v	b	w	X
m	n	p	X	m
x	z	c	e	h
ke	y	x	o	f

6. Add *y*.



See the \_\_\_ak.



I like \_\_\_ogurt.



I have a \_\_\_ellow \_\_\_oyo.

\_\_\_\_\_ 's

Letter  
**Yy**

Book

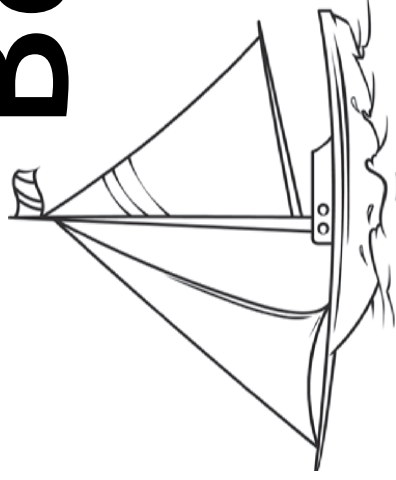

1. Follow the zigzag.

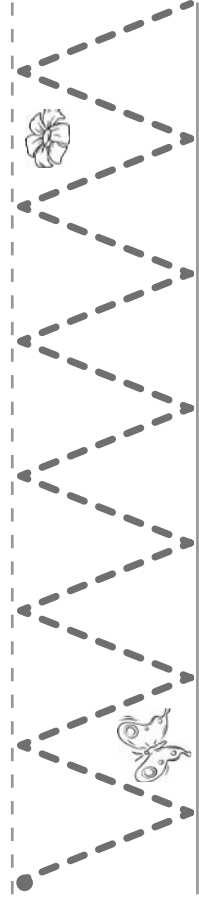

2. Trace.

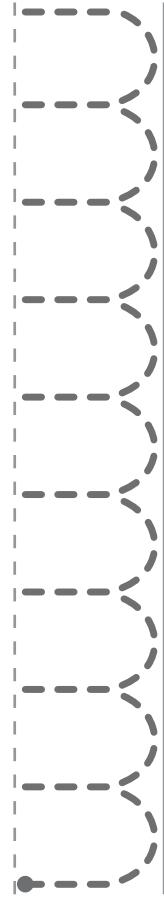

3. Write uppercase letter Y.

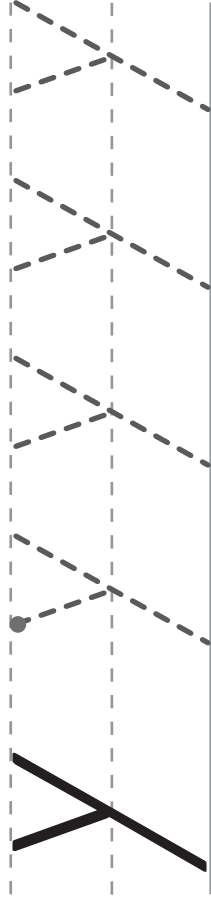

4. Write lowercase letter y.

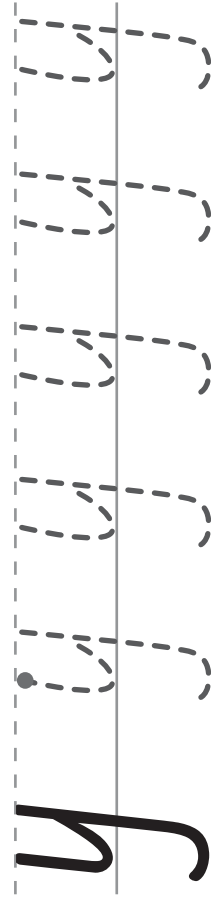

5. Color uppercase letter Y and lowercase letter y.

u	S	r	y	m
g	h	y	k	l
Y	v	b	y	Y
Y	n	p	o	y
Y	m	y	w	h
x	e	f	d	y



6. Join Buzzy Bee to Z flowers.

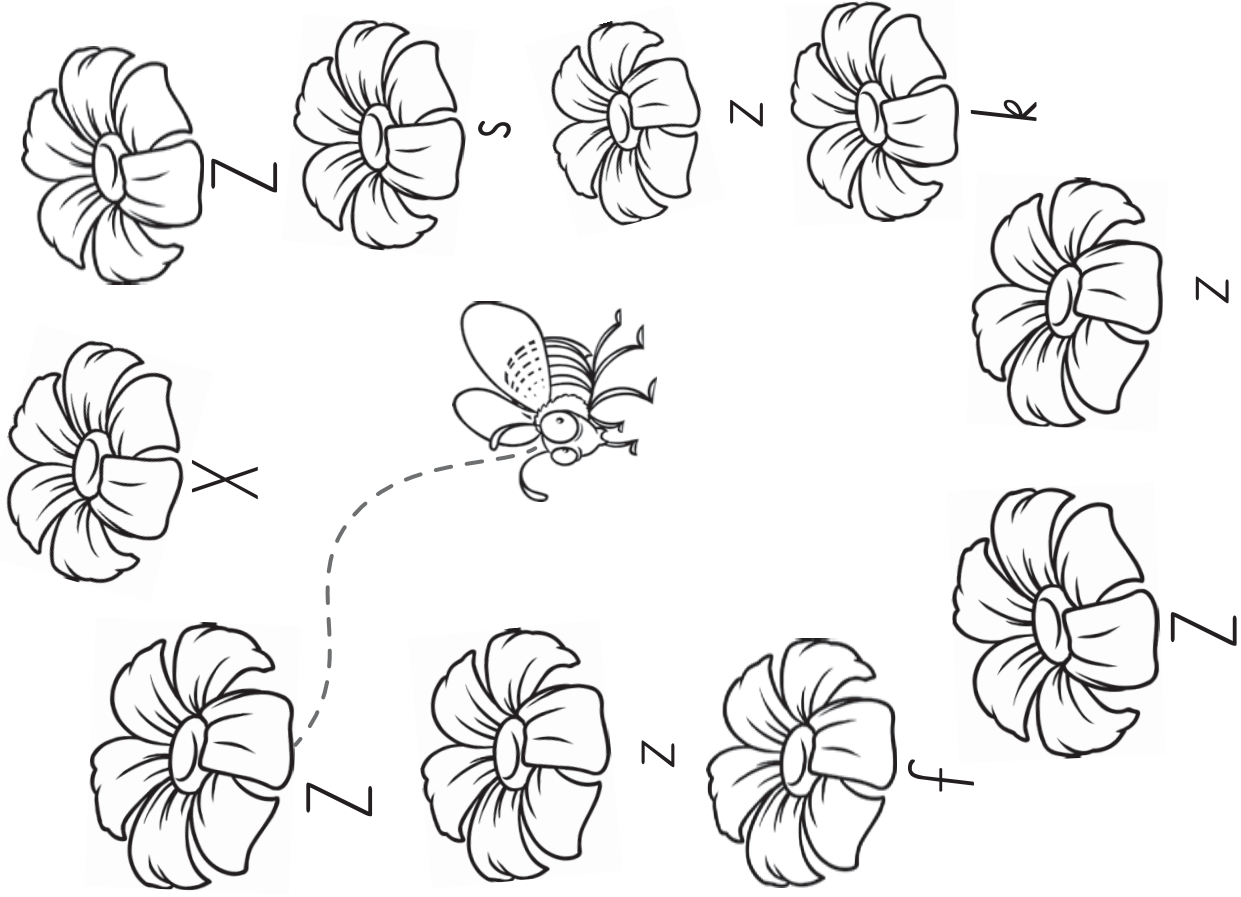

,s

Letter  
ZZ

Book

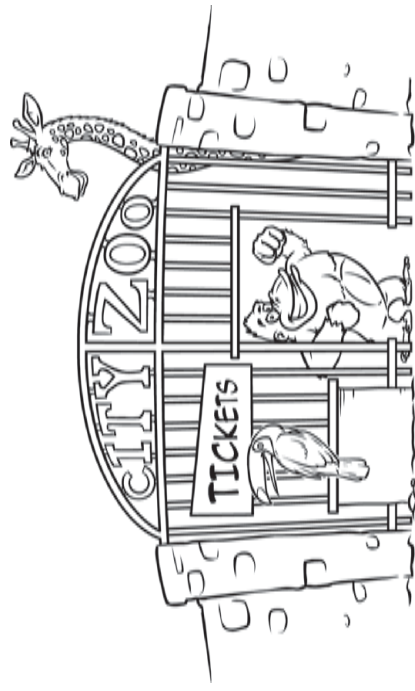

1. Follow the zigzag.

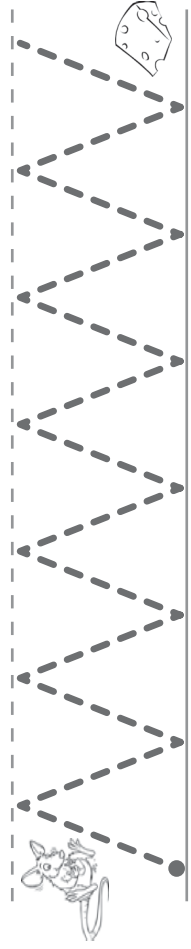

2. Trace.

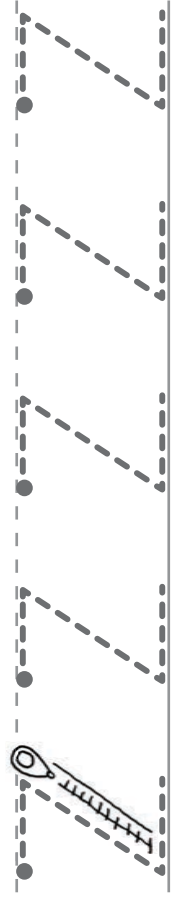

3. Write uppercase letter Z.

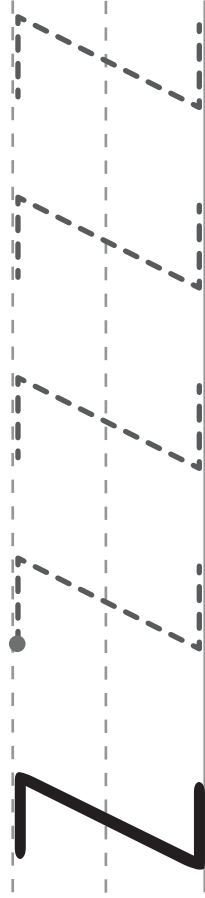

4. Write lowercase letter Z.

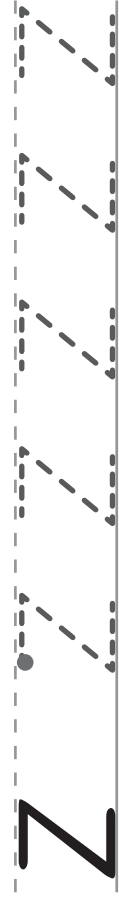

5. Color uppercase letter Z and lowercase letter z.

z	S	r	z	m
g	h	a	Z	l
Z	v	b	e	Z
Z	n	p	o	m
z	z	c	e	h
z	y	x	Z	w

# THANK YOU!

Thank you for trying this resource!

We hope you enjoy using it with your students.

Visit our **Teach Reading with Reading Eggs TPT** store for these other great resources.



## DELETING PHONEMES

Can you hear the missing sound?

Play listening games to help learners "tune in" to the sounds in words. Great for small groups or whole class phonics lessons.

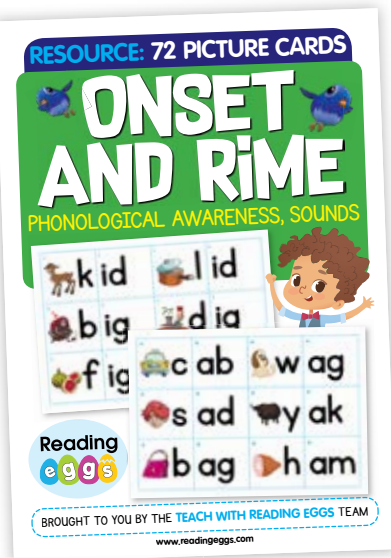
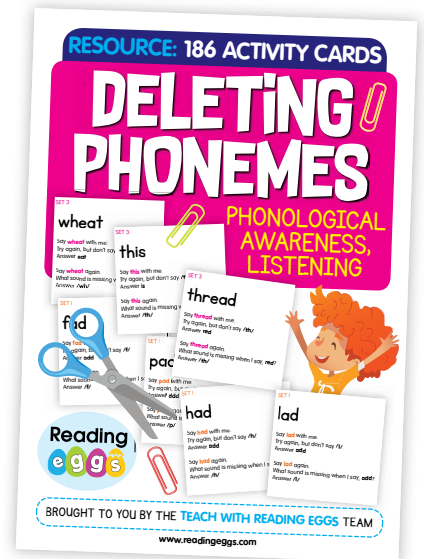

## ONSET AND RIME

We are family!

These easy-to-use card sets of word families are ready to print and go. Both color + black and white included so you can start using our puzzle cards today!



## SPELLING POSTERS

**FREE!**

Spelling is easy together!

Ready-to-use, these sound charts are great for young writers!



# HAPPY EGGSPLORING!

[www.readingeggs.com](http://www.readingeggs.com)