

INTRODUCTION

Florida's stormwater regulatory program requires the use of Best Management Practices (BMPs) during and after construction to minimize erosion and sedimentation and to properly manage runoff for both stormwater quantity and quality. However, insufficient staffing among regulatory agencies, combined with lack of awareness among contractors, has resulted in a low rate of compliance.

To improve this situation the Department of Environmental Protection has developed a training program curriculum on the use, installation, and maintenance of erosion, sedimentation, and stormwater BMPs. The training program is primarily directed towards inspectors and contractors, however, permit reviewers and public works personnel will also benefit from this program.

This manual is designed to be a comprehensive reference source for the conduct of your daily professional duties. Do not attempt to memorize this entire manual. Instead, become familiar enough to know where to find information quickly. Review the manual periodically to improve and maintain your technical and personal skills. Refer to this manual when facing a new situation or when in doubt. Try to keep this manual with you while conducting your duties.

Mission Statement

The objectives of this training and certification program are:

- * to assure that the desired benefits of stormwater management systems are being achieved.
- * to assure that both the public and private sectors have enough inspectors trained in the proper installation and maintenance of BMPs during and after construction.
- * to assure a consistent level of technical expertise and professional conduct for all individuals responsible for inspecting erosion and sediment controls and stormwater management systems.

TABLE OF CONTENTS

INTRODUCTORY SECTION

INTRODUCTION and MISSION STATEMENT	1
TABLE OF CONTENTS	2
LIST OF PLATES	5
LIST OF ABBREVIATIONS	10
THE WATER QUALITY INSPECTOR'S CREED	11

CHAPTER 1 EROSION AND SEDIMENT CONTROL

1.1	THE EROSION PROCESS	1
1.2	IMPACTS OF SEDIMENTATION AND EROSION	5
1.3	PRINCIPLES OF EROSION AND SEDIMENT CONTROL	9

CHAPTER 2 SOILS

2.1	GENERAL OVERVIEW	1
2.2	CLASSIFICATION AND PROPERTIES	3
2.3	ESTIMATING SOIL LOSS	9
2.4	SOIL SURVEYS	11

CHAPTER 3 ESTIMATING STORMWATER RUNOFF

3.1	INTRODUCTION	1
3.2	DESIGN STORMS	2
3.3	HYDROGRAPHS	3
3.4	GENERAL PROCEDURE	5
3.5	RATIONAL METHOD	7
3.6	OTHER METHODS	23

CHAPTER 4 BEST MANAGEMENT PRACTICES FOR EROSION AND SEDIMENTATION CONTROL

4.1	IMPORTANCE OF CONSTRUCTION SEQUENCING	1
4.2	POLLUTION SOURCE CONTROLS ON CONSTRUCTION SITES	3
4.3	TEMPORARY GRAVEL CONSTRUCTION ENTRANCE	7
4.4	CONSTRUCTION ROAD STABILIZATION	11
4.5	STRAW BALE BARRIER	13

TABLE OF CONTENTS (Continued)

4.6	SILT FENCE	21
4.7	BRUSH BARRIER	31
4.8	STORMDRAIN INLET PROTECTION	33
4.15	TEMPORARY DIVERSION DIKE	55
4.16	TEMPORARY FILL DIVERSION	59
4.17	TEMPORARY RIGHT-OF-WAY DIVERSION	63
4.25	TEMPORARY SEDIMENT TRAP	67
4.26	TEMPORARY SEDIMENT BASIN	79
4.30	TEMPORARY SLOPE DRAIN	99
4.38	TEMPORARY CHECK DAMS	105
4.40	DEWATERING	113
4.45	FLOATING TURBIDITY BARRIER	115

**CHAPTER 5
BEST MANAGEMENT PRACTICES
FOR STORMWATER MANAGEMENT**

	STORMWATER INTRODUCTION	1
5.00	EARTHWORK SPECIFICATIONS	3
5.01	RETENTION BASINS	5
5.02	EXFILTRATION TRENCHES	11
5.03	POROUS PAVEMENT	23
5.04	CONCRETE GRID AND MODULAR PAVEMENT	25
5.05	DETENTION BASINS	27
5.06	UNDERDRAINS AND STORMWATER FILTER SYSTEMS	31
5.07	GRASSED WATERWAYS AND SWALES	41
5.08	STORMWATER CONVEYANCE CHANNEL	47
5.09	PAVED FLUME	51
5.10	DIVERSION	53
5.11	LEVEL SPREADER	57
5.12	CHECK DAM	59
5.14	WATERWAY DROP STRUCTURE	63
5.15	OUTLET PROTECTION	67
5.16	RIPRAP	71
5.17	GRID CONFINEMENT SYSTEMS	75
5.18	CELLULAR CONCRETE BLOCK	79
5.19	MAINTENANCE	85

**CHAPTER 6
BEST MANAGEMENT PRACTICES -
VEGETATION FOR EROSION CONTROL**

6.60	SURFACE ROUGHENING	1
6.61	TOPSOILING	7
6.65	TEMPORARY SEEDING	11
6.66	PERMANENT SEEDING	13

TABLE OF CONTENTS (Continued)

6.67	SODDING	17
6.75	MULCHING	23
6.80	TREES, SHRUBS, VINES, AND GROUND COVERS	35
6.85	TREE PRESERVATION AND PROTECTION	43
6.98	VEGETATIVE STREAMBANK STABILIZATION	51

**CHAPTER 7
THE EROSION AND SEDIMENT CONTROL PLAN**

7.1	ELEMENTS OF AN EROSION & SEDIMENT CONTROL PLAN	1
7.2	PREPARING AN EROSION & SEDIMENT CONTROL PLAN	3
7.3	EVALUATING AN EROSION & SEDIMENT CONTROL PLAN	13
7.4	IMPLEMENTING AN EROSION & SEDIMENT CONTROL PLAN	17

**CHAPTER 8
INSPECTION AND ENFORCEMENT**

8.1	THE ROLE OF THE INSPECTOR	1
8.2	SITE INSPECTION	3
8.3	INSPECTING EROSION & SEDIMENT CONTROL PRACTICES	11
8.4	INSPECTING STORMWATER MANAGEMENT SYSTEMS DURING CONSTRUCTION	17
8.5	INSPECTING VEGETATION USED FOR EROSION CONTROL	27

APPENDICES:

8-A	HUMAN RELATIONS	31
8-B	CONDUCT GUIDELINES AS A WITNESS	37
8-C	ESTIMATING QUANTITIES	40
8-D	SAMPLE CHECK LISTS:	41
1	PLAN REVIEW	43
2	PRE-CONSTRUCTION CONFERENCE	45
3	ROUTINE / MAINTENANCE INSPECTION	47
4	FINAL INSPECTION	51

GLOSSARY OF TERMS

LIST OF PLATES

Plate No.	Description	Page
1.1	Types of Soil Erosion	1-2
1.3a	Fit the Development to the Terrain	1-9
1.3b	Minimize the Extent and Duration of Exposure	1-10
1.3c	Apply Perimeter Controls	1-10
1.3d	Apply Erosion Control On-site	1-11
1.3e	Keep Runoff Velocities low	1-12
1.3f	Stabilize Disturbed Areas	1-12
1.3g	Begin Maintenance	1-13
2.1	Soil Profile with Common Horizon Designations	2-2
2.2	Guide to Textural Classification of Soils	2-6
3.3a	Hydrograph Properties	3-4
3.3b	Comparison of Hydrographs	3-4
3.5a	Average Velocities for Estimating Travel Times	3-12
3.5b	2 Year - 24 Hour Rainfall	3-16
3.5c	Florida Zones for Precipitation (IDF Curves)	3-19
3.5d	Rainfall Intensity - Duration - Frequency Curves for Zone 2	3-19
4.03a	Temporary Gravel Construction Entrance	4-8
4.03b	Soil Tracking Prevention Device	4-9
4.03c	Construction Entrance with Wash Rack	4-10
4.05a	FDOT Standard Index 102, Chart 1	4-14
4.05b	Construction of a Straw Bale Barrier	4-15
4.05c	Installation of Straw Bales	4-16
4.05d	Straw Bale Barrier	4-18
4.05e	Proper Placement of Straw Bales at the Toe of a Slope	4-19
4.05f	Proper Placement of Straw Bale Barrier in a Drainage Way	4-20
4.06a	FDOT Standard Index 102, Chart 1	4-22
4.06b	Construction of a Filter Barrier	4-24
4.06c	Double Row Staked Silt Fence	4-26
4.06d	Installing a Filter Fabric Silt Fence	4-28
4.06e	Silt Fence	4-29
4.06f	Proper Placement of a Silt Fence at the Toe of a Slope	4-30
4.06g	Attaching Two Silt Fences	4-30
4.07a	Construction of a Brush Barrier Covered with Filter Fabric	4-32
4.08a	Straw Bale Drop Inlet Sediment Filter	4-34
4.08b	Straw Bale Filter for Area Inlet	4-35
4.08c	Straw Bale and Gravel Drop Inlet Sediment Barrier	4-36
4.08d	Silt Fence Drop Inlet Sediment Barrier	4-38
4.08e	Filter Fabric Drop Inlet Sediment Filter	4-39
4.08f	Gravel and Wire Mesh Drop Inlet Sediment Filter	4-40
4.08g	Block and Gravel Drop Inlet Sediment Filter	4-42
4.08h	Block and Gravel Drop Inlet Sediment Filter	4-43
4.08i	Gravel Filters for Area Inlets	4-44
4.08j	Sod Drop Inlet Sediment Filter	4-46
4.08k	Gravel Curb Inlet Sediment Filter	4-47

LIST OF PLATES (Continued)

Plate No.	Description	Page
4.08L	Gravel Curb Inlet Sediment Filter with Overflow Weir	4-48
4.08m	Block and Gravel Curb Inlet Sediment Filter	4-49
4.08n	Curb Inlet Gravel Filters	4-50
4.08o	Curb Inlet Sediment Barrier	4-52
4.08p	Gravel Bag Curb Sediment Filters	4-53
4.08q	Curb and Gutter Sediment Barrier	4-54
4.15a	Temporary Diversion Dike	4-57
4.16a	Temporary Fill Diversion	4-60
4.17a	Temporary Right-of Way Diversions	4-64
4.17b	Rolling Dip and Water Bar	4-66
4.25a	Earth Outlet Sediment Trap	4-68
4.25b	Pipe Outlet Sediment Trap	4-70
4.25c	Stone Outlet Sediment Trap	4-71
4.25d	Semi-pervious Straw Bale Sediment Barrier	4-72
4.25e	Excavated Drop Inlet Sediment Trap	4-75
4.25f	Storm Inlet Sediment Trap	4-76
4.25g	Small Sediment Trap Located within a SW Conveyance Channel	4-77
4.25h	Sediment Trap and Basin Guide	4-78
4.26a	Sediment Basin Storage Volumes	4-80
4.26b	Sediment Basin Schematic Elevations	4-82
4.26c	Anti-vortex Device Design	4-79
4.26d	Riser Pipe Conditions	4-84
4.26e	Location of Anti-seep Collars	4-85
4.26f	Emergency Spillway	4-86
4.26g	Sediment Basin	4-88
4.26h	Example Plan Views of Baffle Locations in Sediment Basins	4-90
4.26i	Principal Spillway Design	4-92
4.26j	Excavated Earth Spillway	4-94
4.26k	Riser Pipe Base Conditions for Embankments Less than 10 Feet	4-95
4.26L	Anti-seep Collar Details	4-96
4.26m	Perforated Pipe Sediment Basin Dewatering Device	4-97
4.26n	Dewatering a Sediment basin with a Subsurface Drain	4-97
4.30a	Temporary Slope Drain	4-99
4.30b	Slope Drain	4-100
4.30c	Overside Drain	4-102
4.30d	Flared End Section Schematic	4-103
4.30e	Flared End Section Specifications	4-104
4.38a	Log Check Dam	4-106
4.38b	Rock Check Dam	4-108
4.38c	Straw Bale Check Dam	4-109
4.38d	Silt Fence Check Dam	4-110
4.38e	Rock Check Dam Details	4-111
4.38f	Straw Bale Check Dam Details	4-112
4.45a	Type I and II Floating Turbidity Barriers	4-118

LIST OF PLATES (Continued)

Plate No.	Description	Page
4.45b	Type III Floating Turbidity Barrier	4-120
4.45c	Typical Installation Layouts	4-122
5.01a	Off-line Treatment Systems	5-6
5.01b	Schematic of Flow Characteristics Associated with Infiltration from Retention Ponds during Low and High Water Table Conditions	5-7
5.01c	Generalized Geological Section in Karst Sensitive Area	5-8
5.01d	Karst Sensitive Geological Profile Illustrating Conditions Following Excavation of a Retention Basin	5-9
5.01e	Generalized Geological Profile Illustrating Solution Pipe Sink Hole Formation Associated with Retention Pond Operation	5-10
5.02a	Cross-section of Typical Infiltration/Exfiltration System	5-12
5.02b	Typical Section, Slab Covered Trench, Dade County, FL	5-14
5.02c	French Drain (Exfiltration Trench), Dade County, FL	5-16
5.02d	Examples of Typical Underground Percolation Systems	5-18
5.02e	Detailed Schematic of a Typical Observation Well	5-20
5.02f	Example Application of a Vegetated Area for Pretreatment of Runoff Prior to Exfiltration in Frederick County, MD	5-22
5.03a	Examples of Porous Pavement Drainage Systems	5-24
5.04a	Types of Grid and Modular Pavements	5-26
5.05a	Typical Detention Basin Hydrographs	5-27
5.05b	Examples of Dead Storage Areas in Wet Ponds	5-28
5.05c	Wet Detention System, Pond Configuration - A	5-29
5.05d	Wet Detention System, Pond Configuration - B	5-30
5.06a	Sketch of Typical Underdrain System, Area Served by Laterals	5-32
5.06b	Cross-section of Stormwater Discharge Structure	5-33
5.06c	Illustration of Typical "Natural Soil" Bank Filtration System	5-34
5.06d	Typical Subdivision Layout w/ On-line Detention Pond	5-35
5.06e	Typical Cross-section of Elevated Bank Filtration Bed, Wet Pond	5-36
5.06f	Typical Subdivision Layout w/ Off-line Detention Pond	5-37
5.06g	Typical Cross-section of Elevated Sand Filter, Dry Pond	5-38
5.06h	Illustration of Bottom Filter or Underdrain System w/ Weir	5-39
5.06i	Rodent Protection for Outlet Pipes	5-39
5.06j	Flow Net Illustrating Seepage Through Typical Bank Filter	5-40
5.07a	Typical Waterway Shapes and Mathematical Expressions	5-42
5.07b	Typical Swale Block Cross-section	5-44
5.08a	Typical Waterway Cross-sections	5-48
5.08b	Typical Stone-lined Waterways	5-50
5.09a	Paved Flume	5-52
5.10a	Diversions	5-54
5.11a	Level Spreader	5-57
5.11b	Level Spreader Cross-section	5-58
5.12a	Log Check Dam	5-59
5.12b	Rock Check Dam	5-60

LIST OF PLATES (Continued)

Plate No.	Description	Page
5.12c	Spacing Between Check Dams	5-61
5.14a	Waterway Drop Structure	5-63
5.14b	Log Grade Stabilization Structure	5-64
5.14c	Waterway Drop Structure Details	5-66
5.15a	Typical Energy Dissipator - FDOT	5-67
5.15b	Typical Energy Dissipator - Riprap	5-68
5.15c	Pipe Outlet Conditions	5-69
5.15d	Paved Channel Outlet	5-70
5.16a	Rock-lined Channel	5-72
5.16b	Riprap Slope Protection	5-73
5.16c	Toe Requirements for Bank Stabilization	5-74
5.17a	Grid Confinement System	5-75
5.17b	Ease of Installation	5-76
5.17c	Vegetative Protection	5-78
5.17d	Gravity Retaining Wall	5-78
5.18a	Slope Protection	5-80
5.18b	Channel Bottom Protection	5-80
5.18c	Revegetation	5-82
5.18d	Grout Illustration	5-82
6.60a	Stair Stepped Slope	6-2
6.60b	Grooved or Serrated Slope	6-3
6.60c	Terraced Slope	6-4
6.60d	Roughening with Tracked Machinery	6-6
6.67a	Sodding	6-18
6.67b	Sodding Waterways	6-20
6.75a	Typical Orientation of Treatment 1 - Soil Stabilization Blanket	6-26
6.75b	Typical Treatment 1 - Soil Stabilization Blanket Installation Guide	6-28
6.75c	Erosion Blankets and Turf Reinforcement Mats - Slope Installation	6-29
6.75d	Typical Treatment 2 - Soil Stabilization Matting Slope Installation	6-30
6.75e	Erosion Blankets & Turf Reinforcement Mats - Channel Installation	6-31
6.75f	Typical Treatment 2 - Soil Stabilization Matting Installation	6-32
6.75g	Stakes, Staples, and Pins for Installation of Soil Stabilization Mats	6-33
6.75h	General Staple Pattern Guide and Recommendation - Treatment 2	6-34
6.80a	Benefits of Trees	6-36
6.80b	Spacing Trees for Safety and Effective Landscaping	6-38
6.80c	Planting Bare Root Seedlings	6-40
6.80d	Planting Balled & Burlapped, and Container-grown Trees	6-42
6.85a	Construction Operations Relative to Location of Protected Trees	6-43
6.85b	Fencing and Armoring	6-44
6.85c	Trenching vs. Tunneling	6-48
6.85d	Tree Care	6-49
6.85e	Tree Fertilization	6-50
6.98a	Typical Water Levels Correlated with Vegetative Zones	6-52
6.98b	Straw Wattles	6-56

LIST OF ABBREVIATIONS

AASHTO	American Association of State Highway and Transportation Officials
ASCE	American Society of Civil Engineers
ASTM	American Society for Testing and Materials
BCMP	Bituminous Coated Metal Pipe
BMP	Best Management Practice
CB	Catch Basin
c.f.s.	cubic feet per second (also cfs)
cm	centimeter
CMP	Corrugated Metal Pipe
CMU	Concrete Masonry Unit (Cinder Block)
CPESC	Certified Professional in Erosion and Sediment Control
d ₅₀	the average spherical equivalent diameter (of stone aggregate)
d _{max}	the maximum spherical equivalent diameter
EPA	United States Environmental Protection Agency
F.A.C	Florida Administrative Code
FDEP	Florida Department of Environmental Protection
FDOT	Florida Department of Transportation
FES	Florida Engineering Society
F.S.	Florida Statute
g	gram
GIS	Geographic Information Systems
ha	hectares
HDPE	High Density Polyethylene
IECA	International Erosion Control Association
i.d.	inside diameter
IFAS	Florida Institute of Food and Agricultural Sciences
K	kilogram
m	meter
MH	Man Hole
mm	millimeter
NRCS	Natural Resources Conservation Service
N.T.S	Not to scale
o.c.	on center
o.d.	outside diameter
P.E.	Professional Engineer
PVC	Poly Vinyl Chloride
RCP	Reinforced Concrete Pipe
SCS	Soil Conservation Service
SHWT	Seasonal High Water Table
SWCS	Soil and Water Conservation Society
USDA	United States Department of Agriculture
USLE	Universal Soil Loss Equation
USGS	United States Geological Survey
WMD	Water Management District

The Stormwater Inspector's Creed

As a Stormwater Inspector, I dedicate my professional knowledge and skill to the advancement and betterment of the environment, especially the protection and enhancement of Florida's water resources for future generations.

I Pledge:

- * To give the utmost effort in my personal performance.
- * To participate in none but honest enterprise.
- * To live and work according to the laws of humanity and the highest standards of professional conduct.
- * To work in partnership with all segments of Florida's citizenry toward the common goals of compliance.
- * To provide consistent and impartial implementation of the rules and regulations.
- * To place service before profit, the honor and standing of the profession before personal advantage, and the public welfare and environment above all other considerations.
- * To provide beneficial services which enhance the quality of life for Florida's citizens and visitors.
- * To generate growth of the profession through marketing, promotion, advertising, and implementation of sound environmental management practices.
- * To continue to monitor performance and maintenance of environmental management systems for the betterment of humankind.
- * To inspect environmental management systems using timely and adequate documentation, so that all apparent violations may be immediately investigated for necessary remedial action.

CHAPTER 1
EROSION & SEDIMENT CONTROL

1.1	THE EROSION PROCESS	1
1.2	IMPACTS OF SEDIMENTATION AND EROSION	5
1.3	PRINCIPLES OF EROSION AND SEDIMENT CONTROL	9

CHAPTER NOTE

The foundation of technical knowledge for all erosion control professionals is an understanding of the basic process and principles of erosion and sedimentation. This chapter presents a basic fundamental explanation of how soil erosion occurs, the effects of erosion and sedimentation, and the principles for controlling erosion and sedimentation.

1.1 THE EROSION PROCESS

Soil erosion is the process by which the land surface is worn away by the action of wind, water, ice and gravity. The process of soil erosion involves detachment of sediments from the soil mass, transportation primarily by flowing water or wind, and eventual deposition of sediment. Raindrops falling on bare or sparsely vegetated soil detach soil particles. Water flowing over the ground picks up the particles and carries them. As runoff gains velocity, it tends to form channels and detaches more soil particles. This action cuts rills and gullies into the soil, adding to the sediment load. Wind erosion is also a significant cause of soil loss, especially in peninsular Florida. Winds blowing across unvegetated, disturbed land pick up soil particles and carry them along. Additional information on wind erosion and its control is available from the Natural Resources Conservation Service (formerly the Soil Conservation Service).

Sedimentation is the settling out of the soil particles transported by water and wind. Sedimentation occurs when the velocity of water in which the soil particles are suspended is slowed to a sufficient degree, and for a sufficient period of time, to allow the particles to settle out of suspension. Heavier particles, such as sand and gravel, settle out more rapidly than do fine particles such as clay and silt.

Natural, or geologic erosion, has occurred at a relatively slow rate since the earth was formed. It is a major factor in creating the earth as we know it today. The great river valleys of the panhandle, the rolling farmlands and orchards of the central ridge, the productive estuaries, and the barrier islands of the coast are all products of geologic erosion and sedimentation. Except for some cases of shoreline and stream channel erosion, natural erosion occurs at a very slow and uniform rate; and is a vital factor in maintaining environmental balance. Geologic erosion produces about 30 percent of all sediment in the United States.

Accelerated erosion is the increased rate of erosion caused primarily by the removal of natural vegetation or alteration of the ground contour. This type of erosion accounts for 70 percent of all sediment generated in this country. Farming and construction are the principal causes of accelerated erosion, although any land disturbing activity can increase the natural erosion rate.

During the past 20 years, the importance of erosion control has come more to the forefront of the public's interest as well as the government's. Implementation of erosion control measures consistent with sound agricultural and construction operations is strongly desired to minimize the adverse effects associated with increased sediment yield. The increase in state and local regulatory programs, as well as an increased concern by the public for the environment, has resulted in the availability of a wide range of erosion control products, techniques, and analytical methodologies in the United States. In recent years particular emphasis has been placed on the restoration of vegetation as the preferred erosion control method.

TYPES OF EROSION

Soil erosion can be classified as either wind erosion or water erosion. Water erosion can be classified into overland erosion and stream and channel erosion.

A. Overland Erosion

Overland erosion occurs on denuded slopes as a result of raindrop splash and runoff. It includes sheet, rill, and gully erosion; and is the largest source of sediment during construction activities.

1. Raindrop Erosion

Erosion resulting from the impacts of raindrops which dislodges soil particles and splashes them into the air is referred to as raindrop erosion or splash erosion. These dislodged particles are then vulnerable to the next type of erosion.

2. Sheet Erosion

Sheet erosion is caused by shallow sheets of water flowing off the land. These broad moving sheets of water are seldom the detaching agent, but the flow transports soil particles detached by raindrop impact and splash. The shallow surface flow rarely moves as a uniform sheet for more than a few feet before concentrating in land surface irregularities.

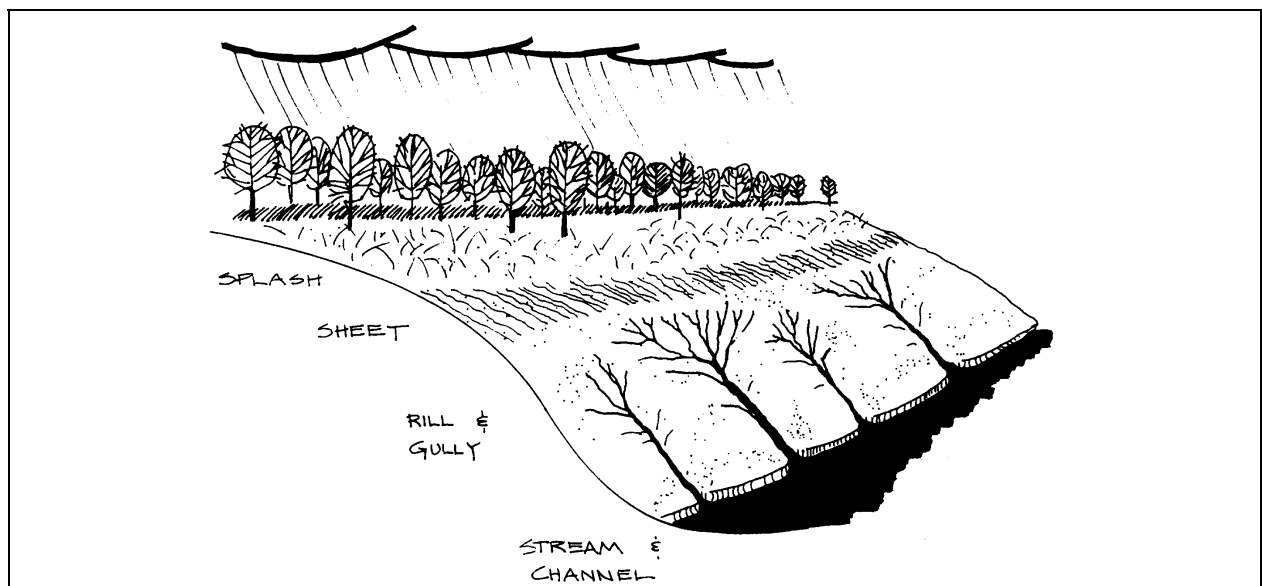

Plate 1.1 Types of Soil Erosion

Source: North Carolina Sedimentation Control Commission

3. Rill Erosion

Rill erosion develops as the shallow surface flow begins to concentrate in low spots. The concentrated flow increases in velocity and turbulence, which in turn causes the detachment and transport of more soil particles. This action cuts tiny well-defined channels called rills, which are usually only a few inches deep.

4. Gully Erosion

Gully erosion occurs as the flow in rills comes together in larger and larger channels. The major difference between this and rill erosion is size.

B. Stream Channel Erosion

Stream channel erosion occurs as the volume and velocity of flow increase sufficiently to cause movement of the streambed and bank materials.

FACTORS INFLUENCING EROSION

The inherent erosion potential of an area is determined by four principal factors: soil characteristics, vegetative cover, topography, and climate (rainfall). Although each of these factors is discussed separately, they are interrelated.

A. Soil Characteristics

Soil properties which influence erosion by rainfall and runoff are those which affect the infiltration capacity of a soil and those which affect the resistance of the soil to detachment and transport by flowing or falling water.

Four factors are important:

1. Soil texture (average particle size and gradation).
2. Percentage of organic content.
3. Soil structure
4. Soil permeability.

Soils that contain high percentages of silt and very fine sand are generally the most erodible. As the clay and organic matter content of these soils increase, the erodibility decreases. Clays act as a binder of soil particles and reduce erodibility. However, while clays have a tendency to resist erosion, once detached from the soil they are easily transported by water and settle out very slowly.

Organic matter is plant and animal residue in various stages of decomposition. Soils high in organic matter have a more stable structure which improves their permeability. Such soils resist raindrop detachment and absorb more rainwater, thus minimizing erosion.

Well-drained and well-graded gravels and gravel-sand mixtures are the least erodible soils. Coarse gravel soils are highly permeable and have a good absorption capacity which either prevents or delays, and thereby reduces, the amount of surface runoff.

The study of the soil characteristics which relate to soil erodibility is a complex, technical field. The Universal Soil Loss Equation (USLE) has been developed by the Natural Resource Conservation Service to help simplify the process. The equation is used to

determine soil erosion that will occur when using various conservation practices. However, the accuracy of the USLE in Florida is quite low. It is also not designed for quantifying sediment yields from construction sites. Further information about soils is found in Chapter 2.

B. Vegetative Cover

Vegetative cover plays an extremely important role in controlling erosion:

1. It shields the soil surface from the impact of falling rain.
2. It holds soil particles in place.
3. It maintains the soil's capacity to absorb water.
4. It slows the velocity of runoff.
5. It removes subsurface water through evapotranspiration.

By sequentially scheduling (staging) and limiting the removal of vegetation, and by decreasing the area and duration of exposure, soil erosion and sedimentation can be significantly reduced. Recent studies in Maryland indicate that these planning activities can reduce sediment loads by up to 90%. Special consideration should be given to the maintenance of vegetative cover on areas of high erosion potential such as erodible soils, steep or long slopes, stormwater conveyances, and the banks of streams.

C. Topography

The size, shape and slope characteristics of a watershed influence the amount and rate of runoff. Slope length and gradient are key elements in determining the volume and velocity of runoff and the erosion risks. As both slope length and gradient increase, the velocity and volume of runoff increases and the erosion potential is magnified. Slope orientation can also be a factor in determining erosion potential.

D. Climate (Rainfall)

The frequency, intensity, and duration of rainfall are fundamental factors in determining the amount of runoff. As both the volume and the velocity of runoff increases, the capacity of runoff to detach and transport soil particles also increases. When storms are frequent, intense, or of long duration, erosion risks are high. Seasonal changes in rainfall and temperature define the high erosion risk period of the year.

Land disturbing activities should be scheduled to take place during periods of low precipitation and low runoff. Exposed areas should be stabilized before the period of high erosion risk. Generally, Florida's wet season occurs from May to November, with a dry season from November to May. Check with your local Water Management District or Florida Department of Transportation office for more precise information in your area.

1.2 IMPACTS OF SEDIMENTATION AND EROSION

Sedimentation is the deposition of detached particulate matter which has been eroded or otherwise detached from its source and transported by flowing water or wind. If the available energy of the water is greater than the burden of the sediment load being transported, the moving water will erode the soil to obtain additional sediment. If the load is greater than the available energy, deposition of some of the transported material will occur. Normally, runoff builds up rapidly to a peak and then diminishes. Excessive quantities of sediment are derived by erosion principally during the higher flows. During lower flows, as the velocity of runoff decreases, the transported materials are deposited only to be picked up by later peak flows. In this way, sediments are carried downstream intermittently and progressively from their source. For instance, a study of sedimentation from highway construction and land development in Virginia indicated that 99 percent of the sediment discharge occurred during periods of high flow which took place during only 3 percent of the period of measurement (Vice et al., 1969).

SEDIMENT DAMAGE

Over four billion tons (3.6 billion metric tons) of sediment are estimated to reach the ponds, rivers and lakes of our country each year, and approximately one billion tons (0.9 billion metric tons) of this sediment are carried all the way to the ocean. Approximately, 10 percent of this amount is contributed by erosion from land undergoing highway construction or land development (SCS, 1980). Although 10 percent may appear to be small compared to the total, it can represent more than one-half of the sediment load carried by many streams draining small sub-watersheds undergoing development.

Sediment yields in streams flowing from established urbanized drainage basins vary from approximately 200 to 500 tons per square mile per year (70 to 175 metric tons/km²). In contrast, areas actively undergoing urbanization often have a sediment yield of from 1,000 to 100,000 tons/mile²/yr (350 to 3,500 metric tons/km²/yr) (USGS, 1968). It is easy to comprehend the tremendous quantity of sediment reaching our streams and rivers annually since development is begun on an estimated 4,000 to 5,000 acres (1,620 to 2,025 hectares) of land throughout the country every day. This includes development for housing, industrial site and highway construction (U.S. Census, 1987). For very small areas, where construction activities have drastically altered or destroyed vegetative cover and the soil mantle, sediment derived from one acre of land may be 20,000 to 40,000 times that obtained from adjacent undeveloped farm or woodland areas.

Sediment deposition occurs as the velocity of a sediment-transporting stream decreases. This is particularly important in Florida where nearly all streams have low gradients and low velocities. Deposition, rather than transport, is therefore the dominant process in most Florida aquatic systems.

Excessive quantities of sediment result in costly damage to aquatic areas and to private and public lands. Obstruction of stream channels and navigable rivers by masses of deposited sediment reduces hydraulic capacity. This, in turn, causes an increase in flood crests resulting in flood damages. Sediment fills stormwater conveyances and plugs culverts and stormwater systems thus necessitating frequent and costly maintenance. Municipal and industrial water supply reservoirs lose storage capacity, the usefulness of

recreational impoundments is impaired or destroyed; navigable channels must continually be dredged; and the cost of filtering muddy water in preparation for domestic or industrial use becomes excessive. The added expense of water purification in the United States amounts to millions of dollars each year.

The biological effects of sedimentation are even more critical. The overall consequence of fine grained sediments (clays, silts and fine sands) in an aquatic system is to reduce both the kinds and the amounts of organisms present. Sediments alter the aquatic environment by screening out sunlight and by changing the rate and the amount of heat radiation. This light reduction inhibits photosynthesis, leading to a decline in benthic plant growth. Consequently, the food chain is disrupted and the population of consumer species is reduced. This frequently results in an alteration of species and their eggs. The elimination or reduction of benthic organisms decreases the number and variety of food sources for fish, further disrupting the food chain and causing fish to either starve or move away. A moderate concentration of sediment can impair fish spawning, while a high concentration clogs the gills of fish and invertebrates. The result may be that clear water bodies that once supported populations of game fish, such as bass and bream, become muddied and inhabited by more tolerant "trash" fish such as carp or suckers.

Coarser-grained materials also blanket bottom areas and suppress aquatic life found on and in these areas. Where currents are sufficiently strong to move the bedload, the abrasive action of these materials accelerates channel scour caused by, or associated with, higher flood stages induced by sedimentation.

EROSION AND SEDIMENT HAZARDS ASSOCIATED WITH LAND DEVELOPMENT

The principal effect land development activities have on the natural or geologic erosion process consists of exposing disturbed soils to precipitation and to surface storm runoff. Shaping of land for development alters the land cover and the soil in many ways. These alterations often detrimentally affect on-site stormwater patterns and, eventually, off-site stream and streamflow characteristics. Protective vegetation is reduced or removed, excavations are made, topography is altered, the removed soil material is stockpiled -- often without protective cover, and the physical properties of the soil itself are changed.

The development process is such that many people may be adversely affected even by a small development project. Uncontrolled erosion and sediment from these areas often cause considerable economic damage to individuals and to society in general. Hazards associated with development include:

1. A large increase in areas exposed to stormwater and soil erosion.
2. Increased volumes of stormwater, accelerated soil erosion and sediment yield and higher peak flows caused by:
 - a. Removal of existing protective vegetative cover.
 - b. Exposure of underlying soil or geologic formations less pervious and/or more erodible than original soil surface.

- c. Reduced capacity of exposed soils to absorb rainfall due to compaction caused by heavy equipment.
 - d. Enlarged drainage areas caused by grading operations, diversions and street construction.
 - e. Prolonged exposure of disturbed areas which are left unprotected due to scheduling problems or delayed construction.
 - f. Shortened times of concentration of surface runoff caused by altering steepness, distance and surface roughness and through installation of "improved" storm drainage facilities.
 - g. Increased impervious surfaces such as streets, buildings, sidewalks and paved driveways and parking lots.
3. Alteration of the ground water regime that may adversely affect stormwater systems, slope stability, and the survival of existing or newly established vegetation.
 4. Creation of exposures facing south and west that may hinder plant growth due to adverse temperature and moisture conditions.
 5. Exposure of subsurface materials that are rocky, acid, droughty or otherwise unfavorable to the establishment of vegetation.
 6. Adverse alteration of surface runoff patterns by construction and development.

This page left intentionally blank

1.3 PRINCIPLES OF EROSION AND SEDIMENT CONTROL

For an erosion and sediment control program to be effective, it is imperative that provisions for control measures be made in the planning stage. These planned measures, when conscientiously and expeditiously applied during construction, will result in orderly development without environmental degradation and with cost savings. The following principles should be used to the maximum extent possible.

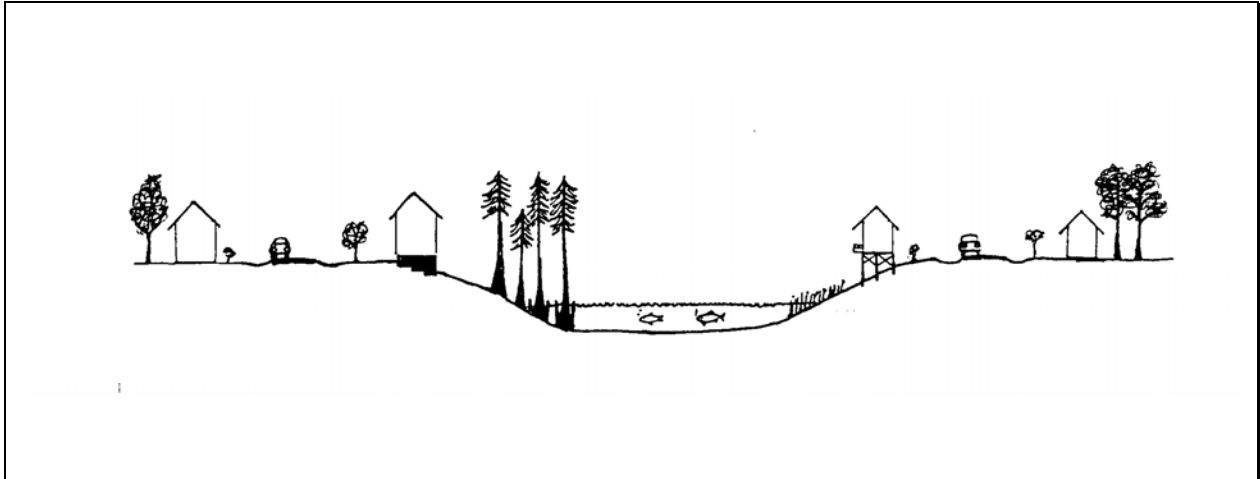

Plate 1.3a Fit the Development to the Terrain

1. Plan the development to fit the particular topography, soils, drainage patterns and natural vegetation of the site.

Detailed planning should be employed to assure that roadways, buildings and other permanent features of the development conform to the natural characteristics of the site. Large graded areas should be located on the most level portion of the site. Slope length and gradient are key elements in determining the volume and velocity of runoff and its associated erosion. As both slope length and steepness increase, the rate of runoff increases and the potential for erosion is magnified. Where possible, steep vegetated slopes should be left undisturbed. Areas with slope and soils limitations should not be used unless sound conservation practices are employed. For instance, where it is necessary to build on long steep slopes, the practices of benching, terracing, or constructing diversions should be used. Areas subject to flooding should be avoided or used as part of the stormwater management system. Flood-plains should be kept free from filling and construction activities since they temporarily store excess runoff, thereby helping to avoid erosion and flooding problems downstream. Erosion control, development, and maintenance costs can be minimized by selecting a site suitable for a specific proposed activity, rather than by attempting to modify a site to conform to that activity. This kind of planning can be more easily accomplished where there is a general land use plan based upon a comprehensive inventory of soils, water, and other related resources.

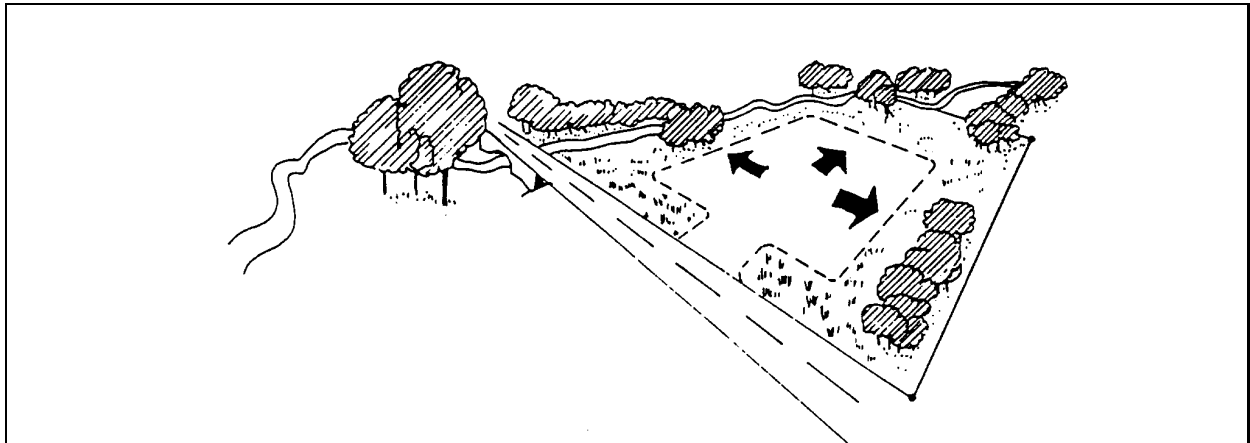

Plate 1.3b Minimize the Extent and Duration of Exposure

Source: North Carolina Sedimentation Control Commission

2. Minimize the extent of the area exposed at one time and the duration of exposure.

When land disturbances are required and the natural vegetation is removed, keep the area and the duration of exposure to a minimum. Plan the stages of development so that only the areas which are actively being developed are exposed. All other areas should have a good cover of either temporary or permanent vegetation, or mulch. Grading should be completed as soon as possible after it has begun. Immediately after grading is completed, a permanent vegetative cover should be established. As cut slopes are made and as fill slopes are brought up to grade, these areas also should be revegetated. This is known as staged revegetation. Minimizing grading of large or critical areas during the rainy season (time of maximum erosion potential) reduces the risk of erosion.

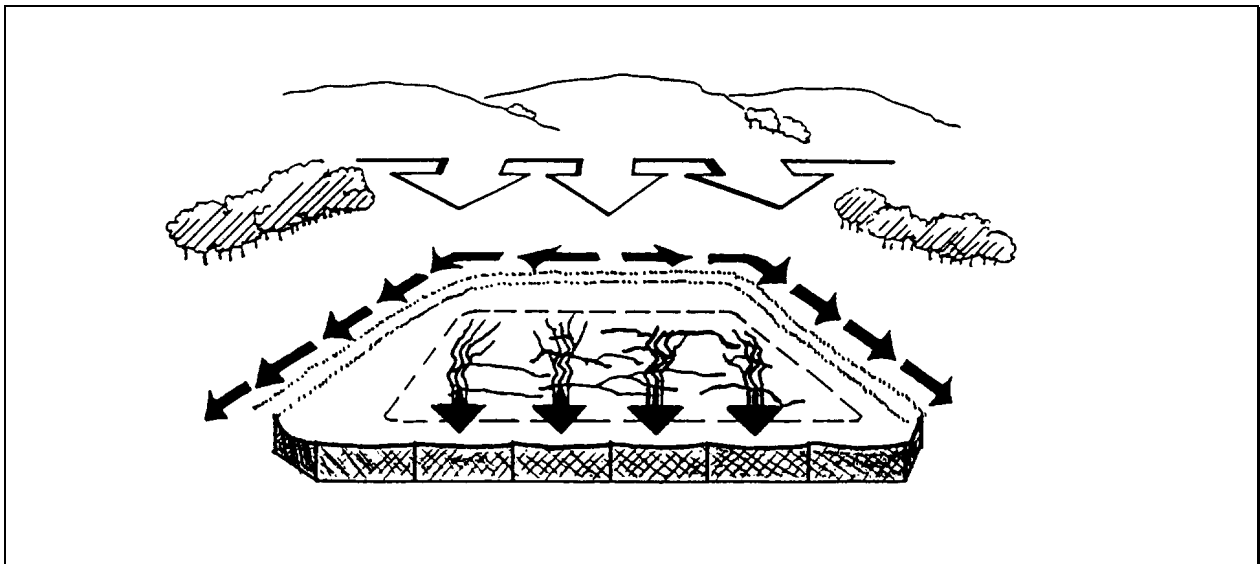

Plate 1.3c Apply Perimeter Controls

Source: Adapted from North Carolina Sedimentation Control Commission

3. Apply perimeter control practices to protect the disturbed area from offsite runoff and to prevent sedimentation damage to areas below the development site.

This principle relates to using practices that effectively isolate the development site from surrounding properties, and especially to controlling sediment once it is produced thereby preventing its transport from the site. Diversion, dikes, sediment traps, vegetative filters, and sediment basins are examples of practices to control sediment. Vegetative and structural sediment control measures can be classified as either temporary or permanent depending on whether or not they will remain in use after development is complete. Generally, sediment can be retained by two methods: (a) filtering runoff as it flows through an area and (b) impounding the sediment-laden runoff for a period of time so that the soil particles settle out. The best way to control sediment, however, is to prevent erosion as discussed in the fourth principle.

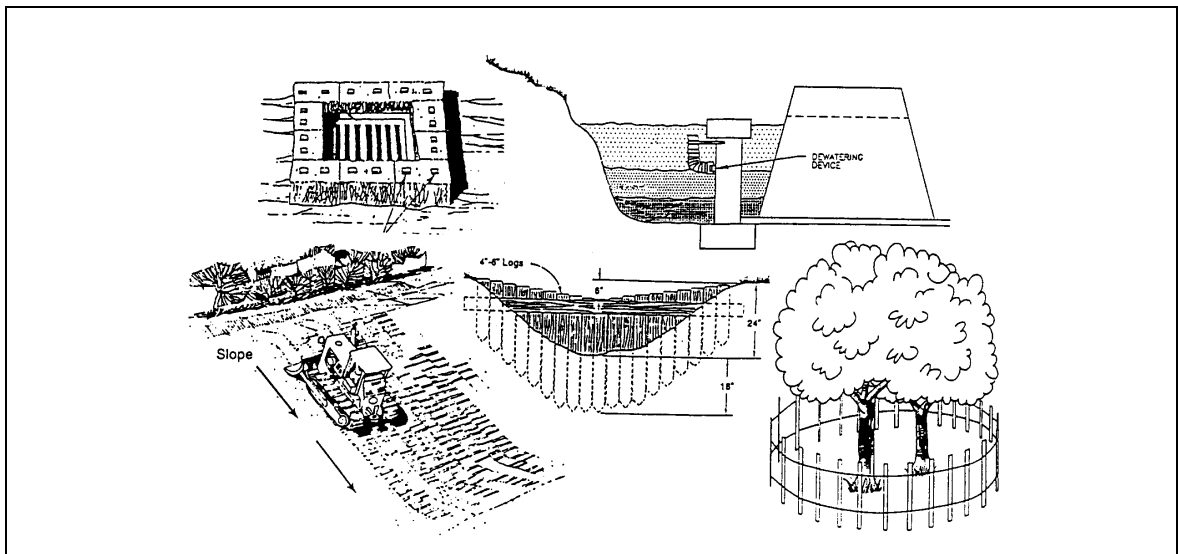

Plate 1.3c Apply erosion control practices on site
Source: Adapted from Florida Development Manual

4. Apply erosion control practices to prevent excessive on-site damage.

This fourth principle relates to using practices that control erosion on a site to prevent excessive sediment from being produced. Keep soil covered as much as possible with temporary or permanent vegetation, or with various mulch materials. Special grading methods such as roughening a slope on the contour or tracking with a cleated dozer may be used. Other practices include diversion structures to direct surface runoff from exposed soil and grade stabilization structures to control surface water. "Gross" erosion in the form of gullies must be prevented by these water control devices. Lesser types of erosion, such as sheet and rill erosion, should be prevented, but often scheduling or the large number of practices required makes this impractical. However, when erosion is not adequately controlled, sediment control is more difficult and expensive.

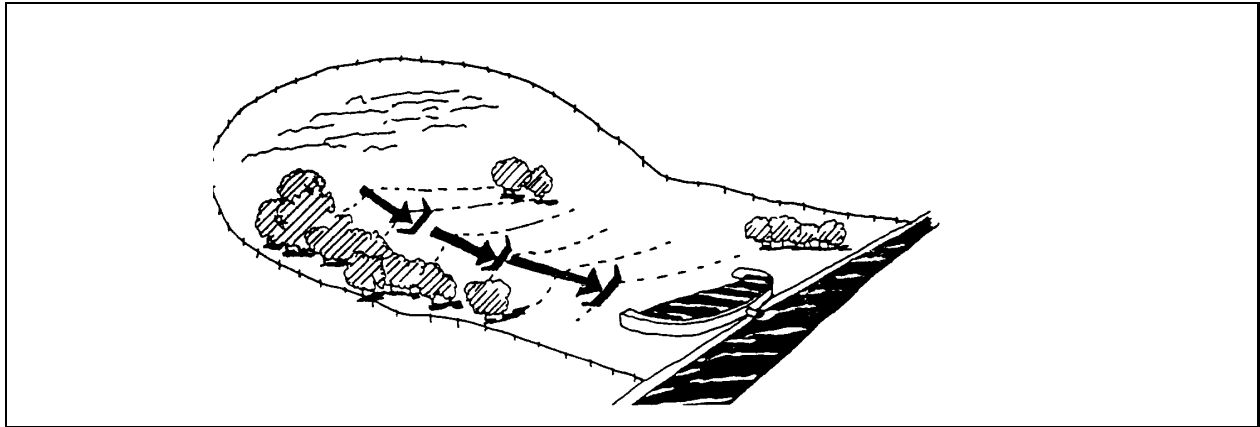

Plate 1.3e Keep Runoff Velocities low

Source: North Carolina Sedimentation Control Commission

5. Keep runoff velocities low and retain runoff on the site.

The removal of existing vegetative cover and the resulting increase in impermeable surface area during development will increase both the volume and velocity of runoff. These increases must be taken into account when providing for erosion control. Keeping slope lengths short and gradients low, and preserving natural vegetative cover can keep stormwater velocities low and limit erosion hazards. Runoff from the development should be safely conveyed to a stable outlet using storm drains, diversions, stable waterways or similar measures. Consideration should be given to the installation of stormwater detention structures to prevent flooding and damage to downstream facilities resulting from increased runoff from the site. Conveyance systems should be designed to withstand the velocities of projected peak discharges. These facilities should be operational as soon as possible after the start of construction.

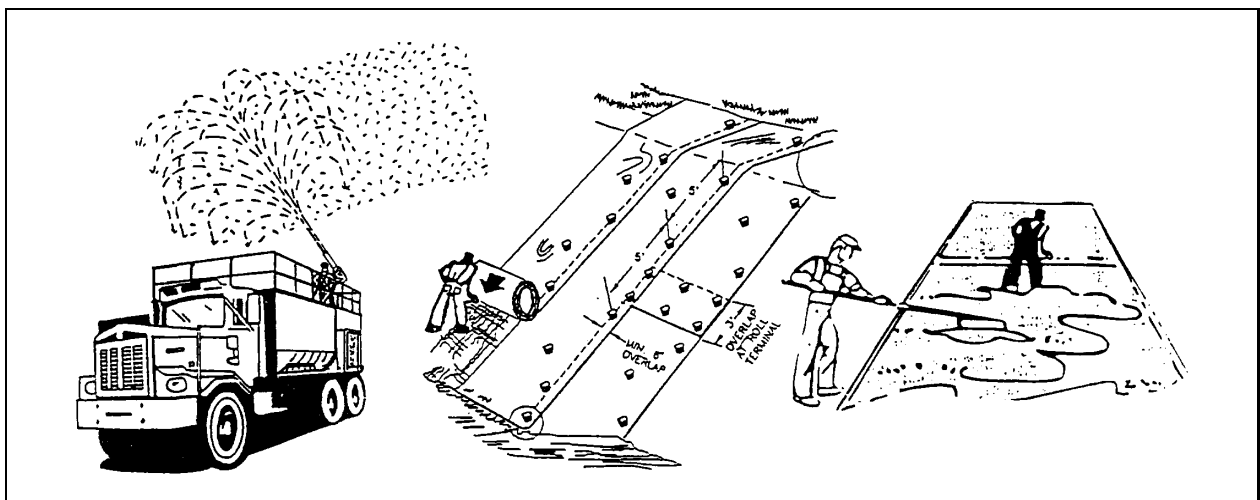

Plate 1.3f Stabilize Disturbed Areas

6. Stabilize disturbed areas immediately after final grade has been attained.

Permanent structures, temporary or permanent vegetation, and mulch, or a combination of these measures, should be employed as quickly as possible after the land is disturbed. Temporary vegetation and mulches can be most effective under conditions where it is not practical to establish permanent vegetation. Such temporary measures should be employed immediately after rough grading is completed if a delay is anticipated in obtaining finished grade. The finished slope of a cut or fill should be stable and ease of maintenance should be considered in the design. Stabilize roadways, parking areas, and paved areas with gravel sub-base whenever possible.

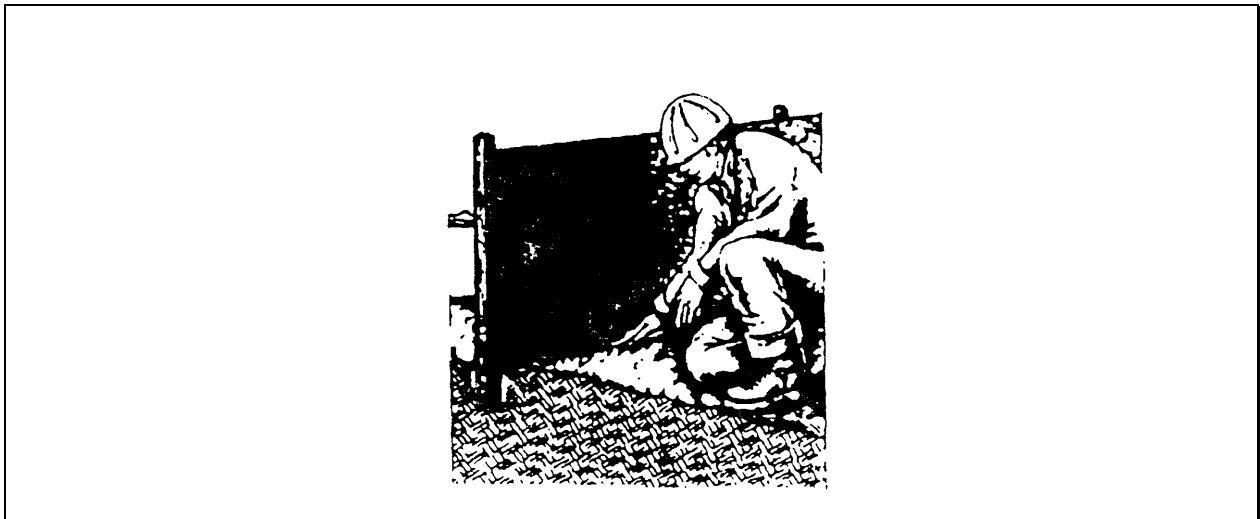

Plate 1.3g Begin Maintenance

Source: Siltco Product Literature

7. Implement a thorough maintenance and follow-up program.

This last principle is vital to the success of the six other principles. A site cannot be effectively controlled without thorough, periodic inspections of the erosion and sediment control practices. These practices must be maintained just as construction equipment must be maintained and materials checked and inventoried.

An example of applying this principle would be to start a routine "end of day check" to make sure that all control practices are working properly.

Usually, these seven principles are integrated into a system of vegetative measures and structural measures along with management techniques to develop a plan to prevent erosion and control sediment. In most cases, a combination of limited grading, limited time of exposure and a judicious selection of erosion control practices and sediment trapping facilities will prove to be the most practical method of controlling erosion and the associated production and transport of sediment.

REFERENCES

Florida Department of Environmental Regulation, 1988, The Florida Development Manual: A Guide to Sound Land and Water Management (Chapter 3). Tallahassee, FL

North Carolina Sedimentation Control Commission, 1988, Erosion and Sediment Control Planning and Design Manual. Raleigh, NC

CHAPTER 2 SOILS

2.1	INTRODUCTION TO SOILS	1
2.2	CLASSIFICATION AND PROPERTIES	3
2.3	ESTIMATING SOIL LOSS	9
2.4	SOIL SURVEYS	11

CHAPTER NOTE

Effectively preventing erosion and minimizing sedimentation depends on understanding the characteristics of soils. This chapter describes the basic characteristics of soils and the factors which govern soil erosion.

2.1 GENERAL OVERVIEW

Soils form in response to the interaction of five soil forming factors. These factors are climate, relief, organisms, parent material, and time. Soils form in the parent material, known as the C horizon. (See Plate 2.1) Marine sands, weathered limestone, and organic deposits are the common parent materials found in Florida soils. A soils profile develops as parent material is transformed into soil by the soil forming processes. Accumulation of organic matter in O and A horizons, leaching of nutrients from the A and E horizons, and the translocation and synthesis of clay to form B horizons are examples of soil forming processes that create horizons (layers) within a profile. A soil profile has two or more horizons. Young soils (A over C horizons) are common in Florida. A soil is said to mature, or age, as the B horizon accumulates clay. Spodic horizons are B horizons that have an accumulation of organics, iron, and aluminum from the overlying soil. Soils with spodic horizons are common in Florida. Soil horizons can differ in chemical and physical properties, such as thickness, texture, color, organic matter, fertility, pH, etc.

On a volume basis, an average topsoil (A horizon) is 45% minerals, 5% organic matter, 50% pore space. With depth, organic matter, porosity, and permeability decrease. The topsoil has the greatest plant and microbial activity. The topsoil is important as a seedbed, a reservoir for nutrients and water, and in the exchange of gases between the subsoil and atmosphere.

The topsoil is the horizon most vulnerable to erosion and human activities. Geologic erosion is a natural and on-going process. An equilibrium between erosion and topsoil formation is established for each landscape position. The soil loss tolerance (T value) is an estimate of the maximum amount of annual erosion that a soil can tolerate without a decrease in crop yield. Some of our most fertile regions are flood plain soils which were deposited from eroded upland topsoil. However accelerated erosion due to human activities has detrimental impacts on-site and downstream. Soil behavior and morphology change in response to any change in the five soil forming factors.

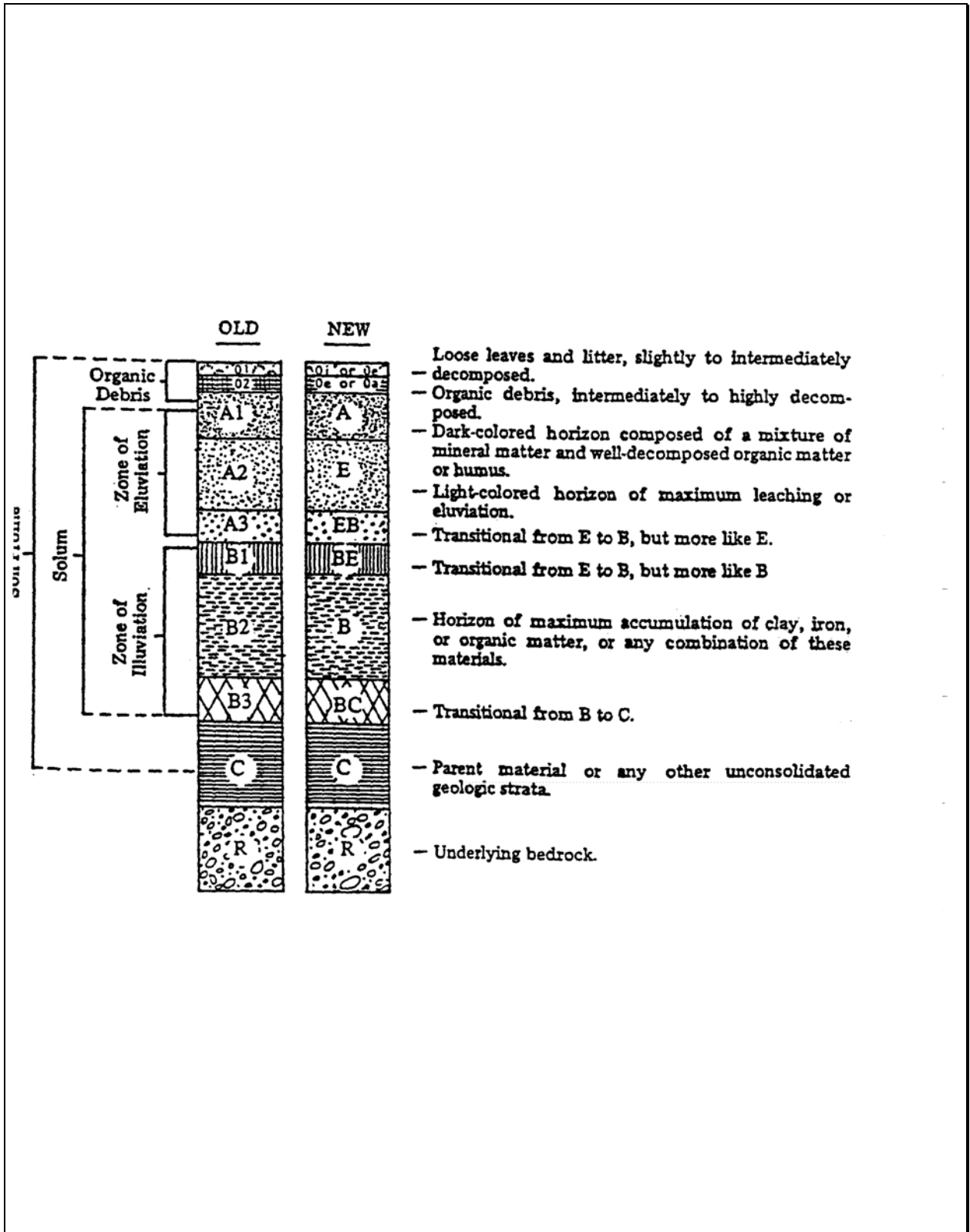

Plate 2.1 Soil Profile with Common Horizon Designations

Source: Collins and Carlisle, 1984

2.2 CLASSIFICATION AND PROPERTIES

SOIL CLASSIFICATION

Soil engineers and agricultural scientists describe the properties of soils differently because their interests are substantially different. Both soil and civil engineers are familiar with the unified and the American Association of State Highway and Transportation Officials (AASHTO) systems that focus on the engineering properties of soils. These classifications are based on the physical properties of the soil. Initially, soils are described as either coarse- or fine-grained. Coarse-grained soils are further described by degree of sorting of particle sizes. Fine-textured soils are further distinguished by their liquid and plasticity limits. Particle size analysis is not usually performed. In contrast, the U.S. Department of Agriculture (USDA) system of soil classification used by the U.S. Natural Resources Conservation Service (NRCS) is directed at characteristics of soils important for agricultural uses, such as texture, organic matter, and nutrient content. A particle size analysis is necessary before a soil can be classified by using the USDA system. In the Universal Soil Loss Equation (USLE), since it was originally developed for use in agricultural areas, the USDA system is used.

A. Soil Texture

Soil texture depends on the proportions (by weight) of sand, silt, and clay in a soil—often referred to as the particle size distribution. Table 2.1 lists the USDA particle size classes. A triangle is used to present the soil texture names according to particle size content. (See Plate 2.2) The percentages of sand, silt, and clay in a soil add up to 100. By knowing any two components, one can find the texture name for the soil. For example, a soil with 40 percent sand and 40 percent silt is called a loam. A loam also contains 20 percent clay. A sample with 20 percent sand and 60 percent silt is called a silt loam, whereas one with 60 percent sand and 30 percent silt is called a sandy loam.

Table 2.1 USDA Particle Size Classes

<u>Particle Name</u>	<u>Size (mm)</u>
Gravel	> 2.0
Sand	2.0 - 0.1
Very Fine Sand	0.1 - 0.05
Silt	0.05 - 0.002
Clay	< 0.002

In the bottom part of Plate 2.2 the USDA, unified, and AASHTO classification systems are compared. Note the size in each system that differentiates silt from sand; the engineering systems change the classification at 0.74 mm, the USDA system at 0.05 mm. This difference is important because the silt and very fine sand particles in this size range are most susceptible to erosion and are therefore of interest in erosion control planning. The particle size also is important because the ability of a sediment basin to trap soil is primarily related to particle size. The smaller the particle, the larger the basin must be to capture it. Each sediment basin should be designed to capture a certain size particle called the *design particle*. If a soils analysis is to be done on a site, the site planner should request that the design particle size be a threshold in the analysis (i.e., specify the percent, by

weight, of particles larger or smaller than that size).

Sandy soils generally have a higher permeability than fine-textured soils. The amount of runoff is lower; and since the particles are relatively large (and thus heavy), they are not carried far in any runoff that does occur. Sand particles will settle out of runoff at the bottom of a slope or in a channel with a gentle slope. Very fine sand particles, however, behave like silt particles.

Silt is the most important particle size class when soil erodibility is evaluated. The higher the silt content, the more erodible a soil is. Silt-sized particles are small enough to reduce the permeability of a soil and are also easily carried by runoff. Control measures should be designed to prevent the erosion of silt, or at least to contain it on-site.

Clay is the smallest particle size class. A soil with a high clay content tends to be quite cohesive -- the particles stick together in clumps. Runoff does not pick up clay particles as easily as it does silt. However, once clays are suspended in runoff, they will not settle out until they reach a large, calm water body. These very small particles have so low a settling velocity that they will be carried long distances until still water is reached or until salt water increases precipitation by causing them to clump together again in aggregates.

It is easiest to prevent erosion of sandy soils. Silts are most susceptible to erosion, but they can be recaptured on-site by applying the control measures described in Chapter 4. Clays are the most difficult to trap once erosion has occurred, so control measures must focus on preventing their erosion in the first place.

Although texture is a principal soil characteristic affecting erodibility, three other characteristics have a strong influence on erosion potential. They are organic matter, soil structure, and permeability.

1. Organic Matter

Organic matter within a soil is mostly decomposed plant and animal litter. It consists of colloidal particles as small as and smaller than clay particles. This kind of organic matter helps bind the soil particles together, improves soil structure, and increases permeability and water-holding capacity. Soils with organic matter are less susceptible to erosion and more fertile than soils without organic matter. On a construction site, where extensive grading has removed the original topsoil and exposed layers of earth that have no plant roots growing in them, the organic matter content will be nil. Such subsoils are likely to be more erodible and less fertile than surface soils.

In another sense of the term, organic matter means plant residue, or other organic material that is applied to the soil surface. Surface-applied mulch reduces erosion by reducing the impact of raindrops, and by absorbing water and reducing runoff. It provides a more hospitable environment for plant establishment, and it eventually decomposes and improves the structure and fertility of the soil. The uses of mulch in erosion control are described in Chapter 6.

2. Soil Structure

Soil structure refers to the arrangement of particles in a soil. In an undisturbed soil with established vegetation, organic matter binds the particles into clumps called aggregates. It thereby produces what is called a granular structure, which is desirable because permeability and water-holding capacity are increased and the clumped particles are more resistant to erosion. Grading and compaction of soils during construction destroys the natural structure, reduces permeability, and increases runoff and erodibility. The direct impact of raindrops on a soil unprotected by mulch or vegetation also breaks up soil aggregates and increases erodibility.

3. Soil Permeability

Soil permeability refers to the ability of the soil to allow air and water to move through it. Permeability classes are listed in Table 2.2. Soil texture, structure, and organic matter all contribute to permeability. Sites with highly permeable soils absorb more rainfall, produce less runoff, are less susceptible to erosion, and support plant growth more successfully.

Table 2.2 USDA Soil Permeability Classes

<u>Class</u>	<u>Permeability</u>	<u>Estimated inches / hour through saturated, undisturbed cores under 1/2 in. head of water.</u>
	Very Slow	< 0.06
	Slow	0.06 - 0.2
	Moderately Slow	0.2 - 0.6
	Moderate	0.6 - 2.0
	Moderately Rapid	2.0 - 6.0
	Rapid	6.0 - 20
	Very Rapid	> 20

One disadvantage of higher permeability relates to slope stability. Graded areas must meet certain standards of compaction to ensure a stable foundation surface. Compaction reduces the permeability of the soil. Infiltration of water into a large fill is **not** desirable because it may reduce the fill's stability. Yet by reducing infiltration, surface runoff and surface erosion are increased. When grass is planted on these fills and paved diversion ditches are installed midslope to carry away excess runoff, surface erosion is reduced.

B. Soil Hydrologic Group

The hydrologic soil group is a direct reflection of the infiltration rate of the soil. The hydrologic soil groups, according to their infiltration and transmission rates are as follows:

- A. Soils having high infiltration rates even when thoroughly wetted. (Low runoff potential)
- B. Soils having moderate infiltration rates when thoroughly wetted.
- C. Soils having slow infiltration rates when thoroughly wetted.
- D. Soils having very slow infiltration rates when thoroughly wetted. (High runoff potential)

SOIL PROPERTIES

Among the characteristics of a soil type are permeability, infiltration, seasonal wetness, depth to the water table, depth to bedrock, texture, shrink-swell potential, erodibility, and slope. Variations in soil properties affect its ability to support heavy loads, to serve as a medium for wastewater or solid waste disposal, to percolate rainwater, to hold its shape and slope after excavation, or to grow vegetation. The qualities relevant to any particular site should be known for planning purposes. Selected soil characteristics are described below:

A. Erodibility

The major soil consideration from an erosion and sediment control standpoint is its erodibility. An erodibility factor (K) indicates the susceptibility of different soils to the forces of erosion. A soil survey report includes the K factor for each soil survey area. These K factors are used in the USLE to determine soil loss from an area over a period of time due to splash, sheet, and rill erosion. K factors in Florida range from about 0.10 (lowest erodibility) to about 0.49 (highest erodibility). K factors can be grouped into three general ranges:

- 0.23 and lower - low erodibility
- 0.23 to 0.36 - moderate erodibility
- 0.36 and up - high erodibility

Cohesiveness of soil particles varies within different layers of the same soil, causing varying degrees of erodibility at different depths. Therefore, depth of excavation must be considered in determining soil erodibility on a construction site.

B. Slope

Slope ranges are recorded in soil surveys, and areas where cuts and fills should be avoided can be identified by studying soil maps. The longer and steeper the slope is, the greater is the potential for soil loss due to increased velocity of surface runoff.

C. Shrink-Swell Potential

Certain soils have clays that shrink when dry and swell when wet. In this situation, special foundations are required to allow for this variation. By consulting the soil survey, soils with these problems can be identified and the necessary precautionary steps can be taken. It should be kept in mind, however, that soil surveys do not always reflect geologic phenomena in the zone beneath the soil; thus, when shrink-swell conditions occur only deep in the soil profile, the soil survey may not be a good guide.

D. Flood Hazard

Although soil survey information does not take the place of hydrologic studies, it does provide estimates of where floods are most likely to occur. The hazards of flooding and ponding are rated in soil surveys, and flood-prone areas are shown on soil maps.

E. Soil Reaction (pH)

Soil survey information includes the pH of the individual layers of each soil. This factor is useful when planning the establishment of vegetation on a construction site.

F. Wetness

Among the many types of data available in soil surveys are natural soil drainage, depth to seasonal water table, and suitability for winter grading of various kinds of soils. With this information, engineers can determine such things as seasonal limitations on the use of heavy earthmoving machinery, the estimation of flood hazards, or damage to underground structures due to soil wetness.

G. Depth to Bedrock

Soil surveys indicate bedrock types and in what areas they will be encountered at a depth of less than 5 to 6 feet (1.75 - 2.0 m). This information is very helpful in determining suitable locations for stormwater management facilities, or time and cost of excavation.

2.3 ESTIMATING SOIL LOSS

Soil conditions are a principal factor in determining the erosion potential of a site. Soil loss estimates have three important applications for erosion control planning:

1. Identify erosion prone areas on site
2. Estimate volume of sediment storage needed in a sediment basin
3. Compare the effectiveness of different control measures

There are several methods that are available for estimating soil loss. They range from simple, qualitative models to elaborate watershed simulations. Qualitative models rely on subjective evaluation of a series of criteria. Watershed simulation models are very theoretical. The Universal Soil Loss Equation (USLE) is an empirical model developed by the USDA. A more recent USDA manual, "Predicting Rainfall Erosion Losses - A Guide to Conservation Planning" includes useful information about the use of this equation on construction sites.

There are six major factors that affect soil loss according to USLE:

$$A = R \times K \times L \times S \times C \times P$$

Where:

A = Average annual soil loss, tons/acre

R = Rainfall erosion index, in 100 ft.tons/acre-in/hr

K = Soil erodibility factor, tons/acre per unit of R

L = Slope factor for length of slope, dimensionless

S = Slope factor for percentage of slope, dimensionless

C = Vegetative cover factor, dimensionless

P = Erosion control practice factor, dimensionless

The soil loss factor, A, is an estimated annual average, that is, it is an estimate of soil eroded from the site in an average year. When an estimate of required sediment storage volume is needed, the units of weight can be converted to volume by assuming a density for the sediment. If a drainage area contains more than one soil type, it should be subdivided into areas of homogeneous soil type. Soil loss should be calculated separately for each homogeneous area, and the estimates should then be added together. The rainfall erosion index, is the only factor that is outside of the developers' control. The discussion of each of the variables is presented below.

Rainfall Erosion Index, R, is a measure of the erosive force and intensity of rain in a normal year. Values of R have been computed for the continental USA from rainfall records and probability statistics. For Tallahassee, R value is about 500. However, for estimating annual soil loss, values of R exceeding 350 are not recommended by the NRCS. With the high value of R in Florida, greater attention to erosion control practices is required during construction activities.

Soil Erodibility factor K, is a measure of soil's susceptibility to detachment and transport by rainfall and runoff. The principal factor affecting K is texture, and its value ranges from 0.02 to 0.69. An example of using this table to minimize erosion during construction would be to limit the cuts into "Blanton" soil to no more than about 4.3 ft. (1.3 m), or to the relatively clayey subsoil, whichever is encountered first. Cuts greater than 4.3 ft. (1.3 m) would expose soil having an erosion potential of almost double that of the soil at shallow depth.

The Slope length and Gradient factors, L and S, describe the combined effect of slope length and slope gradient. It is the ratio of soil loss per unit area on a site to the corresponding loss from a 72.6-ft. long experimental plot with a 9% slope. Slope gradient can be expressed in either % or as a ratio of horizontal to vertical height. Slope length is the distance of the overland flow to the nearest diversion or channel. For a long slope with several midslope diversions, use the slope length equal to the distance from the top of the slope to the first bench or distance between benches, whichever is greater. These values are only suitable for constantly sloping terrain. For irregular shapes, results of the soil loss calculation will be more accurate if the slope is divided into segments. The factor is calculated for each segment of a site with similar slopes, and the individual estimates then summed up.

Vegetative Cover factor, C, is the ratio of soil loss from land under specified types of cover to the corresponding loss from tilled bare soil. The C factor reduces the estimated soil loss according to the effectiveness of vegetation and mulch cover. On construction sites, when estimating soil loss, a value of 1 is recommended for determining worst case situations. In situations where temporary control practices are used during construction period (such as seeding of grasses and use of mulches), values of C can be adjusted.

Erosion Control Practices factor, P, accounts for control practices that reduce the erosion potential of the runoff by reducing the runoff velocity and the tendency of runoff to flow directly down slope. In construction site application, P reflects the roughening of the soil surface by tractor treads or by rough grading, raking, or discing. Since all the values of P are close to 1, changing the surface condition does not provide much direct reduction in soil loss. However, roughening the soil surface is essential before seeding because it greatly increases plant establishment and thus reduces the C factor.

Of all the factors in the USLE, slope length and gradient (LS), cover C, and surface condition P are factors that can be manipulated by the developer, and the LS and C values are the most significant. Computing these factors provides a clue to site susceptibility to erosion and suggest means of controlling it. The effectiveness of each erosion control measure can therefore be compared. Caution is advised in applying the USLE to construction sites. The equation was developed primarily for use in agricultural fields. The equation should not be relied upon to make highly quantitative estimates of soil loss on other types of land. A more precise equation, the Modified Universal Soil Loss Equation (MUSLE) can be used to calculate the sediment yield, in tons, from a drainage basin due to a given storm event. Nevertheless, the USLE does help us to understand the principles governing soil erosion and can be very useful in estimating relative rates of soil erosion in response to alternate erosion control practices.

2.4 SOIL SURVEYS

In many instances, a major soil-related problem is discovered after a site has been selected and construction is either well under way or in some cases completed. These problems often necessitate delays in construction and ultimately increase total cost of the project. By consulting a soil survey during the planning process prior to construction, compensating designs can be prepared in advance or alternate sites can be selected. Knowing the types of soil, the topography, and surface drainage patterns will prove very beneficial in planning and designing almost any type of land development project and is essential for erosion control planning.

Reference to soil maps and accompanying supporting data in soil surveys enables developers to determine the soil conditions in proposed construction areas. Soil surveys have been proven to be of great savings in time and money, and their use has resulted in improved designs, more effective planning, and more accurate preliminary estimates of construction costs.

Soil surveys in Florida are conducted as a joint effort by the NRCS, the Agricultural Experiment Stations of the University of Florida, and the local Soil and Water Conservation Districts. These Soil Surveys have been published for most Florida counties. Additional soils information may be obtained by contacting the local representative of any of these agencies in your area.

The data in a detailed soil survey is especially valuable in determining the suitability of a site for particular land uses. These surveys contain aerial photographs upon which soil classifications and other information are mapped. In addition, detailed Soil Surveys contain soil interpretations for the soil characteristics discussed above, as well as for the suitability of the soils for selected urban uses such as wastewater treatment, community development, transportation facilities, recreational development, and water management. However, these interpretations do not eliminate the need for specific on-site investigations to be used in the engineering design and construction of projects. These interpretations should be used primarily for land use planning, for evaluating land use alternatives, and for planning site investigations prior to design and construction.

County soil surveys are mapped onto aerial photographs in a scale of 1:20,000. The soil map unit includes soils with similar profile characteristics whose management recommendations are similar. Map units smaller than three or four acres are not delineated separately, but are included in larger adjacent units. Most soil map units have inclusions of different soil series which may require different management practices. A site visit is always required in order to complete a preliminary investigation.

Soil surveys also describe all soil series and map units recognized in a county. A profile description to a depth of 80 inches is included for each soil series mapped within the county. The following information is included for several depths of all major soil series within a map unit:

1. ENGINEERING INDEX PROPERTIES

Texture (USDA)
Classification (Unified soil classification system & AASHTO)
Percentage of soil particles passing designated sieve
Rock fragments
Liquid limit
Plastic limit

2. PHYSICAL AND CHEMICAL PROPERTIES

Percent clay
Clay mineralogy
Moist bulk density
Permeability
Available water-holding capacity
Soil reaction (pH)
Salinity
Shrink / swell potential
Erosion factor K (Erodibility index)
Erosion factor T (Annual erosion in tons / acre)
Wind erodibility
Organic matter

3. SOIL AND WATER FEATURES

Hydrologic soil group (A-D)
Flooding (frequency, duration, time of year)
Seasonal high water table
Depth to bedrock
Subsidence of soils
Risk of corrosion

Soils within a map unit are also interpreted with respect to:

Land capability classes and yield
Woodland management and productivity
Recreational development
Wildlife habitat
Building site development (excavations, roads, buildings, basements, landscaping)
Sanitary facilities (septic tanks, absorption fields, sewage lagoons, landfills)
Construction materials (road fill, sand, gravel, topsoil)
Water management (pond reservoir, embankments, grassed waterways, terraces, drainage, irrigation)

REFERENCES

Florida Department of Environmental Regulation, 1988, The Florida Development Manual: A Guide to Sound Land and Water Management (Chapter 2). Tallahassee, FL

Goldman, S.J., K. Jackson, and T.A. Bursztynsky. 1988 Erosion and Sediment Control Handbook. McGraw-Hill, Inc. New York, NY

City of Tallahassee Department of Public Works Erosion and Sedimentation Control Manual. Tallahassee, FL

CHAPTER 3
ESTIMATING STORMWATER RUNOFF

3.1	INTRODUCTION	1
3.2	DESIGN STORMS	2
3.3	HYDROGRAPHS	3
3.4	GENERAL PROCEDURE	5
3.5	RATIONAL METHOD	7
3.6	OTHER METHODS	23

CHAPTER NOTE

Estimating stormwater runoff is a basic initial step in the design of the stormwater management system as well as the erosion control plan. This chapter presents several commonly used methods and procedures used in this process.

3.1 INTRODUCTION

To determine the volume of stormwater runoff from precipitation, hydrologic calculations are used to quantify precipitation losses which occur as part of the hydrologic cycle. Typically, stormwater management calculations only consider infiltration, interception and surface storage losses, since short time scales will render losses from evaporation and transpiration insignificant.

A wide variety of procedures have been developed to estimate runoff volume and peak discharge rate; and to route the runoff through stormwater management systems. This section discusses only a few methods which are acceptable for estimating the runoff treatment volume required to meet the water quality objectives of the Stormwater Rule. For anyone wishing to obtain a greater understanding of hydrologic methods, especially those used in designing stormwater systems to achieve flood protection purposes, the following documents are recommended:

1. "Urban Hydrology for Small Watersheds", Technical Release 55 (TR55), USDA-Soil Conservation Service, 1986.
2. Drainage Manual, Florida Department of Transportation, 1987.
3. National Engineering Handbook, Section 4-Hydrology, USDA-Soil Conservation Service, 1985.

3.2 DESIGN STORMS

To estimate runoff, the amount of rainfall contributing to the runoff of a given area must be known. The designer must estimate the runoff from predevelopment and postdevelopment conditions and design a stormwater management system to retain the excess quantity and treat the reduced quality of the water. Regulations will dictate a minimum "design storm" for use in stormwater calculations.

A design storm is a theoretical storm event based on rainfall intensities associated with frequency of occurrence and having a set duration. For example, a 50 year - 24 hour storm event is one that theoretically occurs once every fifty years and lasts for 24 hours. A stormwater management system designed for such a storm would theoretically fail every fifty years. The amount of rainfall for a design storm is based on the historical rain data of the geographical location in question. For a 100 year period, the probability of any particular design storm occurring in any given year is the storm frequency divided by 100. The following is a list of average rainfall amounts for different design storms for Orlando, Florida (these were interpolated from the U.S. Weather Service 24 hour duration maps found in Technical Publication 40) and the probability of occurrence in any given year:

Design Storm	Avg. Rainfall	Probability
2 year - 24 hour	4.5"	50 %
5 year - 24 hour	6.5"	20 %
10 year - 24 hour	7.5"	10 %
25 year - 24 hour	8.5"	4 %
50 year - 24 hour	9.5"	2 %
100 year - 24 hour	10.5"	1 %

3.3 HYDROGRAPHS

A hydrograph is a graph displaying some property of water flow, such as stage (i.e. water level), discharge, velocity, etc., versus time. For displaying runoff characteristics of a watershed, the hydrograph is one of discharge (cubic feet per second) versus time (hours). It represents watershed runoff at a certain point in the flow and includes only the rainfall upstream of the point in question. Any rainfall downstream of this point is not represented.

A typical hydrograph is illustrated in Figure 3.3a. There are three basic parts to the hydrograph: (1) the rising limb or concentration curve, (2) the crest segment, and (3) the recession curve or falling limb. Analytical properties of the hydrograph are: (1) Lag time (L) which is the time interval from the center of mass of the rainfall excess to the peak of the hydrograph; (2) Time to peak (T_p) which is the time interval from the start of rainfall excess (direct runoff) to the peak of the hydrograph; (3) Time of concentration (T_c) which is the time interval from the end of the rainfall excess to the point on the falling limb of the hydrograph where the recession curve begins (the point of inflection). Time of concentration is the travel time between the furthest point on the watershed to the point represented by the hydrograph or point of interest. This will be discussed further in the Rational Method section.

In Figure 3.3a the rectangle above the hydrograph, which in hydrologic terminology is called the hyetograph, consists of two separate parts - the losses (upper shaded portion) due to infiltration, evaporation, etc. and the rainfall excess (lower white portion) which is the runoff that produces the hydrograph. The duration (D) of the rainfall excess is shown. The volume of rainfall excess is the rainfall intensity (inches per hour) \times duration (hours) \times the watershed area. The volume of runoff can also be determined by calculating the area under the hydrograph.

Hydrographs are an excellent way to compare predevelopment versus postdevelopment conditions. As seen in Figure 3.3b, peak runoff for postdevelopment is considerably greater than that of predevelopment. Also, the time of concentration for postdevelopment conditions is shorter; therefore, the runoff is traveling at a greater velocity which can contribute to increased erosion rates. The hydrograph for postdevelopment with peak discharge control shows how proper stormwater management can reduce peak runoff and lengthen time of concentration.

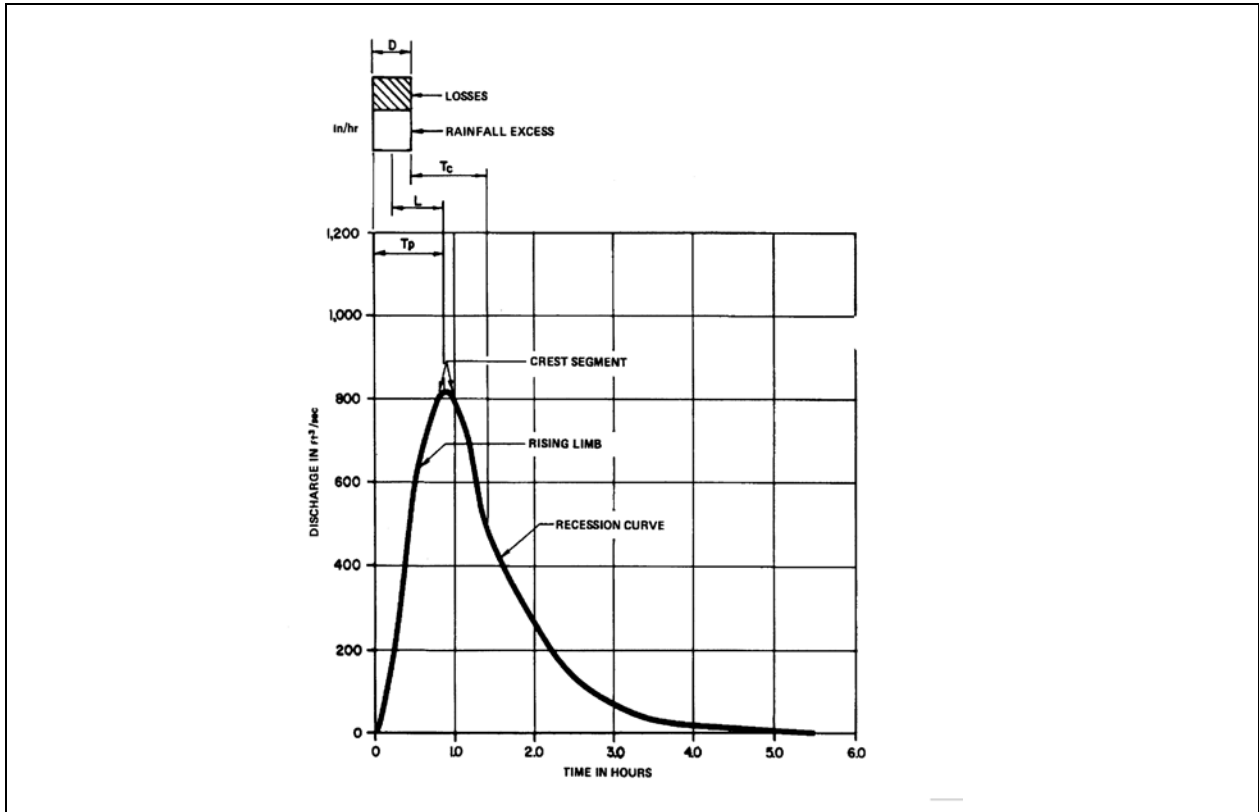

Plate 3.3a Hydrograph Properties

Source: Florida Development Manual

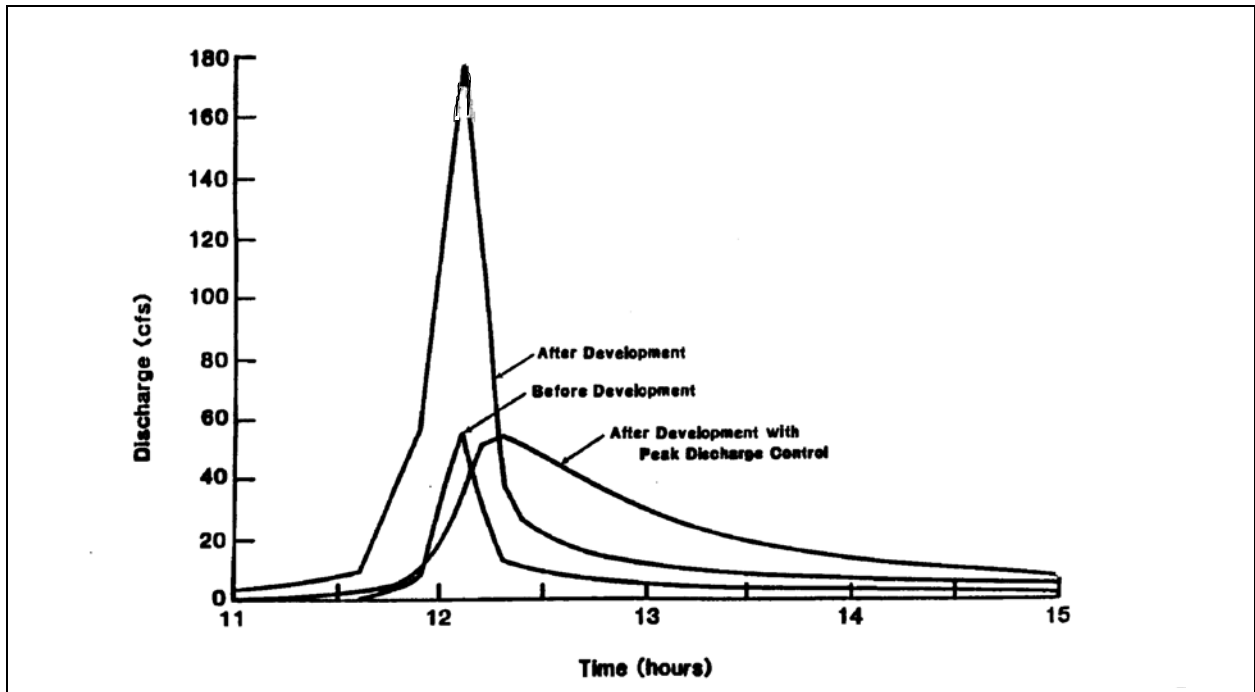

Plate 3.3b Comparison of Hydrographs

Source: Florida Development Manual

3.4 GENERAL PROCEDURE

To meet the water quality objectives of the Stormwater Rule, it is vital that the first flush of pollutants be captured and treated. Many of the methods used to estimate runoff will underestimate runoff volumes because of various factors (e.g., abstraction losses). Therefore, to assure that the first flush is captured and treated, the easiest method to determine the stormwater treatment volume is simply to multiply the project size or contributing drainage area times the treatment volume.

EXAMPLE 3-1: What is the treatment volume for a 50 acre subdivision with a desired retention of 0.5 inches of runoff and a detention of 1.0 inches of runoff?

a. Retention treatment

$$\frac{(50 \text{ acres})(0.5 \text{ inches runoff})}{12 \text{ in / ft}} = 2.08 \text{ acft}$$

b. Detention treatment

$$\frac{(50 \text{ acres})(1.0 \text{ inches runoff})}{12 \text{ in / ft}} = 4.17 \text{ ac - ft}$$

This page left intentionally blank

3.5 RATIONAL METHOD

The Rational Formula is the most commonly used method of determining peak discharges from small drainage areas. This method is traditionally used to size storm sewers, channels and other stormwater structures which handle runoff from drainage areas less than 200 acres.

The Rational Formula is expressed as

$$Q = (C)(i)(A) \quad \text{[Eq 3-1]}$$

where:

- Q = peak rate of runoff in cubic feet per second (*cfs*)
- C = runoff coefficient, a dimensionless unit
- i = average intensity of rainfall in inches per hour (*in/hr*)
- A = the watershed area in acres (*ac*).

COMPONENTS OF THE RATIONAL FORMULA

A - The area

The area, A, draining to any point under consideration in a stormwater management system must be determined accurately. Drainage area information should include:

- a. Land use - present and predicted future - as it affects degree of protection to be provided and percentage of imperviousness.
- b. Character of soil and ground cover as they may affect the runoff coefficient.
- c. General magnitude of ground slopes which, with previous items above and shape of drainage area, will affect the time of concentration. This includes information about individual lot grading and the flow pattern of runoff along swales, streets and gutters.

C - The runoff coefficient

The runoff coefficient, C, is expressed as a dimensionless decimal that represents the ratio of runoff to rainfall. Except for precipitation, which is accounted for in the formula by using the average rainfall intensity over some time period, all other portions of the hydrologic cycle are contained in the runoff coefficient. Therefore, C includes interception, infiltration, evaporation, depression storage and groundwater flow. The variables needed to estimate C should include soil type, land use, degree of imperviousness, watershed slope, surface roughness, antecedent moisture condition, duration and intensity of rainfall, recurrence interval of the rainfall, interception and surface storage. The fewer of these variables used to estimate C, the less accurately the rational formula will reflect the actual hydrologic cycle.

The use of average runoff coefficients for various surface types is common. In addition, C

is assumed to be constant although the coefficient will increase gradually during a storm as the soil becomes saturated and depressions become filled. A suggested range of runoff coefficients is shown in Table 3-1. These coefficients are only applicable for storms of 5 to 10 year return frequencies and they were originally developed when many streets were uncurbed and drainage was conveyed in roadside swales (grassed waterways). For recurrence intervals longer than 10 years, the indicated runoff coefficients should be increased since nearly all of the rainfall in excess of that expected from the 10 year storm will become runoff.

i - Rainfall Intensity

The determination of rainfall intensity, i , for use in the Rational Formula involves consideration of three factors:

- a. Average frequency of occurrence.
- b. Intensity-duration characteristics for a selected rainfall frequency.
- c. The rainfall intensity averaging time, T_C .

The critical storm duration that will produce the peak discharge of runoff is the duration equal to the rainfall intensity averaging time. The average frequency of rainfall occurrence used in the design of the stormwater system theoretically determines how often the structure will fail to serve the protective purpose for which it was designed.

The rainfall intensity averaging time, T_C , is usually referred to as the time of concentration. However, rainfall intensity averaging time more accurately defines the reason for and the use of this variable. T_C is not the total duration of a storm, but is a period of time within some total storm duration during which the maximum average rainfall intensity occurs.

Travel time (T_t) is the time it takes water to travel from one location to another in a watershed. The rainfall intensity averaging time (T_C) is computed by summing all the travel time for consecutive components of the stormwater conveyance system. Several factors will affect the time of concentration and the travel time. These include:

SURFACE ROUGHNESS - One of the most important effects of urbanization on stormwater runoff is increased flow velocity. Undeveloped areas have very slow and shallow overland flow through vegetation which becomes modified by development. The flow is then delivered to streets, gutters and storm sewers that transport runoff downstream more rapidly due to the decreased resistance of the ground cover. Thus, reducing travel time through the watershed.

CHANNEL SHAPE AND FLOW PATTERNS - In small rural watersheds, much of the travel time results from overland flow in upstream areas. Typically, urbanization reduces overland flow lengths by conveying stormwater into a channel as soon as possible. Since channel designs have efficient hydraulic characteristics, runoff flow velocity increases and travel time decreases.

Chapter 3 - Estimating Stormwater Runoff

SLOPE LAND USE		SANDY SOILS		CLAYEY SOILS	
		MIN	MAX	MIN	MAX
Flat (0-2%)	Woodlands	0.10	0.15	0.15	0.20
	Pasture, grass, and farmland ^b	0.15	0.20	0.20	0.25
	Rooftops and pavement	0.95	0.95	0.95	0.95
	Pervious pavements ^c	0.75	0.95	0.90	0.95
	SFR: 1/2-acre lots and larger	0.30	0.35	0.35	0.45
	Smaller lots	0.35	0.45	0.40	0.50
	Duplexes	0.35	0.45	0.40	0.50
	MFR: Apartments, townhouses, etc. Commercial and Industrial	0.45 0.50	0.60 0.95	0.50 0.50	0.70 0.95
Rolling (2-7%)	Woodlands	0.15	0.20	0.20	0.25
	Pasture, grass, and farmland ^b	0.20	0.25	0.25	0.30
	Rooftops and pavement	0.95	0.95	0.95	0.95
	Pervious pavements ^c	0.80	0.95	0.90	0.95
	SFR: 1/2-acre lots and larger	0.35	0.50	0.40	0.55
	Smaller lots	0.40	0.55	0.45	0.60
	Duplexes	0.40	0.55	0.45	0.60
	MFR: Apartments, townhouses, etc. Commercial and Industrial	0.50 0.50	0.70 0.95	0.60 0.60	0.80 0.95
Steep (7%+)	Woodlands	0.20	0.25	0.25	0.30
	Pasture, grass, and farmland ^b	0.25	0.35	0.30	0.40
	Rooftops and pavement	0.95	0.95	0.95	0.95
	Pervious pavements ^c	0.85	0.95	0.90	0.95
	SFR: 1/2-acre lots and larger	0.40	0.55	0.50	0.65
	Smaller lots	0.45	0.60	0.55	0.70
	Duplexes	0.45	0.60	0.55	0.70
	MFR: Apartments, townhouses, etc. Commercial and Industrial	0.60 0.60	0.75 0.95	0.65 0.65	0.85 0.95

Source: FDOT (1987)

^aWeighted coefficient based on percentage of impervious surfaces and green areas must be selected for each site.

^bCoefficients assume good ground cover and conservation treatment.

^cDepends on depth and degree of permeability of underlying strata.

NOTE: SFR = Single Family Residential; MFR = Multi-Family Residential

For recurrence intervals longer than ten years, the indicated runoff coefficients should be increased, assuming that nearly all of the rainfall in excess of that expected from the ten year recurrence interval rainfall will become runoff and should be accommodated by an increased runoff coefficient.

The runoff coefficients indicated for different soil conditions reflect runoff behavior shortly after initial construction. With the passage of time, the runoff behavior in sandy areas will tend to approach that in heavy soil areas. If the designer's interest is long term, the reduced response indicated for sandy soils should be disregarded.

DESIGN STORM FREQUENCY - For recurrence intervals longer than ten years, the indicated runoff coefficients should be increased. This assumes that nearly all of the rainfall in excess of that expected from the ten year recurrence interval rainfall will become runoff. Therefore, it should be accommodated by an increased runoff coefficient.

FUTURE CONSIDERATION - The runoff coefficients indicated for different soil conditions reflect runoff behavior shortly after initial construction. With the passage of time, the runoff behavior in sandy areas will tend to approach that in heavy soil areas. If the designer's interest is long-term, the reduced response indicated for sandy soil areas should be disregarded.

SLOPE - Slopes may be increased or decreased by urbanization, depending on the extent of site grading or the extent to which swales and storm sewers are used in the stormwater management system. Slope will tend to increase when channels are straightened and decrease when overland flow is directed through storm sewers or street gutters.

Water moves through a watershed as sheet flow, shallow concentrated flow, open channel flow or some combination of these. The type of flow that occurs is a function of the conveyance system.

Travel time is the ratio of flow length to flow velocity:

$$T_t = \frac{L}{3600 V} \quad \text{[Eq 3-2]}$$

where:

T_t = travel time (hr)

L = flow length (ft)

V = average velocity (ft/s)

3600 = conversion factor from seconds to hours

Time of concentration is the sum of T_t values for the various consecutive flow segments:

$$T_c = T_{t1} + T_{t2} + \dots + T_{tm} \quad \text{[Eq 3-3]}$$

where:

T_c = time of concentration (hr)

m = number of flow segments

SHEET FLOW is flow over plane surfaces which usually occurs in the headwaters of streams. With sheet flow, the friction value (Manning's n) is an effective roughness coefficient that includes the effect of raindrops impact; drag over the plane surface; obstacles such as litter, crop ridges and rocks; and erosion and transportation of sediment. Table 3-2 gives Manning's n values for sheet flow (depths of about 0.1 foot) for various surface conditions.

For sheet flow of less than 300 feet, use Manning's kinematic solution to compute T_t :

$$T_t = \frac{0.007(nL)^{0.8}}{(P_2)^{0.5} S^{0.4}} \quad \text{[Eq 3-4]}$$

where:

- T_t = travel time (hr)
- n = Manning's roughness coefficient (Table 3-2)
- L = flow length (ft)
- P_2 = 2 year, 24-hour rainfall (in)
- S = slope of hydraulic grade line (ft/ft)

This simplified form of the Manning's kinematic solution is based on the following:

1. Shallow steady uniform flow.
2. Constant intensity of rainfall excess.
3. Rainfall duration of 24-hours.
4. Minor effect of infiltration on travel time.

Table 3-2
ROUGHNESS COEFFICIENTS (MANNING'S n) FOR SHEET FLOW

SURFACE DESCRIPTION	n
Smooth surfaces (concrete, asphalt, gravel or bare soil)	0.011
Fallow (no residue)	0.05
Cultivated soils:	
Residue cover < 20%	0.06
Residue cover > 20%	0.17
Grass:	
Short grass prairie	0.15
Dense grasses	0.24
Bermudagrass	0.41
Range (natural)	0.13
Woods ² :	
Light underbrush	0.40
Dense underbrush	0.80

Source: SCS (1986)

¹Includes species such as weeping lovegrass, bluegrass, buffalograss and native grass mixtures.

²When selecting n , consider cover to a height of about 0.1 ft. This is only part of the plant cover that will obstruct sheet flow.

After a maximum of 300 feet, sheet flow usually becomes **SHALLOW CONCENTRATED FLOW**. The average velocity for this flow can be determined from Figure 3.5a, in which average velocity is a function of watercourse slope and type of channel. For slopes less than 0.005 ft/ft, the average velocity can be calculated from the following equations:

$$\begin{aligned} \text{UNPAVED} \quad V &= 16.1345 (S)^{0.5} \\ \text{PAVED} \quad V &= 20.3282 (S)^{0.5} \end{aligned} \qquad \text{[Eq 3-5]}$$

These two equations are based on the solution of Manning's equation with different assumptions for *n* and *r*. For unpaved areas, *n* is 0.05 and *r* is 0.4; for paved areas *n* is 0.025 and *r* is 0.2.

After determining the average velocity in Figure 3.5a or Equation 3-5, use Equation 3-2 to estimate travel time for the shallow concentrated flow segment.

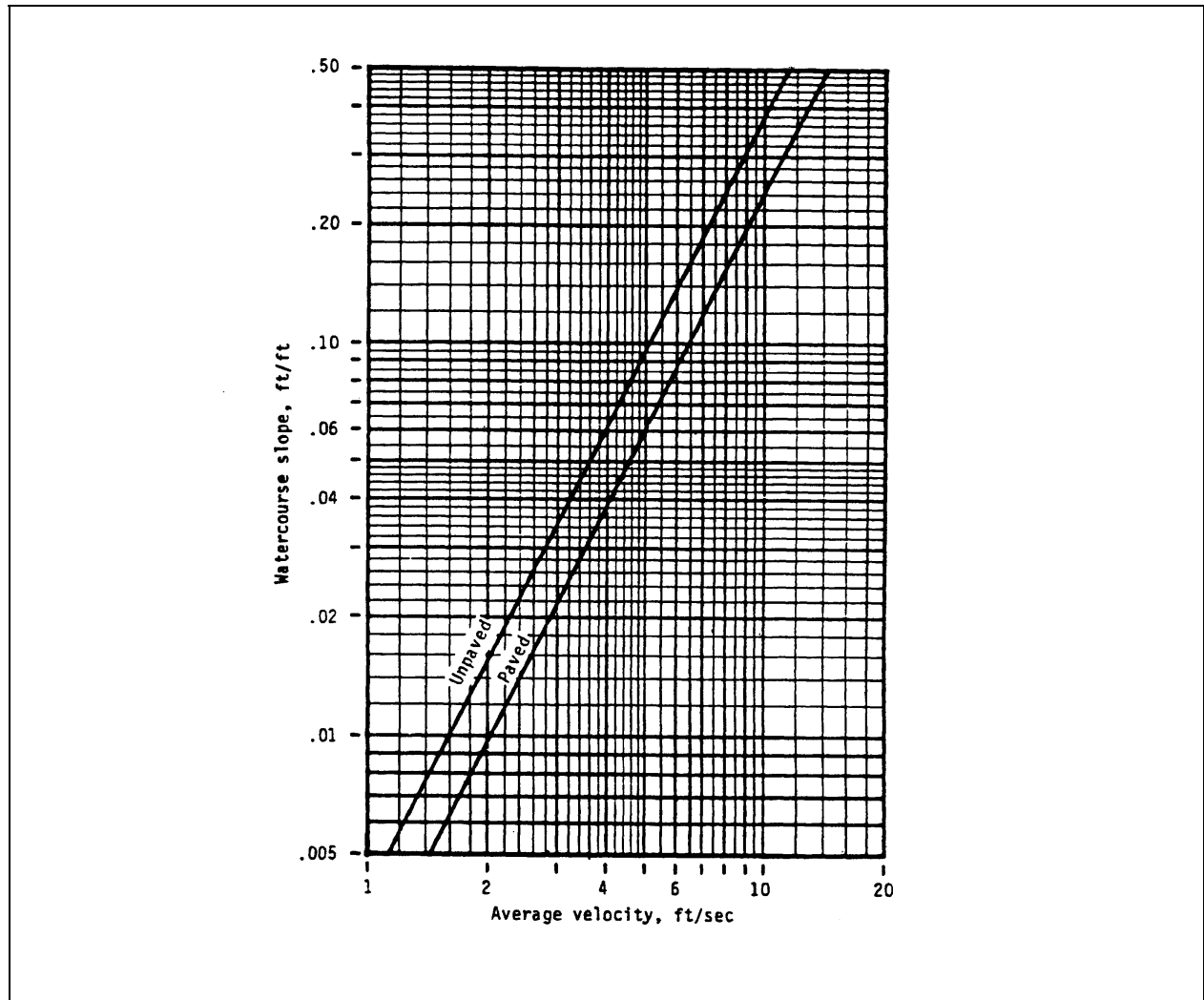

Plate 3.5a Average velocities for estimating travel time for shallow concentrated flow
 Source: Florida Development Manual

OPEN CHANNELS are assumed to begin where surveyed cross-section information has been obtained, where channels are visible on aerial photographs or where blue lines (indicating streams) appear on USGS quadrangle sheets. Manning's equation or water surface profile information can be used to estimate average flow velocity. Average flow velocity is usually determined for bank-full elevation.

Manning's equation is:

$$V = \frac{1.49 r^{2/3} s^{1/2}}{n} \quad \text{[Eq 3-6]}$$

where:

- V = average velocity (ft/sec)
- r = hydraulic radius (ft) and is equal to a/P_w
- a = cross sectional flow area (ft²)
- P_w = wetted perimeter (ft); this is the length of the portion of the cross sectional area in contact with the open channel
- s = slope of the hydraulic grade line (ft/ft)
- n = Manning's roughness coefficient for open channel flow

Manning's n values for open channel flow can be obtained from Table 3-2. Standard textbooks such as Chow (1959) or Linsley et.al (1982) also may be consulted to obtain Manning's n values for open channel flow. Manning's n values for other conditions can be found in Tables 3-3 through 3-5. After average velocity is computed using Equation 3-6, T_t for the channel segment can be estimated using Equation 3-2.

**Table 3-3
RECOMMENDED MANNING'S n VALUES FOR ARTIFICIAL
CHANNELS WITH BARE SOIL AND VEGETATIVE LININGS**

CHANNEL LINING	DESCRIPTION	n
Bare earth, fairly uniform	Clean, recently completed	0.022
	Short grass and some weeds	0.028
Dragline excavated	No vegetation	0.030
	Light brush	0.040
Channels not maintained	Clear bottom, brush sides	0.08
	Dense weeds to flow depth	0.10
Maintained grass or sodded ditches	Good strand, well maintained 2"-6"	0.06*
	Fair strand, length 12"-24"	0.20*

Source FDOT (1987)

*Decrease 30% for flows > 0.7' depth (maximum flow depth 1.5').

**Table 3-4
RECOMMENDED MANNING'S N VALUES FOR
ARTIFICIAL CHANNELS WITH RIGID LININGS**

CHANNEL LINING	FINISH DESCRIPTION	<i>n</i>
Concrete paved	Broomed	0.016
	"Roughened" - Standard	0.020
	Gunite	0.020
	Over rubble	0.023
Asphalt concrete paved	Smooth	0.013
	Rough	0.016

Source: FDOT (1987)

**Table 3-5
RECOMMENDED MANNING'S *n* VALUES FOR CULVERT DESIGN**

CULVERT TYPE	<i>n</i>
Concrete pipe	0.012
Concrete box culvert precast or cast in place	0.012
Corrugated metal pipe (non-spiral flow - all corrugations):	
Round 15" - 24"	0.020
Round 30" - 54"	0.022
Round 60" - 120"	0.024
Corrugated metal pipe (spiral flow - all corrugations):	
Round 15" - 24"	0.017
Round 30" - 54"	0.021
Round 60" - 120"+	0.024
Corrugated metal pipe-arch - all sizes:	
2-2/3 x 1/2	0.024
3 x 1	0.027
5 x 1	0.027
Corrugated structural plate pipe and pipe-arch - all sizes:	
6 x 1	0.030
6 x 2	0.033
9 x 2-1/2	0.034

Source: FDOT (1987)

PIPE FLOW is simply water flowing in a pipe. The flow velocity can be calculated using the same equation as for open channel flow.

When the pipe in question is at full flow a modification of Equation 4-6 can be used for the pipe diameter (*d*) instead of using hydraulic radius (*r*)

$$V = \frac{0.59 (d)^{2/3} (s)^{1/2}}{n} \quad \text{[Eq 3-7]}$$

EXAMPLE 3-2

The sketch below shows an urbanized watershed in Leon County, Florida. The problem is to compute T_C at the outlet of the watershed (point E). The 2 year 24-hour rainfall depth is 4.8 inches (Figure 3.5b). Four types of flow occur from the hydraulically most distant point (A) to the point of interest (E). To compute T_C , first determine T_i for each segment based on the following data:

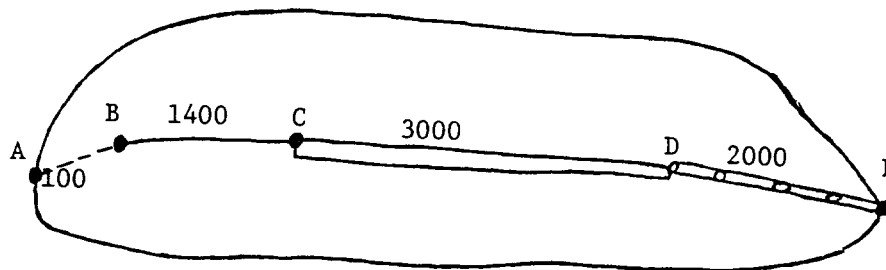

REACH	DESCRIPTION	SLOPE %	LENGTH (FT)
A to B	Sheet flow; dense grass	1.0	100
B to C	Shallow concentrated; unpaved	1.0	1400
C to D	Channel flow (Manning's $n = 0.05$ $a = 27 \text{ ft}^2$, $P_w = 0.015$)	0.5	3000
D to E	Storm sewer (Manning's $n = 0.015$ diameter = 3 ft)	1.5	2000

1. Calculate sheet flow travel time (segment A to B):

Given in this segment are length ($L = 100 \text{ ft.}$) and slope ($s = 0.01 \text{ ft/ft}$). The runoff in this segment is sheet flow; therefore, Table 4-2 is used for determining the n value. The n value for dense grass is 0.24. The 2 year - 24 hour rainfall P_2 for Leon County can be estimated from Figure 3.5b to be 4.8 inches.

Solving Equation 3-4 with the above variables we get:

$$T_t = \frac{0.007 (0.24 \times 100)^{0.8}}{(4.8)^{0.5} (0.01)^{0.4}} = 0.256 \text{ hr}$$

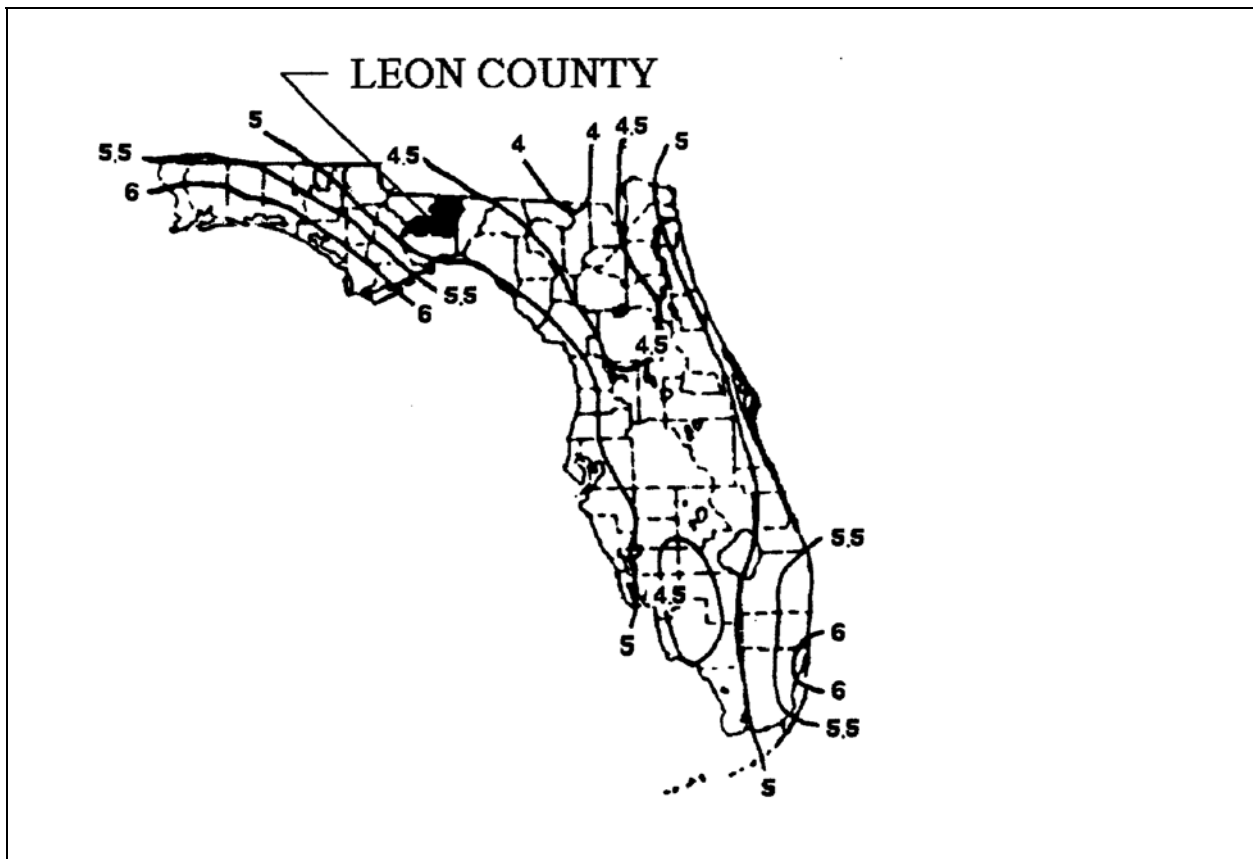

Plate 3.5b 2 Year - 24 Hour Rainfall (inches)

Source: FDOT

2. Calculate shallow concentrated flow (segment B to C).

For this segment length ($L = 1400$ ft) and slope ($s = 0.01$ ft/ft) are given. Use Figure 3-3 to find the average velocity for an unpaved watercourse with 0.01 ft/ft slope. The given slope (s) intersects the line representing "unpaved" at a velocity (V) of 1.6 ft/sec.

Solving Equation 3-2 with the above variables we get:

$$T_t = \frac{1400}{(3600)(1.6)} = 0.24 \text{ hr}$$

3. Calculate channel flow.

The runoff in segment C to D is now channel flow. We are given cross sectional flow area ($a = 27$ ft²) and the wetted perimeter ($P_w = 28.2$ ft). With this information we can calculate the hydraulic radius (r)

$$r = \frac{27}{28.2} = 0.957 \text{ ft}$$

Also given in this segment are channel slope ($s = 0.005$ ft/ft) and Manning's roughness coefficient ($n = 0.05$). From these variables and the hydraulic radius calculated above we can calculate the velocity (V) of the runoff using Equation 3-6

$$V = \frac{1.49 (0.957)^{2/3} (0.005)^{1/2}}{0.05} = 2.05 \text{ ft/sec}$$

Now that we have the velocity and the given distance of this segment ($L = 3000$ ft) we can determine the travel time (T_t) by using Equation 3-2

$$T_t = \frac{3000}{(3600)(2.05)} = 0.406 \text{ hr}$$

4. Calculate storm sewer travel time (assume the pipe is flowing full).

In this segment (D to E) we are given the sewer pipe diameter ($d = 3$ ft) and Manning's roughness coefficient ($n = 0.015$). We can determine velocity by plugging the above variables into Equation 3-7

$$V = \frac{0.59 (3)^{2/3} (0.015)^{1/2}}{0.015} = 10 \text{ ft/sec}$$

Again using Equation 3-2 we can calculate travel time with the velocity determined above and the given length of sewer pipe ($L = 2000$ ft)

$$T_t = \frac{2000}{(3600)(10)} = 0.056 \text{ hr}$$

5. Calculate time of concentration for the watershed.

This is simply the addition of the travel times of the four flow segments (Eq 3-3)

$$T_c = 0.256 + 0.240 + 0.406 + 0.056 = 0.958 \text{ hr} = 57.5 \text{ min}$$

How to Use the Rational Formula

The general procedure for determining peak discharge with the Rational Formula is:

- Step 1)** Determine the drainage area (in acres).
- Step 2)** Determine the runoff coefficient, C , for the type of soil/ cover in the drainage area (Table 3-1). If land use and soil cover are homogeneous over the drainage area, a C value can be determined directly from Table 3-1. If there are multiple soil cover conditions, a weighted average must be performed (see Example 3-3).

- Step 3)** Determine the rainfall intensity averaging time, T_C , in minutes for the drainage area (time required for water to flow from the hydraulically most distant point of that tributary watershed which produces the greatest discharge to the point of design). Example 3-2 illustrates how to calculate the time of concentration, T_C .
- Step 4)** Determine the Rainfall Intensity Factor, i , for the selected design storm. This is done by using the Rainfall Intensity - Frequency Duration chart (Figure 3.5d). Enter the "Duration" axis of the chart with the calculated time of concentration, T_C . Move vertically until you intersect the curve of the appropriate design storm, then move horizontally to read the Rainfall Intensity Factor, i , in inches per hour.
- Step 5)** Determine the peak discharge (Q - in cubic feet per second) by inserting the previously determined factors into the rational formula (Equation 3-1).

Example 3-3

Given: Drainage Area: 80 acres
 30% - Rooftops (24 acres)
 10% - Streets & Driveways (8 acres)
 20% - Lawns @ 5% slope (16 acres) on sandy soil
 40% - Woodland (32 acres)
 Time of Concentration (T_C) = 15 min.
 Location: Tallahassee, Florida (Leon County)

Find: Peak runoff rate from 10-year frequency storm.

Solution: 1. Drainage Area = 80 acres (given)
 2. Determine runoff coefficient (c)

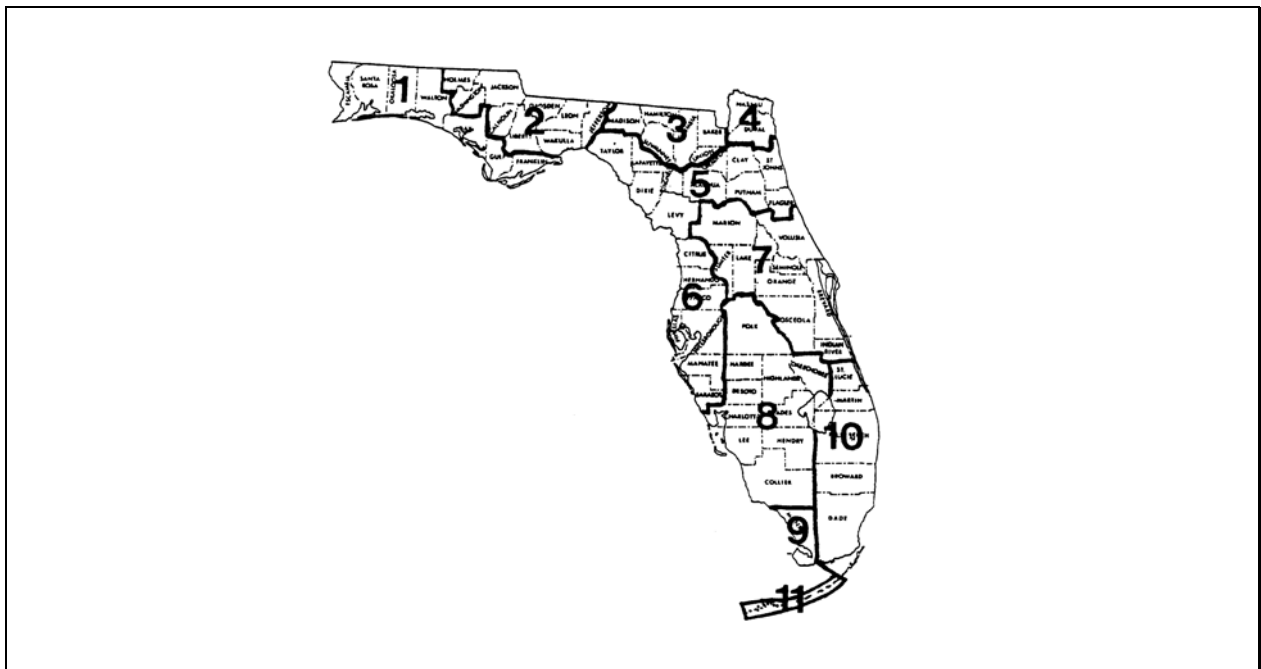

Plate 3.5c Zones for Precipitation Intensity - Duration - Frequency
Source: FDOT

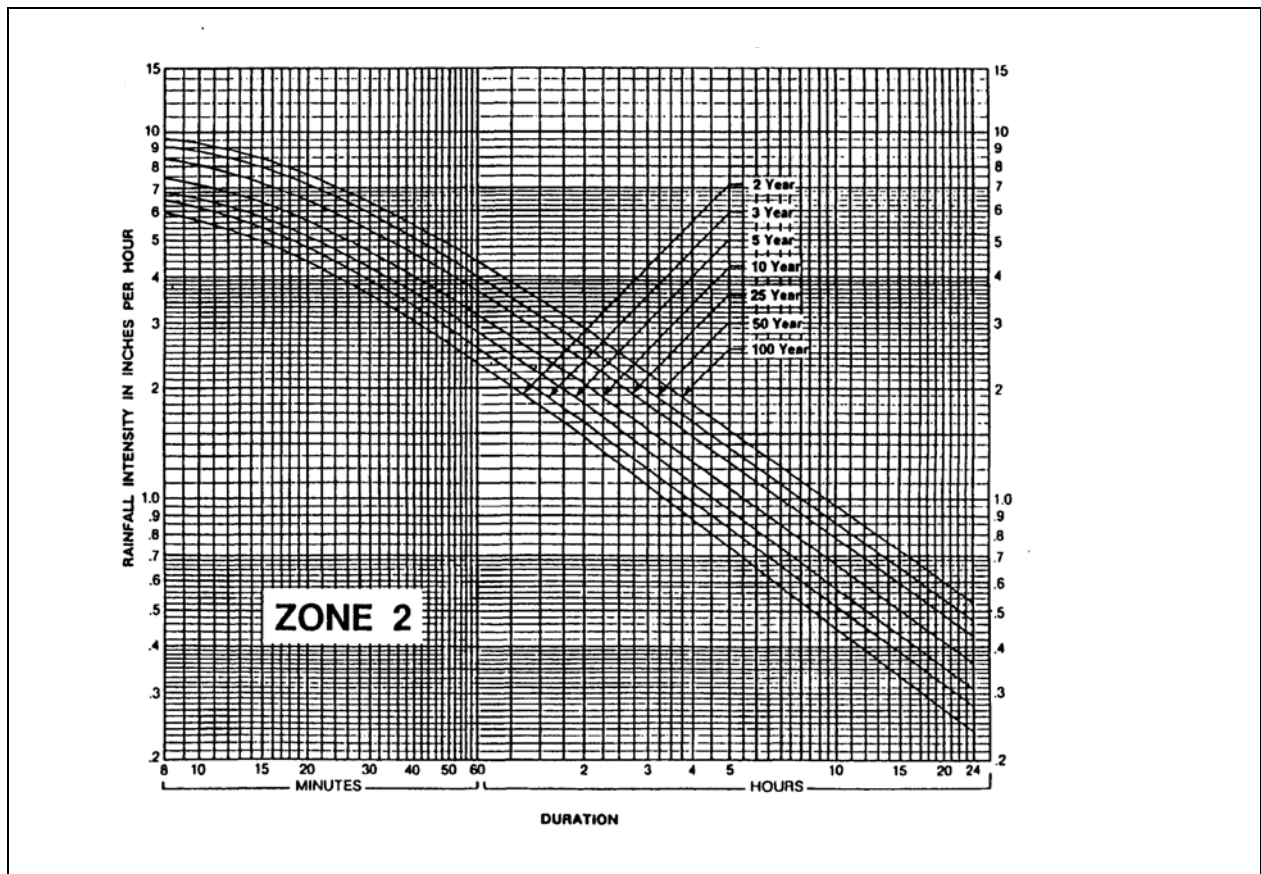

Plate 3.5d Rainfall Intensity - Duration - Frequency Curves for Zone 2
Source: FDOT

Perform Weighted Average

Ground Cover	Area (acres)	C from Table 4-1	Area × C
Rooftops	24	0.90	21.6
Streets	8	0.90	7.2
Lawns	16	0.15	2.4
Woodland	32	0.10	3.2
Total	80	Total	34.4

Weighted average of C is the total of the "C × Area" column divided by the total of the "Area" column

$$C = \frac{34.4}{80} = 0.43$$

3. Time of concentration (T_c) = 15 min. (given)
4. Determine Rainfall Intensity Factor (i)
(i) = 6.2 in./hr. (from Figure 4-6)
5. Plug the above variables into Equation 3-1

$$\begin{aligned} Q &= C (i) (A) \\ &= 0.43 (6.2) (80) \\ &= 213.3 \text{ cfs} \end{aligned}$$

Assumptions and Misconceptions

Assumptions and misconceptions are grouped together because an assumption used in the Rational Formula might in itself be a misconception. Several assumptions are listed below with each followed by a brief discussion.

1. The peak rate of runoff at any point is a direct function of the tributary drainage area and the average rainfall intensity during the time of concentration to that point. This is the rational formula stated in words.
2. The return period of the peak discharge rate is the same as the return period of the average rainfall intensity or rainfall event. While watershed-related variations may cause this relationship to break down, this assumption is widely used in methodologies for estimating peak flows or hydrographs.

3. The rainfall is uniformly distributed over the watershed. Whether this assumption is true depends upon the size of the watershed and the rainfall event.
4. The rainfall intensity remains constant during the time period equal to T_C . Based on rainfall records, this assumption is true for short periods of time (a few minutes), but becomes less true as time increases. In turn, this assumption has led to a common misconception that the duration of the storm is equal to T_C . This is theoretically possible but it is much more common for the total storm duration to be considerably longer than T_C .

Of equal importance is the concept that T_C (the rainfall intensity averaging time) can occur during any segment of the total storm duration--at the beginning; before, during or after the middle portion; or near the end. This concept has important implications for the runoff coefficient C and how well the Rational Formula mirrors the hydrologic cycle. If T_C occurs at the beginning of the storm, then the antecedent moisture conditions become important. If T_C occurs near the end of a long storm, then the ground may be saturated and depression storage already filled when T_C begins.

5. The relationship between rainfall and runoff is linear. If rainfall is doubled then runoff is doubled. This is not accurate because of all the variables which interact and determine runoff. In fact, one of the major misconceptions in the use of the formula is that each of the variables (C , i , A) is independent and estimated separately. In reality, there is some interdependency among variables; however, the aids used in estimating the variables do not recognize such a relationship.
6. The runoff coefficient, C , is constant for storms of any duration or frequency on the watershed. This is a major misconception of many who use the Rational Formula. C is a variable and during the design of a stormwater system, especially a storm sewer, it should take on several different values for the various segments even though the land use remains the same.

Limitations of the Formula

The major limitation is that the Rational Formula only produces one point on the runoff hydrograph--the peak discharge rate. When basins become complex, and where sub-basins combine, the Rational Formula will tend to over estimate the actual flow. The over estimation will result in the oversizing of stormwater management systems.

When the formula is used for larger developments as a basis for establishing predevelopment flow rates which are to define the restrictions needed for peak rate control, higher flow rates are likely to be obtained than actually occur. The implication of this is that greater flow rates will then be allowed after development, resulting in less on-site flow reduction being required and higher post-development flow rates. This condition can adversely affect downstream property owners.

The average rainfall intensities used in the method bear no time sequence relation to the actual rainfall pattern during a storm. The intensity-duration-frequency curves prepared by the Weather Bureau are not true sequence curves of precipitation but are developed from

data on peak rainfall intensities of various duration. For example, an intensity of one inch per hour may occur for various durations at various frequencies (e.g. 25 minute duration for a 5 year return period; 45 minute duration for a 25 year return period). In neither case does this analysis deal with any part of the total storm other than the peak, nor does the formula differentiate between an intense summer thunderstorm or a winter frontal storm. This weakness becomes especially glaring in the design of stormwater systems since the design storms specified by local governments are usually large, long duration events.

The method assumes that the rainfall intensity is uniform over the entire watershed. This assumption is true only for small watersheds and time periods, thus limiting the use of the formula to small watersheds. Whether "small" means 20 acres or 200 acres is still being debated.

Finally, one of the most important limitations is that the results are usually not replicable from user to user. There are considerable variations in interpretation and methodology in the use of the formula. The simplistic approach of the formula permits, and in fact, requires, a wide latitude of subjective judgement in its application. Each firm or agency has its favorite T_C formula, its favorite table for determining C , and its own method for determining which recurrence interval is to be used in certain situations.

3.6 OTHER METHODS

The intent of the Stormwater Rule is to obtain 80 to 90% pollutant removal from stormwater discharges. The pollutant removal efficiency of any system is difficult to accurately predict since the treatment ability of any BMP is highly variable among storm events, depending upon many factors which fluctuate independently with time and location. However, the average annual removal of various pollutants can be estimated based on two of the more often studied properties of storm events and runoff waters. These properties are the frequency distribution of rainstorm volumes and the first flush of pollutants.

The requirements in the Stormwater Rule are based on a statistical analysis of Florida rainfall data and field investigations of the first flush undertaken in Florida. Nearly 90% of all storm events that occur in any region of Florida during a given year will provide one inch of rainfall or less (Table 3-1). These storms account for over 75% of the total annual volume of rain. If the concentrations of pollutants are relatively constant with time during the course of a storm, as has been observed in large watersheds, then the percentage mass of pollutants removed would be proportional to the fraction of yearly runoff waters which are treated. However, first flush effects, in which the amount of pollutants are greater during the early part of a storm, occur in small urbanized drainage areas. Thus, the infiltration of the first one-half inch of runoff from watersheds less than 100 acres in size will result in the capture of at least 80% of the annual average stormwater pollutant load.

It is important that the first flush treatment volume be estimated accurately and conservatively in order to achieve water quality objectives. Designers are not limited to the Rational Formula or the General Procedure for capturing the first 1/2" or 1" of runoff. These are relatively simplistic methods in comparison to other methods available, which we won't discuss in detail due to their increased complexity. Table 3-6 presents a summary of the treatment volumes estimated by various hydrologic methods. As seen, the Rational Formula, despite its deficiencies and over simplicity which may render it undesirable for stormwater quantity calculations, will work to estimate the first flush treatment volume.

The SCS equations will tend to under predict runoff volume from most small storms when compared to the rational method due to the basic presumptions in the "curve number" procedure. The SCS method assumes that runoff will occur only when the storage (S) capacity of the watershed is exceeded. It is postulated that the storage is directly related to the curve number (CN), which is determined by soil type and ground cover. As a result, for low volumes of rainfall (e.g. 6 inches or less, typical of storms with a return period of five years or less) the use of the SCS curve number procedures will underestimate runoff for most urbanizing situations. This will also reduce the amount of the first flush pollutants that are captured and reduce the overall treatment efficiency of a stormwater system. The Wanielista design equations were developed as a result of stormwater research conducted by Dr. Martin P. Wanielista and his colleagues at the University of Central Florida. These equations can be used to determine the stormwater treatment volume for off line retention systems. A complete discussion of these equations can be found in RETENTION BASINS (SW BMP 3.07).

**Table 3-6
Cumulative Probability Values (%) for 15 Florida Locations**

Location	Volume (in) / Probability (%)				
	0 - 1/2	1/2 - 1	1 - 2	2 - 3	3 - 4
Niceville	68.2	84.5	93.8	97.7	98.4
Tallahassee	70.3	83.7	94.2	98.0	99.6
Jacksonville	77.1	91.7	97.7	99.1	99.6
Appalachicola	75.3	87.9	97.4	99.3	99.7
Gainesville	76.9	90.0	97.0	98.9	99.8
Daytona	75.9	89.3	96.2	98.7	99.8
Inglis	71.1	85.1	96.6	99.2	99.8
Orlando	80.1	90.0	98.0	99.6	99.9
Tampa	76.4	89.7	97.9	99.5	99.9
Vero Beach	77.5	89.9	98.7	99.3	99.5
Clewiston	74.3	87.3	97.0	98.9	99.6
West Palm Beach	80.6	90.8	97.0	98.7	99.1
Fort Myers	70.5	86.4	95.6	98.4	99.6
Miami	82.7	93.3	98.5	99.4	99.6
Key West	84.9	94.0	98.4	99.3	99.6
Florida	76.4	89.0	97.0	99.0	99.6

**Table 3-7
Comparison of Different Methods for Calculating Runoff
Volume (Ac-Ft) to Satisfy Section 17-25.035(2)(b) Criteria**

Method	Acres	% Impervious				
		10	40	60	80	90
Santa Barbara Urban Hydrograph	10	0.04	0.16	0.35	0.48	0.62
	50	0.21	0.79	1.75	2.38	3.08
	100	0.42	1.58	3.50	4.75	6.17
	200	0.83	3.17	7.00	9.50	12.33
SCS Weighted Q	10	0.07	0.27	0.39	0.53	0.59
	50	0.33	1.33	1.96	2.63	2.96
	100	0.67	2.67	3.92	5.25	5.92
	200	1.33	5.33	7.83	10.50	11.83
Rational	10	0.16	0.38	0.53	0.67	0.74
	50	0.79	1.88	2.63	3.33	3.71
	100	1.58	3.75	5.25	6.67	7.42
	200	3.17	7.50	10.50	13.33	14.83
1/2" Volume	10	0.42	0.42	0.42	0.42	0.42
	50	2.08	2.08	2.08	2.08	2.08
	100	4.17	4.17	4.17	4.17	4.17
	200	8.33	8.33	8.33	8.33	8.33
Wanielista Equation (80%) Efficiency	10	0.23	0.25	0.26	0.28	0.28
	50	1.81	1.97	2.07	2.17	2.23
	100	4.40	4.78	5.02	5.27	5.40
	200	10.67	11.61	12.19	12.81	13.12

REFERENCES

Florida Department of Environmental Regulation, 1988, The Florida Development Manual A Guide to Sound Land and Water Management (Chapter 5). Tallahassee, Florida

Wanielista, Martin P., 1978. Stormwater Management: Quantity and Quality, Ann Arbor Science, Ann Arbor, Michigan.

**CHAPTER 4
BEST MANAGEMENT PRACTICES
FOR EROSION AND SEDIMENTATION CONTROL**

4.01	IMPORTANCE OF CONSTRUCTION SEQUENCING	1
4.02	POLLUTION SOURCE CONTROLS ON CONSTRUCTION SITES	3
4.03	TEMPORARY GRAVEL CONSTRUCTION ENTRANCE	7
4.04	CONSTRUCTION ROAD STABILIZATION	11
4.05	STRAW BALE BARRIER	13
4.06	SILT FENCE	21
4.07	BRUSH BARRIER	31
4.08	STORMDRAIN INLET PROTECTION	33
4.15	TEMPORARY DIVERSION DIKE	55
4.16	TEMPORARY FILL DIVERSION	59
4.17	TEMPORARY RIGHT-OF-WAY DIVERSION	63
4.25	TEMPORARY SEDIMENT TRAP	67
4.26	TEMPORARY SEDIMENT BASIN	79
4.30	TEMPORARY SLOPE DRAIN	99
4.38	TEMPORARY CHECK DAMS	105
4.40	DEWATERING	113
4.45	FLOATING TURBIDITY BARRIER	115

CHAPTER NOTE

Effective control of erosion and sedimentation depends on the proper use of a number of specific best management practices (BMP's). Each of these has a correct application, installation, and maintenance requirement. This chapter provides a "toolbox" of BMP's with instructions for their use. Always remember that the rules are performance based. Implementation according to this manual is no guarantee of success, nor is it a constraint to prevent the use of other more efficient or cost effective measures.

4.01 IMPORTANCE OF CONSTRUCTION SEQUENCING

Definition

Coordinating the construction schedule to minimize the amount of area disturbed at any one time and coordinating land clearing with the installation of erosion control measures.

Purpose

To minimize the amount of disturbed area, thereby reducing erosion potential.

Condition where Practice Applies

This practice applies to all construction projects. The level of planning and management necessary to minimize erosion and control sedimentation adequately is dependent upon the size, location, and complexity of the construction site.

Planning Considerations

The key to efficient and cost-effective erosion control is to plan construction activities in phases to reduce the erosion potential of the site. By clearing only areas that are to be developed, only limited areas of land are disturbed, making it much easier to prevent and control erosion than if the entire site were exposed at once. On larger projects sub-phases should be used to minimize the area of exposed soil. Before site disturbance occurs perimeter controls, sediment traps, basins, and diversions should be in place to control runoff and capture sediments. Prioritize disturbed areas in the vicinity of water bodies, wetlands, steep grades, long slopes, etc. for effective stabilization within seven days of disturbance. Graded areas that will not be worked on should be seeded and mulched immediately, rather than waiting until all project grading is done. A well-planned and well-maintained construction entrance with stabilized construction roads can prevent offsite sedimentation, keep sediments off of roads, minimize complaints from neighbors, and reduce future expenses and aggravation.

Land disturbing activities are best scheduled during periods of low precipitation. Generally, Florida's wet season occurs from May to November with a dry season from November to May. Check with your local Water Management District (WMD) or Florida Department of Transportation (FDOT) office for more precise information in your area.

Specifications

Management of construction projects can be viewed in three phases. *Phase I* is the initial installation of perimeter controls, sediment traps, basins, and diversions prior to site development. *Phase II* is an interim stormwater management plan whereby components of the permanent stormwater management system are constructed and connected to the stormwater facilities as the site is developed. *Phase III* is the finished product and should perform as such.

Phase I

This is the first construction related activity to occur on any site. Installation of initial controls shall be discussed at the pre-construction conference. The contractor and the inspector should understand the inspection and maintenance requirements of the specified BMPs, as well as the location and proper installation procedures.

Offsite runoff should be diverted around the project if stabilized areas, adequate conveyance, and/or protected inlets are available. Sediment traps and basins should be built to receive the anticipated runoff and sediments. A temporary sediment basin in the location of the permanent stormwater facility makes efficient use of space and simplifies future tasks. Perimeter controls and diversions must be installed to keep sediments onsite and directed to the traps and basins. As clearing and grading progresses, temporary seeding and mulching should follow immediately for areas which will not be worked for a period of seven days or more.

Phase II

This phase is the interim phase of the project. The permanent stormwater management system is constructed in conjunction with the other construction activities. Before runoff is directed into it, the system must be properly stabilized. Additionally it must be protected from sedimentation until completion of the project. As the stormwater facilities are constructed, they should also be kept free of sediments. Special care must be taken if stormwater ponds are used as temporary sediment basins to ensure complete removal of accumulated sediments which would reduce stormwater storage volume and cause premature clogging. If possible, design and excavate the sediment basin bottom 6" to 12" (15 - 30 cm) higher than the eventual pond bottom. Land disturbance should occur only in areas which are being actively worked. Graded areas should be seeded and mulched immediately if they will not be worked for a period of seven days or more.

A regular maintenance program should insure inspection and maintenance of BMPs by the contractor weekly and/or after significant rain events. Any failures should be analyzed to prevent recurrence. Substantial changes to the approved plan must be made or reviewed by the designer and approved by the appropriate regulatory agency.

Phase III

This is the completed project. The entire stormwater management system should be built according to the approved plans. Substantial deviations from the plan may require revisions by the design professional, reapproval by the regulatory agency, and/or reconstruction by the contractor. The system must also function as designed and in compliance with applicable regulatory criteria. Any previously unforeseen activities which could compromise the function or maintainability of the system should be addressed immediately.

4.02 POLLUTION SOURCE CONTROLS ON CONSTRUCTION SITES **(SW BMP 2.04)**

Definition

Minimizing nonpoint source pollution from construction sites through good management and "housekeeping" techniques.

Purpose

To reduce the availability of construction-related pollutants which can contaminate runoff water and, where runoff contamination cannot be avoided, to retain pollutants and polluted water on the site.

Conditions Where Practice Applies

This practice applies to all construction projects. The level of planning and management necessary to control nonpoint source pollution adequately is dependent upon the size and complexity of the construction site.

Planning Considerations

Construction activities, by their nature, create many sources of potential pollutants which can contaminate runoff and thereby affect the quality of downstream receiving waters. Accelerated erosion and sedimentation caused by land-disturbing activities are the major pollution problems caused by construction.

There are, however, many other potential pollutants associated with construction activities such as gasoline, oils, grease, paints, cements, and solvents, to name only a few. Even relatively non-toxic materials such as paper and cardboard can be classified as potential pollutants when they are washed into streams and lakes.

The best way to prevent nonpoint source pollution on construction sites is to use "good housekeeping" practices, which usually entails simply maintaining the site in a neat and orderly condition. Specific practices should be employed to retain runoff and to deal with toxic substances and materials. An overall plan for the control of nonpoint source pollution is advisable so that control measures can be specified and implemented effectively.

Following are some elements which should be considered in **nonpoint** source pollution control planning on a construction site:

1) **Erosion and Sediment Controls**

Practices which minimize erosion and retain sediment on site are effective in controlling many other nonpoint source pollutants associated with construction activities as well. Development and implementation of a good erosion and sediment control plan is a key factor in controlling nonpoint source pollutants other than sediment on a construction site.

2) **Equipment Maintenance and Repair**

Maintenance and repair of construction machinery and equipment should be confined to areas specifically designated for that purpose. Such areas should be located and designed so that oils, gasoline, grease, solvents and other potential pollutants cannot be washed directly into receiving streams, stormwater conveyance systems, or existing and potential wellfields. These areas should be provided with adequate waste disposal receptacles for liquid and solid wastes. Maintenance areas should be inspected and cleaned daily.

On a construction site where designated equipment maintenance areas are not feasible, exceptional care should be taken during each individual repair or maintenance operation to prevent potential pollutants from becoming available to be washed into streams or conveyance systems. Temporary waste disposal receptacles should be provided and emptied as required.

3) **Storm Sewer Inlet Protection**

Inlets to storm sewers should be protected by suitable filtering devices during construction to keep pollutants from entering conveyance systems. See STORM DRAIN INLET PROTECTION - Section 4.08 (ES BMP 1.08).

4) **Waste Collection and Disposal**

A plan should be formulated for the collection and disposal of waste materials on a construction site. Such a plan should designate locations for trash and waste receptacles and establish a specific collection schedule. Methods for ultimate disposal of waste should be specified and carried out according to applicable local and state health and safety regulations. Special provisions should be made for the collection, storage, and disposal of liquid wastes and toxic or hazardous materials.

Receptacles and other waste collection areas should be kept neat and orderly to the extent possible. Trash cans should have lids and dumpsters should have covers to prevent rainwater from entering. Waste should not be allowed to overflow its container or accumulate for excessively long periods of time. Trash collection points should be located where they will least likely be affected by concentrated stormwater runoff.

5) **Demolition Areas**

Demolition projects usually generate large amounts of dust with significant concentrations of heavy metals and other toxic pollutants. Dust control techniques should be used to limit the transport of the airborne pollutants. However, water or slurry used to control dust should be retained on the site and not be allowed to run directly into watercourses or stormwater conveyance systems.

6) **Washing Areas**

Vehicles such as cement or dump trucks and other construction equipment should not be washed at locations where the runoff will flow directly into a watercourse or stormwater

conveyance system. Special areas should be designated for washing vehicles. These areas should be located where the wash water will spread out and evaporate or infiltrate directly into the ground, or where the runoff can be collected in a temporary holding or seepage basin. Wash areas should have gravel bases to minimize mud generation.

7) **Storage of Construction Materials, Chemicals, Etc.**

Sites where chemicals, cements, solvents, paints, or other potential water pollutants are to be stored, should be isolated in areas where they will not cause runoff pollution. Toxic chemicals and materials, such as pesticides, paints, and acids, should be stored according to manufacturers' guidelines. Overuse should be avoided and great care should be taken to prevent accidental spillage. Containers should never be washed in or near flowing streams or stormwater conveyance systems. Groundwater resources should be protected from leaching by placing a plastic mat, tar paper, or other impervious materials on any areas where toxic liquids are to be opened and stored.

8) **Sanitary Facilities**

All construction sites should be provided with adequate sanitary facilities for workers according to applicable health regulations.

9) **Dust Control**

The use of calcium chloride, oils, or other chemical dust control agents on construction roads should be avoided. Periodic watering of these areas is a preferred alternative.

10) **Dewatering**

Many improvements such as underground utilities, foundations, and stormwater management facilities require removal and disposal of water from excavations. A detailed discussion of this practice follows in DEWATERING - Section 4.40.

This page left intentionally blank.

4.03 TEMPORARY GRAVEL CONSTRUCTION ENTRANCE & EXIT **(ES BMP 1.01)**

Definition

A stone stabilized pad located at points of vehicular ingress and egress on a construction site.

Purpose

To stabilize entrances to the construction site and reduce the amount of sediment transported onto public roads by motor vehicles or runoff.

Conditions Where Practice Applies

Wherever traffic will be leaving a construction site and moving directly onto a public road or other paved area.

Planning Considerations

Construction entrances provide an area where mud can be removed from construction vehicle tires before they enter a public road. If the action of the vehicle traveling over the gravel pad is not sufficient to remove most of the mud, then the tires must be washed before the vehicle enters a public road. If washing is used, provisions must be made to intercept the wash water and trap the sediment before it is carried off-site. Construction entrances should be used in conjunction with the stabilization of construction roads to reduce the amount of mud picked up by construction vehicles.

Design Criteria

Aggregate Size

FDOT No. 1 Coarse Aggregate (1.5 - 3.5 inch stone)(4 - 9 cm) should be used. Wood chips may be used for single family residential construction, provided that they can be prevented from floating away in a storm.

Entrance Dimensions

The aggregate layer must be at least 6 inches (15 cm) thick. It must extend the full width of the vehicular ingress and egress area. The length of the entrance must be at least 50 feet (20 m). The entrance must widen at its connection to the roadway in order to accommodate the turning radius of large trucks. (See Plate 4.03a)

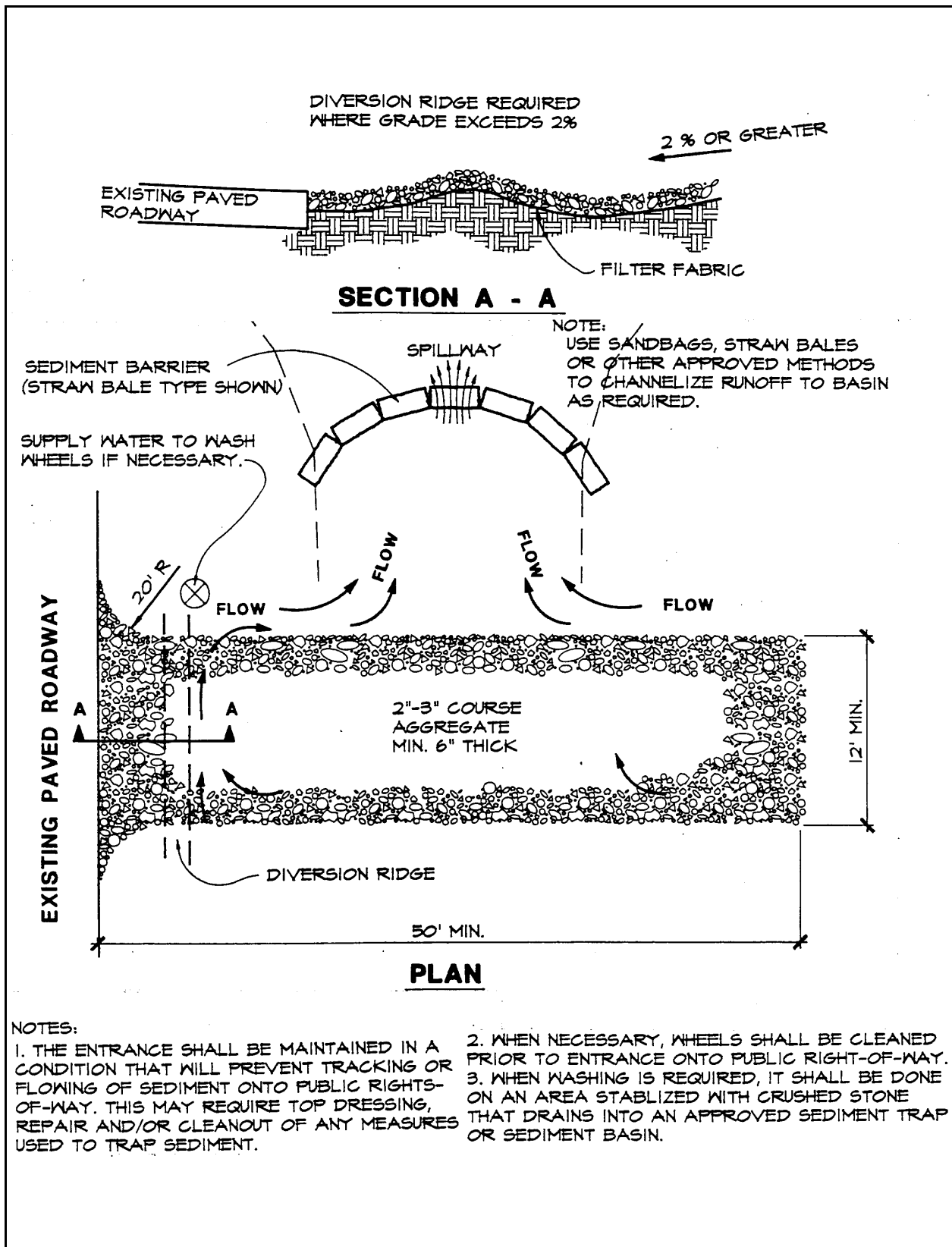

Plate 4.03a Temporary Gravel Construction Entrance

Source: Erosion Draw

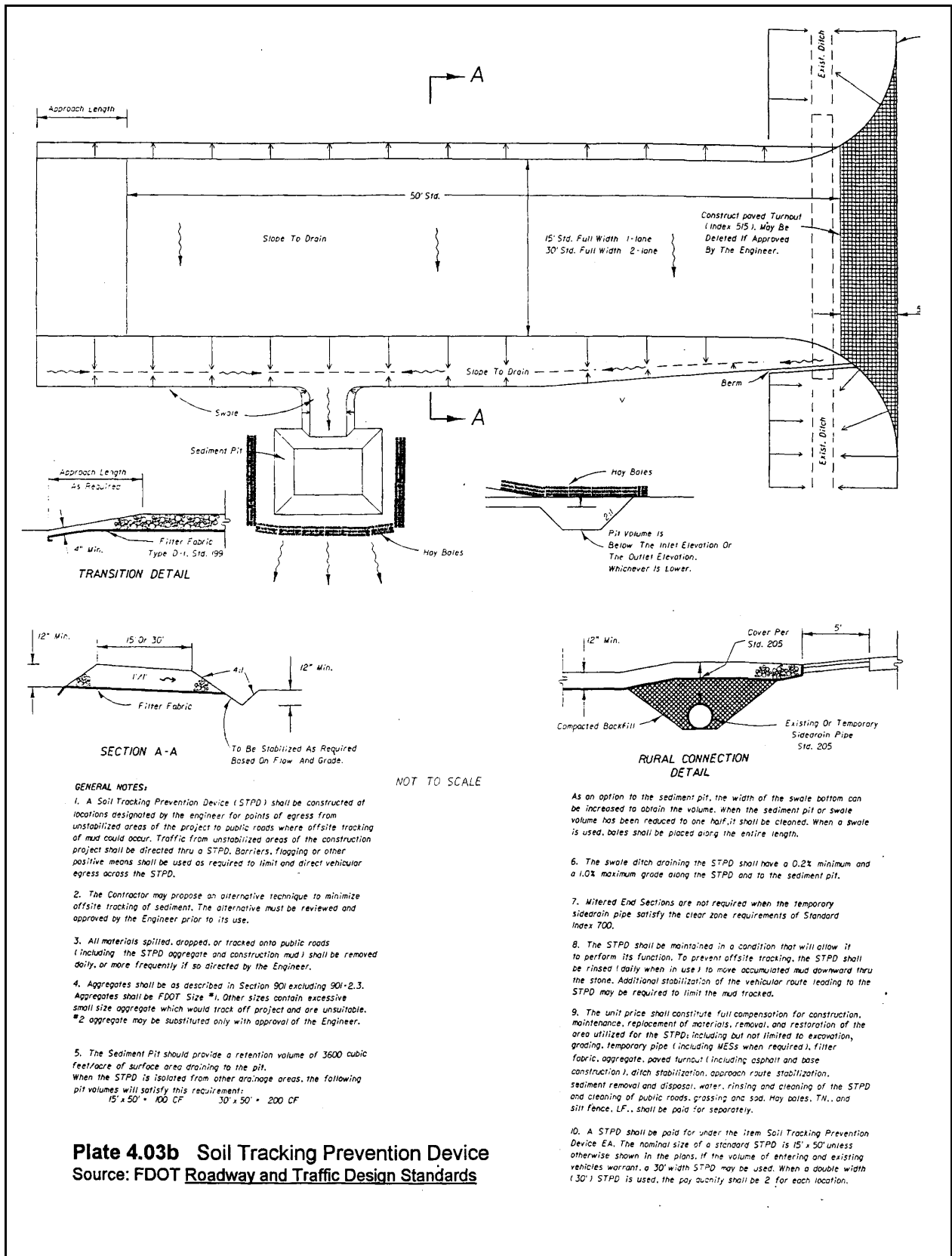

Plate 4.03b Soil Tracking Prevention Device
 Source: FDOT Roadway and Traffic Design Standards

Plate 4.03b Soil Tracking Prevention Device
 Source: FDOT Roadway and Traffic Design Standards

Washing

If conditions on the site are such that most of the mud is not removed by the vehicles traveling over the gravel, then the tires of the vehicles must be washed before entering a public road. Wash water must be carried away from the entrance to a settling area to remove sediment (See Plate 4.03b). A wash rack may also be used to make washing more convenient and effective (See Plate 4.03c).

Location

The entrance should be located to provide for maximum utility by all construction vehicles.

Construction Specifications

The area of the entrance should be cleared of all vegetation, roots, and other objectionable material. A geotextile should be laid down to improve stability and simplify maintenance. The gravel shall then be placed over the geotextile to the specified dimensions.

Any drainage facilities required because of washing should be constructed according to approved specifications. If wash racks are used, they should be installed according to manufacturer's specifications.

Maintenance

The entrance shall be maintained in a condition which will prevent tracking or flow of mud onto public rights-of-way. This may require periodic top dressing with 2-inch (5 cm) stone, as conditions demand, and repair and/or clean out of any structures used to trap sediments. All materials spilled, dropped, washed, or tracked from vehicles onto roadways or into storm drains must be removed immediately. Look for signs of trucks and trailered equipment "cutting corners" where the gravel meets the roadway. Sweep the paved road daily for sediments and stones.

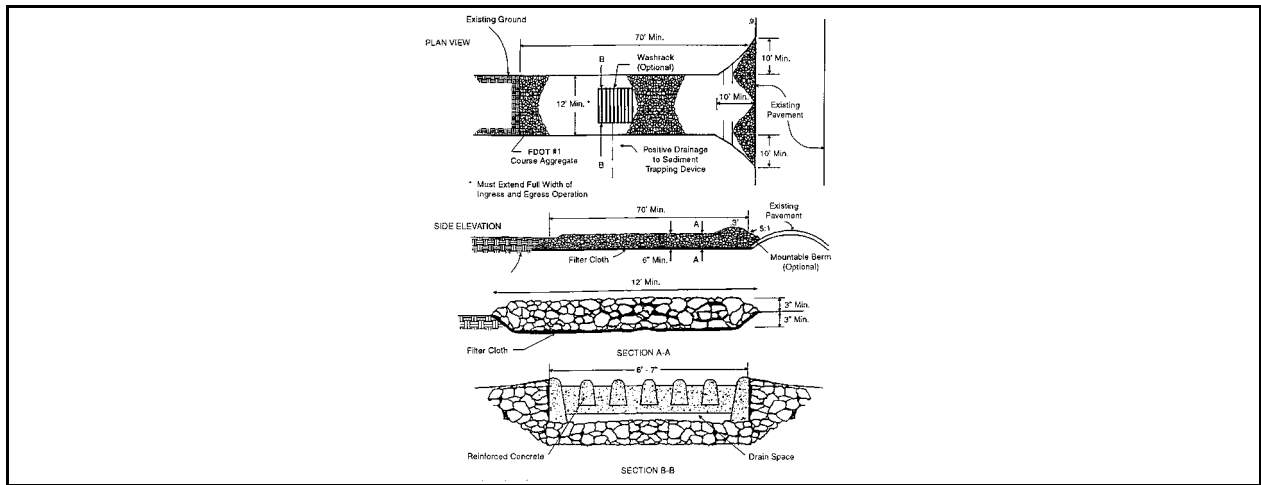

Plate 4.03c Construction Entrance with Wash Rack
 Source: 1983 Maryland Standards for Soil Erosion and Sediment Control

4.04 CONSTRUCTION ROAD STABILIZATION **(ES BMP 1.02)**

Definition

The temporary stabilization of access roads, subdivision roads, parking areas, and other on-site vehicle transportation routes with stone immediately after grading.

Purposes

1. To reduce the erosion and degradation of temporary roadbeds by construction traffic, especially during wet weather.
2. To reduce the erosion and minimize regrading of permanent roadbeds between the time of initial grading and final stabilization.

Conditions Where Practice Applies

Wherever stone-base roads or parking areas are constructed, whether permanent or temporary, for use by construction traffic.

Planning Considerations

Areas which are graded for construction vehicle transport and parking purposes are especially susceptible to erosion. The exposed soil surface is continually disturbed, leaving no opportunity for vegetative stabilization. Such areas also tend to collect and transport runoff waters along their surfaces. During wet weather, they often become muddy quagmires which generate significant quantities of sediment that may pollute nearby streams or be transported off-site on the wheels of construction vehicles. Dirt roads can become so unstable during wet weather that they are virtually unusable.

Permanent roads and parking areas should be paved as soon as possible after grading. However, it is understandable that funds for this purpose may not be available in the early phases of the development project. As an alternative, the early application of stone may solve potential erosion and stability problems and eliminate later regrading costs. Immediate stabilization of such areas with stone may cost more money initially, but it may actually save money over the life of the project by increasing the usefulness of the road during wet weather. Some of the stone will also probably remain in place for use as part of the final base course of the road, thereby offsetting the initial expenditure.

Specifications

Temporary Access Roads and Parking Areas

1. Temporary roads shall follow the contour of the natural terrain to the extent possible. Slopes should not exceed 10 percent.
2. Temporary parking areas should be located on naturally flat areas to minimize grading. Grades should be sufficient to provide drainage but should not exceed 4 percent.
3. Roadbeds shall be at least 14 feet (5.5 m) wide for one-way traffic and 20 feet (8 m) wide for two-way traffic.
4. All cuts and fills shall have side slopes that are stable for the particular soil. Slopes of 2:1 or flatter are recommended for clay soils, and slopes of 3:1 or flatter are recommended for sandy soils.
5. Stormwater system shall be provided as needed and shall be designed and constructed according to applicable regulations.
6. The roadbed or parking surface shall be cleared of all vegetation, roots, and other objectionable material.
7. A 6 inch (15 cm) course of FDOT No. 1 aggregate shall be applied immediately after grading or the completion of utility installation within the right-of-way. Filter fabric may be applied to the roadbed for additional stability according to the fabric manufacturer's specifications.

Permanent Roads and Parking Areas

Permanent roads and parking areas shall be designed and constructed according to applicable FDOT or local criteria except that an initial base course of gravel of at least 6 inches (15 cm) shall be applied immediately following grading.

Vegetation

All roadside ditches, cuts, fills and disturbed areas adjacent to parking areas and roads shall be stabilized with appropriate temporary or permanent vegetation according to the applicable vegetative practices contained in this handbook.

Maintenance

Both temporary and permanent roads and parking areas may require periodic top dressing with new gravel. Seeded areas adjacent to the roads and parking areas should be checked periodically to insure that a vigorous stand of vegetation is maintained. Roadside ditches and other drainage structures should be checked regularly to insure that they do not become clogged with silt or other debris.

4.05 STRAW BALE BARRIER **(ES BMP 1.05)**

Definition

A temporary sediment barrier consisting of a row of entrenched and anchored straw bales.

Purposes

1. To intercept and detain small amounts of sediment from disturbed areas of limited extent.
2. To decrease the velocity of sheet flows and low-to-moderate level channel flows.

Conditions Where Practice Applies

1. Below disturbed areas subject to sheet and rill erosion.
2. Where the size of the drainage area is no greater than 1/4 acre per 100 feet (1.3 ha/100 m) of barrier length; the maximum slope length behind the barrier is 100 feet (30 m); and the maximum slope gradient behind the barrier is 50 percent (2:1).
3. In minor swales or ditch lines where the maximum contributing drainage area is no greater than 2 acres(0.8 ha).
4. Where effectiveness is required for less than 3 months.
5. Under no circumstances should straw bale barriers be constructed in streams or in swales where there is a possibility of a washout.

Planning Considerations

Improper use of straw bale barriers has been a major problem. Straw bale barriers have been used in streams and drainageways where high water velocities and volumes have destroyed or impaired their effectiveness. Improper placement and installation of the barriers, such as staking the bales directly to the ground with no soil seal or entrenchment, has allowed undercutting and end flow. This has resulted in additions instead of removal of sediment from runoff waters. Finally, inadequate maintenance lowers the effectiveness of these barriers. Trapping efficiencies of carefully installed straw bale barriers on one project in Virginia dropped from 57 percent to 16 percent in one month due to lack of maintenance.

There are serious questions about the continued use of straw bale barriers as they are presently installed and maintained. Averaging approximately \$3 to \$6 per linear foot installed (\$10 to \$20 / m) the thousands of straw bale barriers used annually in Florida represent sufficient expense that optimum installation procedures should be emphasized. If such procedures are carefully followed, straw bale barriers can be quite effective.

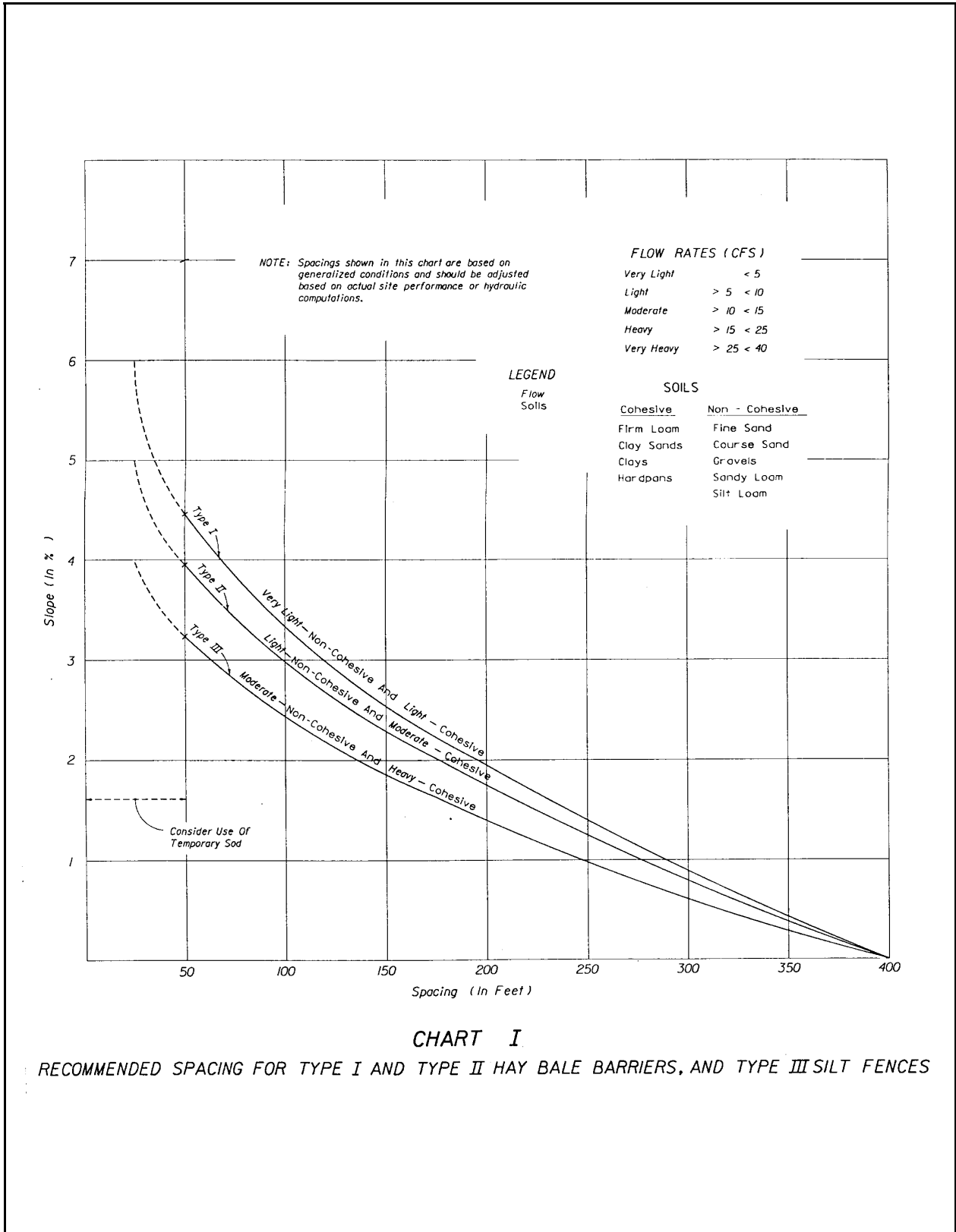

CHART I

RECOMMENDED SPACING FOR TYPE I AND TYPE II HAY BALE BARRIERS, AND TYPE III SILT FENCES

Plate 4.05a FDOT Standard Index 102, Chart 1
Source: FDOT Erosion and Sediment Control Handbook

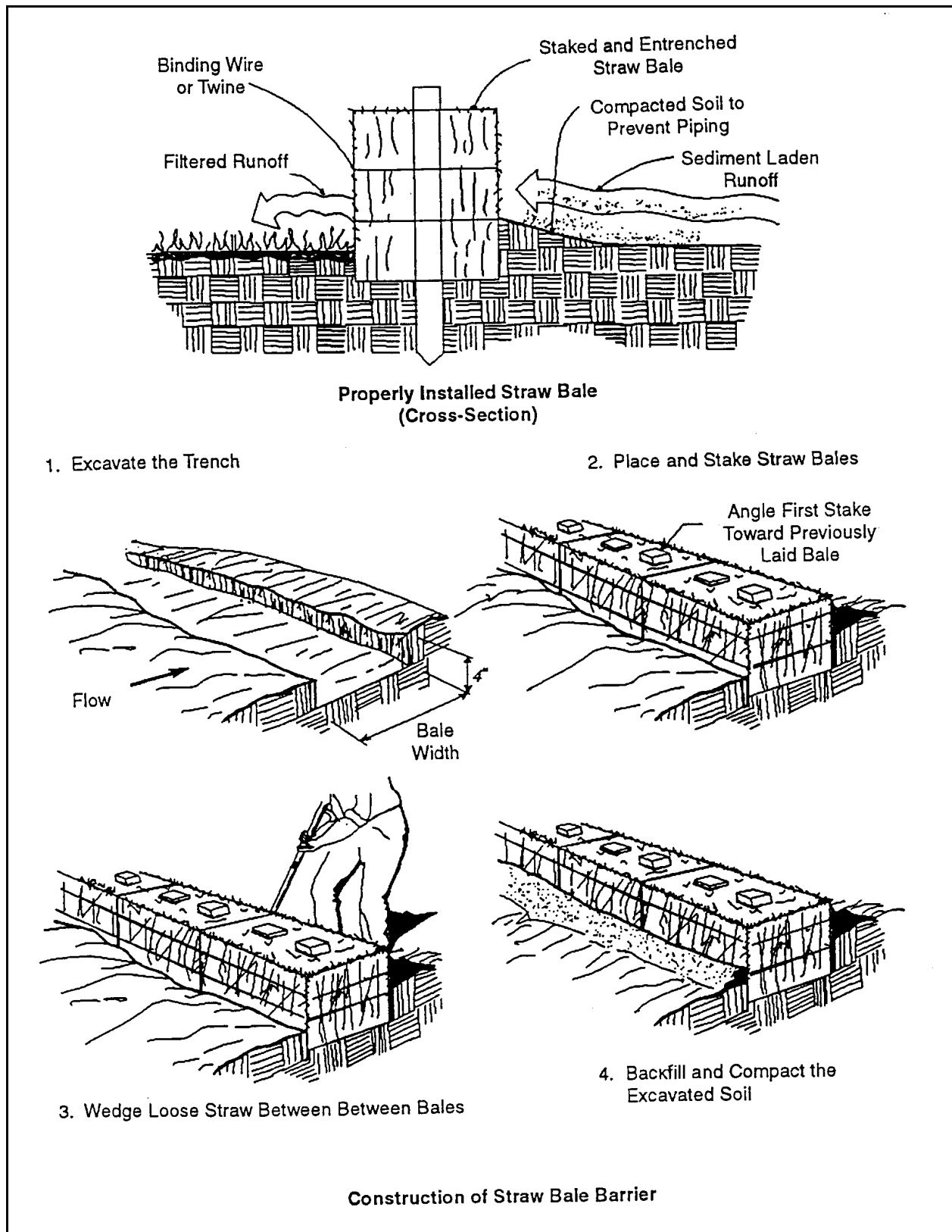

Plate 4.05b Construction of a Straw Bale Barrier

Source: NRCS

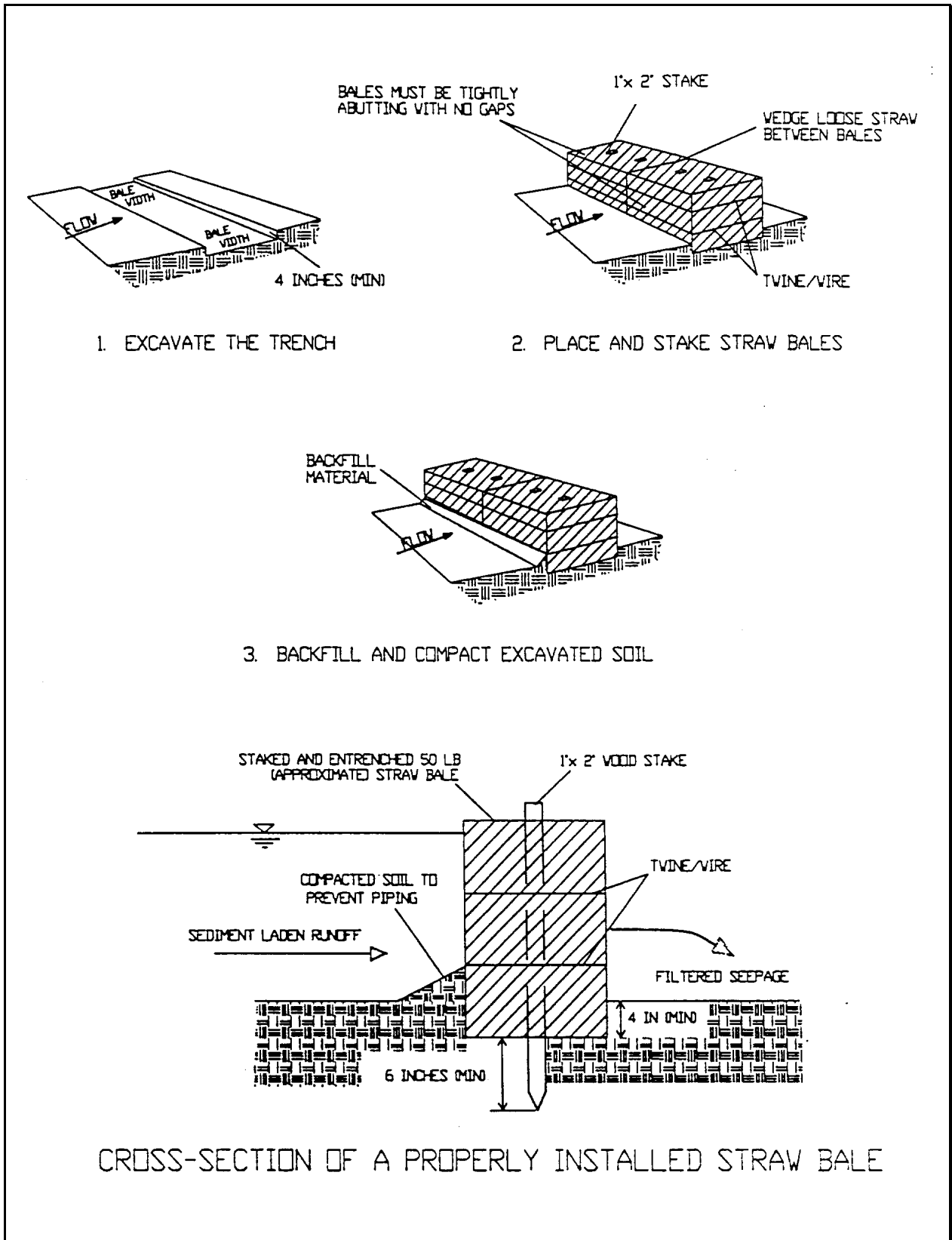

Plate 4.05c Installation of Straw Bales
 Source: HydroDynamics, Inc.

Design Criteria

A formal design is not required for many small projects and for minor or incidental applications. For larger projects refer to Figure 4.05a (FDOT Standard Index 102, Chart 1) for guidance on recommended spacing.

Construction Specifications

Sheet Flow Applications

1. Bales shall be placed in a single row, lengthwise on the contour, with ends of adjacent bales tightly abutting each other.
2. All bales shall be either wire-bound or string-tied. Straw bales shall be installed so that bindings are oriented around the sides rather than along the tops and bottoms of the bales (in order to prevent deterioration of the bindings). (See Plate 4.05b)
3. The barrier shall be entrenched and backfilled. A trench shall be excavated the width of a bale and the length of the proposed barrier to a minimum depth of 4 inches (10 cm). After the bales are staked and chinked, the excavated soil shall be backfilled against the barrier. Backfill soil shall conform to the ground level on the downhill side and shall be built up to 4 inches (10 cm) against the uphill side of the barrier (See Plate 4.05c)
4. Each bale shall be securely anchored by at least two 2" x 2" (5 cm x 5 cm) minimum wooden stakes or two #5 (16 mm) minimum rebars at least 3 feet (0.9 m) driven through the bale. The first stake in each bale shall be driven toward the previously laid bale to force the bales together. Stakes or rebars shall be driven deep enough into the ground to securely anchor the bales. Straw bale barriers placed on paved surfaces may be secured by placing heavy sand bags on top, and/or by bracing with 2 x 4's (5 x 10 cm). (See Plate 4.05d)
5. The gaps between bales shall be chinked (filled by wedging) with straw to prevent water from escaping between the bales. (See Plate 4.05b) Loose straw scattered over the area immediately uphill from a straw bale barrier tends to increase barrier efficiency.
6. When bales are installed at the toe of a slope, they should be placed away from the slope for increased storage capacity. (See Plate 4.05e)
7. Inspection shall be frequent and repair or replacement shall be made promptly as needed.
8. Straw bale barriers shall be removed when they have served their usefulness, but not before the upslope areas have been permanently stabilized.

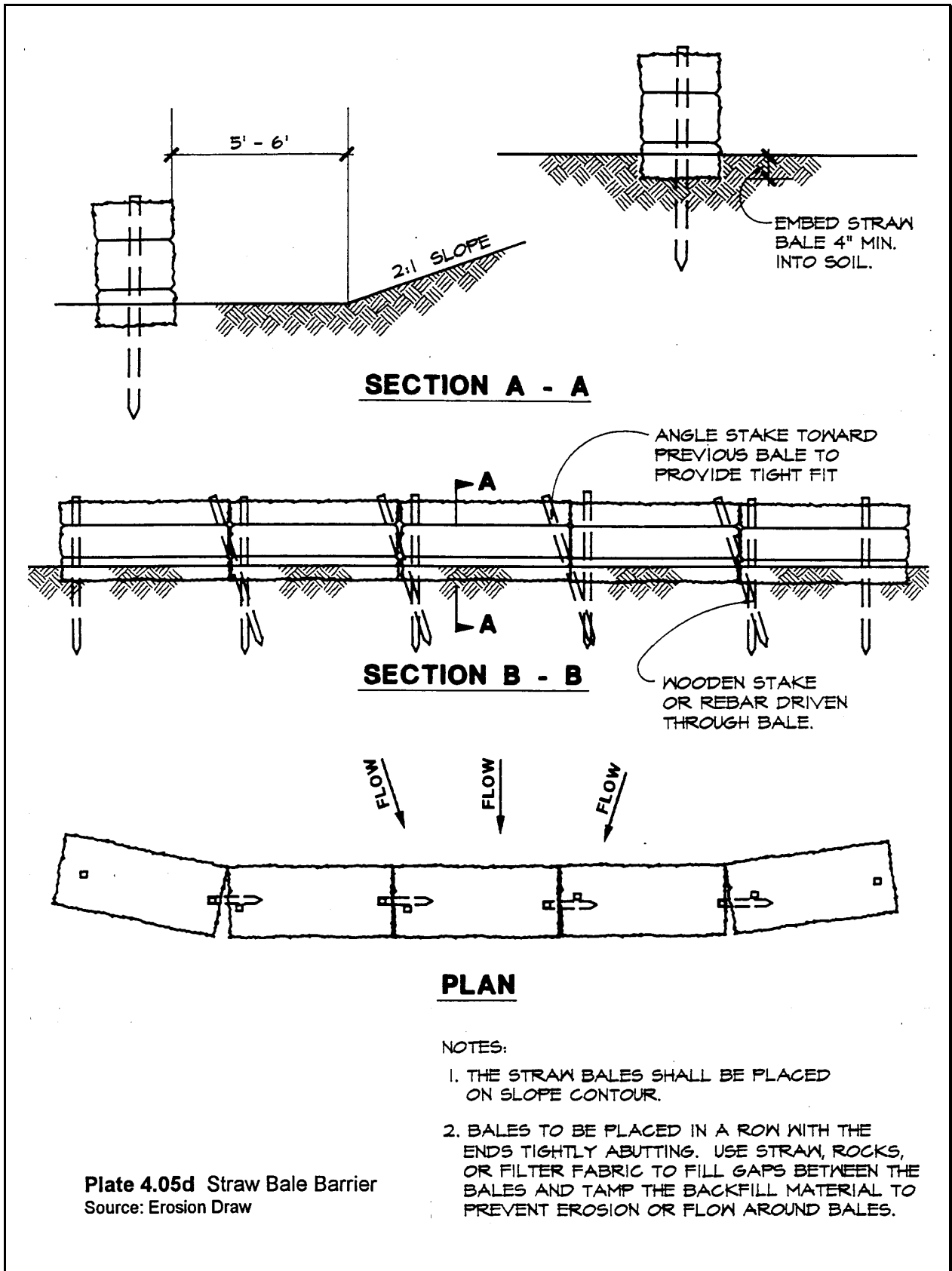

Plate 4.05d Straw Bale Barrier
Source: Erosion Draw

Plate 4.05d Straw Bale Barrier
Source: Erosion Draw

Channel Flow Applications

1. Bales shall be placed in a single row, lengthwise, oriented perpendicular to the contour, with ends of adjacent bales tightly abutting each other.
2. The remaining steps for installing a straw bale barrier for sheet flow applications apply here, with the following addition.
3. The barrier shall be extended to such a length that the bottoms of the end bales are higher in elevation than the top of the lowest middle bale to assure that sediment-laden runoff will flow either through or over the barrier, but not around it. (See Plate 4.05f)

Maintenance

1. Straw bale barriers shall be inspected immediately after each rainfall and at least daily during prolonged rainfall.
2. Close attention shall be paid to the repair of damaged bales, end runs and undercutting beneath bales.
3. Necessary repairs to barriers or replacement of bales shall be accomplished promptly.
4. Sediment deposits should be removed after each rainfall. They must be removed when the level of deposition reaches approximately one-half the height of the barrier.
5. Any sediment deposits remaining in place after the straw bale barrier is no longer required shall be dressed to conform to the existing grade, prepared, and seeded.

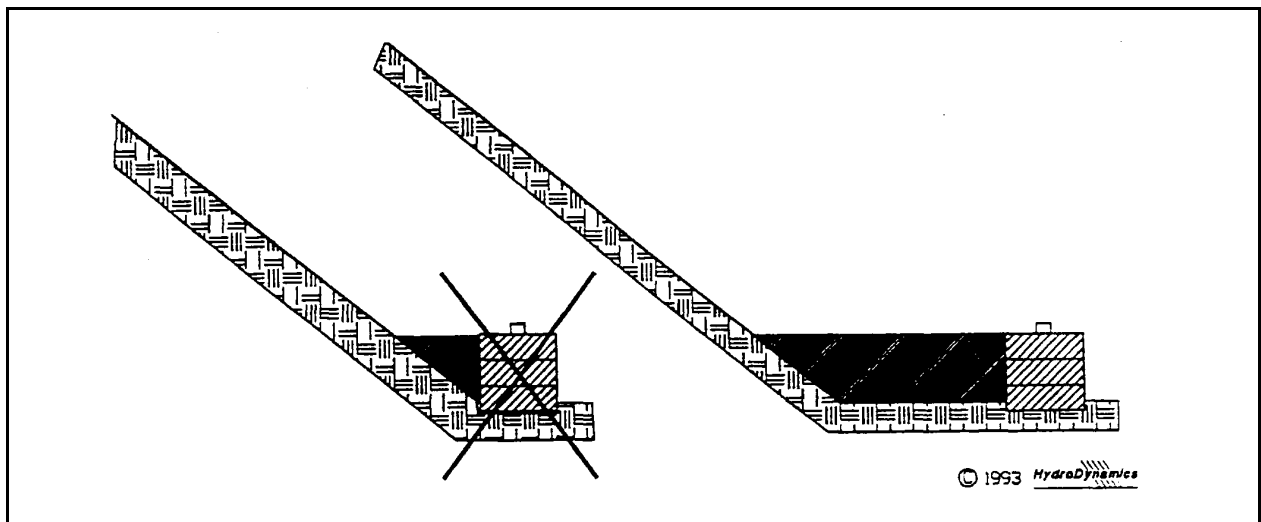

Plate 4.05e Proper Placement of Straw Bales at the Toe of a Slope

Source: HydroDynamics, Inc.

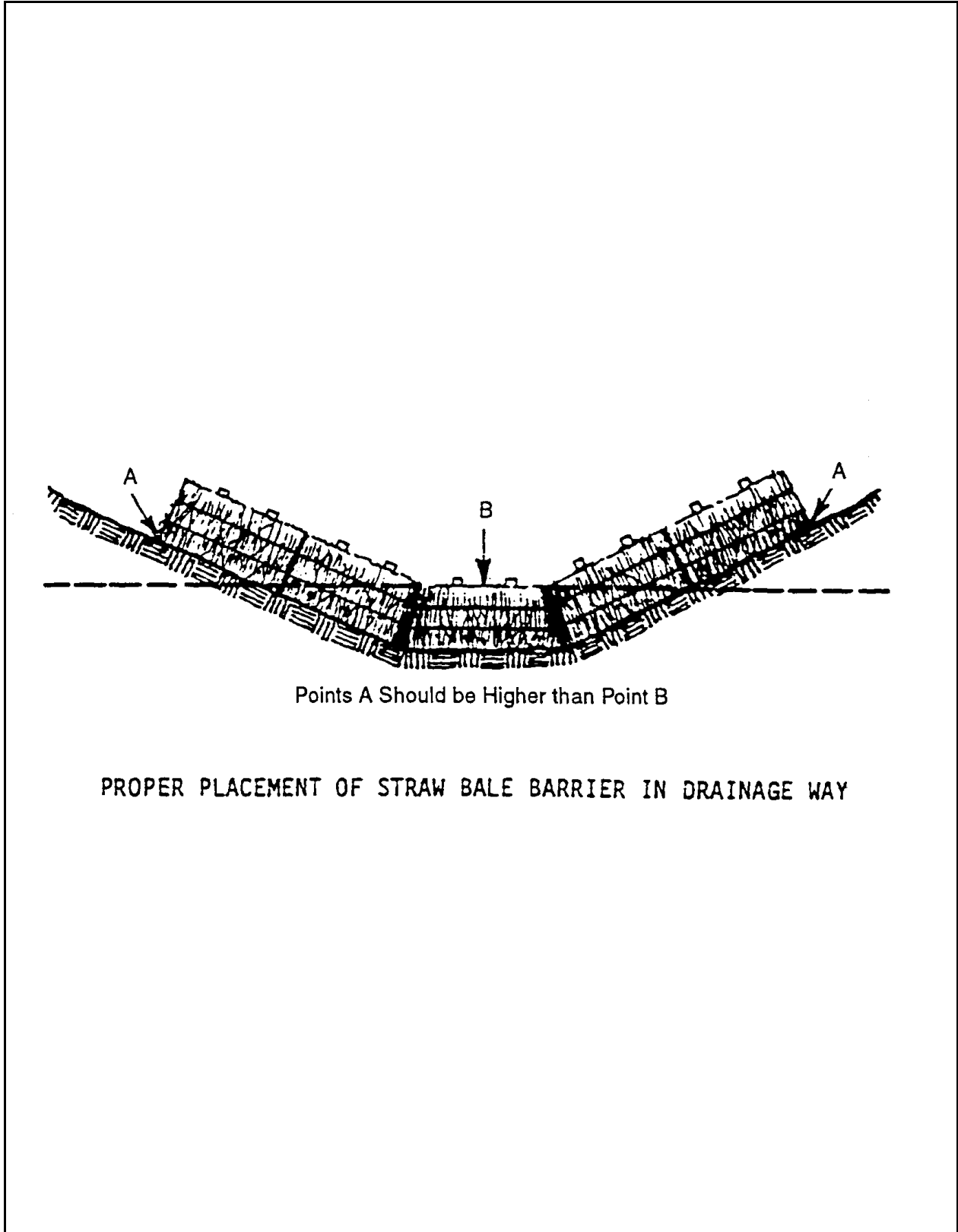

Plate 4.05f Proper Placement of Straw Bale Barrier in a Drainage Way

Source: Installation of Straw and Fabric Filter Barriers for Sediment Control, Sherwood and Wyant

4.06 SILT FENCE **(ES BMP 1.06)**

Definition

A temporary sediment barrier consisting of a filter fabric stretched across and attached to supporting posts and entrenched. There are two types. The silt fence is a temporary linear filter barrier constructed of synthetic filter fabric, posts, and, depending upon the strength of the fabric used, wire fence for support. The filter barrier is constructed of stakes and burlap or synthetic filter fabric.

Purposes

1. To intercept and detain small amounts of sediment from disturbed areas during construction operations.
2. To decrease the velocity of sheet flows and low-to-moderate level channel flows.

Conditions When Practice Applies

1. Below disturbed areas where erosion would occur in the form of sheet and rill erosion.
2. Where the size of the drainage area is no more than 1/4 acre per 100 feet (1.3 ha /100 m) of silt fence length; the maximum slope length behind the barrier is 100 feet (30 m); and the maximum gradient behind the barrier is 50 percent (2:1).
3. In minor swales or ditch lines where the maximum contributing drainage area is no greater than 2 acres (0.8 ha).
4. Under no circumstances should silt fences be constructed in live streams or in swales or ditch lines where flows are likely to exceed one cubic foot per second (cfs)(0.03 m³ / sec.). See Design Criteria for further clarification.

Planning Considerations

Silt fences can trap a much higher percentage of suspended sediments than can straw bales and may be preferable to straw barriers in many cases. While the failure rate of silt fences is lower than that of straw barriers, this failure rate is still due mainly to improper installation. The most effective application is to install two parallel silt fences spaced a minimum of three feet apart. The installation and maintenance methods outlined here can improve performance.

Filter barriers are inexpensive structures composed of burlap or standard weight synthetic filter fabric stapled to wooden stakes. Flow rates through burlap filter barriers are slightly slower and filtering efficiency is significantly higher than for straw bale barriers.

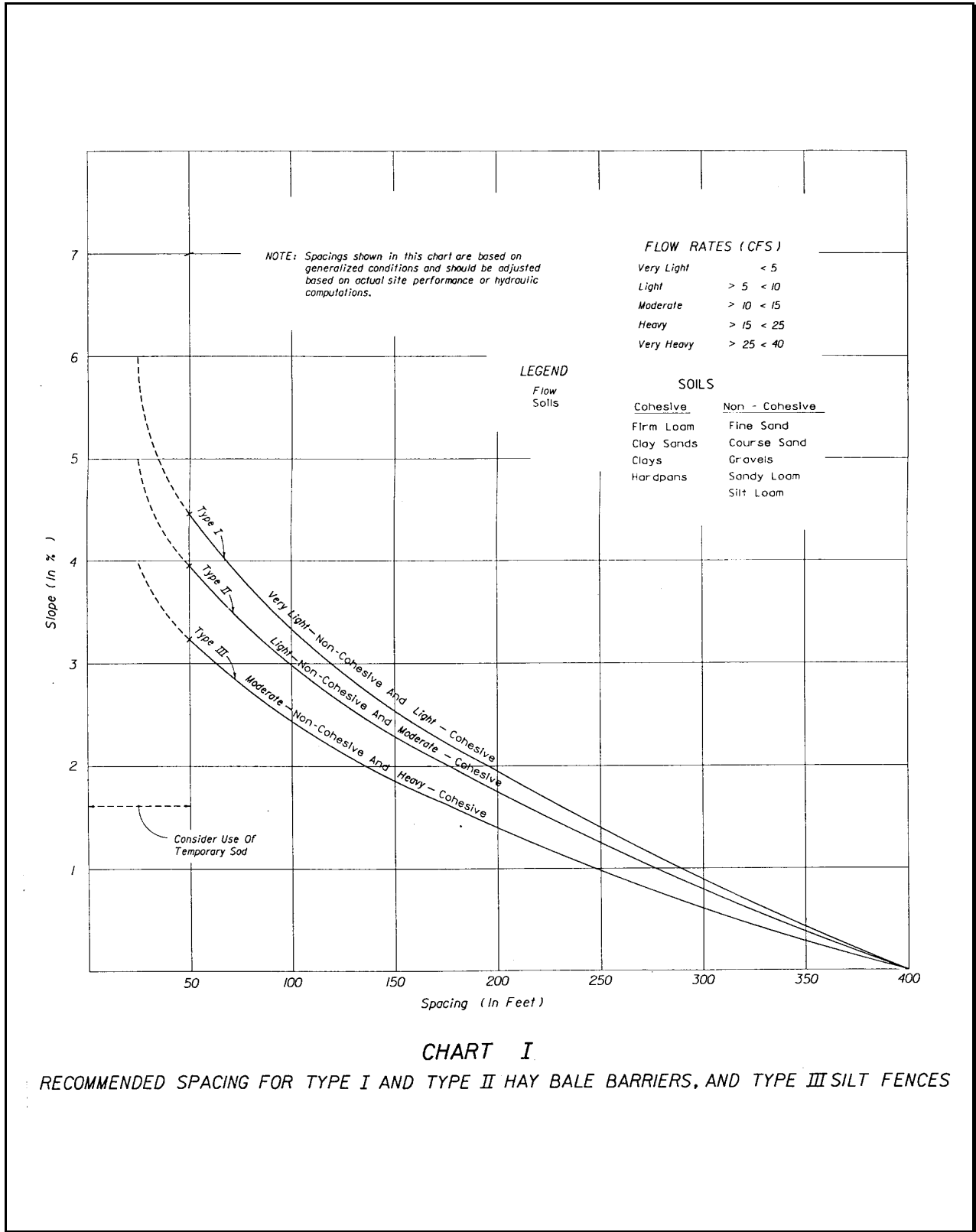

Plate 4.06a FDOT Standard Index 102, Chart 1
Source: FDOT Roadway and Traffic Design Standards

Silt fences composed of a wire support fence and an attached synthetic filter fabric slow the flow rate significantly but have a higher filtering efficiency than burlap. Both woven and non-woven synthetic fabrics are commercially available. The woven fabrics generally display higher strength than the non-woven fabrics. When tested under acid and alkaline water conditions, most of the woven fabrics increase in strength. There are a variety of reactions among the non-woven fabrics. The same is true of testing under extensive ultraviolet radiation. Permeability rates vary regardless of fabric type. While all of the fabrics demonstrate very high filtering efficiencies for sandy sediments, there is considerable variation among both woven and non-woven fabrics when filtering the finer silt and clay particles.

Design Criteria

1. No formal design is required for many small projects and for minor and incidental applications. For channel flow applications refer to FDOT Standard Index 102, Chart 1 (Plate 4.06a) for guidance on recommended spacing.
2. Filter barriers shall have an expected usable life of 3 months. They are applicable in ditch lines, around drop inlets, and at temporary locations where continuous construction changes the earth contour and runoff characteristics and where low or moderate flows (not exceeding 1 cfs) ($0.03 \text{ m}^3 / \text{sec.}$) are expected.
3. Silt fences, because they have much lower permeability than burlap filter barriers, have their applicability limited to situations in which only sheet or overland flows are expected. They normally cannot filter the volumes of water generated by channel flows, and many fabrics do not have sufficient structural strength to support the weight of water ponded behind the fence line. Their expected usable life is 6 months.

Construction Specifications

Materials

1. Synthetic filter fabric shall be a pervious sheet of propylene, nylon, polyester, or polyethylene yarn. Synthetic filter fabric shall contain ultraviolet ray inhibitors and stabilizers to provide a minimum of 6 months of expected usable construction life at a temperature range of 0° F to 120° F (-17C to 49C).
2. Burlap shall be 10 ounces per square yard (340 g/m^2) fabric.
3. Posts for silt fences shall be either 4 inch (10 cm) diameter wood, or 1.33 pounds per linear foot (2 kg/m) steel with a minimum length of 5 feet (1.5 m). Steel posts shall have projections for fastening wire to them.
4. Stakes for filter barriers shall be 1" x 2" ($2.5 \times 5 \text{ cm}$) wood (preferred), or equivalent metal with a minimum length of 3 feet (90 cm).

1. Set Stakes

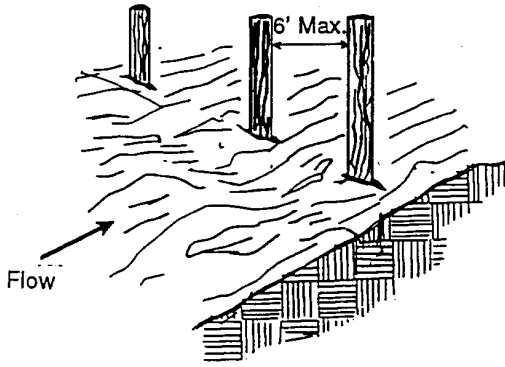

2. Excavate a 4" x 4" Trench Upslope Along the Line of Stakes

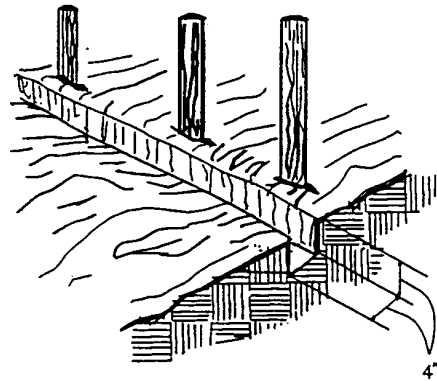

3. Staple Filter Material to Stakes and Extend it into the Trench

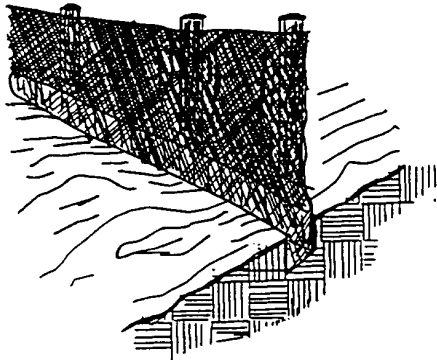

4. Backfill and Compact the Excavated Soil

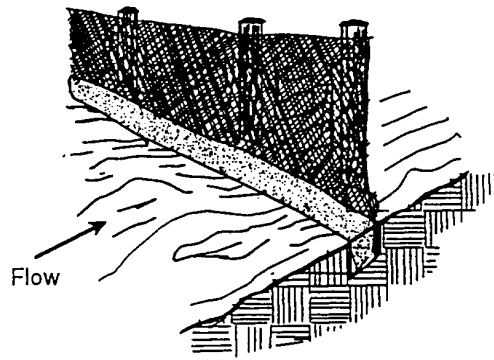

Sheet Flow Installation
(Perspective View)

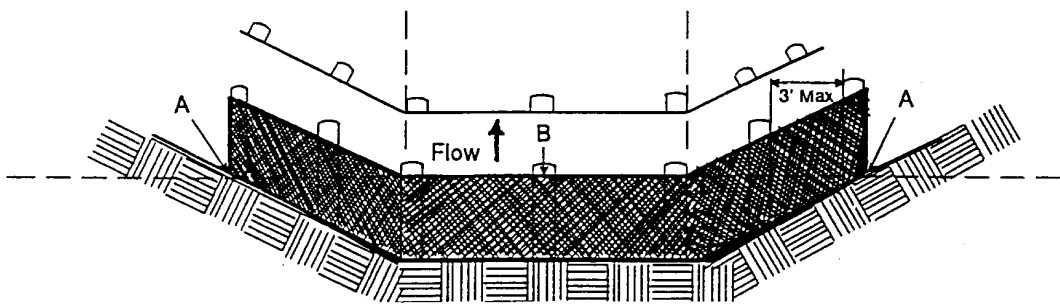

Points A Should be Higher than Point B

Drainageway Installation
(Front Elevation)

Plate 4.06b Construction of a Filter Barrier
Source: NRCS

5. Wire fence reinforcement for silt fences using standard strength filter cloth shall be a minimum of 36 inches (90 cm) in height, a minimum of 14 gauge and shall have a maximum mesh spacing of 6 inches (15 cm).

Sheet Flow Applications: Filter Barrier

This sediment barrier may be constructed using burlap or standard strength synthetic filter fabric. It is designed for low or moderate flows not exceeding 1 cfs. ($0.03 \text{ m}^3 / \text{sec.}$). (See Plate 4.06b)

1. The height of a filter barrier shall be a minimum of 15 inches (38 cm) and shall not exceed 18 inches (45 cm).
2. Burlap or standard strength synthetic filter fabric shall be purchased in a continuous roll and cut to the length of the barrier to avoid the use of joints (and thus improve the strength and efficiency of the barrier).
3. The stakes shall be spaced a maximum of 3 feet (90 cm) apart at the barrier location and driven securely into the ground a minimum of 8 inches (20 cm).
4. A trench shall be excavated approximately 4 inches (10 cm) wide and 4 inches (10 cm) deep along the line of stakes and upslope from the barrier.
5. The filter material shall be stapled to the wooden stakes, and 8 inches (20 cm) of the fabric shall be extended into the trench. Heavy duty wire staples at least 1/2 inch (13 mm) long, hog rings, or tie wire shall be used. Filter material shall not be stapled to existing trees.
6. The trench shall be backfilled and the soil compacted over the filter material.
7. Filter barriers shall be removed when they have served their useful purpose, but not before the upslope area has been permanently stabilized.

Sheet Flow Application: Silt Fence

This sediment barrier uses standard strength or extra strength synthetic filter fabrics. It is designed for situations in which only sheet or overland flows are expected. (See Plate 4.06d)

1. The height of a silt fence shall not exceed 36 inches (90 cm). Higher fences may impound volumes of water sufficient to cause failure of the structure.
2. The filter fabric shall be purchased in a continuous roll cut to the length of the barrier to avoid the use of joints. When joints are necessary, filter cloth shall be spliced as described in item No. 8 below.

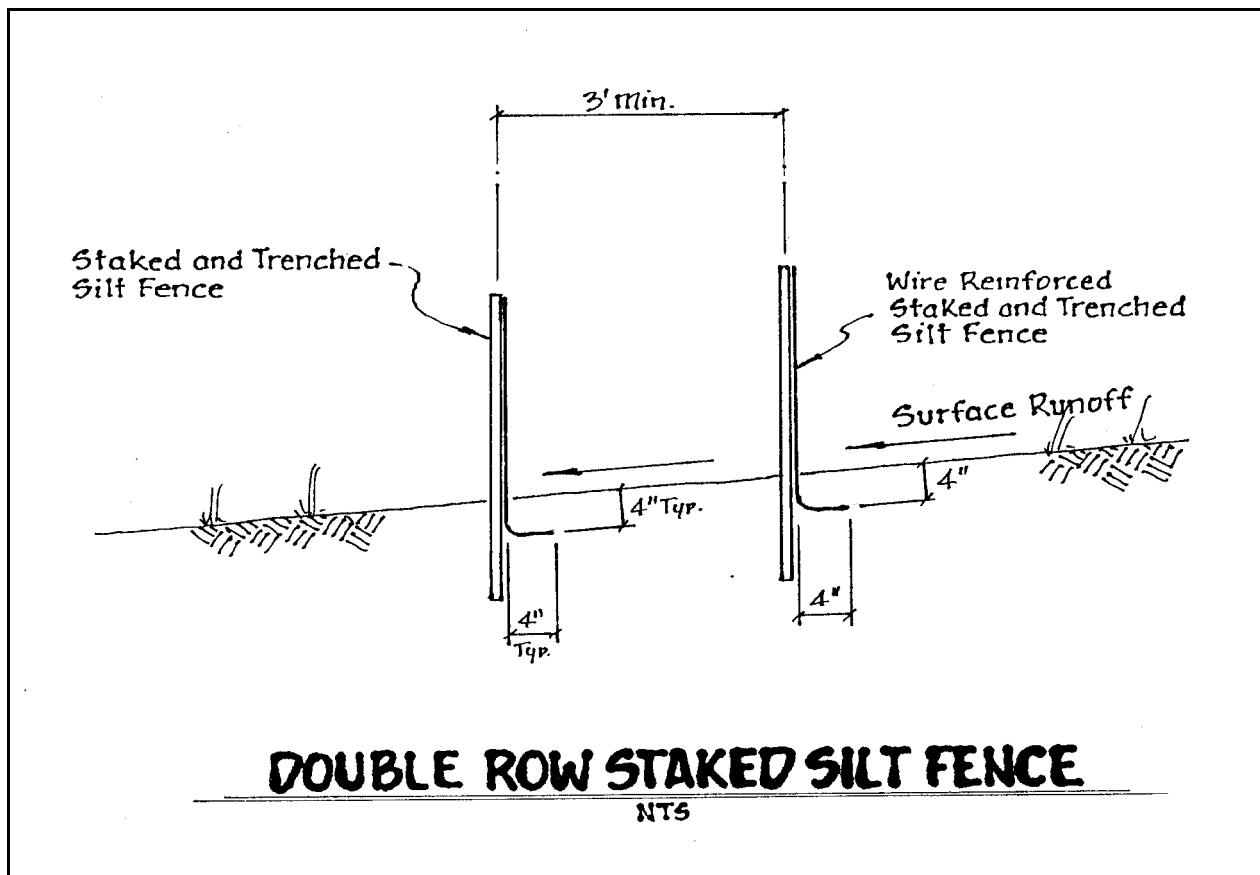
**Plate 4.06c** Double Row Staked Silt Fence

Source: Reedy Creek Improvement District

3. Posts shall be spaced a maximum of 10 feet (3 m) apart at the barrier location and driven securely into the ground a minimum of 12 inches (30 cm). When extra strength fabric is used without the wire support fence, post spacing shall not exceed 6 feet (1.8 m).
4. A trench shall be excavated approximately 4 inches (10 cm) wide and 4 inches (10 cm) deep along the line of posts and upslope from the barrier.
5. When standard strength filter fabric is used, a wire mesh support fence shall be fastened securely to the upslope side of the posts using heavy duty wire staples at least 1 inch (25 mm) long, tie wires, or hog rings. The wire shall extend into the trench a minimum of 2 inches (5 cm) and shall not extend more than 36 inches (90 cm) above the original ground surface.
6. The standard strength filter fabric shall be stapled or wired to the fence, and 8 inches (20 cm) of the fabric shall be extended into the trench. The fabric shall not extend more than 36 inches (90 cm) above the original ground surface.

7. When extra strength filter fabric and closer post spacing are used, the wire mesh support fence may be eliminated. In such a case, the filter fabric is stapled or wired directly to the posts with all other provisions of item No. 6 applying.
8. When attaching two silt fences together, place the end post of the second fence inside the end post of the first fence. Rotate both posts at least 180 degrees on a clockwise direction to create a tight seal with the filter fabric. Drive both posts into the ground and bury the flap. (See Plate 4.06g)
9. The trench shall be backfilled and the soil compacted over the filter fabric.
10. The most effective application consists of a double row of silt fences spaced a minimum of three feet apart. The three foot separation is so that if the first row collapses it will not fall on the second row. Wire or synthetic mesh is may be used to reinforce the first row. (See Plate 4.06c)
11. When used to control sediments from a steep slope, silt fences should be placed away from the toe of the slope for increased holding capacity. (See Plate 4.06f)
12. Silt fences shall be removed when they have served their useful purpose, but not before the upslope area has been permanently stabilized.

Channel Flow Applications

1. If a filter barrier is to be constructed across a ditch line or swale, the barrier shall of sufficient length such that the bottom of the end sections of fence are higher in elevation than the top of the center section to eliminate end flow. The plan configuration shall resemble an arc or horseshoe with the ends oriented upslope. (See Plate 4.06b).
2. Use FDOT Standard Index 102, Chart 1(Plate 4.06a) as a guide for spacing.
3. The remaining steps for installing a filter barrier for sheet flow applications apply here.

Maintenance

1. Silt fences and filter barriers shall be inspected immediately after each rainfall and at least daily during prolonged rainfall. Any required repairs shall be made immediately.
2. Should the fabric on a silt fence or filter barrier decompose or become ineffective before the end of the expected usable life and the barrier still be necessary, the fabric shall be replaced promptly.
3. Sediment deposits should be removed after each storm event. They must be removed when deposits reach approximately one-half the height of the barrier.

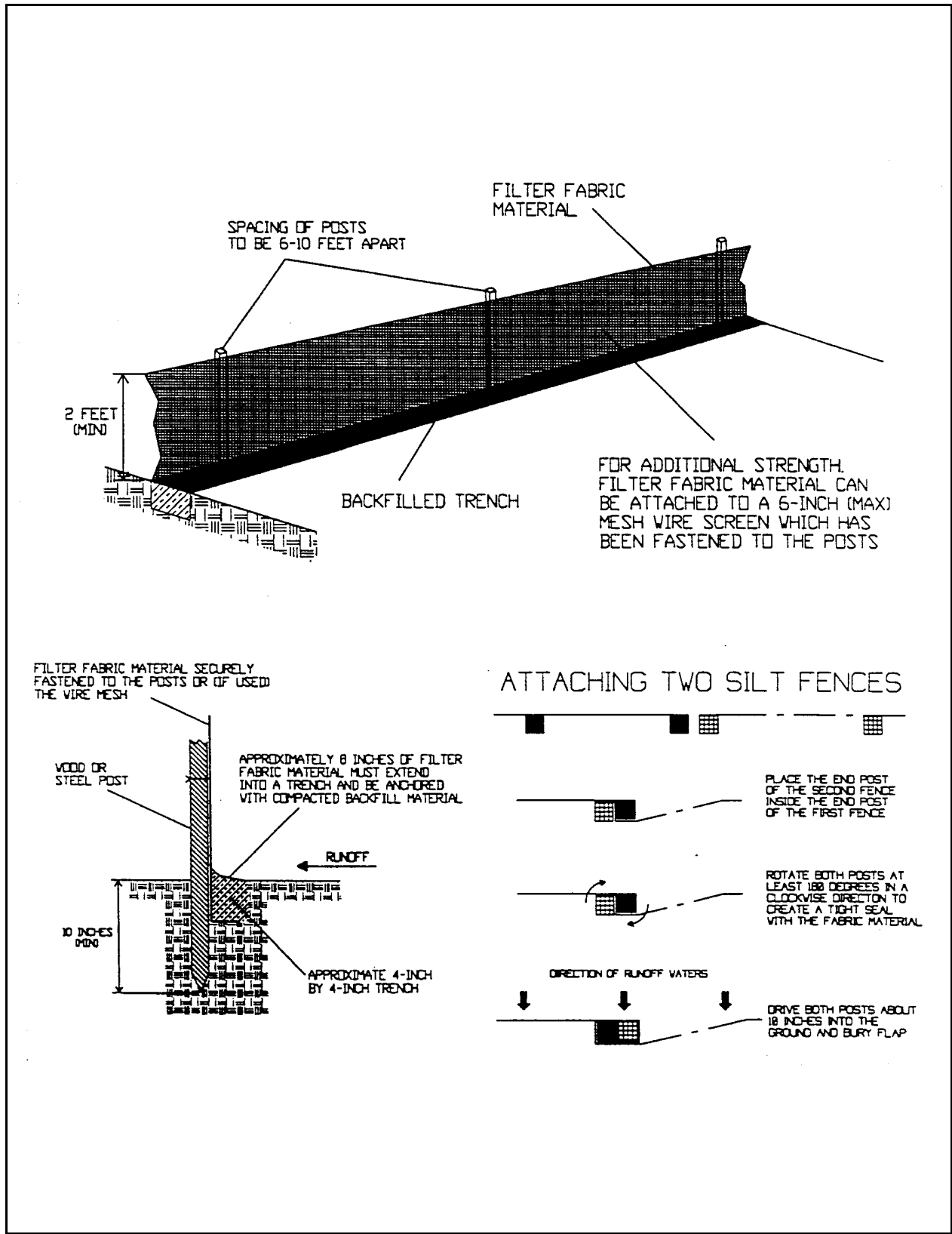

Plate 4.06d Installing a Filter Fabric Silt Fence
 Source: HydroDynamics, Inc.

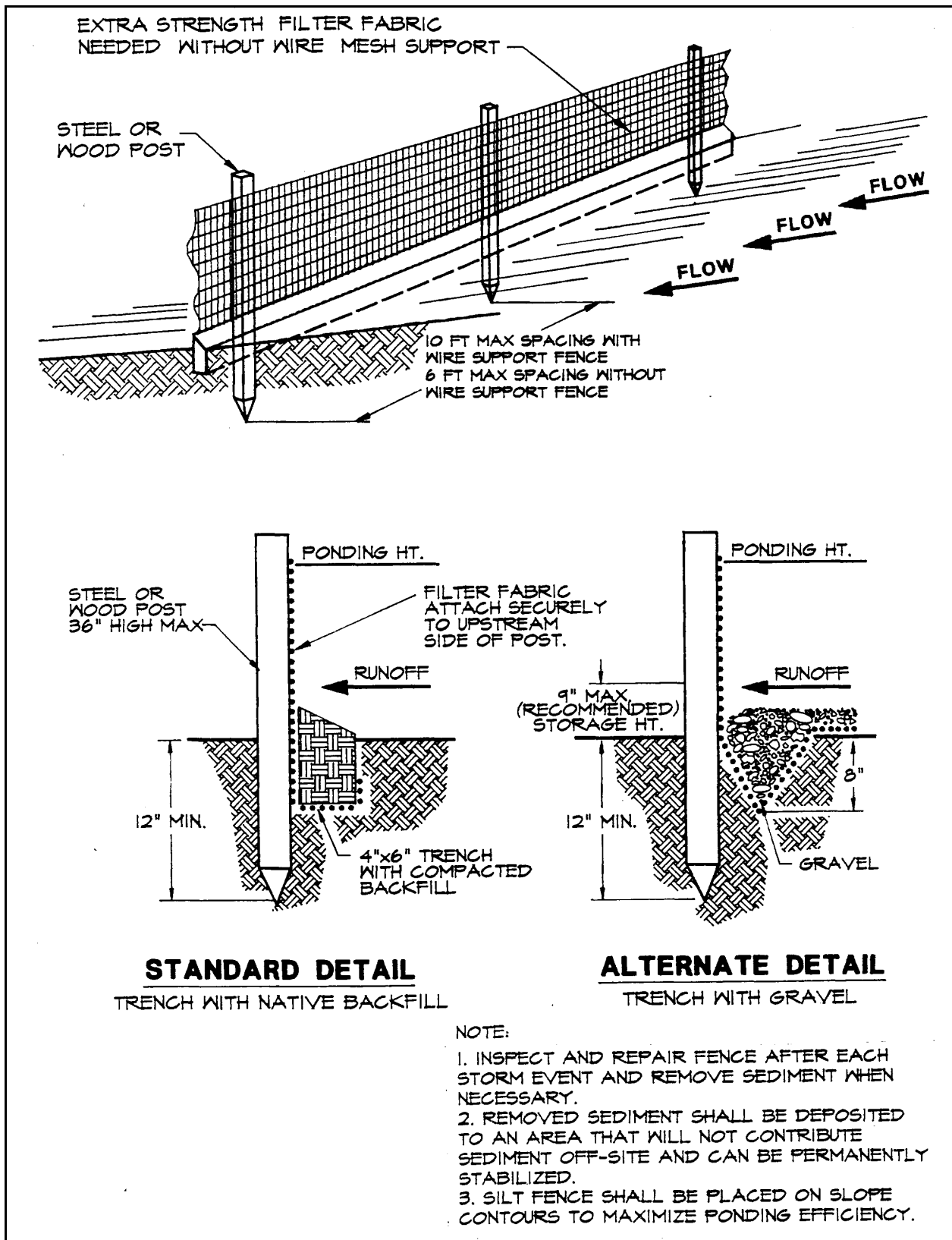

Plate 4.06e Silt Fence

Source: Erosion Draw

4. Any sediment deposits remaining in place after the silt fence or filter barrier is no longer required shall be dressed to conform with the existing grade, prepared, and seeded.

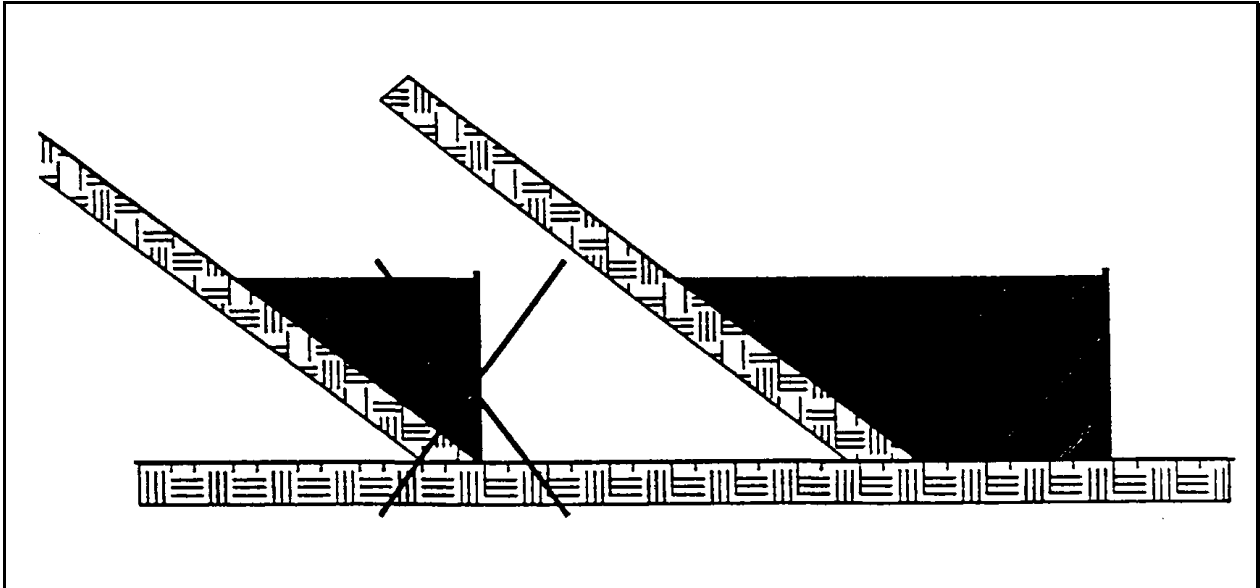

Plate 4.06f Proper Placement of a Silt Fence at the Toe of a Slope

Source: HydroDynamics, Inc

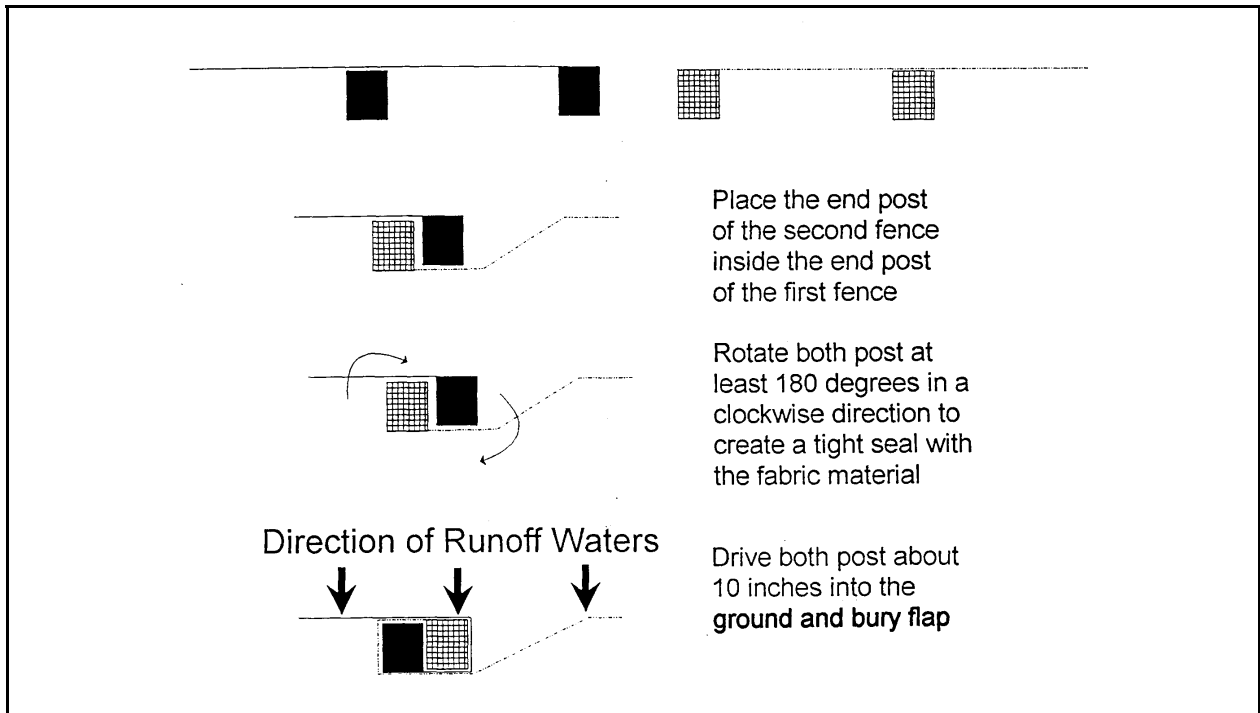

Plate 4.06g Attaching Two Silt Fences

Source: HydroDynamics, Inc.

4.07 BRUSH BARRIER **(ES BMP 1.07)**

Definition

A temporary sediment barrier constructed at the perimeter of a disturbed area from the residue materials available from clearing and grubbing the site.

Purpose

To intercept and retain sediment from disturbed areas of limited extent, preventing sediment from leaving the site.

Conditions Where Practice Applies

Below disturbed areas subject to sheet and rill erosion, where enough residue material is available for construction of such a barrier.

Planning Considerations

Organic litter and spoil material from site clearing operations is usually burned or hauled away to be dumped elsewhere. Much of this material can be used effectively on the construction site itself. During clearing and grubbing operations, equipment can push or dump the mixture of limbs, small vegetation and root mat along with minor amounts of soil and rock into windrows along the toe of a slope where erosion and accelerated runoff are expected. Anchoring a filter fabric over the berm enhances the filtration ability of the barrier. Because brush barriers are fairly stable and composed of natural materials, maintenance requirements are small.

Design Criteria

A formal design is not required.

Construction Specifications

1. The height of a brush barrier shall be a minimum of 3 feet (90 cm).
2. The width of a brush barrier shall be a minimum of 5 feet (1.5 m) at its base. (The sizes of brush barriers may vary considerably based upon the amount of material available and the judgment of the design engineer.)
3. The barrier shall be constructed by piling brush, stone, root mat and other material from the clearing process into a mounded row on the contour.

If a filter fabric is used (Plate 4.07a):

4. The filter fabric shall be cut into lengths sufficient to lay across the barrier from its upslope base to just beyond its peak. Where joints are necessary, the fabric shall

be spliced together with a minimum 6 inch (15 cm) overlap and securely sealed.

5. A trench shall be excavated 6 inches (15 cm) wide and 4 inches (10 cm) deep along the length of the barrier and immediately uphill from the barrier.
6. The lengths of filter fabric shall be draped across the width of the barrier with the uphill edge placed in the trench and the edges of adjacent pieces overlapping each other.
7. The filter fabric shall be secured in the trench with stakes set approximately 36 inches (90 cm) on center. Stakes shall be at least 12" (30 cm) long, 1" x 2" (25 mm x 50 mm) wood or #4 rebar (13 mm) minimum.
8. The trench shall be backfilled and the soil compacted over the filter fabric.
9. Set stakes into the ground along the downhill edge of the brush barrier, and anchor the fabric by tying twine from the fabric to the stakes.

Maintenance

1. Brush barriers shall be inspected after each rainfall and necessary repairs shall be made promptly.
2. Sediment deposits must be removed when they reach approximately one-half of the height of the barrier.

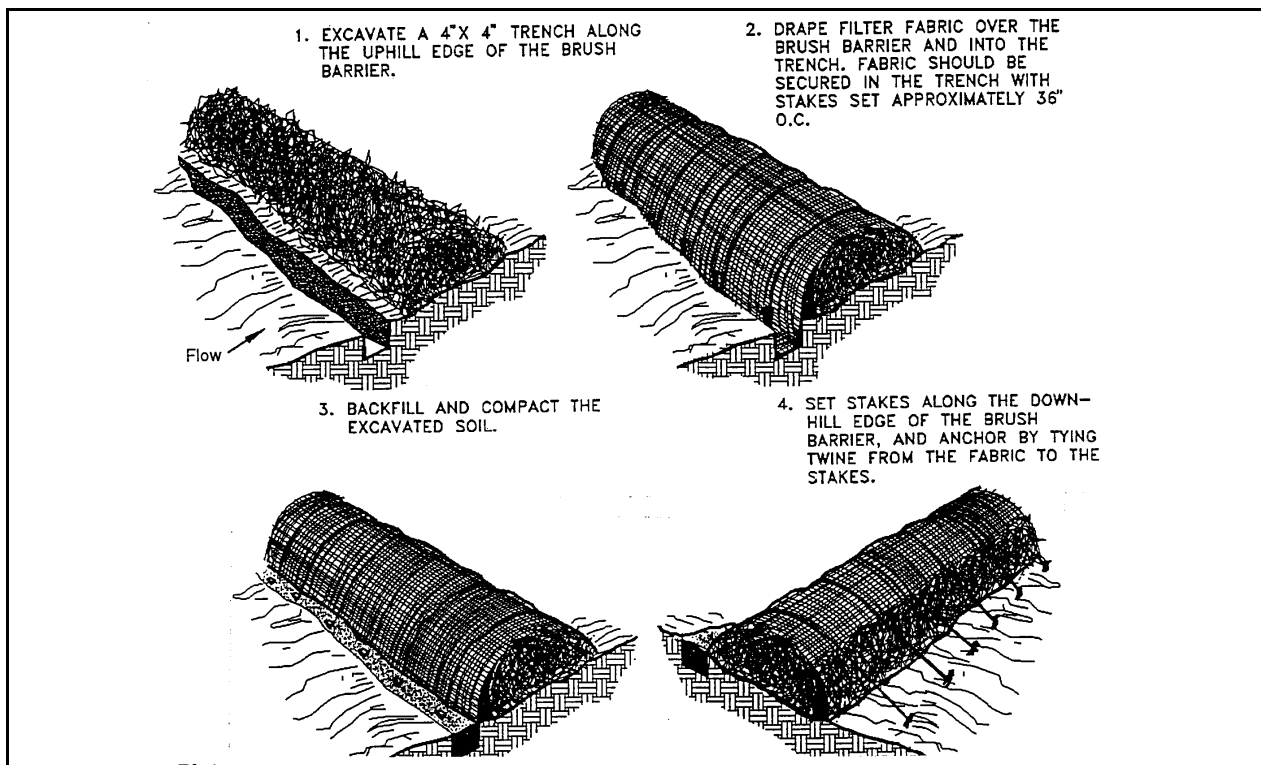

Plate 4.07a Construction of a Brush Barrier Covered with Filter Fabric

Source: Virginia DSWC

4.08 STORM DRAIN INLET PROTECTION **(ES BMP 1.08)**

Definition

A sediment filter or an excavated impounding area around a storm drain drop inlet or curb inlet.

Purpose

To prevent sediment from entering storm water conveyance systems prior to permanent stabilization of the disturbed area.

Condition Where Practice Applies

Where storm drain inlets are to be made operational before permanent stabilization of the disturbed drainage area. Different types of structures are applicable to different conditions (see Plates 4.08a through 4.08h).

Planning Considerations

Storm sewers which are made operational before their drainage area is stabilized can convey large amounts of sediment to receiving waters. In case of extreme sediment loading, the storm sewer itself may clog and lose most of its capacity. To avoid these problems, it is necessary to prevent sediment from entering the system at the inlets.

This section contains several types of inlet filters and traps which have different applications dependent upon site conditions and type of inlet. Other innovative techniques for accomplishing the same purpose are encouraged, but only after specific plans and details are submitted to and approved by the stormwater permitting agency.

Note that these various inlet protection devices are for drainage areas of less than one acre (0.4 ha). Runoff from large disturbed areas should be routed through a TEMPORARY SEDIMENT TRAP - Section 4.25 (ES BMP 1.25).

Design Criteria

1. The drainage area shall be no greater than 1 acre (0.4 ha).
2. The inlet protection device shall be constructed to facilitate clean out and disposal of trapped sediment and to minimize interference with construction activities.
3. The inlet protection devices shall be constructed so that any resultant ponding or stormwater will not cause excessive inconvenience or damage to adjacent areas or structures.
4. Design criteria more specific to each particular inlet protection devices will be found on Plates 4.08a-h.

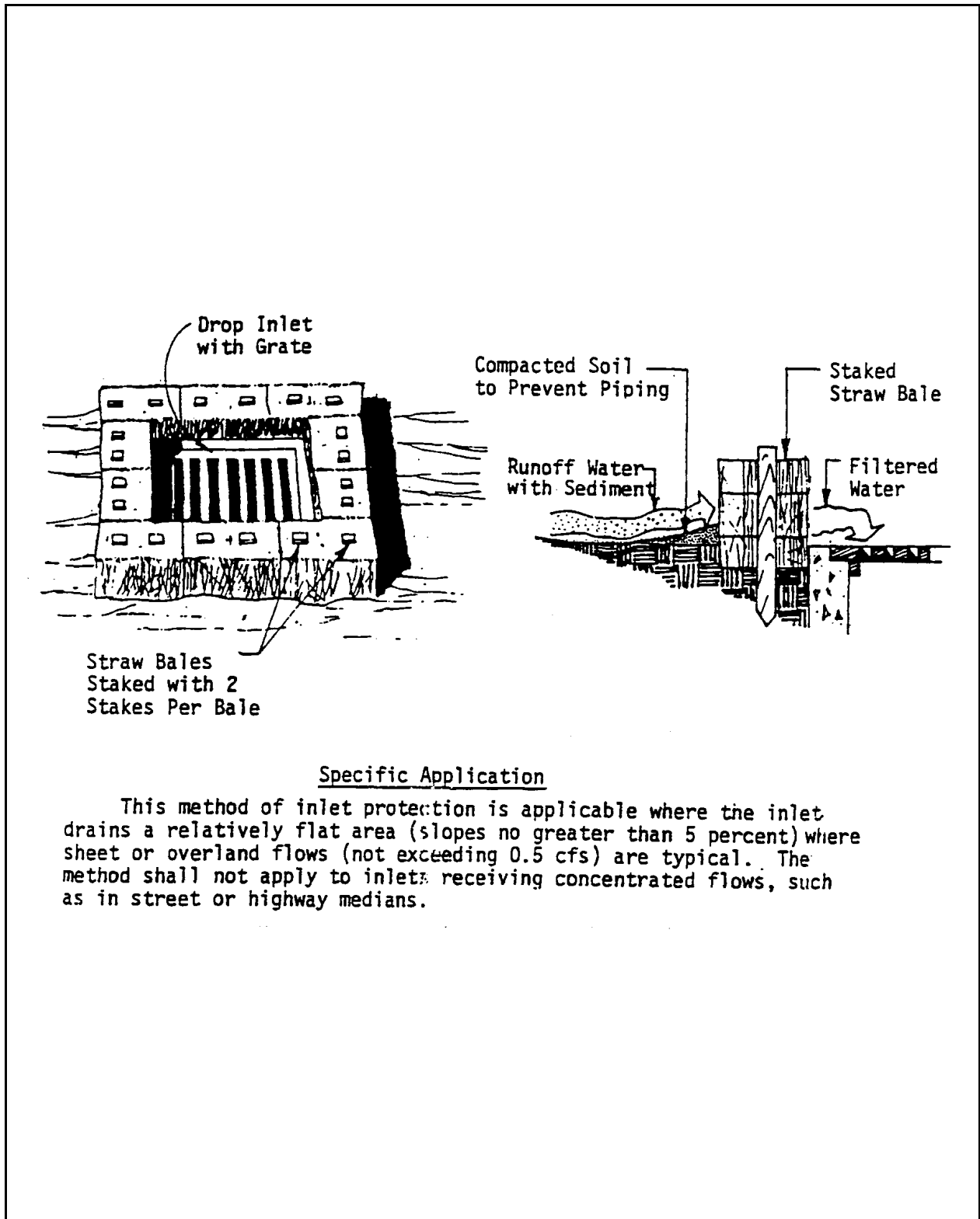
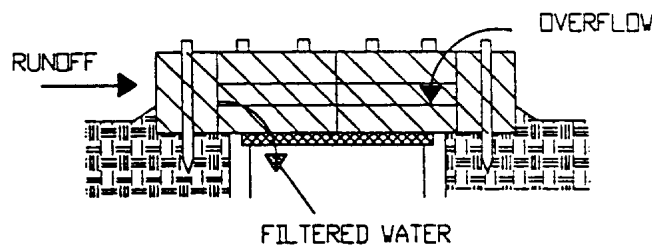
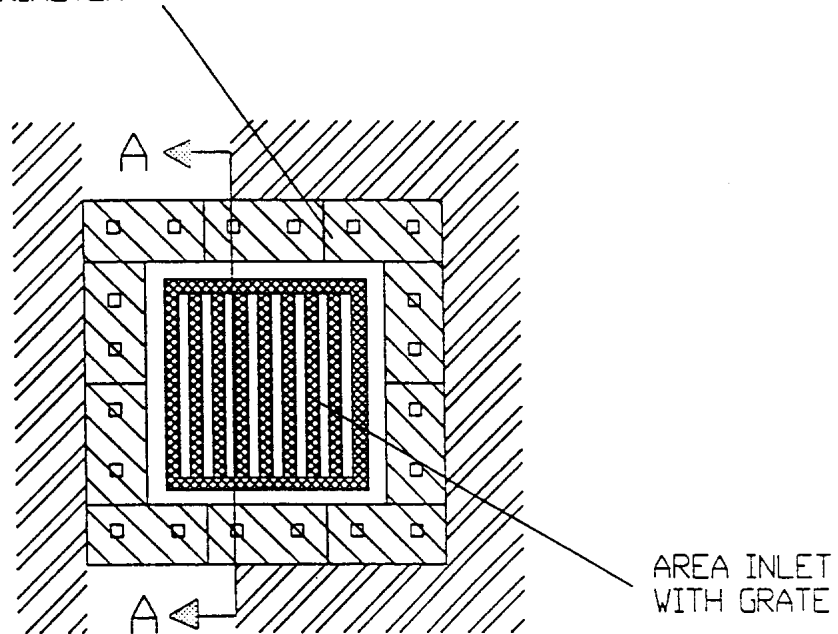

Plate 4.08a Straw Bale Drop Inlet Sediment Filter

Source: Michigan Soil Erosion and Sedimentation Control Guidebook

STRAW BALES ARE TO BE PLACED 4 INCHES IN THE SOIL, TIGHTLY ABUTTING WITH NO GAPS, STAKED AND BACKFILLED AROUND THE ENTIRE OUTSIDE PERIMETER



SECTION AA

NOTE: STRAW BALE FILTERS ARE NOT TO BE USED IF ADJACENT AREA TO INLET IS PAVED

Plate 4.08b Straw Bale Filter for Area Inlet

Source: HydroDynamics, Inc.

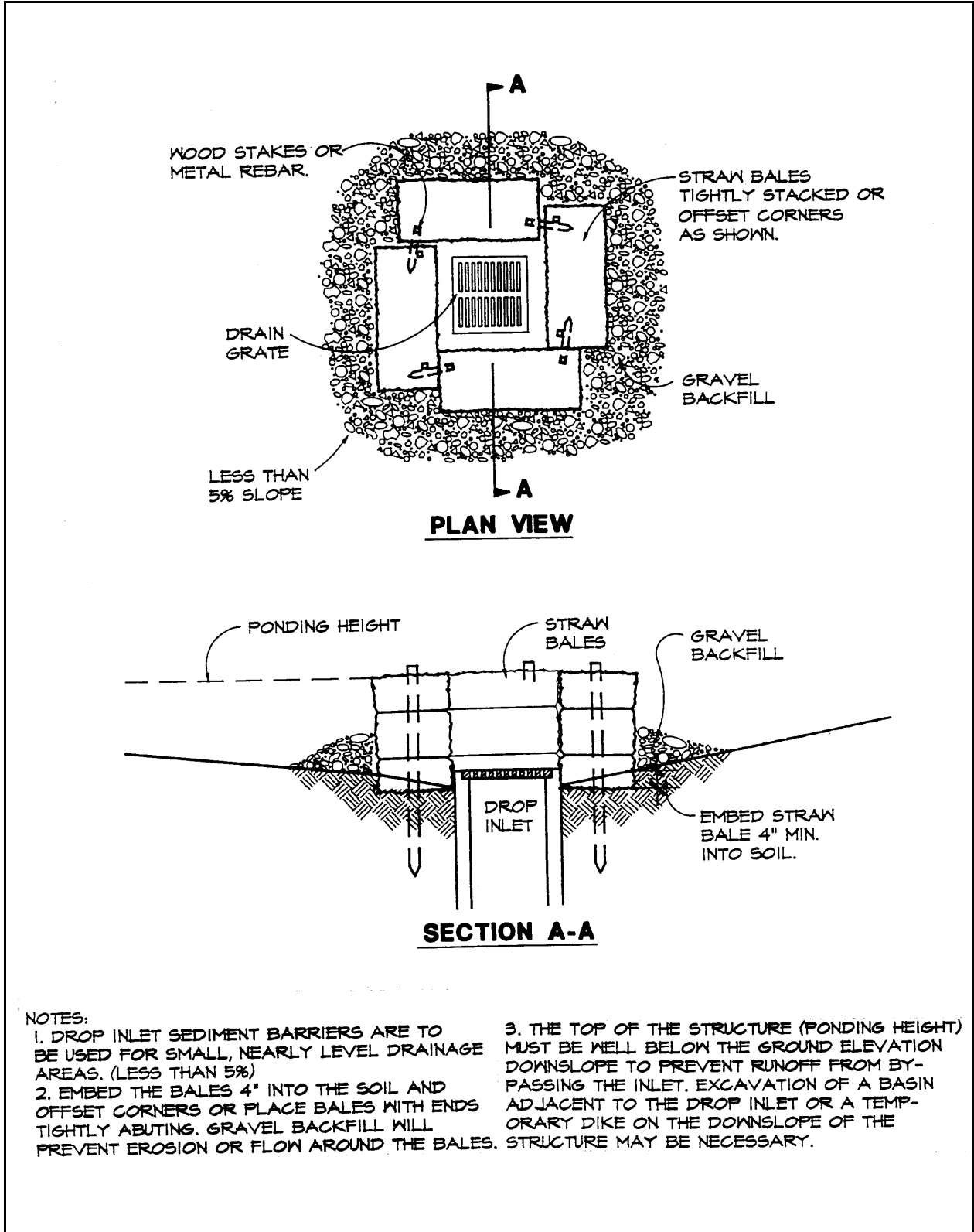

Plate 4.08c Straw Bale and Gravel Drop Inlet Sediment Barrier

Source: Erosion Draw

Construction Specifications

Straw bale drop inlet filter

1. Bales shall be either wire-bound or string-tied with the bindings oriented around the sides rather than over and under the bales.
2. Bales shall be placed lengthwise in a single row surrounding the inlet, with the ends of adjacent bales pressed together. (See Plate 4.08a)
3. The filter barrier shall be entrenched and backfilled. A trench shall be excavated around the inlet the width of a bale to a minimum depth of 4 inches (10 cm). After the bales are staked, the excavated soil shall be backfilled and compacted against the filter barrier. (See Plate 4.08b)
4. Each bale shall be securely anchored and held in place by at least two stakes or rebars (See p. 4-17) driven through the bale.
5. Loose straw should be wedged between bales to prevent water from entering between bales.
6. Gravel may be spread around the bales to improve stability. (See Plate 4.08c)

Fabric drop inlet sediment filter

1. Fabric shall be cut from a continuous roll to avoid joints.
2. Stakes shall be 2" x 4" (5 cm x 10 cm) wood (preferred) or equivalent metal with a minimum length of 3 feet (90 cm). (See Plate 4.08d)
3. Staples shall be of heavy duty wire at least 1/2-inch (13 mm) long.
4. Stakes shall be spaced around the perimeter of the inlet a maximum of 3 feet (90 cm) apart and securely driven into the ground minimum of 8 inches (20 cm). A frame of 2" x 4" (5 cm x 10 cm) wood shall be constructed around the top of the stakes for proper stability.
5. A trench shall be excavated approximately 4 inches (10 cm) wide and 4 inches (10 cm) deep around the outside perimeter of the stakes. (See Plate 4.08e)
6. The burlap shall be stapled to the wooden stakes, and 8 inches (20 cm) of the fabric shall be extended into the trench. The height of the filter barrier shall be a minimum of 15 inches (38 cm) and shall not exceed 18 inches (45 cm).
7. The trench shall be backfilled and the soil compacted over the burlap.

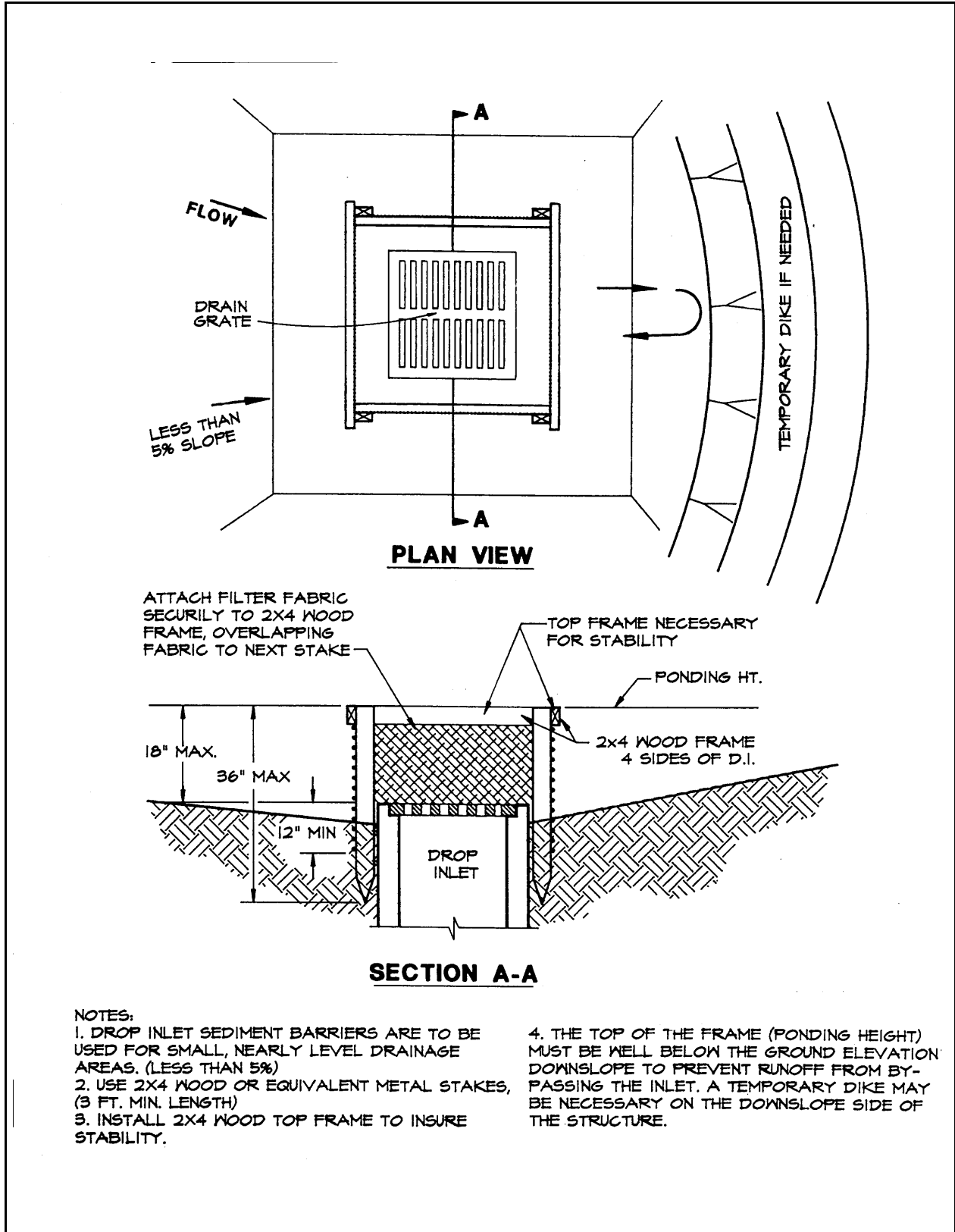

Plate 4.08d Silt Fence Drop Inlet Sediment Barrier

Source: Erosion Draw

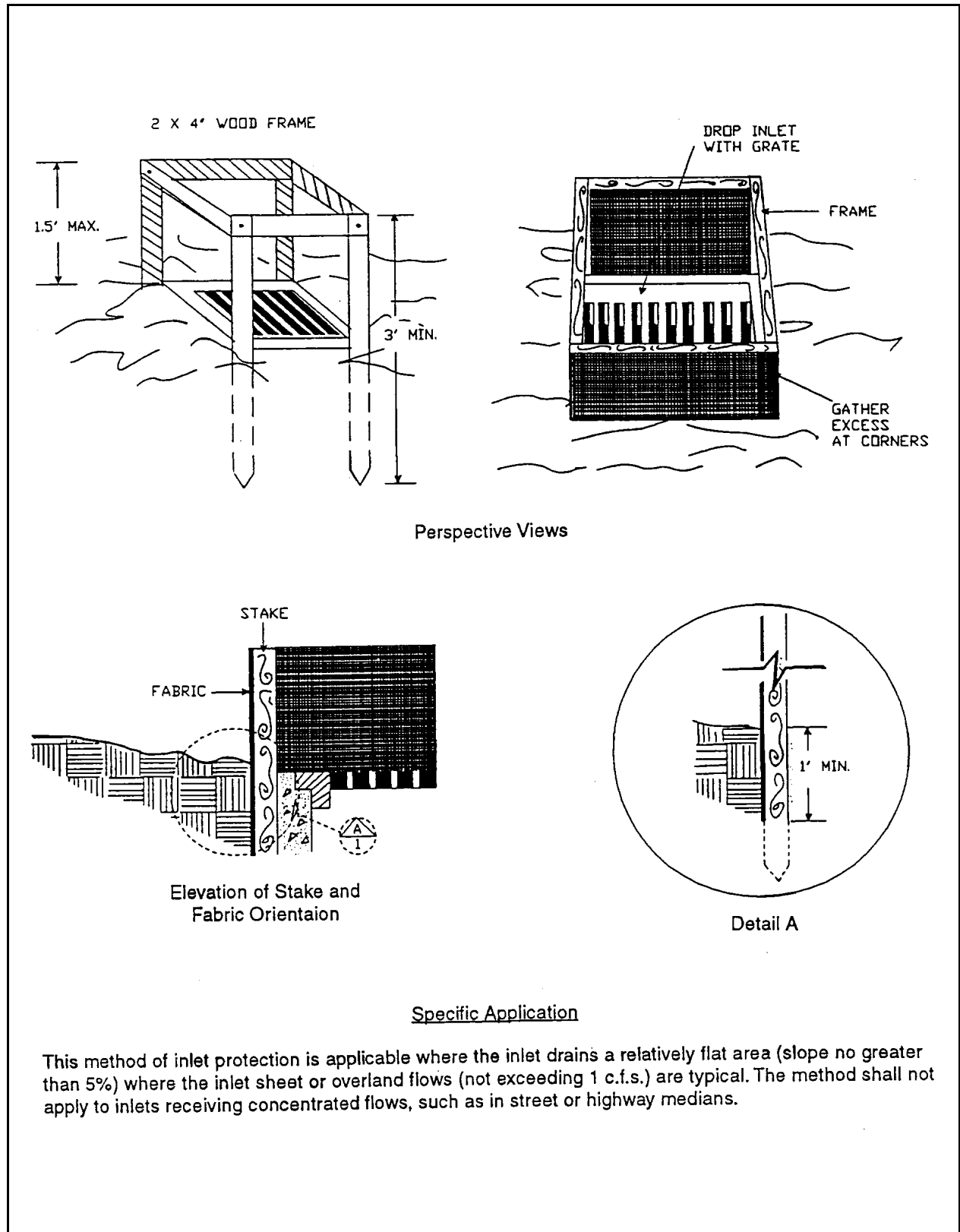

Plate 4.08e Filter Fabric Drop Inlet Sediment Filter
 Source: North Carolina Erosion and Sediment Control Manual

Gravel and wire mesh drop inlet sediment filter

1. Wire mesh shall be laid over the drop inlet so that the wire extends a minimum of one foot (30 cm) beyond each side of the inlet structure. Hardware cloth or comparable wire mesh with 1/2 inch (13 mm) openings shall be used. If more than one strip of mesh is necessary, the strips shall be overlapped at least 1 ft. (30 cm).
2. FDOT No. 1 Coarse Aggregate (1.5" to 3.5" stone)(4 - 9 cm) shall be placed over the wire mesh as shown on Plate 4.08c. The depth of stone shall be at least 12 inches (30 cm) over the entire inlet opening. The stone shall extend beyond the inlet opening at least 18 inches (45 cm) on all sides. (See Plate 4.08f)
3. If the stone filter becomes clogged with sediment so that it no longer adequately performs its function, the stones must be pulled away from the inlet, cleaned and replaced.

NOTE: This filtering device has no overflow mechanism. Therefore, ponding is likely especially if sediment is not removed regularly. This type of device must never be used where overflow may endanger an exposed fill slope. Consideration should also be given to the possible effects of ponding on traffic movement, nearby structures, working areas, adjacent property, etc.

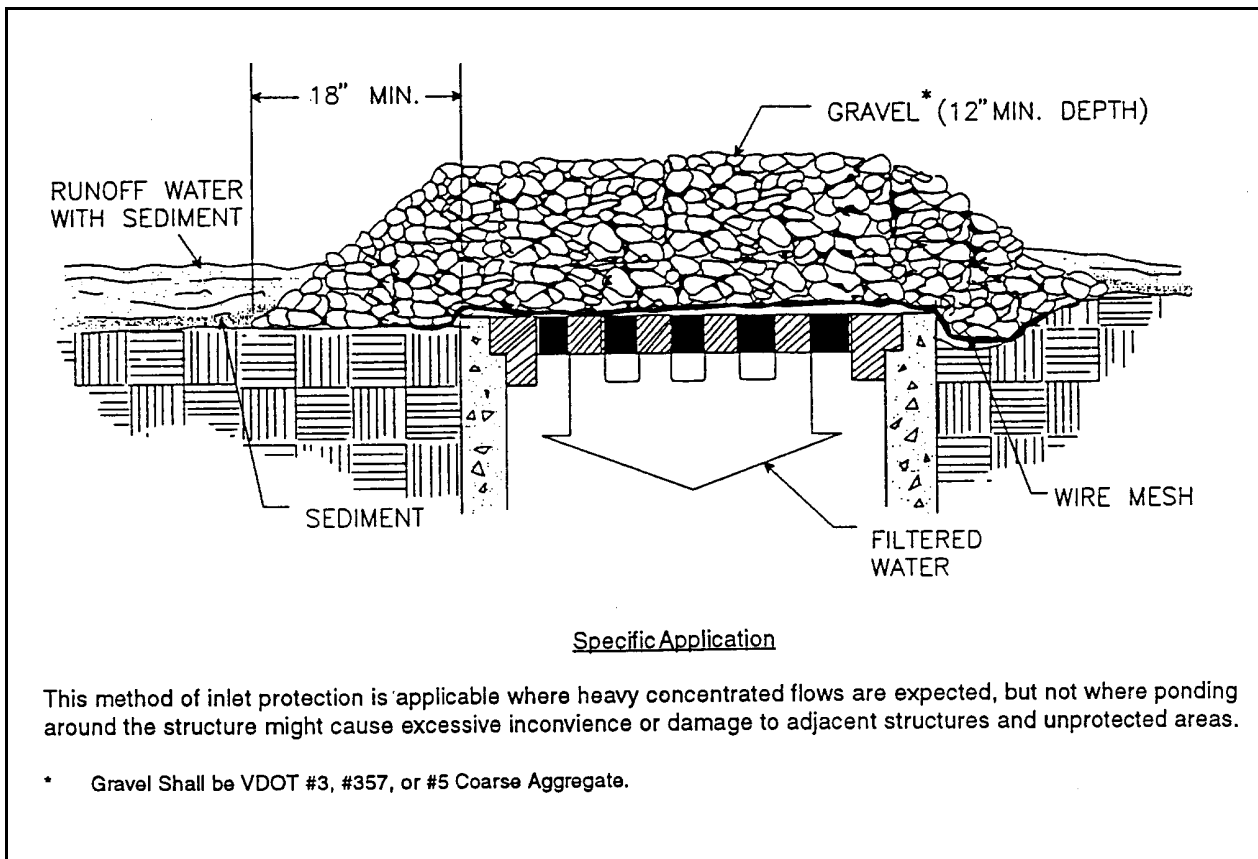

Plate 4.08f Gravel and Wire Mesh Drop Inlet Sediment Filter
 Source: Virginia DSWC

Block and gravel drop inlet sediment filter

1. Place concrete blocks lengthwise on their sides in a single row around the perimeter of the inlet, with the ends of adjacent blocks abutting. The height of the barrier can be varied, depending on design needs, by stacking combinations of 4 inch, 8 inch and 12 inch (10, 20, and 30 cm) wide blocks. The barrier of blocks shall be at least 12 inches (30 cm) high and no greater than 24 inches (60 cm) high.
2. Wire mesh shall be placed over the outside vertical face (webbing) of the concrete blocks to prevent stone from being washed through the holes in the blocks. Hardware cloth or comparable wire mesh with 1/2 inch (13 mm) openings shall be used. (See Plate 4.08g)
3. Stone shall be piled against the wire to the top of the block barrier. Suitable coarse aggregate shall be used. (See Plate 4.08h)
4. If the stone filter becomes clogged with sediment so that it no longer adequately performs its function, the stone must be pulled away from the blocks, cleaned and replaced.
5. As a very temporary alternative, pervious burlap bags filled with gravel may be placed around the inlet provided that there are no gaps between the bags. (See Plate 4.08i)
6. Either of these two practices may be installed on pavement or bare ground

Sod drop inlet sediment filter

1. Soil shall be prepared and sod installed according to the specifications in SODDING - Section 6.67 (ES BMP 1.67).
2. Sod shall be placed to form a turf mat covering the soil for a distance of 4 feet (1.2 m) from each side of the inlet structure. (See Plate 4.08j)

Prefabricated drop inlet internal filter bag (ACF Silt Sack)

1. Remove the grate over the catch basin and insert the filter device, then replace grate to hold the device in position.
2. When sediments have accumulated to within one foot (30 cm) of the grate the filter insert must be removed by a front-end loader or forklift. The filter may be discarded and replaced or it may be emptied, cleaned, and reused.

NOTE: This segment does not constitute a product endorsement.

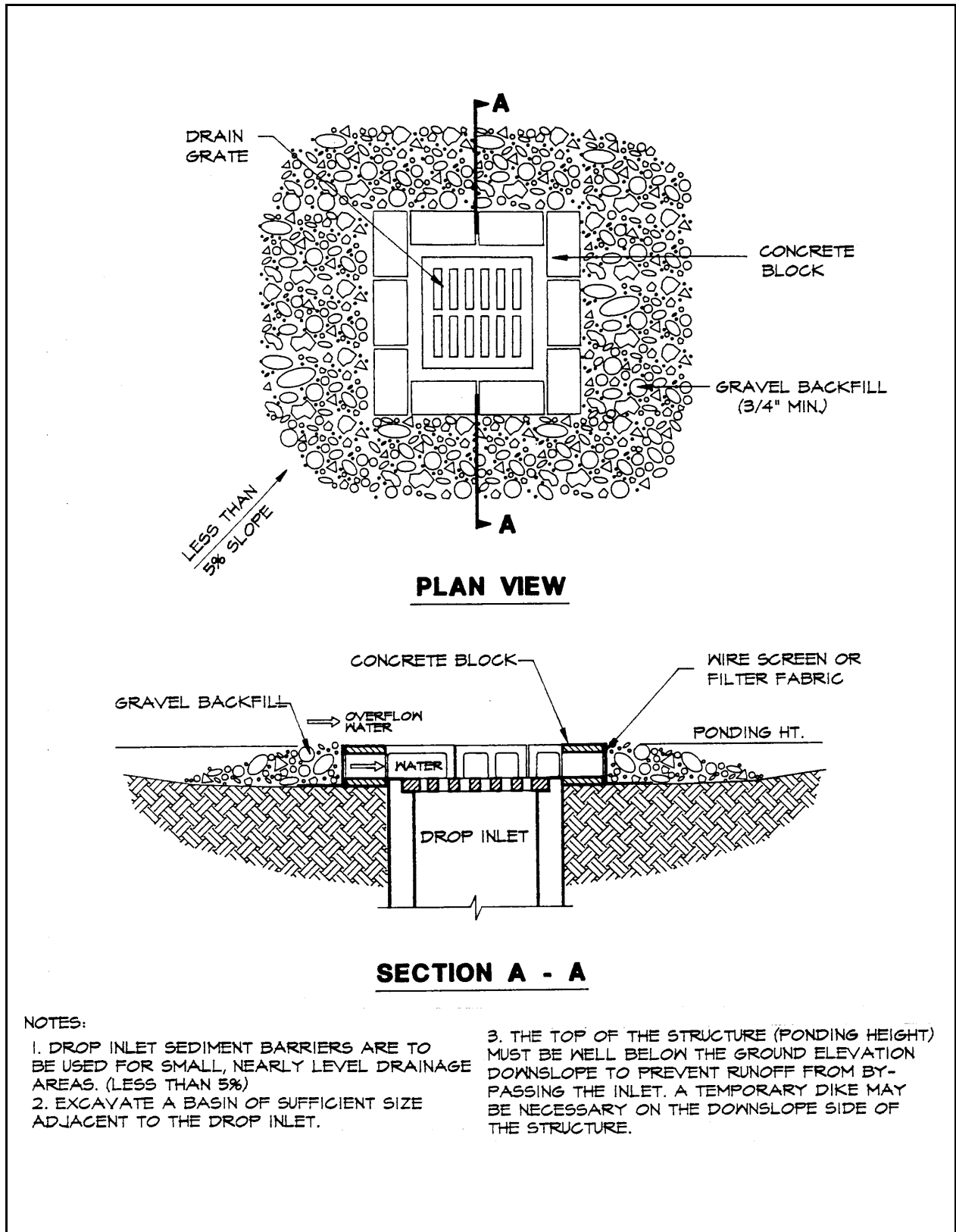
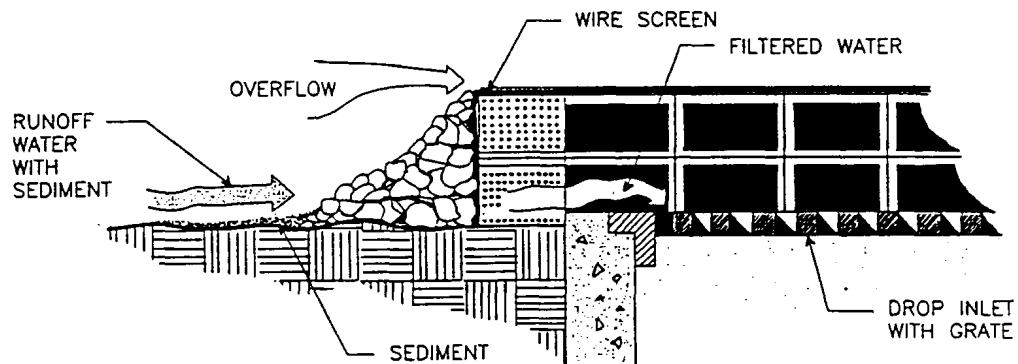
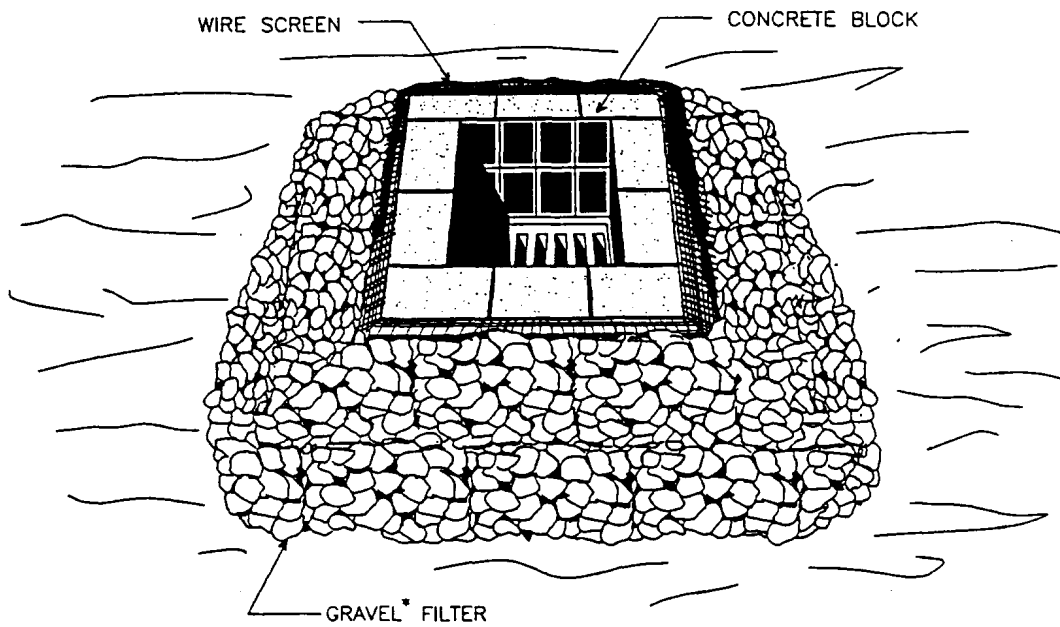

Plate 4.08g Block and Gravel Drop Inlet Sediment Filter

Source: Erosion Draw



Specific Application

This method of inlet protection is applicable where heavy flows are expected and where an overflow capacity is necessary to prevent excessive ponding around the structure.

* Gravel Shall be FDOT #3, #357, or #5 Coarse Aggregate.

Plate 4.08h Block and Gravel Drop Inlet Sediment Filter
Source: Michigan Soil Erosion and Sedimentation Control Guidebook

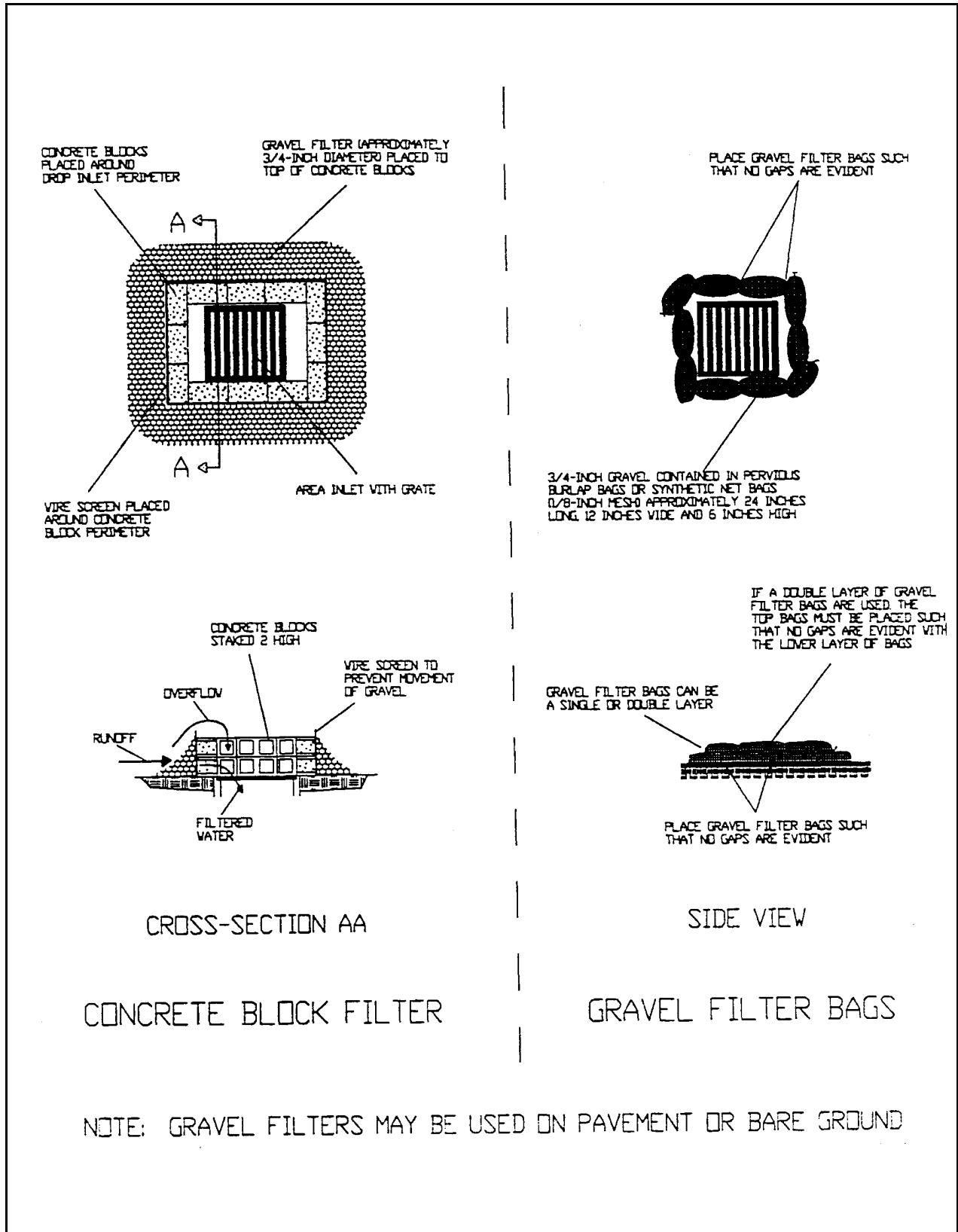

Plate 4.08i Gravel Filters for Area Inlets

Source: HydroDynamics, Inc.

Prefabricated drop inlet external filter (Suntree Isles Grate Inlet Protector)

1. Place the device over the inlet. If the inlet has a grate, the device shall be secured to the grate by means of a long toggle bolt. If the grate is not present, the device shall be bolted directly to the concrete.
2. Sediments shall be removed when they have accumulated to within one foot (30 cm) of the top of the device. The filter fabric elements shall be cleaned or replaced at that time.

NOTE: This segment does not constitute a product endorsement.

Gravel curb inlet sediment filter

1. Hardware cloth or comparable wire mesh with 1/2 inch (13 mm) openings shall be placed over the curb inlet opening so that at least 12 inches (30 cm) of wire extends across the top of the inlet cover and at least 12 inches (30 cm) of wire extends across the concrete gutter from the inlet opening. (See Plate 4.08k)
2. Stone shall be piled against the wire so as to anchor it against the gutter and inlet cover and to cover the inlet opening completely. FDOT No. 1 Coarse Aggregate shall be used.
3. An overflow weir can be constructed of 2" x 4" (5 x 10 cm) boards to lessen ponding from this practice. (See Plate 4.08L)
4. If the stone filter becomes clogged with sediment so that it no longer adequately performs its function, the stone must be pulled away from the block, cleaned and replaced.

Block and gravel curb inlet sediment filter

1. Two concrete blocks shall be placed on their sides abutting the curb at either side of the inlet opening.
2. A 2" x 4" (5 x 10 cm) board shall be cut and placed through the outer holes of each spacer block to help keep the front blocks in place.
3. Concrete blocks shall be placed on their sides across the front of the inlet and abutting the spacer blocks. (See Plate 4.08m)
4. Wire mesh shall be placed over the outside vertical face (webbing) of the concrete blocks to prevent stone from being washed through the holes in the blocks. Hardware cloth with 1/2 inch (13 mm) openings shall be used.
5. FDOT No. 1 Coarse Aggregate shall be piled against the wire to the top of the barrier.

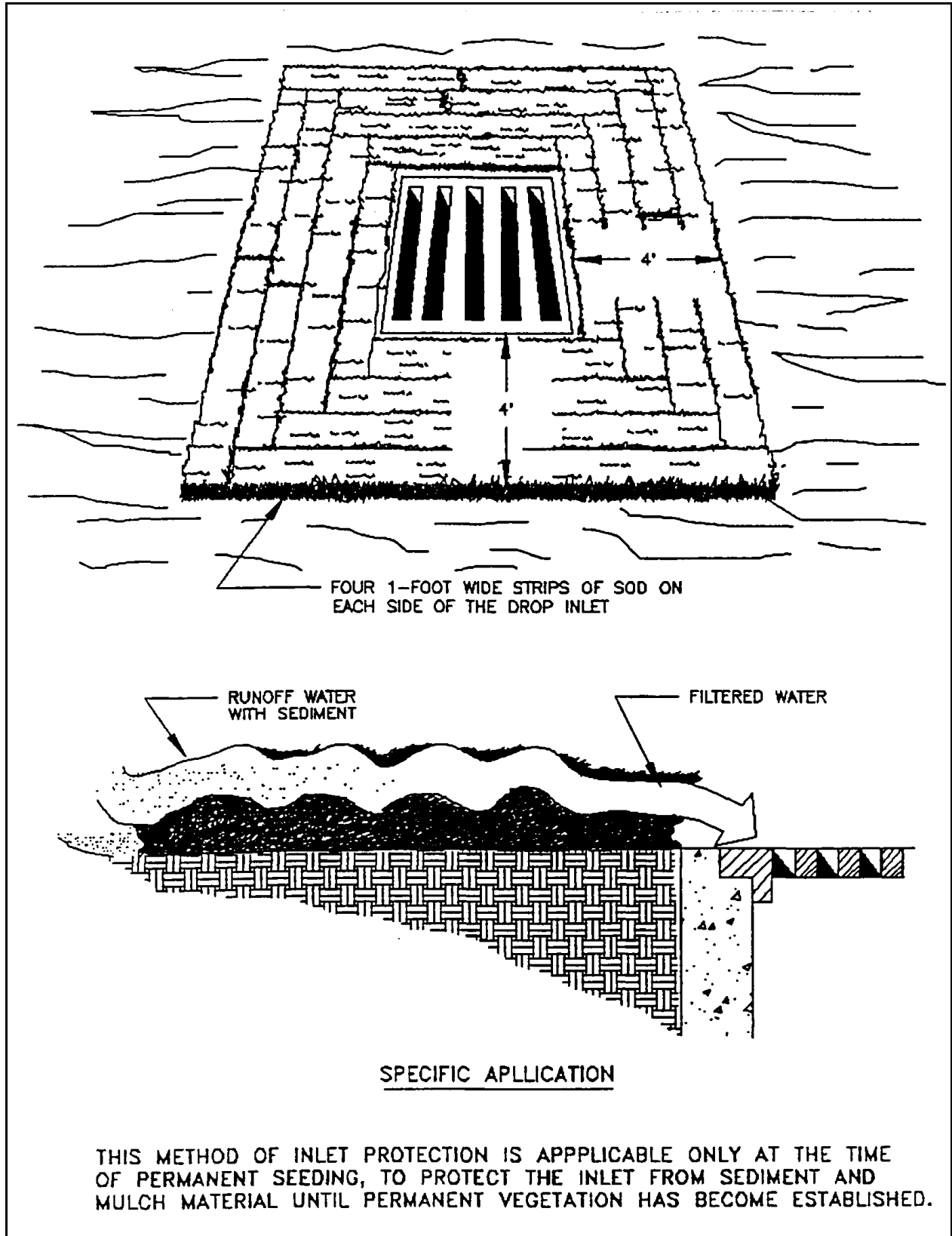

Plate 4.08j Sod Drop Inlet Sediment Filter
Source: Virginia DSWC

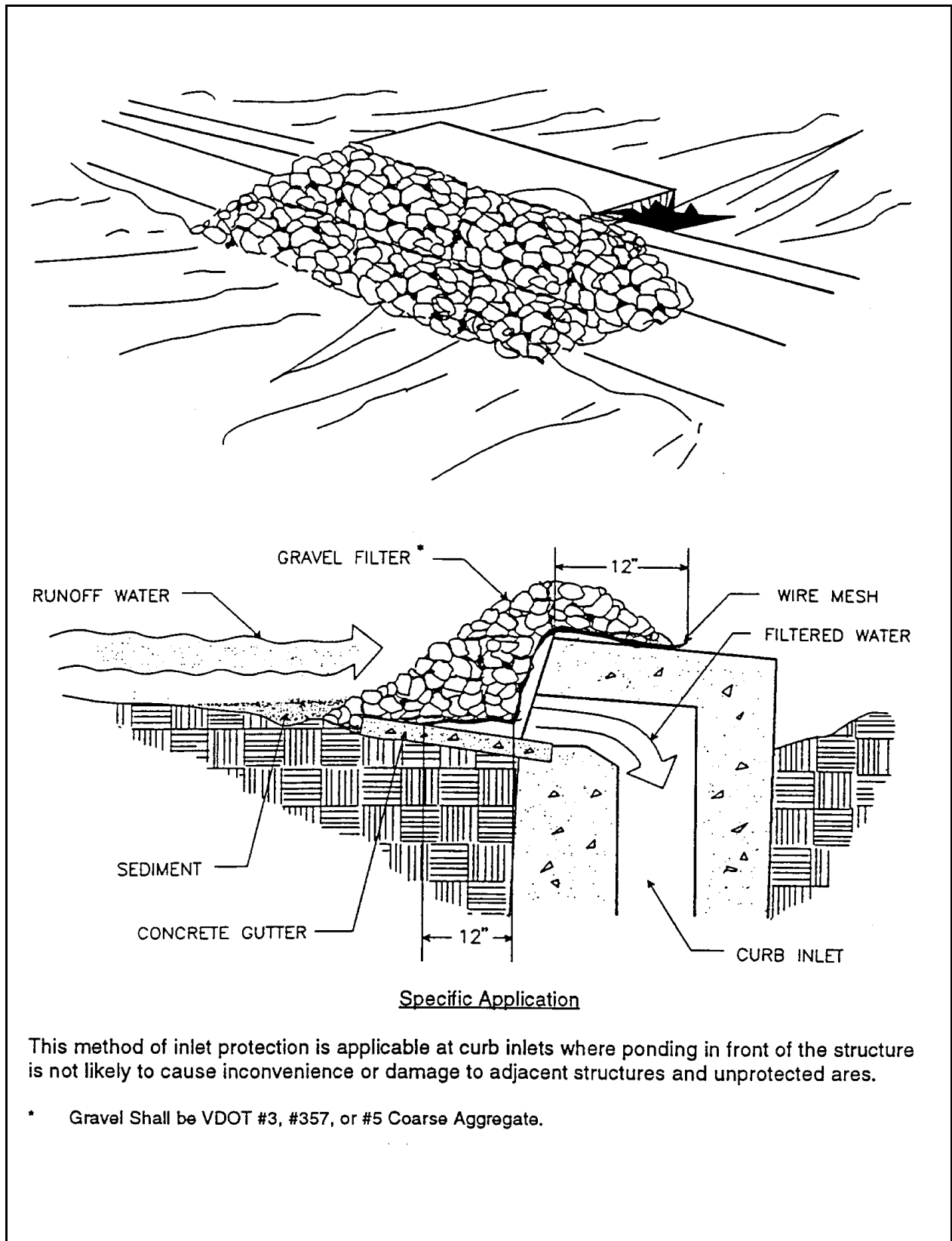

Plate 4.08k Gravel Curb Inlet Sediment Filter
Source: Virginia DSWC

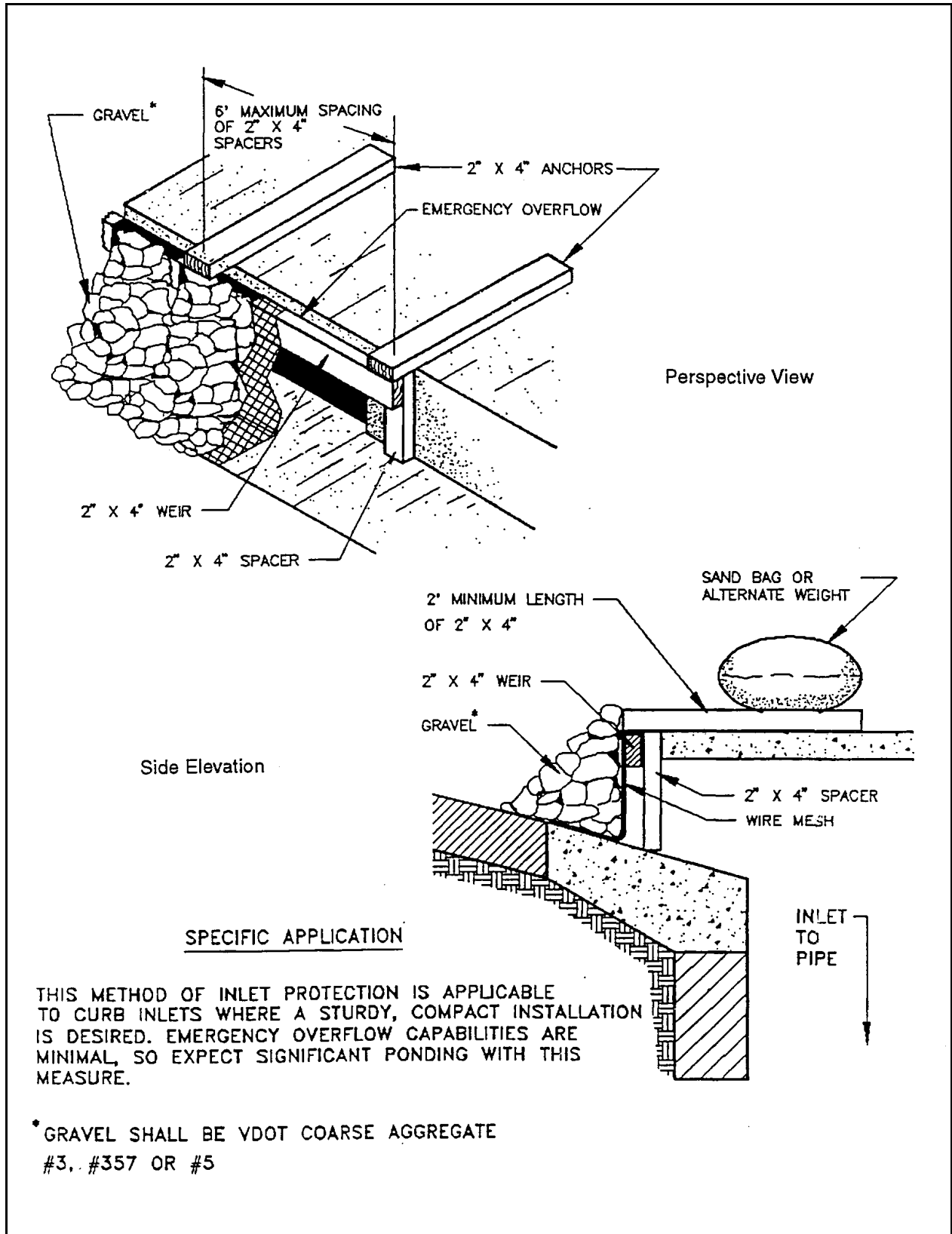

Plate 4.08L Gravel Curb Inlet Sediment Filter with Overflow Weir
 Source: Maryland Standards and Specifications for Soil Erosion and Sediment Control

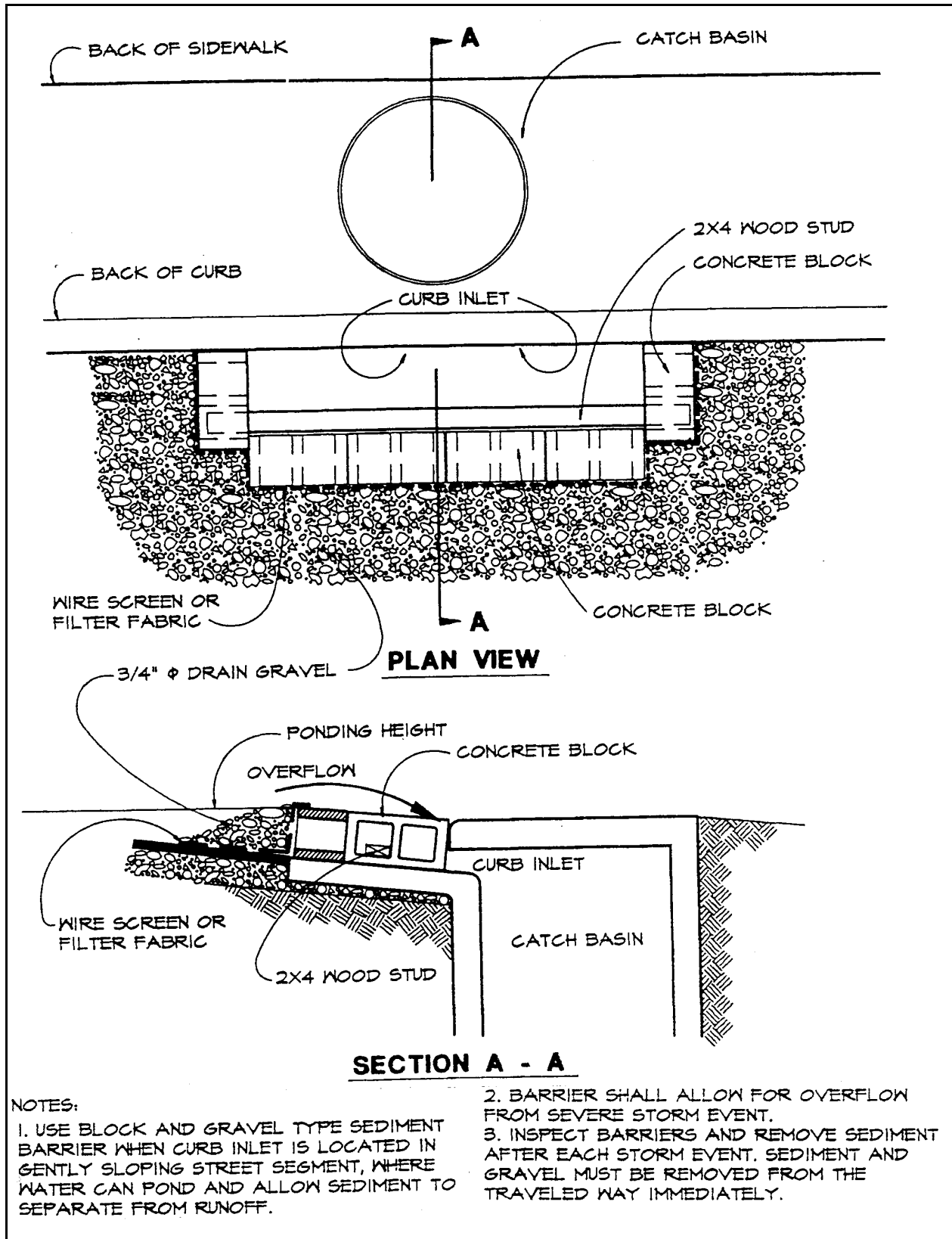

Plate 4.08m Block and Gravel Curb Inlet Sediment Barrier

Source: Erosion Draw

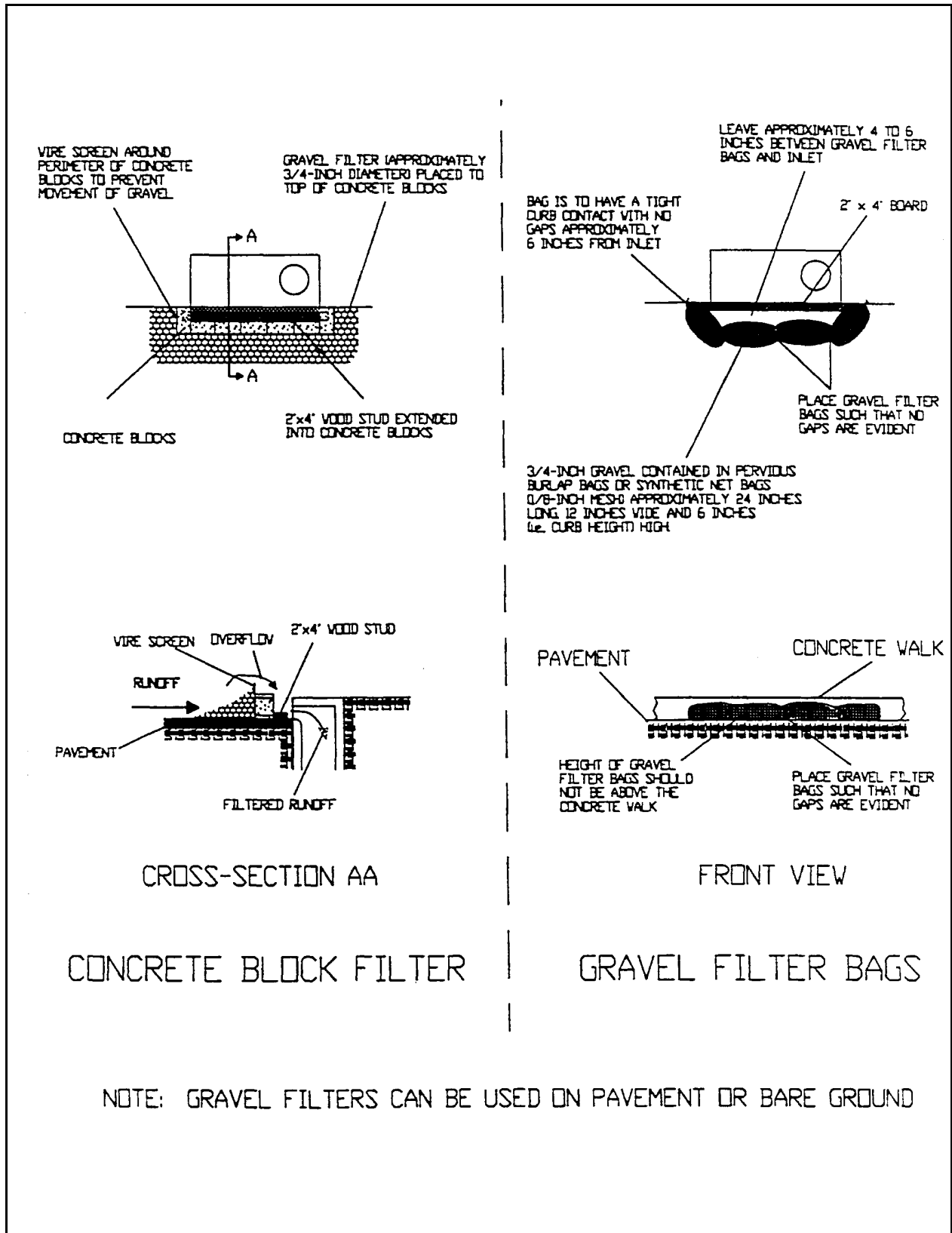

Plate 4.08n Curb Inlet Gravel Filters
 Source: HydroDynamics, Inc.

6. If the stone filter becomes clogged with sediment so that it no longer adequately performs its function, the stone must be pulled away from the block, cleaned and replaced.
7. As an alternate, gravel filled burlap bags may be stacked tightly around the curb inlet. (See Plates 4.08n and 4.08o)

Curb and Gutter Sediment Barrier

1. Place gravel filled burlap bags on gently sloping street segments according to the spacing chart. (See Plate 4.08p)
2. Place two or more bags at each interval in a manner which provides maximum support.
3. When stacking several bags high, leave a one bag gap to provide an overflow spillway. (See Plate 4.08q)
4. Sediments must be removed after each rain event.

Maintenance

1. The structure shall be inspected after each rain and repairs made as needed.
2. Sediment shall be removed and the trap restored to its original dimensions when the sediment has accumulated to 1/2 of the design depth of the trap. Removed sediment shall be deposited in a suitable area and in such a manner that it will not erode.
3. Structures shall be removed and the area stabilized when the remaining drainage area has been properly stabilized.

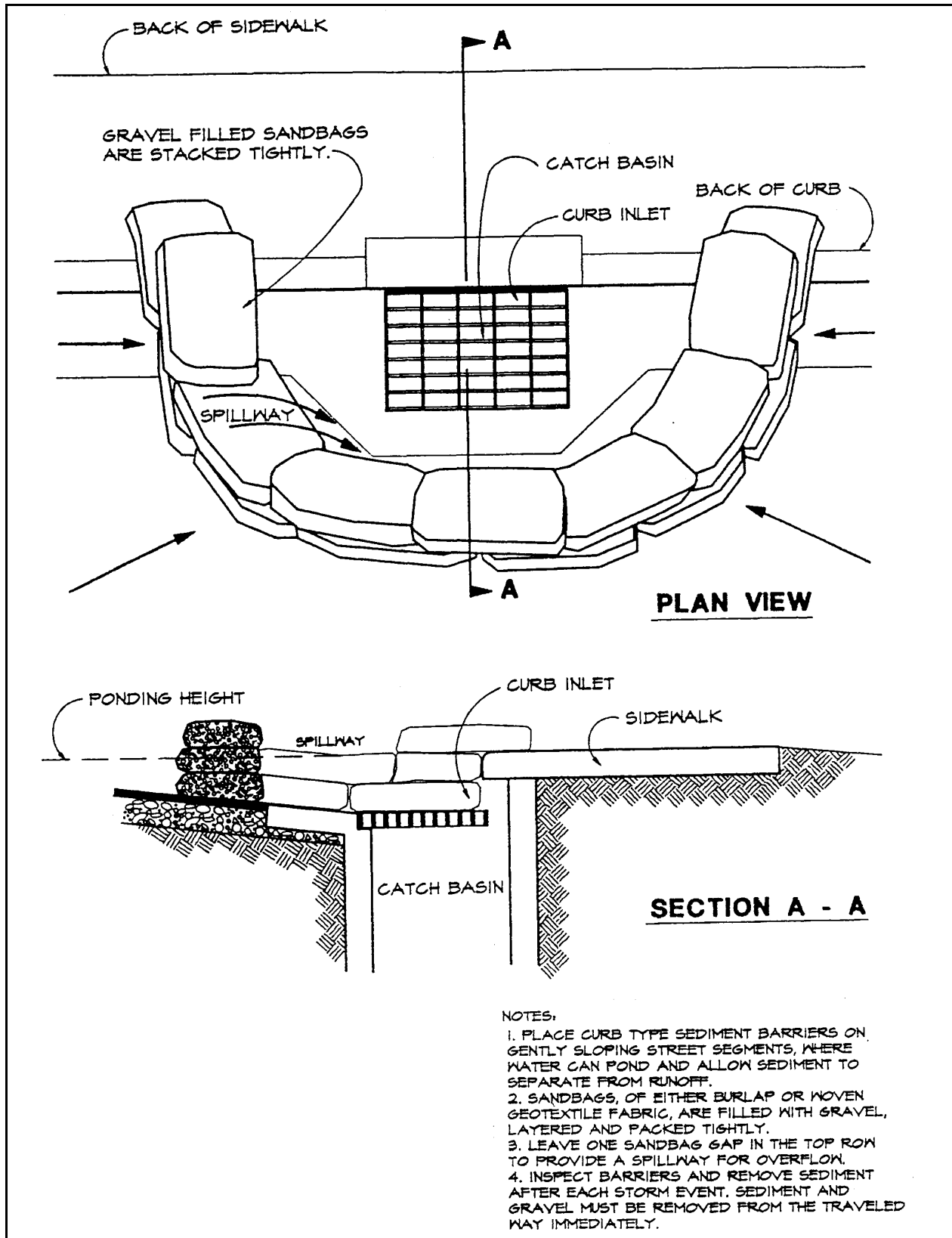

Plate 4.08o Curb Inlet Sediment Barrier

Source: Erosion Draw

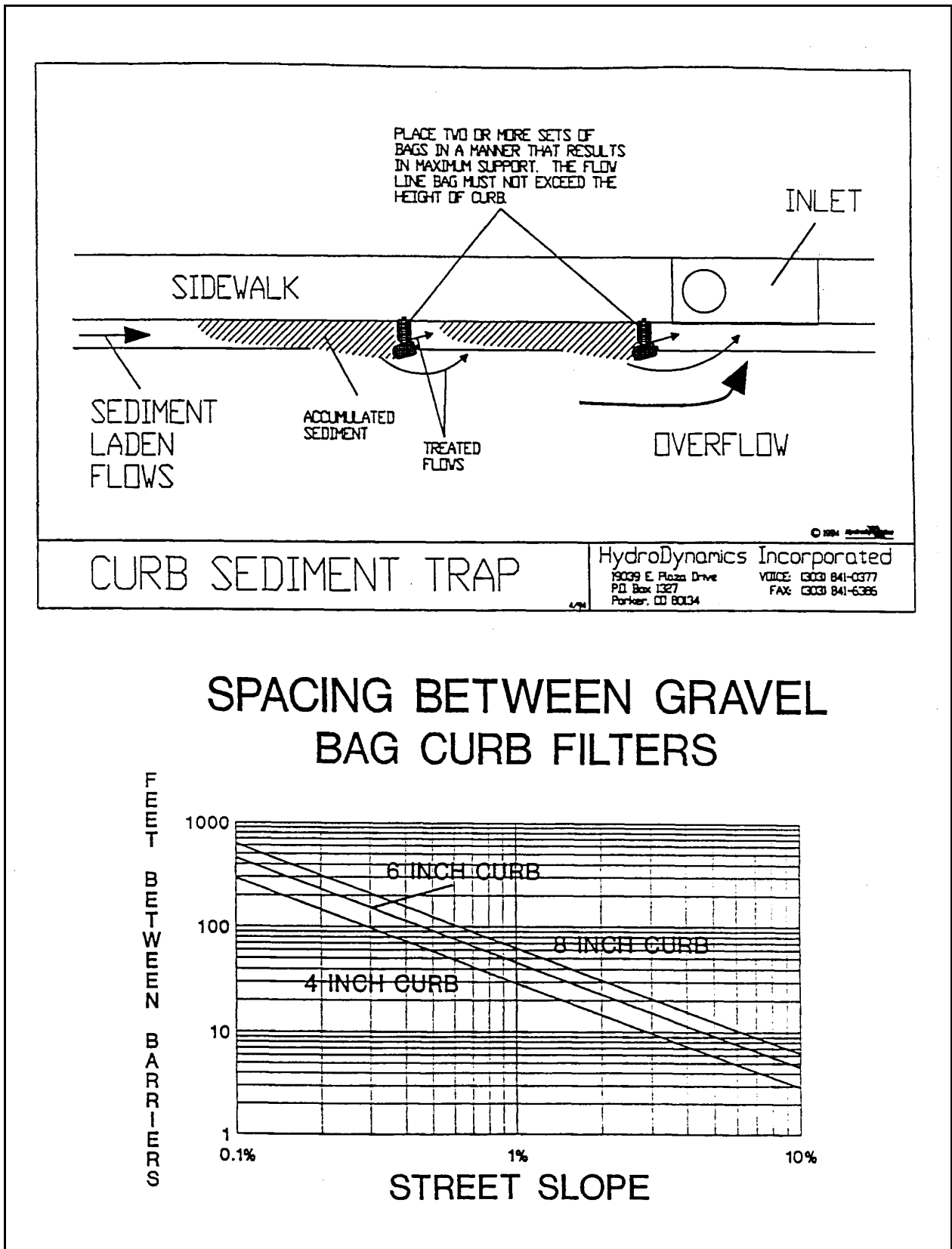

Plate 4.08p Gravel Bag Curb Sediment Filters
 Source: HydroDynamics, Inc.

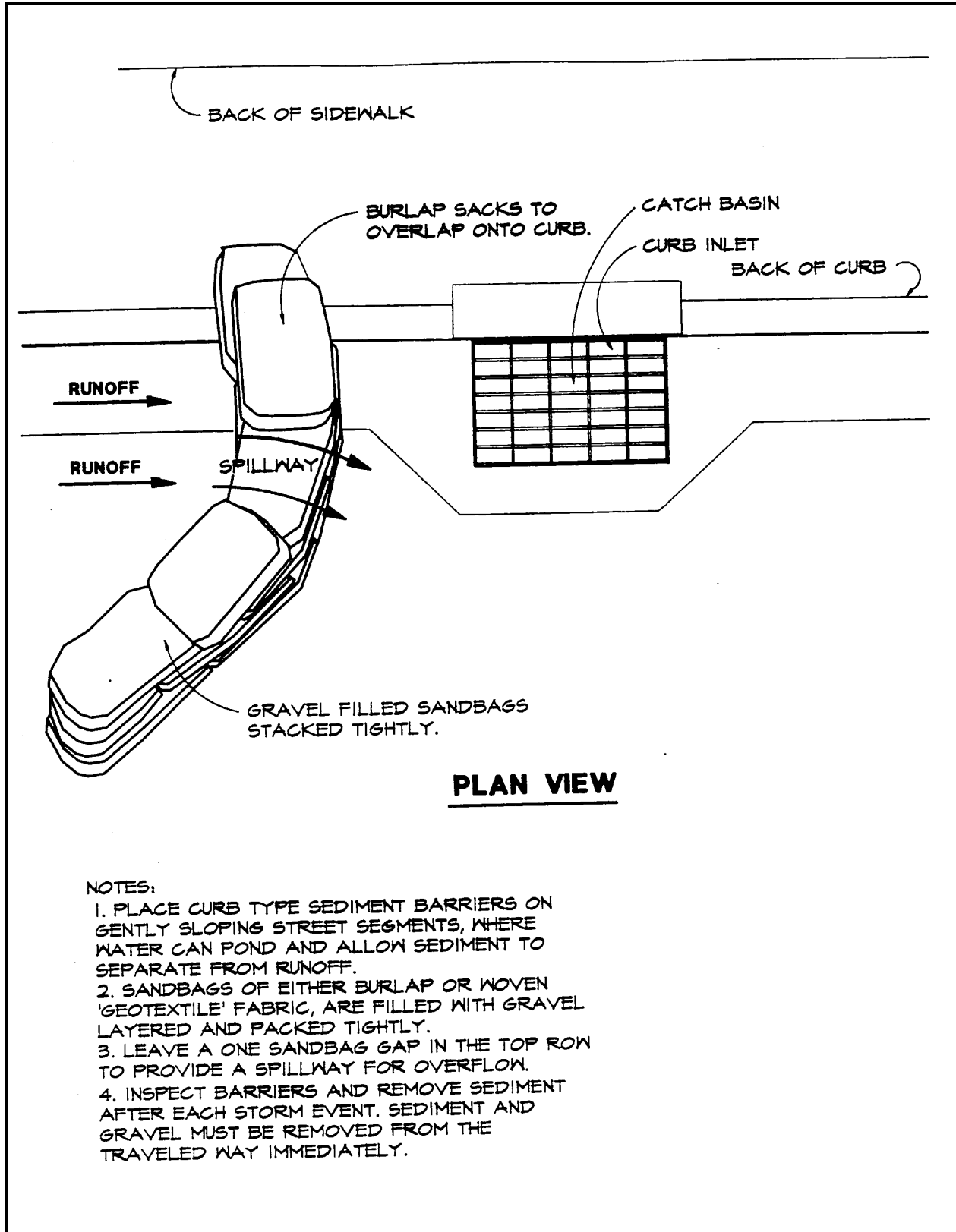

Plate 4.08q Curb and Gutter Sediment Barrier

Source: Erosion Draw

4.15 TEMPORARY DIVERSION DIKE **(ES BMP 1.15)**

Definition

A temporary ridge of compacted soil located at the top or base of a sloping disturbed area.

Purposes

1. To divert storm runoff from higher drainage areas away from unprotected slopes to a stabilized outlet.
2. To divert sediment-laden runoff from a disturbed area to a sediment trapping facility.

Condition Where Practice Applies

Wherever stormwater runoff must be temporarily diverted to protect disturbed slopes or retain sediments on site during construction. These structures generally have a life expectancy of 18 months or less.

Planning Considerations

A temporary diversion dike is intended to divert overland sheet flow to a stabilized outlet or a sediment trapping facility during establishment of permanent stabilization on sloping, disturbed areas. When used at the top of a slope, the structure protects exposed slopes by keeping upland runoff away. When used at the base of a slope, the structure protects adjacent and downstream areas by diverting sediment-laden runoff to a sediment trapping facility.

If the dike is going to remain in place for longer than 30 days, it is very important that it be established with temporary or permanent vegetation. The slope behind the dike is also an important consideration. The dike must have a positive grade to assure drainage, but if the slope is too great, precautions must be taken to prevent erosion due to high velocity flow behind the dike.

This practice is considered an economical one because it uses material available on the site and can usually be constructed with equipment needed for site grading. The useful life of the practice can be extended by stabilizing the dike with vegetation.

As specified herein, this practice is intended to be temporary. However, with more stringent design criteria, it can be made permanent in accordance with DIVERSIONS - Section 5.18 (ES BMP 1.18).

Design Criteria

No formal design is required. The following criteria shall be met:

Drainage Area

The maximum allowable drainage area is 5 acres (2 ha).

Dimensions

The minimum allowable height measured from the upslope side of the dike is 18 inches (45 cm). Top width shall be a minimum of 2 feet (60 cm) with a minimum base width of 4.5 feet (1.4 m). (See Plate 4.15a)

Side Slopes

3:1 or flatter.

Grade

The channel behind the dike shall have a positive grade to a stabilized outlet. If the channel slope is less than or equal to 2%, no stabilization is usually required. If the slope is greater than 2%, the channel shall be stabilized in accordance with STORMWATER CONVEYANCE CHANNEL - Section 5.35 (ES BMP 1.35).

Outlet

1. The diverted runoff, if free of sediment, must be released through a stabilized outlet or channel.
2. Sediment-laden runoff must be diverted and released through a sediment trapping facility.

Construction Specifications

1. Whenever feasible, the dike should be built before construction begins on the project.
2. The dike should be adequately compacted to prevent failure.
3. Temporary or permanent seeding and mulch shall be applied to the dike within 15 days of construction.
4. The dike should be located to minimize damages by construction operations and traffic.

Maintenance

The measure shall be inspected after every storm and repairs made to the dike, flow channel and outlet, as necessary. Approximately once every week, whether a storm has occurred or not, the measure shall be inspected and repairs made if needed. Damages caused by construction traffic or other activity must be repaired before the end of each working day.

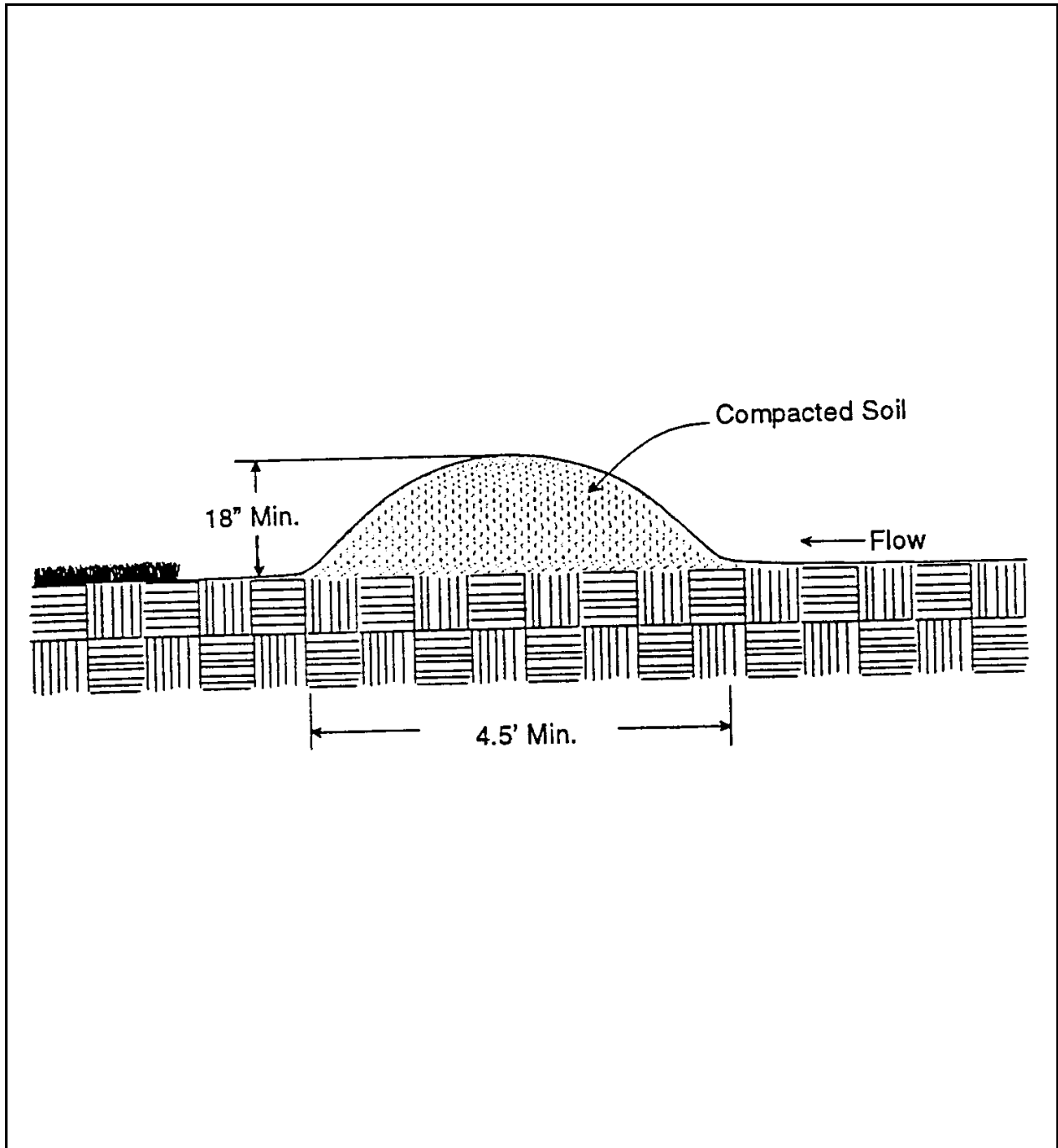

Plate 4.15a Temporary Diversion Dike
Source: Virginia DSWC

This page left intentionally blank

4.16 TEMPORARY FILL DIVERSION **(ES BMP 1.16)**

Definition

A channel with a supporting ridge on the lower side cut along the top of an active earth fill.

Purpose

To divert storm runoff away from the unprotected slope of the fill to a stabilized outlet or sediment trapping facility

Conditions Where Practice Applies

Where the drainage area at the top of an active earth fill slopes toward the exposed slope and where continuous fill operations make the use of a DIVERSION - Section 5.18 (ES BMP 1.18) unfeasible. This temporary structure should remain in place for less than one week.

Planning Considerations

One important principle of erosion and sediment control is to keep stormwater runoff away from exposed slopes. This is often accomplished by installing a dike, diversion or paved ditch at the top of a slope to carry the runoff away from the slope to a stabilized outlet or down drain. In general, these measures are installed after the final grade has been reached. On cuts, the measures may be installed at the beginning since the work proceeds from the top and the measures have little chance of being covered or damaged. On fills, the work proceeds from the bottom to the top and the elevation changes daily. It is therefore not feasible to construct a compacted dike or permanent diversion which may be covered by the next day's activity.

The temporary fill diversion is intended to provide some slope protection on a daily basis until final elevations are reached and a more permanent measure can be constructed. This practice can be constructed by the use of a motor grader or one of the smaller dozers. To shape the diversion, the piece of machinery used may run near the edge of the fill with its blade tilted to form the channel as described in Plate 4.16a. This work should be done at the end of the working day and should provide a channel with a berm on the lower side to protect the slope. Wherever possible, the temporary diversion should be sloped to direct water to a stabilized outlet. If the runoff is diverted over the fill itself, the practice may cause more problems than it solves by concentrating water at a single point.

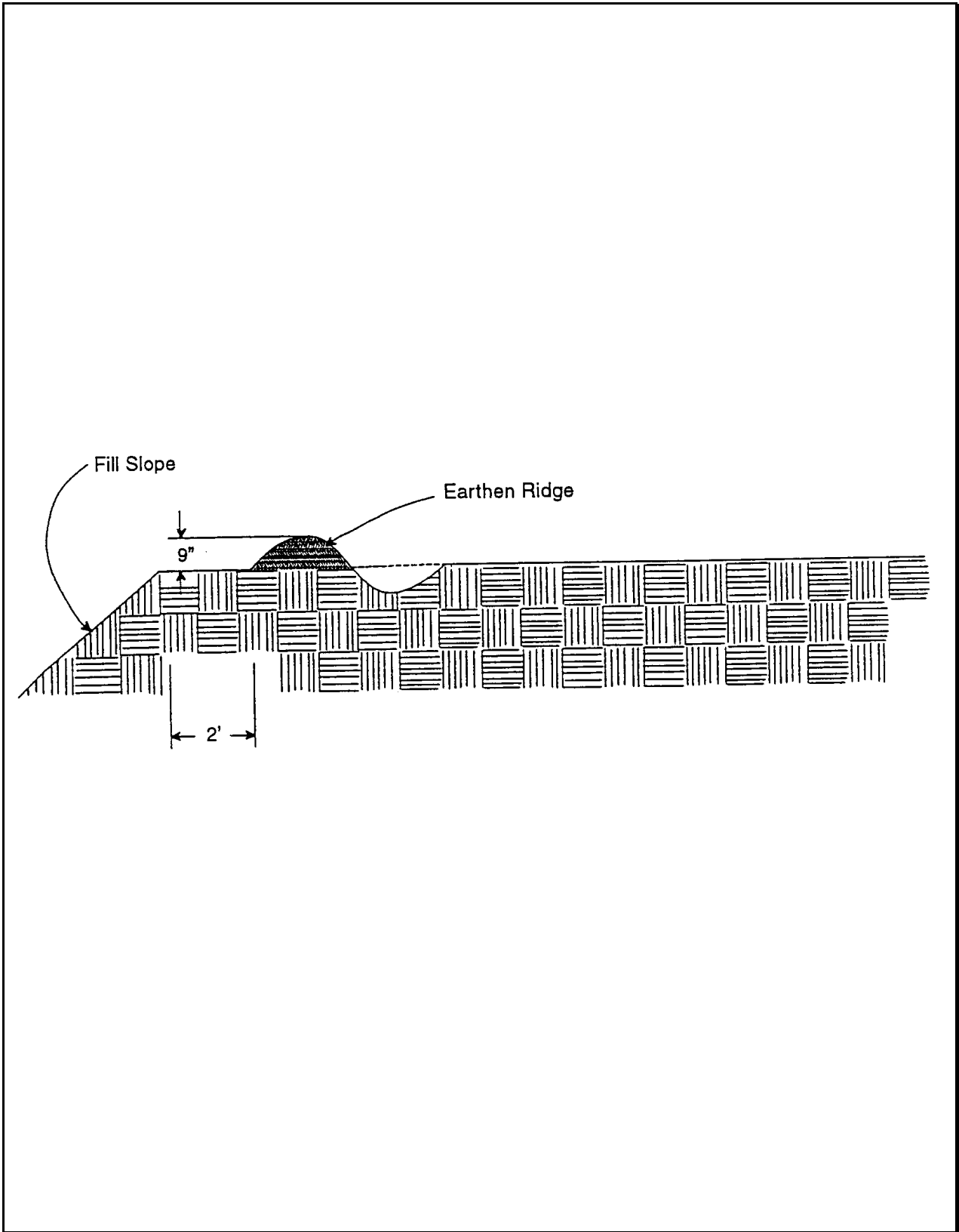

Plate 4.16a Temporary Fill Diversion
Source: Virginia DSWC

Good timing is essential to fill construction. The filling operation should be completed as quickly as possible and the permanent slope protection measures and slope stabilization measures installed as soon after completion as possible. With quick and proper construction, the developer or contractor will save both time and money in building, repairing and stabilizing the fill area. The longer the time period for construction and stabilization, the more prone the fill operation is to damages by erosion. Repairing the damages adds additional time and expense to the project.

Design Criteria

No formal design is required. The following criteria shall be met:

Drainage Area

The maximum allowable drainage area is 5 acres (2 ha).

Height

The minimum height of the supporting ridge shall be 9 inches (23 cm). (See Plate 4.16a).

Grade

The channel shall have a positive grade to a stabilized outlet.

Outlet

The diverted runoff should be released through a stabilized outlet, slope drain or sediment trapping measure.

Construction Specifications

1. The diversion shall be constructed at the top of the fill at the end of each work day as needed.
2. The diversion shall be located at least 2 feet (60 cm) inside the top edge of the fill. (See Plate 4.16a).
3. The supporting ridge of the lower side shall be constructed with a uniform height along its entire length.

Maintenance

Since the practice is temporary and under most situations will be covered the next work day, the maintenance required should be low. If the practice is to remain in use for more than one day, an inspection will be made at the end of each work day and repairs made to the measure if needed. The contractor should avoid the placement of any material over the structure while it is in use. Construction traffic should not be permitted to cross the diversion.

This page left intentionally blank

4.17 TEMPORARY RIGHT-OF-WAY DIVERSION **(ES BMP 1.17)**

Definition

A ridge of compacted soil or loose rock or gravel constructed across disturbed rights-of-way and similar sloping areas.

Purpose

To shorten the flow length within a long sloping right-of-way, thereby reducing the erosion potential by diverting storm runoff to a stabilized outlet or sediment trapping device.

Conditions Where Practice Applies

Generally, earthen diversions are applicable where there will be little or no construction traffic within the right-of-way. Gravel structures are more applicable to roads and other rights-of-way which accommodate vehicular traffic.

Planning Considerations

Construction of utility lines and roads often requires the clearing of long strips of right-of-way over sloping terrain. The volume and velocity of stormwater runoff tend to increase in these cleared strips and the potential for erosion is much greater since the vegetative cover is diminished or removed. To compensate for the loss of vegetation, it is usually a good practice to break up the flow length within the cleared strip so that runoff does not have a chance to concentrate and cause erosion. At proper spacing intervals, Temporary Right-of-Way Diversions can significantly reduce the amount of erosion which will occur until the area is permanently stabilized.

Design Criteria

No formal design is required. The following criteria shall be met:

Drainage Area

Less than 5 acres (2 ha). For larger drainage areas use a DIVERSION - Section 5.18 (ES BMP 1.18).

Dimensions

The minimum allowable height measured from the upslope side of the diversion is 18 inches (45 cm). The minimum top width shall be 2 feet (60 cm) and the base width minimum is 6 feet (1.8 m). (See Plate 4.17a)

Side Slopes

3:1 or flatter to allow the passage of construction traffic.

Width

The measure should be constructed completely across the disturbed portion of the right-of-way.

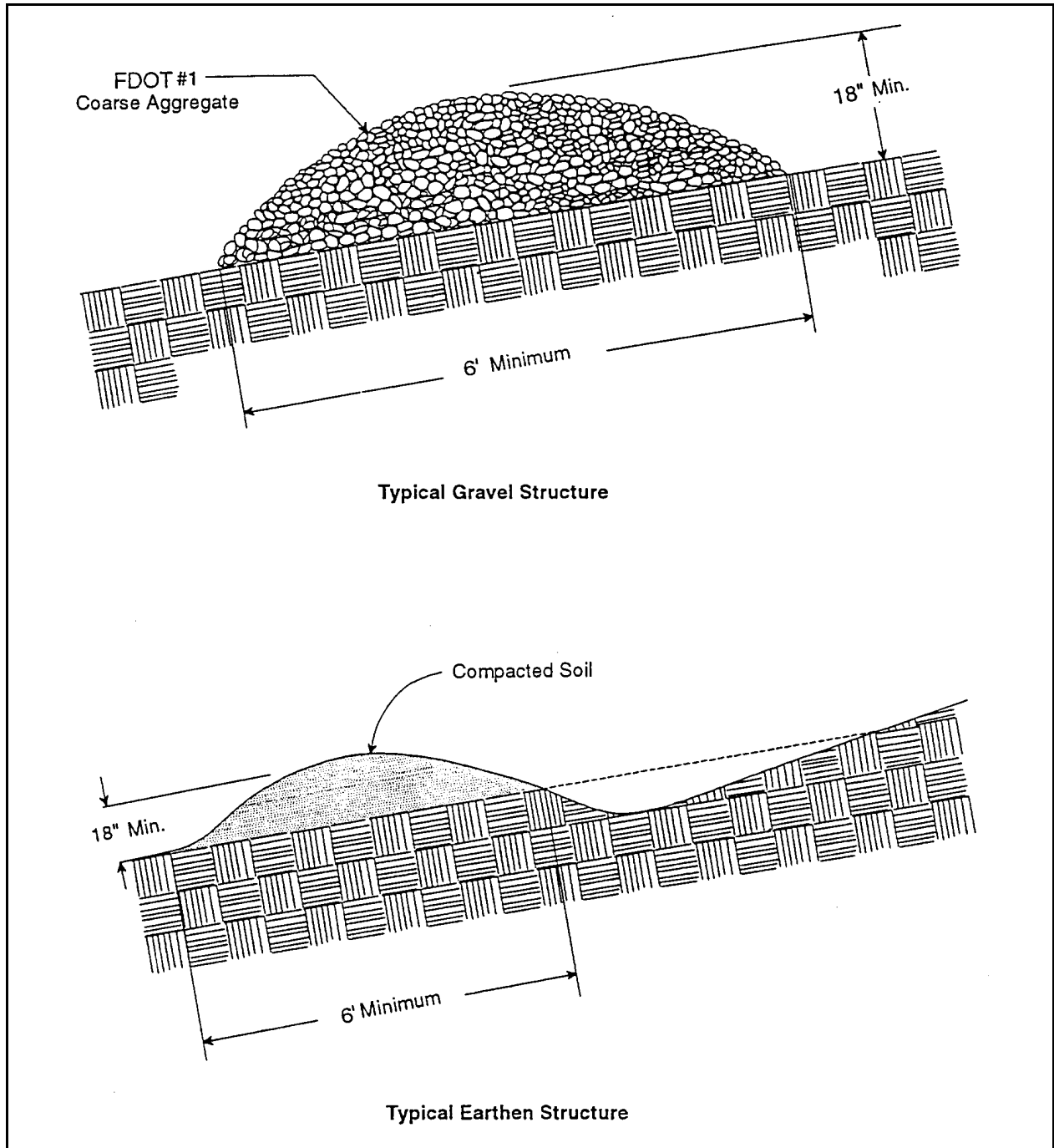

Plate 4.17a Temporary Right-of-way Diversions
Source: Virginia DSWC

Spacing

The following table will be used to determine the spacing of right-of-way diversions:

<u>% Slope</u>	<u>Spacing in feet(m)</u>
Less than 5%	300 (90 m)
Between 5% and 10%	200 (60 m)
Greater than 10%	100 (30 m)

Grade

Positive drainage, with less than 2% slope, should be provided to a stabilized outlet or sediment trapping facility.

Outlet

Interceptor dikes must have an outlet which is not subject to erosion. The on-site location may need to be adjusted to meet field conditions in order to utilize the most suitable outlet.

Concentrated flows should spread over the widest possible area after release. Flows with high sediment concentrations should pass through a sediment trapping measure. (See Plate 4.17b)

Construction Specifications

1. The diversion shall be installed as soon as the right-of-way has been cleared and/or graded.
2. All earthen diversions shall be machine- or hand-compacted in 8-inch (20 cm) lifts.
3. The outlet of the diversion shall be located on an undisturbed and stabilized area when at all possible. The field location should be adjusted as needed to utilize a stabilized outlet. Sediment laden flows shall be conveyed to a sediment trapping device.
4. Earthen diversions which will not be subject to construction traffic should be stabilized in accordance with TEMPORARY SEEDING - Section 6.65 (ES BMP 1.65).

Maintenance

The practice shall be inspected after every rainfall and repairs made if necessary. Approximately once every week, whether a storm has occurred or not, the measure shall be inspected and repairs made if needed. Diversions which are subject to damage by vehicular traffic should be reshaped at the end of each working day.

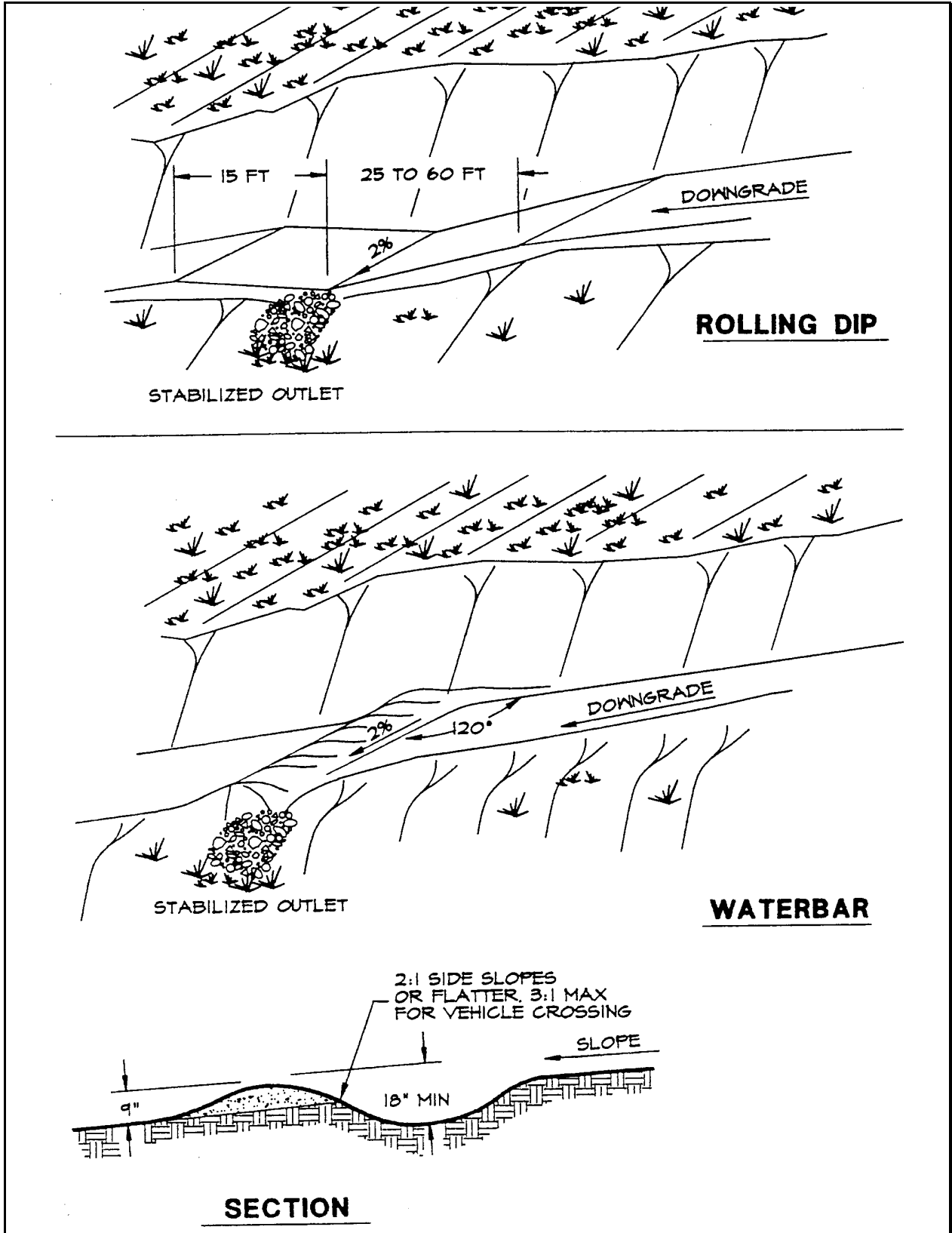

Plate 4.17b Rolling Dip and Water Bar
Source: Erosion Draw

4.25 TEMPORARY SEDIMENT TRAP **(ES BMP 1.25)**

Definition

A small temporary ponding area formed by excavation and/or an embankment across a drainageway.

Purpose

To detain sediment-laden runoff from small disturbed areas long enough to allow most of the sediment to settle out thereby protecting drainageways, properties, and rights-of-way from sedimentation.

Conditions Where Practice Applies

1. A sediment trap is usually installed in a drainageway, at a storm drain inlet or at other points of discharge from a disturbed area.
2. Below drainage areas of 5 acres (2 ha) or less.
3. Where the sediment trap will be used less than 18 months.
4. The sediment trap may be constructed either independently or in conjunction with a TEMPORARY DIVERSION DIKE - Section 4.15 (ES BMP 1.15).

Planning Considerations

The sediment trap should be located to obtain the maximum storage benefit from the terrain, for ease of clean out and disposal of the trapped sediment and to minimize interference with construction activities.

Sediment traps should be used only for small drainage areas. If the contributing drainage area is greater than 5 acres (2 ha), refer to SEDIMENT BASINS - Section 4.26 (ES BMP 1.26).

Sediment must be periodically removed from the trap. Plans should detail how this sediment is to be disposed of, such as by use in fill areas on site or removal to an approved off-site dump.

Sediment traps, along with other perimeter controls, shall be installed before any land disturbance takes place in the drainage area.

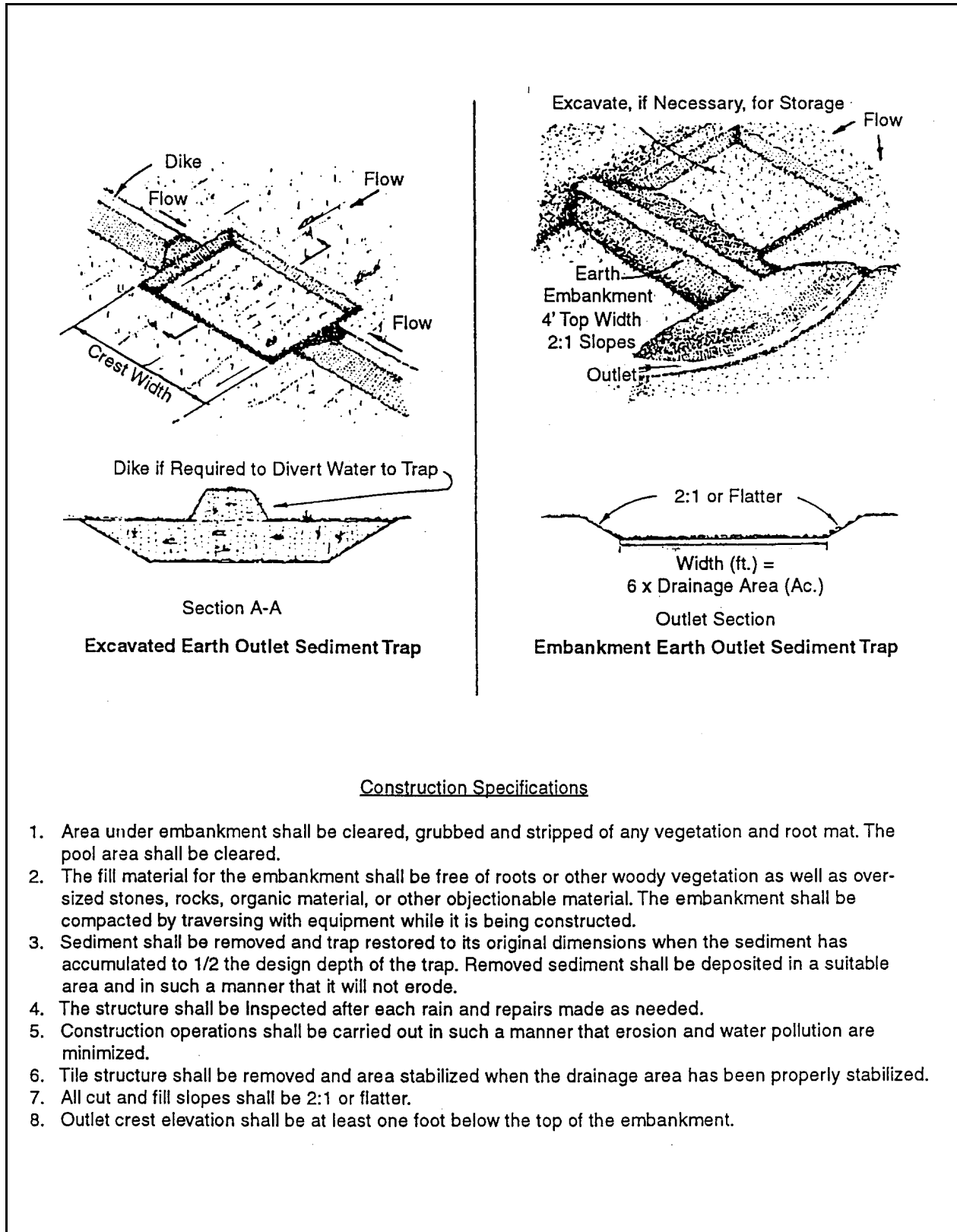

Construction Specifications

1. Area under embankment shall be cleared, grubbed and stripped of any vegetation and root mat. The pool area shall be cleared.
2. The fill material for the embankment shall be free of roots or other woody vegetation as well as oversized stones, rocks, organic material, or other objectionable material. The embankment shall be compacted by traversing with equipment while it is being constructed.
3. Sediment shall be removed and trap restored to its original dimensions when the sediment has accumulated to 1/2 the design depth of the trap. Removed sediment shall be deposited in a suitable area and in such a manner that it will not erode.
4. The structure shall be inspected after each rain and repairs made as needed.
5. Construction operations shall be carried out in such a manner that erosion and water pollution are minimized.
6. Tile structure shall be removed and area stabilized when the drainage area has been properly stabilized.
7. All cut and fill slopes shall be 2:1 or flatter.
8. Outlet crest elevation shall be at least one foot below the top of the embankment.

Plate 4.25a Earth Outlet Sediment Trap

Source: NRCS

Design Criteria

Trap Capacity

The sediment trap must have an initial storage volume of 134 cubic yards, or 3600 cubic feet per acre (252 m³/ha) of drainage area, measured from the low point of the ground to the crest of the gravel outlet. Sediment should be removed from the basin when the volume is reduced by one-half.

For a natural basin, the volume may be approximated as follows:

$$V = 0.4 \times A \times D$$

where: V = the storage volume in ft.³
 A = the surface area of the flood area at the crest of the outlet, in ft.²
 D = the maximum depth, measured from low point in trap to crest of outlet, in ft.

Excavation

If excavation is necessary to attain the required storage volume, side slopes should be no steeper than 2:1.

Embankment Cross-Section

The maximum height of the sediment trap embankment shall be 5 feet (1.5 m) as measured from the low point. Minimum top widths (W) and outlet heights (H_o) for various embankment heights (H) are shown in Table 4.25a. Side slopes of the embankment shall be 2:1 or flatter.

Table 4.25a

MINIMUM TOP WIDTH (W) AND OUTLET HEIGHT (H_o) REQUIRED FOR
 SEDIMENT TRAP EMBANKMENT ACCORDING TO HEIGHT OF EMBANKMENT (feet)

H	H _o	W
2.0	1.0	2.0
2.5	1.5	2.5
3.0	2.0	2.5
3.5	2.5	3.0
4.0	3.0	3.0
4.5	3.5	4.0
5.0	4.0	4.5

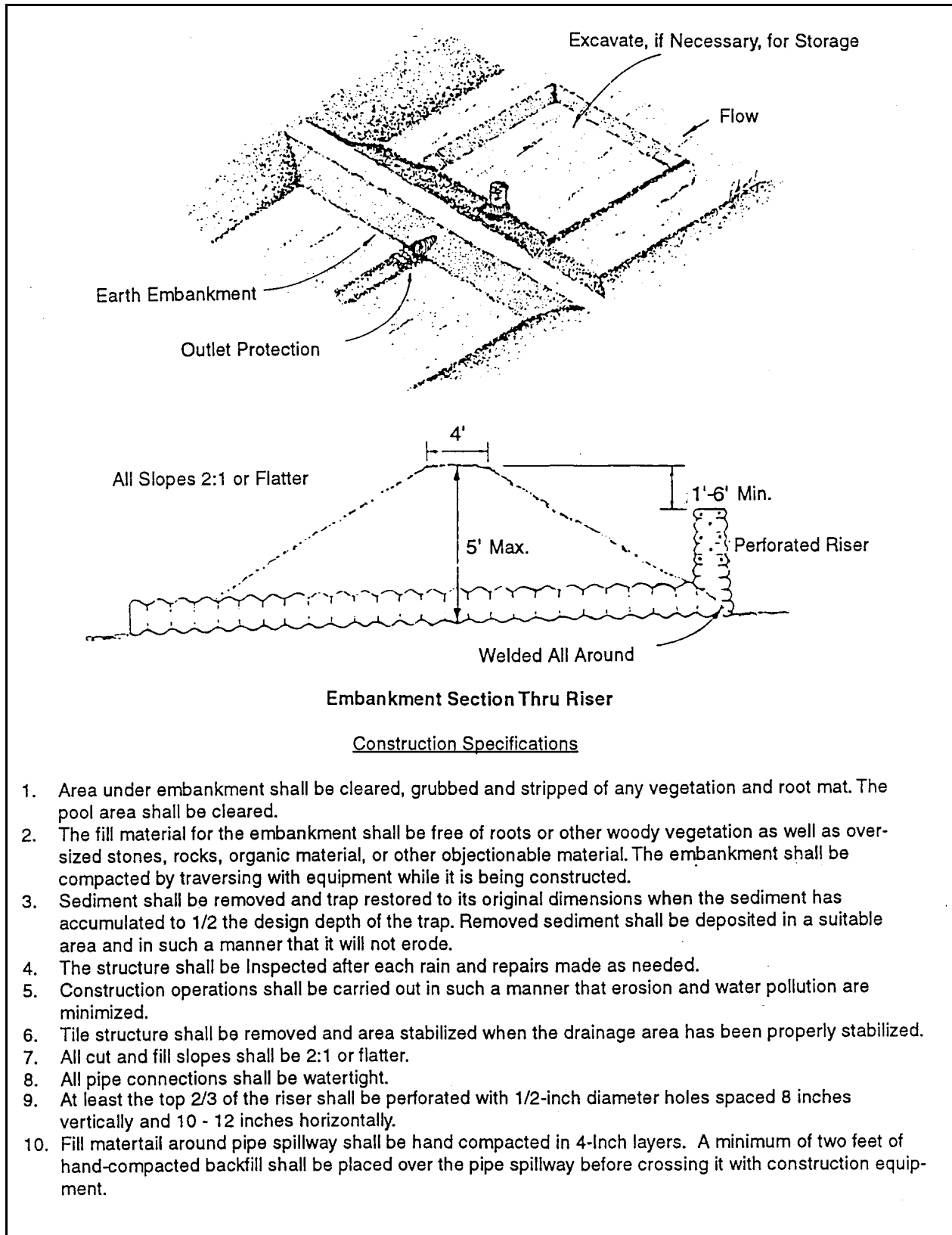

Plate 4.25b Pipe Outlet Sediment Trap

Source: NRCS

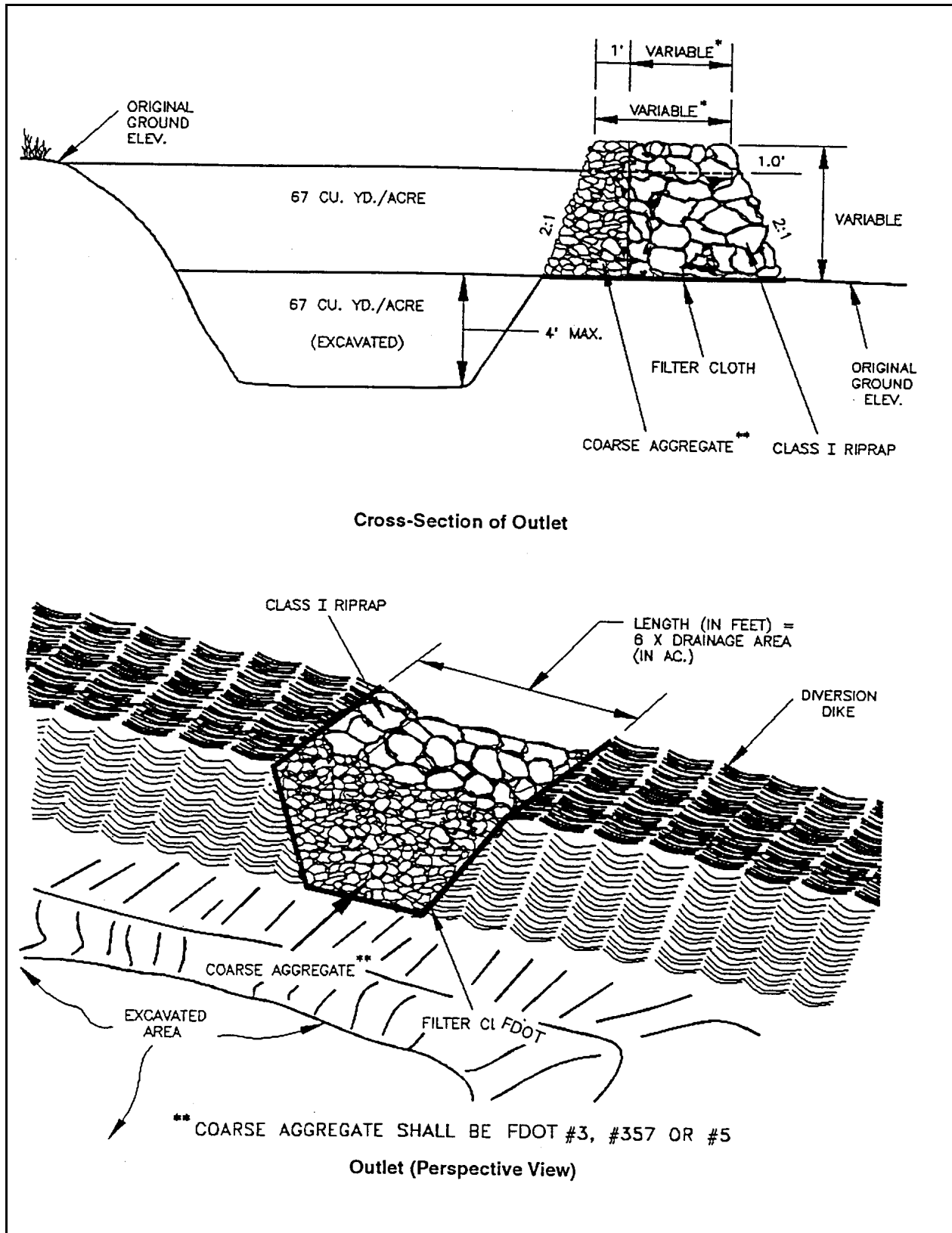

Plate 4.25c Stone Outlet Sediment Trap
Source: NRCS

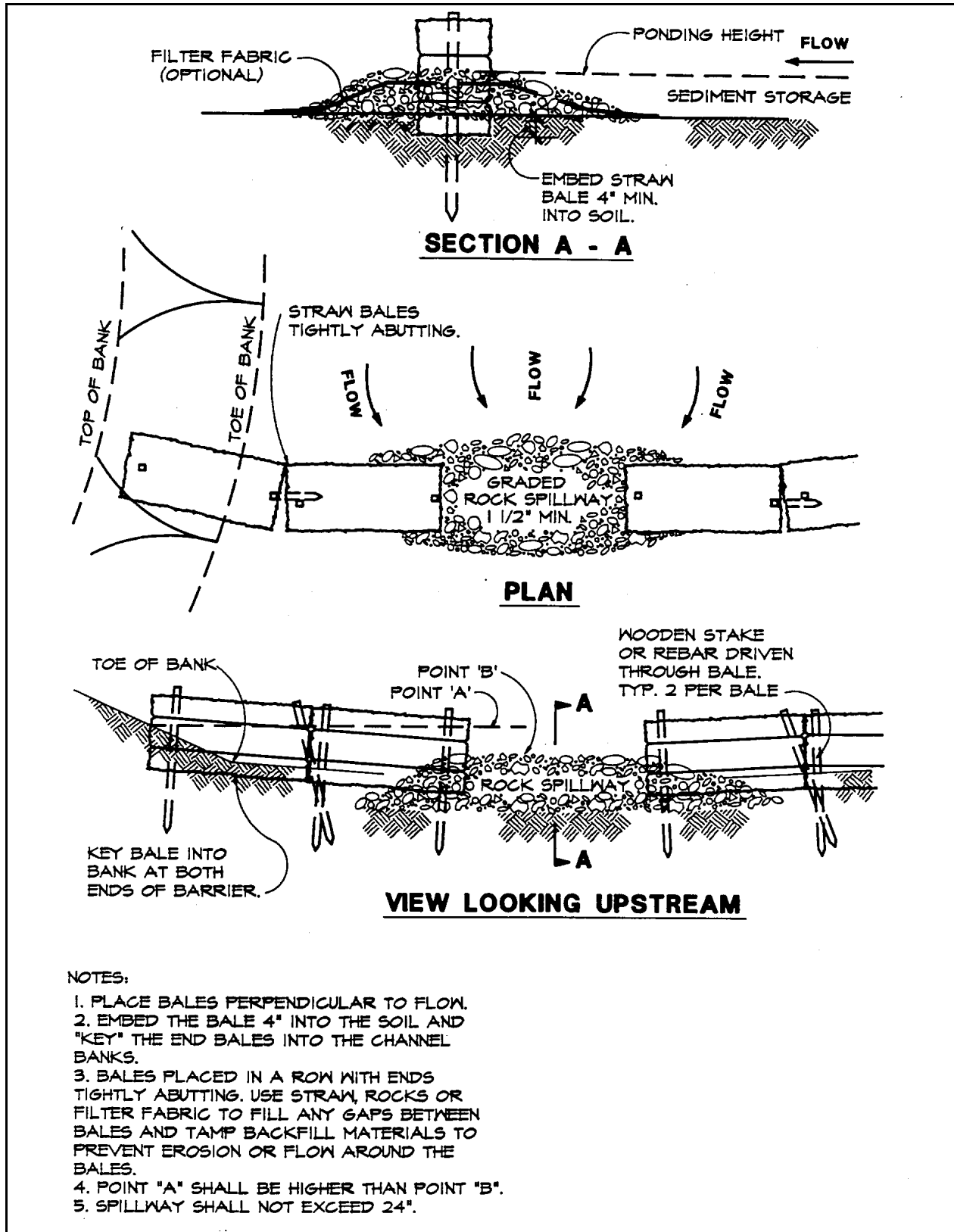

Plate 4.25d Semi-pervious Straw Bale Sediment Barrier
 Source: Erosion Draw

Outlet

The outlets shall be designed, constructed and maintained so that sediment does not leave the trap and that erosion of the outlet does not occur. A trap may have several different outlets with each outlet conveying part of the flow based on the criteria below. The combined outlet capacity shall be sufficient for the drainage area. For example, a 12 foot (3.6 m) earth outlet, adequate for 2 acres (0.8 ha), and a 12 inch (30 cm) pipe outlet, adequate for 1 acre (0.4 ha), could be used for a three acre (1.2 ha) drainage area.

There are four types of outlets for sediment traps. Each sediment trap is named according to the type of outlet that it has. Each type has different design criteria and will be discussed separately.

1. An Earth Outlet Sediment Trap consists of a basin formed by excavation and/or an embankment. The trap has a discharge point over or cut into natural ground. The outlet width (feet) shall be equal to 6 times the drainage area (acres). If an embankment is used the outlet crest shall be at least one foot (30 cm) below the top of the embankment. The outlet shall be free of any restriction to flow. The earthen embankment shall be seeded with temporary or permanent vegetation (see Sections 6.65 and 6.66) within 15 days of construction. (See Plate 4.25a)

2. A Pipe Outlet Sediment Trap consists of a basin formed by an embankment, or an excavation and an embankment. The outlet for the trap is through a perforated riser and a pipe through the embankment. The outlet pipe and riser shall be made of corrugated metal. The riser diameter shall be of the same or larger diameter than the pipe. The top of the embankment shall be at least 1.5 feet (45 cm) above the crest of the riser. At least the top 2/3 of the riser shall be perforated with 1/2 inch (13 mm) diameter holes spaced 8 inches (20 cm) vertically and 10-12 inches (25 - 30 cm) horizontally. All pipe connections shall be watertight (See Plate 4.25b). Select pipe diameter from the following table:

Minimum Pipe Diameter in inches (cm)		Maximum Drainage Area in acres (ha)	
12	(30 cm)	1	(0.4 ha)
18	(45 cm)	2	(0.8 ha)
21	(53 cm)	3	(1.2 ha)
24	(60 cm)	4	(1.6 ha)
30	(75 cm)	5	(2.0 ha)

3. A Stone Outlet Sediment Trap consists of a basin formed by an embankment or excavation and an embankment. The outlet for the sediment trap shall consist of a crushed stone section of the embankment located at the low point in the basin. The minimum length of the outlet shall be 6 feet times the acreage of the drainage area (4.5 m times hectares). The crest of the outlet must be at least 1 foot (30 cm) below the top of the embankment, to insure that the flow will travel over the stone and not the embankment. The outlet shall be constructed of FDOT No. 1 size crushed stone. (See Plate 4.25c) A very temporary alternate trap can be constructed from straw bales with a stone outlet. (See Plate 4.25d) Straw bales shall be installed per Section 4.05 STRAW BALE BARRIER (ES BMP 1.05).

4. A Storm Inlet Sediment Trap consists of a basin formed by excavation or natural ground that discharges through an opening in a storm drain inlet structure. This opening can either be the inlet opening or a temporary opening made by omitting bricks or blocks in the inlet. The trap shall be between 1' and 2' (30 - 60 cm) deep measured from the low point of the inlet. A yard drain inlet or an inlet in the median strip of a dual highway would use the inlet opening for an outlet. (See Plate 4.25e) A curb inlet would require a temporary opening. (See Plate 4.25f) The trap should be out of the roadway to avoid interference with construction. Placing the trap on the opposite side of the opening and diverting water from the roadway to the trap is one means of accomplishing this.
5. Other applications At times a small trap may be constructed in a drainage channel using the culvert for a road crossing. Straw bales or gravel filled bags may be used provided that there are no gaps in the installation. (See Plate 4.25g) In larger traps baffles may be required to insure adequate flow length and prevent short-circuiting. (See Plate 4.25h)

Construction Specifications

1. The area under the embankment shall be cleared, grubbed, and stripped of any vegetation and root mat. To facilitate cleanout, the pool area should be cleared.
2. Fill material for the embankment shall be free of roots or other woody vegetation, organic material, large stones, and other objectionable material. The embankment should be compacted in 8 inch (20 cm) layers by traversing with construction equipment.
3. The earthen embankment shall be seeded with temporary or permanent vegetation (see Sections 6.65 and 6.66) within 15 days of construction.
4. Construction operations shall be carried out so that erosion and water pollution are minimized.
5. The structure shall be removed and the area stabilized when the upslope drainage area has been stabilized.

Maintenance

1. Sediment shall be removed and the trap restored to its original dimensions when the sediment has accumulated to 1/2 the design volume of the trap. Sediment removed from the basin shall be deposited in a suitable area and in such a manner that it will not erode.
2. The structure should be checked regularly to insure that it is structurally sound and has not been damaged by erosion or construction equipment. The height of the outlet should be checked to ensure that its center is at least one foot (30 cm) below the top of the embankment.

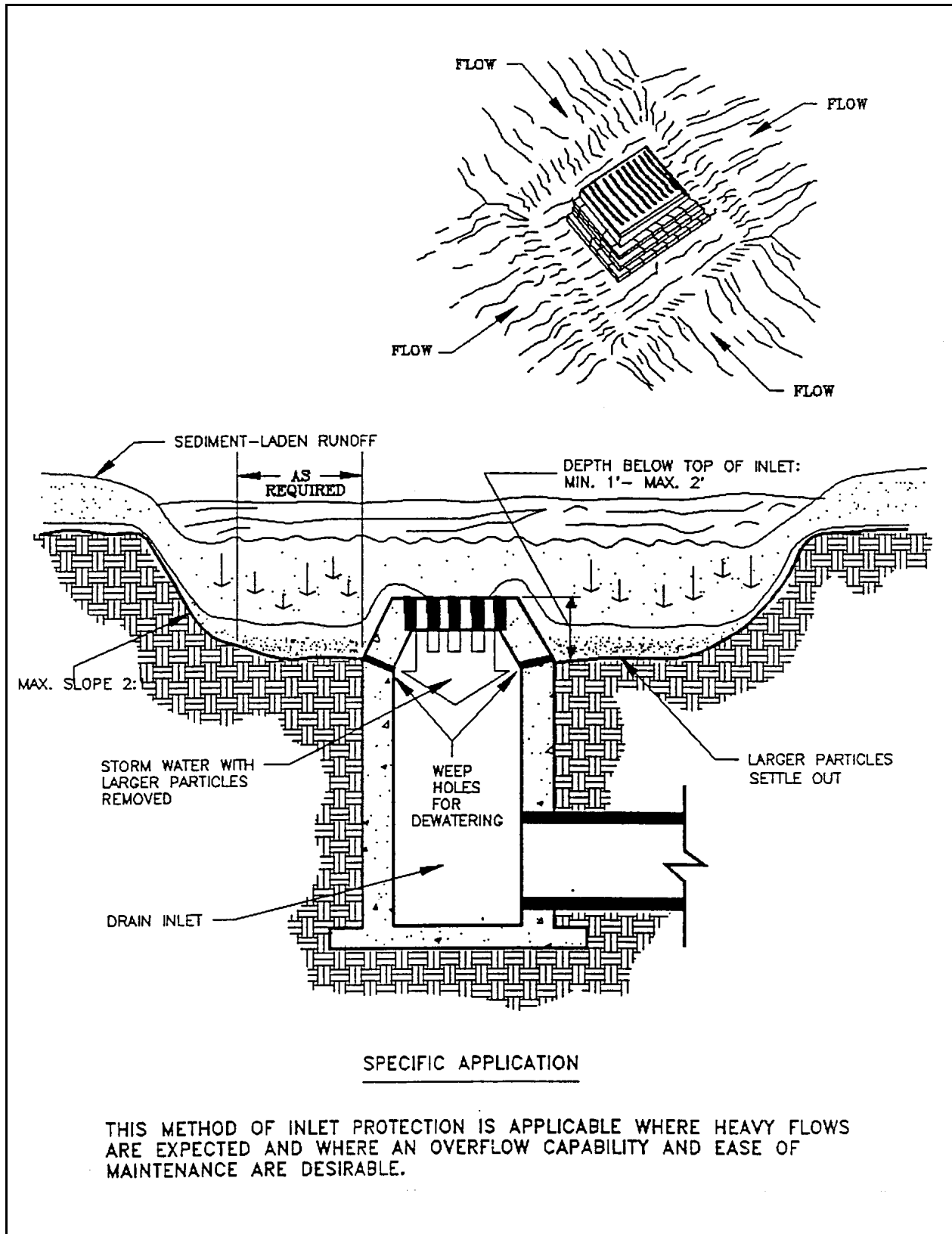
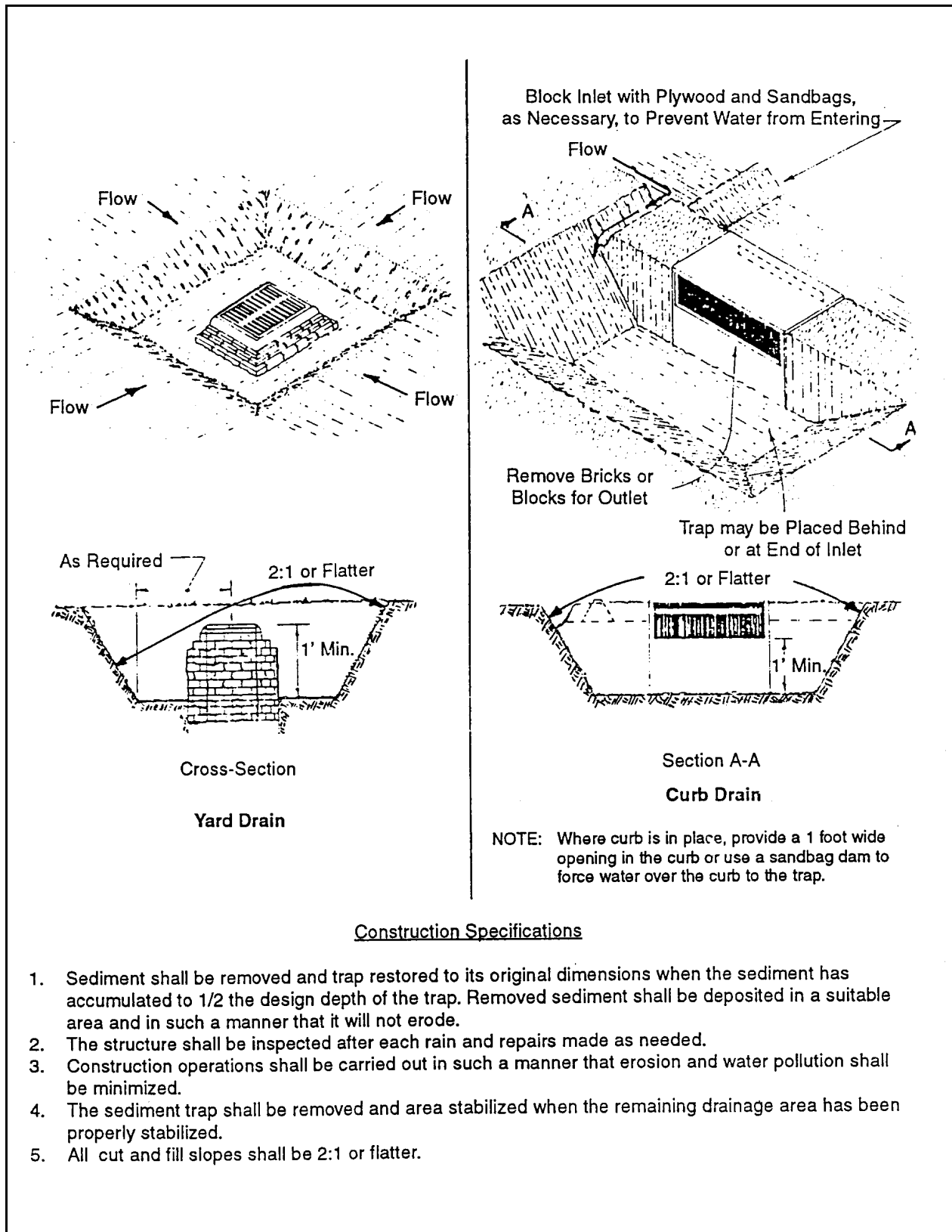

Plate 4.25e Excavated Drop Inlet Sediment Trap

Source: Michigan Soil Erosion and Sedimentation Control Guidebook



Construction Specifications

1. Sediment shall be removed and trap restored to its original dimensions when the sediment has accumulated to 1/2 the design depth of the trap. Removed sediment shall be deposited in a suitable area and in such a manner that it will not erode.
2. The structure shall be inspected after each rain and repairs made as needed.
3. Construction operations shall be carried out in such a manner that erosion and water pollution shall be minimized.
4. The sediment trap shall be removed and area stabilized when the remaining drainage area has been properly stabilized.
5. All cut and fill slopes shall be 2:1 or flatter.

Plate 4.25f Storm Inlet Sediment Trap

Source: NRCS

Removal

Sediment traps must be removed after the contributing drainage area is stabilized. Plans should show how the site of the sediment trap is to be graded and stabilized after removal.

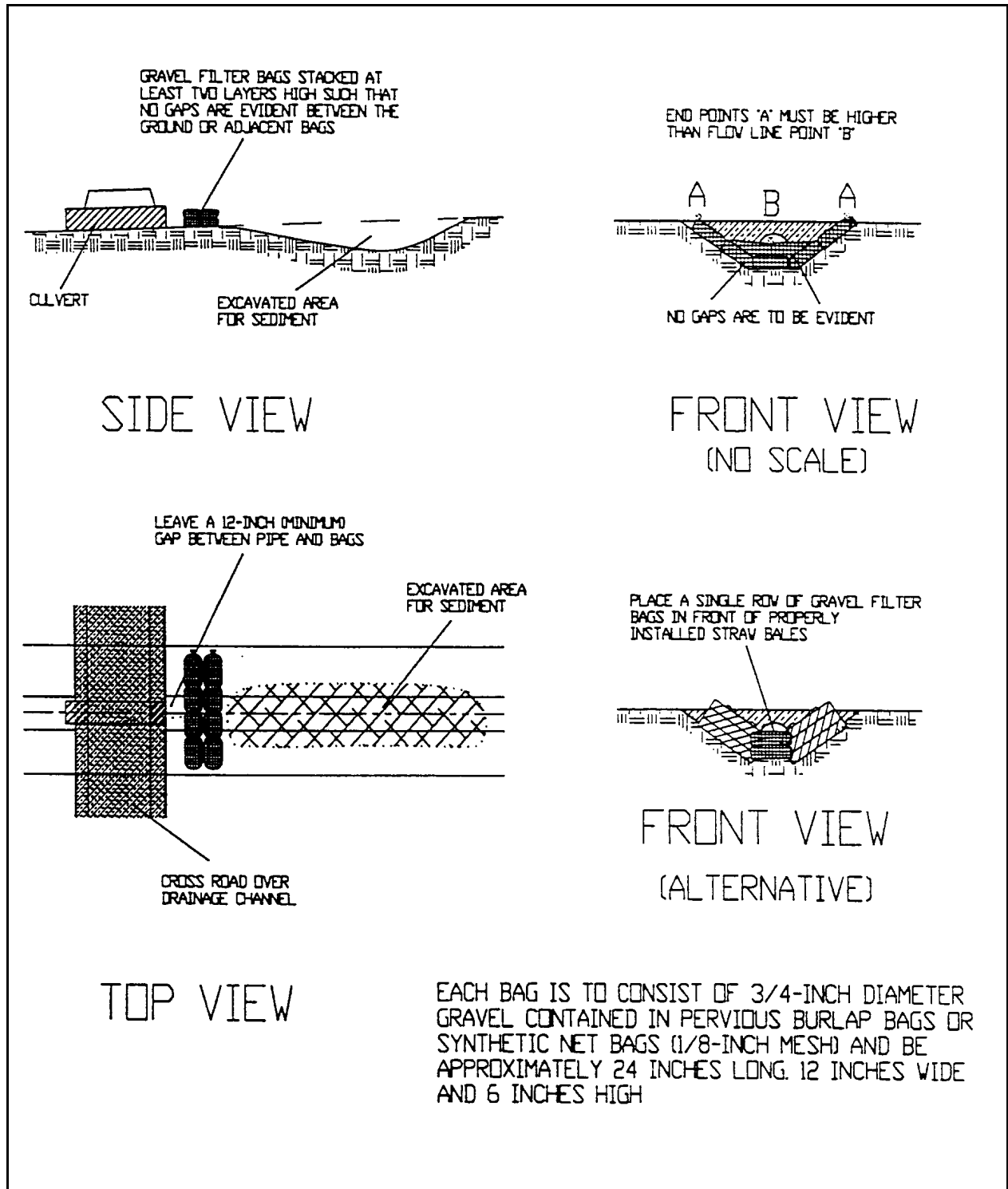

Plate 4.25g Small Sediment Trap Located within a Stormwater Conveyance Channel

Source: HydroDynamics, Inc.

SEDIMENT TRAP GUIDELINES

H (FT)	2.0	2.5	3.0	3.5	5.0	4.5	5.0
V (FT)	2.0	2.5	2.5	3.0	3.0	4.0	4.5

EMBANKMENT SIDE SLOPES ARE NOT TO BE STEEPER THAN 2:1

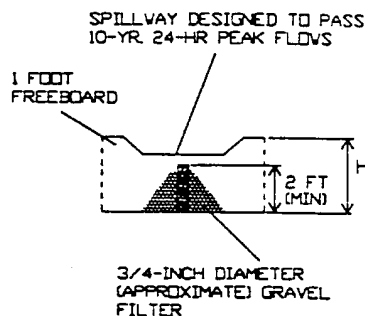
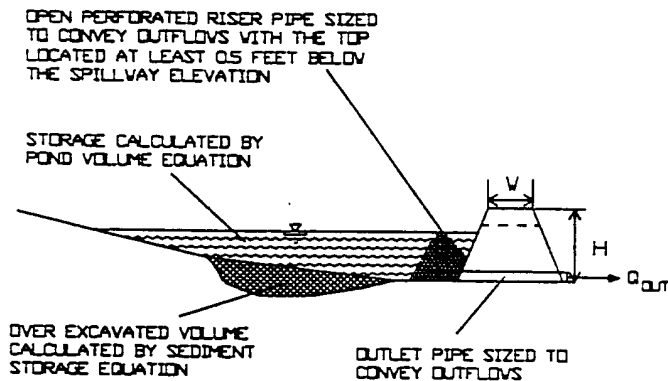

DETENTION POND SEDIMENT TRAP/BASIN

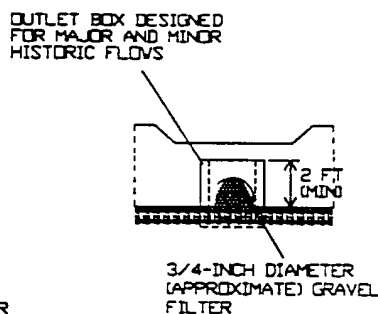
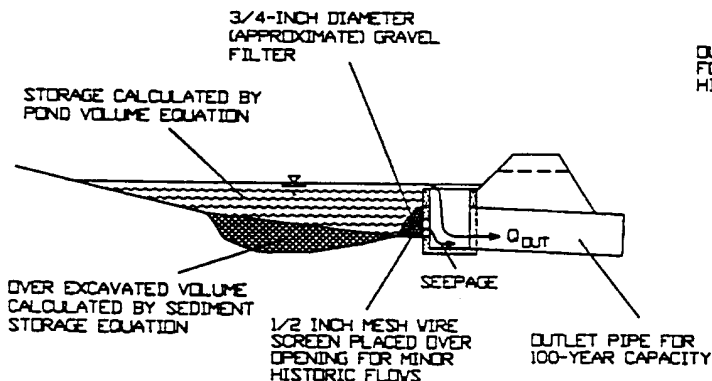

FLOW LENGTH DETAIL

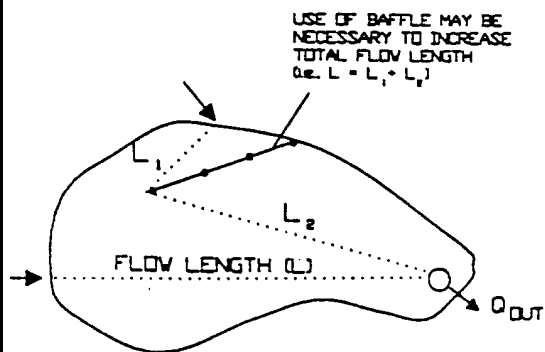

BAFFLE DETAIL

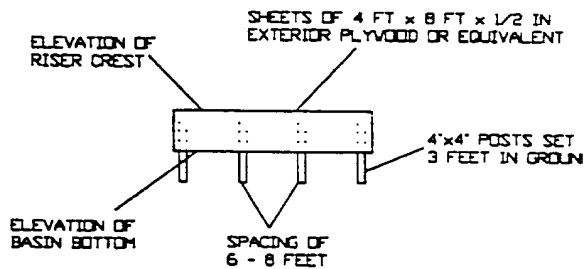

Plate 4.25h Sediment Trap and Basin Guide

Source: HydroDynamics, Inc.

4.26 TEMPORARY SEDIMENT BASIN **(ES BMP 1.26)**

Definition

A temporary basin with a controlled stormwater release structure, formed by constructing an embankment of compacted soil across a drainageway.

Purpose

To detain sediment-laden runoff from disturbed areas long enough for most of the sediment to settle out.

Conditions Where Practice Applies

Below disturbed areas greater than 5 acres (2 ha). There must be sufficient space and appropriate topography for the construction of a temporary impoundment. These structures are limited to a useful life of 18 months unless they are designed as permanent ponds by a qualified professional engineer.

Planning Considerations

Effectiveness

Sediment basins are at best only 70-80% effective in trapping sediment which flows into them. Therefore, they should be used together with erosion control practices such as temporary seeding, mulching, diversion dikes, etc. to reduce the amount of sediment flowing into the basin.

Location

To improve the effectiveness of the basin, it should be located so as to intercept the largest possible amount of runoff from the disturbed area. The best locations are generally low areas and natural drainageways below disturbed areas. Drainage into the basin can be improved by the use of diversion dikes and ditches. The basin must not be located in a live stream but should be located to trap sediment-laden runoff before it enters the stream. The basin should not be located where its failure would result in the loss of life, damage to adjacent properties, or interruption of the use of public utilities or roads.

Multiple Use

Sediment basins may be designed as permanent structures to remain in place after construction is completed. The Stormwater Rule (Ch. 62-25, F.A.C.) makes the use of these structures desirable for stormwater detention purposes. Always leave the bottom of the sediment basin 6" - 12" higher than the eventual bottom of a retention basin. This will ensure removal of accumulated fine sediments which could prematurely clog the retention basin. Wherever these structures are to become permanent, or if they exceed the size limitations of the design criteria, they must be designed as permanent ponds by a qualified professional engineer. Permanent ponds are beyond the scope of this BMP.

Design Criteria

Maximum Drainage Area

Unless the structure is designed as a permanent pond by a qualified professional engineer, the maximum allowable drainage area into the basin shall be 150 acres (61 ha).

Basin Capacity

The design capacity of the basin must be at least 134 cubic yards or 3600 cubic feet per acre ($252 \text{ m}^3/\text{ha}$) of drainage area measured from the bottom of the basin to the crest of the principal spillway (riser pipe). Sediment should be removed from the basin when the volume of the basin has been reduced to 55 cubic yards per acre ($104 \text{ m}^3/\text{ha}$) of drainage area. The elevation of the sediment clean out level should be calculated and clearly marked on the riser. In no case shall the sediment clean out level be higher than one foot (30 cm) below the top of the riser. (See Plate 4.26a).

Basin Shape

To improve sediment trapping efficiency of the basin, the effective flow length must be twice the effective flow width. This basin shape may be attained by properly selecting the site of the basin, by excavation, or by the use of baffles. See Appendix 1.26A for design details.

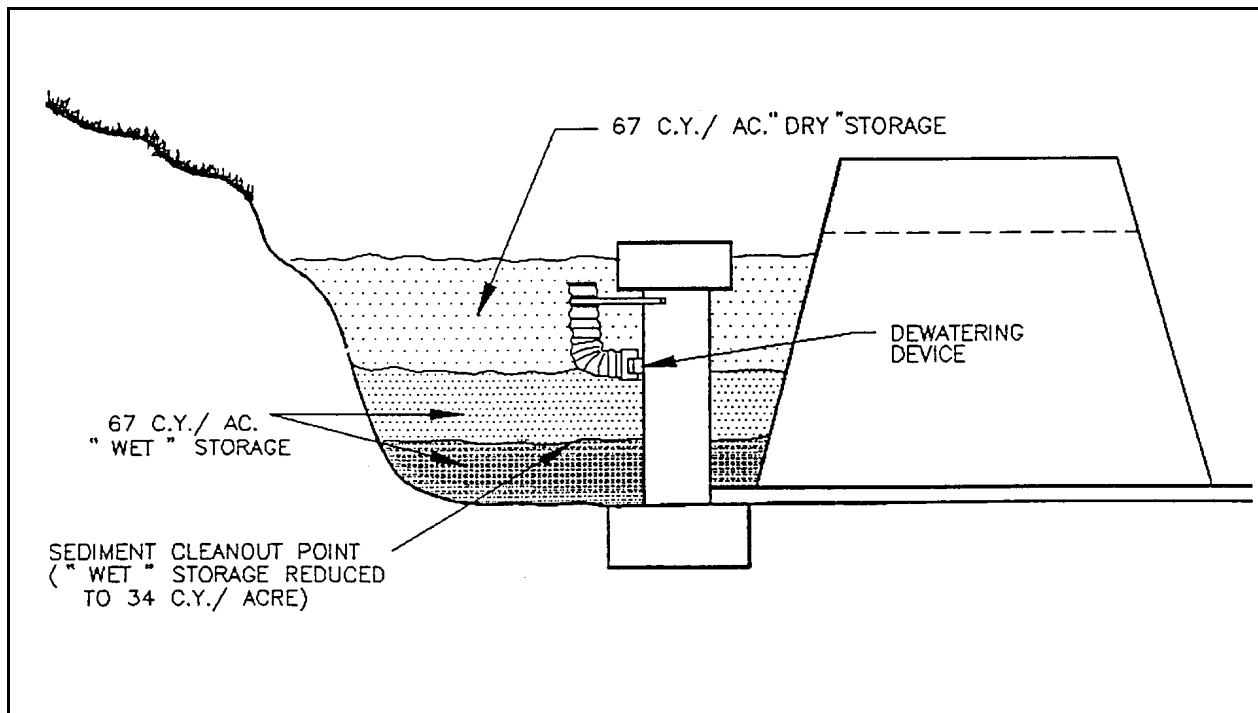

Plate 4.26a Sediment Basin Storage Volumes

Source: Virginia DSWC

Embankment Cross-Section

The embankment must have a minimum top width of 8 feet (2.5 m). The side slopes must be 2:1 or flatter. The embankment may have a maximum height of 10 feet (3 m) if the side slopes are 2:1. If the side slopes are 2.5:1 or flatter, the embankment may have a maximum height of 15 feet (4.5 m).

Spillway Design

The outlets for the basin may consist of a combination of principal and emergency spillways or a principal spillway alone. In either case, the outlet(s) must pass the peak runoff expected from the drainage area for a 10 year storm without damage to the embankment of the basin. Runoff computations shall be based upon the soil cover conditions which are expected to prevail during the life of the basin. Refer to Chapter 3 of this manual for calculation of the peak rate of runoff.

The spillways designed by the procedures contained in this BMP will not necessarily result in any reduction in the peak rate of runoff. If a reduction in peak runoff is needed, the appropriate hydrographs should be generated to choose the basin and outlet sizes.

To increase the efficiency of the basin, the spillway(s) must be designed to maintain a permanent pool of water between storm events.

Principal Spillway

The principal spillway shall consist of a solid (non-perforated), vertical pipe or box of corrugated metal or reinforced concrete joined by a watertight connection to a horizontal pipe (barrel) extending through the embankment and outletting beyond the downstream toe of the fill. If the principal spillway is used in conjunction with an emergency spillway, the principal spillway shall have a minimum capacity of 0.2 cfs per acre (0.015 m³/sec. per ha) of drainage area when the water surface is at the crest of the emergency spillway. If no emergency spillway is used, the principal spillway must be designed to pass the entire peak flow expected from a 10-year storm. See Appendix 1.26A of The Florida Development Manual for design details.

Design Elevations

If the principal spillway is used together with an emergency spillway, the crest of the principal spillway shall be a minimum of one foot (30 cm) below the crest of the emergency spillway. If no emergency spillway is used, the crest of the principal spillway shall be a minimum of 3 feet (90 cm) below the top of the embankment. (See Plate 4.26b.) In either case, a minimum freeboard of one foot (30 cm) shall be provided between the design high water and the top of the embankment.

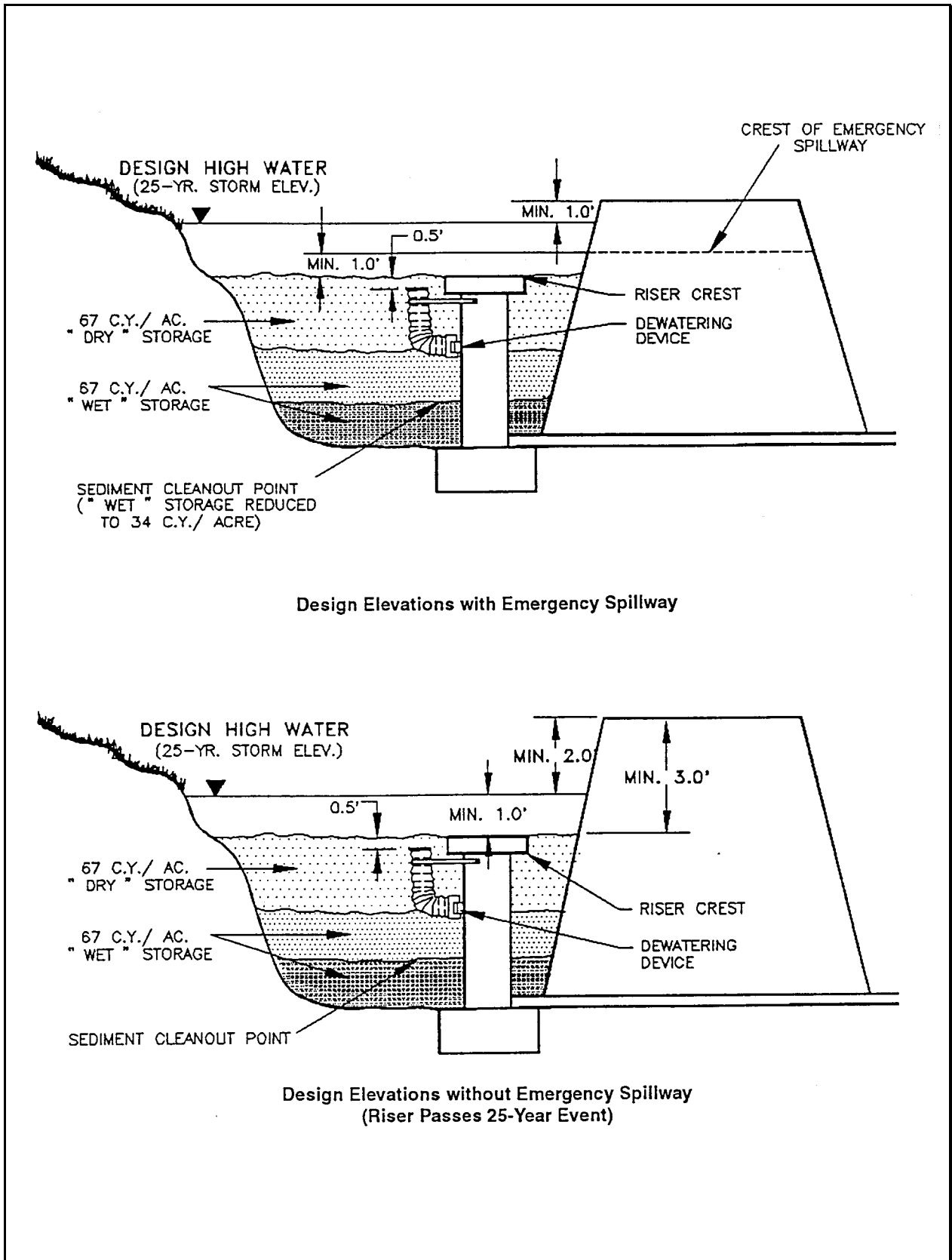

Plate 4.26b Sediment Basin Schematic Elevations

Source: Virginia DSWC

Anti-vortex device and trash rack

An anti-vortex device and trash rack shall be attached to the top of the principal spillway to improve the flow of water into the spillway and prevent floating debris from being carried out of the basin. The anti-vortex device shall be of the concentric type. (See Plate 4.26c).

See Appendix 1.26A of The Florida Development Manual for design procedures for the anti-vortex device and trash rack.

Dewatering

Shall be done in a way that removes the relatively clean water without removing any of the sediment that has settled out and without removing any appreciable quantities of floating debris. As a minimum, provisions shall be made to dewater the basin down to the sediment cleanout elevation. This can be accomplished by providing a hole at the maximum sediment retention elevation (See Plate 4.26b). The dewatering hole shall be no larger than 4 inches (10 cm) in diameter. Other means of automatic dewatering are detailed in Appendix 1.26A of The Florida Development Manual.

It is also advantageous (but not required) to provide for dewatering of trapped sediment before clean out. Basin underdrains are generally installed for this purpose. Appendix 1.26A contains details for the design of an underdrain system.

Base

The base of the principal spillway must be firmly anchored to prevent its floating. If the riser of the spillway is greater than 10 feet (3 m) in height, computations must be made to determine the anchoring requirements. As a minimum, a factor of safety of 1.25 shall be used (downward forces = 1.25 x upward forces).

For risers 10 feet (3 m) or less in height, the anchoring may be done in one of the two following ways:

1. A concrete base 18 inches (45 cm) thick and twice the width of riser diameter shall be used and the riser embedded 6 inches (15 cm) into the concrete. (See Plate 4.26d and Appendix 1.26A of The Florida Development Manual for design details).
2. A square steel plate, a minimum of 1/4 inch (6.5 mm) thick and having a width equal to twice the diameter of the riser, shall be welded to the base of the riser. The plate shall then be covered with 2.5 feet (76 cm) of stone, gravel, or compacted soil to prevent floatation. (See Plate 4.26d and Appendix 1.26A for design details).

Barrel

The barrel of the principal spillway, which extends through the embankment, shall be designed to carry the flow provided by the riser of the principal spillway with the water level at the crest of the emergency spillway. The connection between the riser and the barrel must be watertight. The outlet of the barrel must be protected to prevent erosion or scour of downstream areas. See Appendix 1.26A for design details.

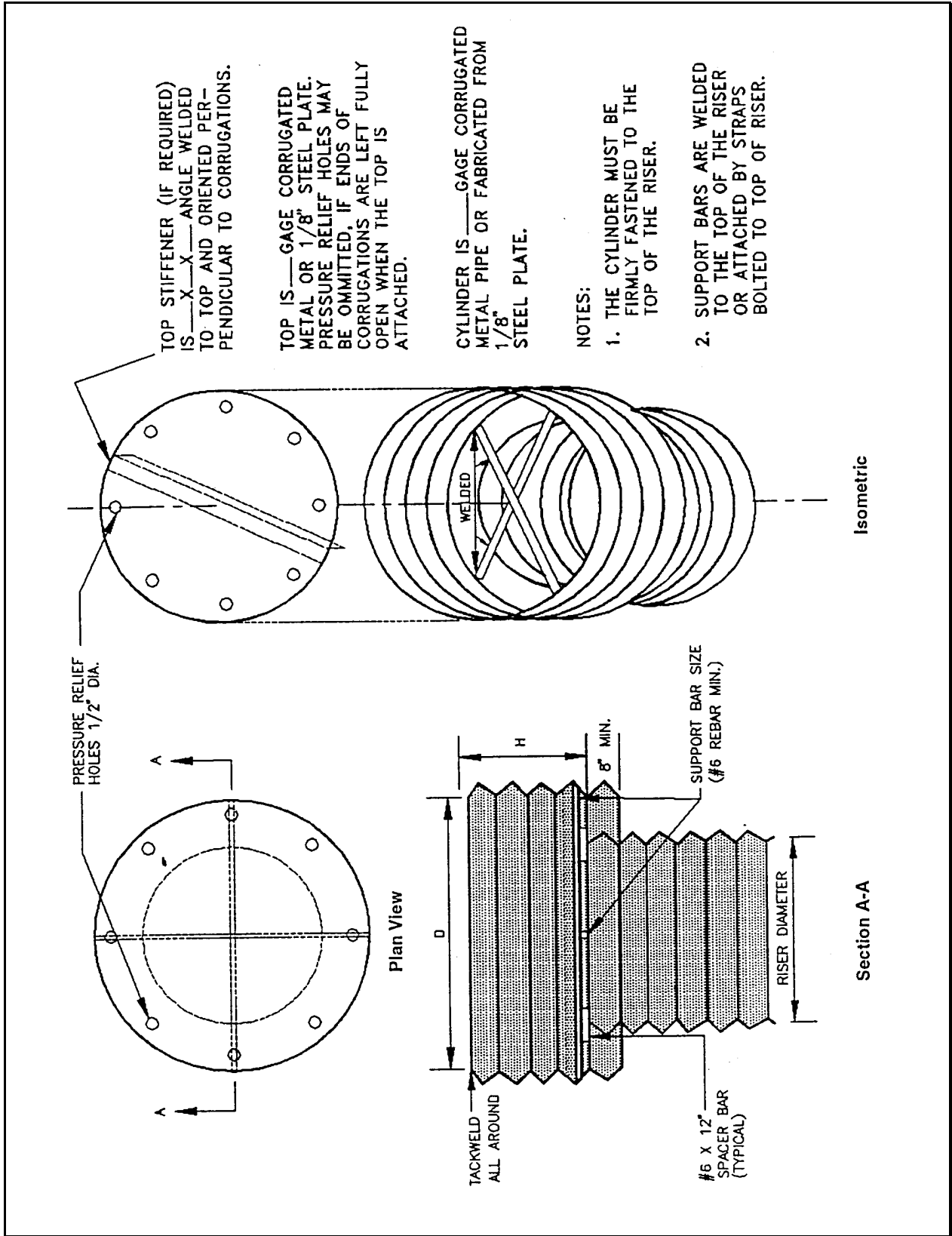

Plate 4.26c Anti-vortex Device Design
Source: NRCS

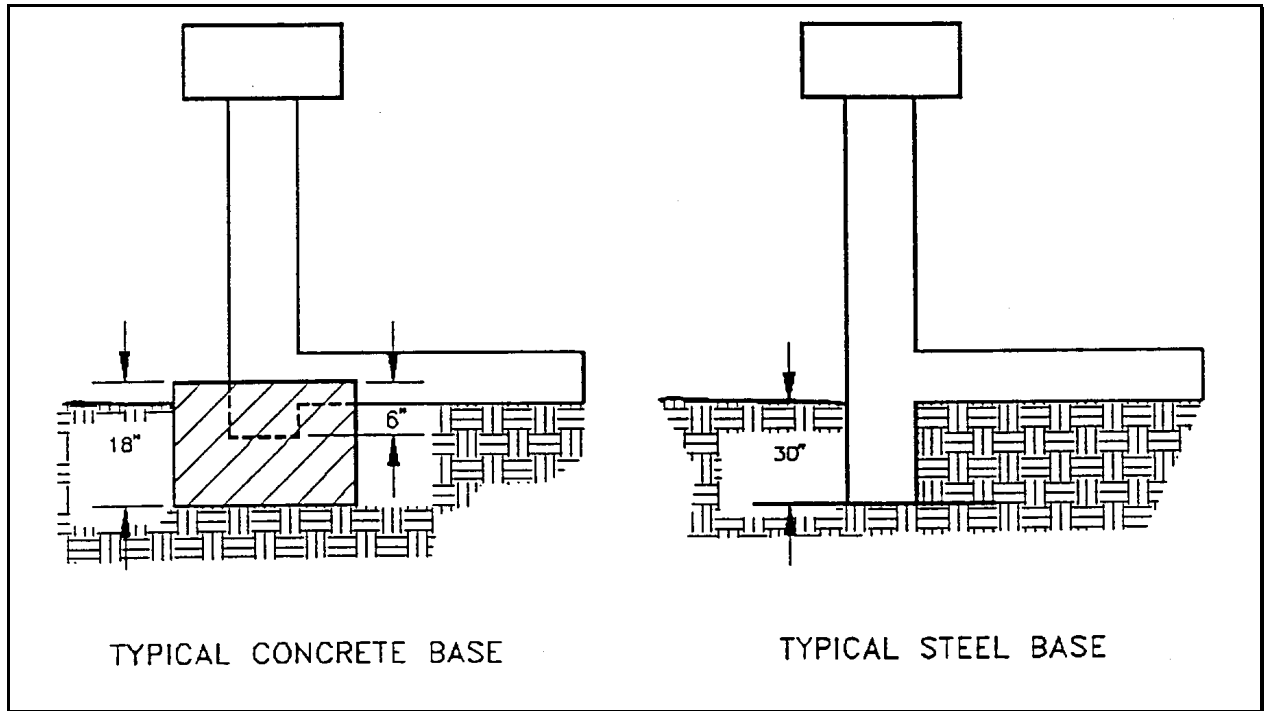

Plate 4.26d Riser Pipe Conditions
Source: Virginia DSWC

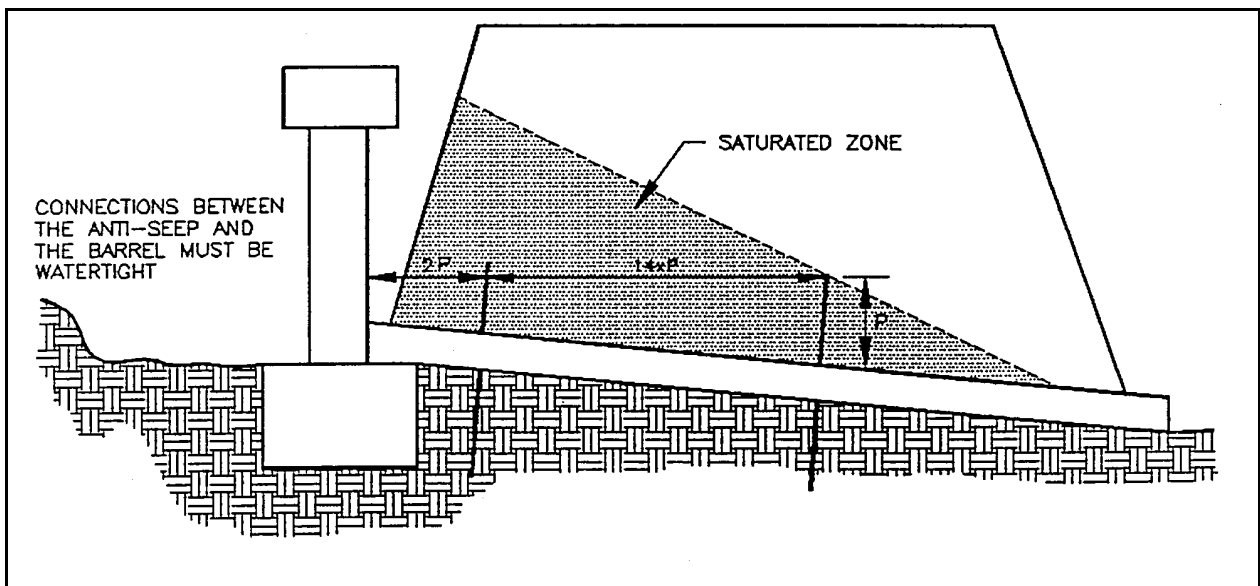

Plate 4.26e Location of Anti-seep Collars
Source: Virginia DSWC

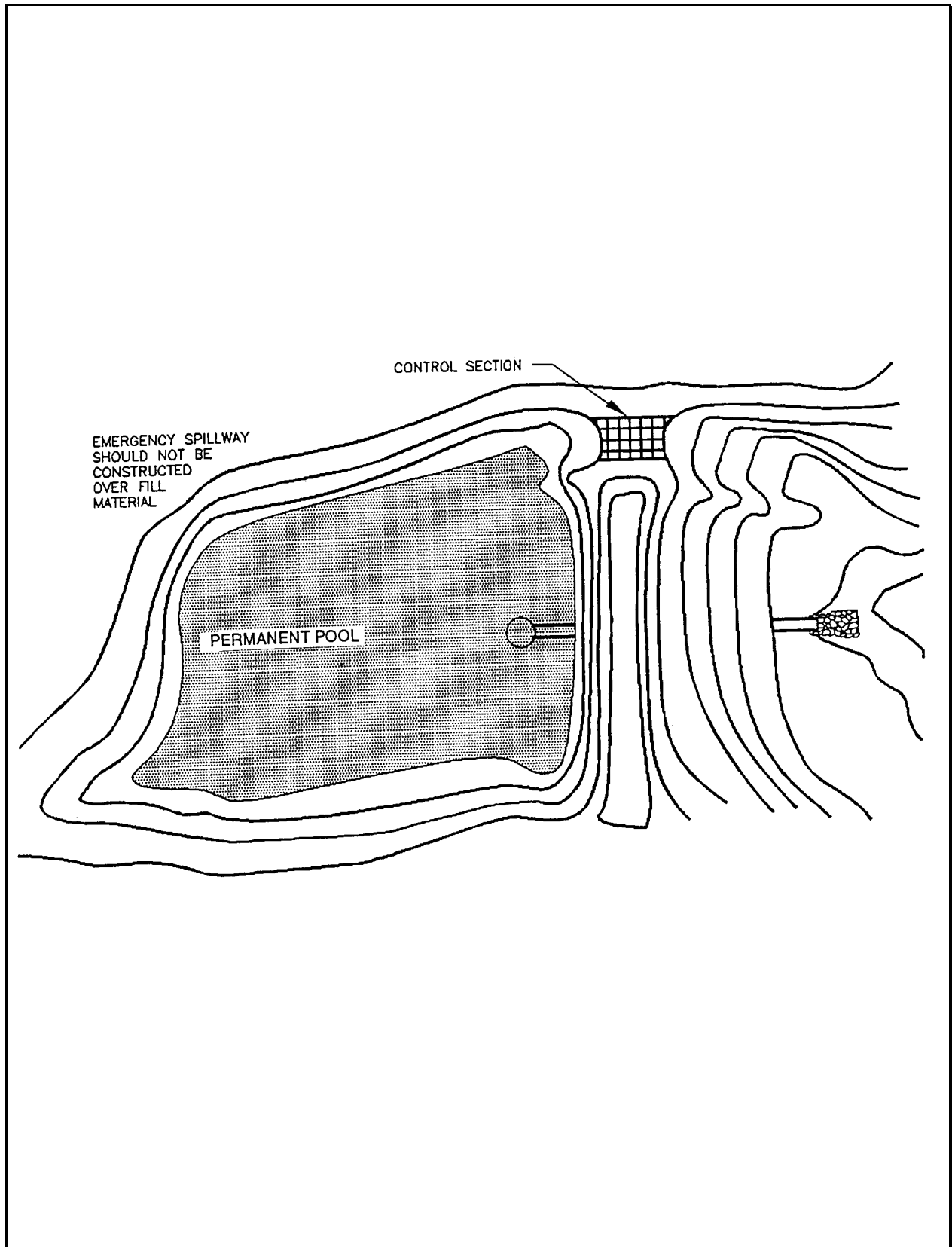

Plate 4.26f Emergency Spillway
Source: Virginia DSWC

Anti-seep collars

Anti-seep collars shall be used on the barrel of the principal spillway within the normal saturation zone of the embankment to increase the seepage length by at least 10%, if either of the following two conditions is met:

1. The settled height of the embankment exceeds 10 feet (3 m).
2. The embankment has a low silt-clay content (Unified Soil Classes SM or GM) and the barrel is greater than 10 inches (25 cm) in diameter.

The anti-seep collars shall be installed within the saturated zone. The maximum spacing between collars shall be 14 times the projection of the collar above the barrel. Collars shall not be closer than 2 feet (60 cm) to a pipe joint. Collars should be placed sufficiently far apart to allow space for hauling and compacting equipment. Connections between the collars and the barrel shall be watertight. See Plate 4.26e and Appendix 1.26A for design procedure and details.

Emergency Spillway

The emergency spillway shall consist of an open channel constructed next to the embankment over undisturbed material or properly compacted fill. The spillway shall have a control section at least 20 feet (6 m) in length. The control section is a level portion of the spillway channel at the highest elevation in the channel. (See Appendix 1.26A and Plate 4.26f). The primary spillway and the emergency spillway shall both discharge to stabilized outlets. (See Plate 4.26g).

Capacity

The emergency spillway shall be designed to carry the peak rate of runoff expected from a 10-year storm, less any reduction due to the flow through the principal spillway. See Appendix 1.26A for design details.

Design elevations

The design high water through the emergency spillway shall be at least one foot (30 cm) below the top of the embankment. The crest of the emergency spillway channel shall be at least one foot (30 cm) above the crest of the principal spillway.

Location

The emergency spillway channel shall be located to avoid fill material. If constructed on fill, the fill will be properly compacted in lifts. The channel shall be located so as to avoid sharp turns or bends. The channel shall return the flow of water to a defined channel downstream from the embankment.

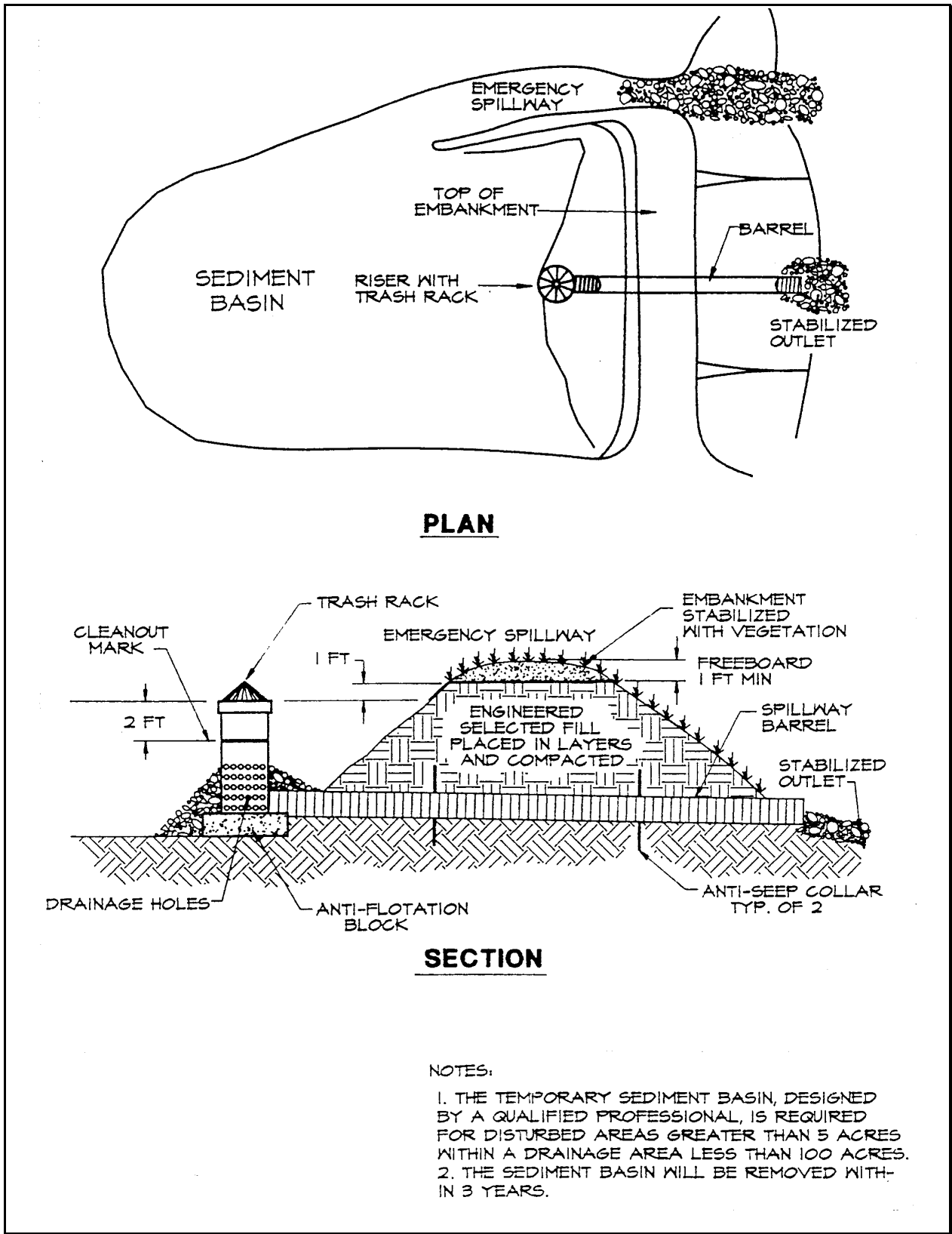

Plate 4.26g Sediment Basin

Source: Erosion Draw

Maximum velocities

The maximum allowable velocity in the emergency spillway channel will depend upon the type of lining used. For vegetated linings, allowable velocities are listed in Table 5.35a (STORMWATER CONVEYANCE CHANNEL - Section 5.35 - ES BMP 1.35). For non-erodible linings, such as concrete or asphalt paving and riprap, design velocities may be increased. However, the emergency spillway channel shall return the flow to the natural channel at a non-eroding velocity. See Appendix 1.26A for design details.

Stabilization of the Embankment and Basin

The embankment of the sediment basin shall be temporarily seeded within 15 days after its completion as per TEMPORARY SEEDING - Section 6.65 (ES BMP 1.65). If excavation is required in the basin, side slopes should not be steeper than 2:1.

Cleanout

Sediment shall be removed from the basin when the capacity is reduced to 55 cubic yards per acre (104 m³/ha) of drainage area. This elevation should be clearly marked, preferably on the riser. Plans for the sediment basin shall state the methods for disposing of sediment removed from the basin. Possible alternatives are the use of the material in fill areas on-site or removal to an approved off-site dump.

Final removal

Sediment basin plans shall show the final disposition of the sediment basin after the upstream drainage area is stabilized. The plans shall specify methods for the removal of excess water lying over the sediment, stabilization of the basin site, and the disposal of any excess material. Sediment shall not be flushed into the stream or drainageway.

Safety

Sediment basins are attractive to children and can be very dangerous. Therefore, they should be fenced or otherwise made inaccessible to persons or animals unless this is deemed unnecessary due to the remoteness of the site or other circumstances. Strategically placed signs around the impoundment reading "DANGER-QUICKSAND" should also be installed. In any case, local ordinances and regulations regarding health and safety must be adhered to.

Construction Specifications

Site Preparation

Areas under the embankment and any structural works shall be cleared, grubbed, and stripped of topsoil to remove trees, vegetation, roots, or other objectionable material. In order to facilitate cleanout and restoration, the pool area (measured at the top of the principal spillway) will be cleared of all brush and trees.

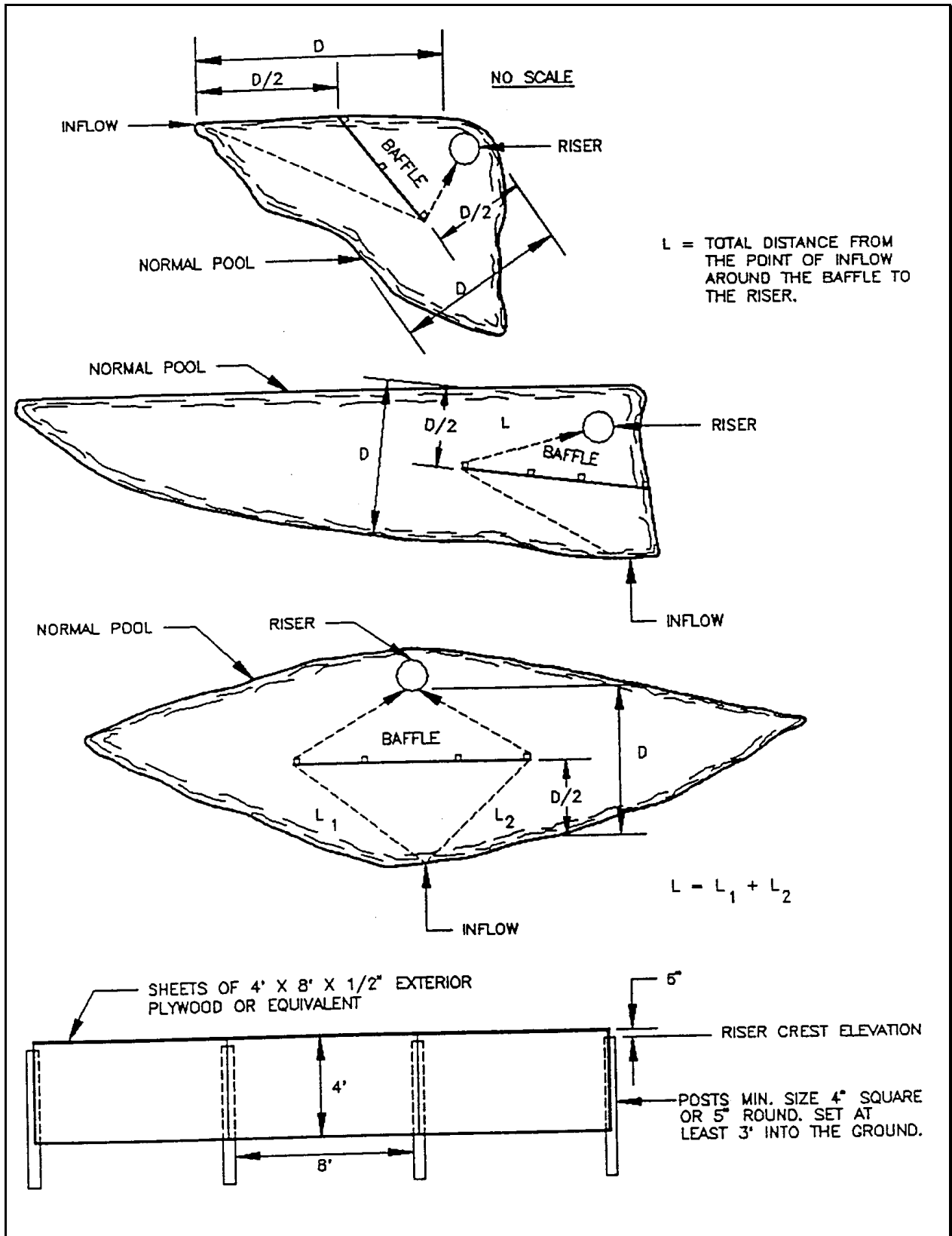

Plate 4.26h Example Plan Views of Baffle Locations in Sediment Basins

Source: NRCS

Cutoff Trench

For earth fill embankments, a cutoff trench shall be excavated along the centerline of the dam. The minimum depth shall be 2 feet (60 cm). The cutoff trench shall extend up both abutments to the riser crest elevation. The minimum bottom width shall be 4 feet (1.2 m), but wide enough to allow operation of compaction equipment. The side slopes shall be no steeper than 1:1. Compaction requirements shall be the same as those for the embankment. The trench shall be drained during the backfilling-compacting operations.

Embankment

The fill material shall be taken from approved borrow areas. It shall be clean mineral soil, free of roots, woody vegetation, oversized stones, rocks, or other objectionable material. Areas on which fill is to be placed shall be scarified prior to placement of fill. The fill material should contain sufficient moisture so that it can be formed by hand into a ball without crumbling. If water can be squeezed out of the ball, it is too wet for proper compaction. Fill material will be placed in 6 to 8 inch (15 to 20 cm) continuous layers over the entire length of the fill. Compaction shall be obtained by routing the hauling equipment over the fill so that the entire surface of the fill is traversed by at least one wheel or tread track of the equipment, or by using a compactor. The embankment shall be constructed to an elevation 10% higher than the design height to allow for settlement if compaction is obtained with hauling equipment. If compactors are used for compaction, the overbuild may be reduced to not less than 5%.

Principal Spillway

The riser of the principal spillway shall be securely attached to the barrel by a watertight connection. The barrel and riser shall be placed on a firm compacted soil foundation. The base of the riser shall be firmly anchored according to design criteria to prevent its floating. Pervious material such as sand, gravel or crushed stone shall not be used as backfill around the barrel or anti-seep collars. Fill material shall be placed around the pipe in 4 inch (10 cm) layers and compacted by hand at least to the same density as the embankment. A minimum of two feet (60 cm) of fill shall be hand-compacted over the barrel before crossing it with construction equipment.

Emergency Spillway

The emergency spillway should not be constructed over fill material. Design elevations, widths, entrance and exit channel slopes are critical to the successful operation of the spillway and should be adhered to closely during construction.

Vegetative Stabilization

The embankment and emergency spillway of the sediment basin shall be stabilized with temporary vegetation within 15 days of completion of the basin as per TEMPORARY SEEDING - Section 6.65 (ES BMP 1.65).

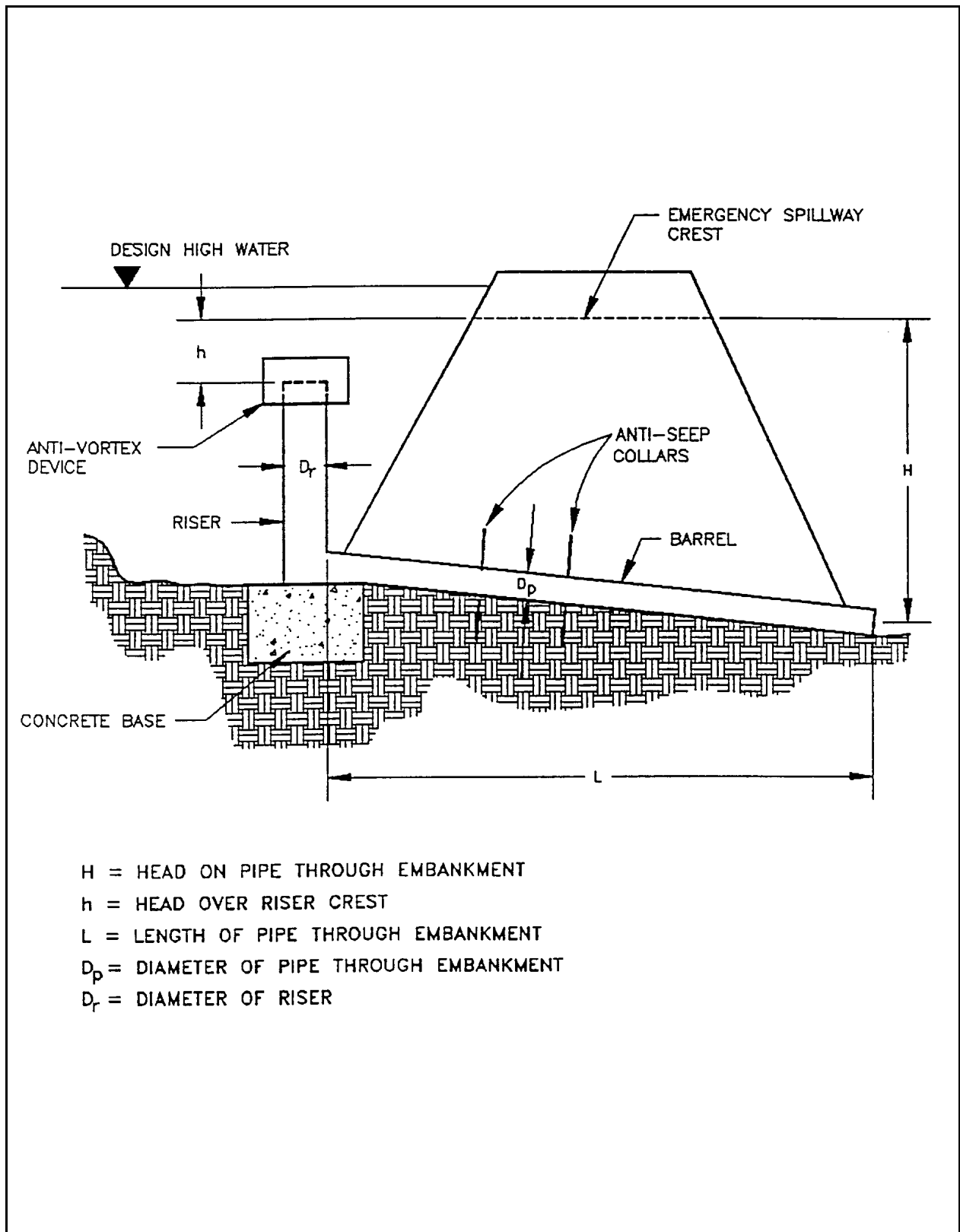

Plate 4.26i Principal Spillway Design
 Source: Virginia DSWC

Erosion and Sediment Control

The construction of the sediment basin shall be carried out in a manner such that erosion and water pollution are minimized downstream.

Final Disposal

When temporary structures have served their intended purpose and the contributing drainage area has been properly stabilized, the embankment and resulting sediment deposits are to be leveled or otherwise disposed of according to the approved pollution control plan.

Maintenance

The embankment of the basin should be checked regularly to ensure that it is structurally sound and has not been damaged by erosion or construction equipment. The emergency spillway should be checked regularly to ensure that its lining is well established and erosion-resistant. The basin should be checked after each runoff-producing rainfall for sediment cleanout. When the sediment reaches the cleanout level mark, it shall be removed and properly disposed of.

Information to be Submitted for Approval

Sediment Basin designs and construction plans submitted for review to the appropriate regulatory agency shall include:

1. Specific location of the dam.
2. Plan view of dam, storage basin and emergency spillway.
3. Cross-sections and profiles of dam, principal spillway and emergency spillway.
4. Details of pipe connections, riser to pipe connection, riser base, anti-seep collars, trash rack, and anti-vortex device.
5. Runoff calculations for 10-year frequency storm.
6. Storage Computations
 - a. Total required
 - b. Total available
 - c. Level of sediment at which cleanout shall be required; to be stated as a distance from the riser crest to the sediment surface.
7. Calculations showing design of pipe and emergency spillway.

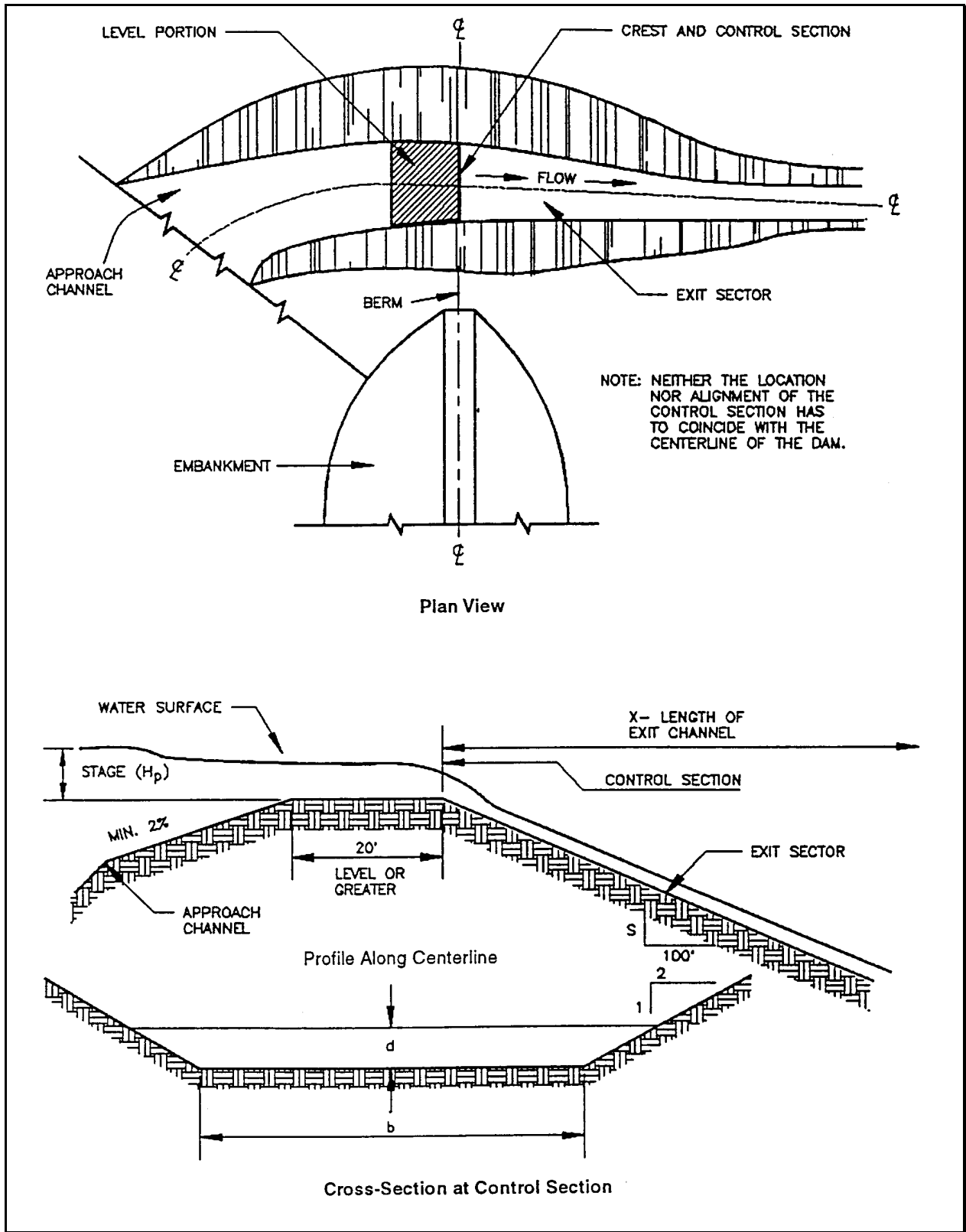

Plate 4.26j Excavated Earth Spillway
Source: NRCS

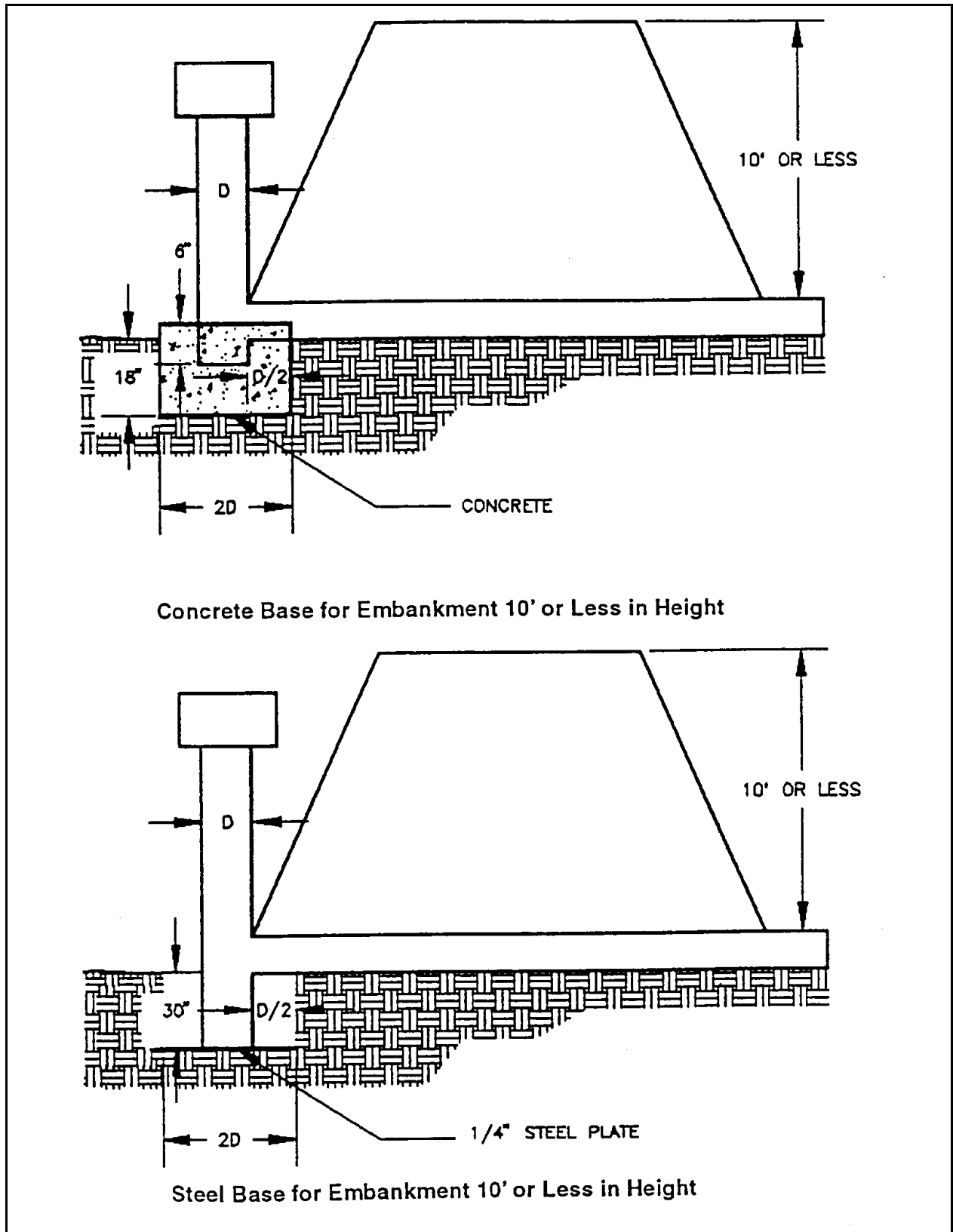

Plate 4.26k Riser Pipe Base Conditions for Embankments Less than 10 Feet High
Source: Virginia DSWC

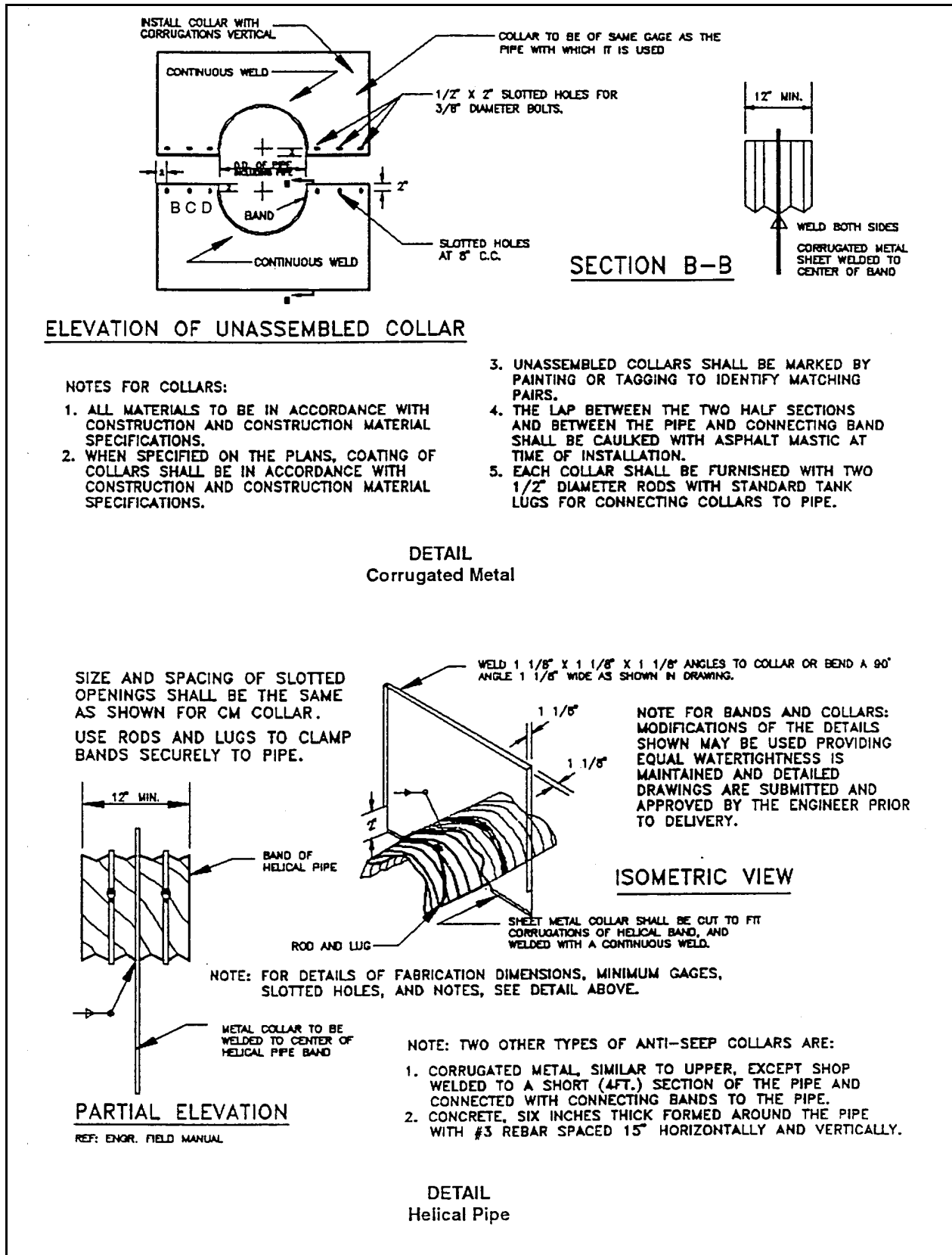

Plate 4.26L Anti-seep Collar Details

Source: NRCS

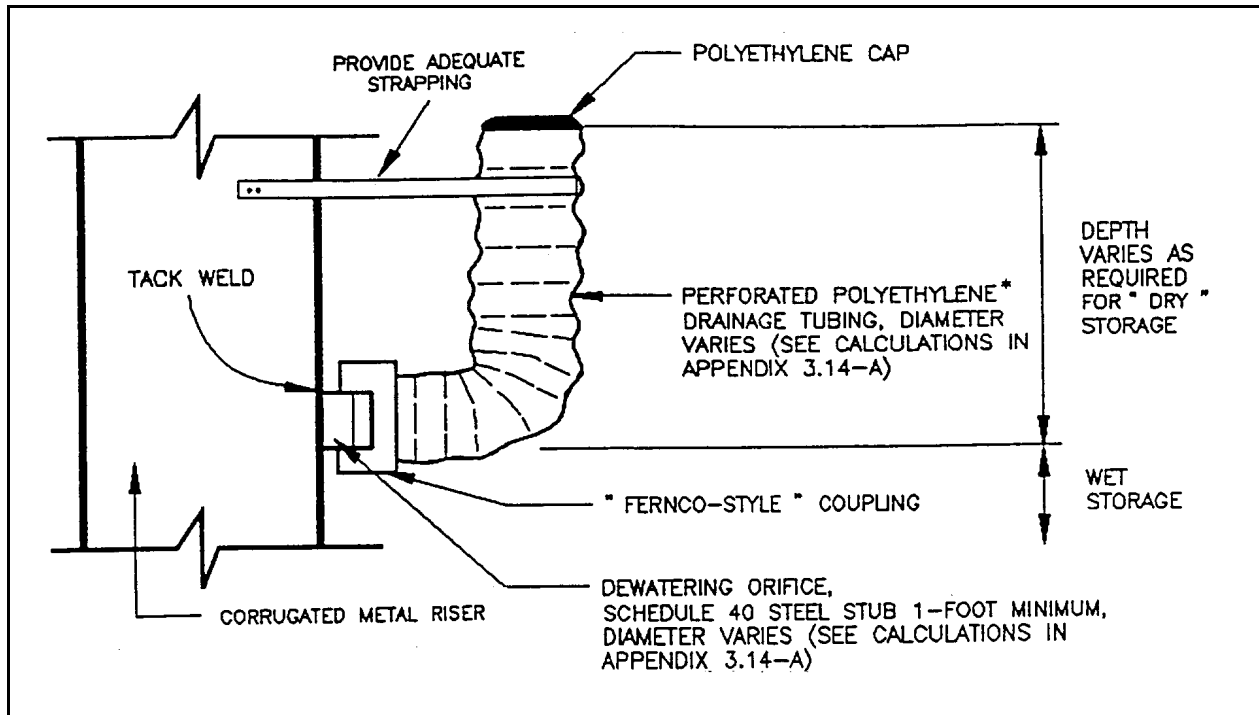

Plate 4.26m Perforated Pipe Sediment Basin Dewatering Device

Source: Virginia DSWC

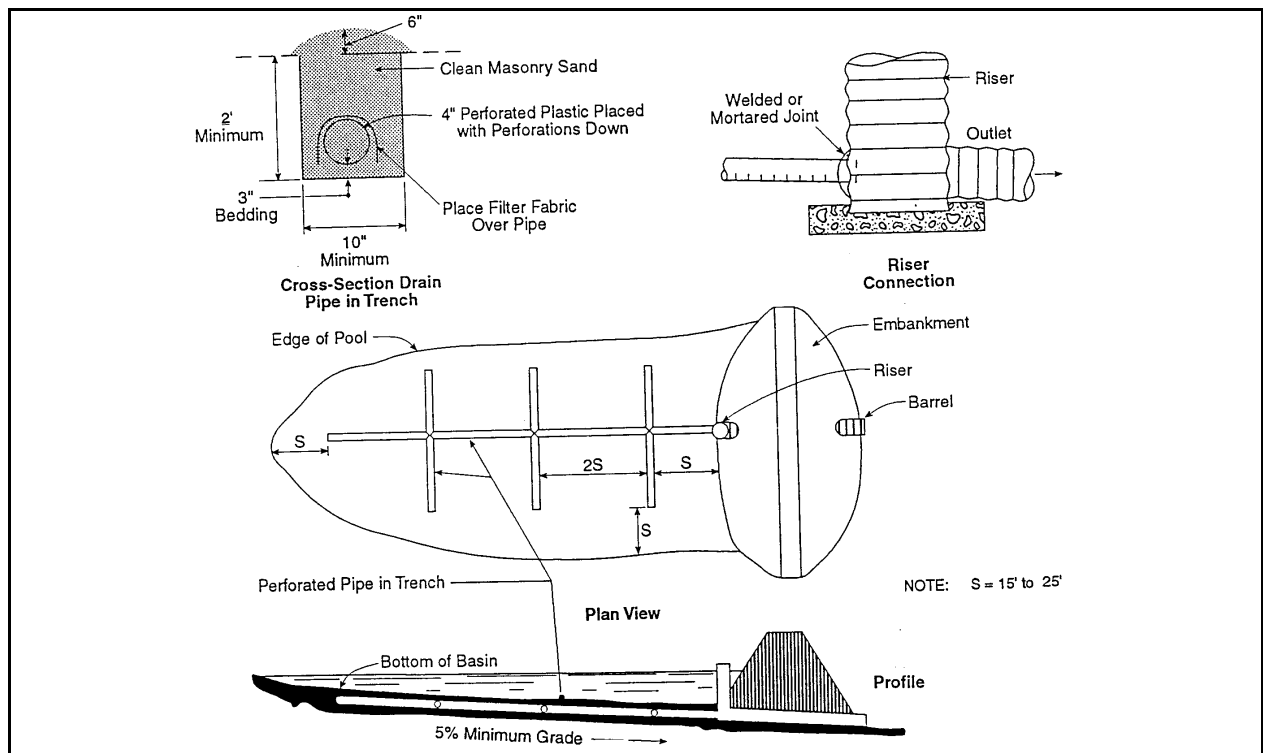

Plate 4.26n Dewatering a Sediment Basin with Subsurface Drain

Source: NRCS

This page left intentionally blank

4.30 TEMPORARY SLOPE DRAIN (ES BMP 1.30)

Definition

A flexible tubing or conduit extending from the top to the bottom of a cut or fill slope.

Purpose

To temporarily convey concentrated stormwater runoff safely down the face of a cut or fill slope without causing erosion problems on or below the slope.

Conditions Where Practice Applies

On cut or fill slopes before permanent stormwater drainage structures are installed.

Planning Considerations

There is often a significant lag between the time a cut or fill slope is completed and the time a permanent drainage system can be installed. During this period, the slope is usually not stabilized and is particularly vulnerable to erosion. This situation also occurs on slope construction which is temporarily delayed before final grade is reached. Temporary slope drains can provide valuable protection of exposed slopes until permanent drainage structures can be installed.

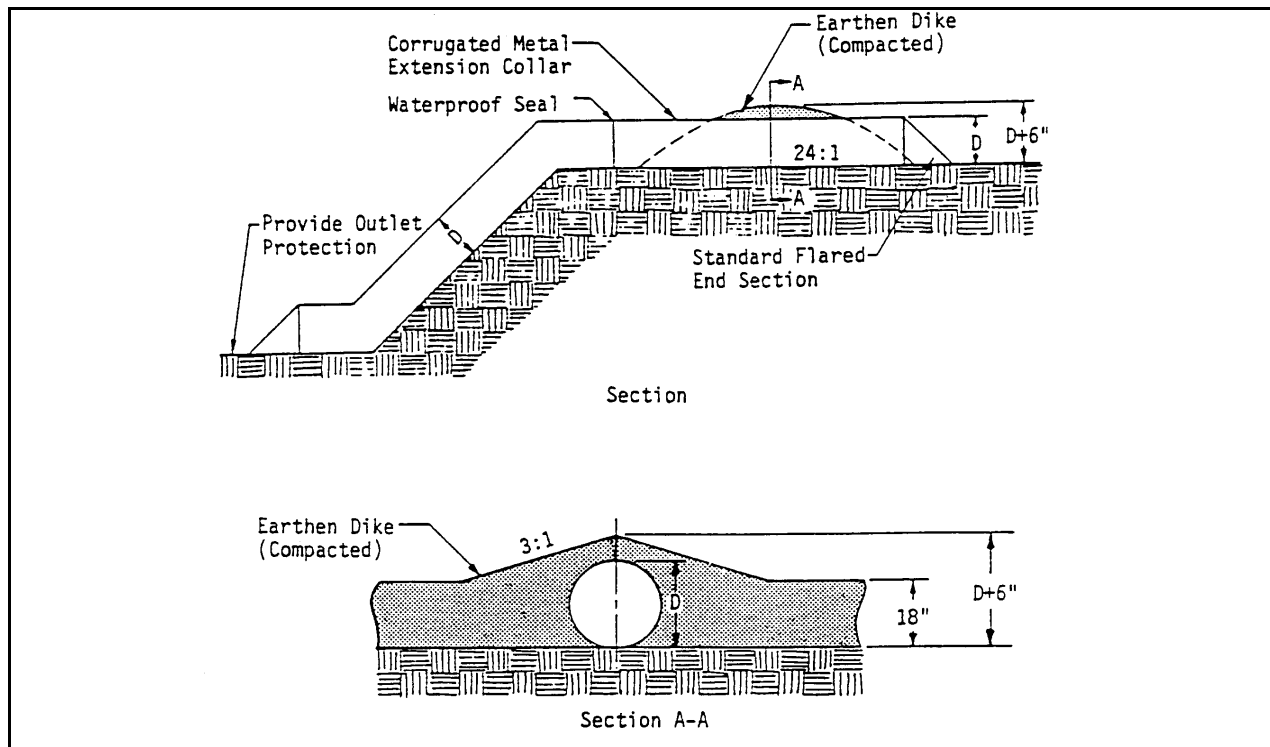

Plate 4.30a Temporary Slope Drain
Source: Virginia SWCC

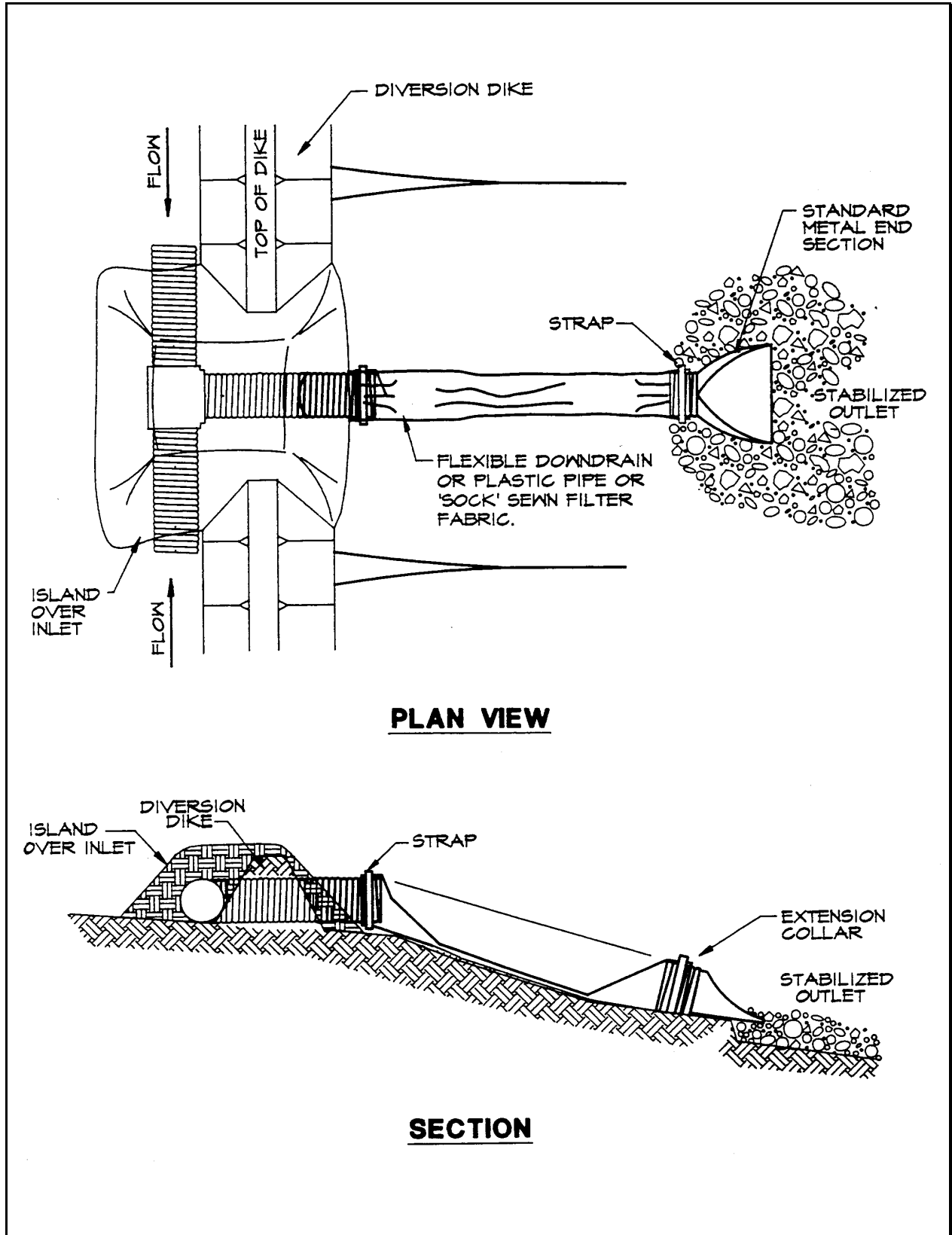

Plate 4.30b Slope Drain
Source: Erosion Draw

When used in conjunction with diversion dikes, temporary slope drains can be used to convey stormwater from the entire drainage area above a slope to the base of the slope without erosion. It is very important that these temporary structures be installed properly since their failure will often result in severe gully erosion. The entrance section must be securely entrenched, all connections must be watertight, and the conduit must be staked securely.

Design Criteria

Drainage Area

The maximum allowable drainage area per drain is 5 acres (2 ha).

Flexible Conduit

1. The slope drain shall consist of heavy duty flexible material designed for this purpose. The diameter of the slope drain shall be equal over its entire length. Reinforced hold-down grommets shall be spaced at 10 foot (3 m) maximum intervals.
2. Slope drains shall be sized according to the following table:

Table 4.30a
SIZE OF SLOPE DRAIN

<u>Maximum Drainage Area (Acres)</u>	<u>Pipe Diameter (in.)</u>
0.5	12
1.5	18
2.5	21
3.5	24
5.0	30

Overside drain

For small flows and/or short slopes, an open top chute may be used in place of a pipe. (See Plate 4.30c).

Entrance Sections

The entrance to the slope drain shall consist of a Standard FDOT "Flared End-Section for Metal Pipe Culverts." Extension collars shall consist of 12 inch (30 cm) long corrugated metal pipe. Watertight fittings shall be provided. (See Plates 4.30d & 4.30e).

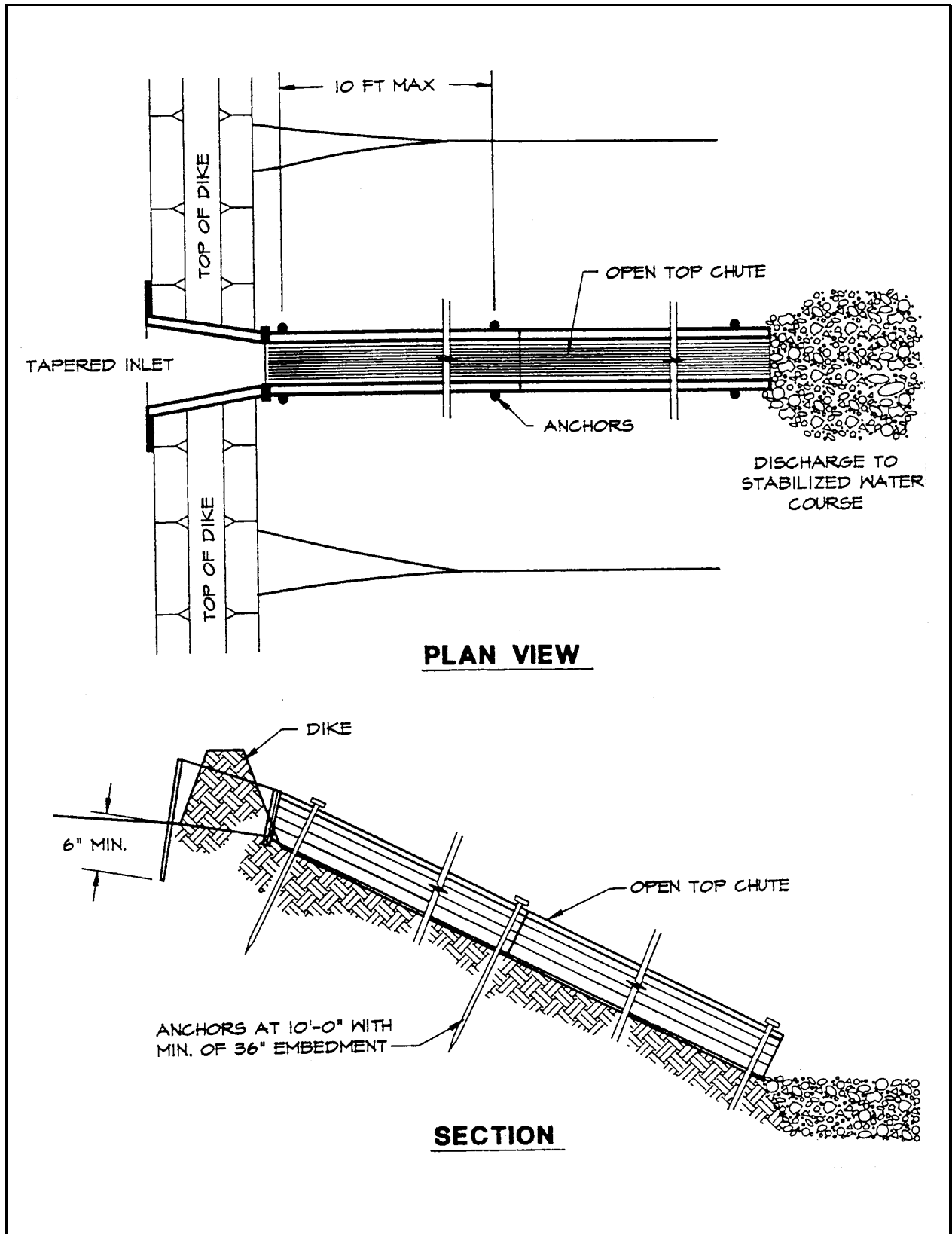

Plate 4.30c Overside Drain
Source: Erosion Draw

Dike Design

1. An earthen dike shall be used to direct stormwater runoff into the temporary slope drain and shall be constructed according to the practice entitled DIVERSION - Section 5.18 (ES BMP 1.18). (See Plate 4.30a)
2. The height of the dike at the centerline of the inlet shall be equal to the diameter of the pipe (D) plus 6 inches (15 cm). Where the dike height is greater than 18 inches (45 cm) at the inlet, it shall be sloped at the rate of 3:1 or flatter to connect with the remainder of the dike. (See Plate 4.30a)

Outlet Protection

The outlet of the slope drain shall be protected from erosion according to the practice entitled OUTLET PROTECTION - Section 5.36 (ES BMP 1.36). (See Plate 4.30b).

Construction Specifications

1. The measure shall be placed on undisturbed soil or well-compacted fill.
2. The entrance section shall slope toward the slope drain at the minimum rate of ½inch per foot (4 cm/m).
3. The soil around and under the entrance section shall be hand-tamped in 8 inch (20 cm) lifts to the top of the dike to prevent piping failure around the inlet.
4. The slope drain shall be securely staked to the slope at the grommets provided.
5. The slope drain sections shall be securely fastened together and have watertight fittings.

Maintenance

The slope drain structure shall be inspected weekly and after every storm, and shall have repairs made if necessary. The contractor should avoid the placement of any material on and prevent construction traffic across the slope drain.

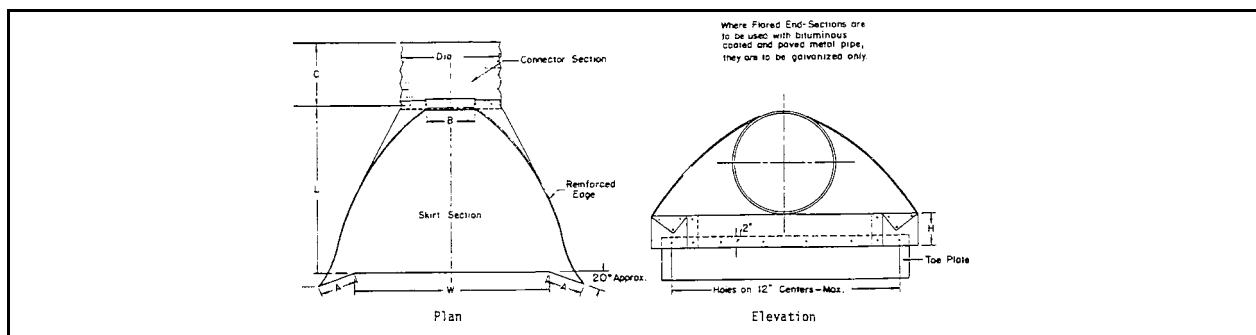
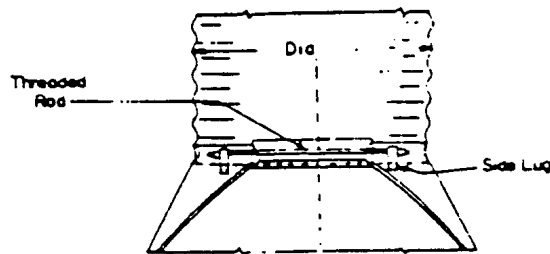

Plate 4.30d Flared End Section Schematic

Source: VDH&T Road Designs and Standards

Alternate Connection



Toe plate, where needed, to be punched to match holes in skirt lip. 3/8" galv. bolts to be furnished. Length of toe plate is W + 10" for 12" to 30" dia. pipe and W + 22" for 36" to 60" dia. pipe.

Skirt Section for 12" to 30" dia. pipe to be made in one piece.

Skirt Section for 36" to 54" dia. pipe may be made from two sheets joined by riveting or bolting on center line, 60" may be constructed in 3 pieces.

Connector Section, Corner Plate and Toe Plate to be same sheet thickness as skirt.

End-sections and fittings are to be galvanized steel or aluminum alloy for use with like pipe.

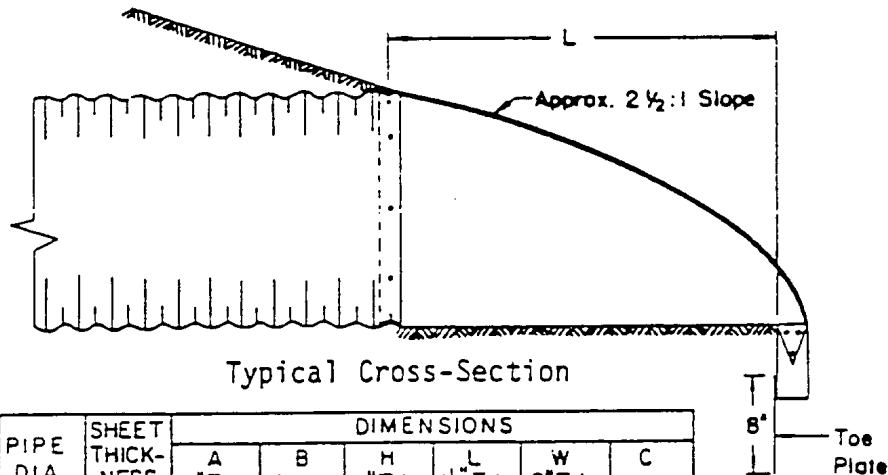

Typical Cross-Section

PIPE DIA	SHEET THICKNESS	DIMENSIONS					
		A 1" Tol	B Max	H 1" Tol	L 1/2" Tol	W 2" Tol	C
12"	.064"	6"	6"	6"	21"	24"	24"
15"	.064"	7"	8"	6"	26"	30"	24"
18"	.064"	8"	10"	6"	31"	36"	24"
24"	.064"	10"	13"	6"	41"	48"	24"
30"	.079"	12"	16"	8"	51"	60"	24"
36"	.079"	14"	19"	9"	60"	72"	36"
42"	.109"	16"	22"	11"	69"	84"	36"
48"	.109"	18"	27"	12"	78"	90"	24"
54"	.109"	18"	30"	12"	84"	102"	36"
60"	.109"	18"	33"	12"	87"	114"	36"

FLARED END-SECTION
(Continued)

Plate 4.30e Flared End Section Specifications

Source: VDH&T Road Designs and Standards

4.38 TEMPORARY CHECK DAMS

Definition

Small temporary dams constructed across a swale or stormwater conveyance channel.

Purpose

To reduce the velocity of concentrated stormwater flows, thereby reducing erosion of the swale or ditch. This practice also traps small amounts of sediment generated in the ditch itself. These sediments will require periodic removal. However, this is not a sediment trapping practice and should not be used as such.

Conditions Where Practice Applies

This practice is limited to use in small open channels which drain 10 acres (4 ha) or less. It should not be used in a live stream. This practice is especially applicable to sloping sites where the gradient of waterways is close to the maximum for a grass lining. Some specific applications include:

1. Temporary ditches or swales which, because of their short length of service, cannot receive a non-erodible lining but still need some protection to reduce erosion.
2. Permanent ditches or swales which for some reason cannot receive a permanent non-erodible lining for an extended period of time.
3. Either temporary or permanent ditches or swales which need protection during the establishment of grass linings.

Planning Considerations

Temporary check dams can be constructed of filter fence or straw bales for very short term applications; or either stone or logs for longer or permanent applications. Filter fence and straw bale check dams are economical to purchase and simple to install. Log check dams are economical as for material costs, since logs can usually be salvaged from clearing operations. However, log check dams require more time and hand labor to install. Stone for check dams, on the other hand, must generally be purchased. However, this cost is offset somewhat by the ease of installation.

Specifications

No formal design is required for a check dam; however, the following criteria should be adhered to when specifying check dams.

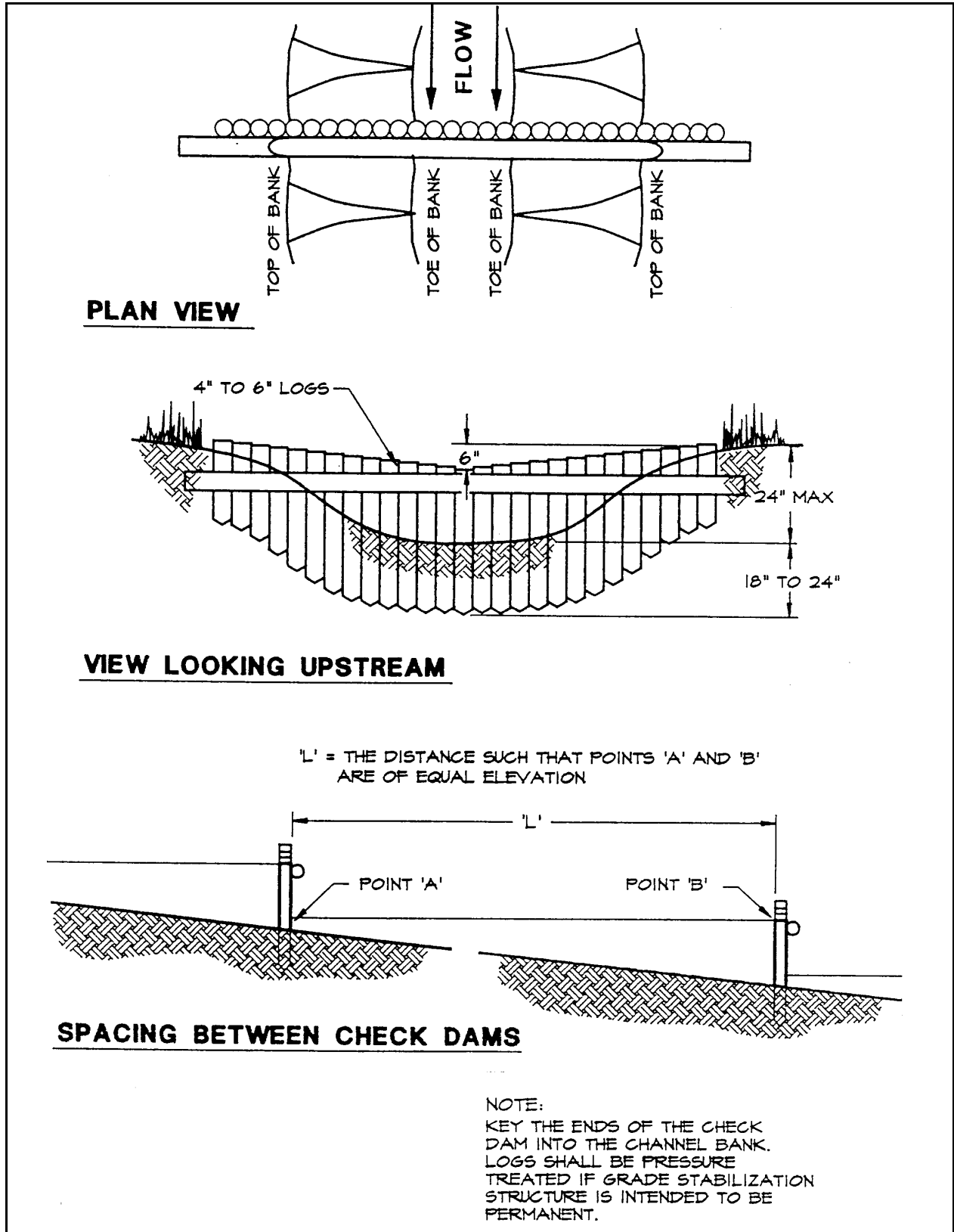

Plate 4.38a Log Check Dam
 Source: Erosion Draw

The drainage area of the ditch or swale being protected should not exceed 10 acres (4 ha). The maximum height of the check dam should be 2 feet (60 cm). The center of the check dam must be at least 6 inches (15 cm) lower than the outer edges. (See Plate 4.38a) The cross-sections of the dams should be as shown in Plates 4.38a through 4.38d, respectively, for logs, stone, straw bales, and filter fence. The maximum spacing between the dams should be such that the toe of the upstream dam is at the same elevation as the top of the downstream dam. (See Plate 4.38c).

Log check dams should be constructed of 4 to 6 inch (10 to 15 cm) logs salvaged from clearing operation site, if possible. The logs should be embedded into the soil at least 18 inches (45 cm). The 6 inch (15 cm) lower height required at the center can be achieved either by careful placement of the logs or by cutting the logs after they are in place. (See Plate 4.38a). Logs and/or brush should be placed on the downstream side of the dam to prevent scour during high flows.

Stone check dams should be constructed of FDOT No. 1 Coarse Aggregate (1.5 to 3.5 inch stone) (4 to 9 cm). The stone should be placed according to the configuration in Plate 4.38b. Hand or mechanical placement will be necessary to achieve complete coverage of the ditch or swale and to insure that the center of the dam is lower than the ends. (See Plates 4.38b & 4.38e)

Straw bale and filter fence check dams shall be installed as per STRAW BALE BARRIER - Section 4.05 (Channel Flow Applications) (See Plates 4.38c & 4.38f) and SILT FENCE - Section 4.06 (Channel Flow Applications) (See Plate 4.38d).

Sediment Removal

While this practice is not intended to be used primarily for sediment trapping, some sediment will accumulate behind the check dams. Sediment should be removed from behind the check dams when it has accumulated to half of the original height of the dam.

Removal

Check dams must be removed when their useful life has been completed. In temporary ditches and swales, check dams should be removed and the ditch filled in when it is no longer needed. In permanent structures, check dams should be removed when a permanent lining can be installed. In grass-lined ditches, check dams should be removed when the grass has matured sufficiently to protect the ditch or swale. The area beneath the check dams should be seeded and mulched or sodded (depending upon velocity) immediately after they are removed.

If stone check dams are used in grass-lined channels which will be mowed, care should be taken to remove all the stone from the dam when the dam is removed. This should include any stone which has washed downstream. Since log check dams are embedded in the soil, their removal will result in more disturbance of the soil than will removal of stone check dams. Consequently, extra care should be taken to restabilize the area when log dams are used in permanent ditches or swales.

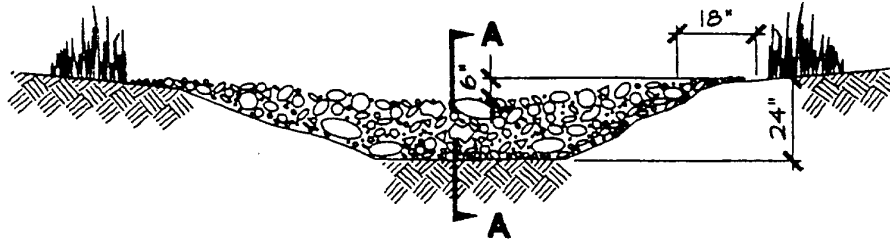

VIEW LOOKING UPSTREAM

NOTE:
KEY STONE INTO THE DITCH BANKS
AND EXTEND IT BEYOND THE ABUTMENTS
A MINIMUM OF 18" TO PREVENT OVER
FLOW AROUND DAM.

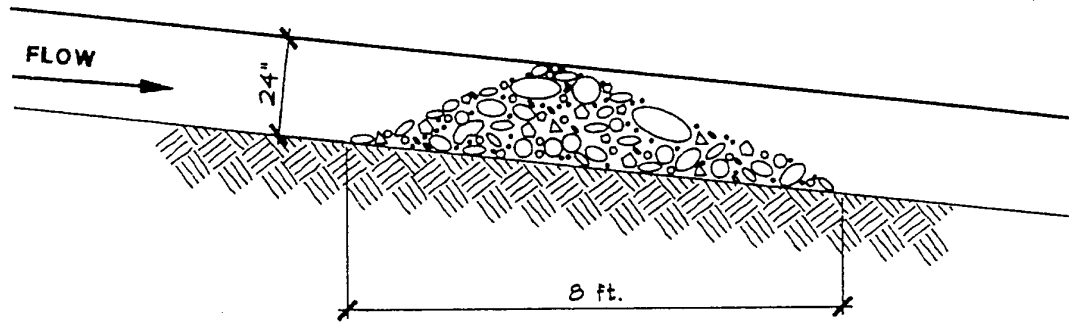

SECTION A - A

'L' = THE DISTANCE SUCH THAT POINTS 'A' AND
'B' ARE OF EQUAL ELEVATION.

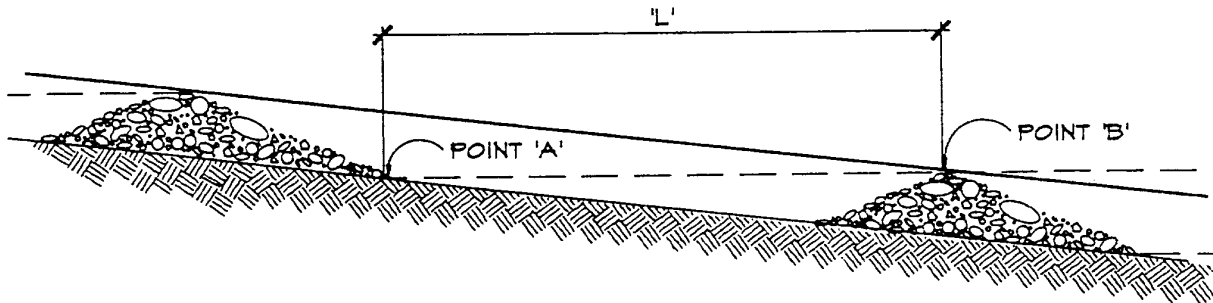

SPACING BETWEEN CHECK DAMS

Plate 4.38b Rock Check Dam
Source: Erosion Draw

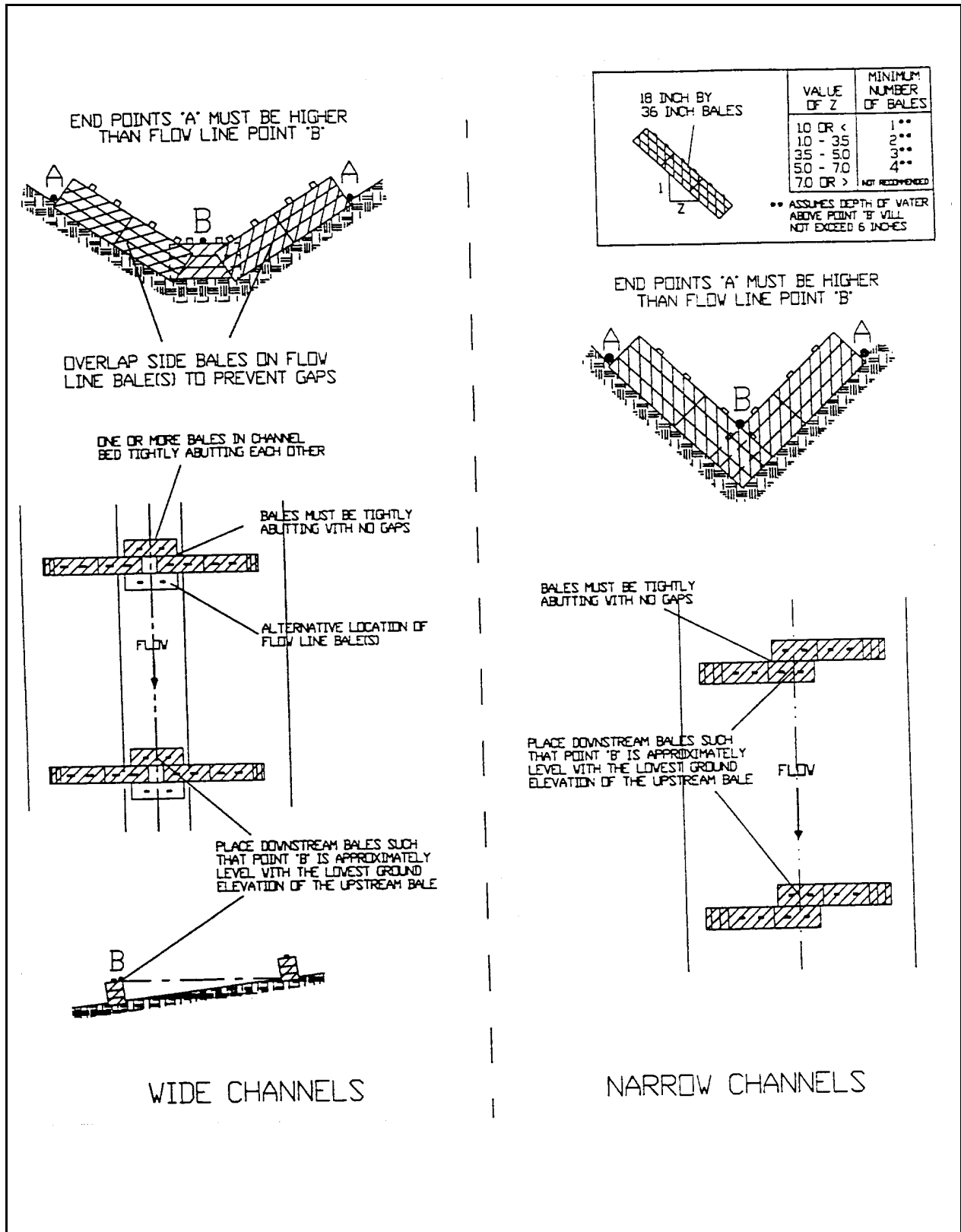

Plate 4.38c Straw Bale Check Dam
Source: HydroDynamics, Inc.

Maintenance

Check dams should be checked for sediment accumulation after each significant rainfall. Sediment should be removed when it reaches one-half of the original height or before. Regular inspections should be made to insure that the center of the dam is lower than the edges. Erosion caused by high flows around the edges of the dam should be corrected immediately.

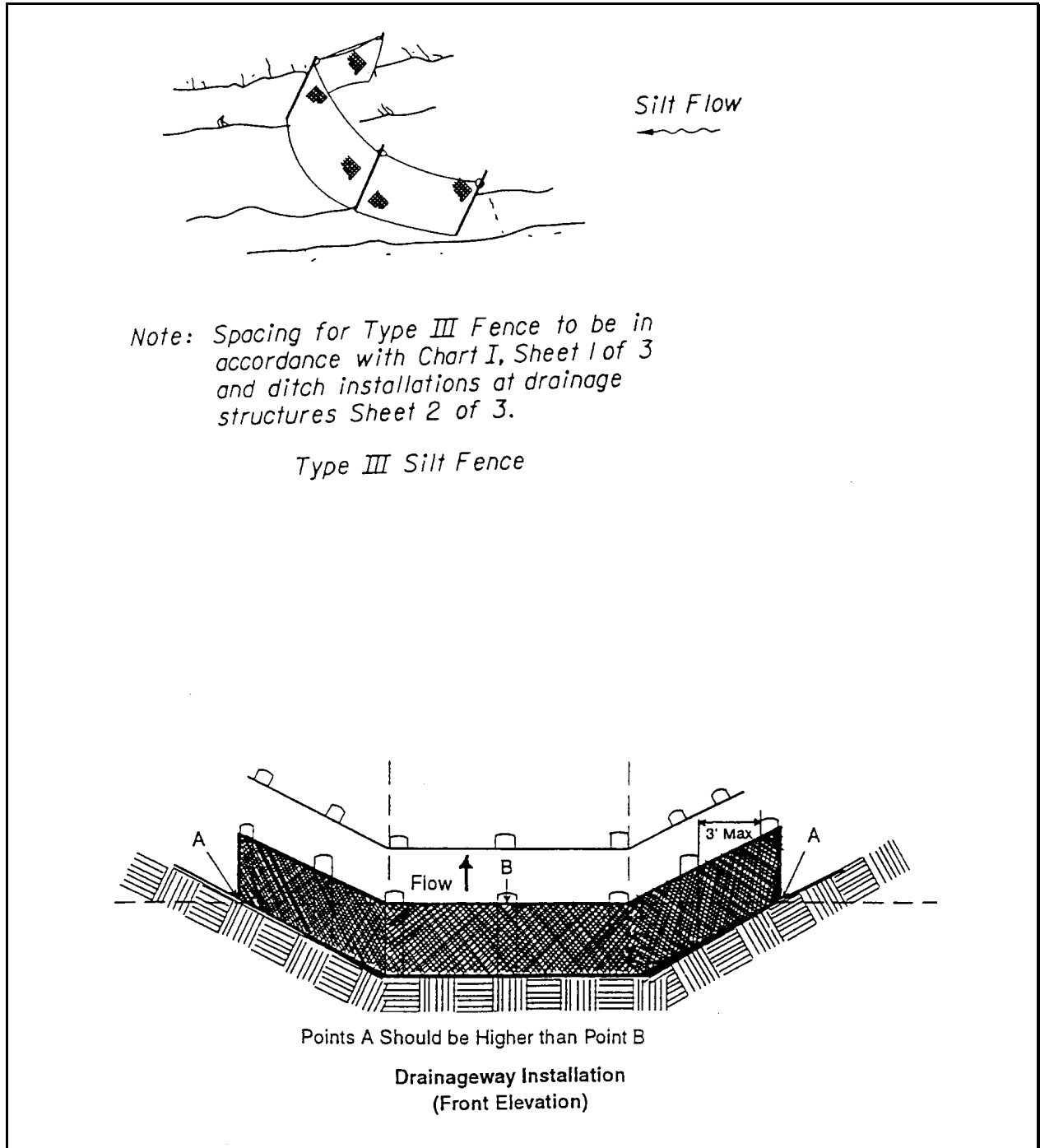
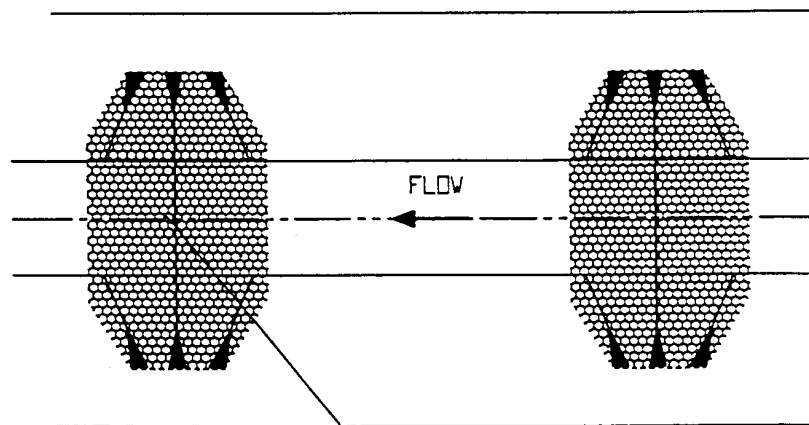
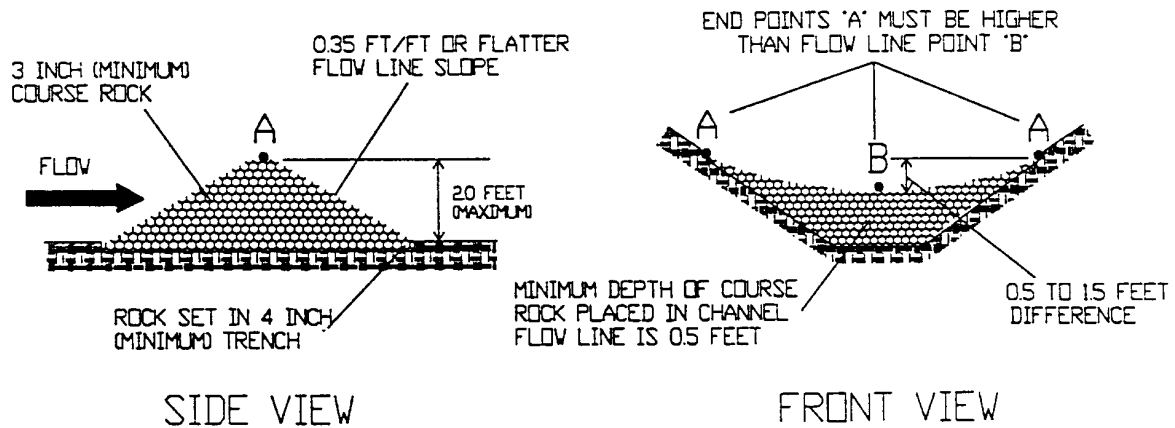

Plate 4.38d Silt Fence Check Dam

Source: Installation of Straw and Fabric Filter Barriers for Sediment Control Sherwood and Wyant

D-50 OF ROCK (INCHES)	DOWNSTREAM FLOWLINE SLOPE OF STRUCTURE (FT/FT)					
	0.35	0.30	0.25	0.20	0.15	0.10
3	0.6	0.7	0.8	1.0	1.3	1.9
6	1.2	1.4	1.6	2.0	2.6	3.9

RECOMMENDED ROCK SIZE & FLOW DEPTHS



PLACE DOWNSTREAM STRUCTURE SUCH THAT POINT 'B' IS APPROXIMATELY LEVEL WITH THE LOWEST GROUND ELEVATION OF THE UPSTREAM STRUCTURE

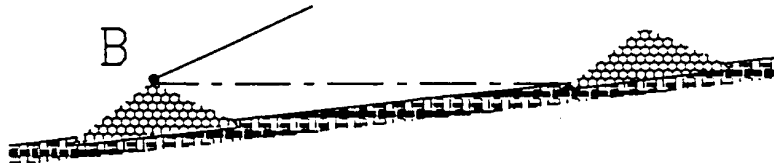

Plate 4.38e Rock Check Dam Details

Source: HydroDynamics, Inc.

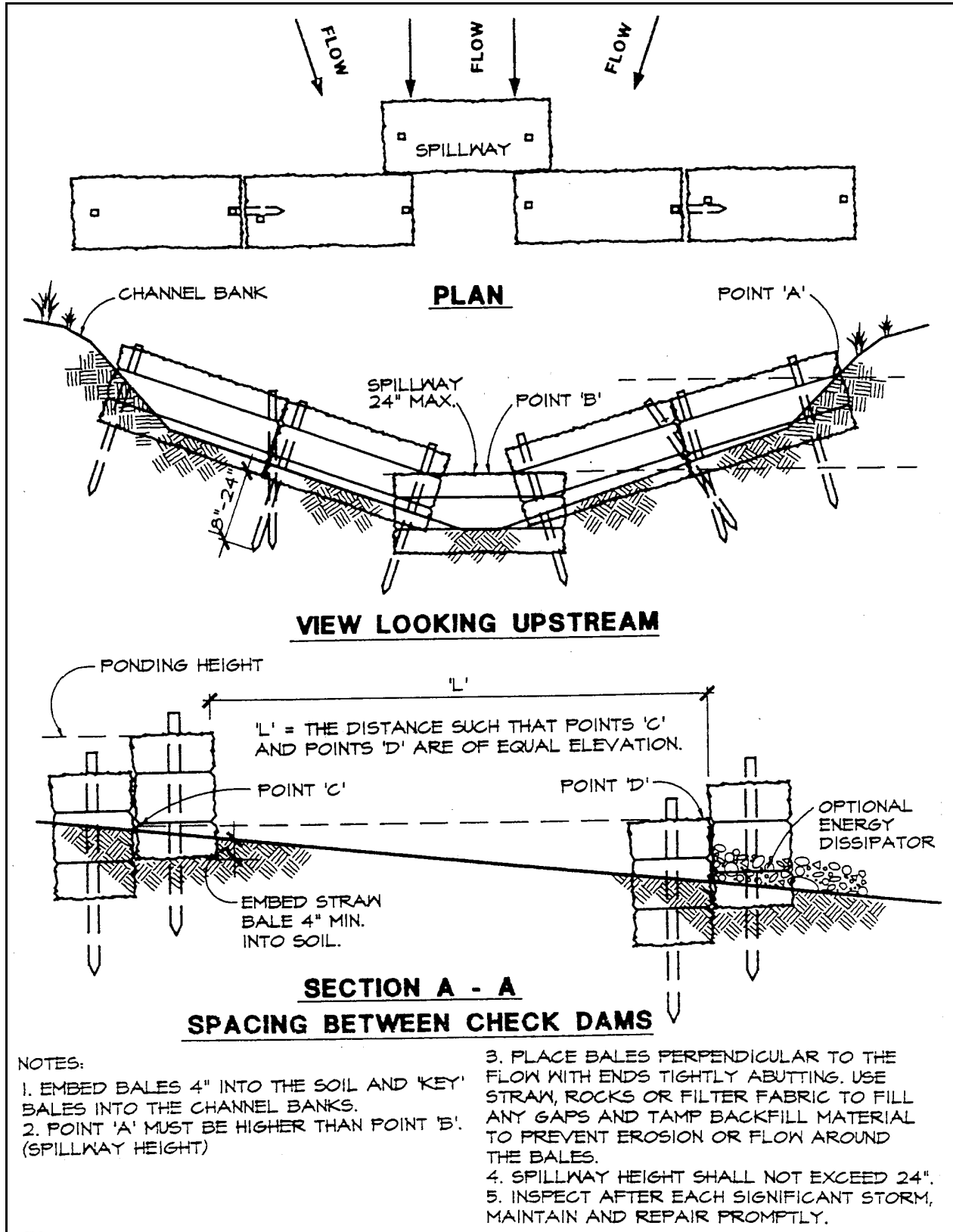

Plate 4.38f Straw Bale Check Dam Details

Source: Erosion Draw

4.40 DEWATERING

Definition

Lowering the water table by means of pumping.

Purpose

To allow the construction of structural and stormwater improvements by removing water from excavation areas and allowing construction by conventional "dry" methods.

Planning Considerations

The major planning consideration in dewatering is disposal of removed water. Volume, quality, and topography are the factors governing the method and destination of removed water. Discharge from well-point dewatering is relatively clear except for the initial discharge after installation or inactivity. Water pumped from a sump hole is thoroughly sediment laden and must always be treated. Turbid water must either be filtered before leaving the site or must be impounded onsite and allowed to settle. In flat terrain it is sometimes more economical to impound relatively clean water rather than pipe it long distances to a receiving water body.

Specifications

The two most common methods of dewatering used in Florida are well-point systems and sump pumps. A well-point system consists of one or more rows of small 2" (5 cm) collector pipes which are jetted vertically into the ground near the proposed excavation. The small pipes are connected by a larger 6" (15 cm) manifold pipe which is connected to the pump and discharge line. The sump method is simply a hole in the ground with a pump drawing all of the water flowing into the hole. Excess water is conveyed to the sump by open ditches or perforated pipes embedded in sand or gravel.

Sumps and Ditches

The water table is lowered by ditching and conveying water to a lowered sump hole. Water pumped from a sump hole is usually heavily laden with sediments. Water flowing over disturbed and saturated ground detaches and transports all sizes of soil particles into the sump pit to be sucked up by the pump. Saturated liquid soil (mud) is also drawn into the pump. The discharged water must be treated before release into a receiving water body or stormwater system. Placing haybales around the pump intake or outlet is not sufficient filtration by itself. Turbid water must either be impounded long enough for effective settling of fines, or filtered through a temporary filter or sediment tank. Initially the water may percolate freely into the ground, however this will diminish as the fine particles settle and clog the surface layer of soil. In situations which preclude the use of filtration or settlement facilities, and turbid water is discharged directly into a water body, a suitably designed floating turbidity barrier must be used. Note that this method does not remove any sediments, it merely allows for dilution to lower the turbidity level.

Horizontal Wells

This system also consists of a series of ditches leading to a sump hole or pump. The ditches are filled with sand or gravel surrounding a perforated pipe. A geotextile may also be used to prevent excessive migration of fines into the system. The discharged water must be treated before release as described above.

Well-point Systems

The well-point system is the preferred system for dewatering and should be used whenever possible. The initial discharge yields the sediments displaced by the installation of the small collector pipes. This can be directed into the excavation, a small settling or filtration facility, or larger temporary impoundment. Thereafter the water is generally clear ground water and may be discharged into a receiving water body provided that there is suitable conveyance.

Maintenance

1. Any water impoundment must be inspected daily to prevent failure of dikes, berms, or control structures. Minor problems should be repaired at once. Major problems will require a redesign and plan modification.
2. Any filtration device must be inspected and cleaned frequently. The discharge should be monitored daily and whenever the pumps are started. Inspection and maintenance of the system are best performed when the facility is dry. The first signs of diminished performance should be an alarm that maintenance is required. If the facility will no longer drain itself, the untreated water must be pumped back to its source, rather than by-passing the facility and discharging to the water body or stormwater system.
3. Floating turbidity barriers shall be maintained as per FLOATING TURBIDITY BARRIER - Section 4.45

4.45 FLOATING TURBIDITY BARRIER

Definition

A floating geotextile material which minimizes sediment transport from a disturbed area adjacent to or within a body of water.

Purpose

To provide sedimentation protection for a watercourse from up-slope land disturbance where conventional erosion and sediment controls cannot be used, or from dredging or filling within the watercourse.

Conditions Where Practice Applies

Applicable to non-tidal and tidal watercourses where intrusion into the watercourse by construction activities has been permitted and subsequent sediment movement is unavoidable.

Planning Considerations

Soil loss into a watercourse results in long-term suspension of sediment. In time, the suspended sediment may travel large distances and affect widespread areas. A turbidity curtain is designed to deflect and contain sediment within a limited area and provide enough residence time so that soil particles will fall out of suspension and not travel to other areas.

Turbidity curtain types must be selected based on the flow conditions within the water body, whether it be a flowing channel, lake, pond, or a tidal watercourse. The specifications contained within this practice pertain to minimal and moderate flow conditions where the velocity of flow may reach 5 feet (1.5 m) per second (or a current of approximately 3 knots). For situations where there are greater flow velocities or currents, a qualified engineer and product manufacturer should be consulted.

Consideration must also be given to the direction of water movement in channel flow situations. Turbidity curtains are not designed to act as water impoundment dams and cannot be expected to stop the flow of a significant volume of water. They are designed and installed to trap sediment, not to halt the movement of water itself. In most situations, turbidity curtains should not be installed across channel flows.

In tidal or moving water conditions, provisions must be made to allow the volume of water contained within the curtain to change. Since the bottom of the curtain is weighted and external anchors are frequently added, the volume of water contained within the curtain will be much greater at high tide versus low tide and measures must be taken to prevent the curtain from submerging. In addition to allowing slack in the curtain to rise and fall, water must be allowed to flow through the curtain if the curtain is to remain in roughly the same place and maintain the same shape. Normally, this is achieved by constructing part of the curtain from a heavy woven filter fabric. The fabric allows the water to pass through the

curtain, but retains the sediment particles. Consideration should be given to the volume of water that must pass through the fabric and sediment particle size when specifying fabric permeability.

Sediment which has been deflected and settled out by the curtain may be removed if so directed by the on-site inspector or the permitting agency. However, consideration must be given to the probable outcome of the procedure - will it create more of a sediment problem by resuspension of particles and by accidental dumping of the material by the equipment involved? It is, therefore, recommended that the soil particles trapped by a turbidity curtain only be removed if there has been a significant change in the original contours of the effected area in the watercourse. Regardless of the decision made, soil particles should always be allowed to settle for a minimum of 6-12 hours before their removal by equipment or before removal of a turbidity curtain.

It is imperative that the intended function of the other controls in this chapter, to keep sediment out of the watercourse, be the strategy used in every erosion control plan. However, when proximity to the watercourse makes successfully mitigating sediment loss impossible, the use of the turbidity curtain during land disturbance is essential. ***Under no circumstances shall permitted land disturbing activities create violations of water quality standards!***

Design Criteria

1. Type I configuration (see Plate 4.45a) should be used in protected areas where there is no current and the area is sheltered from wind and waves.
2. Type II configuration (see Plate 4.45a) should be used in areas where there may be small to moderate current running (up to 2 knots or 3.5 feet (1 m) per second) and/or wind and wave action can affect the curtain.
3. Type III configuration (see Plate 4.45b) should be used in areas where considerable current (up to 3 knots or 5 feet (1.5 m) per second) may be present, where tidal action may be present, and/or where the curtain is potentially subject to wind and wave action.
4. Turbidity curtains should extend the entire depth of the watercourse whenever the watercourse in question is not subject to tidal action and/or significant wind and wave forces. This prevents silt laden water from escaping under the barrier, scouring and resuspending additional sediments.
5. In tidal and/or wind and wave action situations, the curtain should never be so long as to touch the bottom. A minimum 1 foot (30 cm) "gap" should exist between the weighted lower end of the skirt and the bottom at "mean" low water. Movement of the lower skirt over the bottom due to tidal reverses or wind and wave action on the flotation system may fan and stir sediments already settled out.
6. In tidal and/or wind and wave action situations, it is seldom practical to extend a turbidity curtain depth lower than 10 to 12 feet (3 to 4 m) below the surface, even in deep water. Curtains which are installed deeper than this will be subject to very large loads with consequent strain on curtain materials and the mooring system.

In addition, a curtain installed in such a manner can "billow up" toward the surface under the pressure of the moving water, which will result in an effective depth which is significantly less than the skirt depth.

7. Turbidity curtains should be located parallel to the direction of flow of a moving body of water. Turbidity curtains should not be placed across the main flow of a significant body of moving water.
8. When sizing the length of the floating curtain, allow an additional 10 - 20% variance in the straight line measurements. This will allow for measuring errors, make installing easier and reduce stress from potential wave action during high winds.
9. An attempt should be made to avoid an excessive number of joints in the curtain; a minimum continuous span of 50 feet (15 m) between joints is a good "rule of thumb."
10. For stability reasons, a maximum span of 100 feet (30 m) between anchor or stake locations is also a good rule to follow.
11. The ends of the curtain, both floating upper and weighted lower, should extend well up into the shoreline, especially if high water conditions are expected. The ends should be secured firmly to the shoreline to fully enclose the area where sediment may enter the water.
12. When there is a specific need to extend the curtain to the bottom of the watercourse in tidal or moving water conditions, a heavy woven pervious filter fabric may be substituted for the normally recommended impervious geotextile. This creates a "flow-through" medium which significantly reduces the pressure on the curtain and will help to keep it in the same relative location and shape during the rise and fall of tidal waters.
13. Typical alignments of turbidity curtains can be seen in Plate 4.45c. The number and spacing of external anchors may vary depending on current velocities and potential wind and wave action; manufacturer's recommendations should be followed.
14. Be certain that the type, location, and installation of the barrier is as shown on the approved plan and permit. Additional permits may be required in navigable waterways, especially when the barrier creates an obstruction.

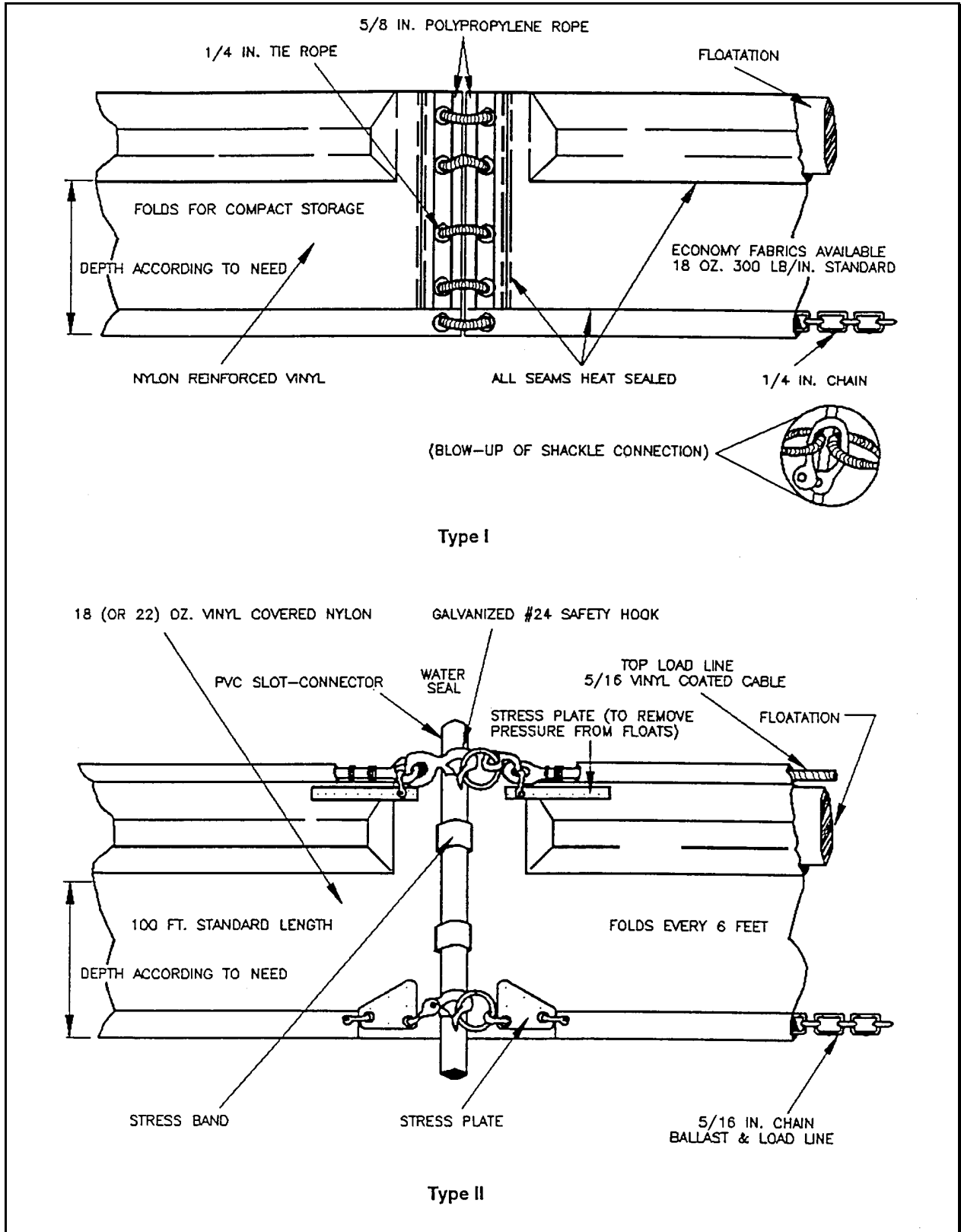

Plate 4.45a Type I and II Floating Turbidity Barriers
 Source: American Boom and Barrier Corporation

Construction Specifications

Materials

1. Barriers should be a bright color (yellow or "international" orange are recommended) that will attract the attention of nearby boaters.
2. The curtain fabric must meet the minimum requirements noted in Table 3.27-A.
3. Seams in the fabric shall be either vulcanized welded or sewn, and shall develop the full strength of the fabric.
4. Floatation devices shall be flexible, buoyant units contained in an individual floatation sleeve or collar attached to the curtain. Buoyancy provided by the floatation units shall be sufficient to support the weight of the curtain and maintain a freeboard of at least 3 inches (8 cm) above the water surface level. (See Plate 4.45c)
5. Load lines must be fabricated into the bottom of all floating turbidity curtains. Type II and Type III must have load lines also fabricated into the top of the fabric. The top load line shall consist of woven webbing or vinyl-sheathed steel cable and shall have a break strength in excess of 10,000 pounds (4.5 t). The supplemental (bottom) load-line shall consist of a chain incorporated into the bottom hem of the curtain of sufficient weight to serve as ballast to hold the curtain in a vertical position. Additional anchorage shall be provided as necessary. The load lines shall have suitable connecting devices which develop the full breaking strength for connecting to load lines in adjacent sections (See Plates 4.45a and 4.45b which portray this orientation).
6. External anchors may consist of 2 x 4 inch (5 x 10 cm) or 2-1/2 inch (6 cm) minimum diameter wooden stakes, or 1.33 pounds/linear foot (2 kg/m) steel posts when Type I installation is used; when Type II or Type III installations are used, bottom anchors should be used.
7. Bottom anchors must be sufficient to hold the curtain in the same position relative to the bottom of the watercourse without interfering with the action of the curtain. The anchor may dig into the bottom (grappling hook, plow or fluke-type) or may be weighted (mushroom type) and should be attached to a floating anchor buoy via an anchor line. The anchor line would then run from the buoy to the top load line of the curtain. When used with Type III installations, these lines must contain enough slack to allow the buoy and curtain to float freely with tidal changes without pulling the buoy or curtain down and must be checked regularly to make sure they do not become entangled with debris. As previously noted, anchor spacing will vary with current velocity and expected wind and wave action; manufacturer's recommendations should be followed. See orientation of external anchors and anchor buoys for tidal installation in Plate 4.45b.

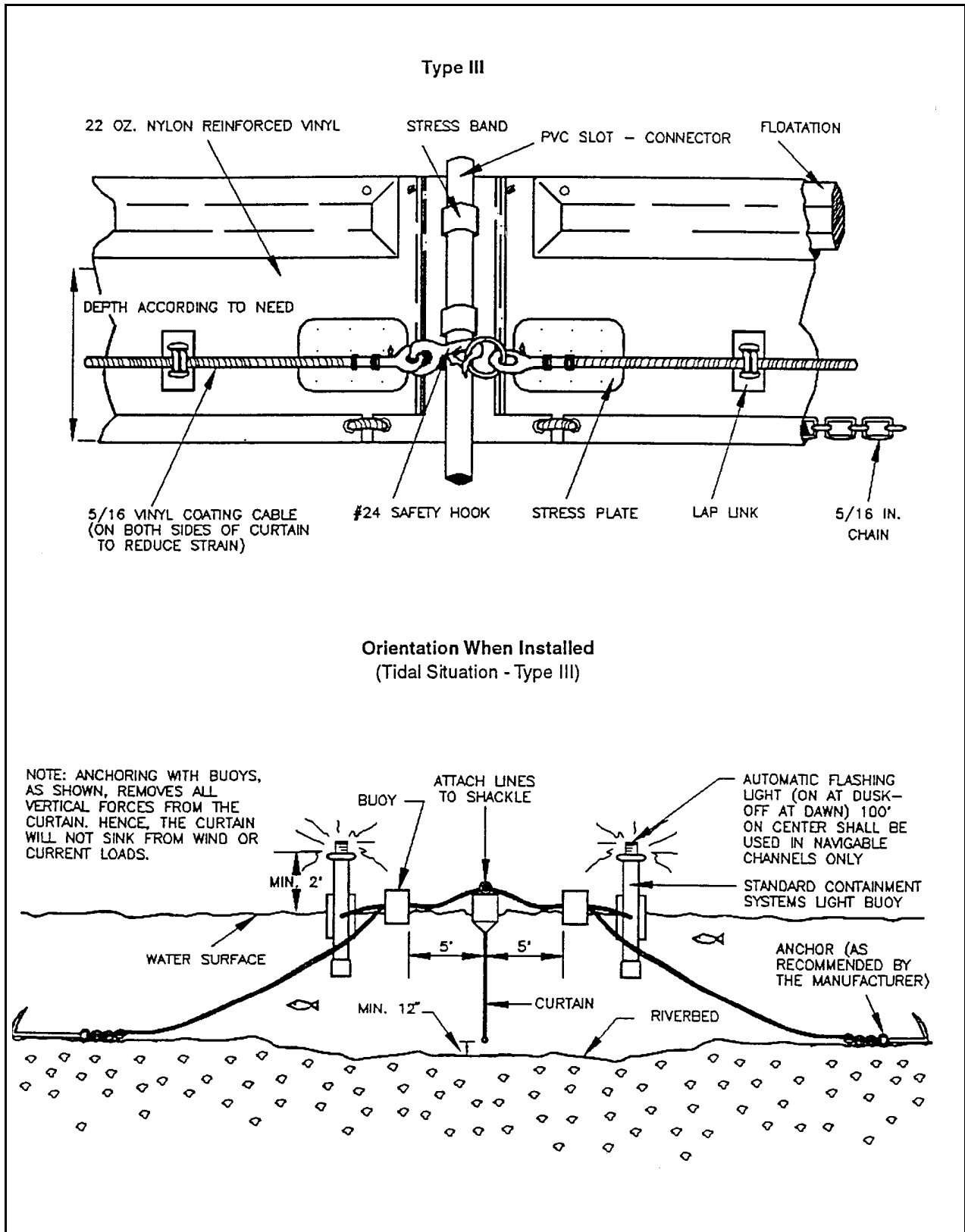

Plate 4.45b Type III Floating Turbidity Barrier

Source: American Boom and Barrier Corporation and VDOT Standard Sheets

Installation

1. In the calm water of lakes or ponds (Type I installation) it is usually sufficient to merely set the curtain end stakes or anchor points (using anchor buoys if bottom anchors are employed), then tow the curtain in the furled condition out and attach it to these stakes or anchor points. Following this, any additional stakes or buoyed anchors required to maintain the desired location of the curtain may be set and these anchor points made fast to the curtain. Only then, the furling lines should be cut to let the curtain skirt drop.

2. In rivers or in other moving water (Type II and Type III installations) it is important to set all the curtain anchor points. Care must be taken to ensure that anchor points are of sufficient holding power to retain the curtain under the expected current conditions, before putting the furled curtain into the water. Anchor buoys should be employed on all anchors to prevent the current from submerging the flotation at the anchor points. If the moving water into which the curtain is being installed is tidal and will subject the curtain to currents in both directions as the tide changes, it is important to provide anchors on both sides of the curtain for two reasons:
 - a) Curtain movement will be minimized during tidal current reversals.
 - b) The curtain will not overrun the anchors pull them out when the tide reverses.

When the anchors are secure, the furled curtain should be secured to the upstream anchor point and then sequentially attached to each next downstream anchor point until the entire curtain is in position. At this point, and before unfurling, the "lay" of the curtain should be assessed and any necessary adjustments made to the anchors. Finally, when the location is ascertained to be as desired, the furling lines should be cut to allow the skirt to drop.

3. Always attach anchor lines to the flotation device, not to the bottom of the curtain. The anchoring line attached to the floatation device on the downstream side will provide support for the curtain. Attaching the anchors to the bottom of the curtain could cause premature failure of the curtain due to the stresses imparted on the middle section of the curtain.

4. There is an exception to the rule that turbidity curtains should not be installed across channel flows; it occurs when there is a danger of creating a silt buildup in the middle of a watercourse, thereby blocking access or creating a sand bar. Curtains have been used effectively in large areas of moving water by forming a very long-sided, sharp "V" to deflect clean water around a work site, confine a large part of the silt-laden water to the work area inside the "V" and direct much of the silt toward the shoreline. Care must be taken, however, not to install the curtain perpendicular to the water current.

5. See Plate 4.45c for typical installation layouts.

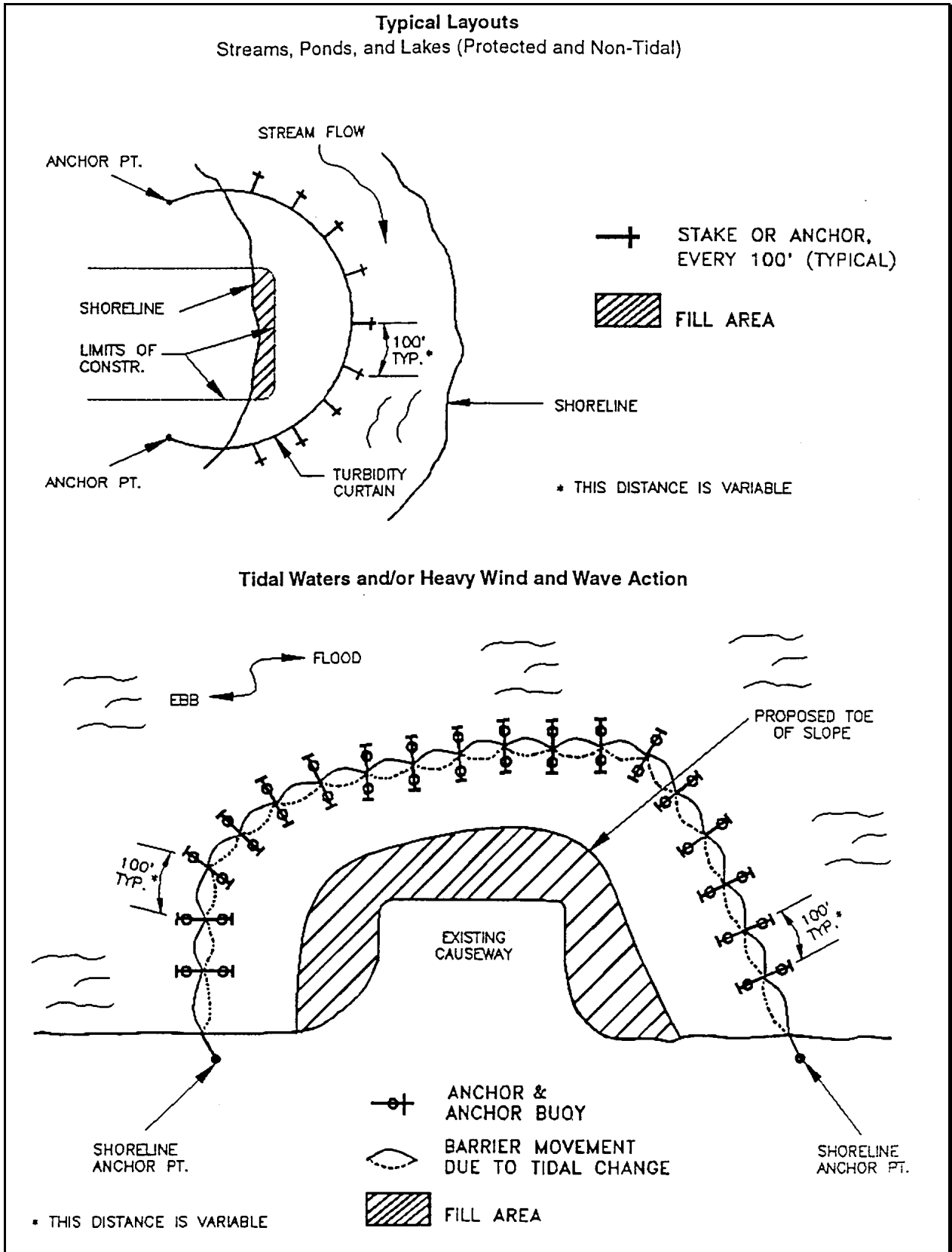

Plate 4.45c Typical Installation Layouts
Source: FDOT Roadway and Traffic Design Standards

6. The effectiveness of the barrier can be increased by installing two parallel curtains, separated at regular intervals by 10' (3 m) long wooden boards or lengths of pipe.

Removal

1. Care should be taken to protect the skirt from damage as the turbidity curtain is dragged from the water.
2. The site selected to bring the curtain ashore should be free of sharp rocks, broken cement, debris, etc. so as to minimize damage when hauling the curtain over the area.
3. If the curtain has a deep skirt, it can be further protected by running a small boat along its length with a crew installing furling lines before attempting to remove the curtain from the water.

Maintenance

1. The developer/owner shall be responsible for maintenance of the filter curtain for the duration of the project to ensure the continuous protection of the watercourse.
2. Should repairs to the geotextile fabric become necessary, there are normally repair kits available from the manufacturers; manufacturer's instructions must be followed to ensure the adequacy of the repair.
3. When the curtain is no longer required as determined by the inspector, the curtain and related components shall be removed in such a manner as to minimize turbidity. Sediment shall be removed and the original depth (or plan elevation) restored before removing the curtain. Remaining sediment shall be sufficiently settled before removing the curtain. Any spoils must be taken to an upland area and stabilized.

This page left intentionally blank

REFERENCES

Florida Department of Environmental Regulation, 1988, The Florida Development Manual: A Guide to Sound Land and Water Management (Chapter 6). Tallahassee, FL

CHAPTER 5

BEST MANAGEMENT PRACTICES FOR STORMWATER MANAGEMENT

STORMWATER INTRODUCTION	1
5.00 EARTHWORK SPECIFICATIONS	3
5.01 RETENTION BASINS	5
5.02 EXFILTRATION TRENCHES	11
5.03 POROUS PAVEMENT	23
5.04 CONCRETE GRID AND MODULAR PAVEMENT	25
5.05 DETENTION BASINS	27
5.06 UNDERDRAINS AND STORMWATER FILTER SYSTEMS	31
5.07 GRASSED WATERWAYS AND SWALES	41
5.08 STORMWATER CONVEYANCE CHANNEL	47
5.09 PAVED FLUME	51
5.10 DIVERSION	53
5.11 LEVEL SPREADER	57
5.12 CHECK DAMS	59
5.14 WATERWAY DROP STRUCTURE	63
5.15 OUTLET PROTECTION	67
5.16 RIPRAP	71
5.17 GRID CONFINEMENT SYSTEMS	75
5.18 CELLULAR CONCRETE BLOCK	79
5.19 MAINTENANCE	85

CHAPTER NOTE

Effective management of stormwater depends on the proper use of a number of specific best management practices (BMP's). Each of these has a correct application, installation, and maintenance requirement. This chapter provides a "toolbox" of BMP's with instructions for their use, including construction and maintenance. Design shall use accepted engineering methods, such as those established by FDEP, FDOT, NRCS, IECA, ASCE, U.S. Army Corps of Engineers, or other recognized organization.

INTRODUCTION

Best Management Practices (BMPs) are control practices which are used for a given set of conditions to achieve satisfactory water quality and quantity enhancement at a minimal cost. Chapter 6 of the Florida Development Manual contains an extensive discussion of the use, design, construction, and operation of a wide variety of stormwater management and erosion and sediment control BMPs.

Structural versus Nonstructural - Best Management Practices can be classified into two broad categories: structural and nonstructural. Nonstructural controls are those which are intended to improve stormwater quality by reducing the generation and accumulation of potential stormwater pollutants at or near their sources. They are therefore frequently referred to as source controls. Nonstructural controls are the first line of defense and include practices such as planning and management, wetlands and floodplain protection, public education, proper fertilizer and pesticide application control, solid waste collection and disposal, street cleaning, and "good housekeeping" techniques on construction sites. They are prevention oriented and very cost-effective.

Structural controls are those which are used to control the stormwater volume and peak discharge rate, as well as reducing the magnitude of pollutants in the discharge waters through physical containment or flow restrictions designed to allow settling, filtration, percolation, chemical treatment, or biological uptake. These practices typically are land intensive, require proper long term maintenance, and can be costly, especially in already urbanized areas.

The BMP Treatment Train - A stormwater management system might be considered as a BMP Treatment Train in which the individual BMPs are the cars. Generally, the more BMPs that are incorporated into the system, the better the performance of the treatment train. Although the different BMPs will be discussed individually, they often work together as part of a total system. Many BMPs are highly susceptible to clogging, especially those which use filtration. Treatment swales, sediment forebays, and stilling basins intercept sediments before they reach filtration BMPs, making sediment removal easier and less costly.

On-Line versus Off-Line - On-line BMPs temporarily store runoff before they discharge to surface waters. These systems capture all of the runoff from a design storm. They primarily provide flood control benefits, with water quality benefits secondary. However, some on-line BMPs, such as wet detention systems, can do an excellent job of achieving both objectives.

Off-line BMPs divert the first flush of polluted stormwater (often called "treatment volume") and isolate it from the remaining stormwater, which is managed for flood control. Off-line retention is the most effective water quality protection BMP, since the diverted first flush is not discharged to surface waters. It is removed by infiltration, evaporation, and evapotranspiration.

This page left intentionally blank

5.00 EARTHWORK SPECIFICATIONS

Definition

Specifications for earthwork maximize the utilization of the desirable physical properties of soil and take measures to compensate for weaknesses.

Purpose

To ensure that inadequate earthwork does not cause premature failure of constructed improvements.

Condition Where Practice Applies

This practice applies on all construction sites.

Specifications

Subgrade Preparation

Proper subgrade preparation involves the clearing and grubbing of land. Except for muck soils, the subgrade should be free of organic debris, demolition debris, and large stones and rocks. If no fill is required, the ground should then be smoothed and compacted. If the area requires fill, the surface should be scarified or roughened to facilitate a bond between the original soil and the fill. Do not place fill on a smooth compacted soil.

Filling, Backfilling, and Compaction

All fill material must be properly compacted. Large fill areas, such as embankments, dams, and building pads, can be mechanically compacted with heavy equipment in 6"- 8" (15 - 20 cm) lifts of compacted soil. Smaller above ground fills, such as berms, can be compacted with heavy and medium equipment, or with hand tampers. Backfilling around pipes and manholes is the most sensitive operation, particularly around the bottom half of a pipe. Here fill should be placed in 2"- 4" (5 - 10 cm) lifts and great care must be exercised to avoid damage to pipes, especially bituminous coated pipe. Small rollers or tampers are commonly used.

Compaction of fill can also be accomplished using time and/or water. Where time is not a pressing factor fill can simply be dumped in place and allowed to settle over a period of several months. The primary force causing settlement is rain. The process can be shortened to several days by constant inundation with a sprinkler. This technique is commonly used by homebuilders for compacting fill inside of a stem-wall foundation. It could also be used to backfill under pipes. These techniques work best in very sandy soils. Regardless of the method used to achieve compaction, a compaction test should be performed before permanent structures are constructed on top of fill material.

This page left intentionally blank

5.01 STORMWATER RETENTION BASINS **(SW BMP 3.07)**

Definition

A surface area used to store runoff for a selected design storm or specified treatment volume. Stormwater is retained on site, with the storage volume recovered when the runoff percolates into the soil or evapotranspires.

Purpose

To reduce stormwater volume, peak discharge rate, and pollutants; and to recharge ground water and base flow. (See Plate 5.01a)

Conditions Where Practice Applies

Applicability of this practice is primarily dependent upon the ability of the soils to percolate runoff, and the availability of adequate land area for a retention area or for modifications of an existing system. Geologic, topographic, and soils conditions must be considered in determining site suitability. Besides soil infiltration rates, the single most significant limiting factor in many cases is the availability of sufficient land area to provide the necessary storage volume. This is particularly true in densely urbanized areas where land is scarce and property values are high.

The soil and water table conditions must also be such that the system can, in a maximum of 72 hours following a stormwater event, provide for a new volume of storage through percolation and/or evapotranspiration. When retention systems are vegetated as recommended, the runoff needs to percolate within 24 - 36 hours to assure viability of the vegetation. Retention systems do not release stored waters for surface discharge.

Construction Specifications

Initial basin excavation should be carried to within 1 ft. (0.3m) of the final elevation of the basin floor. Interior sideslopes should be sodded immediately to prevent erosion and the introduction of additional sediments. Final excavation shall be deferred until all contributing areas of the watershed have been stabilized. Light equipment should be used to remove accumulated sediments and achieve final grade without compacting the basin floor. After final grading, the basin floor should be scarified with rotary tillers or disc harrows to promote infiltration and grass establishment.

Structural elements, such as embankments, inlets, flumes, and emergency spillways, shall be designed by a Florida registered professional engineer. These elements shall be constructed in accordance with EARTHWORK SPECIFICATIONS - Section 5.00 and other acceptable engineering standards.

Do not allow sediment laden runoff to enter a finished basin. Do not overexcavate in order to provide additional sediment capacity unless the intent is to remove all sediments and backfill with a more pervious soil type.

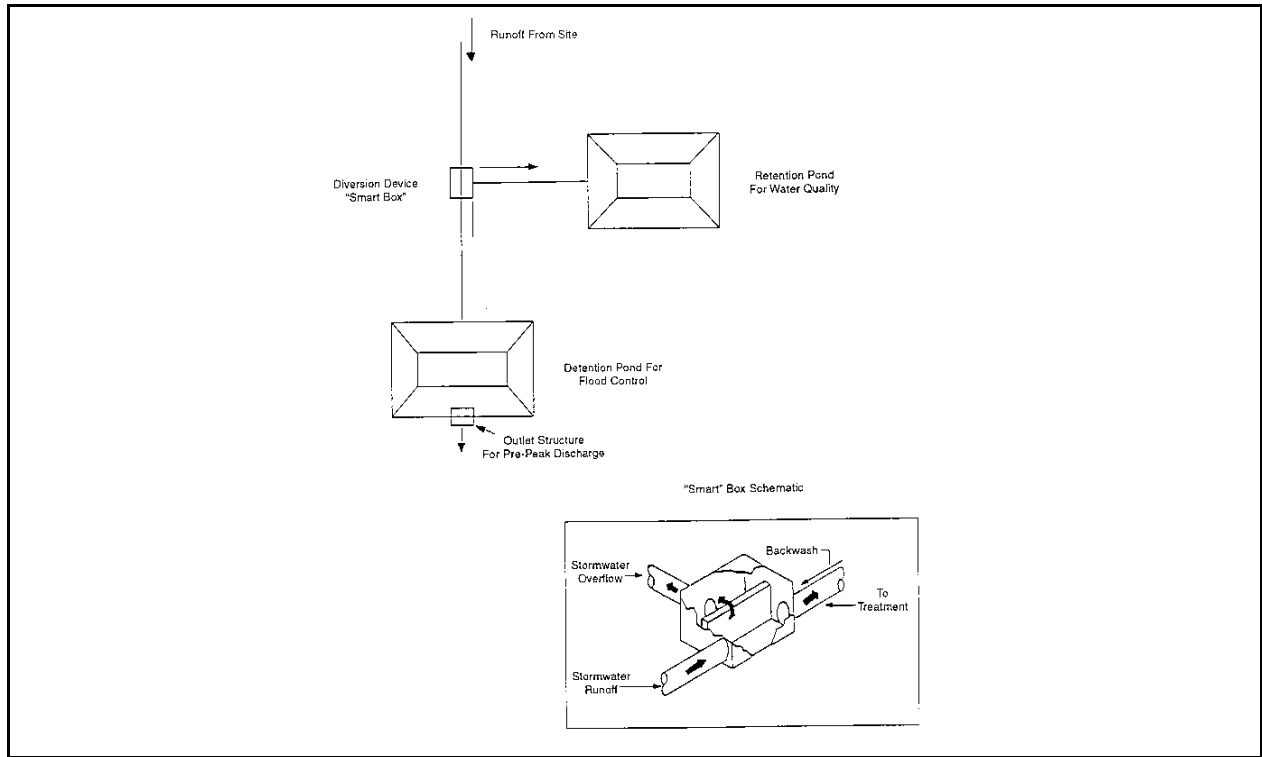

Plate 5.01a Off-Line Treatment Systems
Source: NRCS

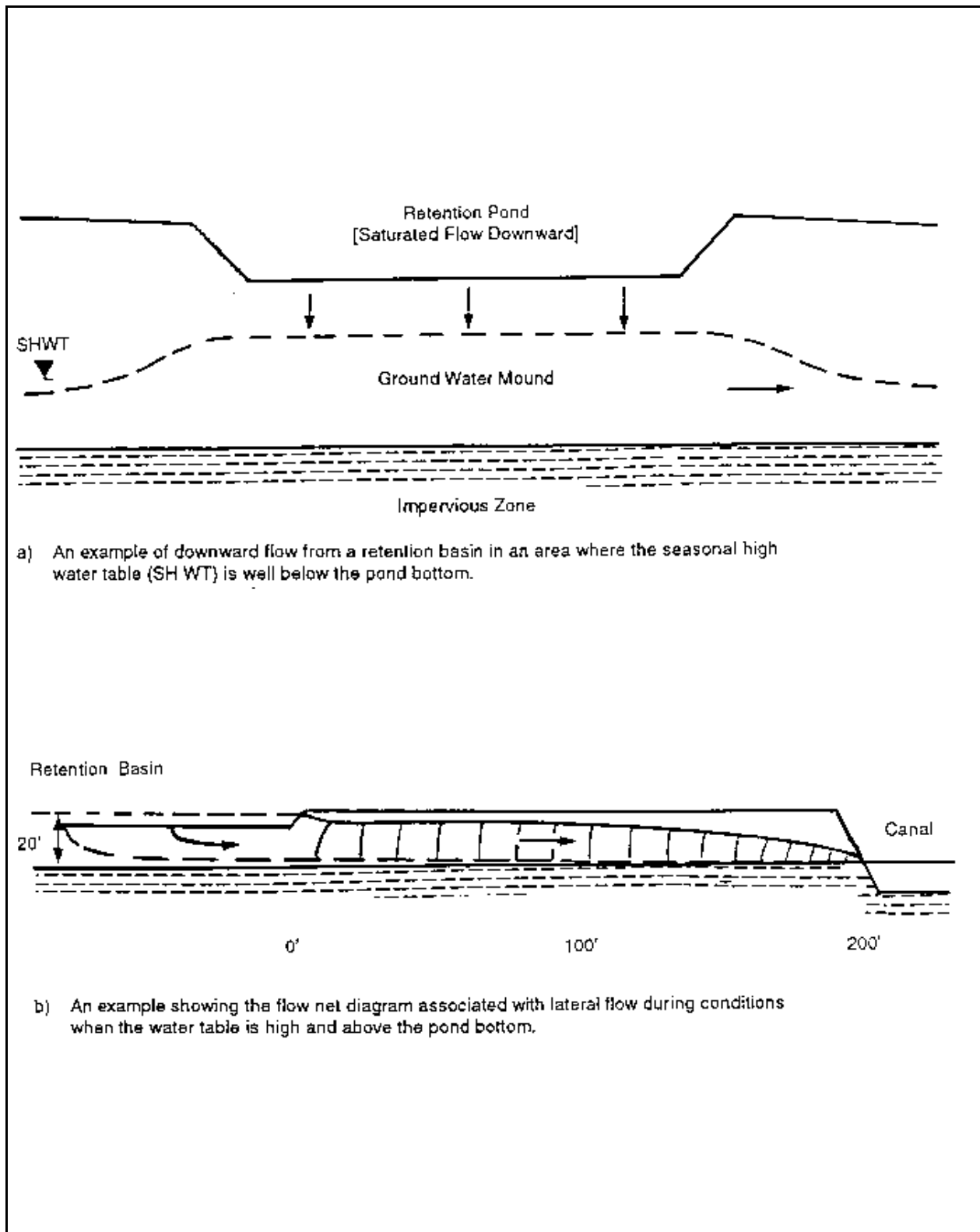

Plate 5.01b Schematic of Flow Characteristics Associated with Infiltration from Retention Ponds during Low and High Water Table Conditions

Source: Hannon, 1980

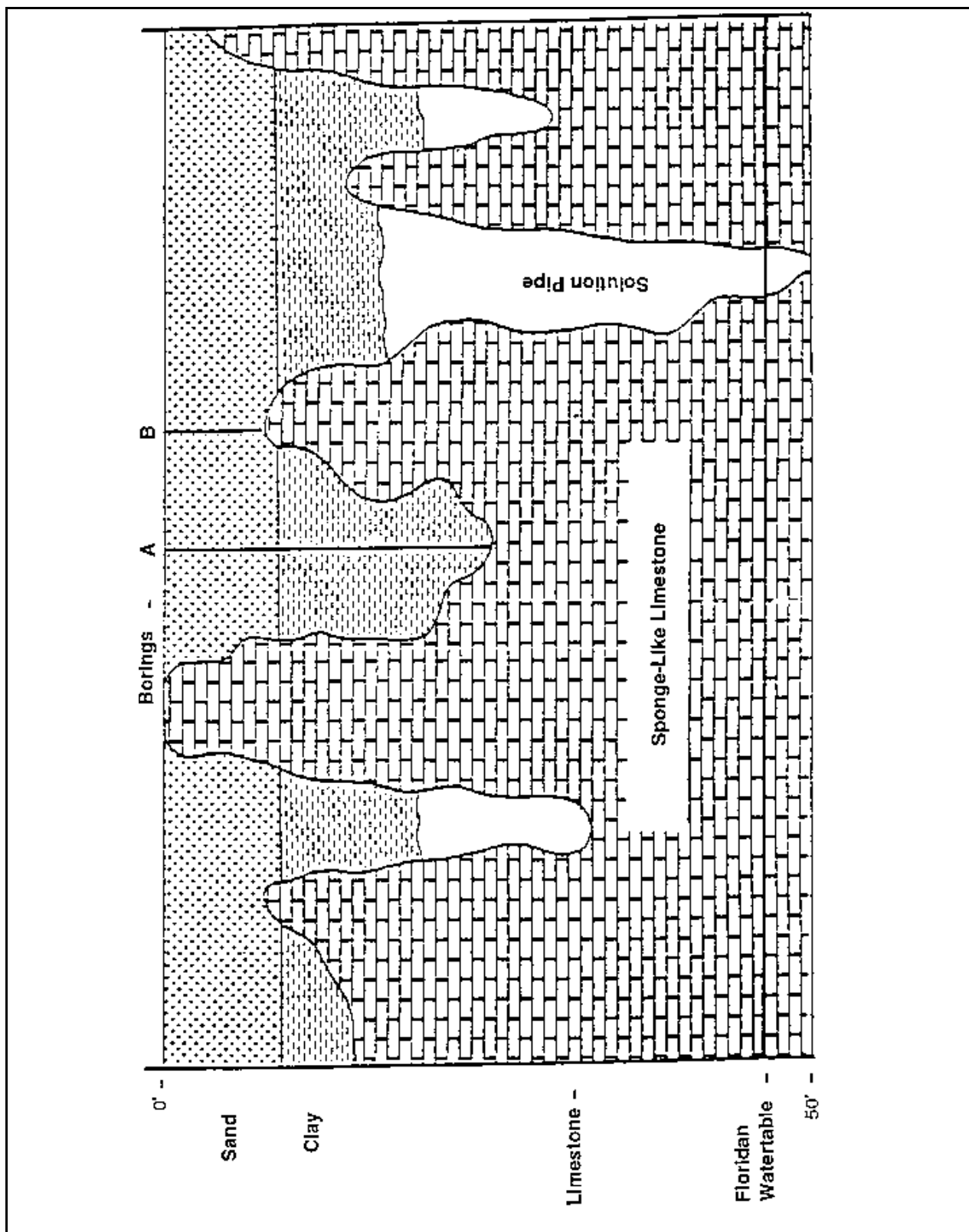

Plate 5.01c Generalized Geological Section in Karst Sensitive Area
Source: St. Johns River Water Management District, May 1988

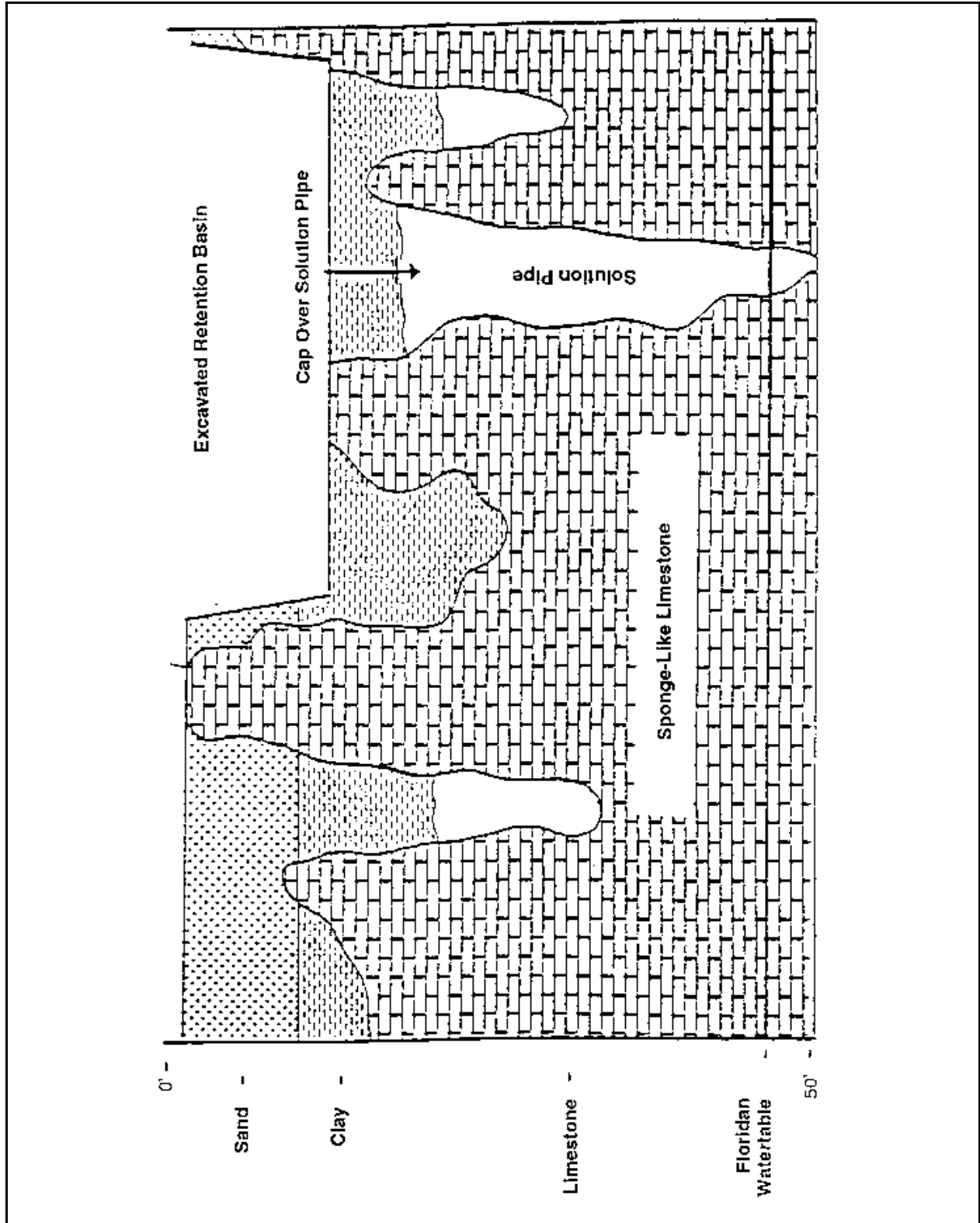

Plate 5.01d Karst Sensitive Geological Profile Illustrating Conditions Following Excavation of a Retention Basin

Source: St. Johns River Water Management District, May 1988.

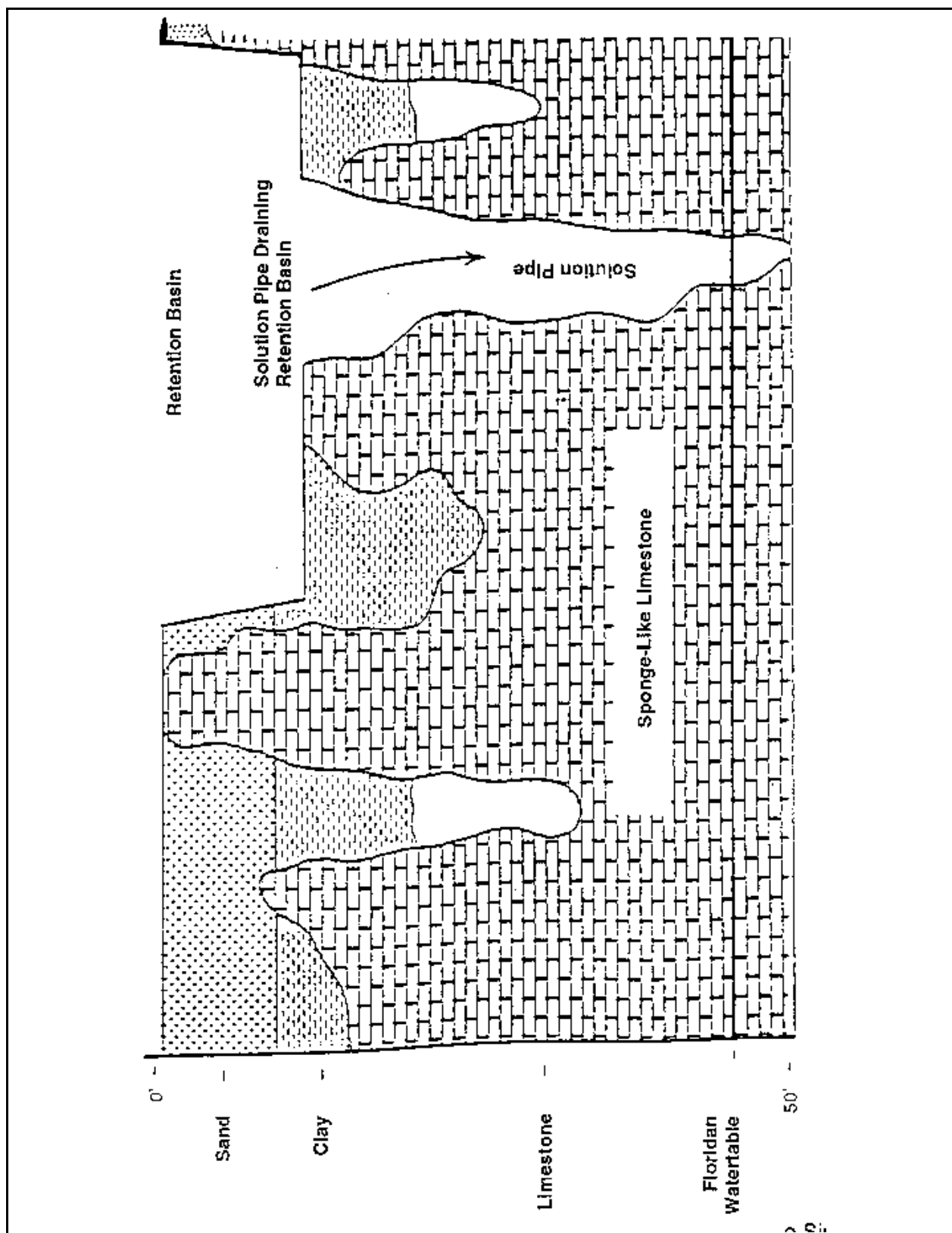

Plate 5.01e Generalized Geological Profile Illustrating Solution Pipe Sink Hole Formation Associated with Retention Pond Operation

Source: St. Johns River Water Management District, May 1988

5.02 EXFILTRATION TRENCHES (also referred to as infiltration pits and trenches) **(SW BMP 3.03)**

Definition

On site retention of stormwater accomplished below the ground. The subsurface retention BMP most commonly used in Florida is an exfoltration trench. This is an excavated trench, backfilled with coarse graded aggregate. Stormwater runoff is collected for temporary storage and infiltration. These facilities often include perforated pipe. Water is exfiltrated from the pipe and infiltrates the trench walls and, to some extent, the trench bottom for disposal and treatment. The addition of the pipe increases the storage available in the system and helps promote infiltration by making delivery of the runoff waters more effective and evenly distributed over the length of the facility. Exfiltration trenches should be designed as "off-line" systems which include a weir overflow structure or a diversion sometimes called a "smart box". The device is installed at the point of inflow to the trench system. Its purpose is to route the treatment runoff volume into the perforated pipe and trench for percolation into the surrounding soil. Excess water from larger storms is by-passed away from the trench (See Plate 5.02a).

Purposes

1. To retain the "first flush" of stormwater runoff to promote water quality improvement.
2. To reduce the runoff volume and peak discharge rate from a site, thus contributing to a reduction in downstream flooding and channel degradation.
3. To filter contaminants out of runoff before they reach receiving waters, and promote recharge of ground water supplies.

Conditions Where Practice Applies

Where the subsoil is sufficiently permeable to provide a reasonable rate of infiltration, and where the water table is sufficiently lower than the design depth of the facility. This practice is normally used where space is limited and land is expensive. Frequently used for the disposal of runoff from roof drains, parking lots, tennis courts, and roadways. This practice is not recommended where runoff water contains high concentrations of suspended materials unless a presettling sediment trap or vegetated filter strip is provided to prevent premature clogging of the geotextile filter fabric (see Plate 5.02f). Likewise, grease and oil traps are also highly recommended prior to discharge to these systems. These precautions are primarily for maintenance reasons since exfiltration systems are very susceptible to clogging and sediment build up, reducing their hydraulic efficiency and storage capacity to unacceptable levels.

Types of Infiltration Trenches

Trench construction criteria for three different soil and geologic conditions are discussed below:

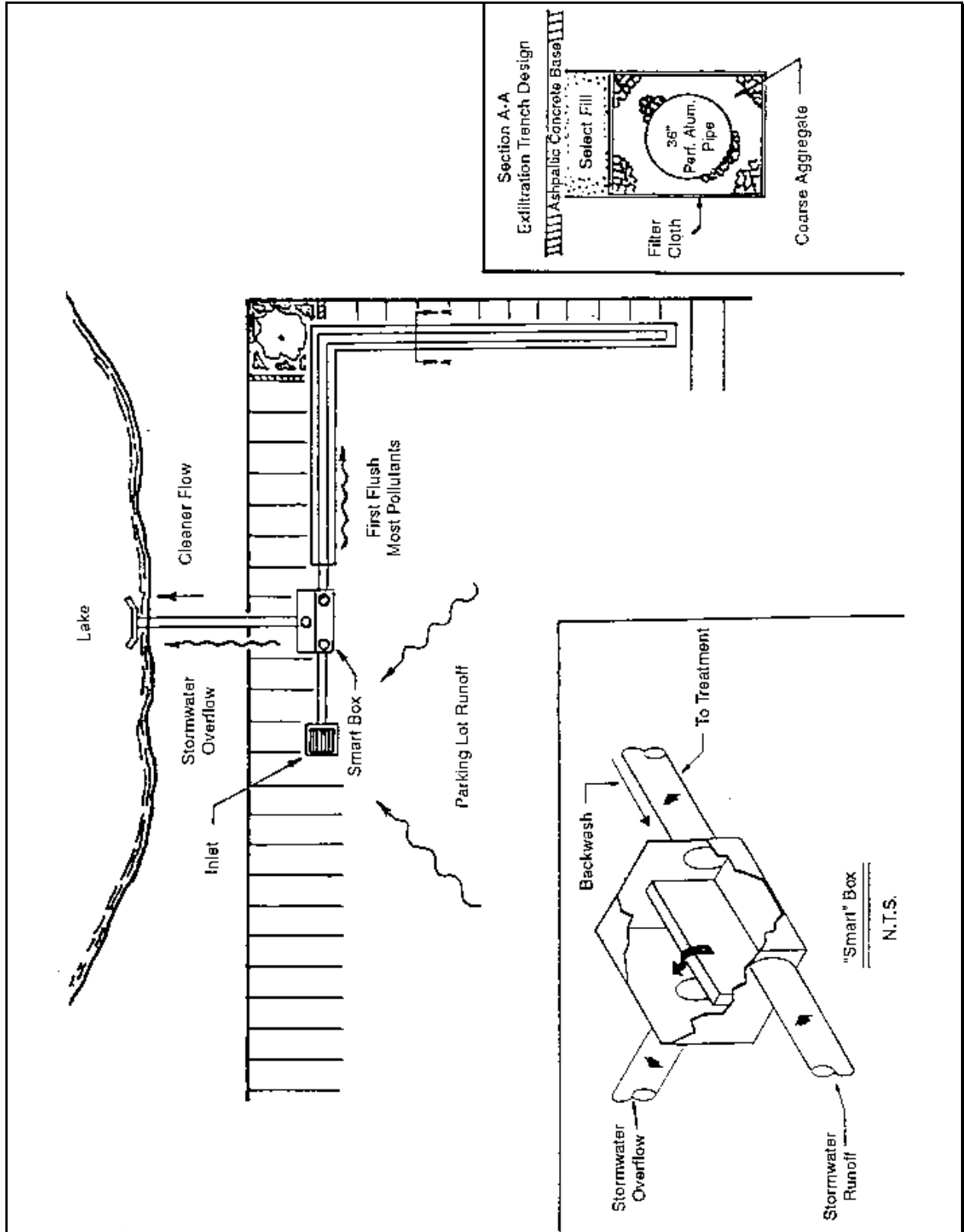

Plate 5.02a Cross-Section of Typical Infiltration/Exfiltration System for Parking or Roads
 Source: Dyer, Riddle, Mills and Precourt, Inc., Engineers/Surveyors

Trenches in Rock

Exfiltration facilities cut into permeable rock are quite often used in the Miami vicinity. These trenches are the least expensive infiltration system to construct; however, the following conditions must be met:

1. The rock must be able to support a specified wheel load on a covering concrete slab or other suitable cover.
2. The rock must be amenable to excavation without blasting.

The inlet to the system can be placed directly over the slab cover, with discharge directly into the trench (See Plate 5.02b). A more acceptable method is to set the inlet and catch basin adjacent to the trench and pipe the inflow to the trench. This technique lessens the introduction of debris into the system. Manhole access must be provided to facilitate cleaning and inspection.

Trenches in Stable Soil

In this type of trench, perforated or slotted pipe is normally used as the conduit. Coarse aggregate between the pipe and trench wall prevents side wall collapse and distributes collected water to the trench walls. Whether the pipe is included or not, the trench is usually 4 to 5 feet (1.2 - 1.5 m) in width and of sufficient depth to reach a permeable soil layer.

Coarse aggregate or other free-draining material is generally placed in the bottom of the trench and brought up to a specified pipe flowline grade, generally a minimum of 2 feet (60 cm). Perforated or slotted pipe is then placed in the trench and the trench is backfilled with the coarse aggregate to the design storage elevation. A typical Dade County installation sometimes includes a 6-inch (15 cm) thickness of finer textured filter material or pea rock placed over the aggregate backfill as shown in Plate 5.02c. The trench will normally be covered with a geotextile to prevent the sand or fill used for cover from piping and possible surface subsidence.

The trench cross-sections shown in Plate 5.02b and Plate 5.02c are typical of most installations in extreme southern Florida. The configuration is applicable in other areas where the soil or substrate is stable and provides sufficient infiltration capacity. Even where infiltration rates are marginal, the system could supplement the drainage requirements of a positive outfall system by storing, and infiltrating a portion of the stormwater into the soil; thereby reducing the downstream requirements of the positive system.

Trenches in Cohesionless Soil or Sand

Although trenches in cohesionless soil require a different type of construction, the design, final shape, and size are the same as for a trench in stable soil. However, side slopes of 1.5:1 or 2:1 may be required, if the walls are not shored during construction. Filter cloth must be used along the periphery of the trench to prevent migration of soil fines into the coarse aggregate backfill. (See Plate 5.02d)

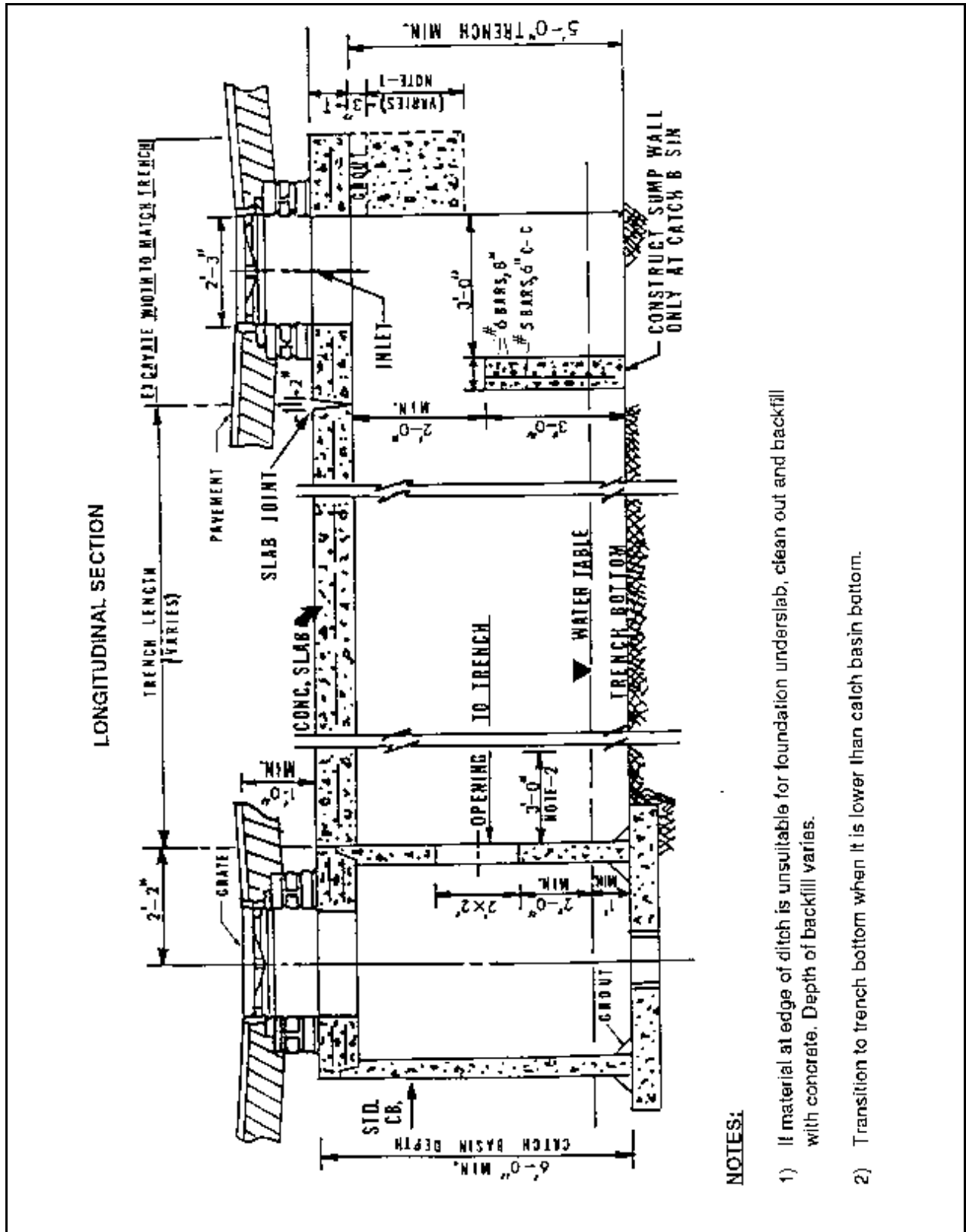

Plate 5.02b Typical Section, Slab Covered Trench, Dade County , Florida
 Source: NRCS

In a trench system where perforated pipe is used, a non-perforated-section some 6 to 8 feet (1.8 - 2.4 m) in length is used to connect the trench to the catch basin or inlet. This procedure serves to prevent piping near structures and subsidence around the inlet. A concrete slab is generally placed around the catch basin or inlet.

In the design of a trench system, any one of the above types, or combination thereof, may be used. It is recommended that a positive overflow pipe or bypass also be provided to allow for large storm events.

Trench Construction Specifications

Safety

Trench construction techniques will vary with local site conditions. Strict adherence to OSHA's Trench Safety Code, and/or other local regulations relative to acceptable construction practice, should be observed. Depending upon the length and width of trench, a backhoe, wheel, or ladder type trencher may be used for excavation. Excavated material should be stored at least 10 feet (3 m) from the trench to avoid backsliding and cave-ins.

General Construction Recommendations

Proper construction and routine maintenance are extremely important for successful trench applications. A substantial number of trenches have failed shortly after being built, primarily due to poor construction practices, inadequate field testing, or because sediment was not filtered or trapped before entering the trench. The discussion below highlights construction and erosion control procedures that should minimize the risk of premature clogging.

1. Before the entire development site is graded, the area planned for the trench should be roped off to prevent heavy equipment from compacting the underlying soils.
2. Diversion berms should be placed around the perimeter of the trench during all phases of construction. Sediment and erosion control plans for the site should be oriented to keep sediment and runoff completely away from the trench area. Otherwise, actual construction of the trench should not begin until after the site is completely stabilized.
3. The trench should be excavated using a backhoe or trencher equipped with tracks or over-sized tires. Normal rubber tires should be avoided since they compact the subsoil and may reduce infiltration capability. For the same reason, the use of bulldozers or front-end loaders should be avoided.
4. Sediment control is critical. It is therefore important that sediment and erosion controls be inspected following each storm to make sure they still work. If a vegetated buffer strip is planned for pre-treatment of runoff entering the facility, grass should be established immediately, preferably by sodding. When hydroseeding is used, reinforced silt fences must be placed between the buffer and trench to prevent sediment entry before the buffer becomes fully established.

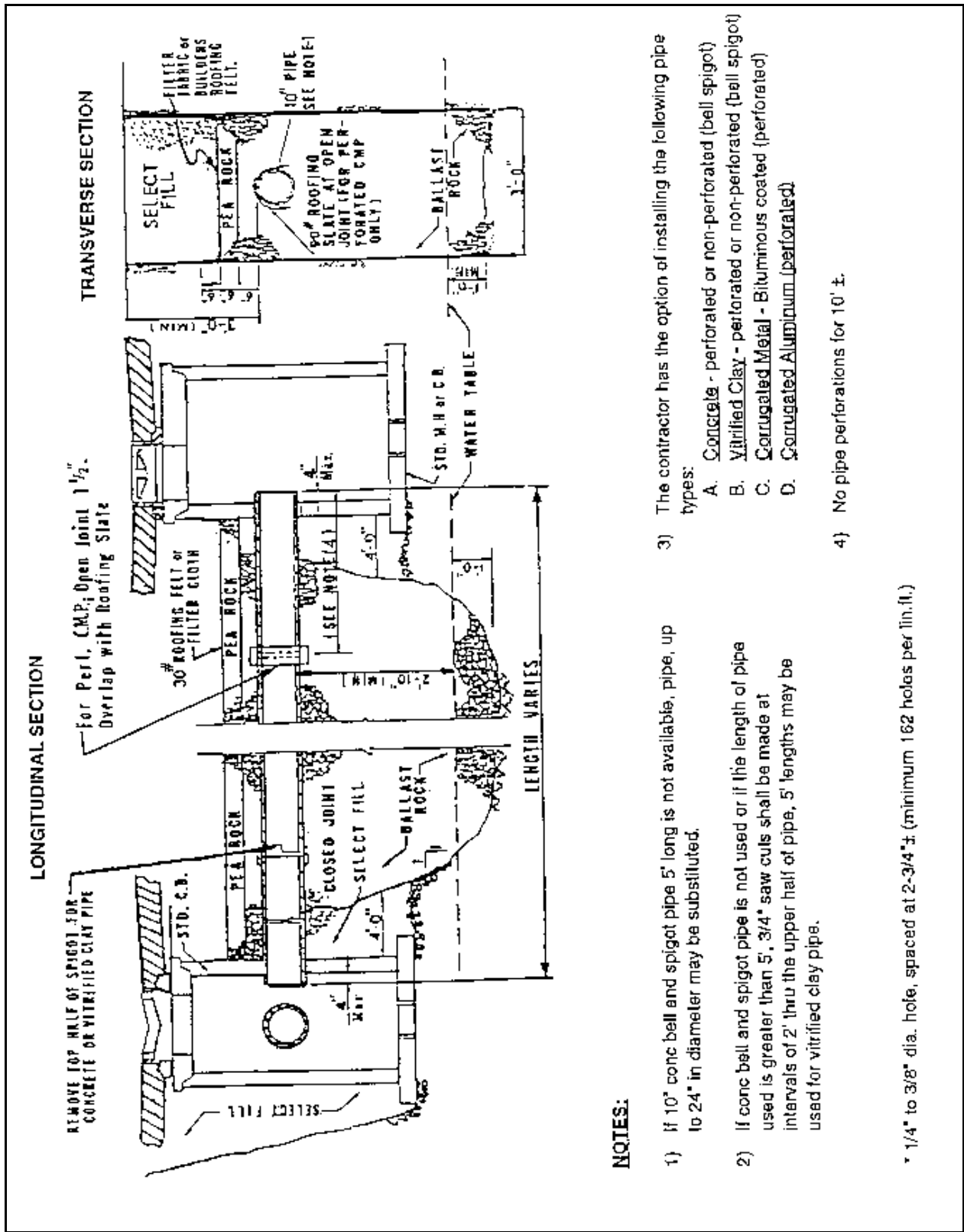

NOTES:

- 1) If 10" conc bell and spigot pipe 5' long is not available, pipe, up to 24" in diameter may be substituted.
- 2) If conc bell and spigot pipe is not used or if the length of pipe used is greater than 5', 3/4" saw cuts shall be made at intervals of 2' thru the upper half of pipe, 5' lengths may be used for vitrified clay pipe.
- 3) The contractor has the option of installing the following pipe types:
 - A. Concrete - perforated or non-perforated (bell spigot)
 - B. Vitrified Clay - perforated or non-perforated (bell spigot)
 - C. Corrugated Metal - Bituminous coated (perforated)
 - D. Corrugated Aluminum (perforated)
- 4) No pipe perforations for 10' ±.

* 1/4" to 3/8" dia. hole, spaced at 2-3/4" ± (minimum 162 holes per lin.ft.)

Plate 5.02c Exfiltration Trench (French Drain), Dade County, FL
Source: NRCS

Perforated or Slotted Pipe

When perforated pipe is used for conveyance and distribution, a liberal number of holes to ensure free and rapid flow in and out of the walls of the pipe should be provided. Large diameter pipe adds to total storage volume in the trench. The use of a pipe in the trench system also allows for ease of maintenance as described in MAINTENANCE - Section 5.20. The pipe serves as a catchment for sediment without reducing overall efficiency.

Pipes manufactured of plastic, steel, aluminum, concrete, or other materials are available for this application. Perforated metal pipes usually have 3/8-inch (9 mm) diameter perforations uniformly spaced around the full periphery of a pipe. Specifications stipulate not less than 30 perforations per square foot (323 perforations/m²) of pipe surface. Other perforations not less than 5/16 inch (8 mm) in diameter or slots, are permitted if they provide a total opening area of not less than 3.31 square inches per square foot (230 cm²/m²) of pipe surface.

Tentative specifications for slotted concrete pipe with cast slots have been developed based on field performance and cooperative testing by FDOT and industry. Concrete pipe with 3/8-inch (9 mm) wide slots is usually specified. Slots should be circumferential in direction, approximately 3/8-inch (9 mm) in width and not less than 4 inches (10 cm) in length at the inside of the pipe. Four rows of slots are generally specified for pipe 30 inches (75 cm) in diameter or less. Six rows are specified for pipe 36 inches (90 cm) in diameter and larger.

Pipe Backfill

Coarse aggregate backfill material serves to support the sides and top of an infiltration trench following construction. It also provides good bedding for distribution and overflow pipes. Aggregates for this purpose must be sound and comply with FDOT established specifications for durability. The material must provide sufficient void space to allow for the storage of the required volume of runoff. The designer should also allow for the accumulation of the normally encountered fine sands, silts, silty clays, and other material in stormwater which will pass through the perforations or slots in the pipe conduit into the backfill during the expected life of the facility.

Clean, washed stone aggregate should be placed in the excavated trench in lifts, **lightly** compacted to form the base. Unwashed stone has enough associated sediment to pose a clear risk of clogging at the soil/filter cloth interface. Granite, washed pea-gravel, or river rock is usually acceptable. Where possible, the use of crushed limestone aggregate should be avoided unless the limestone is washed, contains little or no phosphorus, and is of the hard variety.

Pea Rock or Gravel

This material is often placed in a 6-inch (15 cm) layer over the top of the aggregate for the pipe backfill as illustrated in Plate 5.02c. This layer serves as a granular filter below the filter fabric. The gradation for this layer should consist of 100% material passing the 1-inch (25 mm) sieve with not more than 5% passing the No. 4 sieve.

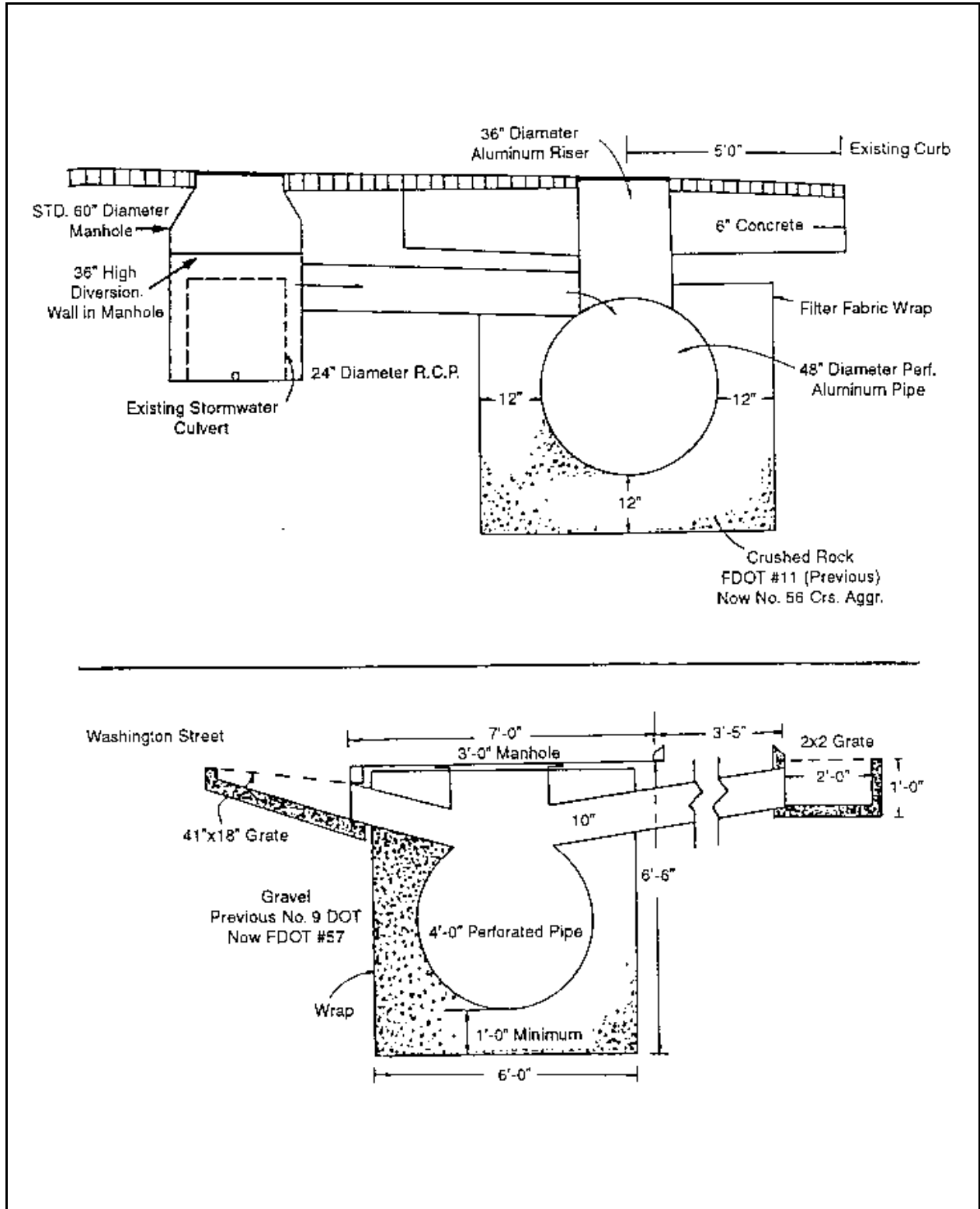

Plate 5.02d Examples of Typical Underground Percolation Systems for Retrofitting Existing Stormsewer Systems in Orlando, Florida.
Source: NRCS

Synthetic Filter Fabrics

When fine native materials are encountered in the excavation, a filter cloth envelope or wrap should be placed around the coarse aggregate backfill. This practice serves to prevent migration of fine materials from the surrounding soil. These fine sediments could result in clogging of the trench following reverse flow conditions resulting from high groundwater. A number of plastic woven or non-woven filter fabrics can be used for this purpose. However, care should be taken to prevent tearing or puncture of the fabric. Likewise, adjacent sheets should be overlapped 12" - 18" (30 - 45 cm) and secured to prevent openings from developing.

To ensure good performance, synthetic fabrics (either woven or non-woven) must be carefully selected, based on the properties required. As with aggregate filters, fabric filters must provide two very important functions:

1. They must be able to prevent clogging of the drain by the migration of erodible soil or other material from the substrate into the trench, which could also result in erosion, piping, or other problems.
2. They must not inhibit the free flow of water.

Care should be taken in selecting the proper kind of filter fabric, as available brands differ significantly in their permeability and strength. If desired, a six inch (15 cm) deep filter of clean, washed sand may be substituted for filter fabric on the bottom of the trench.

Likewise, the use of filter fabric directly surrounding slotted corrugated polyethylene pipe has recently become a popular derivation of the typical exfiltration trench design. In these facilities, sedimentation and filtration of particulates larger than the silt/clay size range take place within the perforated pipe. Consequently, the pipe is more prone to clogging and large reductions in capacity will occur more often than usual. While this may seem unacceptable, manufacturers point out that the pipe may be cleaned relatively easily using high pressure hoses, vacuum systems, etc. On the other hand, conventional designs usually require complete replacement when clogging eventually occurs.

Observation Well

An observation well is recommended for installation in every infiltration trench. The observation well will serve two primary functions:

1. It will indicate how quickly the trench dewateres following a storm.
2. It will provide a method of observing how quickly the trench fills up with sediments.

A simple observation well may consist of perforated PVC pipe, 4 to 6 inches (10 - 15 cm) in diameter. It is usually located in the center of the facility and is constructed flush with the ground elevation of the trench as shown in Plate 5.02e. The top of the well should be capped and locked to discourage vandalism and tampering.

The observation well is needed to monitor the performance of the trench. It is also useful in marking the trench location. The drain time for a trench can be measured by placing a graduated dip-stick down the well immediately after a storm and again twenty-four and forty-eight hours later.

For the first year after completion of construction, the well should be monitored on a quarterly basis and after every large storm. It is recommended that a log book be maintained indicating the rate at which the facility dewateres after large storms and the depth of the well at each observation. Once the performance characteristics of the structure have been verified, the monitoring schedule can be reduced to a semi-annual basis, unless the performance data indicate that a more frequent schedule is required.

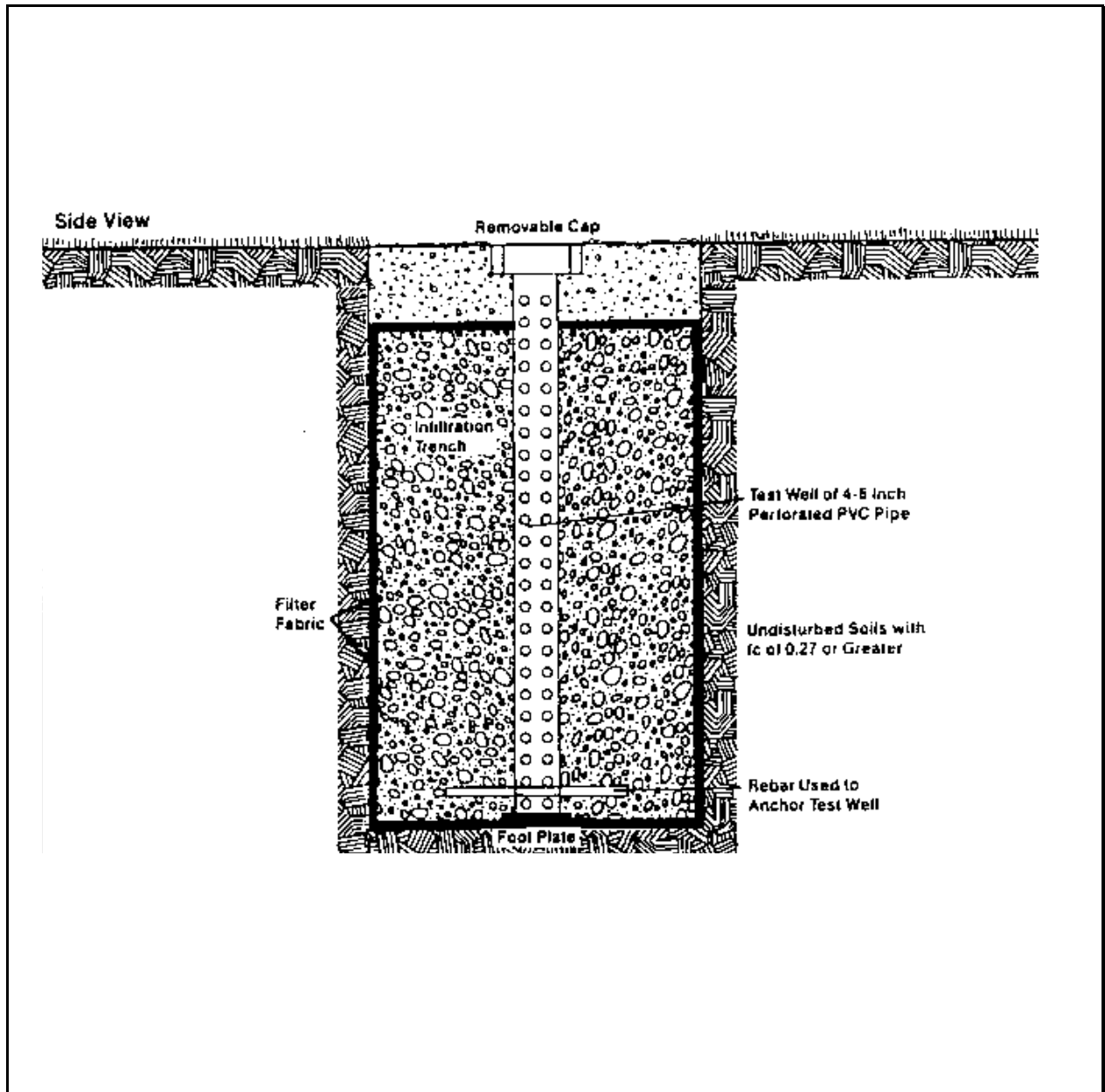

Plate 5.02e Detailed Schematic of a Typical Observation Well
 Source: Schueler (1987).

A monitoring well in the top foot (30 cm) of stone aggregate will be required when the trench has a stone surface. Sediment build-up in the top foot (30 cm) of stone aggregates or the surface inlet should be monitored on the same schedule as the observation well. Sediment deposited shall not be allowed to build up to the point where it will significantly reduce the rate of infiltration into the trench.

Overflow

Unless the facility is designed to accommodate the total amount of anticipated runoff from a large design storm, some provisions should be made for overflow. In order to have maximum benefit in reducing downstream flood peaks, these structures should be designed to overflow before the total storage capacity is reached. There are many ways to accomplish this. Pipes can be used, for instance, to connect a sequence of infiltration facilities so that when the first one fills, it passes water through to the next one, and so on. Generally, several smaller facilities are more effective than one large one, though the latter may be necessary when there are space limitations. The capacity and cost of overflow discharge systems can be reduced by allowing temporary storage space above the infiltration trenches.

Because of the small drainage areas controlled by the exfiltration trench, an emergency spillway usually is not necessary. In all cases, however, the overland flow path of any surface runoff exceeding the capacity of the trench should be evaluated to preclude the development of an uncontrolled, erosive watercourse.

Seepage Analysis and Control

An analysis shall be made to determine any possible adverse effects of seepage zones when there are nearby building foundations, roads, parking lots, or sloping sites. Developments on sloping sites often require the use of extensive cut and fill operations. The use of infiltration trenches on fill sites with steep slopes is not recommended. Fill areas can be very susceptible to slope failure due to slippage along the interface of the undisturbed soil and the fill material. This condition could be further aggravated if the fill material is allowed to become saturated using retention practices. The methods for seepage analysis and estimation of infiltration rates using Darcy's law and flow nets can be used to conduct the seepage analysis.

When exfiltration trenches are used in residential areas, special care must be taken to prevent seepage from causing unstable soil conditions near foundations. Trenches three or more feet (>0.9 m) deep shall be located at least 10 feet (3 m) down gradient from foundation walls. Trenches should also be no closer than 100' (30 m) from wells or septic tanks.

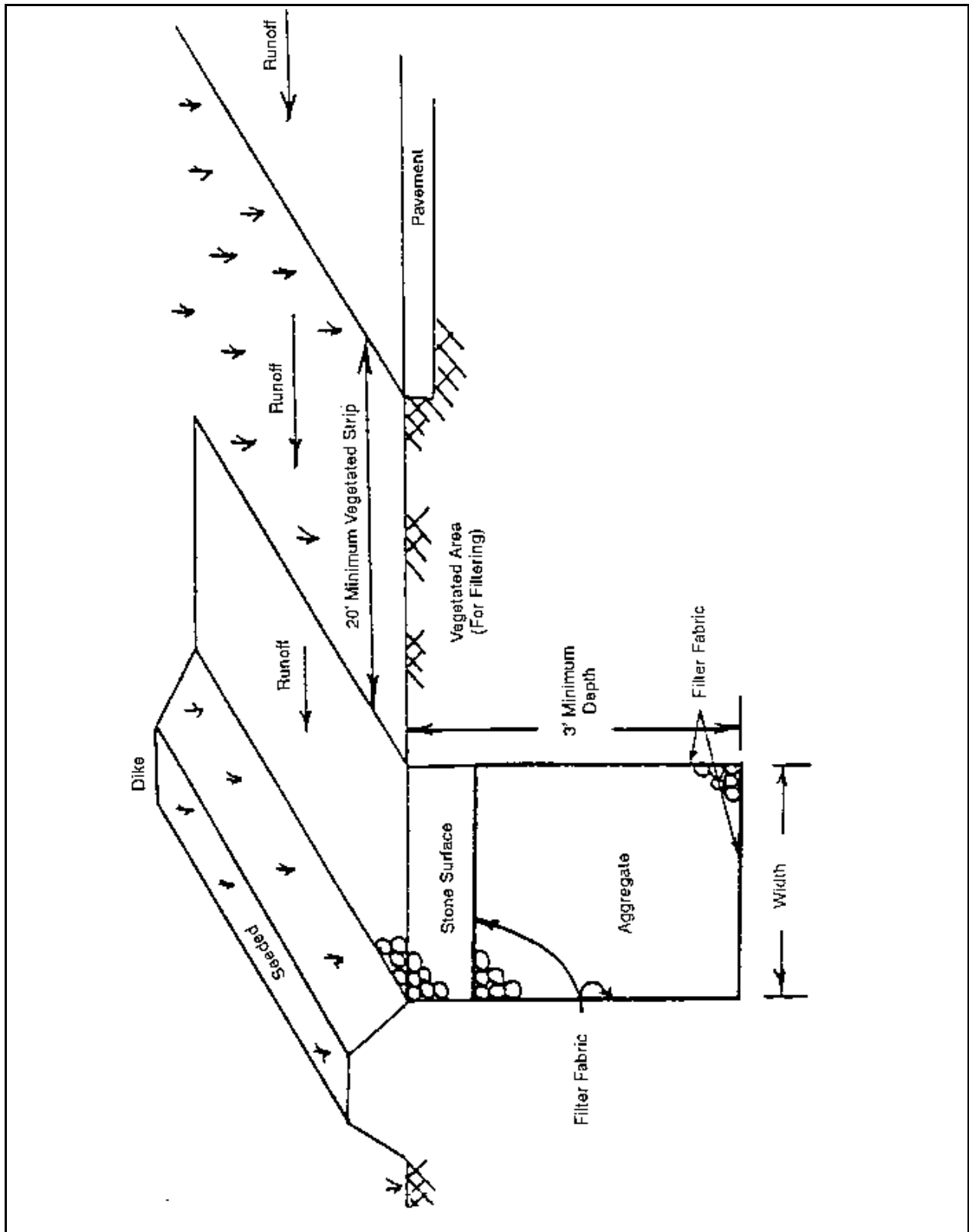

Plate 5.02f Example Application of a Vegetated Area for Pretreatment of Runoff Prior to Exfiltration in Frederick County, Maryland
 Source: NRCS

5.03 POROUS PAVEMENT **(SW BMP 3.06)**

Definitions

Pervious concrete consists of specially formulated mixtures of Portland Cement, uniform open graded coarse aggregate such as FDOT #8 or #89 (3/8 inch)(10 mm) to #5 or #56 (1 inch)(25 mm), and potable water. This material may be combined with certain water reducing and retarding or accelerating admixtures along with air entraining agents. When properly handled, and installed pervious concrete has a high percentage of void space which allows rapid percolation of liquids through the pavement. (See Plate 5.03a)

Purpose

1. To reduce volumes and peak rates of runoff normally associated with urban-type development, thereby reducing the potential for combined sewer overflows, downstream channel erosion, and subsequent sediment pollution.
2. To improve water quality by filtration and bacterial action.
3. To aid in ground water recharge.

Conditions Where Practice Applies

Theoretically, applicable as a direct substitute for conventional concrete pavements wherever on-site retention is necessary to control runoff rates, volumes, and/or quality. However, this practice is most popular for low-volume traffic areas such as parking areas, where stable subgrade soils having at least moderate permeability exist. The practice should have a wider range of application in areas with very sandy soils.

Several regulatory agencies in Florida have placed restrictions on the use of porous pavement due to failure resulting from lack of maintenance. Use of this practice should be restricted to entities which have demonstrated a capability to maintain the pavement and/or the ability to restrict access to vehicles that have taken precautions such as tire washing. An operating permit (2 - 5 years duration) based on regular performance inspection is another method to safeguard the effectiveness of this practice.

Construction Specifications

The subgrade shall be prepared following standard practices as described in EARTHWORK SPECIFICATIONS - Section 5.00, and as directed by a Florida registered professional engineer. Light equipment or low ground pressure equipment should be used to avoid compaction of the subsoil. Mixing and placement shall be performed by qualified contractors under the direction of the professional engineer.

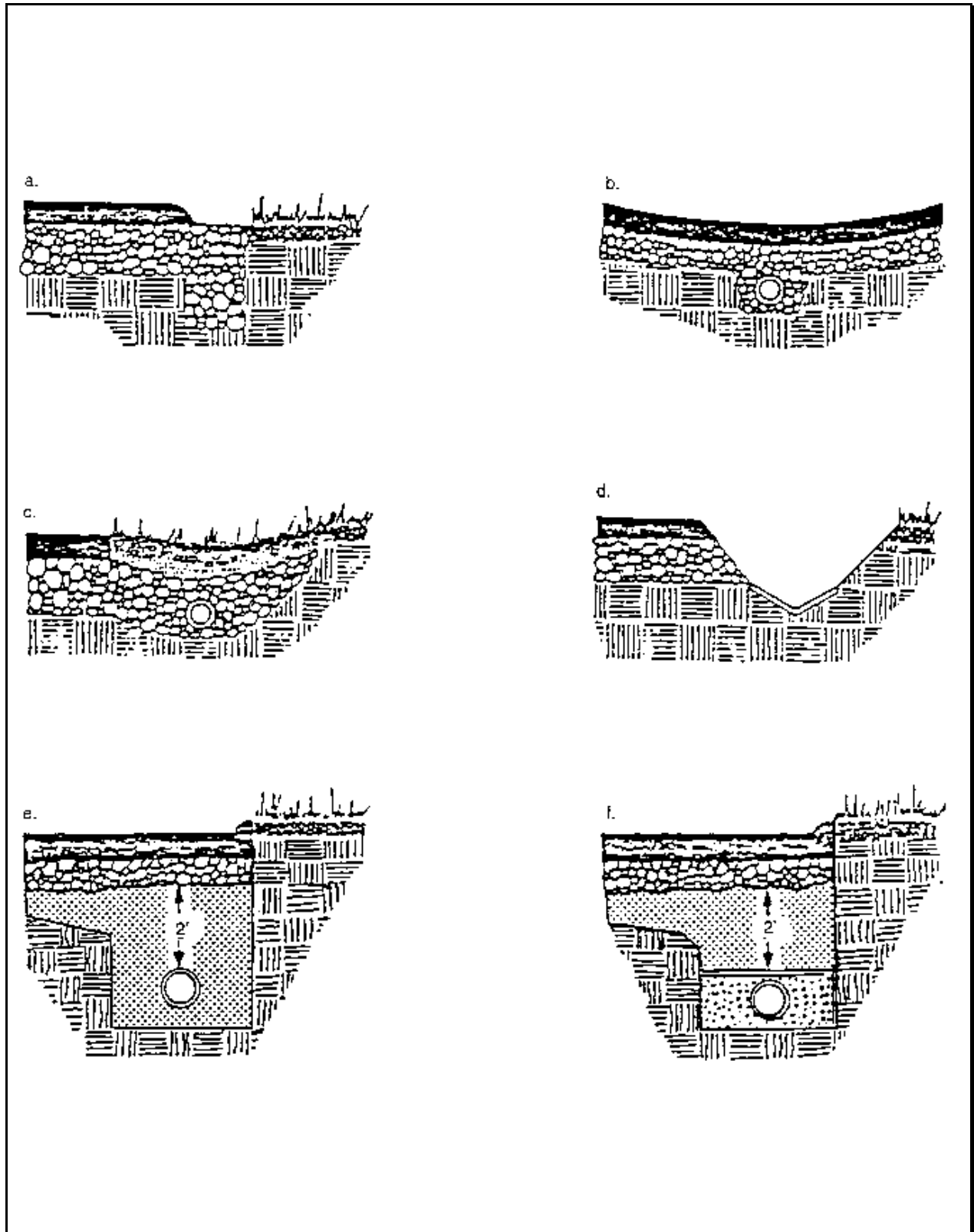

Plate 5.03a Examples of Porous Pavement Drainage Systems

Source: Investigation of Porous Pavements for Urban Runoff Control, Thelen et al.

5.04 CONCRETE GRID AND MODULAR PAVEMENT **(ES BMP 3.01)**

Definition

A pavement consisting of strong structural materials having regularly interspersed void areas which are filled with pervious materials, such as sod, gravel, or sand (see Plate 5.04a).

Purpose

To reduce water pollution from low-volume traffic areas by providing a bearing surface having adequate strength to accommodate vehicles while allowing infiltration of surface water and filtration of pollutants. The approach is intended to achieve this purpose by:

1. Reducing the volume and peak rate of runoff flow, thus reducing the likelihood of sewer overflows, flooding, and downstream erosion and sediment pollution.
2. Reducing the loading and concentration of pollutants in the runoff.

Conditions Where Practice Applies

Where pavement is desirable or required for low-volume traffic areas and the underlying soils allow for rapid drainage. This practice is most applicable for new construction, but it can be used in existing developments to expand a parking area or even to replace existing pavement if that is a cost-effective measure. This practice should NOT be used in areas where infiltrated pollutants may reach and degrade ground water.

Possible areas for use of these paving materials include:

1. Parking lots, especially fringe or overflow parking areas.
2. Parking aprons, taxiways, blast pads, and runway shoulders at airports (heavier loads may demand the use of reinforced grid systems).
3. Emergency stopping and parking lanes and vehicle cross-overs on divided highways.
4. On-street parking aprons in residential neighborhoods.
5. Recreational vehicle camping area parking pads.
6. Private roads, easement service roads, and fire lanes.
7. Industrial storage yards and loading zones (heavier loads may demand the use of reinforced grid systems).
8. Driveways for residential and light commercial use.

9. Sidewalks, patios, and swimming pool aprons.
10. Boat ramps, bike paths, nature trails.

Construction Specifications

The subgrade shall be prepared following standard practices as described in EARTHWORK SPECIFICATIONS - Section 5.00, and as directed by a Florida registered professional engineer. Light equipment or low ground pressure equipment should be used to avoid compaction of the subsoil. Grid or modular pavement shall be installed according to the manufacturer's specifications. The void spaces can be filled with sand, gravel, or vegetated according to the practices described in Chapter 6.

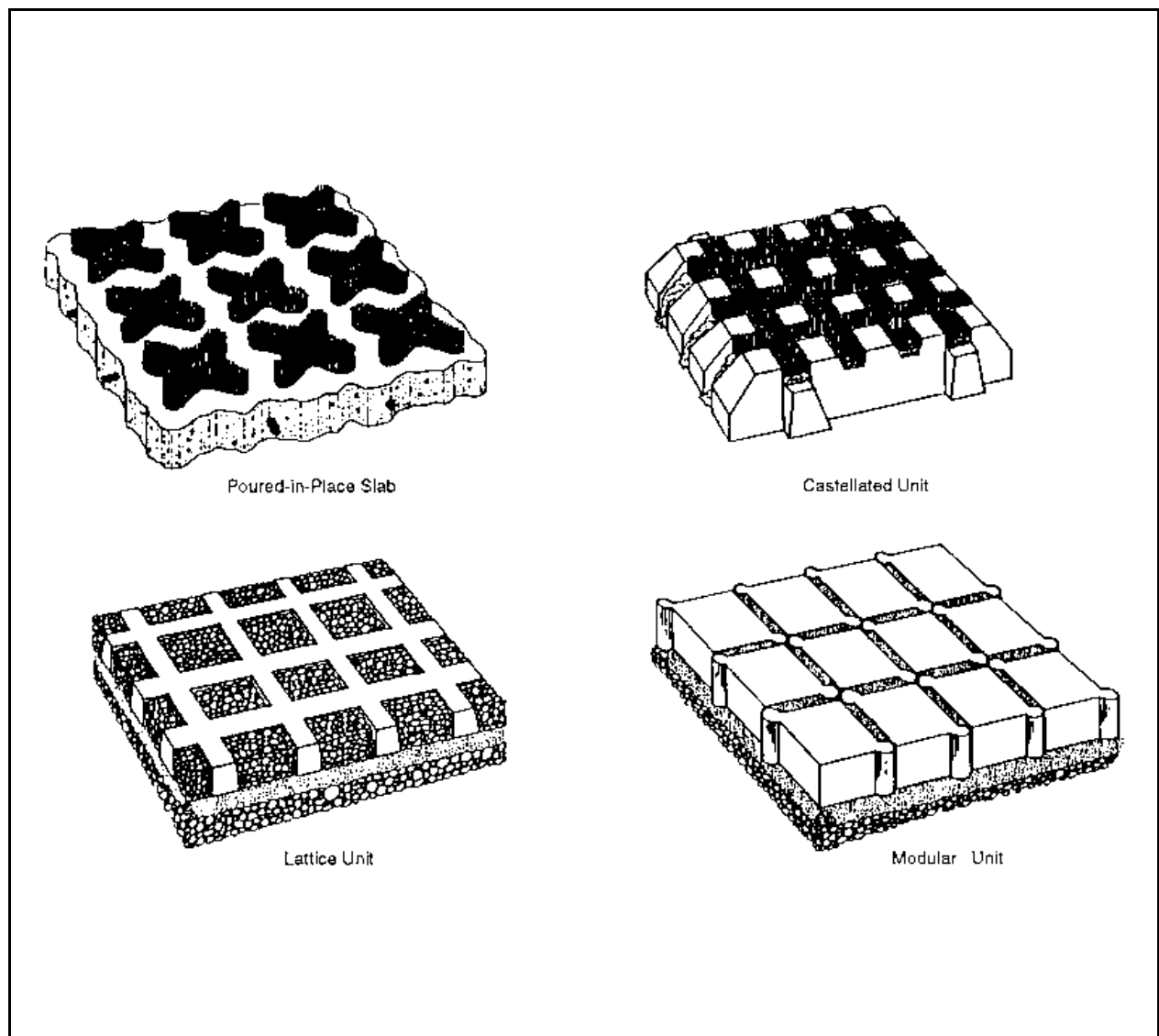

Plate 5.04a Types of Grid and Modular Pavement

Source: Virginia Soil and Water Conservation Commission

5.05 STORMWATER DETENTION BASINS (SW BMP 3.02)

Definition

On-site detention refers to the temporary storage of excess runoff on the site prior to its' gradual release after the peak of the storm inflow has passed. Runoff is held for a short period of time and is slowly released to a natural or constructed water course, usually at a rate no greater than the pre-development peak discharge rate.

Purpose

The objective of a detention facility is to regulate the runoff from a given rainfall event and to control discharge rates to reduce the impact on downstream stormwater systems, either natural or manmade. Generally, detention facilities will not reduce the total volume of runoff, but will redistribute the rate of runoff over a period of time by providing temporary "live" storage of a certain amount of stormwater. The volume of temporary "live" storage provided is the volume indicated by the area between the inflow and outflow hydrographs as shown in Plate 5.05a.

A major benefit derived from properly designed and operated detention facilities is the reduction in downstream flooding problems. Other benefits include reduced costs of downstream stormwater conveyance facilities, reduction in pollution of receiving streams and enhancement of aesthetics within a development area by providing a core of "blue-green" areas for parks and recreation.

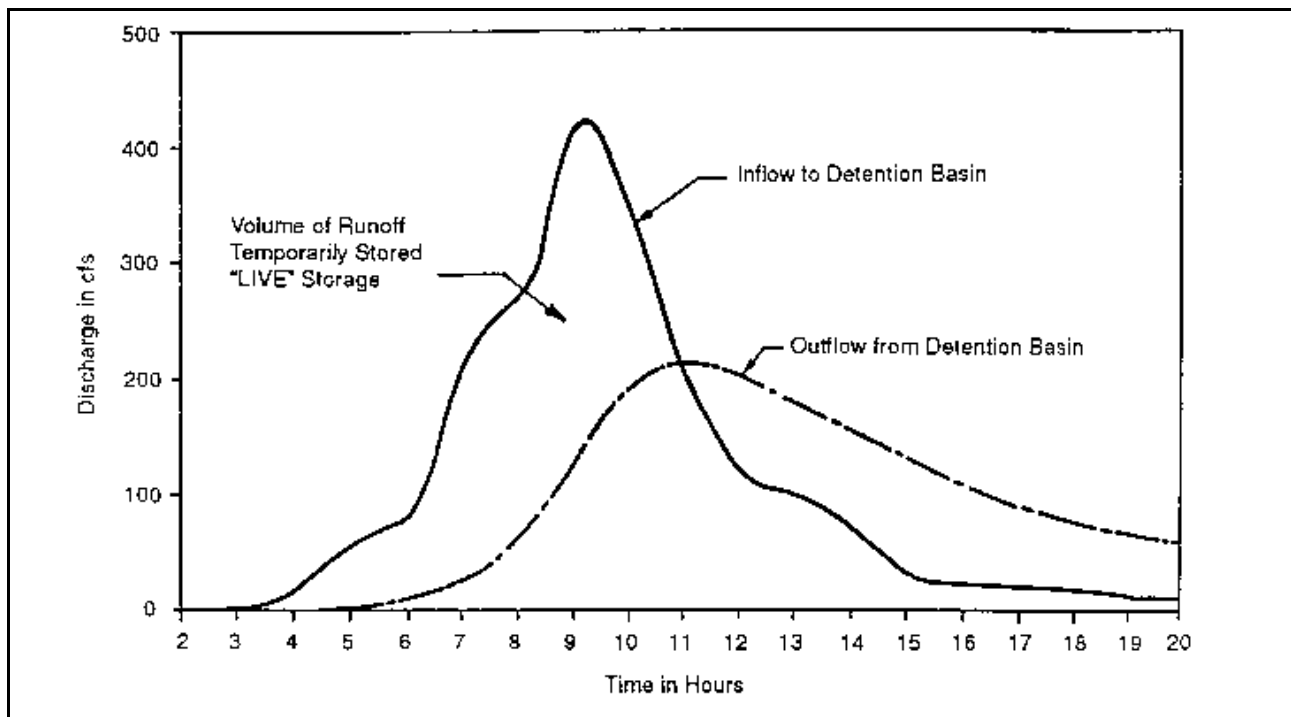

Plate 5.05a Typical Detention Basin Hydrographs

Source: NRCS

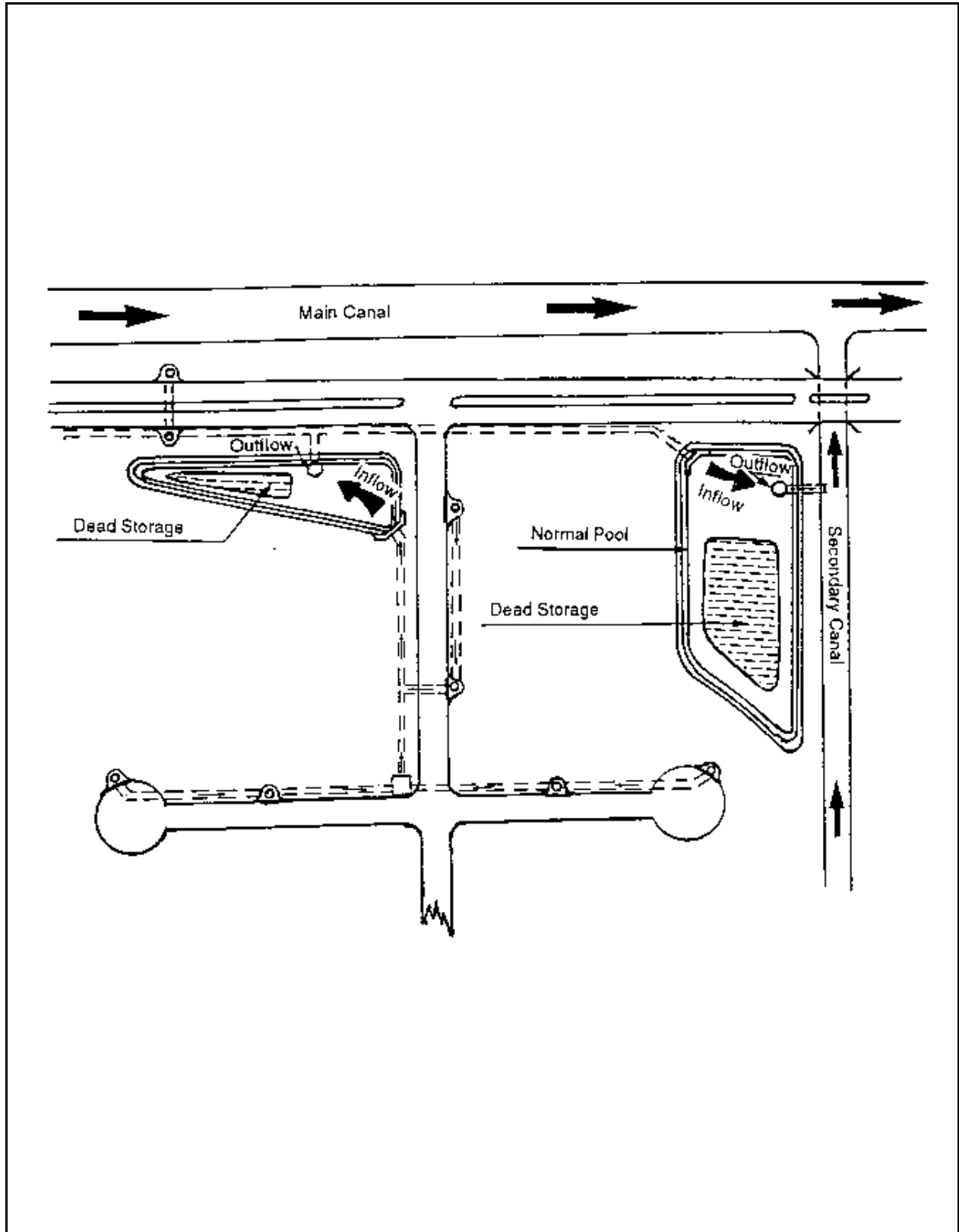

Plate 5.05b Examples of Dead Storage Areas in Wet Ponds
Source: NRCS

Construction Specifications

Initial basin construction should be carried to within 1 ft. (0.3m) of the elevation of the basin floor. Interior sideslopes should be sodded immediately to prevent erosion and the introduction of additional sediments. Final excavation shall be deferred until all contributing areas of the watershed have been stabilized.

Structural elements, such as embankments, inlets, flumes, and emergency spillways, shall be designed by a Florida registered professional engineer. These elements shall be constructed in accordance with EARTHWORK SPECIFICATIONS - Section 5.00 and other acceptable engineering standards.

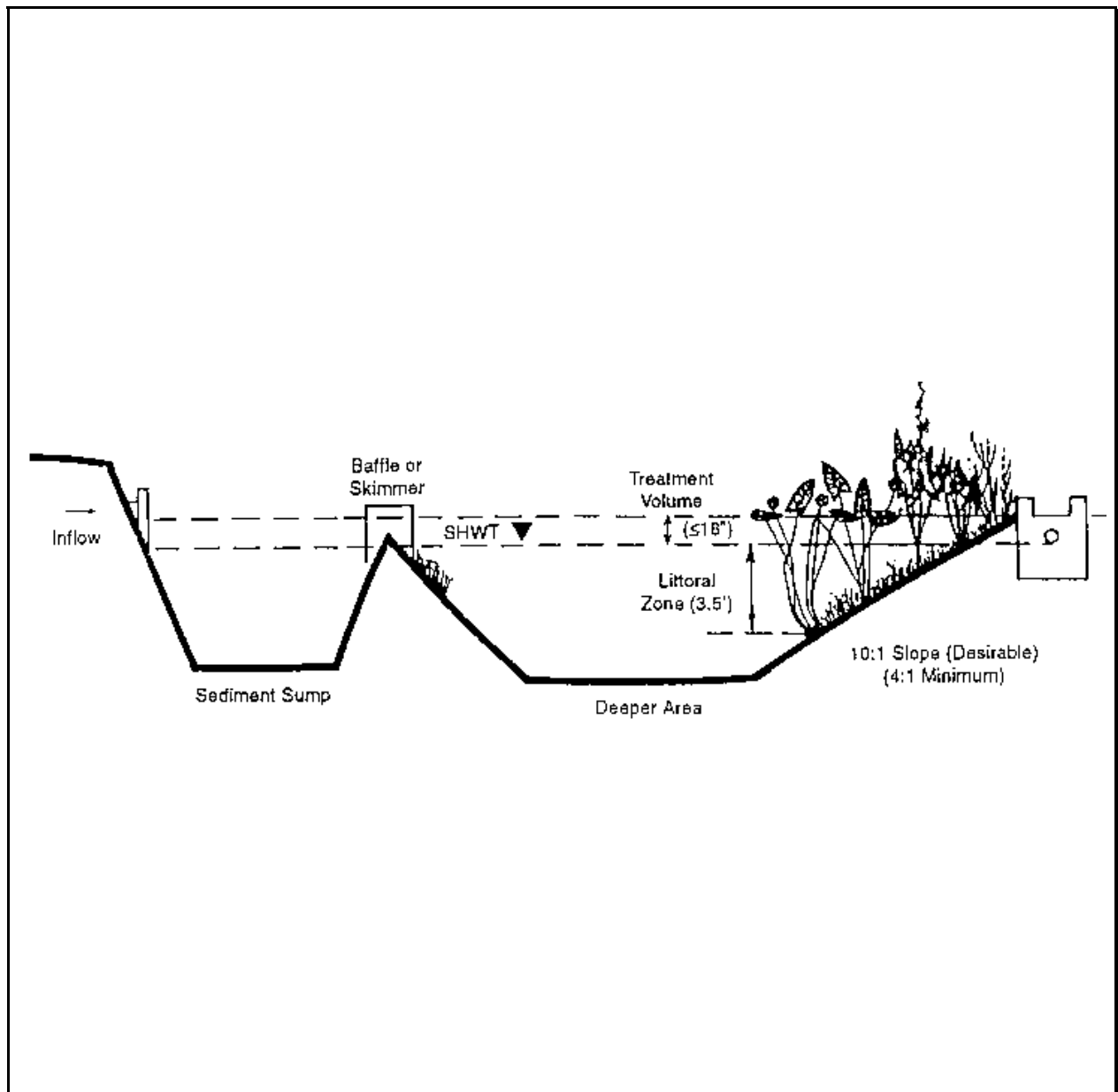

Plate 5.05c Wet Detention System, Pond Configuration - A

Source: SWFWMD Management and Storage of Surface Waters, Permit Information Manual, Vol. 1, Mar. 1988

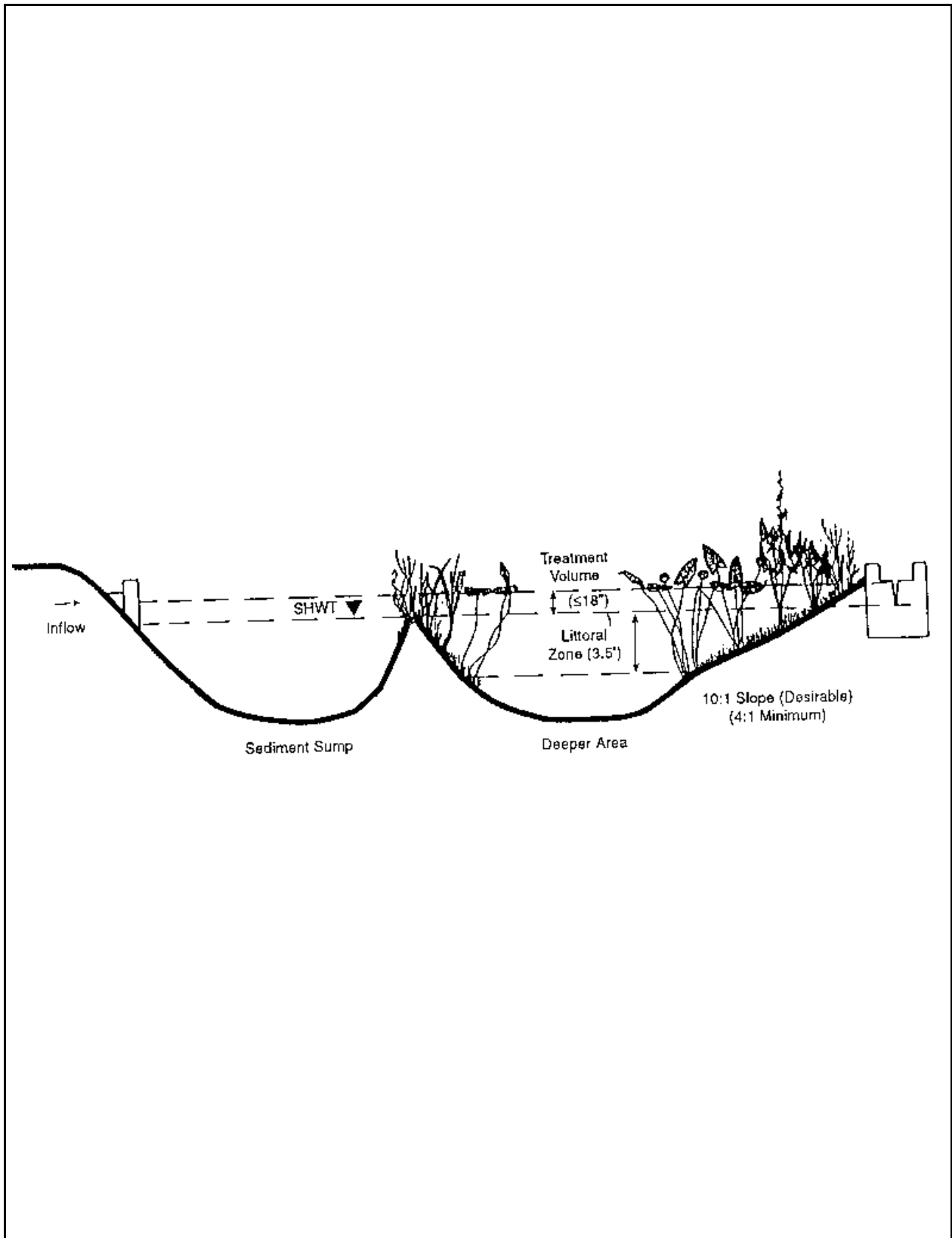

Plate 5.05d Wet Detention System, Pond Configuration - B

Source: SWFWMD Management and Storage of Surface Waters, Permit Information Manual, Vol. 1, Mar. 1988

5.06 UNDERDRAINS AND FILTERS **(SW BMP 3.10)**

Definition

Stormwater underdrain and filtration systems usually consist of a conduit, such as a pipe and/or a gravel filled trench, which intercepts, collects, and conveys stormwater following infiltration and percolation through the soil, suitable aggregate, and/or filter fabric.

Purpose

In Florida, these systems serve one or more of the following purposes:

1. To filter a portion (normally 0.5 to 1.0 inch)(13 - 25 mm) of the stormwater runoff contained in detention facilities prior to discharge to surface waters
2. To alter the soil environment in treatment areas when not suitable for desired vegetation; usually by regulating the period of inundation, the water table elevation, and/or the inflow of shallow ground water.
3. To improve the infiltration and percolation characteristics of the soil in stormwater management facilities when permeability is restricted due to soil texture or high water table conditions.

Conditions where practice applies

Underdrain systems and filters are used in combination with a variety of stormwater management measures where space, soil permeability, and/or water table conditions dictate that sufficient pollutant removal cannot normally be achieved through natural percolation, sedimentation, or other means. A gravity outlet must be available or pumping must be provided. A pumped discharge will usually require a permit from FDEP and/ or the local Water Management District.

Construction Specifications

All drains shall be laid to line and grade, surrounded by at least three inches (8 cm) of washed gravel, and wrapped in filter fabric. The trench bottom must be uniformly smooth, and either undisturbed soil or properly compacted fill, especially if the trench is cut into rock. Joints between sections of rigid pipe shall not exceed 1/4 inch (3 mm). Ends of pipe shall be capped, or preferably connected to clean-outs. Backfill shall be as outlined in EARTHWORK SPECIFICATIONS - Section 5.00.

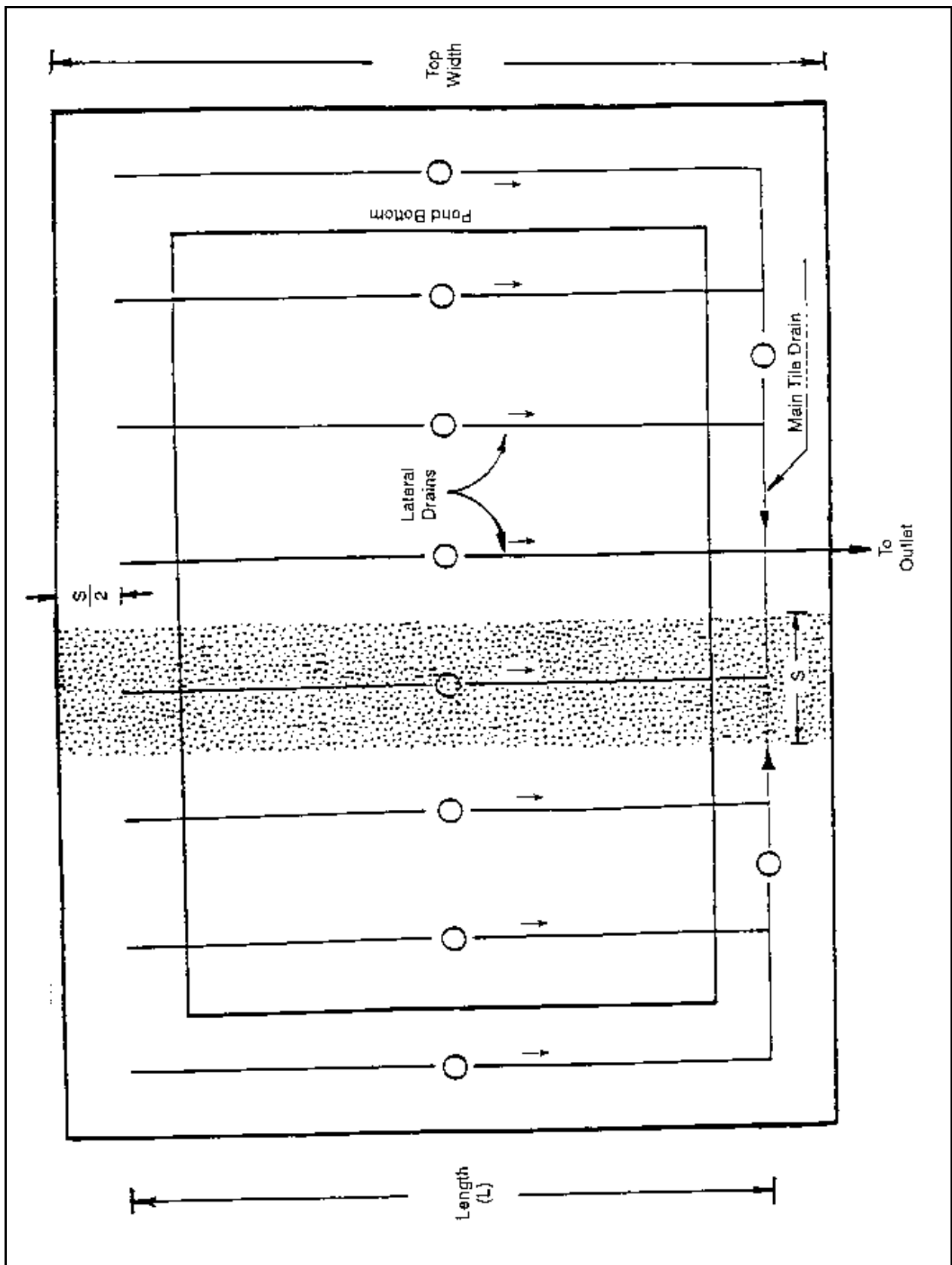

Plate 5.06a Sketch of Typical Underdrain System Illustrating the Area Served by Laterals.
 Source: NRCS

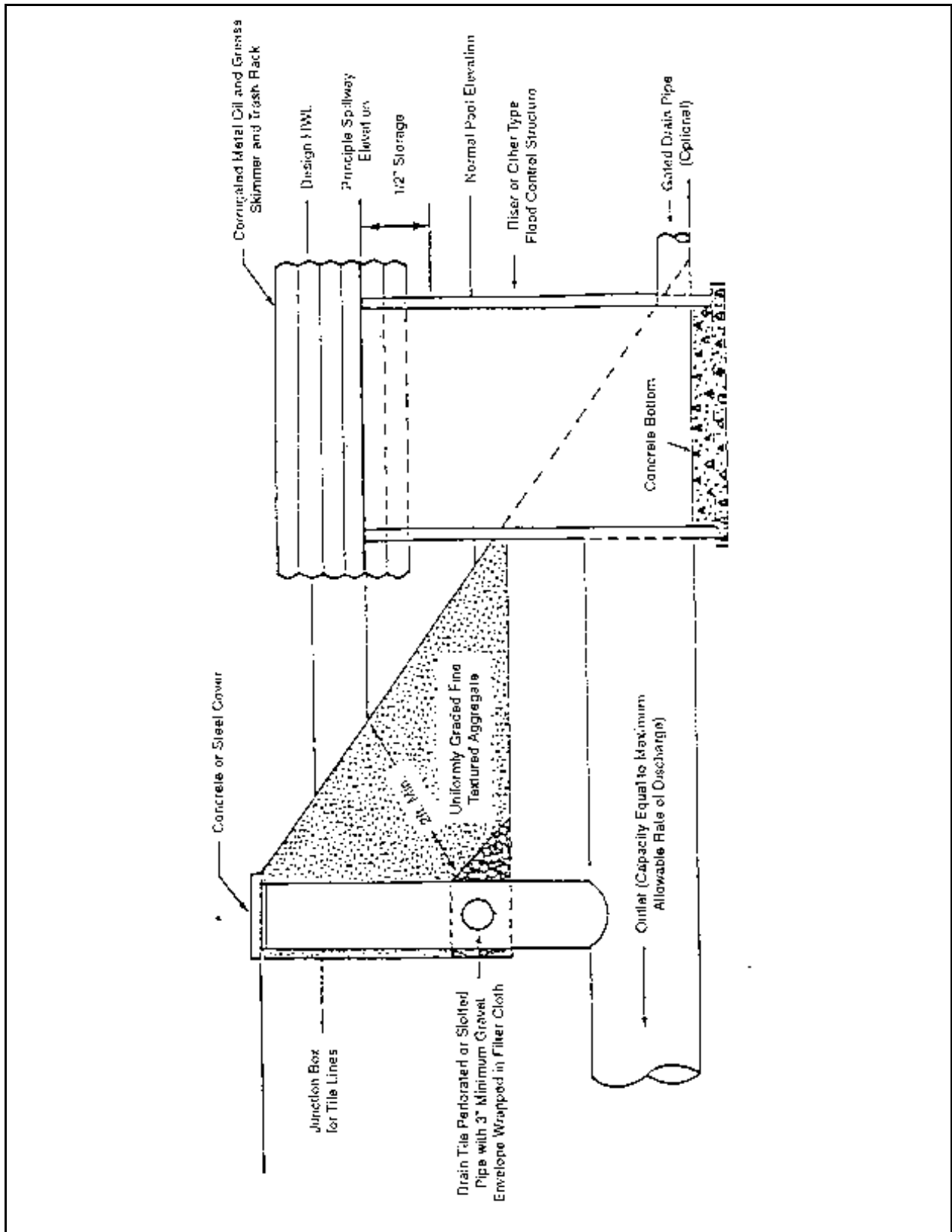

Plate 5.06b Cross-Section of Stormwater Discharge Structure with "Mixed Media" Bank Filter System
 Source: NRCS

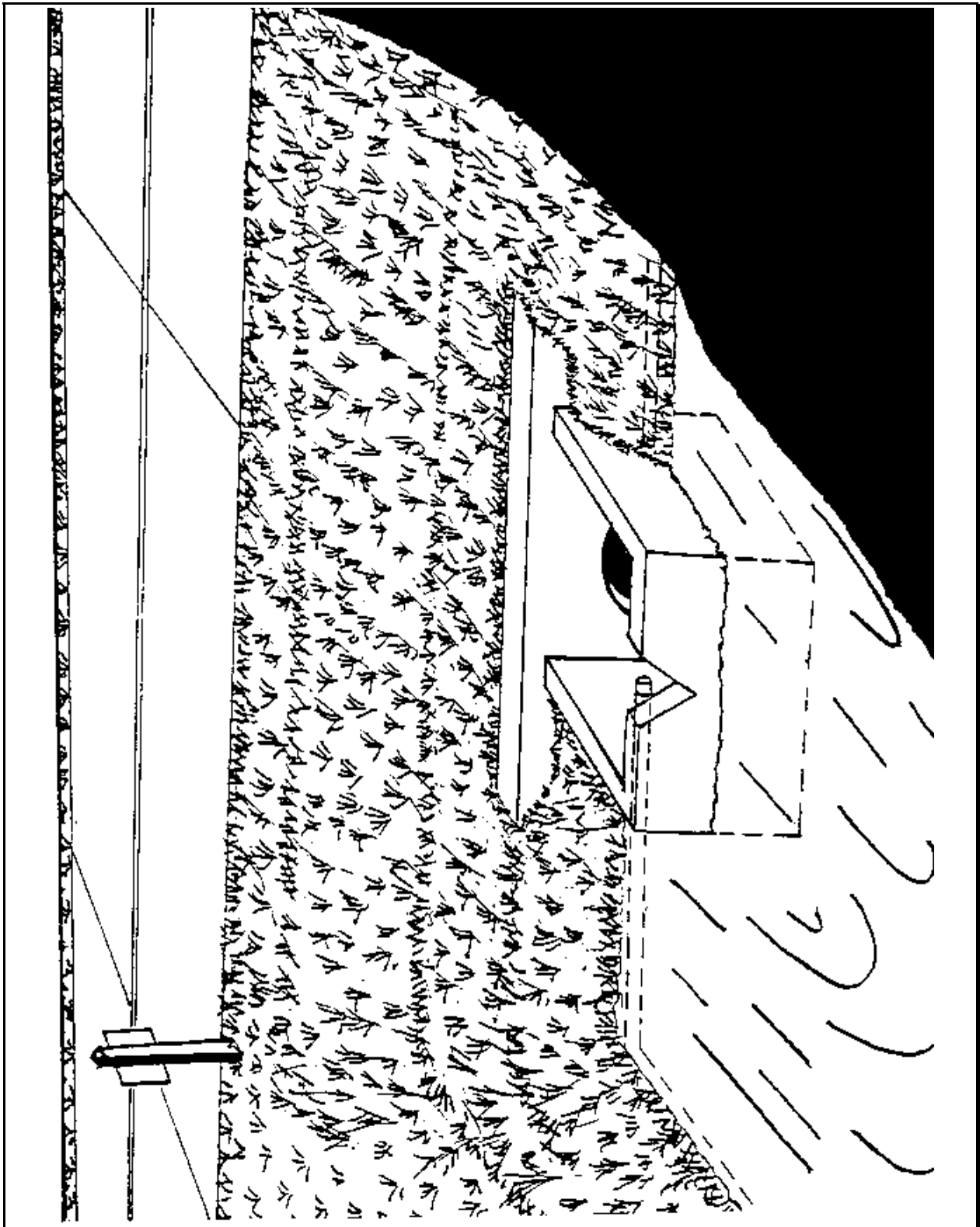

Plate 5.06c Illustration of Typical "Natural Soil" Bank Filtration System with Box Inlet Drop Spillway and "V" Notched Weir (Wet Detention Facility)

Source: NRCS

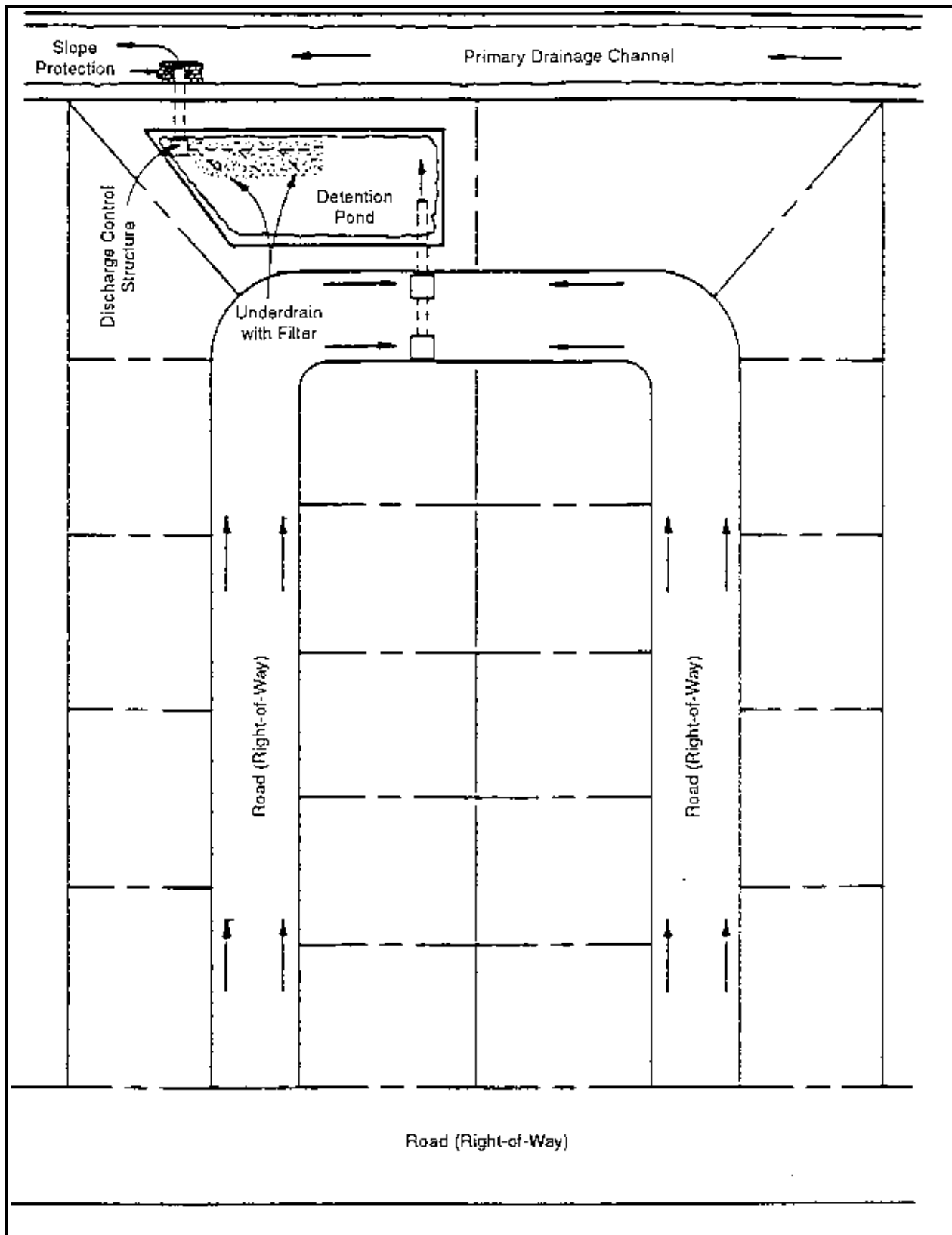

Plate 5.06d Typical Subdivision Layout Showing On-Line Detention Pond and Outfall
Source: Pinellas Park Water Management District

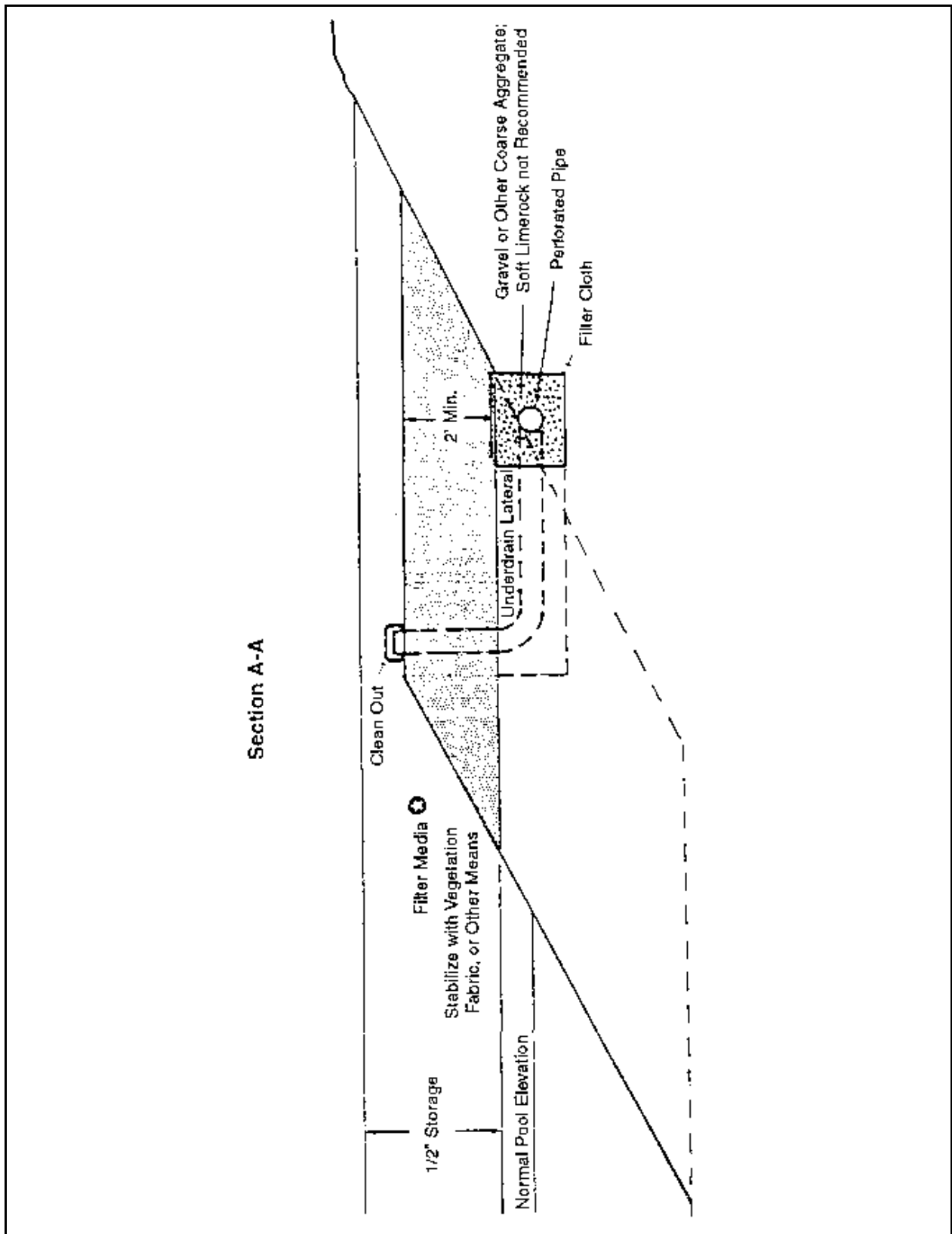

Plate 5.06e Typical Cross-Section of Elevated Bank Filtration Bed used in Conjunction with Wet Stormwater Detention Facilities

Source: NRCS

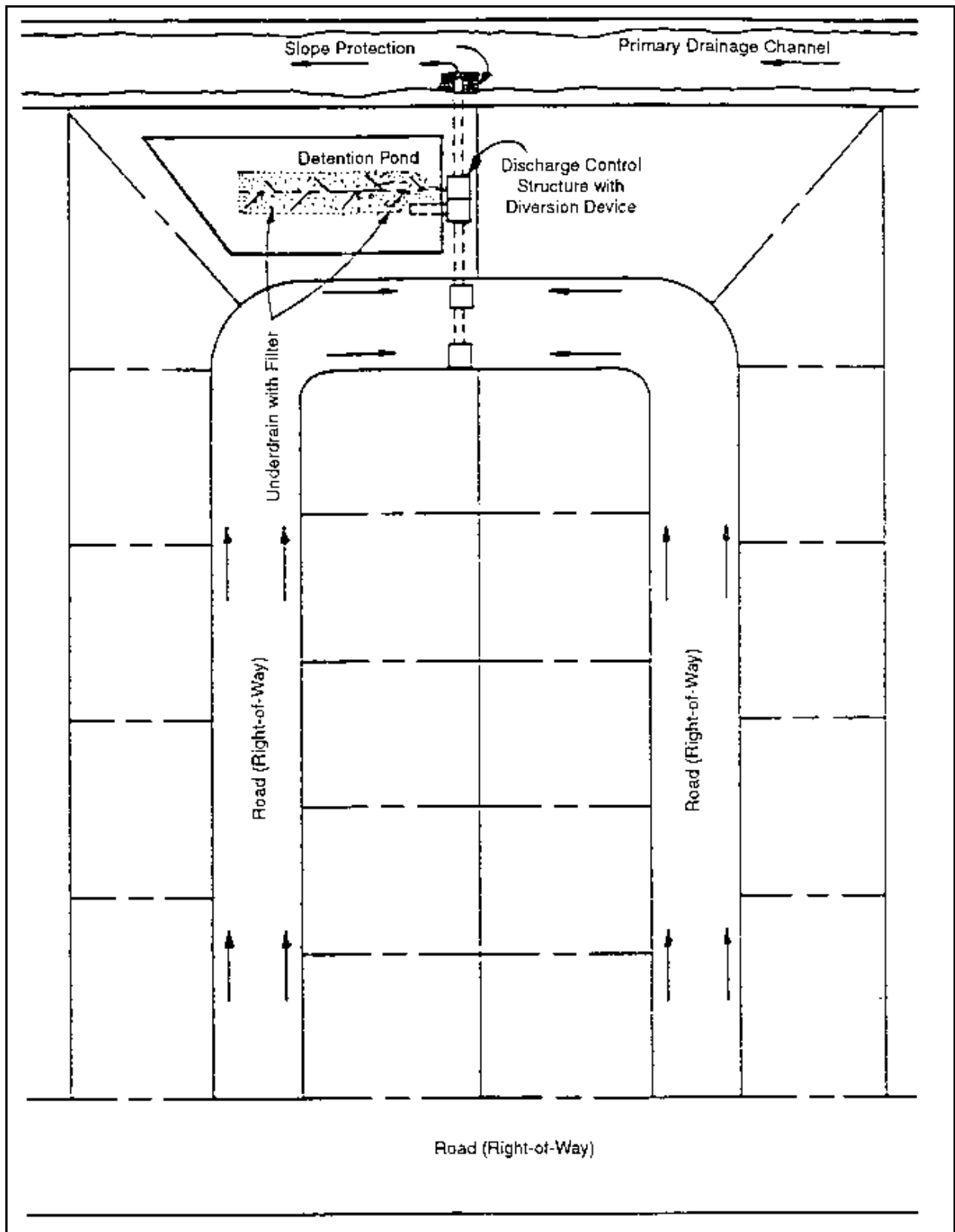

Plate 5.06f Typical Subdivision Layout Showing Off-Line Detention Pond and Outfall
Source: Pinellas Park water Management District

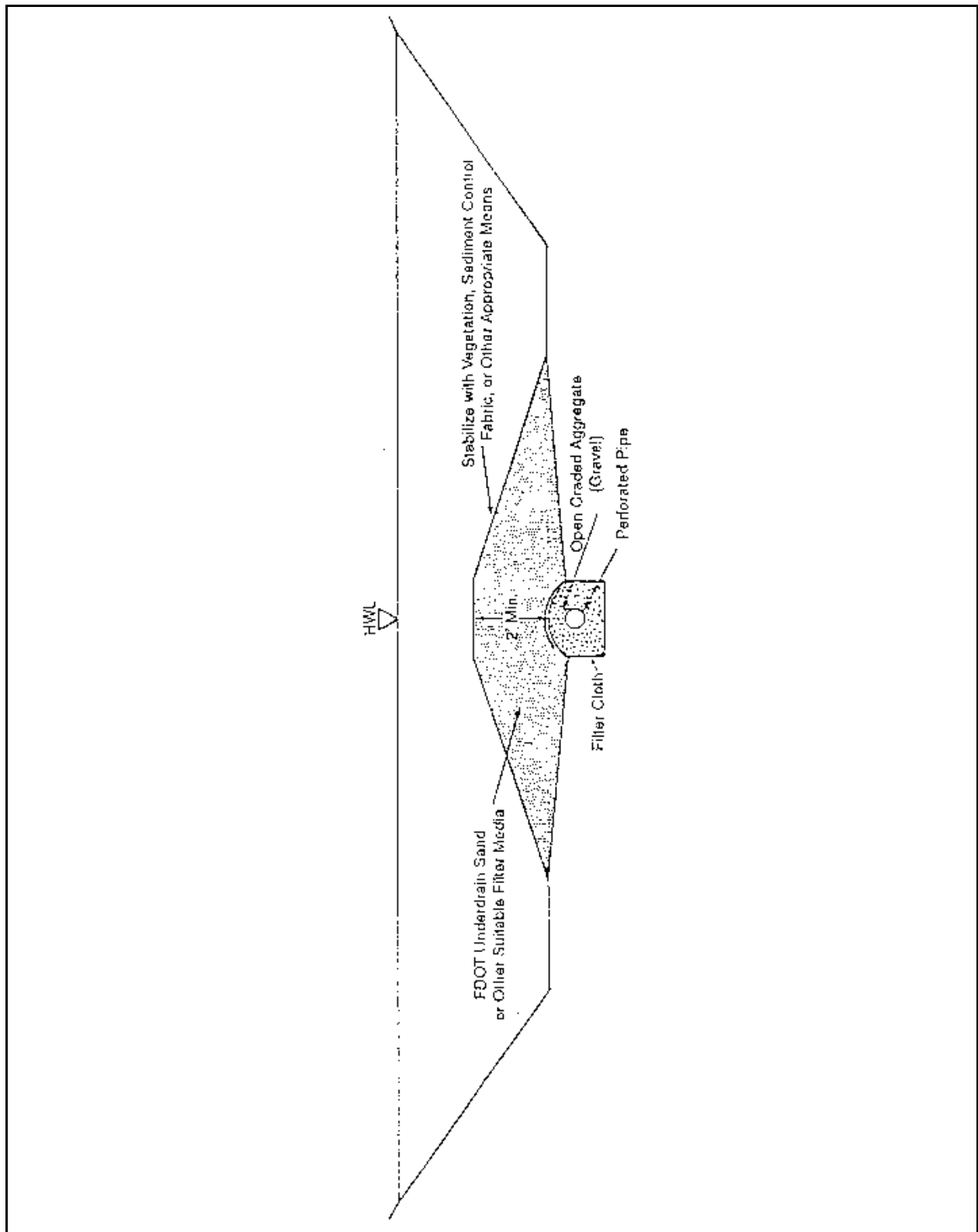

Plate 5.06g Typical Cross-Section of Elevated Sand Filter for Stormwater Treatment used in Conjunction with Dry Detention Facility

Source: NRCS

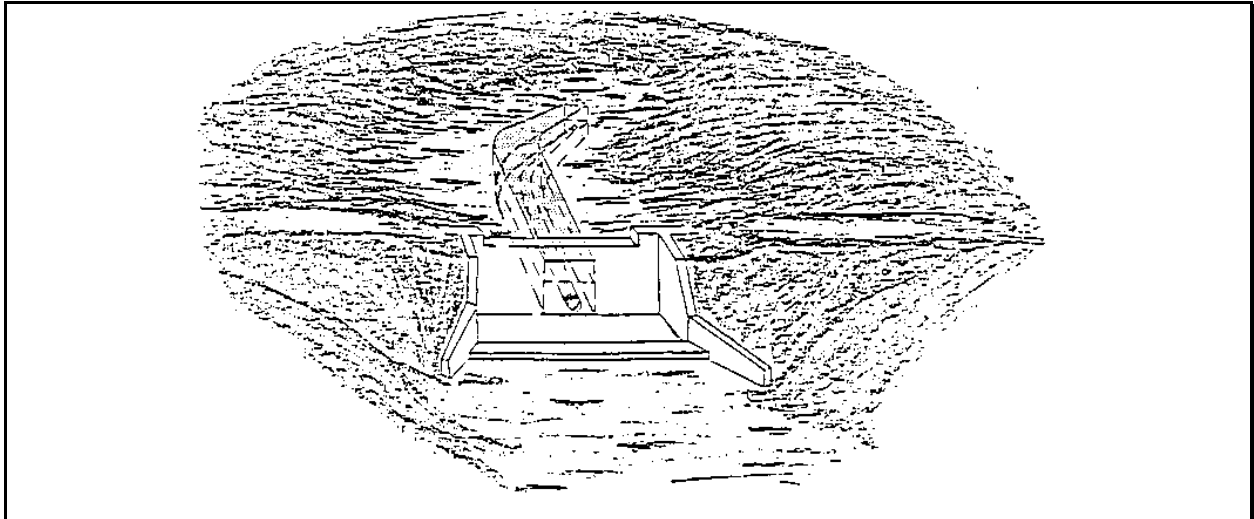

Plate 5.06h Illustration of Bottom Filter or Underdrain System used in Conjunction with Rectangular Weir and Drop Spillway

Source: NRCS

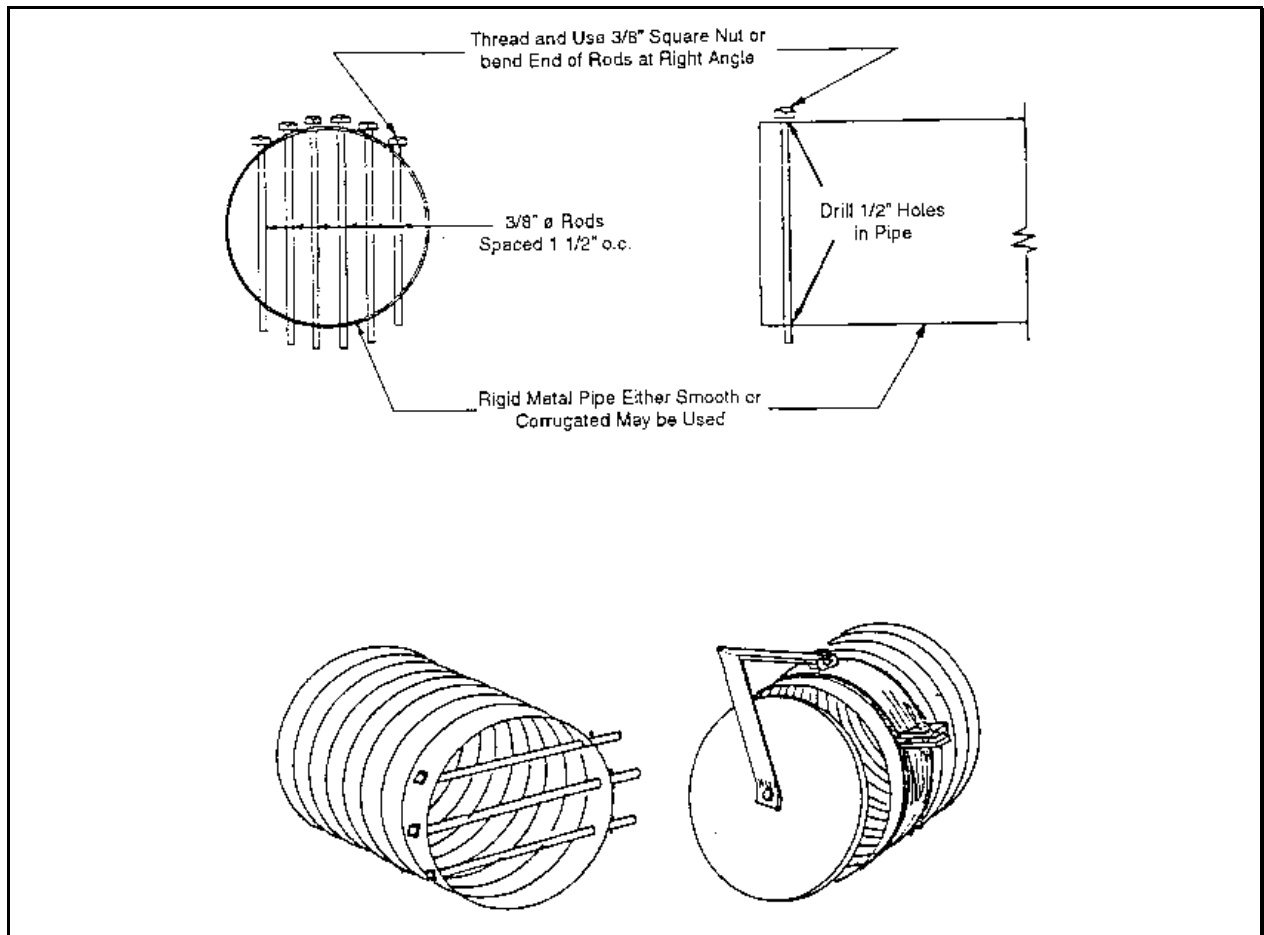

Plate 5.06i Rodent Protection for Outlet Pipes

Source: NRCS Florida

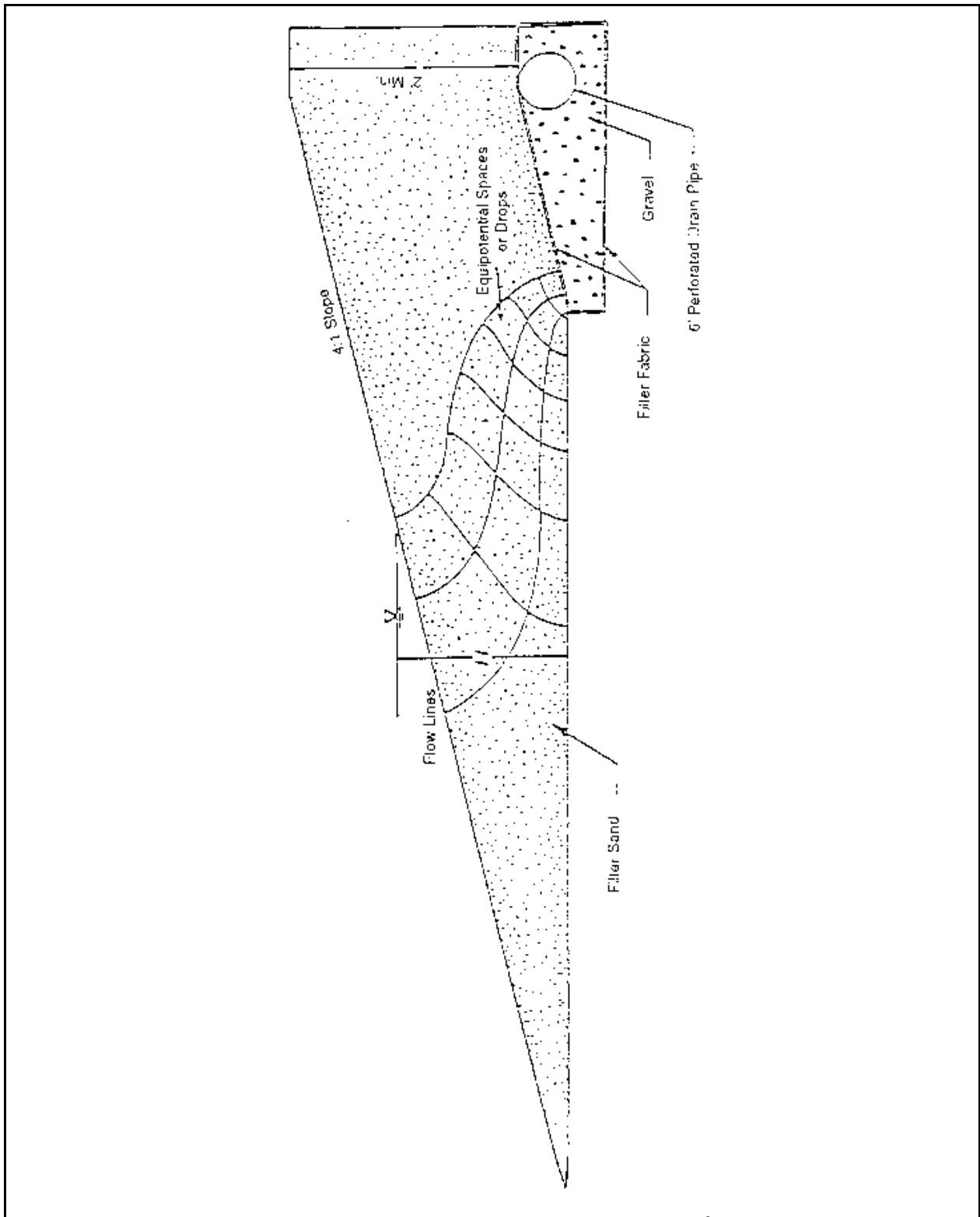

Plate 5.06j Flow Net Diagram Illustrating Lines of Seepage Through a Typical Bank Filtration System.

Source: Heidt and Associates, Inc., Tampa, Florida

5.07 SWALES **(SW BMP 3.04)**

Definition

1. Swales (or grassed waterways) are constructed conveyances shaped or graded to required dimensions and established with suitable vegetation for the safe disposal and treatment of runoff. (See Plate 5.07a)
2. Chapter 403 F.S. further defines the term "swale" by requiring a cross-section with a top width to depth ratio of 6:1 or greater or side slopes of three horizontal to one vertical or flatter. In addition, these rules also specify that the conveyance must only contain standing or flowing water following a storm, be planted with or have stabilized vegetation, and be designed to prevent erosion and reduce pollutant concentration.

Historical Perspective and Purpose

1. Swales are used primarily to convey stormwater safely without erosion.
2. It is the usual practice to use existing topographic draws and rework as needed.
3. With slight modification to increase retention and infiltration of runoff, swales can be used for the treatment and removal of pollutants from stormwater runoff in urban situations.

Conditions Where Practice Applies

All sites where added capacity, vegetative protection, or both, are required to control erosion and/or reduce the pollutant load from concentrated stormwater runoff. As a pretreatment BMP in combination with others BMPs. Example uses include:

1. Outlets for diversions and terraces.
2. Conveyances to, or outlets from, surface and subsurface detention and filtration systems.
3. To convey and treat stormwater collected along roadways or discharged from residential buildings, yards, and vehicle use areas.
4. To rehabilitate or stabilize natural draws carrying concentrations of runoff.
5. To provide for, or improve, percolation and treatment of stormwater.
6. As pretreatment practices to reduce stormwater pollutant loads before conveying stormwater to other management practices.

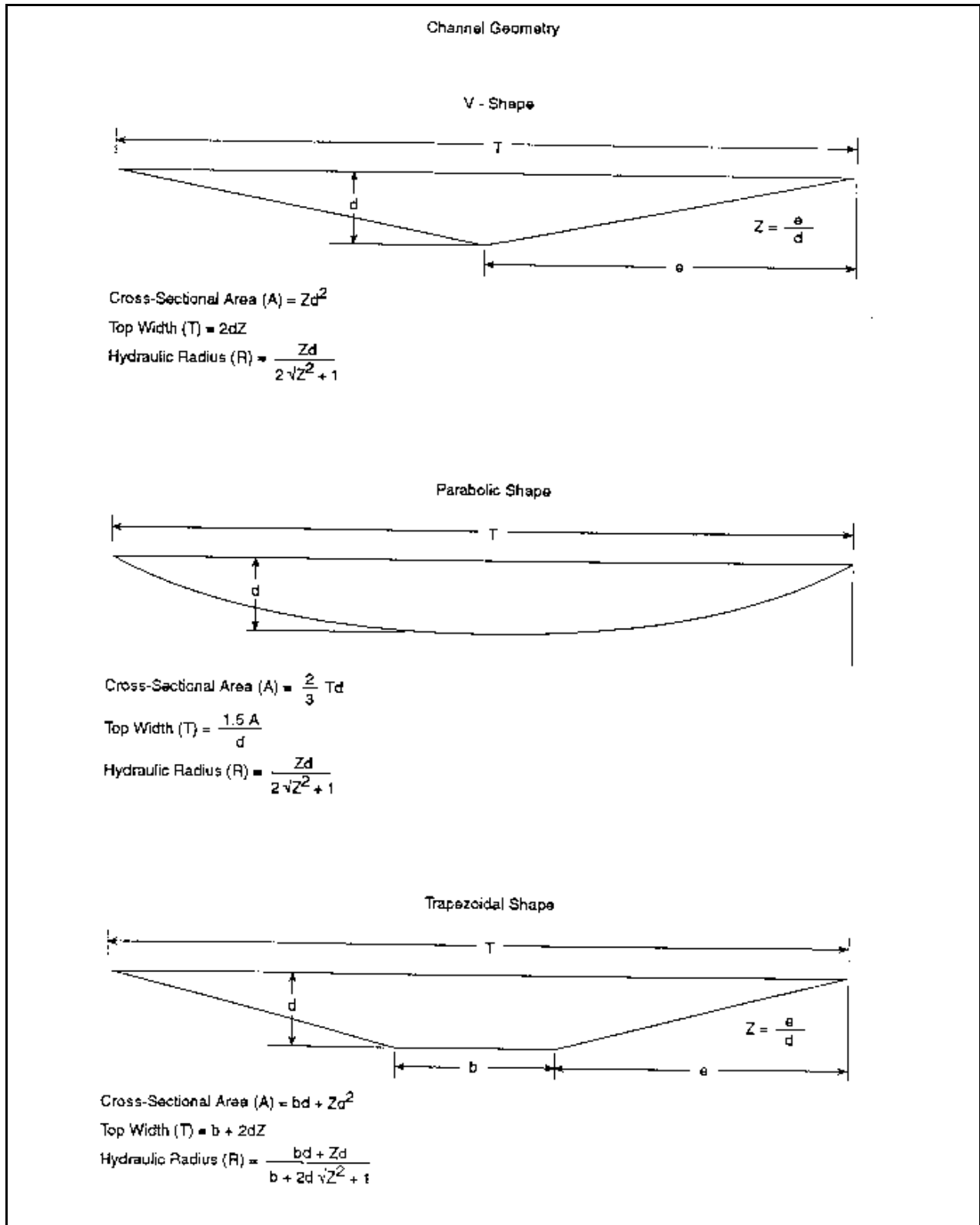

Plate 5.07a Typical Waterway Shapes and Mathematical Expressions for Calculating Cross-Sectional Area, Top Width, and Hydraulic Radius

Source: NRCS

Construction Specifications

Equipment

Many kinds of farming and construction equipment can be used for building grassed swales. However, it may be necessary to use equipment that can load and transport the excavated material to locations where it is needed. These points of need might be low spots in the surrounding area or washes in the conveyance that need filling. Small scrapers that can be pulled by farm tractors are satisfactory units for construction. However, large scrapers, bulldozers, and road graders are excellent types of equipment for constructing these systems and may be more efficient.

Site Preparation

The swale should be staked for construction. All trees, stumps, brush and similar material should be removed from the site and disposed of in such manner as to not interfere with proper functioning of the system. Design and construction survey notes should be kept according to standard engineering practice.

Excavation

The soil removed from the swale should be deposited where it will not interfere with flow of water into the swale. Normally it can be used to fill low spots or build diversions to keep runoff from the swale during vegetation establishment.

The topsoil should be saved and spread in the constructed swale if necessary to assure establishment of a good vegetative cover. When this is done, the swale should be over-excavated to allow for replacement of the topsoil without encroaching on the design cross section.

Establishing Vegetation

The method used to establish grass in a swale will depend upon the severity of the conditions encountered. The methods available for grass establishment are:

- 1.a Seeding with straw mulch and tack coat.
- 1.b Sprigging with bermudagrass.
2. Seeding with straw mulch and jute mesh or erosion netting.
3. Sodding.

Consult Table 5.07 to choose the correct grass establishment technique. For each establishment technique, if any one of the four conditions is exceeded, the next establishment technique below must be used.

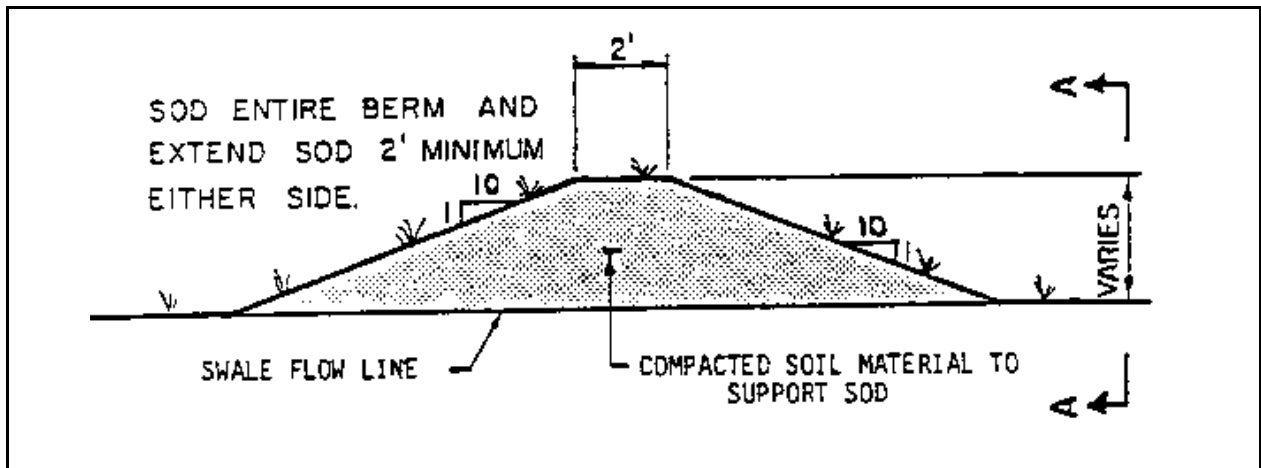

Plate 5.07b Typical Swale Block Cross-Section

Source: NRCS

TABLE 5.07 GRASS ESTABLISHMENT ALTERNATIVES

<u>Establishment Technique</u>	<u>Conditions</u>
1.a Seeding with straw mulch and tack coat.	1. Slopes less than 5%
1.b Establishing bermudagrass by sprigging.	2. Velocity less than 3 ft (1 m) /sec.
	3. Majority of drainage can be diverted away from channel during germination and establishment
	4. Erosion resistant soils
2. Seeding with straw mulch and jute mesh or erosion netting.	1. Slopes less than 5%
	2. Velocity less than 5 ft (1.5 m)/sec.
	3. Majority of the drainage can <u>not</u> be diverted away from channel during germination and establishment
	4. Moderately erodible soil
3. Sodding	1. Slopes greater than 5%
	2. Velocity between 5 and 6 ft (1.5 - 1.8 m) /sec
	3. Majority of drainage can not be diverted away from channel during germination and establishment
	4. Highly erodible soil.

Grass establishment details:

- 1.a Seeding with straw mulch and tack coat. All seeding shall be done in accordance with PERMANENT SEEDING (ES BMP 1.66). When mulching, use 2 tons/acre (4.4 t/ha) small grain straw with an acceptable tacking agent. Refer to MULCHING - Section 6.75 (ES BMP 1.75).

- 1.b. Bermudagrass establishment by sprigging. Establish bermudagrass in accordance with BERMUDAGRASS ESTABLISHMENT - Section 6.68 (ES BMP 1.68). Irrigation water must be available during the first 4 weeks. Divert drainage away from the channel during the first 3 weeks of the establishment period by using temporary dikes, silt fencing, or straw bale barriers.

Seeding with straw mulch and jute mesh or erosion netting. In addition to 1.a above, straw mulch will be secured with netting. If using jute mesh, use only 1 ton/acre (2.2 t/ha) small grain straw, evenly distributed. If using a light plastic or paper erosion netting, 1-1/2 to 2 tons/acre (3.3 - 4.4 t/ha) of straw is appropriate. Care should be taken to staple the mesh or netting according to specifications in MULCHING - Section 6.75 (ES BMP 1.75).

Mats and Blankets. Many type of erosion control mats and blankets, used alone, are also acceptable mulches for the establishment of swales. Some of these products are also pre-seeded.

3. Sodding. When using strip sod, follow recommendations in SODDING - Section 6.67 (ES BMP 1.67), Installation, part D. Another suitable product is rolled sod, which comes on rolls 2 - 5 ft. (60 - 150 cm) wide and 50 - 100 ft. (15 - 30 m) long. The sod is grown through a plastic mesh which offers additional strength and erosion resistance.

The swale and its outlet shall be protected against erosion by vegetative means as soon after construction as practical and **before** diversions or other channels are connected to them.

Details for Swale Block Construction

Swale blocks may be constructed using a variety of materials including wood, concrete, asphalt, metal, natural soil, or a mixture of each. The most common application is the use of native in place soil fashioned in the form of a low berm. Regardless of the material or materials chosen to form the restriction the designer should take proper precautions to ensure that the facility is not subject to undercutting and erosion, especially along its toe.

A typical cross section of a berm type system is shown Figure 5.07b. Research conducted by the University of Central Florida (UCF) indicates that three swale block systems still existed for more than two years after their construction. Wash out did not occur even though three storms greater than three inches (8 cm) were recorded during this period.

Swale block height should be limited to 1.5 feet (45 cm) for public safety and roadway subgrade protection. It is also recommended that the following guidelines be applied to ensure good structural integrity and easy maintenance (mowing).

1. The front and back slope of the structure should not be steeper than ten feet horizontal to 1 ft. vertical unless pavement or other equally stable material is used to protect the berm from erosion during overflow conditions.
2. Berms should be constructed of clean stable material suitable for the construction of

embankments. The material should be free from tree roots, construction debris and other extraneous material. Clayey sand, which was mechanically compacted was used by the UCF researchers. Inorganic silts, organic silts, and organic clays, as well as peat or other highly organic soil should not be considered. The designer should also be aware that vegetative cover may be hard to establish when using highly permeable material, such as FDOT washed sand.

3. Sod should be used to protect these embankments from erosion. Protection should be provided extending at least two feet (60 cm) from the toe of the berm along both the face and back slope of the structure.

5.08 STORMWATER CONVEYANCE CHANNEL **(ES BMP 1.35)**

Definition

A permanent, designed waterway, shaped and lined with appropriate vegetation or structural material to safely convey excess stormwater runoff away from a developing area.

Purpose

To provide for the conveyance of concentrated surface runoff water without damage from erosion.

Conditions Where Practice Applies

Generally applicable to man-made-channels, including roadside ditches, and intermittent natural channels that are modified to accommodate increased flows generated by land development. This practice is not applicable to major, continuous flowing natural streams.

Construction Specifications

General

1. All trees, brush, stumps, roots, obstructions and other unsuitable materials shall be removed and properly disposed of.
2. The channel shall be excavated or shaped to the proper grade and cross-section, taking into account the type of channel lining.
3. All fills shall be well compacted to prevent unequal settlement.
4. Any excess soil shall be removed and properly disposed of.

Grass-lined channels

Grass shall be established in accordance with GRASSED WATERWAYS AND SWALES - Section 5.07 (SW BMP 3.04) and Chapter 6 of this manual.

Concrete-lined channels

Concrete-lined channels must be constructed in accordance with all applicable FDOT specifications. Following is a summary of those specifications provided as a guide only:

1. The subgrade should be moist at the time the concrete is poured.

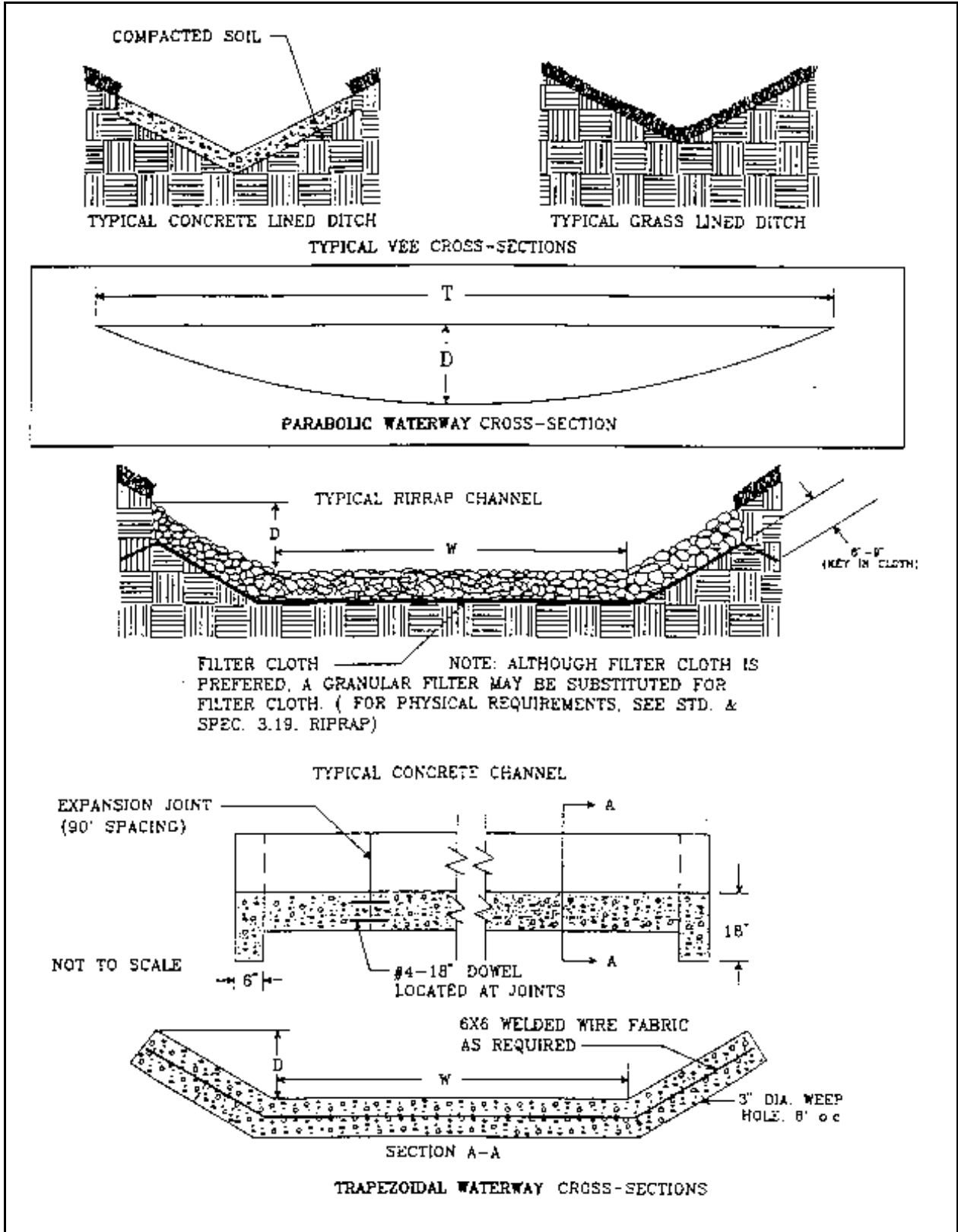

Plate 5.08a Typical Waterway Cross-Sections
 Source: Virginia DSWC

2. Traverse joints for crack control should be provided at approximately 20-feet (6 m) intervals and when more than 45 minutes elapses between the times of consecutive concrete placements. All sections should be at least 6 feet (1.8 m) long. Crack control joints may be formed by using a 1/8-inch (3 mm) thick removable template, by scoring or sawing to a depth of at least 3/4 inch (19 mm) or by an approved "leave in" type insert. (See Plate 5.08a)
3. Expansion joints shall be installed every 100 feet (30 m).

Riprap-lined channels

Riprap shall be installed in accordance with RIPRAP - Section 5.16 (ES BMP 1.37). (See Plate 5.08b)

Gabion-lined channels

Gabions and reno mattresses shall be installed in accordance with GABIONS AND RENO MATTRESSES - Section 5.19

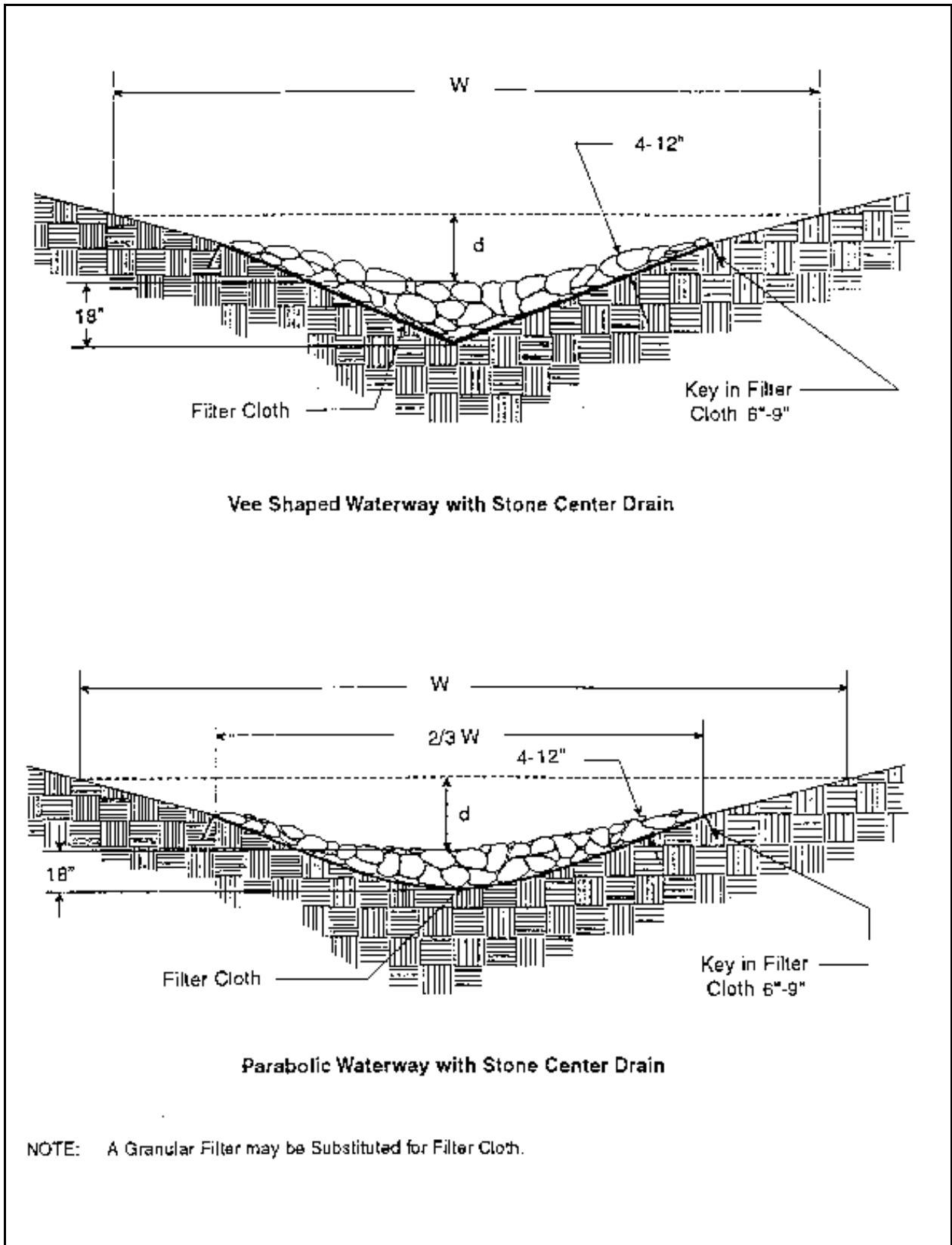

Plate 5.08b Typical Stone-Lined Waterways
 Source: NRCS

5.09 PAVED FLUME **(ES BMP 1.31)**

Definition

A permanent concrete-lined channel constructed on a slope (See Plate 5.09a).

Purpose

To conduct stormwater runoff safely down the face of a slope without causing erosion problems on or below the slope.

Conditions Where Practice Applies

Wherever concentrated stormwater runoff must be conveyed from the top to the bottom of cut or fill slopes on a permanent basis.

Planning Considerations

Paved flumes are used routinely on highway cuts and fills to convey concentrated stormwater runoff from the top to the bottom of a slope without erosion. Fortunately these structures have equal applicability to cut and fill slopes for construction projects other than highways.

Construction Specifications

On steep slopes paved flumes shall be constructed of concrete on undisturbed soil or properly compacted fill. Trenches for anchor lugs and curtain walls shall be dug by hand. The subgrade should be moist during concrete placement. Curtain walls and anchor lugs should be poured monolithic with the flume slab. If conditions dictate, these may be poured separately, provided that a proper construction joint with dowels and keyway is approved by the design professional engineer.

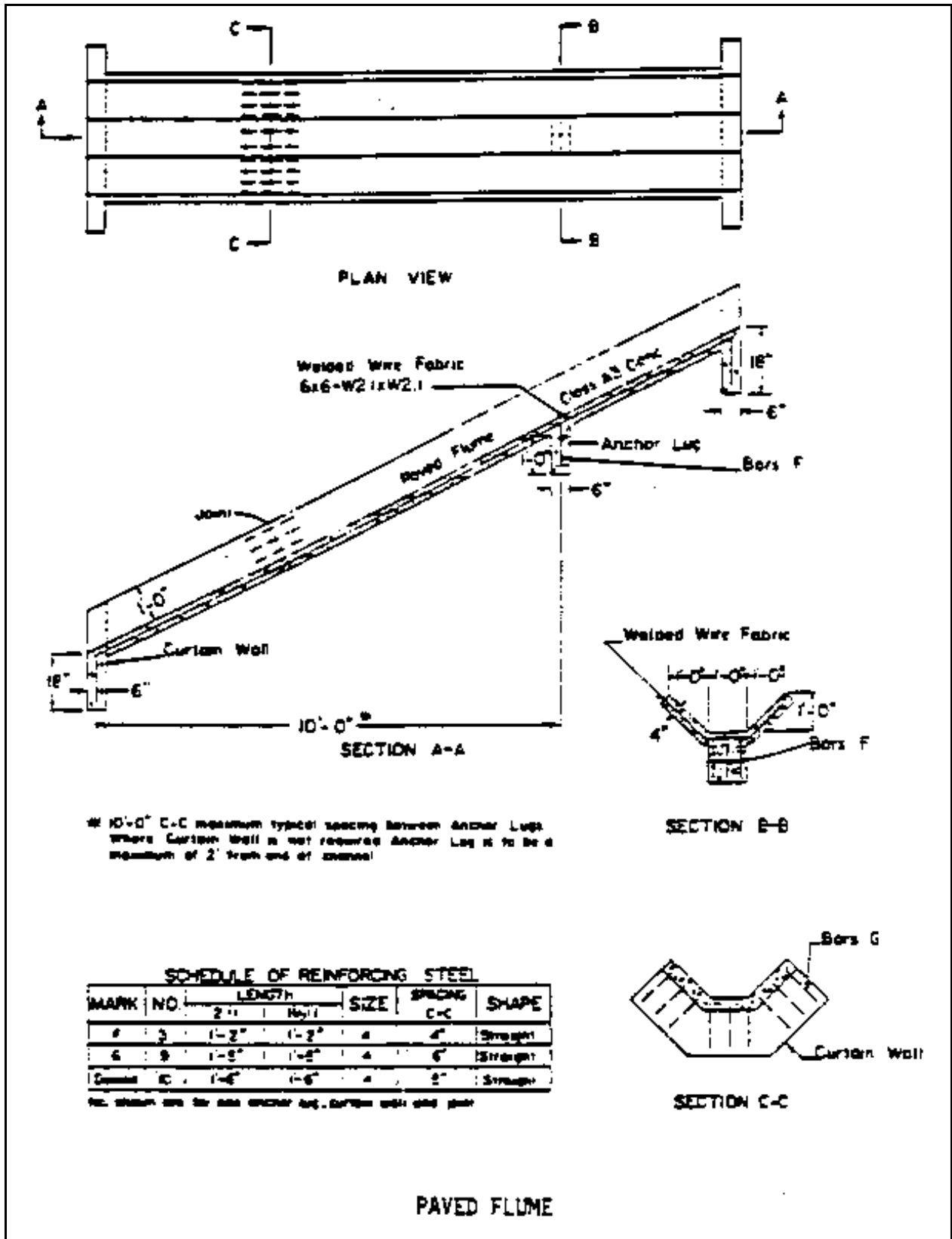

Plate 5.09a Paved Flume

Source: Virginia Department of Highways and Transportation [Road Designs and Standards](#)

5.10 DIVERSION **(ES BMP 1.18)**

Definition

A channel constructed across a slope with a supporting ridge on the lower side.

Purpose

To reduce slope length and to intercept and divert stormwater runoff to stabilized outlets at non-erosive velocities

Conditions Where Practice Applies

1. Where runoff from higher areas may damage property, cause erosion, or interfere with the establishment of vegetation on lower areas.
2. Where surface and/or shallow subsurface flow is damaging upland slopes.
3. Where the slope length needs to be reduced to minimize soil loss.
4. Diversions are applicable only below stabilized or protected areas. They should not be used below high sediment producing areas unless land treatment practices or structural measures, designed to prevent damaging accumulations of sediment in the channels, are installed with or before the diversions.
5. Diversions should not be placed on slopes greater than fifteen percent.

Planning Considerations

Diversions can be useful tools for managing surface water flows and preventing soil erosion. On moderately sloping areas, they may be placed at intervals to trap and divert sheet flow before it has a chance to concentrate and cause rill and gully erosion. They may be placed at the top of cut or fill slopes to keep runoff from upland drainage areas off the slope. They can also be used to protect structures, parking lots, adjacent properties, and other special areas from flooding.

Diversions are preferable to other types of constructed stormwater conveyance systems because they more closely simulate natural flow patterns and characteristics. Flow velocities are generally kept to a minimum. When properly coordinated into the landscape design of a site, diversions can be visually pleasing as well as functional.

As with any earthen structure, it is very important to establish adequate vegetation as soon as possible after installation. It is equally important to stabilize the drainage area above the diversion so that sediment will not enter and accumulate in the diversion channel.

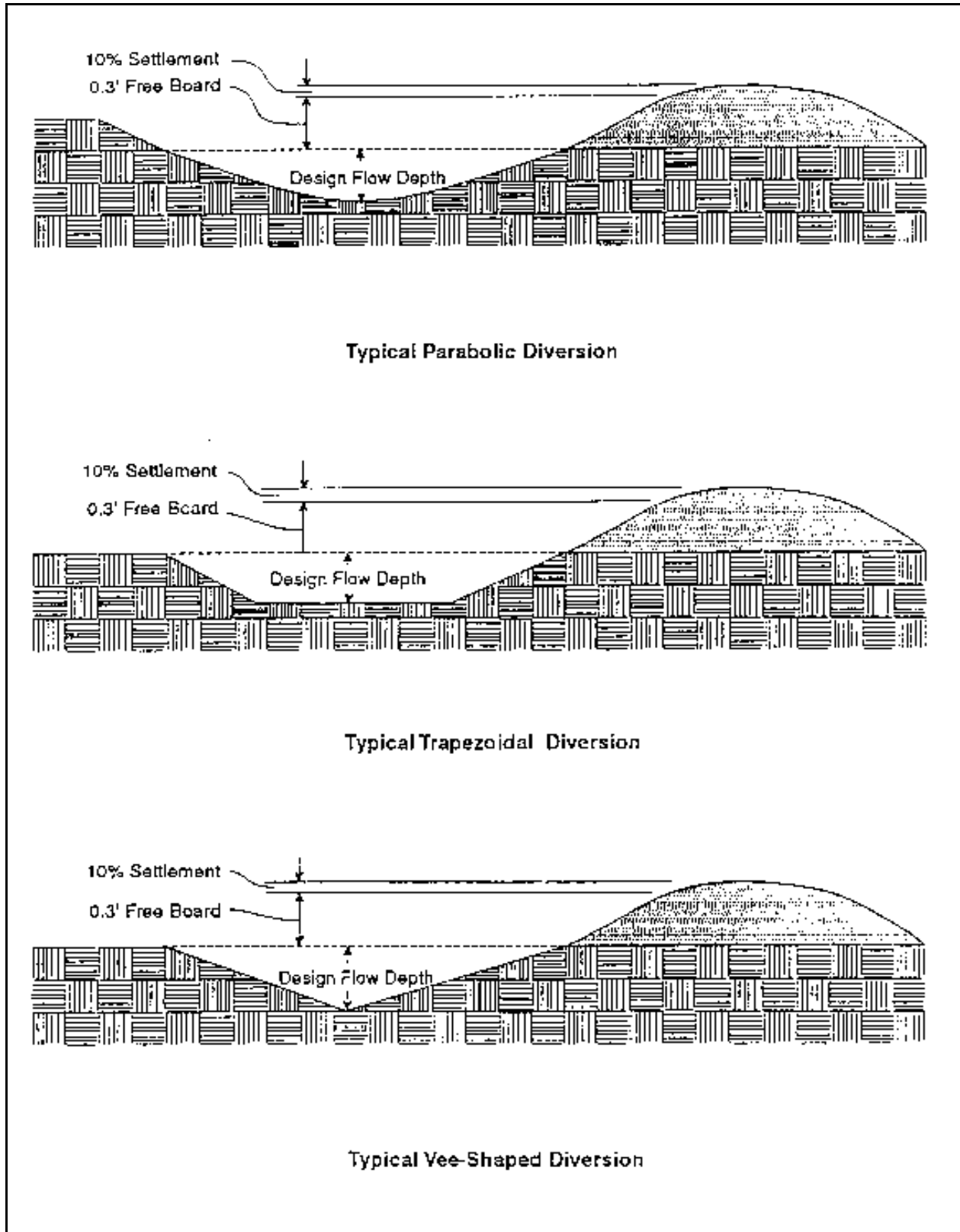

Plate 5.10a Diversions
Source: Virginia DSWC

Diversions should be constructed before clearing and grading operations begin. If used to protect a flat, exposed area, a diversion might be constructed as a dike or berm. Berms made of gravel or stone can be crossed by construction equipment.

Design Criteria

Location

Diversion location shall be determined by considering outlet conditions, topography, land use, soil type, length of slope, seepage planes (where seepage is a problem), and the development layout.

Capacity

1. The diversion channel must have a minimum capacity to carry the runoff expected from a 10-year frequency storm with a freeboard of at least 0.3 foot (10 cm). (See Plate 5.10a)
2. Diversions designed to protect homes, schools, industrial buildings, roads, parking lots, and comparable high-risk areas, and those designed to function in connection with other structures, shall have sufficient capacity to carry peak runoff expected from a storm frequency consistent with the hazard involved.
3. Peak rates of runoff used in determining the capacity requirements shall be as outlined in Chapter 3 of this manual or by other accepted methods.

Channel Design

The diversion channel may be parabolic, trapezoidal, or Vee-shaped and shall be designed and constructed according to STORMWATER CONVEYANCE CHANNELS - Section 5.08 (ES BMP 1.35). (See Plate 5.10a)

Ridge Design

The supporting ridge cross-section shall meet the following criteria (See Plate 5.10a).

1. The side slopes shall be no steeper than 2:1 and shall be flat enough to insure ease of maintenance of the structure and its protective vegetative cover.
2. The width at the design water elevation shall be a minimum of 4 feet.
3. The minimum freeboard shall be 0.3 foot (10 cm).
4. The design shall include a 10 percent settlement factor.

Outlet

Diversions shall have stabilized outlets which will convey concentrated runoff without erosion. Acceptable outlets include PAVED FLUMES - Section 5.09 (ES BMP 1.31), STORMWATER CONVEYANCE CHANNELS - Section 5.08 (ES BMP 1.35), OUTLET PROTECTION - Section 5.15 (ES BMP 1.36), and LEVEL SPREADERS - Section 5.11 (ES BMP 1.40). Outlets shall be constructed and stabilized prior to the operation of the diversion.

Stabilization

1. Unless otherwise stabilized, the ridge and channel shall be seeded and mulched within 15 days of installation in accordance with PERMANENT SEEDING - Section 6.66 (ES BMP 1.66).
2. Disturbed areas draining into the diversion shall be seeded and mulched prior to or at the time the diversion is constructed.
3. Permanent diversions should include a filter strip of close growing grass maintained above the channel. The width of the filter strip, measured from the center of the channel, shall be one-half the channel width plus 15 feet (4.5 m).

Construction Specifications

1. All trees, brush, stumps, debris, and other obstructions shall be removed and disposed of so as not to interfere with the proper functioning of the diversion.
2. The diversion shall be excavated or shaped to line, grade, and cross-section as required to meet the criteria specified herein, free of irregularities, which will impede flow.
3. Fills shall be compacted as needed to prevent unequal settlement that would cause damage in the complete diversion.
4. All earth removed and not needed in construction shall be spread or disposed of so that it will not interfere with the functioning of the diversion.
5. Permanent stabilization of disturbed areas shall be done in accordance with the applicable standard and specification contained in this handbook. Permanent stabilization techniques include PERMANENT SEEDING - Section 6.66 (ES BMP 1.66) and SODDING - Section 6.67 (ES BMP 1.67).

**5.11 LEVEL SPREADER
(ES BMP 1.40)**

Definition

An outlet for dikes and diversions consisting of an excavated depression constructed at zero grade across a slope whereby concentrated runoff may be discharged at non-erosive velocities onto an undisturbed area stabilized by existing vegetation (See Plate 5.11a).

Purpose

To convert concentrated runoff to sheet flow and release it onto an area stabilized by existing vegetation.

Conditions Where Practice Applies

Where sediment-free storm runoff is intercepted and diverted away from graded areas onto undisturbed stabilized areas. This practice applies only in those situations where the spreader can be constructed on undisturbed soil and the area below the level lip is stabilized by natural vegetation. The water should not be allowed to reconcentrate after release.

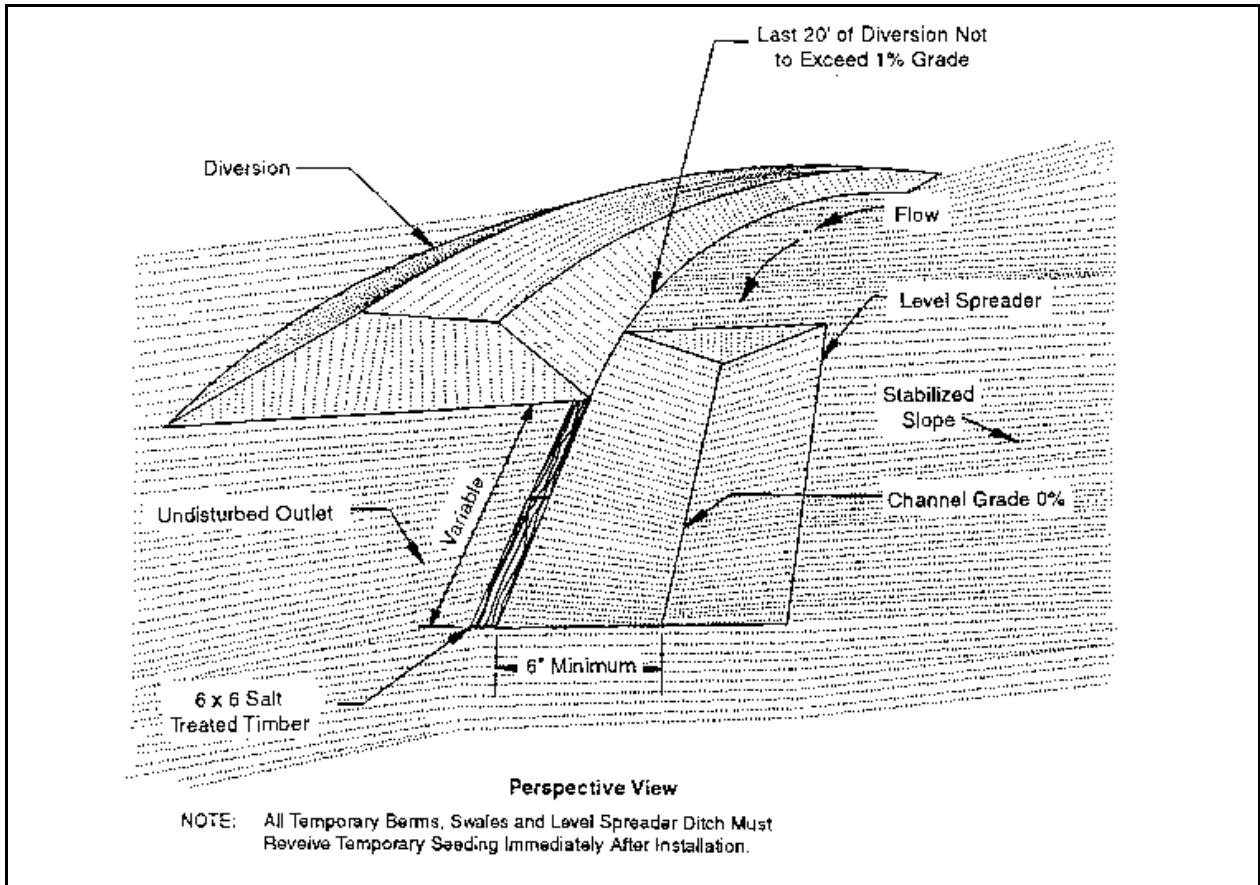

Plate 5.11a Level Spreader

Source: Adapted from North Carolina Erosion and Sediment Control Planning and Design Manual

Construction Specifications

1. Level spreaders must be constructed on undisturbed soil (not fill material).
2. The entrance to the spreader must be shaped in such a manner as to insure that runoff enters directly onto the 0 % channel.
3. The level lip shall be constructed on zero percent grade to insure uniform spreading of storm runoff (See Plate 5.11b).
4. The released runoff must outlet onto undisturbed stabilized areas in sheet flow and not be allowed to reconcentrate below the structure.

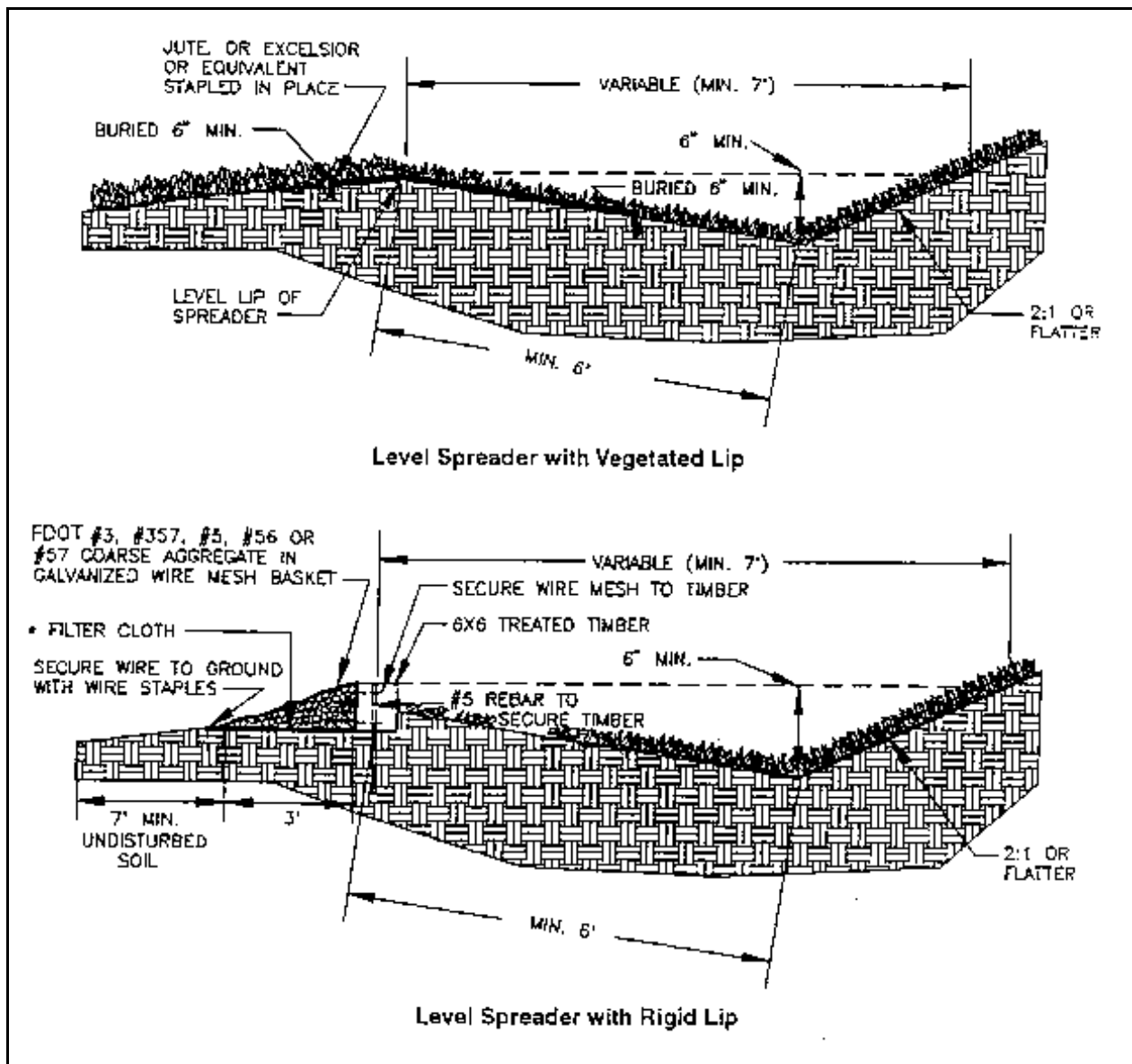

Plate 5.11b Level Spreader Cross-Section

Source: Virginia DSWC and North Carolina Erosion and Sediment Control Planning and Design Manual

5.12 CHECK DAMS **(ES BMP 1.38)**

Definition

Small dams constructed across a swale or other stormwater conveyance.

Purpose

To reduce the velocity of concentrated stormwater flows, thereby reducing erosion of the swale or channel. This practice also traps small amounts of sediment generated in the conveyance itself. However, this is not a sediment trapping practice and should not be used as such.

Conditions Where Practice Applies

This practice is limited to use in small open channels which drain 10 acres (4 ha) or less. It should not be used in a live stream. They are especially applicable to sloping sites where the gradient of waterways is close to the maximum for a grass lining. Some specific applications include:

1. In constructed conveyances or swales to facilitate the establishment of a permanent non-erodible lining, reduce erosion potential, and reduce maintenance.
2. In natural conveyances which are expected to experience increased flows as a result of development activities.

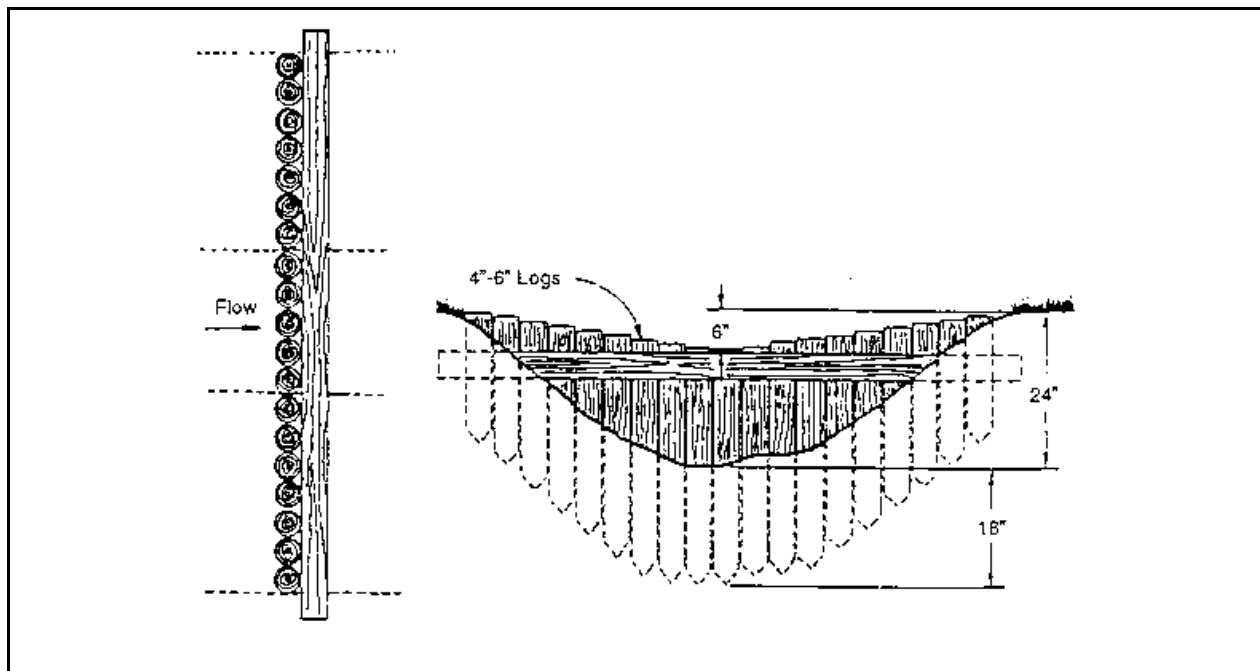

Plate 5.12a Log Check Dam
Source: Virginia SWCC

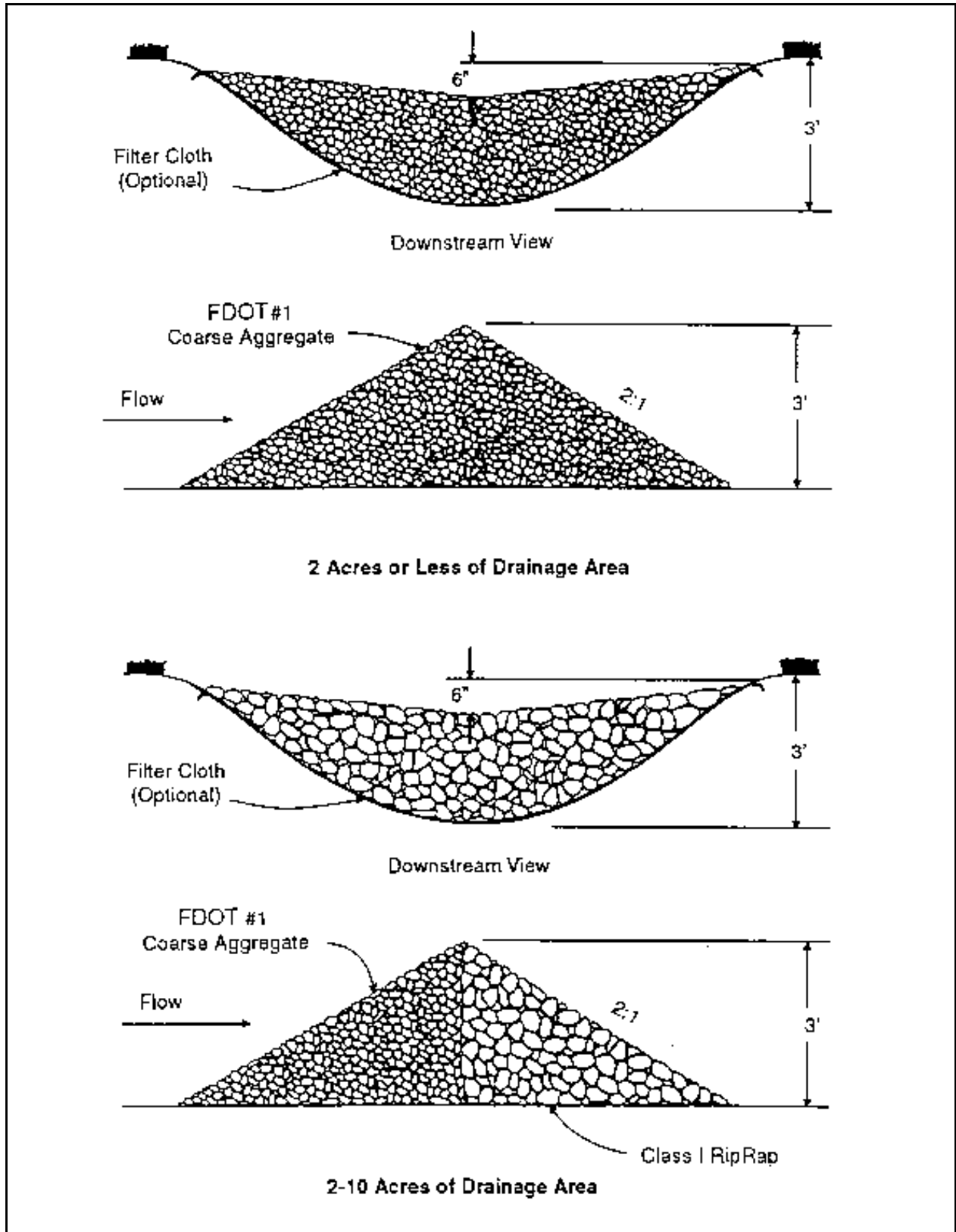

Plate 5.12b Rock Check Dam
Source: Virginia DSWC

Construction Specifications

No formal design is required for check dams. They can be used as temporary or permanent structures. Check dams may be designed by an engineer and appear on the stormwater management plan, or they may be installed by the contractor on an "as required" basis. In any case, the following criteria should be adhered to when constructing check dams.

The drainage area of the ditch or swale being protected should not exceed 10 acres (4 ha). The maximum height of the check dam should be 2 feet (60 cm). The center of the check dam must at least 6 inches (16 cm) lower than the outer edges (see Plate 5.12a). The cross-sections of the dams should be as shown in Plates 5.12a and 5.12b, respectively, for logs and stone. The maximum spacing between the dams should be such that the toe of the upstream dam is at the same elevation as the top of the downstream dam. (See Plate 5.12c).

Stone check dams should be constructed of FDOT Aggregate No. 1 (2- to 3-inch (5 - 8 cm) stone). The stone should be placed according to the configuration in Plate 5.12b. Hand or mechanical placement will be necessary to achieve complete coverage of the ditch or swale and to insure that the center of the dam is lower than the edges.

Log check dams should be constructed of 4 to 6 inch (10 - 15 cm) logs salvaged from clearing operation site, if possible. The logs should be embedded into the soil at least 18 inches (45 cm). The 6 inch (15 cm) lower height required at the center can be achieved either by careful placement of the logs or by cutting the logs after they are in place as in Plate 5.12a. Logs and/or brush should be placed on the downstream side of the dam to prevent scour during high flows.

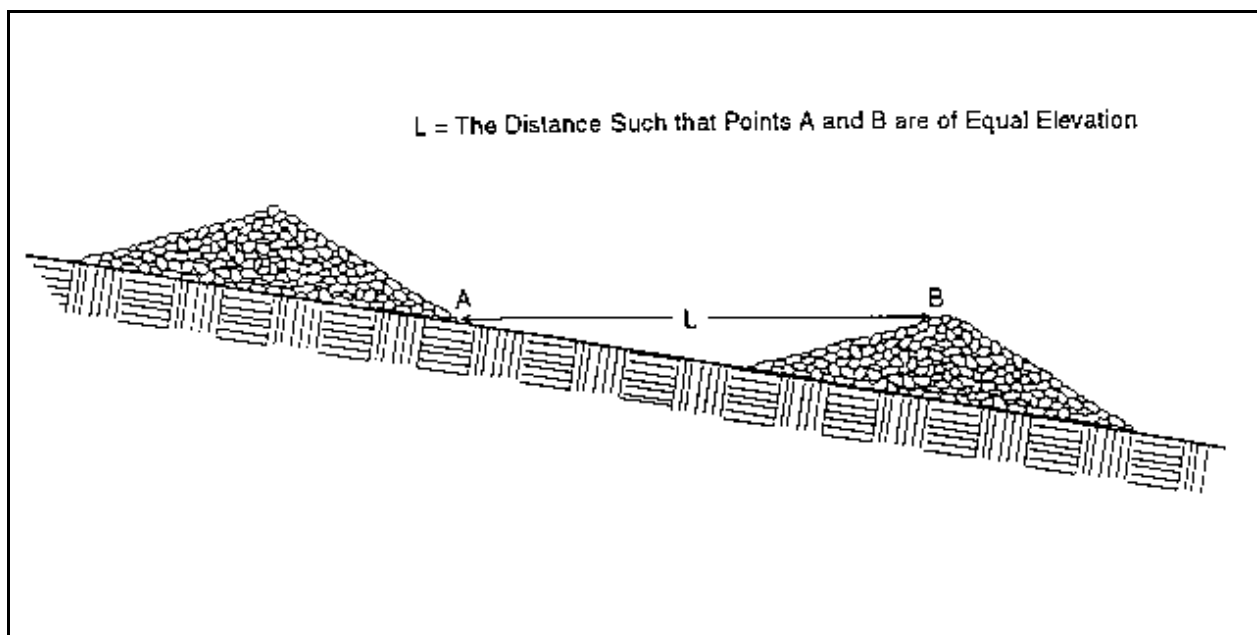

Plate 5.12c Spacing Between Check Dams

Source: Virginia DSWC

This page left intentionally blank

5.14 WATERWAY DROP STRUCTURE **(ES BMP 1.39)**

Definition

A permanent structure or series of structures designed to set up the flow of water down a slope without causing erosion of the channel. (See Plate 5.14a)

Purpose

To prevent channel erosion of waterways by preventing high velocity flows in moderately steep channels.

Conditions Where Practice Applies

1. In constructed channels which must traverse long, relatively steep slopes without large increases in the flow velocity.
2. In natural channels which have long or relatively steep sections and which, as a result of construction activities, are expected to experience channel erosion problems.

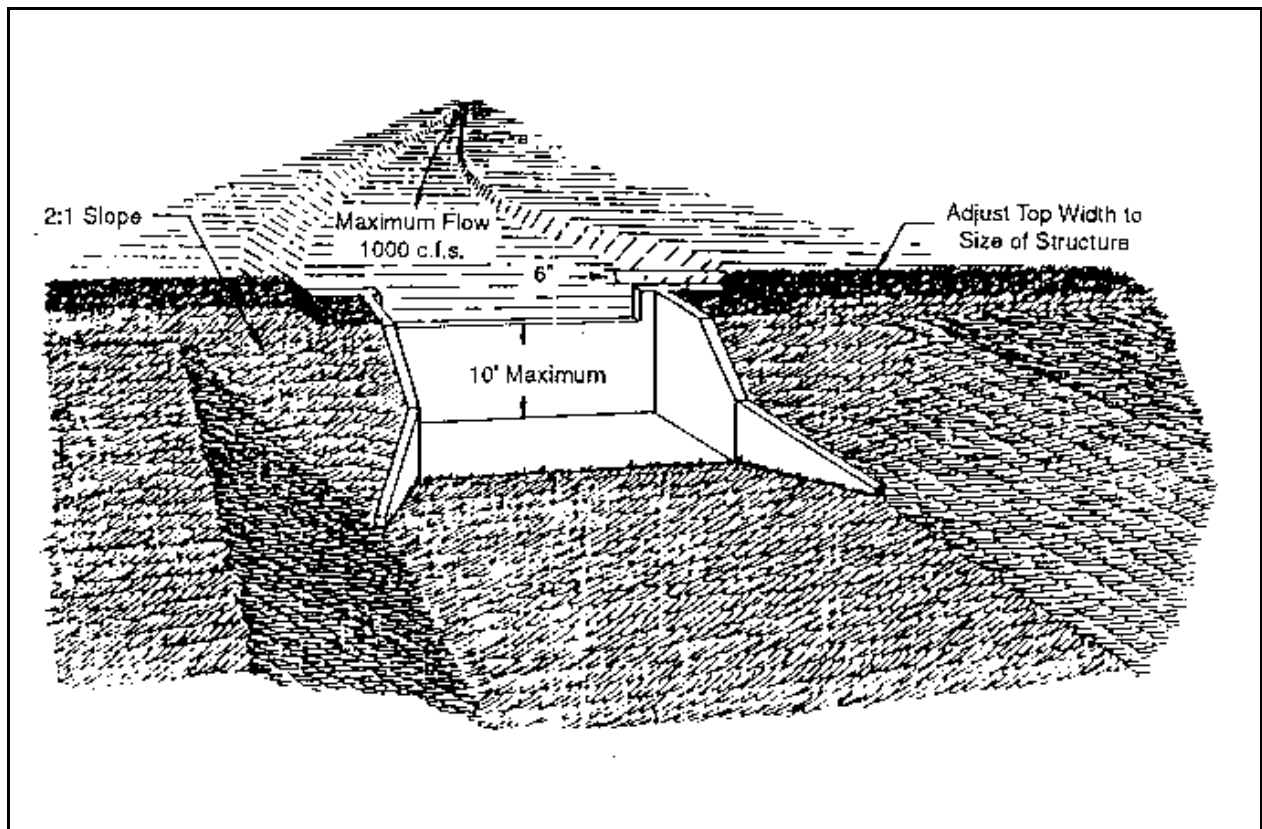

Plate 5.14a Waterway Drop Structure
Source: NRCS

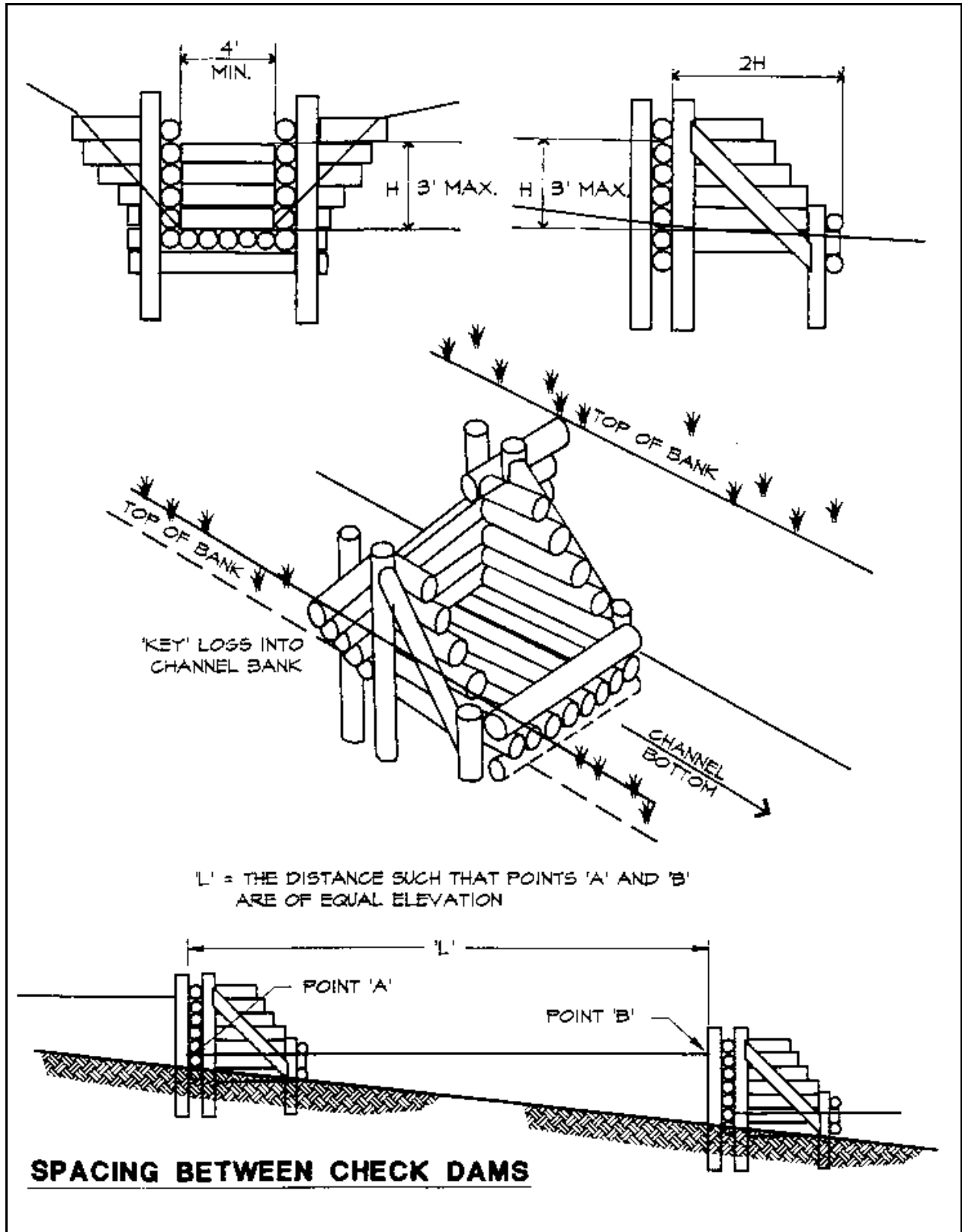

Plate 5.14b Log Grade Stabilization Structure

Source: Erosion Draw

Construction Specifications

1. All runoff should be diverted away from the swale, if possible, during construction.
2. The foundation of the structure shall be well compacted and free of roots, rocks, organic matter and other objectionable material.
3. Logs or timbers shall be embedded into the soil at least 18 in. (45 cm). (See Plate 5.14b)
4. Pouring of concrete for the structure shall be done in a continuous operation. (See Plate 5.14c)
5. Backfill around the structure shall be hand-compacted in 4-inch (10 cm) layers.
6. The embankment shall be constructed according to the specifications for sediment basin embankments.
7. The embankment and all other disturbed areas shall be seeded within 15 days of construction.
8. All necessary precautions shall be taken to prevent excess erosion and sedimentation during construction of the structure.

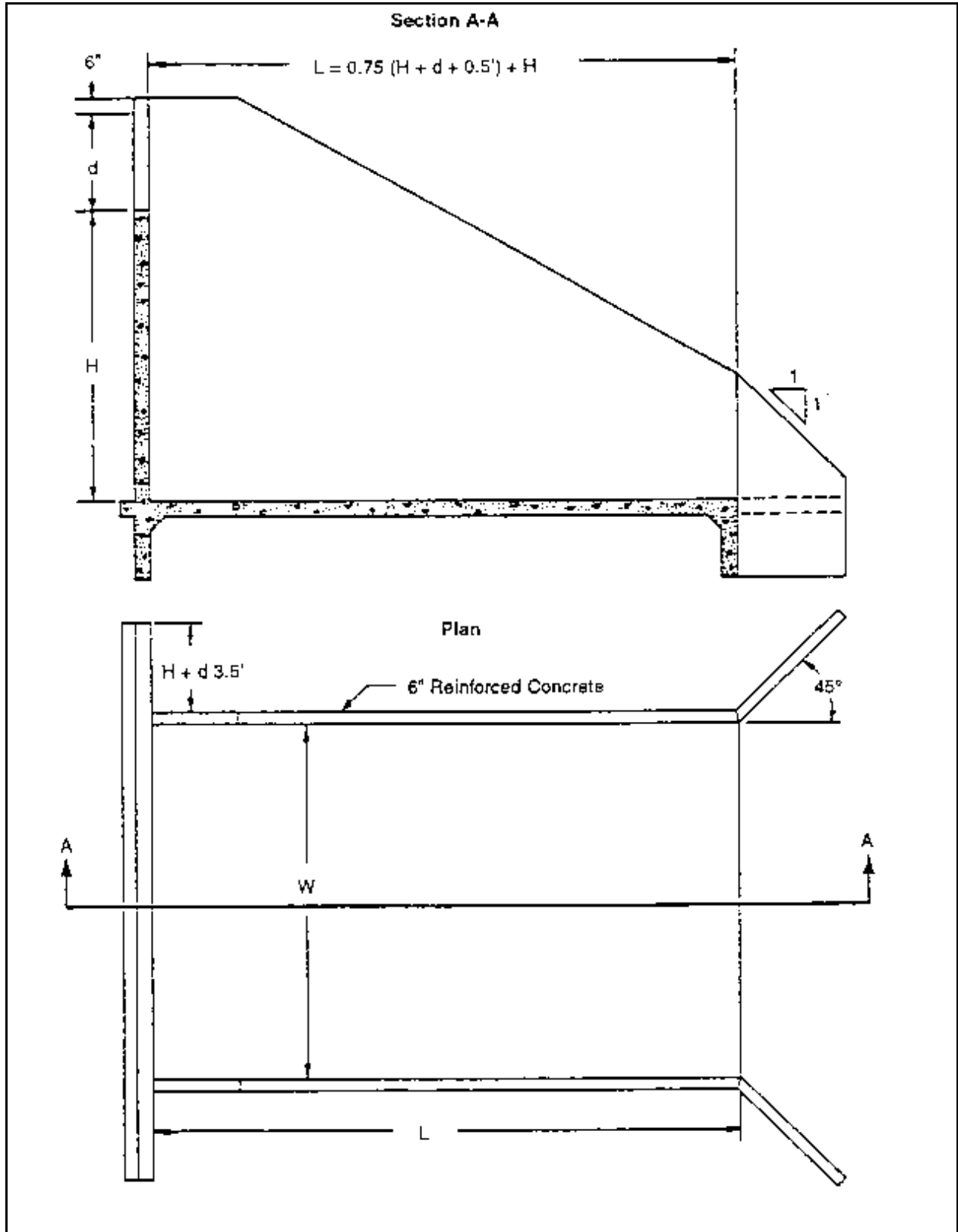

Plate 5.14c Waterway Drop Structure Details
 Source: Soil and Water Conservation Engineering, Schwab et al

5.15 OUTLET PROTECTION (ES BMP 1.36)

Definition

Structurally lined aprons or other acceptable energy dissipating devices placed at the outlets of pipes (See Plate 5.15a) or paved channel sections (see Plate 5.15c). The most common types are riprap aprons or concrete aprons with energy dissipator blocks or walls.

Purpose

To prevent scour at stormwater outlets and to minimize the potential for downstream erosion by reducing the velocity of concentrated stormwater flows.

Conditions Where Practice Applies

Applicable to the outlets of all pipes and paved channel sections where the velocity of flow at design capacity of the outlet will exceed the permissible velocity of the receiving channel or area.

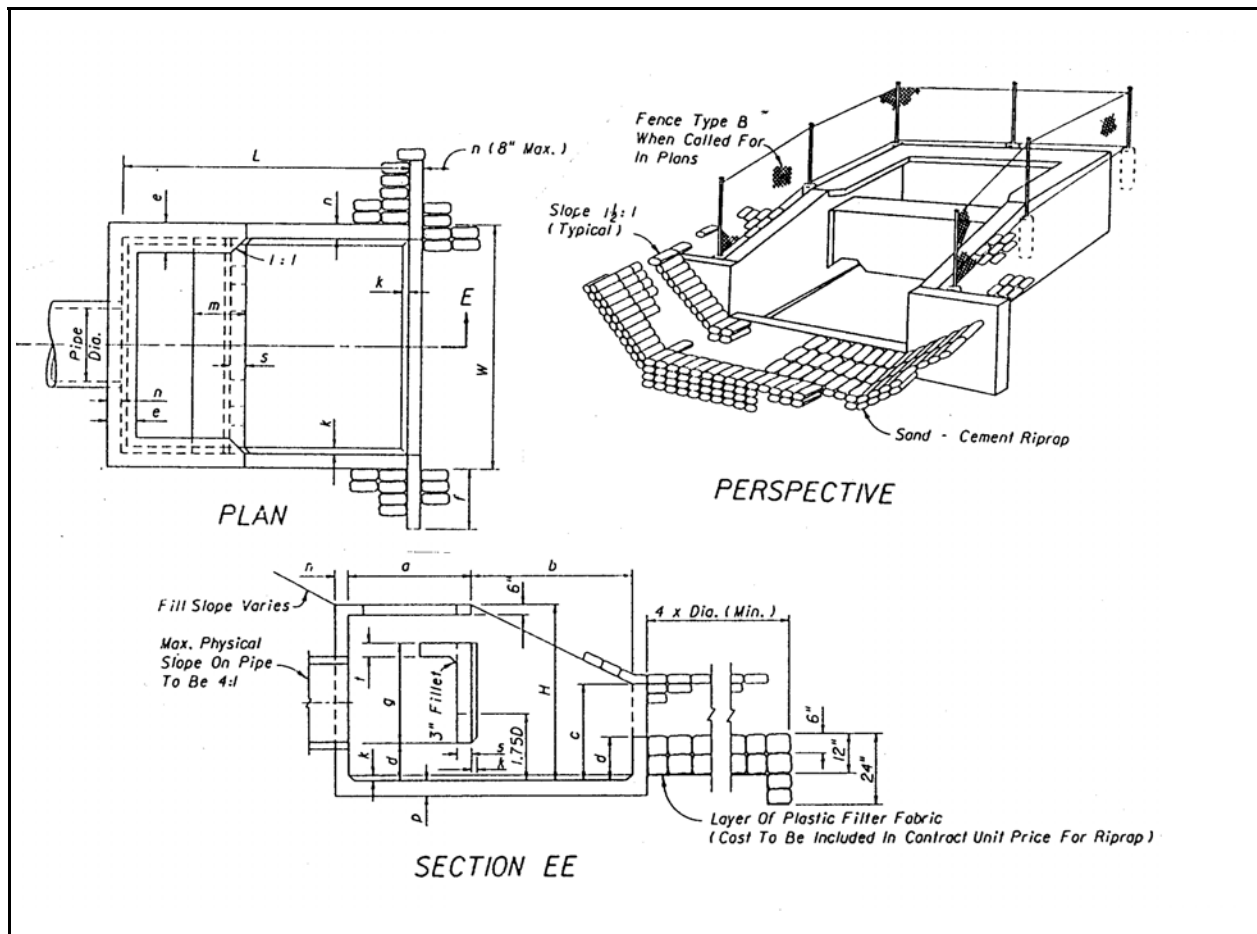

Plate 5.15a Energy Dissipator

Source: FDOT

Construction Specifications

Subgrade preparation for all types of outlet protection shall follow guidelines presented in EARTHWORK SPECIFICATIONS - Section 5.00. Riprap outlet protection aprons shall be installed in accordance with RIPRAP - Section 5.16. Reno mattresses can also be used as per GABIONS AND RENO MATTRESSES - Section 5.19. Underlying geotextiles shall be anchor trenched in at least 6" -9" (15 - 25 cm) and backfilled (see Plate 5.15b).

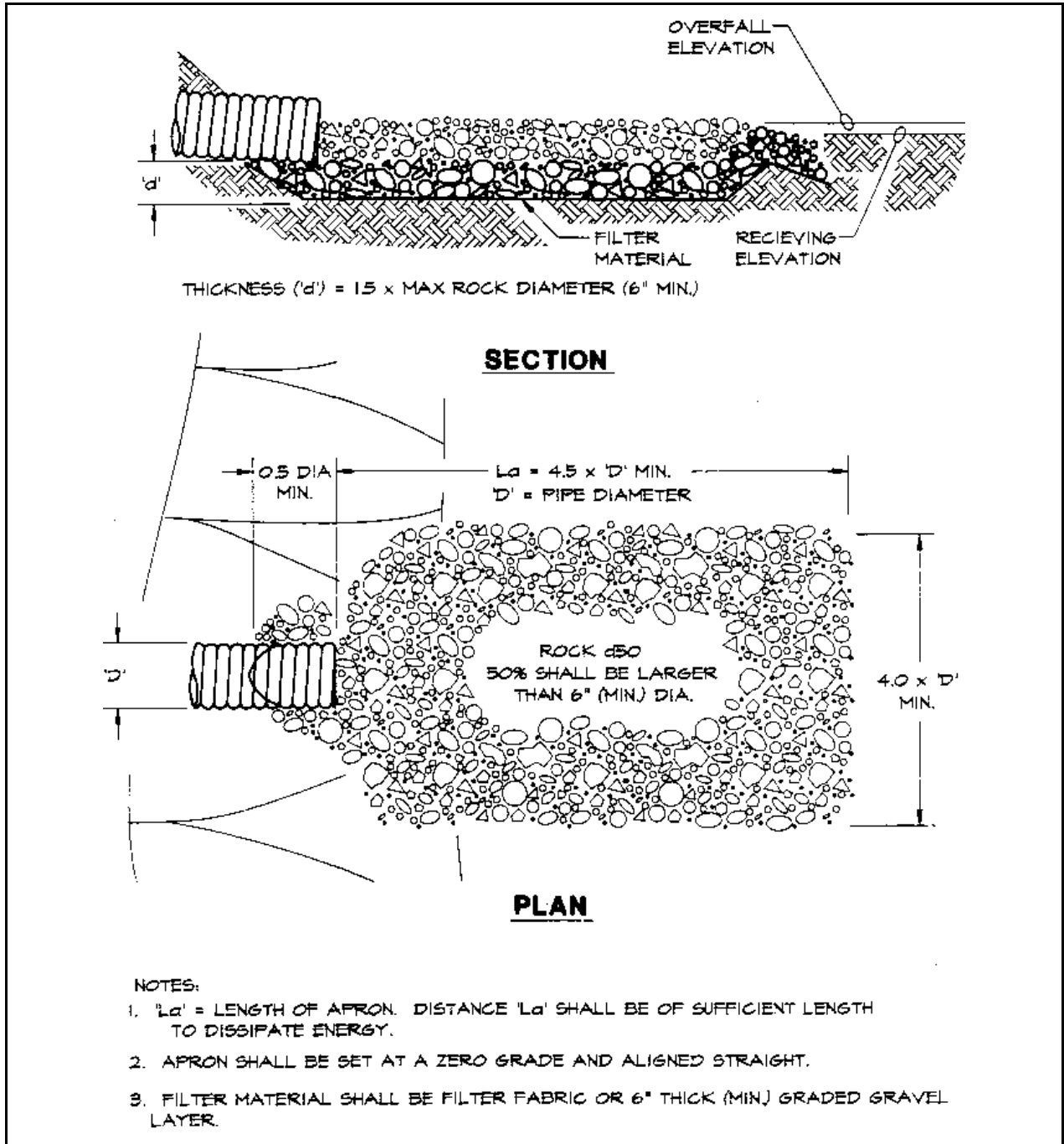

Plate 5.15b Energy Dissipator

Source: Erosion Draw

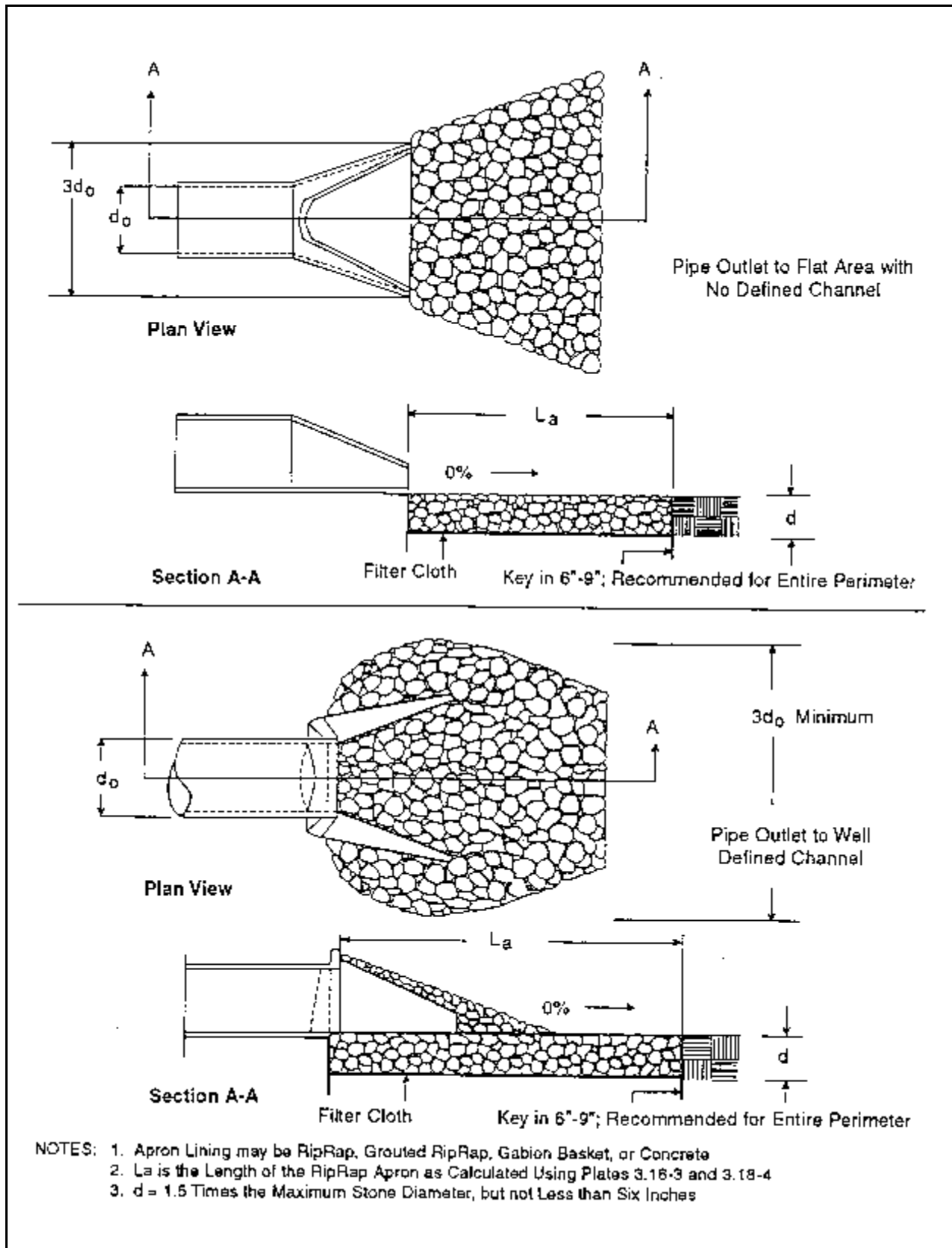

Plate 5.15c Pipe Outlet Conditions

Source: Virginia DSWC

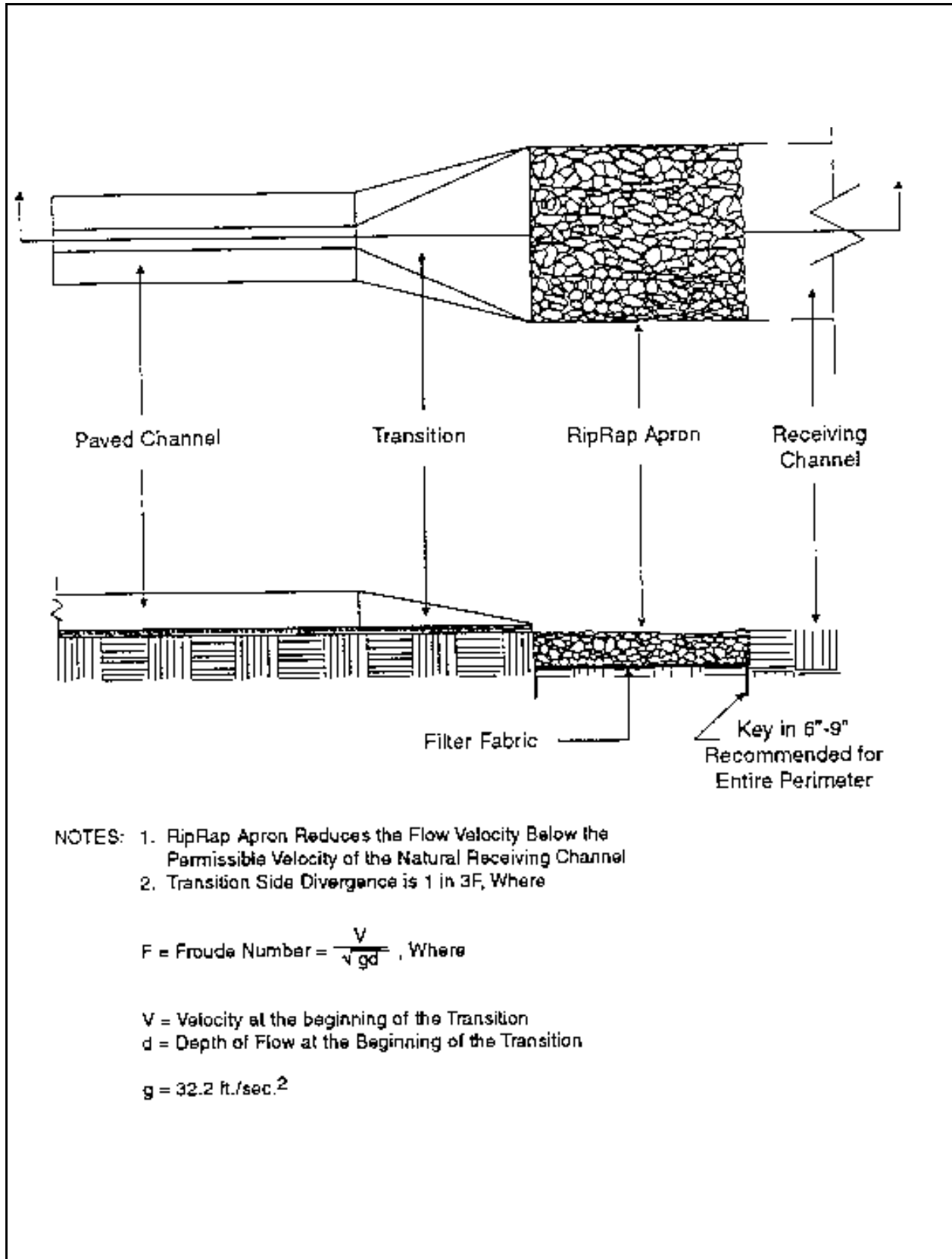

Plate 5.15d Paved Channel Outlet

Source: Virginia DSWC

5.16 RIPRAP **(ES BMP 1.37)**

Definition

A permanent erosion-resistant ground cover of large, loose, angular stone.

Purposes

1. To protect the soil surface from the erosive forces of concentrated runoff.
2. To slow the velocity of concentrated runoff while enhancing the potential for infiltration (See Plate 5.16a).
3. To stabilize slopes with seepage problems and/or non-cohesive soils (See Plate 5.16b).

Conditions Where Practice Applies

To soil-water interfaces where the soil conditions, water turbulence and velocity, expected vegetative cover, etc., are such that the soil may erode under the design flow conditions. Riprap may be used, as appropriate, at stormdrain outlets, on channel banks and/or bottoms, roadside ditches, drop structures, at the toe of slopes, etc (See Plate 5.16c).

Construction Specifications

Subgrade Preparation

The subgrade for the riprap or filter blanket shall be prepared to the required lines and grades. Any fill required in the subgrade shall be compacted to a density approximating that of the surrounding undisturbed material. Brush, trees, stumps and other objectionable material shall be removed.

Filter Blanket

Placement of the filter blanket should be done immediately after slope preparation. For granular filters the stone should be spread in a uniform layer to the specified depth. Where more than one layer of filter material is used, the layers should be spread so that there is minimal mixing of the layers.

For plastic filter cloths, the cloth should be placed directly on the prepared slope. The edges of the sheets should overlap by at least 12 inches (30 cm). Anchor pins, 15 inches (38 cm) long, should be spaced every 3 feet (90 cm) along the overlap. The upper and lower ends of the cloth should be buried a minimum of 12 inches (30 cm) deep. Care should be taken not to damage the cloth when placing the riprap. If damage occurs, that sheet should be removed and replaced. For large stone (12 inches (30 cm) or greater), a 4-inch (10 cm) layer of gravel may be necessary to prevent damage to the cloth.

Stone Placement

Placement of riprap should follow immediately after placement of the filter. The riprap should be placed so that it produces a dense well-graded mass of stone with a minimum of voids. The desired distribution of stones throughout the mass may be obtained by selective loading at the quarry, controlled dumping of successive loads during final placing, or by a combination of these methods. The riprap should be placed to its full thickness in one operation, not placed in layers. Stones should not be placed by dumping into chutes or similar methods which are likely to cause segregation of the various stone sizes. Care should be taken not to dislodge the underlying material when placing the stones.

The finished slope should be free of pockets of small stone or clusters of large stones. Hand placing may be necessary to achieve the required grades and a good distribution of stone sizes. Final thickness of the riprap blanket should be within plus or minus 1/4 of the specified thickness.

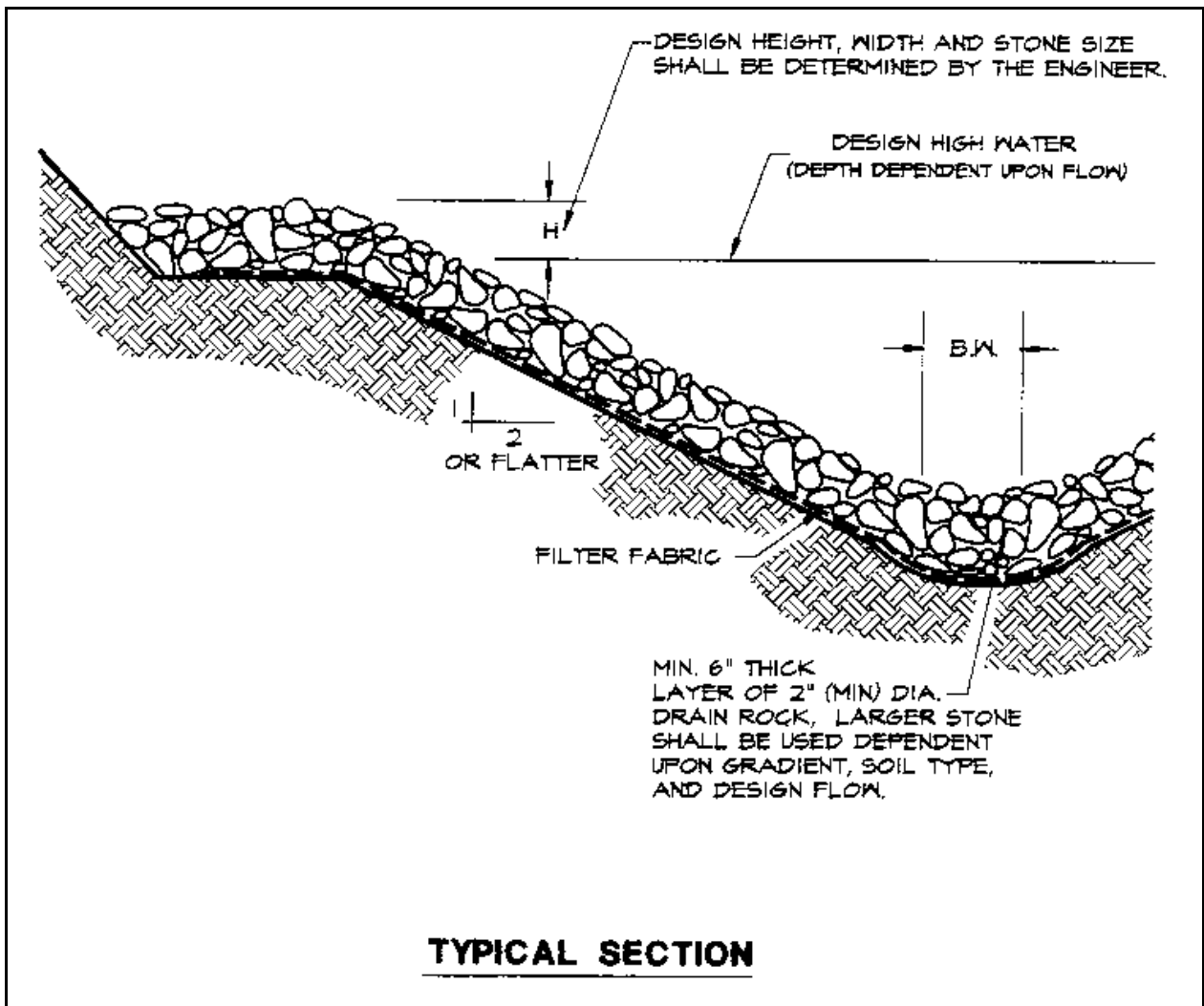

Plate 5.16a Rock-Lined Channel

Source: Erosion Draw

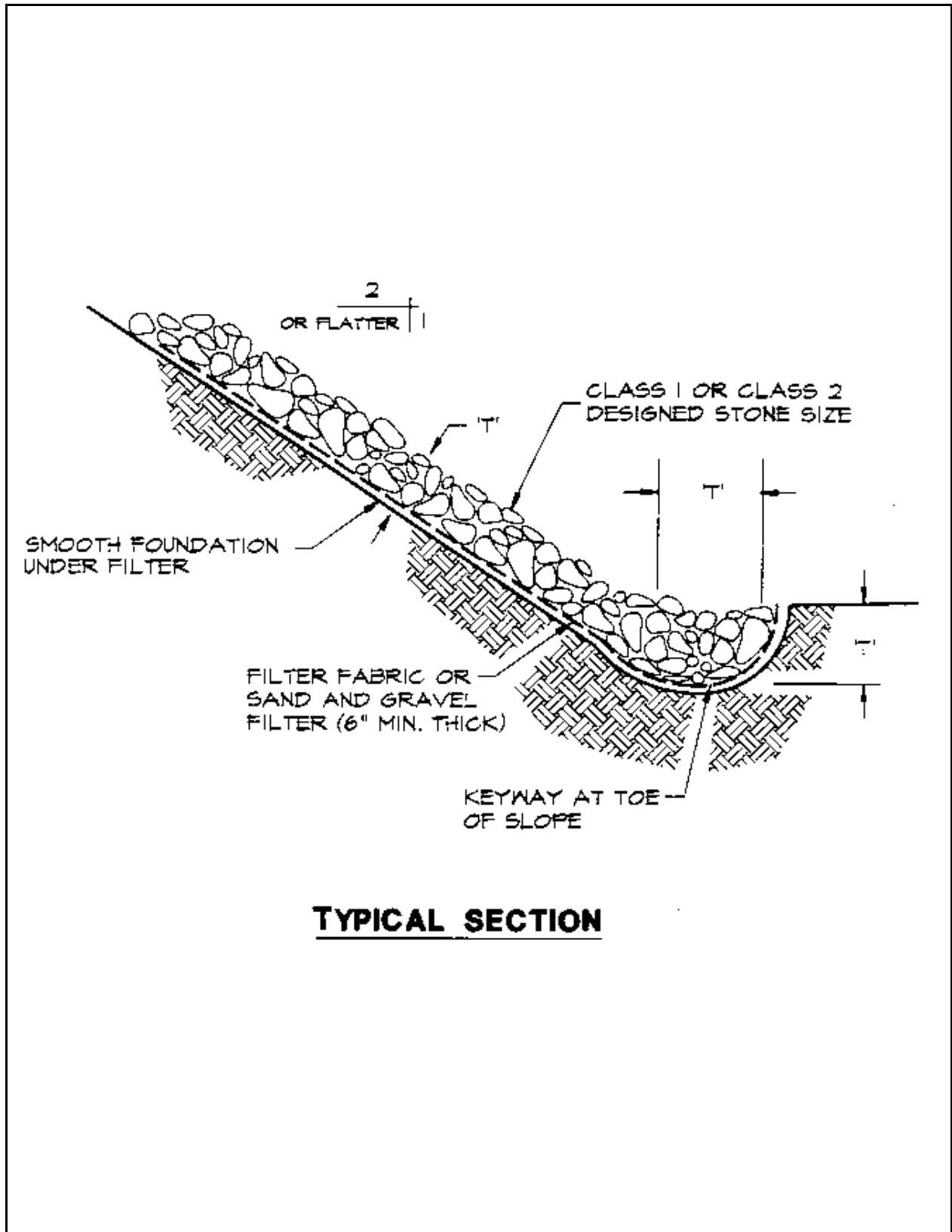

Plate 5.16b Riprap Slope Protection
Source: Erosion Draw

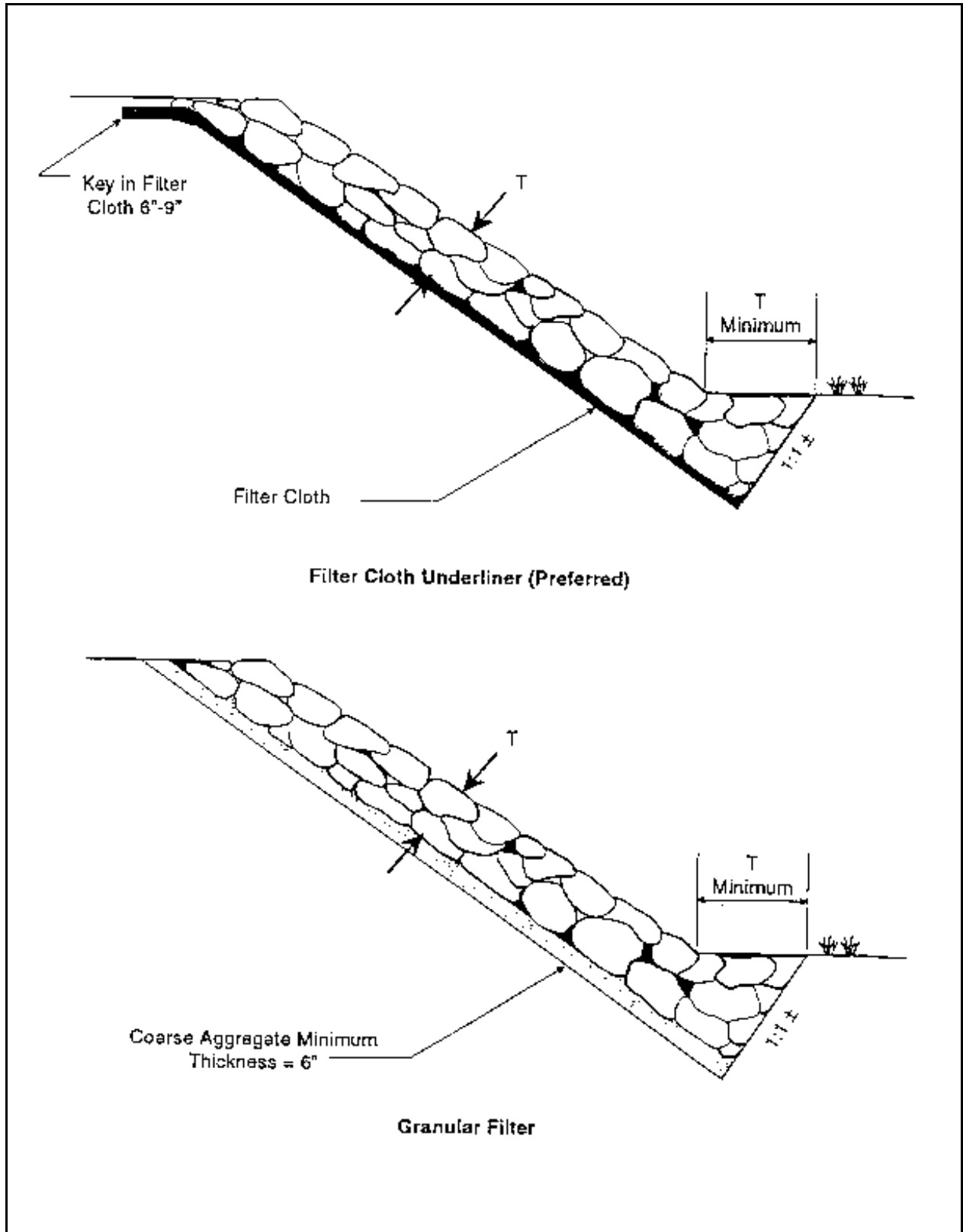

Plate 5.16c Toe Requirements for Bank Stabilization
Source: Virginia Department of Highways and Transportation Drainage Manual

5.17 GRID CONFINEMENT SYSTEMS **(ES BMP 1.90)**

Definition

A high density polyethylene (HDPE) grid confinement system stabilizes slopes or streambanks and allows vegetation to establish itself. In addition, the geometry of the three dimensional cells increases the loadbearing capacity (See Plate 5.17a).

Purpose

To prevent erosion from relatively steep slopes by stabilization of soil surface.

Condition Where Practice Applies

1. Disturbed areas which require protection from erosive forces, but require the aesthetics of vegetation, not provided by rock riprap or continuous concrete lining.
2. Sloping areas which may have intermittent traffic or other factors which would make vegetation hard to establish or maintain. (See Plate 5.17c).
3. Provides a firm surface for mowing with mechanical equipment.
4. Low volume vehicle use areas such as overflow parking, utility easements, unpaved roads, and driveways.
5. Grid confinement systems can be stacked to build earth retaining walls. (See Plate 5.17d).

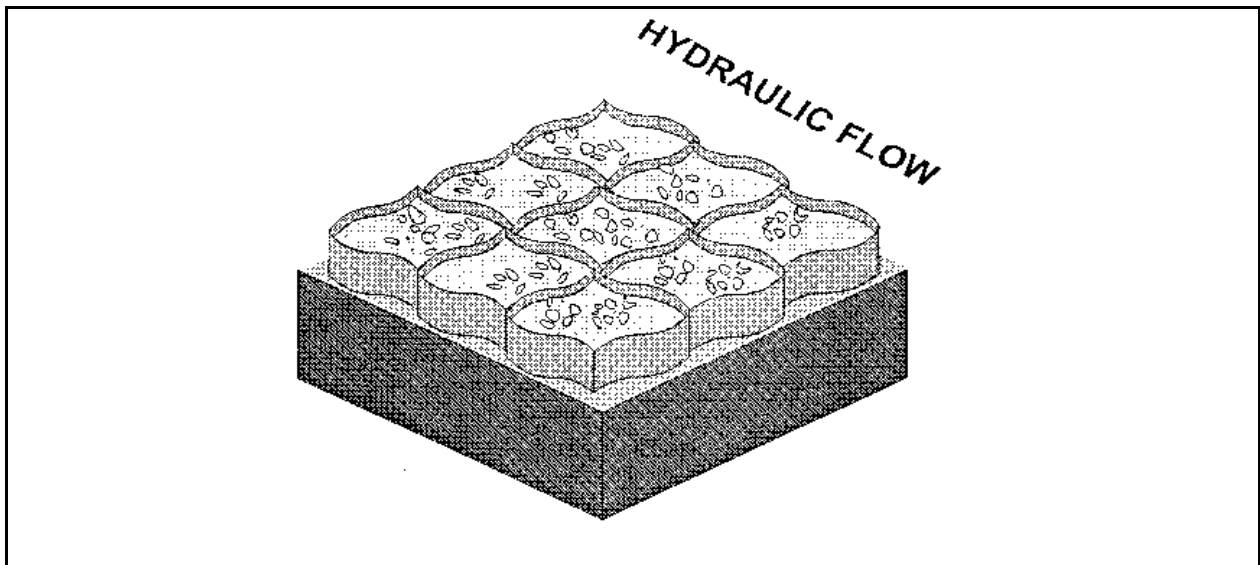

Plate 5.17a Grid Confinement System

Source: NRCS

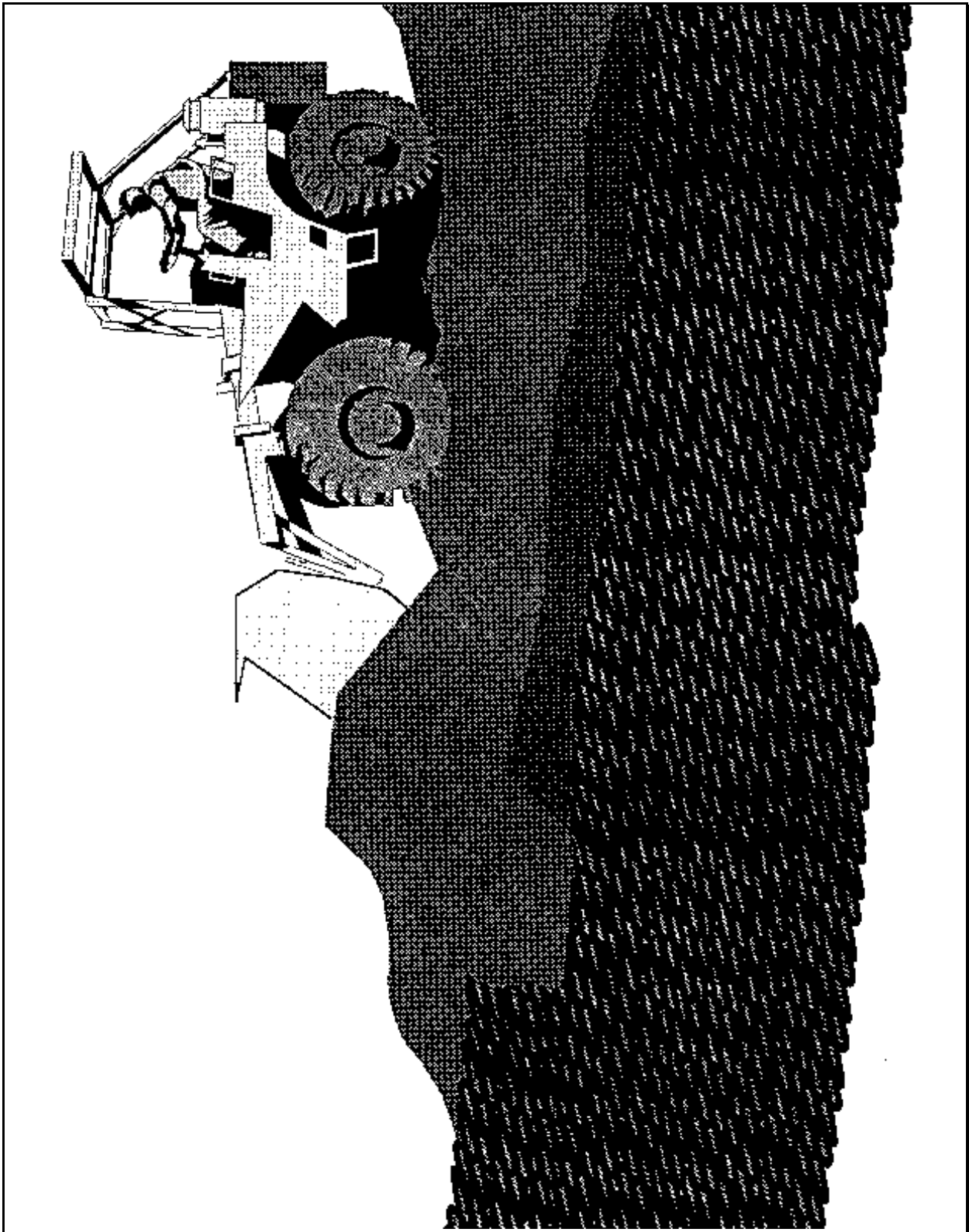

Plate 5.17b Ease of Installation
Source: NRCS

Planning Considerations

Grid confinement systems are less expensive alternative erosion control practice compared to cellular concrete block or rock riprap which combines benefits of vegetative and structural practices. The grid confinement system can be filled with locally available soils, small rock, or concrete. By stacking layers of grids, retaining wall structures can be created. It may be necessary after installation to provide TEMPORARY SEEDING - Section 6.65 (ES BMP 1.65) or PERMANENT SEEDING - Section 6.66 (ES BMP 1.66) to establish appropriate vegetative cover.

Design Criteria

No formal design is required.

Construction Specifications

Geotextile

Geotextile shall be placed prior to placement of the grid confinement system. The proper filter fabric to be used should be determined using a sieve analysis of the soil being protected. After the analysis a filter fabric is selected that will retain the soils being protected while having openings large enough to permit drainage and prevent clogging. The strength under tensile stress for the filter fabric should be at least one and one-half times the weight of the blocks. If no backfill material is to be used, the fabric should have good UV stability. Filter fabric should be buried at least 12" (30 cm) at the upper end of the protected area to prevent undermining.

Placement

Prior to placement of the filter fabric, the area to be affected should be prepared to have minimal disruption of the smooth plane of the slope. The grid confinement system shall be stretched according to the manufacturer's recommendation. The grid may be attached to a preconstructed rack to aid installation. The grid shall be staked, at a minimum, at least every third cell across the top, bottom, and center of each grid unit, if the unit dimension exceeds 3 feet (90 cm). If the unit's length is less than 3 feet (90 cm), stakes are required at the top and bottom of the grid. Where grids are laid adjacent, the cells shall be locked together with use of hog rings or equivalent locking system.

Backfill and Vegetation

Open grids will be back filled with gravel, crushed stone, or soil. Vegetation will provide additional stability at the area above the protective lining by consolidating soil. Seeding may need to be done to accelerate the establishment of vegetation. Seed may be premixed with this material to prevent the seed from being lost by washing out before germination.

The equipment placing the material shall not travel on top of the confinement grid until cells are filled in. As part of the grid is filled, the equipment may drive upon that portion, subject to manufacturer's recommendations (See Plate 5.17b). If the fill is a graded mixture, it shall be placed in a manner to avoid segregation.

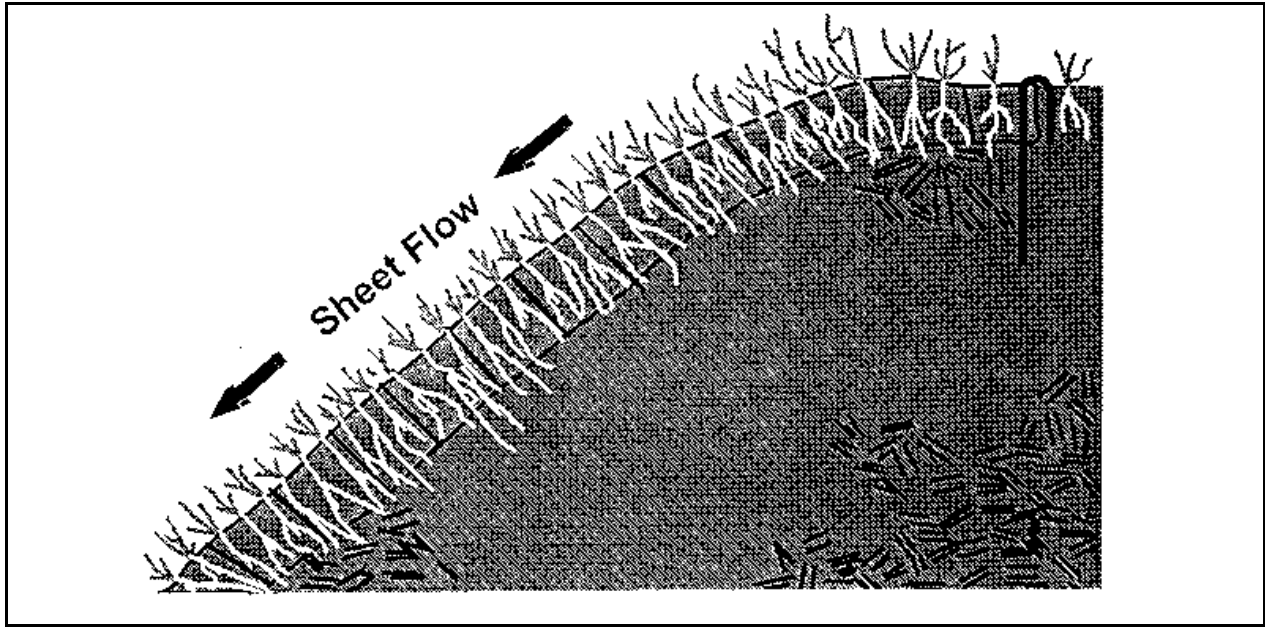

Plate 5.17c Vegetative Protection
Source: NRCS

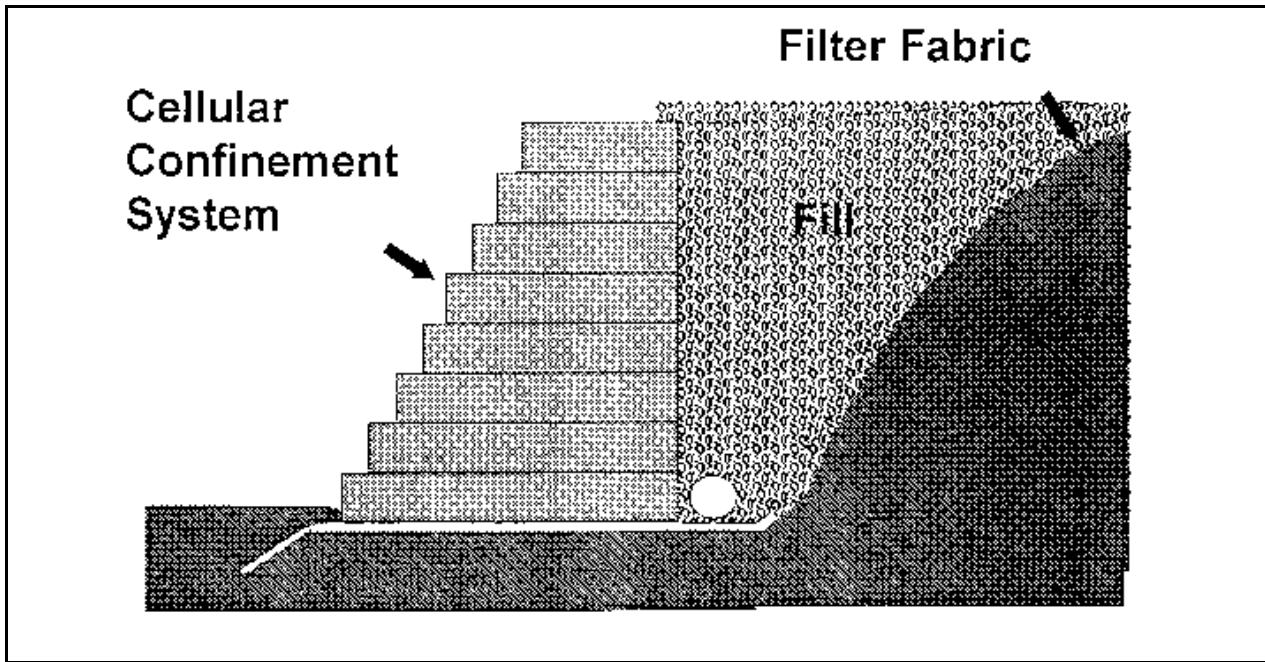

Plate 5.17d Gravity Retaining Wall
Source: NRCS

5.18 CELLULAR CONCRETE BLOCK **(ES BMP 1.92)**

Definition

Precast perforated concrete blocks which stabilize slopes or streambanks, but also allow vegetation to establish itself through openings in the block.

Purpose

1. To prevent erosion from relatively steep slopes by stabilization of soil surface (See Plate 5.18a).
2. Protect banks of streams, lakes, estuaries, and excavated channels against scour (See Plate 5.18b).

Conditions Where Practice Applies

1. Disturbed areas which require protection from erosive forces, but require the aesthetics of vegetation not provided by rock riprap or continuous concrete lining.
2. Sloping areas which may have intermittent traffic or other factors which would make vegetation hard to establish or maintain.
3. Provide a firm surface for mowing with mechanical equipment.
4. Land-water interfaces such as shorelines, channel linings, bridge abutments, spillways, boat ramps, and low water stream crossings.

Planning Considerations

Cellular concrete block are an expensive alternative erosion control practice which combines benefits of both vegetative and structural practices.

Blocks may be of the interlocking or nonlocking type and may be interconnected with flexible cable. Interconnected blocks can be swung into place for ease of underwater installation. These blocks can be used as a temporary installation and later removed and reused.

It may be necessary after installation to provide TEMPORARY SEEDING - Section 6.65 (ES BMP 1.65) or PERMANENT SEEDING - Section 6.66 (ES BMP 1.66) to establish appropriate vegetative cover.

Design Criteria

Design standards are currently under development by the IECA working with ASTM.

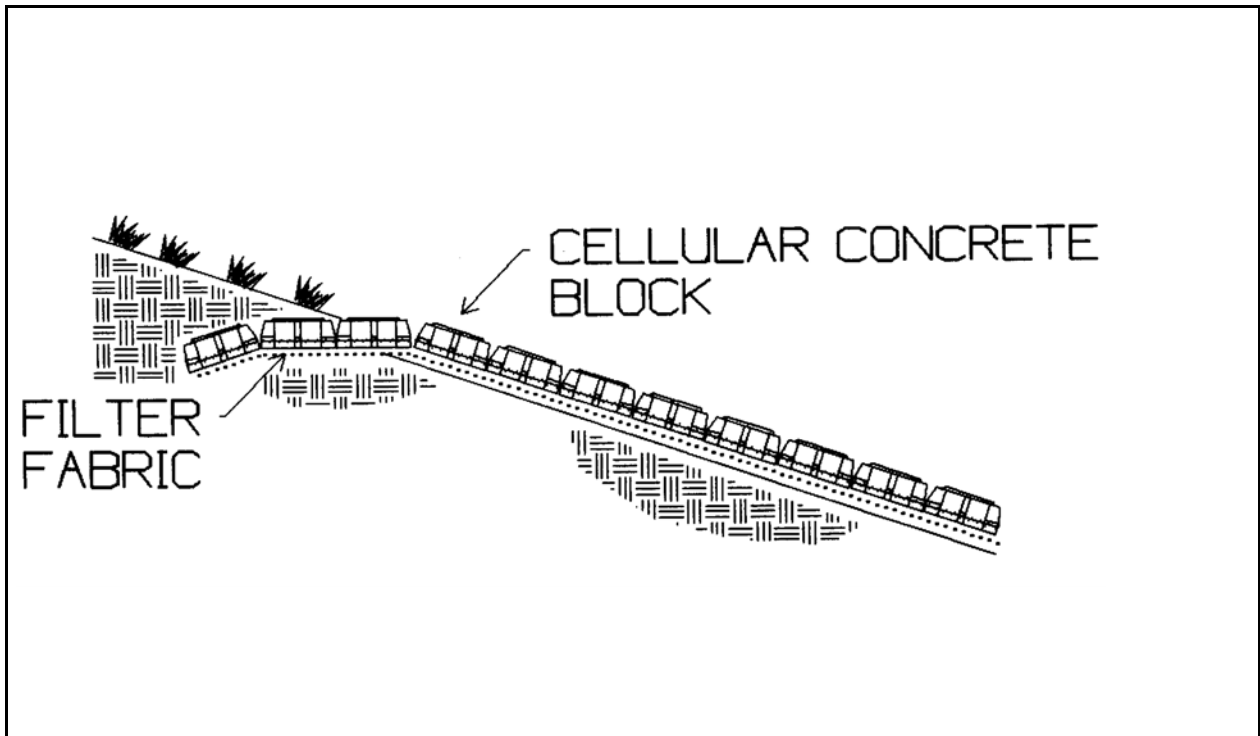

Plate 5.18a Slope Protection

Source: R.H.Moore & Assoc.

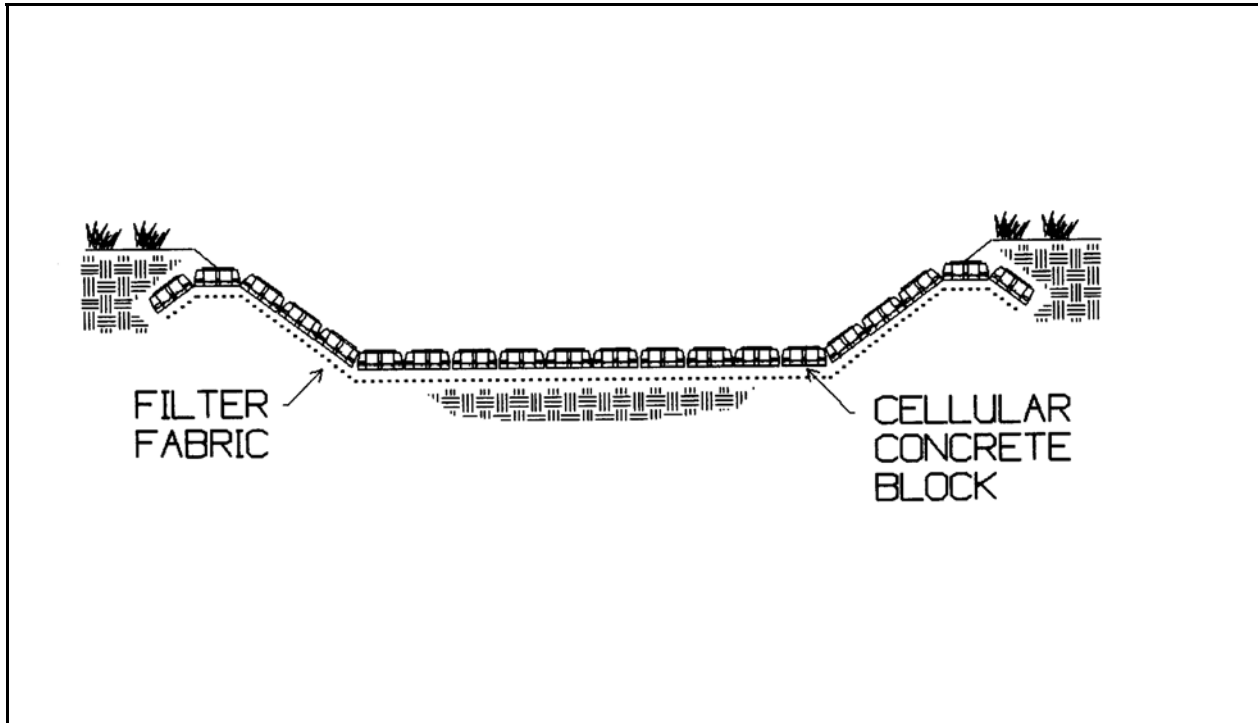

Plate 5.18b Channel Bottom Protection

Source: R.H.Moore & Assoc.

Construction Specifications

Subgrade Preparation

The slope should be graded to a smooth plane surface to ensure that intimate contact is achieved between the slope face and the geotextile, and between the geotextile and the bottom of the articulated concrete blocks. All slope deformities, roots, grade stakes, and stones which project from the slope face must be removed and regraded. Holes, "pockmarks", slope board teeth marks, footprints, grooves, depressions, or other localized voids should also be removed, filled, and compacted. The slope and slope face should be uniformly compacted to 95% standard proctor density.

To insure a uniform channel cross-section, it is suggested that a grading template be constructed and "dragged" down the channel in front of the shovel crew. The anchor trench at the top of the slope should be uniformly graded to insure intimate contact between all articulated blocks and the underlying grade at the transition between the embankment crest and the slope face. Immediately prior to placing the filter fabric and articulated block, the prepared area should be inspected and approved by the design engineer.

Placement of Geotextile

The geotextile should be placed directly on the prepared area, in intimate contact with the subgrade, and free of folds or wrinkles. The geotextile should not be walked on or disturbed when the result is loss of intimate contact between the articulated block and the geotextile or between the geotextile and the subgrade. The geotextile should be placed so that the upstream strip of fabric overlaps the downstream strip. The longitudinal and traverse joints should overlap at least three feet (1 m). The geotextile should extend at least one foot (30 cm) beyond the top and bottom of the revetment. If articulated blocks are assembled and placed as large mattresses, the edge of the geotextile should not occur in the same location as a space between the articulated block mattresses.

Placement of Articulated Block

The articulated blocks should be placed on the geotextile in such a manner as to produce a smooth plane surface in intimate contact with the geotextile. No individual block within the plane of placed articulated blocks should protrude more than the design tolerance, typically 0.5 inches (12 mm). To insure that articulated blocks are flush and develop intimate contact with the subgrade, it is suggested that the blocks be "seated in" with a roller or "stepped on " to produce a flush surface.

If assembled and placed as large mattresses, the articulated mats are typically attached to a spreader bar to aid in the lifting and placing of the mats in their proper position with a crane. The mats should be placed side by side and/or end to end, so that the mats abut each other. Mat seams or openings between mats greater than two inches (5 cm) should be filled with grout.

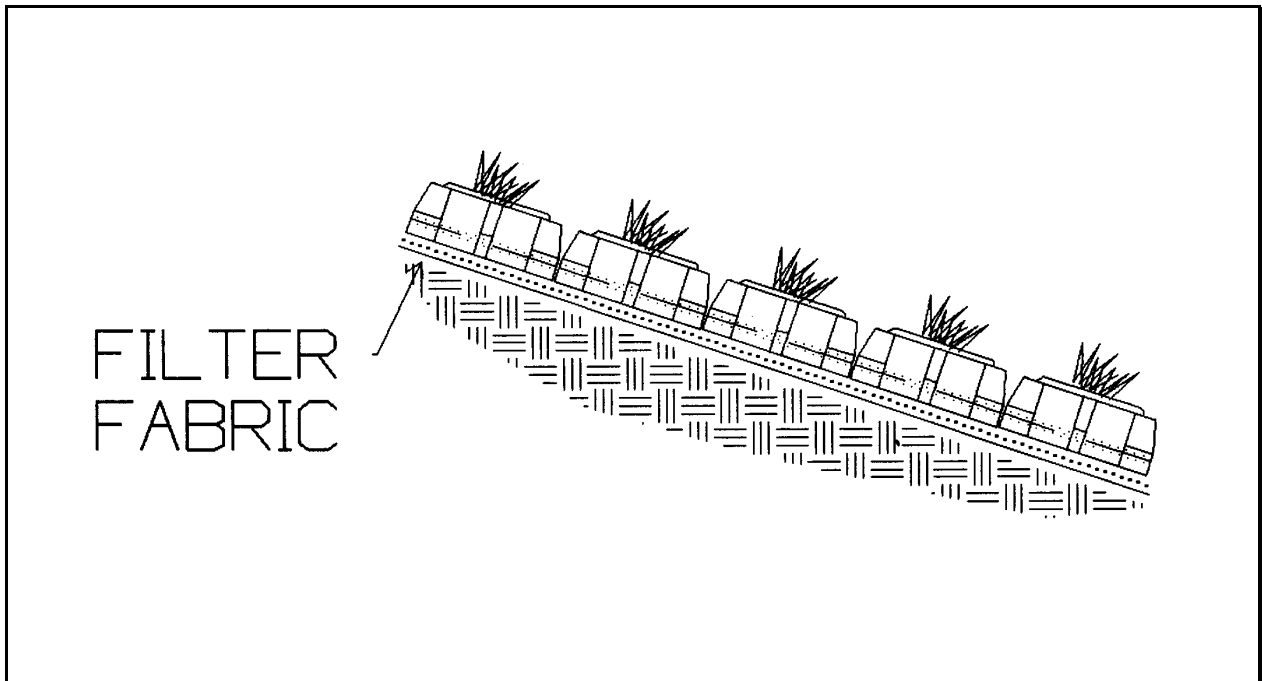

Plate 5.18c Revegetation
Source: NRCS

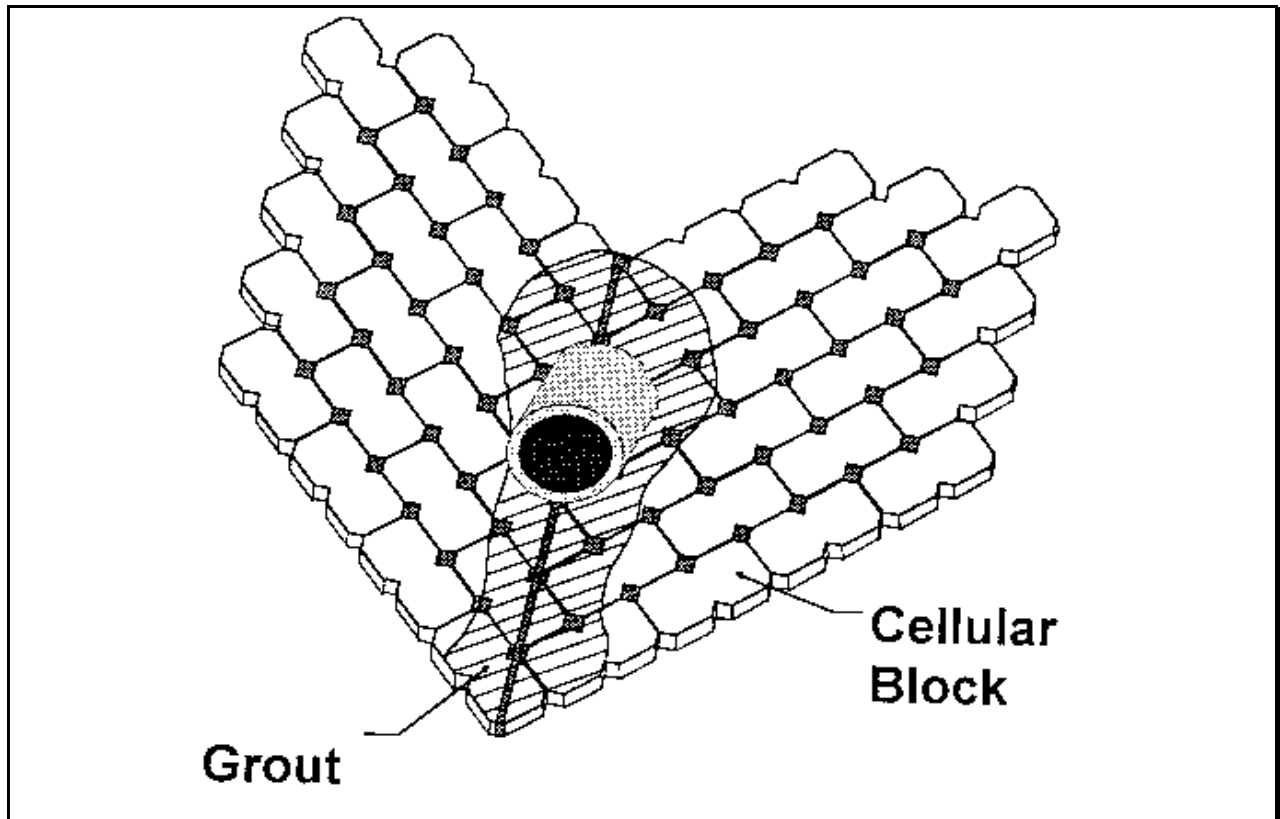

Plate 5.18d Grout Illustration
Source: NRCS

Whether placed by hand or in large mattresses, distinct grade changes should be accommodated with a transition curve of not less than four feet (1.3 m). However, if a discontinuous surface exists in the direction of flow, a grout seam at the grade change location should be provided to produce a continuous smooth flow surface.

Installation Details

The articulated concrete block system should extend horizontally at the top of an embankment side slope at least two feet (0.6 m) into the embankment before terminating. The revetment should be terminated into an anchor trench of at least two feet (0.6 m) deep. The trench should be immediately backfilled, compacted, and protected from erosion which could cause undermining of the system. The top of the anchor trench should remain flush with the top surface of the block system. When flow transition occurs, as in the case of flumes or drop structures, the articulated blocks should extend into the zone of subcritical flow before terminating in an anchor trench.

The termination at the toe of the protected embankment could either be (1) extended outward as an apron a distance of 1.5 times the maximum expected depth of scour, (2) buried to a depth of 1.5 times the maximum depth of scour, or (3) buried with large rocks or other suitable erosion resistant backfill. When the articulated block system is to be buried, the blocks should continue into the toe trench along the same grade as the slope being protected. Side termination is performed by burying the articulated block into an anchor trench at least two feet (0.6 m) deep, and backfilling with a non-erodible material to the top surface or the adjacent blocks.

Grouting

When placing blocks at sharp bend, pilings, pipe outlets, slope intersections, and other irregular areas, individual blocks should be cut to fill the area. Concrete grout should be placed in the area where blocks have been cut (See Plate 5.18d). Grout should also be placed in any seams or joints greater than two inches (5 cm) wide.

Backfill and Vegetation

Void spaces in the articulated concrete block system may be filled with gravel or crushed stone in areas below the waterline and with soil in areas above the waterline. Do not overfill voids with soil, as the best results are obtained when soil level is kept 1/2" to 3/4" (12 to 18 mm) below the top of the blocks. Typically one cubic yard of material is needed for every 200 sq. ft. of area ($1 \text{ m}^3/24 \text{ m}^2$).

Vegetation will provide additional stability to the area above the protective lining by consolidating the soil. Seeding may be needed to accelerate the establishment of vegetation. Seed should be premixed with the fill to prevent the seed being lost by washing out before the vegetation is established. Hydroseeding may also be used (See Plate 5.18c).

This page left intentionally blank

5.19 MAINTENANCE

GENERAL

Maintenance is of primary importance if stormwater management systems are to continue to function as originally designed. A local government, a designated group such as a homeowners' association, or some individual must accept the responsibility for maintaining the structures and the impoundment area. A set of "As-Built" plans should be prepared for and maintained by the responsible entity. A specific maintenance plan should be formulated outlining the schedule and scope of maintenance operations. It should be stressed that good records should be kept on all maintenance operations to help plan future work and identify facilities requiring attention.

All stormwater systems should be inspected on a routine basis to ensure that they are functioning properly. Major inspections should be conducted semi-annually, and brief inspections should always be conducted following storms with over one inch (25 mm) of rainfall. Systems that incorporate infiltration are especially critical since poor maintenance practices can soon render them inefficient. It is also advisable to assure that vegetation (sod) is growing well and that all construction is according to approved design.

SAFETY

All permanent impoundments and structures should be inspected periodically by a Florida registered professional engineer to insure that they remain structurally sound and mechanically efficient. An annual safety inspection is recommended where the potential for downstream damage and loss of life due to impoundment failure is high. Look for signs of burrowing animals, especially on or near embankments. All structures should be inspected for scour, erosion, settlement, and structural failure following major storms as well.

Many jurisdictions require fences around impoundments with side slopes of 3:1 or steeper. The fence, gates, and locks should be inspected quarterly, and a list of key holders should be kept.

PUBLIC HEALTH

Precautions should be taken to minimize the production of fast-breeding insects in and around the ponded area. Possible control measures include controlling the growth of vegetation at shorelines, varying the water depth every few days, and stocking the pond with mosquito-eating fish, such as *Gambusia*.

MAINTENANCE OF RETENTION SYSTEMS

5.01 STORMWATER RETENTION BASINS

Routine Maintenance

Cleanout frequency of infiltration basins will depend on a number of factors. These factors include whether they are vegetated or non-vegetated, whether pretreatment BMPs are

used, storage capacity, infiltration characteristics, volume of inflow, and amount and type of sediment load. Infiltration basins should be thoroughly inspected at least semi-annually. Sedimentation basins and traps may require more frequent inspections and cleanout. These structures should be cleaned out when sediment levels reduce storage volume by 10%. An elevation mark (also known as a tattle-tale) should be located inside the basin. Non-vegetated basins can be scarified on an annual basis following removal of all accumulated sediments. Rotary tillers or disc harrows with light tractors are recommended for maintenance of retention basins. Use of heavy equipment should be discouraged to prevent excessive compaction of surface soils. The basin floor should be left level and smooth after the tilling operation to ease future removal of sediment and minimize the amount of material to be removed during future cleaning operations. A leveling drag towed behind the equipment on the last pass will accomplish this.

However, this operation can be eliminated or minimized by the establishment of grass cover on the basin floor and slopes. The roots of vegetation help maintain soil permeability.

The BMP treatment train, especially sediment traps or forebays, can be used to reduce maintenance of infiltration basins by settling out suspended solids, or removing oil and grease before the water is released into the infiltration basin.

Infiltration basins should never be used for sediment control during the construction process. In situations with heavy sediment loads, chemical flocculants can also be used to speed up settlement in pretreatment sediment traps or forebay ponds. Flocculants should be added to the runoff water within the settlement pond inlet pipe or culvert where turbulence will ensure more thorough mixing. After suspended matter has flocculated and settled in the settling pond, the water may then be released into the infiltration basin for disposal.

Algae or bacterial growth can also inhibit infiltration. To avoid this problem make certain that the basin dries out between storms, especially during the wet summer months.

5.02 EXFILTRATION TRENCHES

Preventive maintenance is vital to the continued effectiveness of all infiltration BMPs, but especially for exfiltration systems. Pretreatment measures to filter out suspended materials that might clog the trench are necessary because once void areas become clogged, maintenance entails a complete replacement of the filter material. The use of filter fabrics over the surface of an infiltration trench that is open to the surface for runoff can be most effective in keeping objectionable material from entering the system. Of course, periodic cleaning or replacement of clogged filter fabric will be necessary.

Routine Maintenance

The routine maintenance requirements of trenches are not great. However, getting property owners to actually perform them may be very difficult. Trenches are smaller and more inconspicuous than most other BMPs, and when located underground, they may not be visible or accessible. As a result, residents or homeowners' associations are not likely to exhibit much concern over trench maintenance as they might for more visible BMPs,

such as detention ponds. For these reasons, a public sector commitment to regularly inspect privately owned trenches is a necessity. Property owners and associations will need to be educated about the function and maintenance requirements of the trench. A legally binding maintenance agreement should be included with the property deed that clearly describes maintenance tasks and schedules. Further, the agreement should grant access for regular inspections, and enable the public sector to perform maintenance (and bill the owners) if the trench has been neglected. Some of the normal maintenance tasks for trenches are detailed below.

Inspection

The trench should be inspected several times in the first year of operation, and at least semi-annually thereafter. The inspections should be conducted after large storms to check for surface ponding that might indicate local or wide spread clogging. Water levels in the observation well should be recorded over several days to check trench drainage. Surface trenches can be inspected by hand by digging with a trowel down to the first layer of filter fabric usually located one foot (30 cm) below the surface.

Buffer Maintenance

The condition of the grass buffer strips used in conjunction with trenches should be inspected regularly. Refer to the VEGETATION section of this chapter for further information about buffer maintenance.

Sediment Removal

The pre-treatment inlets of underground trenches should be checked periodically and cleaned out when sediment depletes more than 10% of available capacity. This can be done manually or by a vacuum pump. Inlet and outlet pipes should be checked for clogging and vandalism.

Non-Routine Maintenance

The primary non-routine maintenance task involves rehabilitation of the trench after it becomes clogged. There is no reliable estimate as to how long trenches will function before they clog. However, it is probable that the longevity of trenches may be on the order of ten years at best.

Clogging in surface trenches is most likely to occur near the top of the trench, between the upper layer of stone and the protective layer of filter fabric. Surface clogging can be relieved by carefully removing the top layer of stone, removing the clogged filter fabric, installing new filter fabric, and cleaning or replacing the top stone layer. The costs for rehabilitating a surface trench will usually not exceed 20% of the initial construction cost, adjusted for inflation.

Clogging of underground trenches is a much more serious problem as it is likely to occur at the bottom of the trench, at the filter fabric/soil interface. Rehabilitation of an underground trench requires the removal of the pavement or the topsoil/vegetation layer, the protective plastic layer, the stone aggregate, and the bottom filter fabric layer. Then, the subsoil

layer, must be tilled to promote better infiltration, and each layer must be replaced. If pavement or concrete constitute the surface layer (instead of topsoil/grass), the rehabilitation effort becomes more difficult and costly.

Total Maintenance Costs

No reliable data is presently available to assess maintenance costs for trenches. Routine maintenance costs will probably run higher for surface trenches than underground trenches, primarily due to the frequency. As noted before, the opposite is probably true for non-routine maintenance tasks. It is reasonable to assume that the cost of rehabilitating an underground trench will be roughly equivalent to the initial construction cost. Surface trench rehabilitation should be approximately 20% of the initial construction cost; however, there are reasons to expect that the clogging of surface trenches may occur more frequently.

If it is assumed that surface and underground trenches will need rehabilitation every five to fifteen years, respectively. An annual maintenance set-aside of 5% - 10% (surface trenches) and 10% - 15% (underground trenches) of the initial construction cost may be needed to cover routine/non-routine maintenance expenditures. It must be emphasized that these estimates are highly uncertain. Until more local experience is obtained, the issue of trench maintenance costs remains largely speculative.

5.03 POROUS PAVEMENT

Routine Maintenance

Routine maintenance involves removal of debris that is too coarse to be washed through the pavement system. Vacuuming pavements is required to remove particulates that are fine enough to be carried into the pavement but too large to pass through, thus clogging the void space. Porous pavements require no more repair maintenance than conventional pavements, so maintenance problems can generally be reduced to better "housekeeping" practices on the part of area residents and more efficient street cleaning procedure in municipalities.

To preserve the high filtration rate of the pervious paving, routine inspection and maintenance is required. The surface should be routinely visually checked (preferably after a prolonged storm event) for evidence of debris, ponding of water, clogging of pores and other damage. Any debris should be immediately removed. An monthly cleaning with a vacuum street sweeper should be done to thoroughly cleanse the surface.

Cleaning

It has long been recognized that maintenance and cleaning of porous pavements to prevent or alleviate clogging would be a factor in the application of such pavements. Sections of porous pavement which have been clogged have been cleaned by various methods. No method has been satisfactory on fully clogged pavements, however, and, only a superficially clogged section showing a water penetration rate of 0.1 inches (2.5 mm) per second compared to a normal water penetration of 0.38 inches (10 mm) per second can be restored to normal operation. The best method for cleaning is brush and

vacuum sweeping followed by high pressure water washing of the pavement. In Maryland, it has been determined that vacuum cleaning alone, once the pavement is clogged, will be largely ineffective. The oils bind dirt, and, only an abrading and washing technique can be effective in its removal. Clogging to a depth of 0.5 inch (13 mm) is sufficient to prevent water penetration.

If, during visual inspection, any ponding or clogging is noticed, the following program should be followed to correct the problem. First, a street sweeper with a vacuum should be used. If ponding persists, steam cleaning with a biodegradable substance can be applied, then vacuum. If the clogging is at a depth greater than 1/2-inch (13 mm), holes, 1/4-inch (6.5 mm) in diameter and one foot (30 cm) on-center, can be drilled through concrete pavement. Hand-held drills or truck-mounted drill rigs may be used. All drilling debris should be vacuumed from the pavement.

Replacing Clogged Pavement

Once a large area of porous pavement is fully clogged and it cannot be adequately cleaned, the paving must be removed to a depth where the clogging is not evident and new porous paving filled in. In extreme cases, the affected area must be removed and new topping put down. Since these materials are relatively new, obtaining a patching mix suitable to match the installed pavement may be difficult. Available patching material is usually dense graded at present. If the subbase becomes clogged, the pavement must also be saw cut and removed. Six to twelve inches (15 - 30 cm) of the subbase will usually need to be replaced with clean sand, then proof rolled. Pervious paving will then need to be filled in.

5.04 CONCRETE GRID AND MODULAR PAVEMENT

Where turf is incorporated into these installations, normal turf maintenance - watering, fertilizing and mowing - will be necessary. Mowing is seldom required in areas of frequent traffic. It is documented that the hard surfaces in these installations require very little maintenance. However, fertilizers, pesticides and other chemicals may have adverse effects on concrete products. The use of such chemicals should be restricted as much as possible.

5.07 GRASSED WATERWAYS AND SWALES

Timely maintenance is important to keep a swale in good working condition. Fertilizing and mowing should be done frequently enough to keep the vegetation in vigorous condition. The cut vegetation should be removed to prevent the decaying organic litter from adding pollutants to the discharge from the swale.

Vehicular traffic should be excluded from the swale. Following heavy rainfall always inspect the area for failures and make necessary repairs, replacements, or re-seeding within the planting season. If complete re-seeding is necessary, apply half the original recommended rate of fertilizer with a full rate of seed.

Many residents find swales to be convenient sites for the disposal of leaf litter, grass clippings, and other types of refuse. The proper operation of these facilities from both a

hydraulic and treatment standpoint is dependent on the integrity and knowledge of the residents whom the system serves. A few careless individuals can result in an outlet getting plugged with debris. These circumstances lead to abnormally high levels of organic material being delivered to downstream waters, and sometimes flooding of a neighbor's property. Public education programs should be undertaken, as necessary, to ensure that swales are not used as trash disposal areas. The Department has published a pamphlet entitled "Save the Swales" to facilitate education.

SPECIAL OPERATION & MAINTENANCE CONDITIONS FOR KARST SENSITIVE AREAS

In areas of active sinkhole activity, a site inspection should be performed by field personnel, when the retention basins is excavated to final grade. The objective is to visually inspect for exposed limerock or solution pipes. To mitigate the potential for direct connections from on-site infiltration basins to the ground water, the following recommendations are provided:

1. Stormwater swales and retention basins should be monitored by visual observations following significant storm events. If open solutions or pipes and/or sinkhole-like depressions are noted, this information should be relayed to permitting authorities and appropriate corrective action should be taken.
2. Where small, shallow depressions are noted, these may be filled to pre-existing grade with clayey sand materials, graded and vegetated.
3. When, and if, chimney-type solution pipes are exposed within the retention basins, these may be plugged in accordance with acceptable water well plugging and abandonment procedures. Where these features are small in diameter and of a limited vertical depth, bridging of the pipe with indigenous limestone boulders is recommended. Once the bridge is in place, the pipe may be filled with clay and/or clayey sand back to the land surface and then vegetated.
4. Remedial plugging activities should employ methodologies acceptable to the applicable regulatory agency.

MAINTENANCE OF DETENTION SYSTEMS

5.05 STORMWATER DETENTION BASINS

Maintenance of sediment and debris basins is extremely important. Plans should include provisions for sediment removal when a certain storage elevation is reached. Debris removal in detention basins can be achieved through the use of trash racks or other screening devices. Debris should be removed from the basin following each storm.

Sediment

Sediment deposition should be continually monitored in the basin. The maintenance plan should specify an elevation at which the sediment should be removed. This elevation mark, or tattle-tale should be located inside of the basin. The mark should be set at no

more than 25% of capacity, however 10% is preferred. Owners, operators, and maintenance authorities should be aware that significant concentrations of heavy metals (e.g., lead, zinc, and cadmium) as well as some organics such as pesticides, may be expected to accumulate at the bottom of these treatment facilities. Testing of sediment (EP Toxicity) especially near points of inflow should be conducted to determine the leaching potential and level of accumulation of hazardous material before disposal via landspreading or filling is prescribed.

5.06 UNDERDRAINS AND FILTERS

Like all stormwater BMPs, a properly designed and constructed underdrain filter system still requires maintenance to keep it operating. Inspection of the underdrains, especially after heavy rains, should be made to see if they are working and if maintenance is required. Pore spaces in stormwater filters can be expected to seal with time following the beginning of operation. The duration of a filter's effectiveness before the hydraulic capacity is reduced to the point that drawdown requirements can no longer be met will depend on a number of factors including the initial permeability of filter material used, the degree of pretreatment (sedimentation) prior to entering the filtration facility, and the nature of the pollutants being removed.

Common causes of subsurface filter system failures include the following:

1. Underdrains installed with insufficient capacity.
2. Underdrains placed too shallow and lack of auxiliary structures necessary for the installation.
3. Underdrains of insufficient strength or lacking in other qualities necessary for the installation.
4. Poor construction resulting in inadequacies such as poor connection of joints and fittings, improper bedding, poor grade and alignment, and improper backfilling.
5. Failure due to mineral deposits such as iron oxide. These deposits do not seriously affect the operation of the drain unless the perforations or joints become sealed. Usually indications of deposits may be observed at the outlets, junction boxes and inspection holes.

Surface Maintenance

Vegetated basins can be mowed and maintained in accordance with the VEGETATION section of this chapter. Periodic discing or scraping the surface layers of unvegetated basins may be required following heavy storm events that carry heavy sediment loads. Preliminary indication show that these systems can often function for up to one year with only minor maintenance.

Filter Maintenance

Coarse grained systems may require complete replacement of the filter media to restore their function following clogging since pollutants penetrate further into these systems than in more fine grained filters. Most of the particulates will be trapped in the first 2 or 3 inches (5 - 8 cm) of the latter, while suspended substances can be expected to penetrate up to a foot (30 cm) or more into the coarse grained filter. Semi-annual restoration efforts are likely to involve complete removal and cleaning and or replacement of the top 12 inches (30 cm) or more of the filter material. While major maintenance of this type may not have to be done frequently, when it is required, the operation will involve a significant amount of labor and material. Heavy machinery may be needed if the facility is large and therefore care will be needed to prevent damage to the underdrain pipes. There may be some problems associated with the ability of these more coarse grained, evenly graded materials to support machinery needed to perform maintenance activities, such as scraping without getting equipment stuck and/or damaging the filter bed.

Pipe Network Maintenance

The roots of nearby trees and shrubs will penetrate and clog perforated pipe if near enough. If it is found that the underdrain system is not functioning and the outlet is open, the lines should be checked near trees. Obstructions caused by roots can be cleared by a Roto-Rooter type machine, however, this service will be required several times per year until the source of root penetration is eliminated. High pressure hydraulic nozzles have been used with success to clean underdrain filter systems in Florida that have evidence of iron oxide.

NOTE: This segment does not constitute a product or service endorsement.

Another common maintenance problem with underdrains in Florida is to get landowners to keep the outlets free of silt and vegetation where they empty into open ditches. Sediment and fast growing aquatic vegetation might cause the outlets to become entirely plugged within one year after installation, consequently frequent inspections must be made.

MAINTENANCE OF CONVEYANCE SYSTEMS

5.08 STORMWATER CONVEYANCE CHANNEL

Grass-lined channels

During the initial establishment, grass-lined channels should be repaired immediately and grass re-established if necessary. After grass has become established, the channel should be checked periodically to determine if the grass is staying in place. If the channel is to be mowed, it should be done in a manner that will not damage the grass.

Concrete-lined channels

Concrete-lined channels should be checked periodically to ensure that there is no undermining of the channel. Particular attention should be paid to the outlet of the channel. If scour is occurring at the outlet, appropriate energy dissipation measures shall be taken.

Sediment deposition

If the channel is below a high sediment-producing area, sediment should be trapped before it enters the channel. If sediment is deposited in grass-lined channels, it should be removed promptly to prevent damage to the grass. Sediment deposited in riprap and concrete-lined channels should be removed when it reduces the capacity of the channel.

5.10 DIVERSION

Before final stabilization, the diversion should be inspected after every rainfall. Sediment shall be removed from the ditchline and repairs made as necessary. Seeded areas which fail to establish a vegetative cover shall be reseeded as necessary.

FLEXIBLE CHANNEL LINERS: Riprap, Gabions, Grid Confinement System, Cellular Block

Once a flexible channel liner installation has been completed, it should require very little maintenance. It should, however, be inspected periodically to determine if high flows have caused scour beneath the riprap or dislodged any of the stone or block. If repairs are needed, they should be accomplished immediately. The repair should be stronger than the area which failed, and may therefore require grout, concrete, or larger stones.

Many of these systems are designed to incorporate vegetation. Desirable vegetation (turf) should be regularly mowed. Large weeds, shrubs, and trees should be controlled so that roots do not cause premature failure of the system.

MAINTENANCE OF STORMWATER MANAGEMENT STRUCTURES

5.09 PAVED FLUME

Before permanent stabilization of the slope, the structure should be inspected after each rainfall and damages to the slope or paved flume repaired immediately. After the slope is stabilized, little maintenance should be required. During periodic inspections look for bypassing or undermining of the entrance and resulting erosion along the sides. Also check the bottom for scour beyond the apron or energy dissipators, and remove any debris in the energy dissipators.

5.11 LEVEL SPREADER

The level spreader shall be inspected after every rainfall and repairs made if required. Normal vegetative maintenance should be sufficient for continued proper operation. The owner should avoid the placement of any material on, and prevent traffic across, the structure. If the level spreader is damaged, it shall be repaired immediately.

5.12 CHECK DAMS

Check dams should be checked for sediment accumulation after each significant rainfall. Sediment should be removed when it reaches one-fourth of the original height or before. Regular inspections should be made to insure that the center of the dam is lower than the edges. Erosion caused by high flows around the edges of the dam should be corrected immediately. If stone check dams are used in grass-lined channels care must be taken to retrieve any stone which has washed downstream.

5.14 WATERWAY DROP STRUCTURE

Once the waterway drop structure has been constructed and the area around it stabilized, maintenance should be minimal. During routine inspection, however, the channel should be checked for scour above and below the structure. The embankment should be checked to insure that vegetation is well established. The structure itself should be checked for cracking of the concrete, uneven settlement, and piping around the structure.

5.15 OUTLET PROTECTION

Outlets should be inspected after every major storm. Outlet pipes should be in sound structural condition and free of sediment accumulation. Energy dissipators, splash pads, and riprap aprons should be kept free of debris. Look for scour below the outlet. Wherever such erosion is detected, effective measures should be taken quickly to stabilize and protect the affected area.

OTHER STORMWATER MANAGEMENT STRUCTURES

Inlets

Pipe inlets should be inspected for clogging and/or structural integrity after each major storm, and accumulated debris and sediment should be removed as required. Trash racks should be cleaned and should be replaced if missing.

Rodent Guards

Landowners often do not maintain the rodent guards. These appurtenances are sometimes removed, become rusted or plugged, and may never be replaced. These actions invite damage that can lead to the failure of the entire system. The outlet must be inspected periodically to make sure that it is clear, and that these guards are in place and functional.

Control Structures

In addition to inlets and outlets, many stormwater management facilities have control structures to regulate the rate and/ or water level in the facility. These structures must be inspected frequently for sediment and debris. Control structures should be checked annually by the design engineer for structural integrity

MAINTAINING VEGETATION

Turf

Turf is used for erosion protection, water treatment, velocity reduction, and esthetics. Regular mowing and occasional fertilization is required to maintain desired growth. Avoid cutting too short; as this may damage the plant, reduce the desirable friction in channels, and reduce the protection to soil. Lack of mowing can lead to invasion by weeds. In areas which impound or convey stormwater, clippings should be bagged and removed to reduce the organic loading.

Trees and Shrubs

Trees and shrubs have a place in stormwater management systems in places such as wet detention facilities. However there are many areas where trees and shrubs are not desirable! Trees and shrubs should be kept off of dam and emergency spillway areas. Should these plants die, their large and decaying root system can seriously reduce the structural integrity of an embankment. In addition, trees that start to grow in the vicinity of an exfiltration trench or an underdrain system should be removed immediately. This will help to avoid root puncture of the filter fabric through which sediment might enter the structure. When practical, fallen leaves should be removed from stormwater conveyance or impoundment areas.

REFERENCES

Florida Department of Environmental Regulation, 1988, The Florida Development Manual: A Guide to Sound Land and Water Management (Chapter 6). Tallahassee, FL

**CHAPTER 6
BEST MANAGEMENT PRACTICES
VEGETATION FOR EROSION CONTROL**

6.60	SURFACE ROUGHENING	1
6.61	TOPSOILING	7
6.65	TEMPORARY SEEDING	11
6.66	PERMANENT SEEDING	13
6.67	SODDING	17
6.75	MULCHING	23
6.80	TREES, SHRUBS, VINES, AND GROUND COVERS	35
6.85	TREE PRESERVATION AND PROTECTION	43
6.98	VEGETATIVE STREAMBANK STABILIZATION	51

CHAPTER NOTE

The most efficient and cost effective form of erosion control is prevention. The most cost effective, environmentally friendly, and aesthetically pleasing form of prevention is through the use of vegetation. Success depends on the proper application, installation, and maintenance of these vegetative best management practices (BMPs). This chapter presents the basics of vegetative BMPs.

6.60 SURFACE ROUGHENING **(ES BMP 1.60)**

Definition

Providing a rough soil surface with horizontal depressions created by operating a tillage or other suitable implement on the contour, or by leaving slopes in a roughened condition by not fine-grading them.

Purposes

1. To aid in establishment of vegetative cover with seed.
2. To reduce runoff velocity and increase infiltration.
3. To reduce erosion and provide for sediment trapping.

Conditions Where Practice Applies

1. All slopes steeper than 3:1 require surface roughening if they are to be stabilized with vegetation. Acceptable methods include stair step grading, grooving, furrowing, or tracking.
2. Areas with grades less steep than 3:1 should have the soil surface lightly roughened and loosened to a depth of 2 to 4 inches (5 to 10 cm) prior to seeding.
3. Areas which have been graded and will not be stabilized immediately may be roughened to reduce runoff velocity until seeding takes place.

Specifications

Cut Slope Applications for Areas Which Will Not Be Mowed

Cut slopes with a gradient steeper than 3:1 shall be stair-step graded or grooved (See Plate 6.60a and 6.60b).

1. Stair-step grading may be carried out on any material soft enough to be ripped with a bulldozer. Slopes consisting of soft rock with some subsoil are particularly suited to stair-step grading. The ratio of the vertical cut distance to the horizontal distance shall be less than 1:1 and the horizontal portion of the "step" shall slope toward the vertical wall. Individual vertical cuts shall not be more than thirty inches (75 cm) on soft soil materials and not more than forty inches (100 cm) in rocky materials.

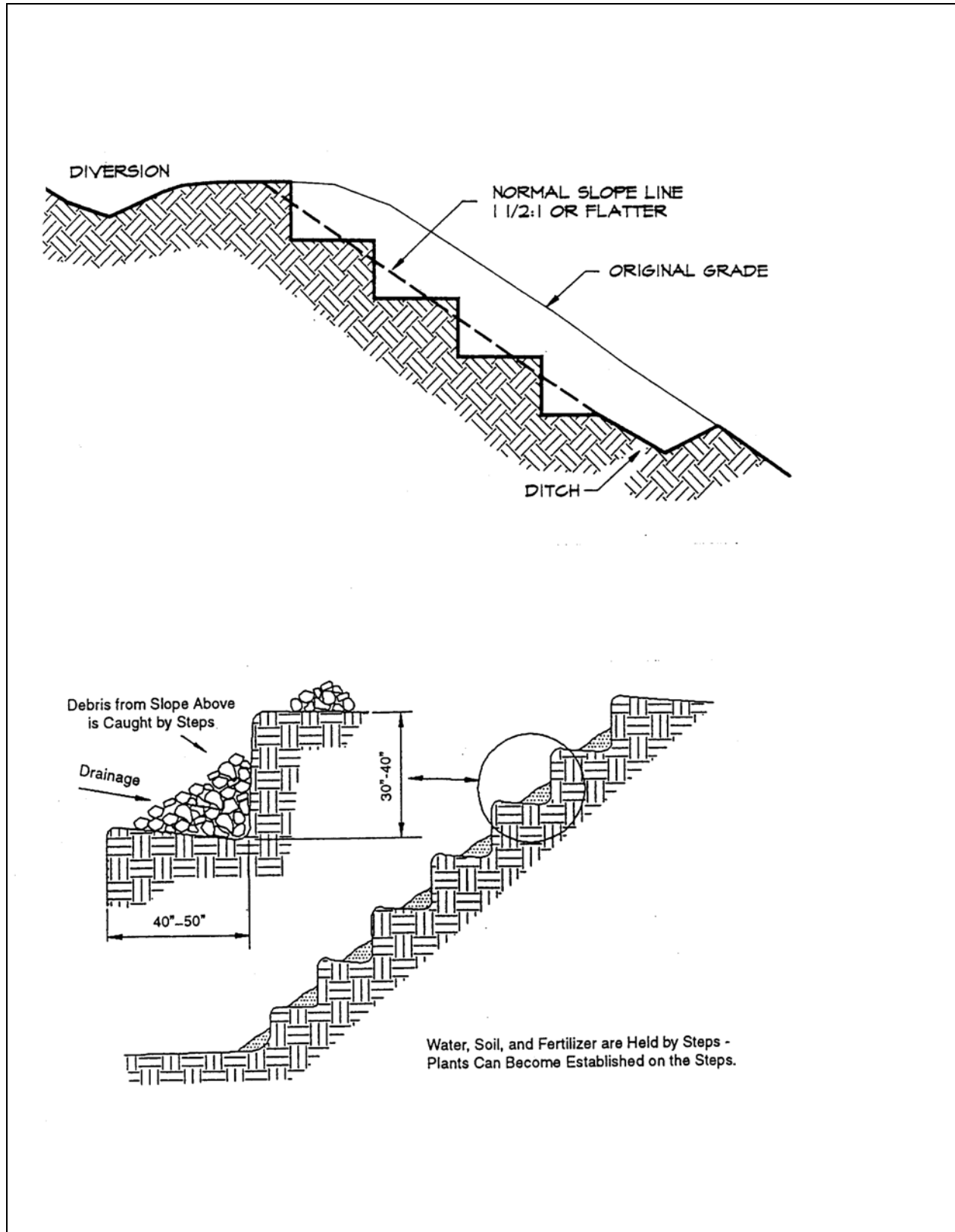

Plate 6.60a Stair Stepped Slope
 Source: Virginia DSWC, Erosion Draw

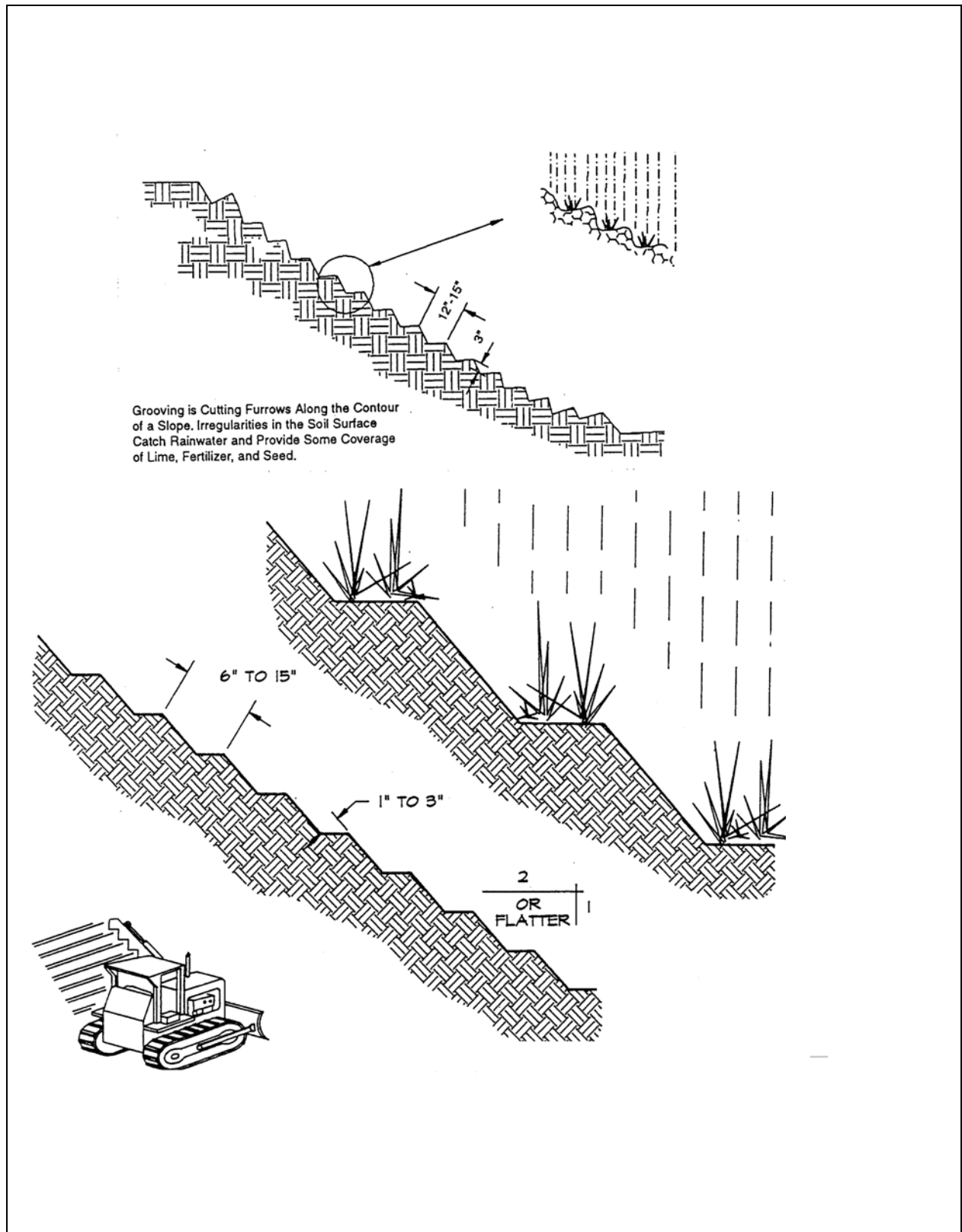

Plate 6.60b Grooved or Serrated Slope

Source: Erosion Draw

2. Grooving consists of using machinery to create a series of ridges and depressions which run perpendicular to the slope (on the contour). Grooves may be made with an appropriate implement which can be safely operated on the slope and which will not cause undue compaction. Suggested implements include discs, tillers, spring harrows, and the teeth on a front-end loader bucket. Such grooves shall not be less than three inches (8 cm) deep nor further than fifteen inches (38 cm) apart.

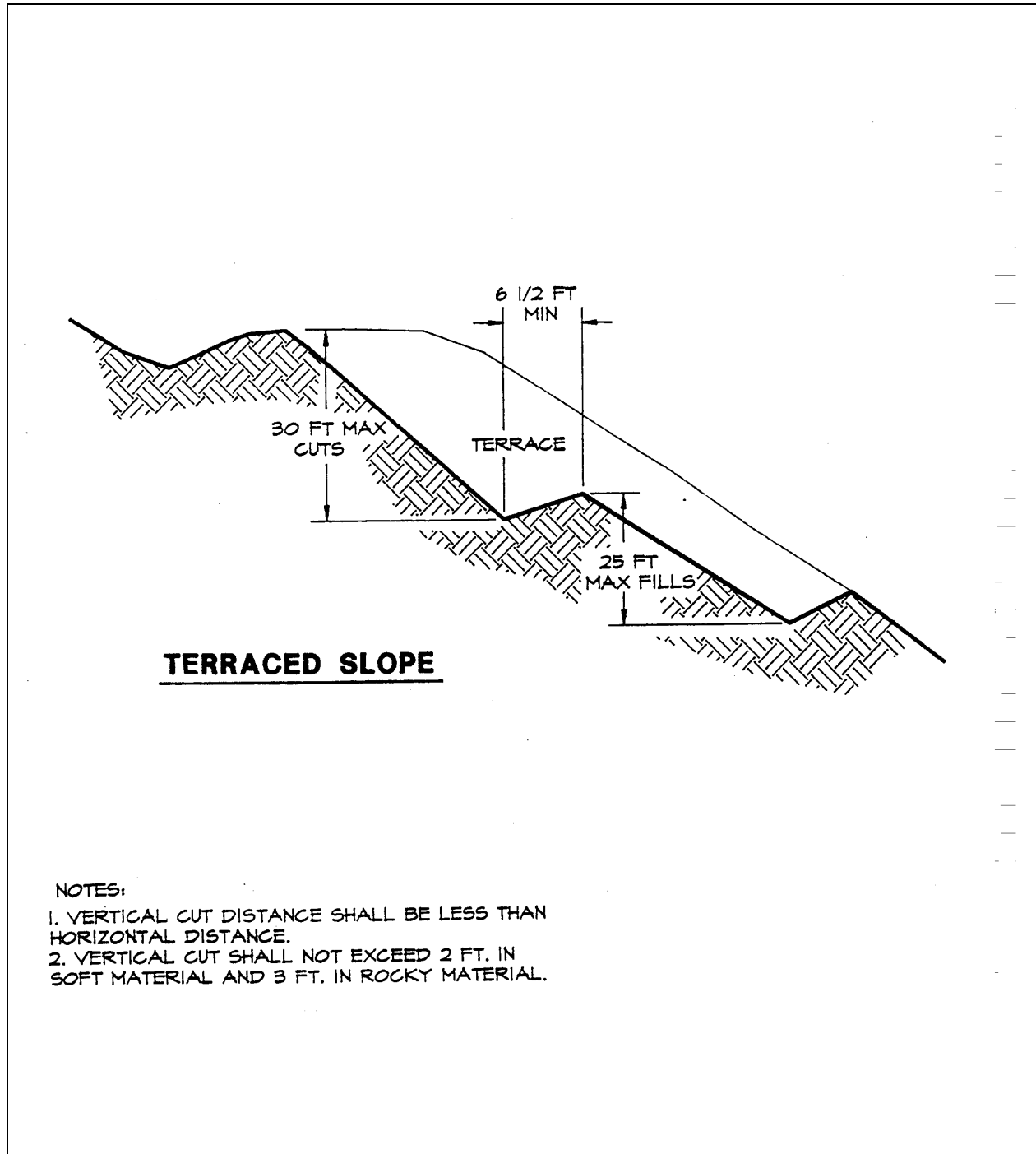

Plate 6.60c Terraced Slope
 Source: Erosion Draw

Fill Slope Applications For Areas Which Will Not Be Mowed

Fill slopes with a gradient steeper than 3:1 shall be grooved or allowed to remain rough as they are constructed. The options are:

1. Groove according to #2, above.
2. As lifts of the fill are constructed, soil and rock materials may be allowed to fall naturally onto the slope surface. (See Plate 6.60a)

Colluvial materials (soil deposits at the base of slopes or from old stream beds) shall not be used in fills as they flow when saturated. At no time shall slopes be bladed or scraped to produce a smooth, hard surface.

Cuts, Fills, and Graded Areas Which Will Be Mowed

Mowed slopes should not be steeper than 3:1. Excessive roughness is undesirable where mowing is planned. These areas may be slightly roughened with shallow grooves such as remain after tilling, discing harrowing, raking, or use of a cultipacker-seeder. The final pass of any such tillage implement shall be on the contour (perpendicular to the slope). Grooves formed by such implements shall not be less than one inch (2.5 cm) deep and not further than twelve inches (30 cm) apart. Fill slopes which are left rough as constructed may be smoothed with a dragline or pickchain to facilitate mowing.

Terracing

Bench terraces consist of one or more diversions placed along a slope to slow and intercept the flow of water. The diversions are constructed either along the contour or sloping gradually to a stabilized waterway. The bench or channel should be at least 6 ft. (2 m) wide to allow for mowing equipment. (See Plate 6.60c)

Roughening With Tracked Machinery

Roughening with tracked machinery on clayed soils is not recommended unless no alternatives are available. Undue compaction of surface soil results from this practice. Sandy soils do not compact severely, and may be tracked. Tracking is not as effective as the other roughening methods described in this chapter.

When tracking is the chosen surface roughening technique, it shall be done by operating tracked machinery up and down the slope to leave horizontal depressions in the soil. As few passes of the machinery should be made as possible to minimize compaction. (See Plate 6.60d)

Seeding

Roughened areas shall be seeded and mulched as soon as possible to obtain optimum seed germination and seedling growth.

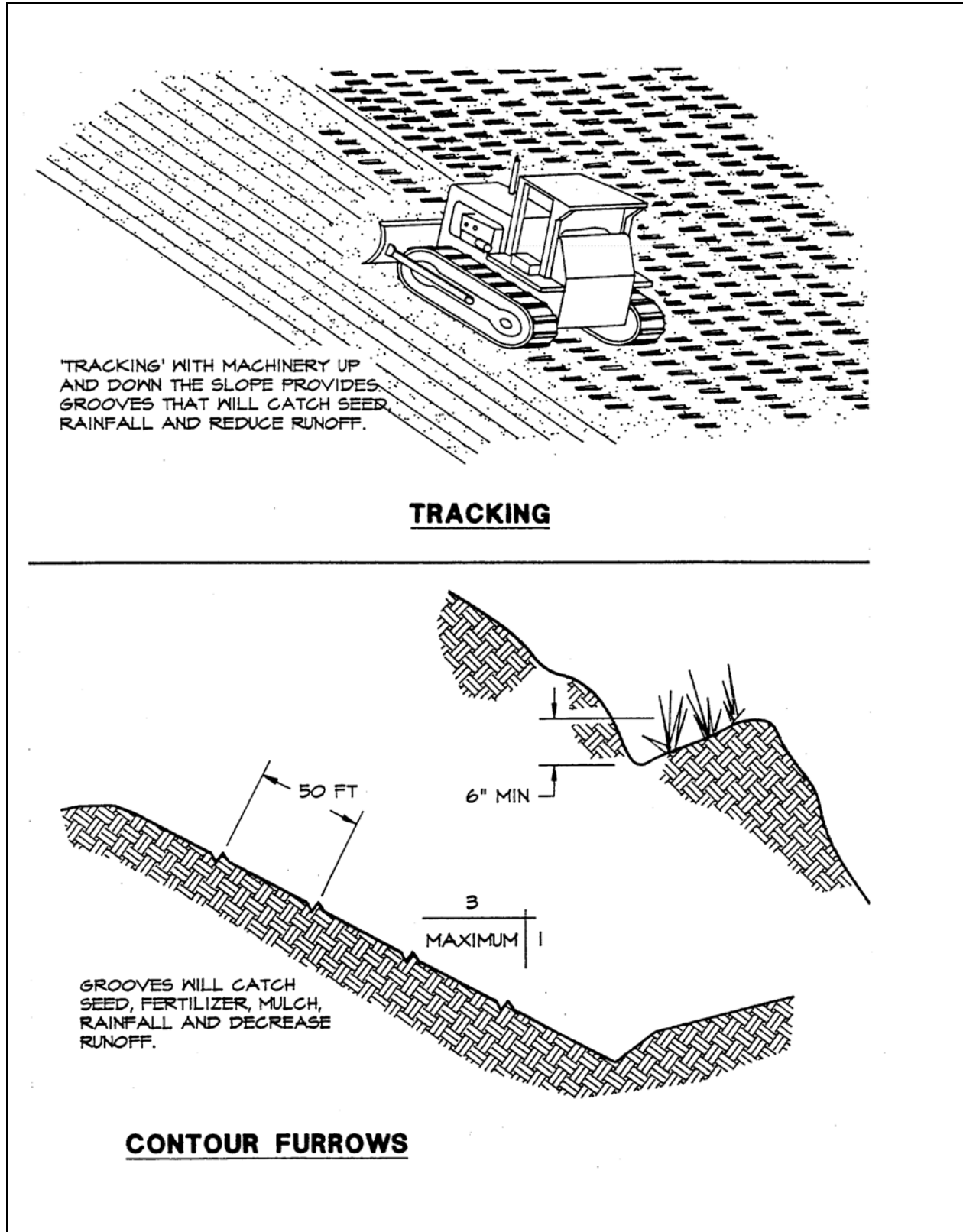

Plate 6.60d Roughening with Tracked Machinery
Source: Erosion Draw

6.61 TOPSOILING **(ES BMP 1.61)**

Definition

Methods of preserving and using topsoil to enhance final site stabilization with vegetation.

Purpose

To provide a suitable growth medium for final site stabilization with vegetation.

Conditions Where Practice Applies

1. Where either the preservation or importation of topsoil is determined to be the most effective method of providing a suitable growth medium.
2. Where the subsoil or existing soil presents the following problems:
 - a. The texture, pH, or nutrient balance of the available soil cannot be modified by reasonable means to provide an adequate growth medium.
 - b. The soil material is too shallow to provide an adequate root zone and to supply necessary moisture and nutrients for plant growth.
 - c. The soil contains substances potentially toxic to plant growth.
3. Where high-quality turf is desirable to withstand intense use or meet aesthetic requirements.
4. Where ornamental plants will be established.
5. Only on slopes that are 2:1 or flatter.

Specifications

Materials

Field evaluation of the site should be made to determine if there is sufficient surface soil of good quality to justify stripping. Topsoil should be friable and loamy (loam, sandy loam, silt loam, sandy clay loam, clay loam). It should be free of debris, trash, stumps, rocks, roots, and noxious weeds, and should give evidence of being able to support healthy plant growth.

Stripping

Stripping should be confined to the immediate construction area. A 4 to 6 inch (10 to 15 cm) stripping depth is common, but depth may vary depending on the particular soil. All perimeter dikes, basins, and other sediment controls shall be in place prior to stripping.

Stockpiling

Topsoil shall be stockpiled in such a manner that natural drainage is not obstructed and no off-site sedimentation occurs. Stockpiles should be planned so as not to interfere with any of the construction operations. Stockpiles can also act as barriers to shield the construction site from the neighborhood and adjacent landowners. They will also help to reduce the amount of dust and noise coming from the site.

Side slopes of the stockpile shall not exceed 2:1.

A perimeter dike with gravel outlet, silt fence, or straw bale barrier shall surround all topsoil stockpiles.

Temporary seeding of stockpiles shall be completed within 15 days of the formation of the stockpile, in accordance with TEMPORARY SEEDING - Section 6.65 (ES BMP 1.65).

Site Preparation Prior to and Maintenance During Topsoiling

Before topsoiling, establish needed erosion and sediment control practices such as diversions, grade stabilization structures, berms, dikes, level spreaders, waterways, sediment basins, etc. These practices must be maintained during topsoiling.

Grading: Previously established grades on the areas to be topsoiled shall be maintained according to the approved plan.

Liming: Where the pH of the subsoil is 6.0 or less, or the soil is composed of heavy clays, agricultural limestone shall be spread in accordance with the soil test or the vegetative establishment practice being used.

Bonding: After the areas to be topsoiled have been brought to grade, and immediately prior to dumping and spreading the topsoil, the subgrade shall be loosened by discing or scarifying to a depth of at least 2 inches (5 cm) to insure bonding of the topsoil and subsoil.

Applying Topsoil

Topsoil shall not be placed while in a muddy condition, when the subgrade is excessively wet, or in a condition that may otherwise be detrimental to proper grading or proposed sodding or seeding. The topsoil shall be uniformly distributed to a minimum compacted depth of 2 inches (5 cm) on 3:1 or steeper slopes, and 4 inches (10 cm) on flatter slopes. (See Table 6.61a to determine volume of topsoil required for application to various depths). Any irregularities in the surface, resulting from topsoiling or other operations, shall be corrected in order to prevent the formation of depressions or water pockets.

It is necessary to compact the topsoil enough to ensure good contact with the underlying soil and to obtain a level seedbed for the establishment of high maintenance turf. However, undue compaction is to be avoided as it increases runoff velocity and volume, and deters seed germination. In areas which are not going to be mowed, the surface should be left rough as per SURFACE ROUGHENING - Section 6.60 (ES BMP 1.60).

Soil Sterilants

No sod or seed shall be placed on soil which has been treated with soil sterilants until sufficient time has elapsed to permit dissipation of toxic materials.

This page left intentionally blank

6.65 TEMPORARY SEEDING **(ES BMP 1. 65)**

Definition

The establishment of a temporary vegetative cover on disturbed areas by seeding with appropriate rapidly growing annual plants.

Purposes

1. To reduce erosion and sedimentation by stabilizing disturbed areas that will not be brought to final grade for a 30 days or more.
2. To reduce problems associated with mud and dust production from bare soil surfaces during construction.

Conditions Where Practice Applies

Where exposed soil surfaces are not to be fine graded for periods from 30 days or more. Such areas include denuded areas, soil stockpiles, dikes, dams, sides of sediment basins, temporary roadbanks, etc.

Specifications

Prior to seeding, install necessary erosion control practices such as dikes, waterways, and basins.

Plant Selection

Select plants appropriate to the season, region, and site conditions. Consult with your local Agricultural Extension agent, county, FDEP, WMD, or FDOT office, or Table 1.65a of The Florida Development Manual.

Seedbed Preparation

To control erosion on bare soil surfaces, plants must be able to germinate and grow. Seedbed preparation is essential. A soil test should be taken to determine liming and fertilization requirements. In the absence of a soil test the following guidelines should be followed:

1. **Liming:** Where soils are known to be highly acid (pH 6.0 and lower), lime should be applied at the rate of two tons of pulverized agricultural limestone per acre.
2. **Fertilizer:** Shall be applied as 450 lbs./acre of 10-20-20 (10 lbs./ 1,000 sq. ft.)(504 kg/ha) or equivalent. Lime and fertilizer shall be incorporated into the top 2 to 4 inches (5 to 10 cm) of the soil.
3. **Surface Roughening:** If the area has been recently loosened or disturbed, no

further roughening is required. When the area is compacted, crusted, or hardened, the soil surface shall be loosened by discing, raking, harrowing, or other acceptable means. See SURFACE ROUGHENING - Section 6.60 (ES BMP 1.60).

4. Tracking: Tracking with bulldozer cleats is most effective on sandy soils. This practice often causes undue compaction of the soil surface, especially in clayey soils, and does not aid plant growth as effectively as other methods of surface roughening.

Seeding

Seed shall be evenly applied with a cyclone seeder, drill, cultipacker seeder or hydroseeder. Small grains shall be planted no more than one inch deep. Grasses and legumes shall be planted no more than 1/4 inch (6 mm) deep.

Mulching

1. Mulching should usually be used to reduce damage from water runoff or wind erosion, and to improve moisture conditions for seedlings. Mulching without seeding should be considered for very short term protection. The use of mulch is a judgment decision based on time of seeding and conditions of individual sites. When used, mulch shall be applied according to MULCHING - Section 6.75 (ES BMP 1.75).
2. Seedings made on slopes in excess of 3:1, or on adverse soil conditions, or during excessively hot or dry weather, shall be mulched according to MULCHING - Section 6.75 (ES BMP 1.75).
3. Seedings made during optimum spring and summer seeding dates, with favorable soil and site conditions, may not require mulch.

Re-seeding

Areas which fail to establish vegetative cover adequate to prevent rill erosion will be filled in with proper topsoil and re-seeded as soon as such areas are identified.

6.66 PERMANENT SEEDING **(ES BMP 1.66)**

Definition

The establishment of perennial vegetative cover on disturbed areas by planting seed.

Purposes

1. To reduce erosion and decrease sediment yield from disturbed areas.
2. To permanently stabilize disturbed areas in a manner that is economical, adaptable to site conditions, and allows selection of the most appropriate plant materials.

Conditions Where Practice Applies

1. Disturbed areas where permanent, long-lived vegetative cover is needed to stabilize the soil.
2. Rough-graded areas which will not be brought to final grade for a year or more.

Specifications

Selection of Plant Materials

1. Selection of plant materials is based on climate, topography, soils, land use, and planting season. To determine which plant materials are best adapted to a specific site, use Tables 1.66b and 1.66c of The Florida Development Manual which describe plant characteristics and list recommended varieties.
2. Appropriate seeding mixtures for various site conditions in Florida are given in Table 1.66a of The Florida Development Manual. These mixtures are designed for general use, and are known to perform well on the sites described. Adhere to these mixtures whenever feasible. Check Tables 1.66b and 1.66c for recommended varieties.

Seedbed Requirements

Vegetation should not be established on slopes that are unsuitable due to inappropriate soil texture, poor internal structure or internal drainage, volume of overland flow, or excessive steepness, until measures have been taken to correct these problems.

To maintain a good stand of vegetation, the soil must meet certain minimum requirements as a growth medium. The existing soil must have these criteria:

1. Enough fine-grained material to maintain adequate moisture and nutrient supply.
2. Sufficient pore space to permit root penetration. A bulk density of 1.2 to 1.5

indicates that sufficient pore space is present. A fine granular or crumb-like structure is also favorable.

3. Sufficient depth of soil to provide an adequate root zone. The depth to rock or impermeable layers such as hardpans shall be 12 inches (30 cm) or more, except on slopes steeper than 2:1 where the addition of soil is not feasible.
4. A favorable pH range for plant growth. If the soil is so acid that a pH range of 6.0 - 7.0 cannot be attained by addition of pH-modifying materials, then the soil is considered an unsuitable environment for plant roots.
5. Freedom from toxic amounts of materials harmful to plant growth.
6. Freedom from excessive quantities of roots, branches, large stones, large clods of earth, or trash of any kind. Clods and stones may be left on slopes steeper than 3:1 if they are to be hydroseeded.

If any of the above criteria cannot be met, i.e., if the existing soil is too coarse, dense, shallow, acid, or contaminated to foster vegetation, then topsoil should be applied in accordance with TOPSOILING - Section 6.61 (ES BMP 1.61).

Necessary mechanical erosion and sediment control practices ***will be installed prior to seeding***. Grading will be carried out according to the approved plan.

Surfaces will be roughened in accordance with SURFACE ROUGHENING - Section 6.60 (ES BMP 1.60).

Soil Conditioners

In order to modify the texture, structure, or drainage characteristics of a soil, the following materials may be added to the soil:

1. Peat shall be sphagnum moss peat, hypnum moss peat, reed-sedge peat or peat humus, from fresh-water sources. Peat shall be shredded and conditioned in storage piles for at least six months after excavation.
2. Sand shall be clean and free of toxic materials.
3. Vermiculite shall be horizontal grade and free of toxic substances.
4. Rotted manure shall be stable or cattle manure not containing undue amounts of straw or other bedding materials or toxic chemicals.
5. Thoroughly rotted sawdust shall be 6 lbs. of nitrogen added to each cubic yard (3.5 kg/m³) and shall be free of stones, sticks, and toxic substances.
6. Where local ordinances permit, treated sewage sludge may be used in accordance with local, state, and federal regulations.

Lime and Fertilizer

Lime and fertilizer needs should be determined by soil tests. Soil tests may be performed by the Cooperative Extension Service Soil Testing Laboratory at the U.F., or by a reputable commercial laboratory. Information concerning the State Soil Testing Laboratory is available from county extension agents. Under unusual conditions where it is not possible to obtain a soil test, the following soil amendments will be applied:

LIME: 2 tons/acre finely ground agricultural or dolomitic limestone (90 lbs./1000 ft²)(4.48 t/ha)

FERTILIZER: Mixed grasses and legumes: 1000 lbs./acre 5-20-10 (25 lbs./1000 ft²)(1.12 t/ha)

Legume stands only: 1000 lbs./acre 5-20-10 (25 lbs./1000 ft²)(1.12 t/ha)

Grass stands only: 1000 lbs./acre 5-20-10 (1.12 t/ha) and 300 lbs. of 38-0-0 in spring (7 lbs./1000 ft²)(336 kg/ha)

1000 lbs./acre 10-20-10 (1.12 t/ha) and 300 lbs. of 38-0-0 in fall (7 lbs./1000 ft²)(336 kg/ha)

Other fertilizer formulations may be used, provided they can supply the same amounts and proportions of plant nutrients.

Incorporation - Lime and fertilizer shall be incorporated into the top 4 - 6 inches (10 - 15 cm) of the soil by disking or other means. When applying lime and fertilizer with a hydroseeder, apply to a rough, loose surface.

Seeding

1. Certified seed should be used for all permanent seeding whenever possible.
2. Legume seed - Legume seed should be inoculated with the inoculant appropriate to the species. Seed of lespendezas, crown vetch, and clovers should be scarified to promote uniform germination.
3. Apply seed uniformly with a cyclone seeder, drill, cultipacker seeder, or hydroseeder on a firm, friable seedbed. Maximum seeding depth should be 1/4 inch.
4. Hydroseeding - To avoid seed damage, it is recommended that if a machinery breakdown of 30 minutes to 2 hours occurs, 50% more seed be added to the tank, based on the proportion of the slurry remaining in the tank. Beyond 2 hours, a full rate of new seed may be necessary.

Often hydroseeding contractors prefer not to apply lime in their rigs as it is abrasive. In inaccessible areas, lime may have to be applied in pelletized or liquid form,

separately. Rates of wood fiber should be at least 2000 lbs. per acre (2.24 t/ha). Surface roughening is particularly important when hydroseeding, as a roughened slope will provide some natural coverage of lime, fertilizer, and seed.

5. Legume inoculants should be used by the date indicated on the container. When dry seeding use four times the manufacturer's recommended rate and use ten times the recommended rate of inoculant when hydroseeding.

Mulching

All permanent seeding must be mulched immediately upon completion of seed application. Refer to MULCHING - Section 6.75 (ES BMP 1.75).

Maintenance of New Seedings

Irrigation: New seedings should be supplied with adequate moisture. Supply water as needed, especially late in the season, in abnormally hot or dry weather, or on adverse sites. Water application rates should be controlled to prevent runoff. Inadequate amounts of water may be more harmful than no water.

Re-seeding: Inspect seeded areas for failure and make necessary repairs and reseedings within the same season, if possible.

1. If vegetative cover is inadequate to prevent rill erosion, overseed and fertilize in accordance with soil test results.
2. If a stand has less than 40% cover, re-evaluate choice of plant materials and quantities of lime and fertilizer. Re-establish the stand following seedbed preparation and seeding recommendations, omitting lime and fertilizer in the absence of soil test results. NOTE: if vegetation has failed to grow, soil must be tested to determine if acidity or nutrient imbalances are responsible.

Fertilization: Seedlings should be fertilized one year after planting to insure proper stand density.

1. To established all-grass stands, apply 500 lbs./acre of 10-20-10 (12 lbs./1000 ft²)(560 kg/ha) between August 15 and November 15. (The first fall following seeding.)
2. To legume-and-grass stands or pure legume stands, apply 500 lbs./acre of 0-20-20 (12 lbs./1000 ft²)(560 kg/ha) in early May or between August 15-October 15.

GENERALLY, A STAND OF VEGETATION CANNOT BE DETERMINED TO BE FULLY ESTABLISHED UNTIL SOIL COVER HAS BEEN MAINTAINED FOR ONE FULL YEAR FROM PLANTING. DISTURBED AREAS WHICH ARE TO BE STABILIZED WITH PERMANENT VEGETATION MUST BE SEEDED OR PLANTED WITHIN 15 DAYS AFTER FINAL GRADE IS REACHED UNLESS TEMPORARY STABILIZATION IS APPLIED.

6.67 SODDING **(ES BMP 1.67)**

Definition

Stabilizing fine-graded disturbed areas by establishing permanent grass stands with sod.

Purposes

1. To establish permanent turf immediately.
2. To prevent erosion and damage from sediment and runoff by stabilizing the soil surface.
3. To reduce the production of dust and mud associated with bare soil surfaces.
4. To stabilize drainageways where concentrated overland flow will occur.

Conditions Where Practice Applies

1. Disturbed areas which require immediate vegetative covers, or where sodding is preferred to other means of grass establishment.
2. Locations particularly suited to stabilization with sod are:
 - a. slopes and buffer strips.
 - b. waterways and swales, especially around drop inlets.
 - c. residential or commercial lawns where quick use or aesthetics are factors.

Specifications

Soil Preparation

1. Prior to soil preparation, areas to be sodded shall be brought to final grade in accordance with the approval plan. These operations should leave as much topsoil as possible or replace the topsoil to a depth of four inches (10 cm).
2. Soil tests should be made to determine the exact requirements for lime and fertilizer. Soil tests may be conducted by the State Laboratory at the University of Florida or a reputable commercial laboratory. Information on state soil tests is available from county agricultural extension agents.

When a soil test is not made the following soil amendments should be made:

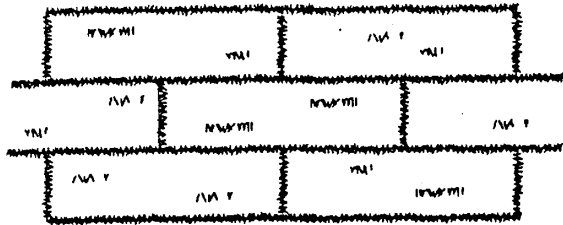

LAY SOD IN A STAGGERED PATTERN. BUTT THE STRIPS TIGHTLY AGAINST EACH OTHER. DO NOT LEAVE SPACES AND DO NOT OVERLAP. A SHARPENED MASON'S TROWEL IS A HANDY TOOL FOR TUCKING DOWN THE ENDS AND TRIMMING PIECES.

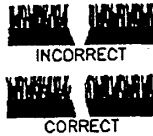

BUTTING - ANGLED ENDS CAUSED BY THE AUTO-MATIC SOD CUTTER MUST BE MATCHED CORRECTLY.



ROLL SOD IMMEDIATELY TO ACHIEVE FIRM CONTACT WITH THE SOIL.

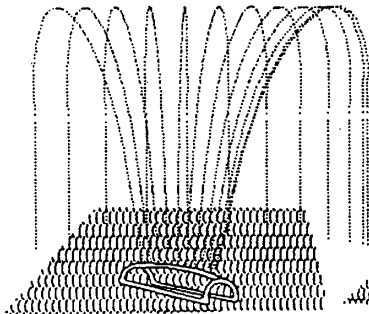

WATER TO A DEPTH OF 4" AS NEEDED. WATER WELL AS SOON AS THE SOD IS LAID.

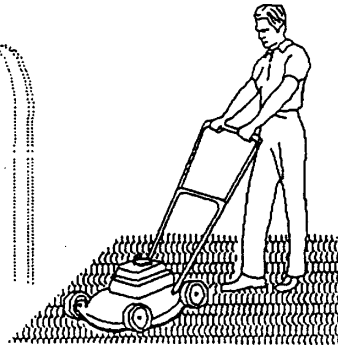

MOW WHEN THE SOD IS ESTABLISHED - IN 2-3 WEEKS. SET THE MOWER HIGH (2"-3").

Appearance of Good Sod

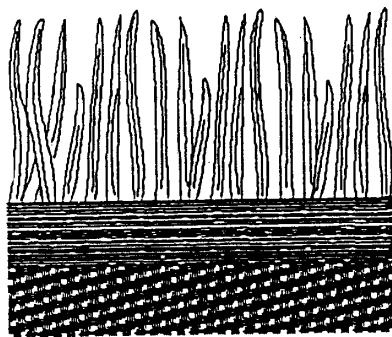

SHOOTS OR GRASS BLADES. GRASS SHOULD BE GREEN AND HEALTHY, MOWED AT A 2"-3" CUTTING HEIGHT.

THATCH - GRASS CLIPPINGS AND DEAD LEAVES, UP TO 1/2" THICK.

ROOT ZONE - SOIL AND ROOTS. SHOULD BE 1/2"-3/4" THICK, WITH DENSE ROOT MAT FOR STRENGTH.

Plate 6.67a Sodding
Source: Virginia DSWC

Pulverized agricultural limestone at 100 lbs./1000 ft² (2 tons/acre)(4.48 t/ha)

Fertilizer at 25 lbs./1000 ft² (1000 lbs./acre)(1.12 t/ha) of 10-10-10 in fall or 25lbs./1000 ft² of 5-10-10 in spring. NOTE: Equivalent nutrients may be applied with other fertilizer formulations.

These amendments shall be spread evenly over the area to be sodded, and incorporated into the top 3 - 6 inches (8 - 15 cm) of the soil by discing, harrowing or other acceptable means.

3. Prior to laying sod, the soil surface shall be clear of trash, debris, roots, branches, stones and clods in excess of 2 inches (5 cm) in length or diameter. Sod shall not be applied to gravel or other non-soil surfaces.
4. Any irregularities in the soil surface resulting from topsoil or other operations shall be filled or leveled in order to prevent the formation of depressions or water pockets.
5. Areas to be topsoiled and topsoil used shall fulfill the requirements of TOPSOILING - Section 6.61 (ES BMP 1.61). No sod shall be spread on soil which has been treated with soil sterilants until enough time has elapsed to permit dissipation of toxic materials.

Sod Quality

1. Sod should be free of weeds and undesirable coarse weedy grasses. If possible, Certified or Approved turfgrass sod should be used.
2. Sod shall be machine cut at a uniform soil thickness of 3/4 inch (20 mm), plus or minus 1/4 inch (6 mm), at the time of cutting. This thickness shall exclude shoot growth and thatch.
3. Pieces of sod shall be cut to the supplier's standard width and length, with a maximum allowable deviation in any dimension of 5%. Torn or uneven pads will not be acceptable.
4. Standard size sections of sod shall be strong enough to support their own weight and retain their size and shape when suspended from a firm grasp on one end of the section.
5. Sod shall be not cut or laid in excessively wet or dry weather.
6. Sod shall be harvested, delivered, and installed within a period of 36 hours

Sod Installation

A. Solid Sodding (Plate 6.67a)

1. Irrigate areas to be sodded with a minimum of 1/2-inch (13 mm) of water unless

recent rains have provided equivalent moisture.

2. The first row of sod shall be laid in a straight line with subsequent rows placed parallel to and butting tightly against each other. Lateral joints shall be staggered to promote more uniform growth and strength. Care shall be exercised to insure that sod is not stretched or overlapped and that all joints are butted tight in order to prevent voids which would cause drying of the roots.

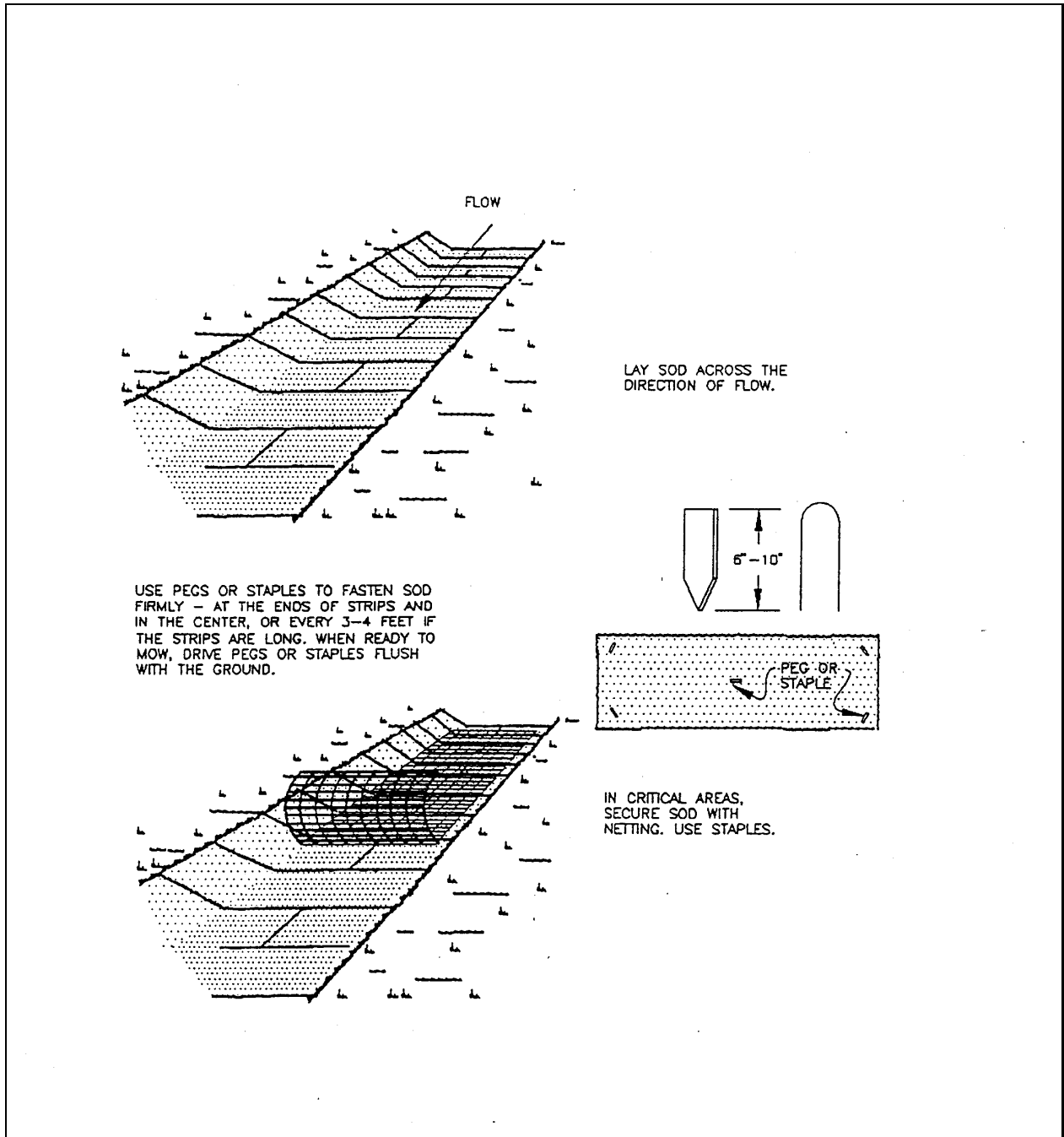

Plate 6.67b Sodding Swales and Waterways
 Source: Virginia DSWC

3. On slopes 3:1 or greater, or wherever erosion may be a problem, sod shall be laid with staggered joints and secured by pegging or other approved methods. Sod shall be installed with the length perpendicular to the slope (on the contour). Begin laying sod at the bottom of the slope and work uphill. On very steep slopes, the use of ladders will facilitate the work and prevent damage to the sod.
4. Surface water cannot always be diverted from flowing over the face of the slope, but a capping strip of heavy jute or erosion netting, properly secured, along the crown of the slope will provide extra protection against lifting and undercutting of sod. This same technique can be used to fortify sod in water-carrying channels and other critical areas. Use wire staples to anchor heavy jute or erosion netting in channels.
5. As sodding of clearly defined areas is completed, sod shall be rolled or tamped to provide firm contact between roots and soil.
6. After rolling, sod shall be irrigated to a depth sufficient that the underside of the sod pad and the soil 4 inches (10 cm) below the sod is thoroughly wet.
7. During the first week, in the absence of adequate rainfall, watering shall be performed as often as necessary to maintain moist soil to a depth of at least 4 inches (10 cm).
8. The first mowing shall not be attempted until the sod is firmly rooted, usually after 2 - 3 weeks. Not more than 1/3 of the grass leaf should be removed at any one cutting.

B. Spot Sodding

1. Spot sodding is the planting of plugs or blocks, a minimum of 4 inches (10 cm) in diameter or square, of sod at measured intervals. The plugs or blocks should be placed one foot (30 cm) apart.
2. Sod spots within a row should be placed alternately and not directly opposite sod spots in adjacent rows.
3. Fit the plugs or blocks tightly into prepared holes and tamp them firmly into place.
4. Irrigate to a depth sufficient that the underside of the sod spot and the soil 4 inches (10 cm) below the sod is thoroughly wet.

C. Strip Sodding

1. Areas to be strip sodded should be fertilized, limed, prepared and smoothed as in solid sodding.
2. Lay the strips end to end in rows that are from 1 to 1-1/2 feet (30 to 45 cm) apart with the strips a minimum of 2 to 4 inches (5 to 10 cm) wide.

3. Roll or tamp the strips thoroughly to provide firm contact between roots and soil.
4. Irrigate to a depth sufficient that the underside of the strips and the soil 4 inches (10 cm) below the strips are wet.

D. Sodded Swales and Waterways (Plate 6.67b)

1. Care should be taken to prepare the soil adequately in accordance with this specification. The sod type shall consist of plant materials able to withstand the designed velocity. (See STORMWATER CONVEYANCE CHANNELS - Section 6.35 (ES BMP 1.35).
2. Sod strips in swales and waterways shall be laid perpendicular to the direction of flow. Care should be taken to butt ends of strips tightly.
3. After rolling or tamping, sod shall be pegged or stapled to resist washout during the establishment period. Chicken wire, jute or other netting may be pegged over the sod for extra protection in critical areas.
4. All other specifications for this practice shall be adhered to when sodding a swale or waterway.

Maintenance of Established Sod

1. After the first week, sod shall be watered as necessary to maintain adequate moisture in the root zone and prevent dormancy.
2. Apply lime and fertilizer under a regular program based on soil tests and on the use and general appearance of the vegetative cover. In the absence of a soil test apply 1 - 2 tons/acre (45 - 90 lbs./1000 ft²)(2.24 to 4.48 t/ha) of finely ground agricultural limestone every three years. Apply 400 - 500 lbs./acre (9 - 18 lbs./1000 ft²)(450 - 560 kg/ha) of 10-10-10 fertilizer. To obtain better vegetative cover, topdress with 150 - 300 lbs./acre (6 - 12 lbs./1000 ft²)(170 - 340 kg/ha) of 16-4-4 fertilizer during the growing season, but at least six weeks before the end of the growing season. If Centipede or St. Augustine grass is used, do not apply more than 1 pound of actual nitrogen per 1000 ft² (20 - 40 lbs./acre)(22 - 44 kg/ha).
3. Mow to control weeds, improve the appearance of the vegetative cover, and to reduce fire hazard, as necessary. In general, the coarser the leaf texture of the grass, the higher it should be cut. Continuous close mowing will result in loss of vigor and reduced stand. No more than 1/3 of the grass leaf should be removed in any mowing.

6.75 MULCHING **(ES BMP 1.75)**

Definition

Application of plant residues or other suitable materials to the soil surface.

Purposes

1. To prevent erosion by protecting the soil surface from raindrop impact and reducing the velocity of overland flow.
2. To foster the growth of vegetation by increasing available moisture and providing insulation against extreme heat and cold.

Conditions Where Practice Applies

1. Areas which have been permanently seeded should be mulched immediately following seeding.
2. Areas which cannot be seeded because of the season should be mulched to provide temporary protection to the soil surface. An organic mulch (not wood fiber alone) shall be used, and the area then seeded as soon as feasible in spring.
3. Mulch shall be used together with plantings of trees, shrubs, or certain ground covers which do not provide adequate soil stabilization by themselves.
4. Mulch shall be used in conjunction with temporary seeding operations specified in TEMPORARY SEEDING - Section 6.65 (ES BMP 1.65).
5. Mulches used in areas of concentrated flows or frequent inundation shall be properly anchored to prevent them from floating away.

Specifications

Types of Mulches

1. Organic Mulches

Organic mulches may be used in any area where mulch is required, subject to the restrictions noted in Table 6.75a. Select mulch material based on site requirements, availability of materials, and availability of labor and equipment. Table 6.75a lists the most commonly used organic mulches. Other materials, such as peanut hulls and cotton burs, may be used.

Mulch materials shall be spread uniformly, by hand or machine. When spreading straw by hand, divide the area to be mulched into approximately 1000 sq. ft. sections and place 70 - 90 lbs. (1-1/2 to 2 bales)(30 - 40 kg) of straw in each section

to facilitate uniform distribution.

2. Nets , Mats, and Blankets

Nets may be used alone on level areas, on slopes no steeper than 3:1, and in waterways as specified in STORMWATER CONVEYANCE CHANNELS - Section 5.35 (ES BMP 1.35). When mulching is done in late fall or during June, July, or August, or where soil is highly erodible, net should only be used in conjunction with an organic mulch such as straw. When net and organic mulch are used together, the net should be installed over the mulch except when the mulch is wood fiber. Wood fiber may be sprayed on top of the installed net. Excelsior binders are considered protective mulches and may be used alone on erodible soils and during all times of year.

Table 6.75a - Mulch Application

Mulches	Rate per acre	Rate per 1000 sq.ft.	Notes
Straw	1.5 - 2 tons	70 - 90 lbs.	Free from weeds and coarse matter. Must be anchored. Spread with mulch blower or by hand.
Wood Fibers	0.5 - 1.0 tons	25 - 50 lbs.	Fibers 1.5" min. length. Do not use alone in winter or during hot, dry weather. Apply as slurry.
Corn Stalks	4 - 6 tons	185 - 275 lbs.	Cut or shredded in 4 - 6" lengths. Air-dried. Do not use in fine turf areas. Apply with mulch blower or by hand.
Wood Chips	4 - 6 tons	185 -275 lbs.	Free of coarse matter. Air-dried. Treat with 12 lbs nitrogen per ton. Do not use in fine turf areas. Apply with mulch blower, chip handler, or by hand.
Shredded Bark Chips	50 - 70 cu. yds.	1 - 2 cu. yds.	Free of coarse matter. Air-dried. Do not use in fine turf areas. Apply with mulch blower, chip handler, or by hand.

Table 6.75a Organic Mulch Materials and Application Rates

Source: Virginia SWCC

Jute net shall be heavy, uniform cloth woven of single jute yarn, which if 36 to 48 inches (90 to 120 cm) wide shall weigh an average of 1.2 pounds per linear yard (0.6 kg/m). Other products designed to control erosion shall conform to manufacturer's specification and should be applied in accordance with manufacturer's instructions provided those instructions are at least as stringent as

this specification. Examples of these products are Erosionet, Holdgro, Weedchek, and Curlex. (Use of trade names does not constitute an endorsement of products by FDEP). In no case shall these products cover less than 30% of the soil surface

3. Chemical Mulches

Chemical mulches may be used alone only in the following situations:

- a. Where no other mulching material is available.
- b. In conjunction with temporary seeding during the times when mulch is not required for that practice.
- c. From May 1 to June 15 and September 15 to October 15, provided that they are used on areas with slopes no steeper than 4:1, which have been roughened in accordance with SURFACE ROUGHENING - Section 6.60 (ES BMP 1.60).

Prior to installation:

1. Shape and grade as require the waterway, channel, slope, or other area to be protected.
2. Remove all rocks, clods, or debris larger than 2 inches in diameter that will prevent contact between the net and the soil surface.
3. Lime and fertilizer should be incorporated and surface roughening accomplished as needed. Seed should be applied prior to mulching except in the following cases:
 - a. Where seed is to be applied as part of a hydroseeder slurry containing wood fiber mulch.
 - b. Where seed is to be applied following a straw mulch spread during winter months.
 - c. Where a hydroseeder slurry is applied over straw.

Mulch Anchoring: Straw mulch must be anchored immediately after spreading to prevent windblow. Other organic mulches listed in Table 6.75a do not require anchoring. The following methods of anchoring straw may be used:

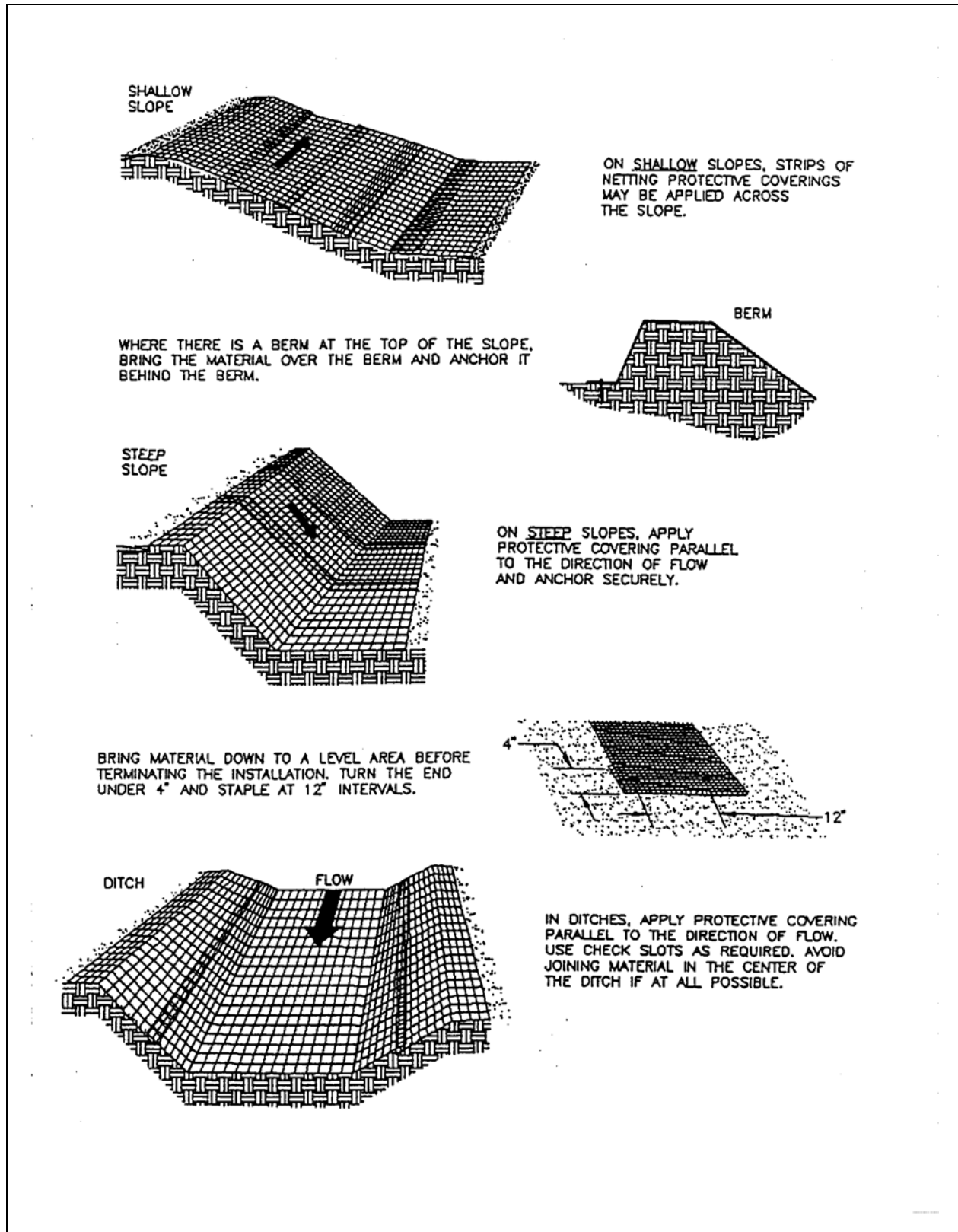

Plate 6.75a Typical Orientation of Treatment 1 - Soil Stabilization Blanket

Source: Adapted from Ludlow Products Brochure

1. Mulch anchoring tool: This is a tractor-drawn implement designed to punch mulch into the soil surface. This method provides maximum erosion control with straw. It is limited to use on slopes no steeper than 3:1, where equipment can operate safely. Machinery shall be operated on the contour.
2. Liquid mulch binders: Application of liquid mulch binders and tackifiers should be heaviest at edges of areas and at crests of ridges and banks, to prevent windblow. The remainder of the area should have binder applied uniformly. Binders may be applied after mulch is spread or may be sprayed into the mulch as it is being blown onto the soil. Applying straw and binder together is the most effective method.

Chemical binders such as Petroset, Terratack, Road Oyl, and Aerospray may be used as recommended by the manufacturer to anchor mulch. These are expensive and therefore usually used in small areas or in residential areas where asphalt may be a problem. (Use of trade names does not constitute an endorsement by FDEP).

3. Mulch nettings - Lightweight plastic, cotton, or paper nets may be stapled over the mulch. Netting shall be secured by stakes, staples, or pins according to manufacturer's recommendations. See Plate 6.75g for details.
4. Peg and Twine - Because it is labor intensive, this method is feasible only in small areas where other methods cannot be used. Drive 8 - 10 inch (20 -25 cm) wooden pegs to within 3 inches (8 cm) of the soil surface, every 4 feet (1.2 m) in all directions. Stakes may be driven before or after straw is spread. Secure mulch by stretching twine between pegs in a criss-cross-within-a-square pattern. Turn twine 2 or more times around each peg.

Laying Nets, Mats, and Blankets

Nets, mats, and blankets should be installed according to the manufacturers' instructions, provided that they are at least as stringent as stringent as the general recommendations below.

1. Start laying net from top of channel or top of slope and unroll downgrade.
2. Allow to lay loosely on soil--do not stretch.
3. **To secure net**: Upslope ends of net should be buried in a slot or trench no less than 6 inches (15 cm) deep. Tamp earth firmly over net. Staple the net every 12 inches (30 cm) across the top end. Edges of net shall be stapled every 3 feet (90 cm). Where 2 strips of net are laid side by side, the adjacent edges shall be overlapped 3 inches (8 cm) and stapled together. Staples shall be placed down the center of net strips at 3-foot (90 cm) intervals. **DO NOT STRETCH** net when applying staples.

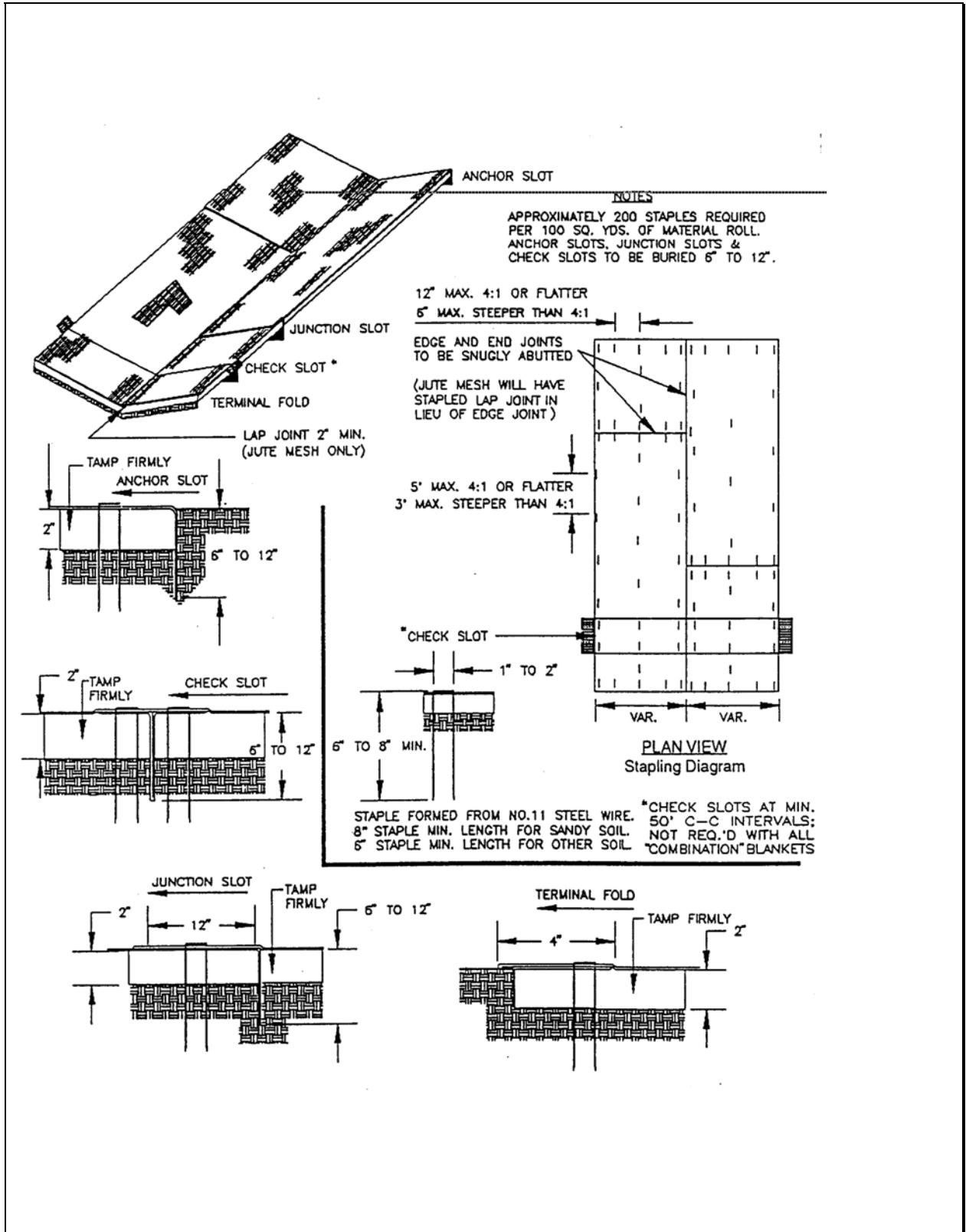

Plate 6.75b Typical Treatment 1 - Soil Stabilization Blanket Installation Guide
Source: VDOT Road and Bridge Standards

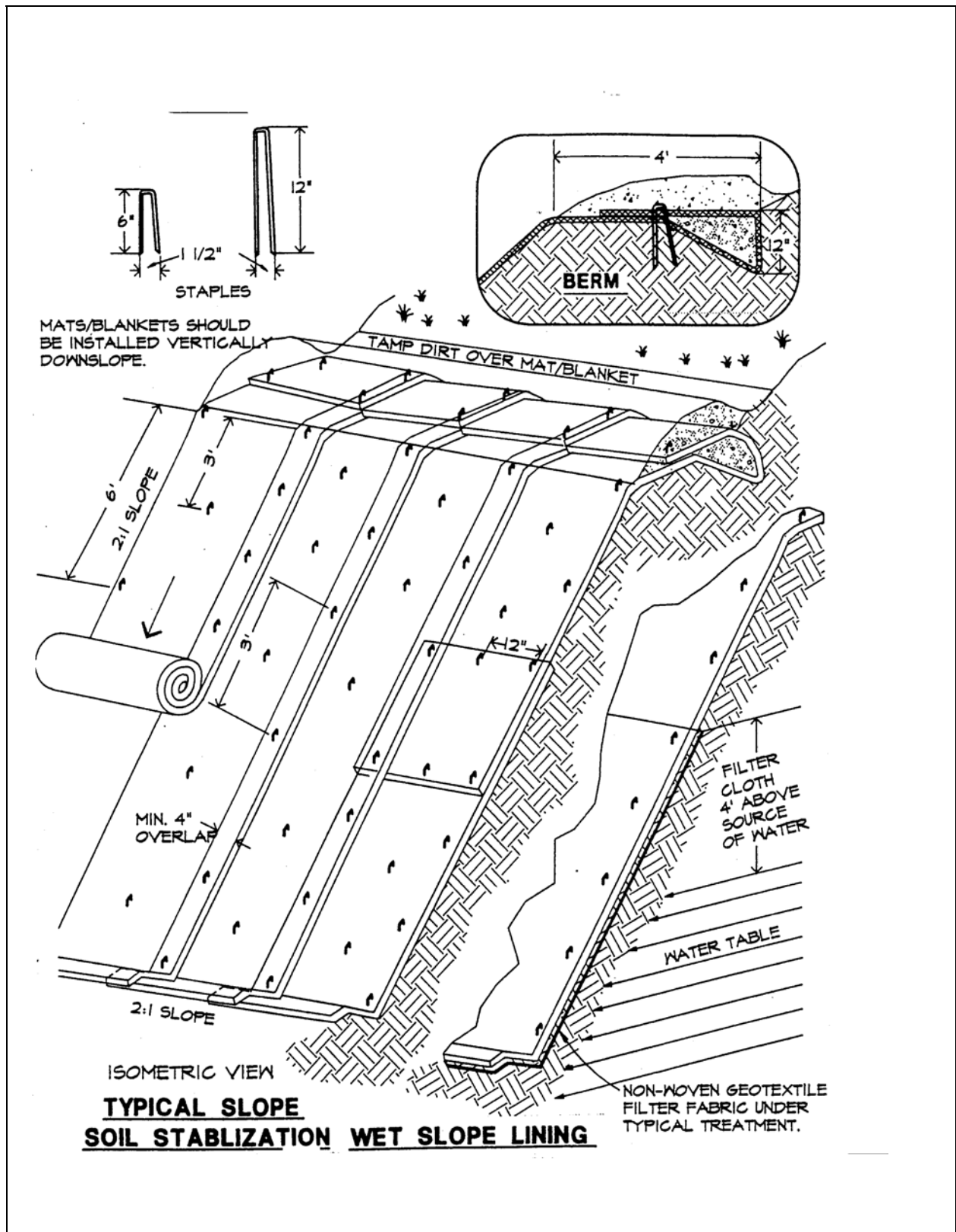

Plate 6.75c Erosion Blankets and Turf Reinforcement Mats - Slope Installation

Source: Erosion Draw

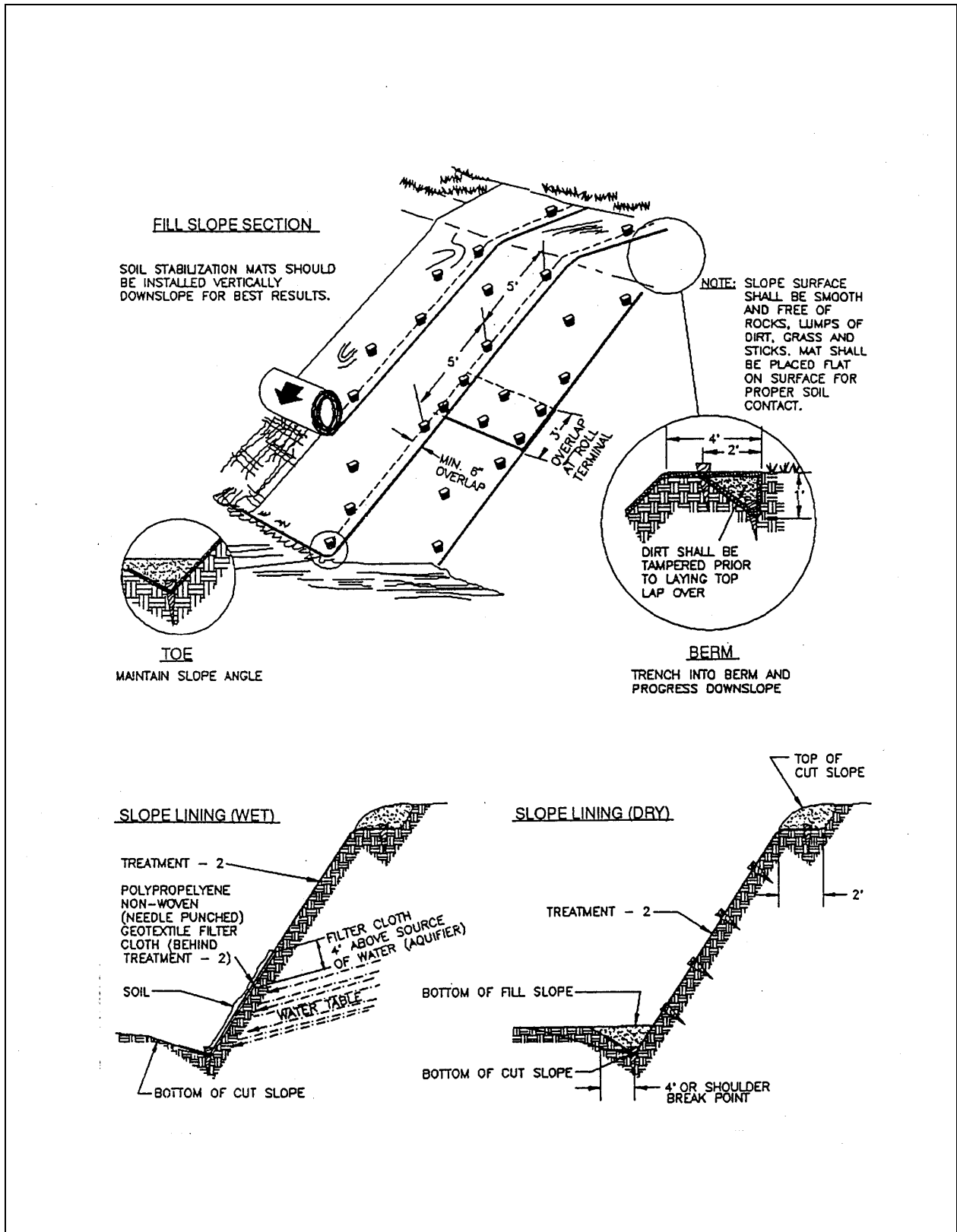

Plate 6.75d Typical Treatment 2 - Soil Stabilization Matting Slope Installation

Source: VDOT Road and Bridge Standards

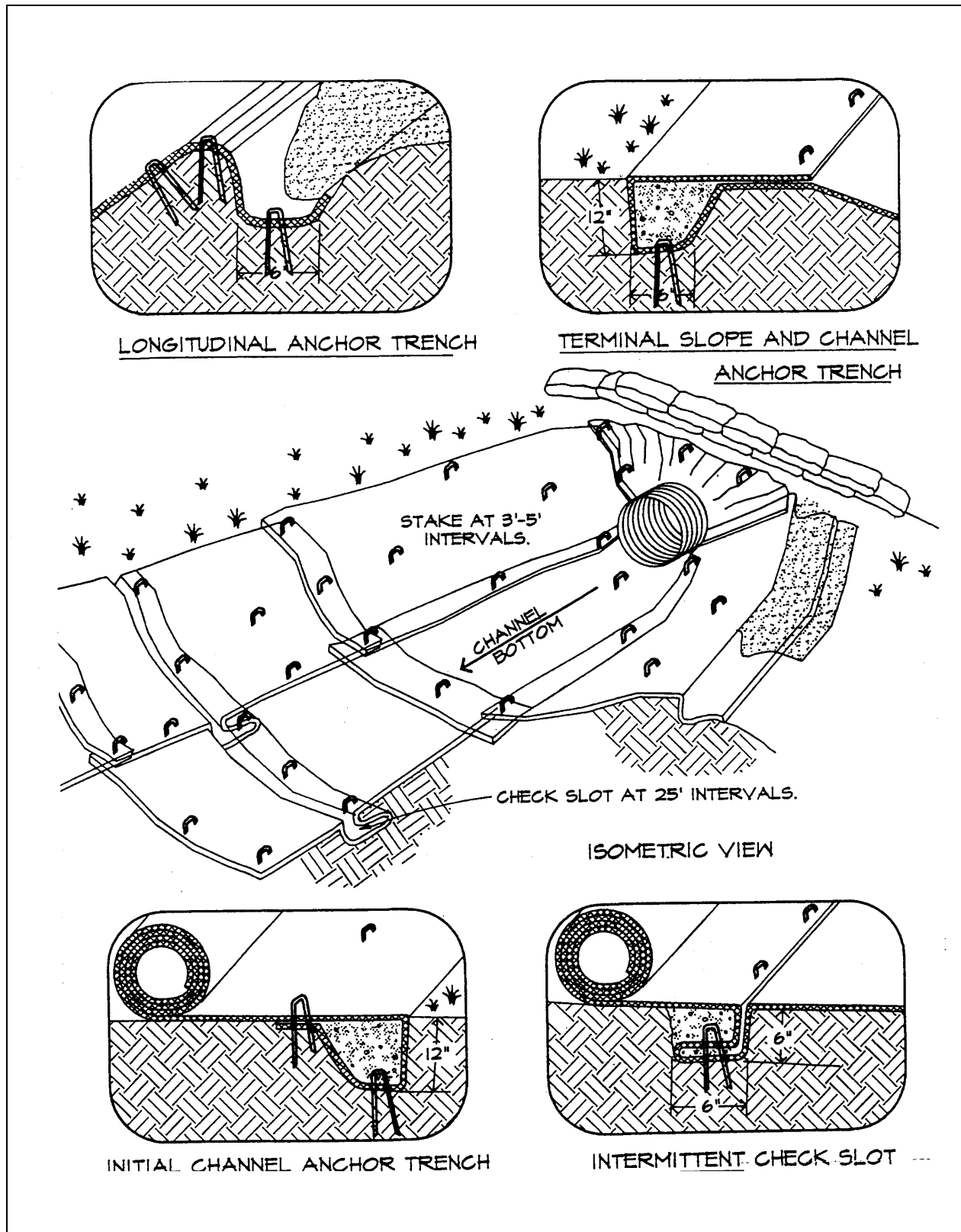

Plate 6.75e Erosion Blankets and Turf Reinforcement Mats - Channel Installation

Source: Erosion Draw

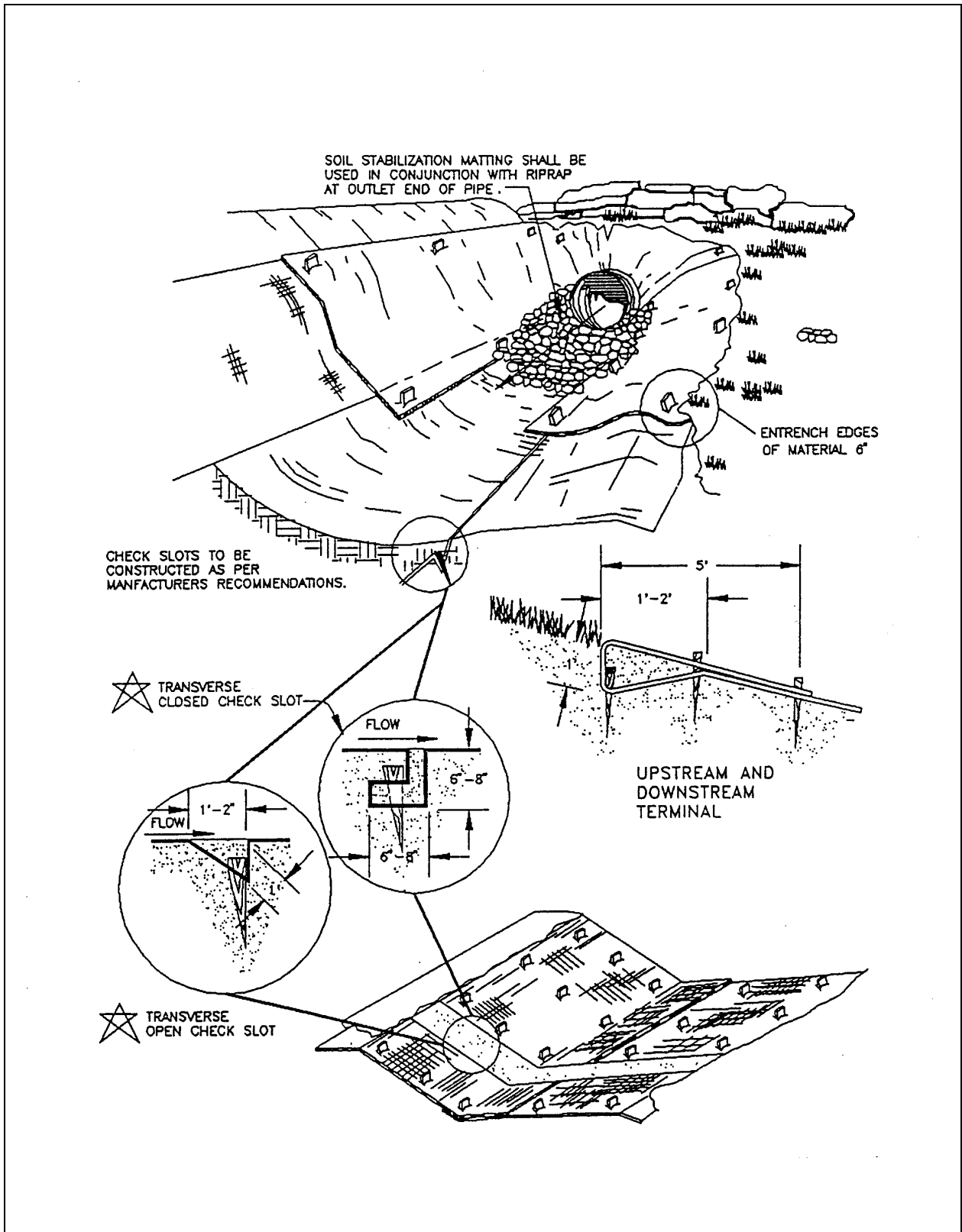

Plate 6.75f Typical Treatment 2 - Soil Stabilization Matting Installation

Source: VDOT Road and Bridge Standards

4. **Joining strips:** Insert new roll of net in trench, as with upslope ends of net. Overlap the end of the previous roll 18 inches (45 cm), turn under 6 inches (15 cm), and staple across end of roll just below anchor slot and at the end of the turned-under net every 12 inches (30 cm).
5. **At bottom of slopes:** Lead net out onto a level area before anchoring. Turn ends under 6 inches (15 cm), and staple across end every 12 inches (30 cm).
6. **Check slots:** On highly erodible soils and on slopes steeper than 4:1, erosion check slots should be made every 15 feet (4.5 m). Insert a fold of net into a 6-inch (15 cm) trench and tamp firmly. Staple at 12-inch (30 cm) intervals across the downstream portion of the net.
7. After installation, stapling, and seeding, net should be rolled to insure firm contact between net and soil.

Maintenance

All mulches should be inspected periodically, in particular after rainstorms, to check for rill erosion. Where erosion is observed additional mulch should be applied. Net should be inspected after rainstorms for dislocation or failure. If washouts or breakage occur, re-install net as necessary after repairing damage to the slope. Inspections should take place up until grasses are firmly established. Where mulch is used in conjunction with ornamental plantings, inspect periodically throughout the year to determine if mulch is maintaining coverage of the soil surface. Repair as needed.

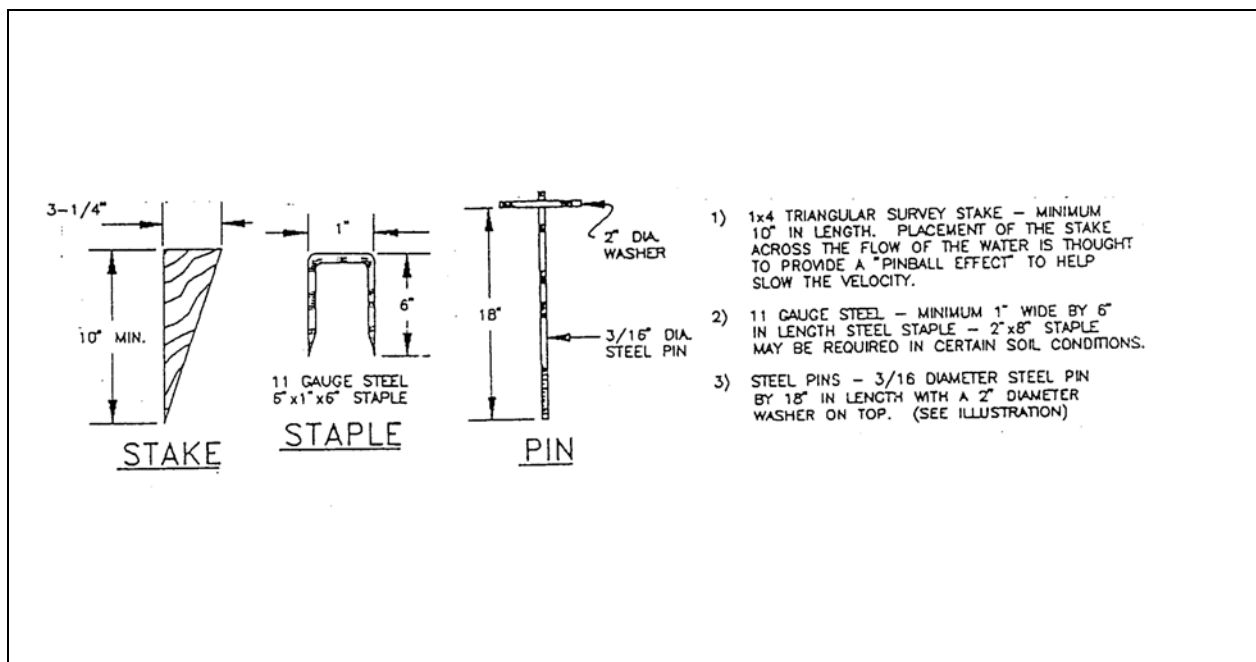

Plate 6.75g Stakes, Staples, and Pins for Installation Soil Stabilization Matting

Source: Product Literature from Greenstreak, Inc.

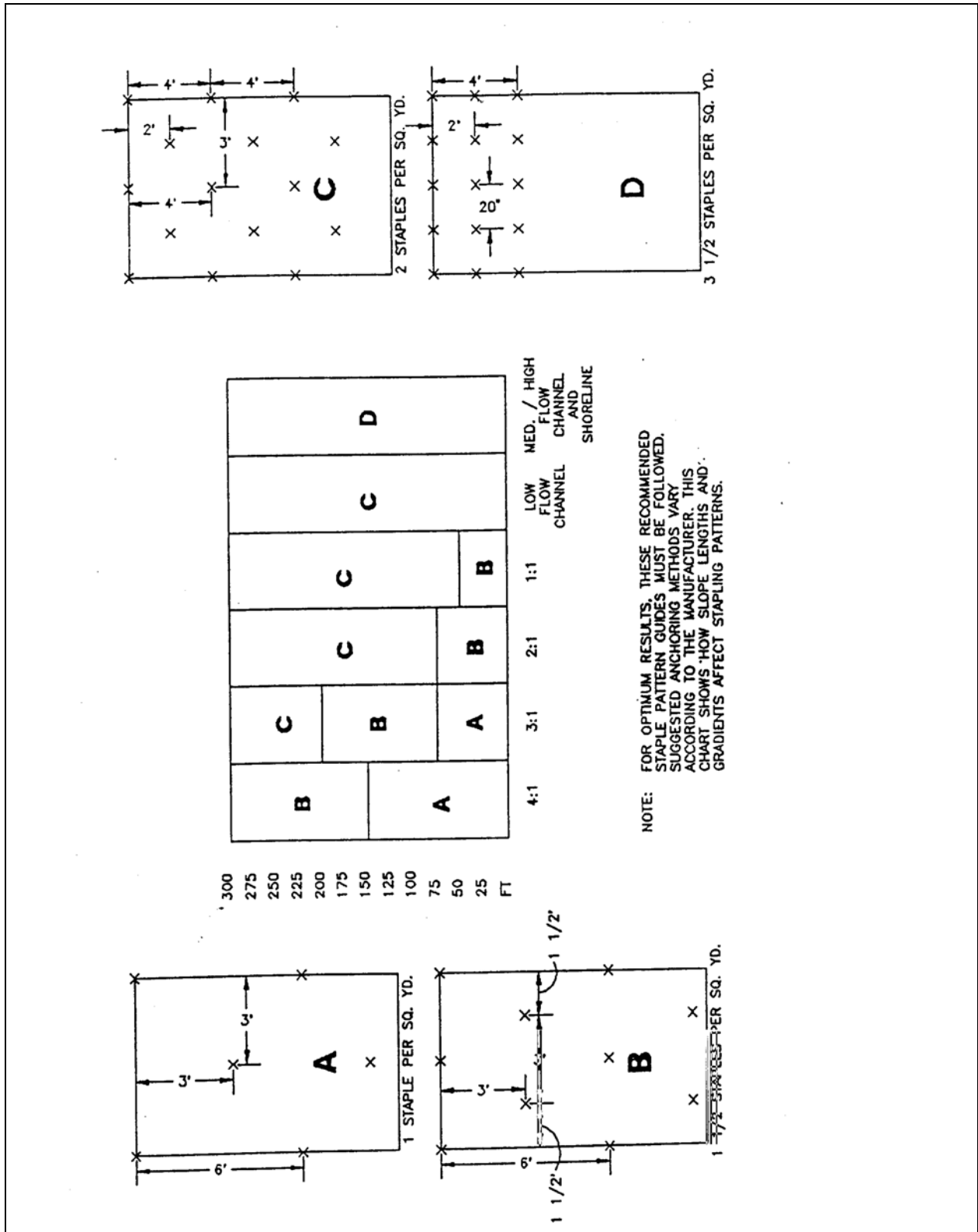

Plate 6.75h General Staple Pattern Guide and Recommendation for Treatment 2 - Soil Stabilization Matting.

Source: Product Literature from North American Green

6.80 TREES, SHRUBS, VINES AND GROUND COVERS

ES BMP 1.80

Definition

Stabilizing disturbed areas by establishing vegetative cover with trees, shrubs, vines, or ground covers.

Purposes

1. To aid in stabilizing soil in areas where vegetation other than turf is preferred.
2. To provide food and shelter for wildlife where wildlife habitat is desirable

Conditions Where Practice Applies

1. On steep or rocky slopes, where mowing is not feasible.
2. Where ornamentals are desirable for landscaping purposes.
3. In areas where turf maintenance is difficult, such as shady areas.
4. Where woody plants are desirable for soil conservation, or to establish wildlife habitats.
5. As a traffic control measure to direct people, vehicles, and equipment to or from an area, or to control access to an area.

Specifications

Types of tree plantings

1. Bare-rooted tree seedlings: Trees to be planted as bare-rooted seedlings should be handled **only while dormant** in winter, or after leaf fall in autumn, with January being the optimum planting month. Refer to Plate 6.80c for planting instructions.

When stabilizing the disturbed areas between tree plantings, do not use grasses or legumes which will overshadow the new seedlings. Where possible, a circle of mulch around seedlings will help them to compete successfully with herbaceous plants.

2. Transplanting trees: (Planting Balled-and-Burlapped and Container-grown Trees) Late fall through winter (November to February) is the preferred time for planting both deciduous and evergreen trees throughout Florida.

TEMPERATURE MODIFICATION

TREES AFFECT WIND SPEED AND DIRECTION, AND THUS TEMPERATURE. FOR EXAMPLE, AN EVERGREEN PLANTING ON THE NORTHWEST SIDE OF A BUILDING WILL REDUCE THE EFFECTS OF HARSH WINTER WINDS AND DIRECT COOL SUMMER BREEZES THROUGH THE AREA. TREES PROTECT THE SOIL FROM DRYING SUN AND WIND, REDUCING EVAPORATION AND MAINTAINING COOLER TEMPERATURES UNDER TREES. WHEN PROPERLY PLACED NEAR BUILDINGS, TREES OF PROPER SIZE WILL INSULATE BUILDINGS FROM EXTREME TEMPERATURE CHANGES IN WINTER AND SUMMER, HELPING REDUCE COSTS OF HEATING AND COOLING. DECIDUOUS TREES BLOCK OUT THE HOT SUMMER SUN, KEEPING THE HOME COOLER, AND ALLOW WARMTH OF WINTER SUN TO PASS THROUGH.

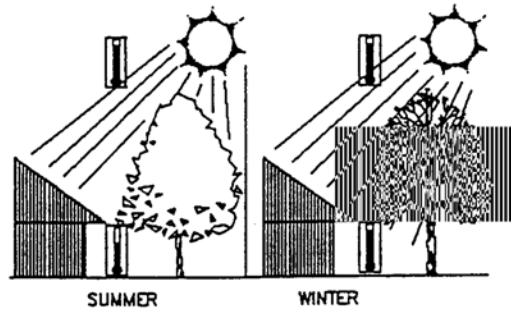
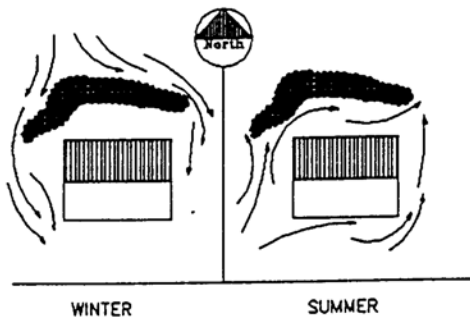

SOUND CONTROL

NOISES FROM NEARBY SOURCES ~~CAN BE REDUCED THROUGH~~ ~~PLACEMENT~~ OF TREES. THE DEGREE OF CONTROL DEPENDS ON THE DENSITY OF THE PLANTING AND INTENSITY AND DIRECTION OF SOUND WAVES. BOTH DECIDUOUS AND EVERGREEN TREES SHOULD BE USED FOR BEST EFFECT.

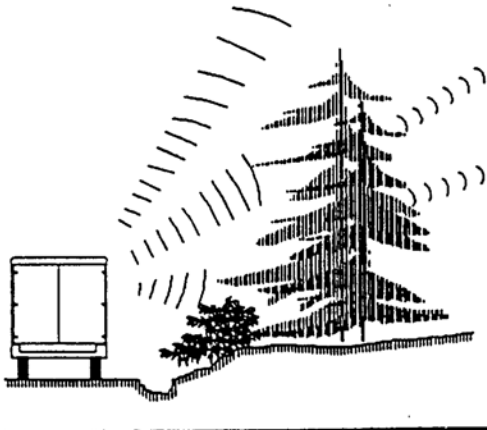

EROSION CONTROL

COARSE LEAF TEXTURES, HORIZONTAL BRANCHING HABITS, FIBROUS ROOT SYSTEMS, AND ROUGH BARK ARE TREE CHARACTERISTICS MOST EFFECTIVE IN SLOWING WATER MOVEMENT AND WIND SPEED, THUS REDUCING EROSION PROBLEMS.



Plate 6.80a Benefits of Trees

Source: Virginia DSWC

Tree preparation - Proper digging of a tree includes the conservation of as much of the root system as possible, particularly the fine roots. Soil adhering to the roots should be damp when the tree is dug, and kept moist until planting. The soil ball should be 12 inches (30 cm) in diameter for each inch (2.5 cm) of diameter of the trunk. The tree should be carefully excavated and the soil ball wrapped in burlap and tied with rope. Use of a mechanical tree spade is also acceptable. Tree foliage should be protected from heat, wind, and chemical damage during transport.

Site preparation - The planting hole should be dug three times as wide as the root ball, and only as deep as the root ball proper placement of the root ball. The final level of the root ball's top should be level with the ground surface. (See Plate 6.80d).

As the hole is dug, topsoil should be kept separate from subsoil. If possible, discard subsoil and replace with good topsoil. If topsoil is unavailable, improve subsoil by mixing in 1/3 by volume of peat moss or well-rotted manure.

Heavy or poorly drained soils are not good growth media for trees. When it is necessary to transplant trees into such soils, extra care should be taken. Properly installed drain tile will improve drainage.

Setting the tree - Depth of planting must be close to the original depth. The tree may be set just a few inches higher than in its former location, especially if soil is poorly drained. DO NOT set the tree lower than before. Soil to be placed around the root ball should be moist but not wet.

Set the tree in the hole and remove the rope and the top one third of the burlap which holds the root ball. Do not break the soil of the root ball. Fill the hole with soil half-way, and tamp firmly around the root ball. Add water to settle the soil and eliminate air pockets. When the water has drained off, fill the hole the remainder of the way and tamp as before.

Use extra soil to form a shallow basin around the tree, somewhat smaller than the diameter of the root ball (See Plate 6.80d). This will be for holding water when the tree is irrigated. Note: Level the ground and eliminate these basins when winter sets in, as ice forming in the basin might injure the trunk.

Supporting the tree - If the tree is grown and dug properly, staking for support is not necessary in most landscape situations. If windy conditions are a concern, trees may be supported by two stakes with wide flexible tie straps. Stakes may also be used to protect plantings from vandalism or mower damage. (see Plate 6.80d).

Watering - Soil around the tree should be thoroughly watered after the tree is set in place. When the soil becomes dry, the tree should be watered deeply but not too often. Mulching around the base of the tree is helpful in preventing roots from drying out.

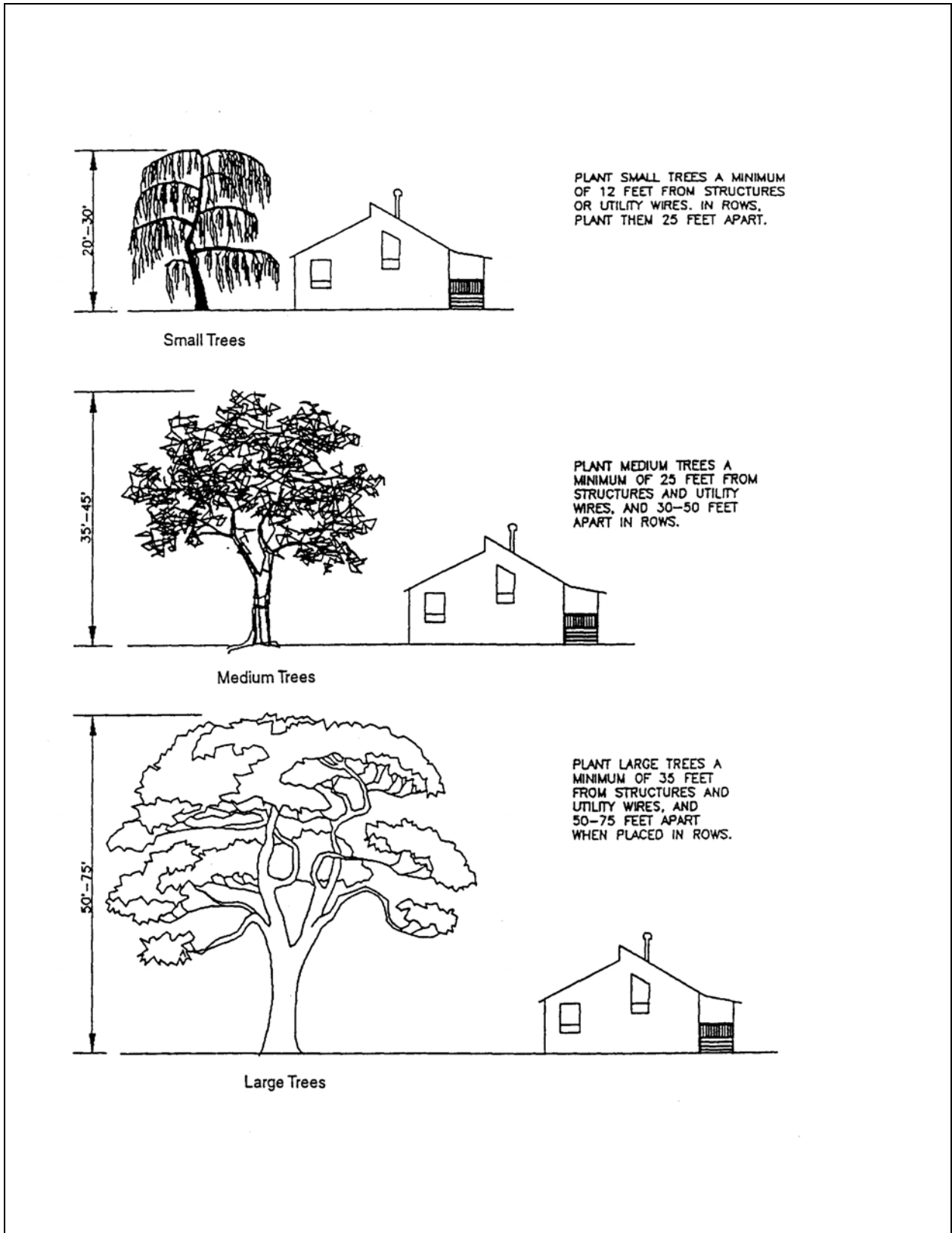

Plate 6.80b Spacing Trees for Safety and Effective Landscaping
Source: Virginia DSWC

Maintenance of Tree Plantings

Like all plants, trees require water and fertilizer to grow. Ideally, young trees should receive an inch of water each week for the first two years after planting. When rain does not supply this need, the tree should be watered deeply but not more often than once per week.

Transplanted trees should be fertilized one year or so after planting. There are many sophisticated ways to supply fertilizer to trees, but some simple methods are adequate. The best material for small trees is well-rotted stable manure, if it can be obtained. Add it annually as a 2-inch (5 cm) layer of mulch around the tree. If chemical fertilizers are to be used, a formulation such as 10-8-6 or 10-6-4 is preferred. Use about 2 lbs. per inch (350 g/cm) of trunk diameter measured 4 feet (1.2 m) from the ground. Thus, if the trunk diameter at 4 feet (1.2 m) was 5 inches (13 cm), 10 lbs. (4.5 kg) of fertilizer would be applied.

Fertilizer must come in contact with the roots to benefit the tree. A simple way to insure this is to make holes in the tree's root area with a punchbar, crowbar, or auger. Holes should be 18 inches (45 cm) deep, spaced about 2 feet (60 cm) apart, and located around the drip line of the tree. Distribute the necessary fertilizer evenly into these holes, and close the holes with the heel of the shoe or by filling with topsoil or peat moss. Fertilize trees in late fall or in early spring, before leaves emerge.

NOTE: Evergreens use 1/2 the recommended amount of chemical fertilizer or use only organic fertilizers such as cottonseed meal, bone meal, or manure.

Planting Shrubs - Follow the general procedure for tree planting when planting shrubs.

Maintenance - Proper pruning, watering, and application of fertilizer every 3 years or so will keep shrubs healthy. Maintain the mulch cover or turf cover surrounding the shrubs. A heavy layer of mulch reduces weeds and retains moisture.

Planting Vines and Ground Covers

Low-growing plants that sprawl, trail, spread, or send out runners come in many leaf types, colors and growth habits. Some are suitable only as part of a maintained landscape, and some can stabilize large areas with little care. In addition to stabilizing disturbed soil, vines and ground covers can perform the following functions:

1. Maintain cover in heavily shaded areas where turf will not thrive.
2. Provide attractive cover that does not need mowing.
3. Help to define traffic areas and control pedestrian movement. People are more likely to walk on the grass than on a thick bed of ivy or a prickly planting of juniper.

Table 1.80c of The Florida Development Manual gives the characteristics of some commonly used vines and ground covers suitable for Florida. Information on others is

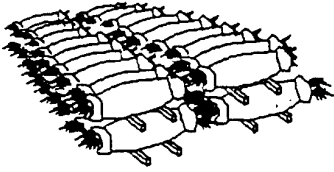

CARE OF SEEDLINGS UNTIL PLANTED

SEEDLINGS SHOULD BE PLANTED IMMEDIATELY. IF IT IS NECESSARY TO STORE MOSS-PACKED SEEDLINGS FOR MORE THAN 2 WEEKS, ONE PINT OF WATER PER PKG. SHOULD BE ADDED. IF CLAY-TREATED, DO NOT ADD WATER TO PKG. PACKAGES MUST BE SEPERATED TO PROVIDE VENTILATION TO PREVENT "HEATING". SEPARATE PACKAGES WITH WOOD STRIPS AND STORE OUT OF THE WIND IN A SHADED, COOL (NOT FREEZING) LOCATION.



CARE OF SEEDLINGS DURING PLANTING

WHEN PLANTING, ROOTS MUST BE KEPT MOIST UNTIL TREES ARE IN THE GROUND. DO NOT CARRY SEEDLINGS IN YOUR HAND EXPOSED TO THE AIR AND SUN. KEEP MOSS-PACKED SEEDLINGS IN A CONTAINER PACKED WITH WET MOSS OR FILLED WITH THICK MUDDY WATER. COVER CLAY-TREATED SEEDLINGS WITH WET BURLAP ONLY.

HAND PLANTING

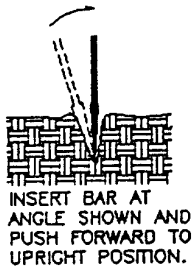

INSERT BAR AT ANGLE SHOWN AND PUSH FORWARD TO UPRIGHT POSITION.

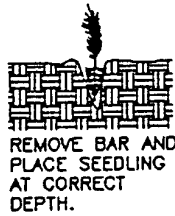

REMOVE BAR AND PLACE SEEDLING AT CORRECT DEPTH.

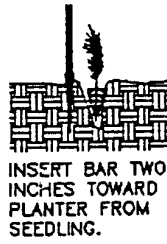

INSERT BAR TWO INCHES TOWARD PLANTER FROM SEEDLING.

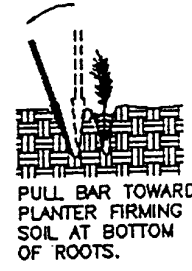

PULL BAR TOWARD PLANTER FIRING SOIL AT BOTTOM OF ROOTS.

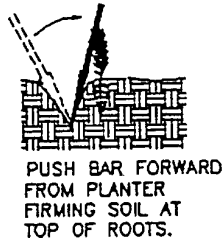

PUSH BAR FORWARD FROM PLANTER FIRING SOIL AT TOP OF ROOTS.

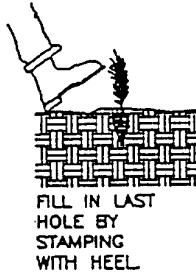

FILL IN LAST HOLE BY STAMPING WITH HEEL



FIRM SOIL AROUND SEEDLING WITH FEET.

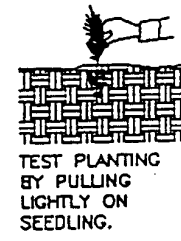

TEST PLANTING BY PULLING LIGHTLY ON SEEDLING.

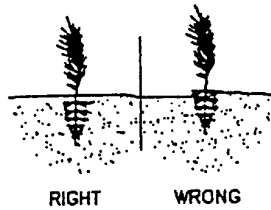

RIGHT WRONG

DON'T EXPOSE ROOTS TO AIR DURING FREEZE OR PLANT IN FROZEN GROUND.

PLANT SEEDLINGS UPRIGHT - NOT AT AN ANGLE.

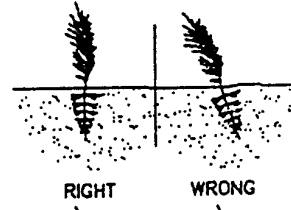

RIGHT WRONG

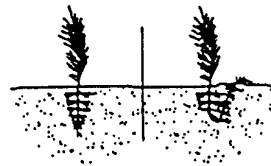

DO NOT BEND ROOTS SO THAT THEY GROW UPWARDS OUT OF THE GROUND.

ALWAYS PLANT IN SOIL - NEVER LOOSE LEAVES OR DEBRIS. PACK SOIL TIGHTLY.

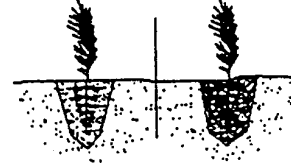

Plate 6.80c Planting Bare Root Seedlings

Source: Virginia Department of Forestry

available from nursery professionals.

Like shrubs and trees, ground covers are best planted in spring. Containergrown plants can be planted throughout the growing season if adequate water is provided.

Site preparation - Ground covers are plants that naturally grow very close together, causing severe competition for space, nutrients, and water. Soil for ground covers should be well prepared. A well-drained soil high in organic matter is best.

The entire area should be spaded, disced or roto-tilled to a depth of six to eight inches. Two to three inches of organic material such as good topsoil, peat or well composted manure should be spread over the entire area. Apply 9 - 18 lbs./1000 ft² (440 - 880 kg/ha) of 10-10-10 fertilizer and incorporate the organic material and fertilizer into the soil before planting.

If the area to be planted is very large or it is impractical to prepare the entire area, individual planting holes 1/3 larger and deeper than the plant root ball should be dug. If the soil is not suitable for plant growth, it is best to batch blend a planting medium. A mixture of 1:1 or 2:1 sandy loam soil and peat, composted manure or other well-rotted organic material with 10 pounds of 10-10-10 fertilizer and 20 lbs. lime per cubic yard (6 kg/m³ fertilizer and 12 kg/m³ lime) of soil mix. Lime should not be used for acid loving plants such as camellias, azaleas, or blueberries.

Planting - Plants such as ivy, pachysandra, and periwinkle should be planted on one-foot centers; large plants such as juniper can be spaced on 3-foot (90 cm) centers. The following steps will help insure good plant growth:

1. Make the plantings on the contour.
2. Dig the holes 1/3 larger than the plant root ball.
3. Plant at the same level that the plants grew.
4. Use good topsoil or soil mixture with a lot of organics.
5. Fill hole 1/3 to 1/2 full, shake plants to settle soil among roots, then water. Finish filling hole, firm slightly and again settle with water.
6. Leave saucer-shaped depression around plant to hold water.
7. Water thoroughly and regularly.
8. Space plants according to the type of plant and the extent of covering desired. Set small plants as close as 4 to 6 inches (10 - 15 cm) apart and large plants as much as 4 feet (1.2 m) apart. The following chart shows the area that approximately 100 plants will cover when set at various distances apart:

<u>Planting Distance</u> (inches)	<u>Area Covered</u> (sq.ft.)
4	11
6	25
8	44
10	70
12	120
18	225
24	400
36	900
48	1600

Mulching - The soil between trees and shrubs must be planted with cover vegetation or must be mulched. When establishing ground covers, it is not desirable to plant species that will compete strongly with the ground cover or will make maintenance difficult. A thick durable mulch such as shredded bark or wood chips is recommended to prevent erosion and reduce weed problems. Pre-emergent herbicides may be necessary where weeding is not practical.

On slopes where erosion may be a problem, jute net, or excelsior blankets may be installed prior to planting, and plants tucked into the soil through slits in the net. Such plants should be put in a staggered pattern to minimize erosion.

Maintenance

Trim old growth as needed to improve the appearance of ground covers. Most covers need once-a-year trimming to promote growth. Maintain mulch cover with additions of mulch where needed. Fertilize as described above, every 3-4 years.

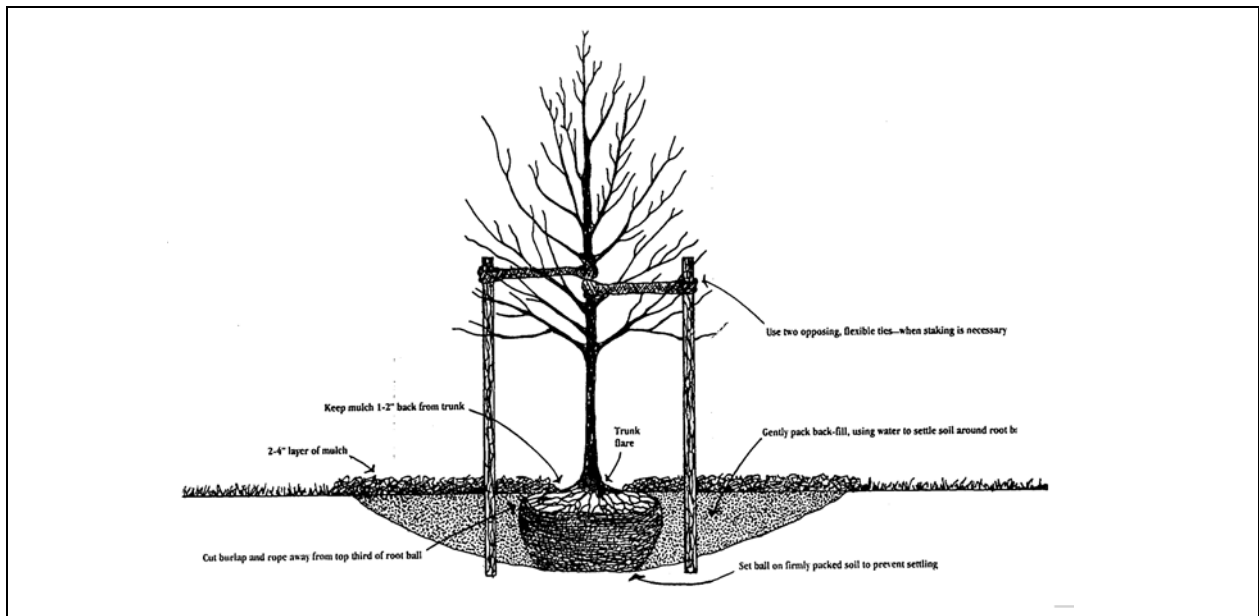

Plate 6.80d Planting Balled & Burlapped, and Container Grown Trees
 Source: International Society of Arboculture

6.85 TREE PRESERVATION AND PROTECTION **(ES BMP 1.85)**

Definition

Protection of desirable trees from mechanical and other injury during land disturbing and construction activities

Purpose

To ensure the survival of desirable trees where they will be effective for erosion and sediment control, watershed protection, landscape beautification, dust and pollution control, noise reduction, shade, and other environmental benefits while the land is being converted from forest to urban-type uses

Conditions Where Practice Applies

Tree-inhabited areas subject to land disturbing activities.

Specifications

1. Groups of trees and individual trees selected for retention shall be accurately located on the plan and designated as "tree(s) to be saved." Individual specimens that are not part of a tree group shall also have their species and diameter noted on the plan.
2. The limits of clearing shall be located outside the drip line of any tree to be retained, and in no case closer than 5 feet (1.5 m) to the trunk of such a tree (See Plate 6.85a).

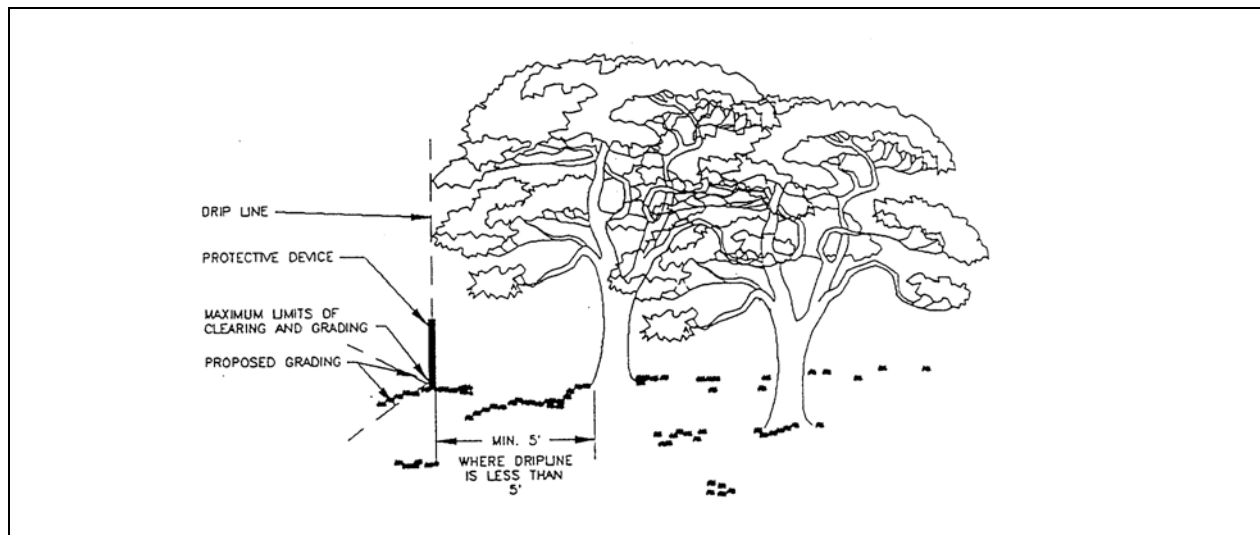

Plate 6.85a Construction Operations Relative to the Location of Protected Trees

Source: Public Facilities Manual, Vol. III, Fairfax County, Virginia 1976

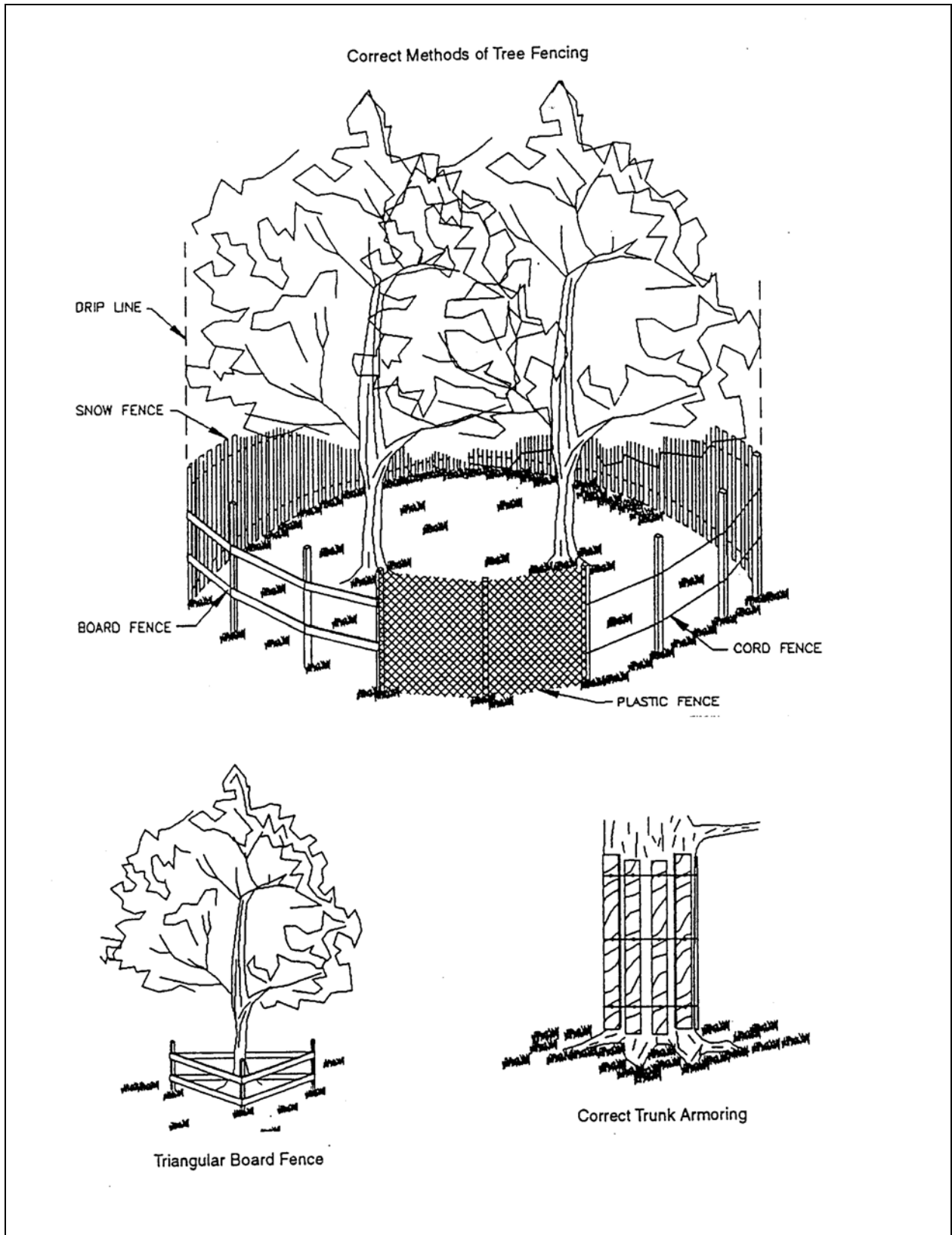

Plate 6.85b Fencing and Armoring
Source: Virginia DSWC

3. Marking: Prior to construction and before the preconstruction conference, individual trees and stands of trees to be retained within the limits of clearing shall be visibly marked with a bright color paint or surveyor's ribbon applied in a band circling the tree at a height visible to equipment operators.
4. Pre-Construction Conference: During any preconstruction conference, tree preservation and protection measures should be reviewed with the contractor as they apply to that specific project.
5. Equipment Operation and Storage: Heavy equipment, vehicular traffic, or stockpiles of any construction material including topsoil shall not be permitted within the drip line of any tree to be retained. Trees being removed shall not be felled, pushed, or pulled into trees being retained. Equipment operators shall not clean any part of their equipment by slamming it against the trunks of trees to be retained.
6. Fires: Fires shall not be permitted within 100 feet (30 m) from the drip line of any trees to be retained. Fires shall be limited in size to prevent adverse effects on trees, and kept under surveillance.
7. Storage and Disposal of Toxic Materials: No toxic materials shall be stored closer than 100 feet (30 m) to the drip line of any trees to be retained. Paint, acid, nails, gypsum board, wire, chemicals, fuels, and lubricants shall not be disposed of in such a way as to injure vegetation.
8. Fencing and Armoring: (Plate 6.85b): Any device may be used which will effectively protect the roots, trunk and tops of trees retained on the site. However, trees to be retained within 40 feet (12 m) of a proposed building or excavation shall be protected by fencing. Personnel must be instructed to honor protective devices. The devices described are suggested only, and are not intended to exclude the use of other devices which will protect the trees to be retained.
 - a. Field fence - Standard 48 inch (1.2 m) high field fence shall be placed at the limits of the clearing on standard steel posts set 6 feet (1.8 m) apart.
 - b. Board Fence - Board fencing consisting of 4 inch (10 cm) square posts set securely in the ground and protruding at least 4 feet (1.2 m) above the ground shall be placed at the limits of clearing with a minimum of two horizontal boards between posts. If it is not practical to erect a fence at the drip line, construct a triangular fence nearer the trunk. The limits of clearing within the drip line will still require protection.
 - c. Cord Fence - Posts with a minimum size of 2 inches (5 cm) square or 2 inches (5 cm) in diameter set securely in the ground and protruding at least 4 feet (1.2 m) above the ground shall be placed at the limits of clearing with two rows of cord 1/4 inch (6 mm) or thicker at least 2 feet (60 cm) apart running between posts with strips of colored surveyor's flagging tied securely to the string at intervals of no greater than 3 feet (90 cm).

- d. Earth Berms - Temporary earth berms shall be constructed according to specifications for a TEMPORARY DIVERSION DIKE - Section 4.15 (ES BMP 1.15) with the base of the berm on the tree side located along the limits of clearing. Earth berms may not be used for this purpose if their presence will conflict with drainage patterns.
- e. Additional Trees - Additional trees may be left standing as protection between the trunks of the trees to be retained and the limits of clearing. However, in order for this alternative to be used, the trunks of the trees in the buffer must be no more than 6 feet (1.8 m) apart to prevent passage of equipment and material through the buffer. These additional trees shall be reexamined prior to the completion of construction and either given sufficient treatment to insure survival or removed.
- f. Trunk Armoring - As a last resort a tree trunk can be armored with burlap wrapping and 2 inch (5 cm) studs wired vertically no more than 2 inches (5 cm) apart to a height of 5 feet (1.5 m) encircling the trunk. If this alternative is used, the root zone within the drip line will still require protection. Nothing should ever be nailed to a tree.

Fencing and armoring devices shall be in place before any excavation or grading is begun, shall be kept in good repair for the duration of construction activities, and shall be the last items removed during the final cleanup after the completion of the project.

9. Trenching and Tunnelling: (Plate 6.85c)

- a. Trenching shall be done as far away from the trunks of trees as possible, preferably outside the branches or crown spreads of trees, to reduce the amount of root area damaged, or killed by trenching activities.
- b. Wherever possible, trenches should avoid large roots or root concentrations. This can be accomplished by curving the trench or by tunnelling under large roots and areas of heavy root concentration.
- c. Tunnelling under an individual specimen that does not have a large taproot may be preferable to trenching beside it. Tunnelling is more expensive initially, but it usually causes less soil disturbance and physiological impact on the root system. The extra cost may offset the potential costs of tree removal and replacement should the tree die.
- d. Roots shall not be left exposed to the air. They shall be covered with soil as soon as possible or protected and kept moistened with wet burlap or peat moss until the trench or tunnel can be filled.
- e. The ends of damaged and cut roots shall be cut off smoothly and protected by painting promptly with a tree wound dressing.
- f. Trenches and tunnels shall be filled as soon as possible. Air spaces in the

- soil shall be avoided by careful filling and tamping.
- g. Peat moss or other suitable material shall be added to the fill material as an aid to inducing and developing new root growth.
 - h. The tree shall be mulched and fertilized to conserve moisture, stimulate new root growth and enhance general tree vigor.
 - i. If a large amount of the root system has been damaged and killed, the crown leaf surface shall be proportionately reduced to balance the reduced root system. This may be accomplished by pruning 20 to 30 percent of the crown foliage. If roots are cut during the winter, pruning shall be accomplished before the next growing season. If roots are cut during the growing season, pruning shall be done immediately.
10. Removal and Replacement of Damaged Trees: Should a tree intended and marked to be retained be damaged seriously enough that survival and normal growth are not possible, the tree shall be removed. If replacement is desirable and/or required, the replacement tree shall be of the same or similar species, 2-inch to 2 1/2-inch (5 to 6 cm) caliper balled and burlapped nursery stock.
12. Cleanup: Cleanup after a construction project can be a critical time for tree damage. Trees protected throughout the development operation are often destroyed by carelessness during the final cleanup and landscaping. Fences and barriers shall be removed last, after everything else is cleaned up and carried away.
13. Maintenance: In spite of precautions, some damage to protected trees may occur. In such cases, the following maintenance guidelines should be followed.
- a. Soil Aeration - If the soil has become compacted over the root zone of any tree, the ground ball shall be aerated by punching holes with an iron bar. The bar shall be driven 1-foot (30 cm) deep and then moved back and forth until the soil is loosened. This procedure shall be repeated every 18 inches (45 cm) until all of the compacted soil beneath the crown of the tree has been loosened.
 - b. Repair of Damage
 - (1) Any damage to the crown, trunk or root system of any tree retained on the site shall be repaired immediately.
 - (2) Whenever major root damage or bark damage occurs, remove some foliage to reduce the demand for water and nutrients.

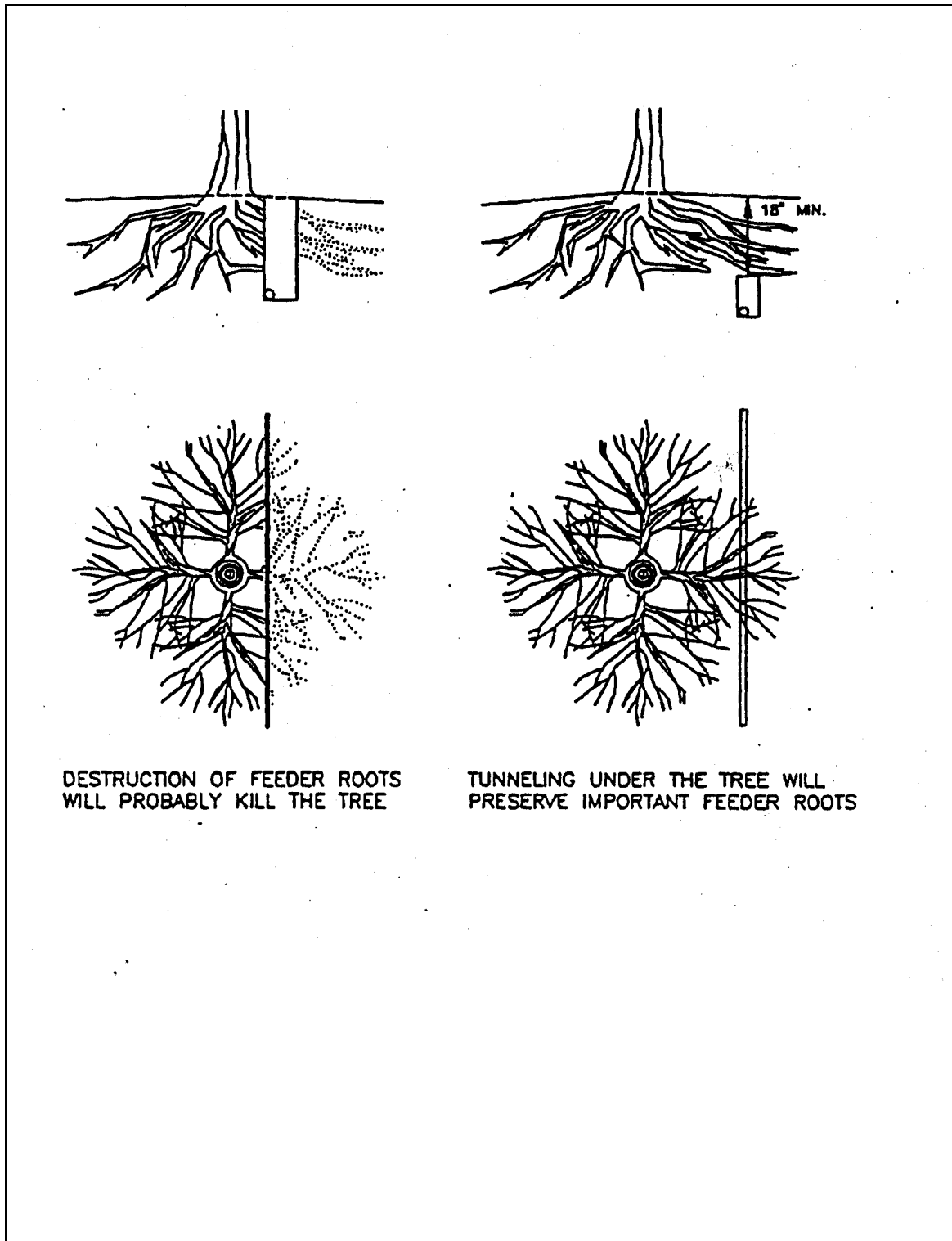

Plate 6.85c Trenching vs. Tunneling

Source: Tree Maintenance, Pirone 1979

(3) Damaged roots shall immediately be cut off cleanly inside the exposed or damaged area. Cut surfaces shall be painted with approved tree paint, and moist peat moss, burlap or topsoil shall be spread over the exposed area.

(4) To treat bark damage, carefully cut away all loosened bark back into the undamaged area, taper the cut at the top and bottom and provide drainage at the base of the wound (See Plate 6.85d).

(5) All tree limbs damaged during construction or removed for any reason shall be cut off above the collar at the preceding branch junction (See Plate 6.85d).

(6) Care for serious injuries shall be prescribed by a forester or a tree specialist.

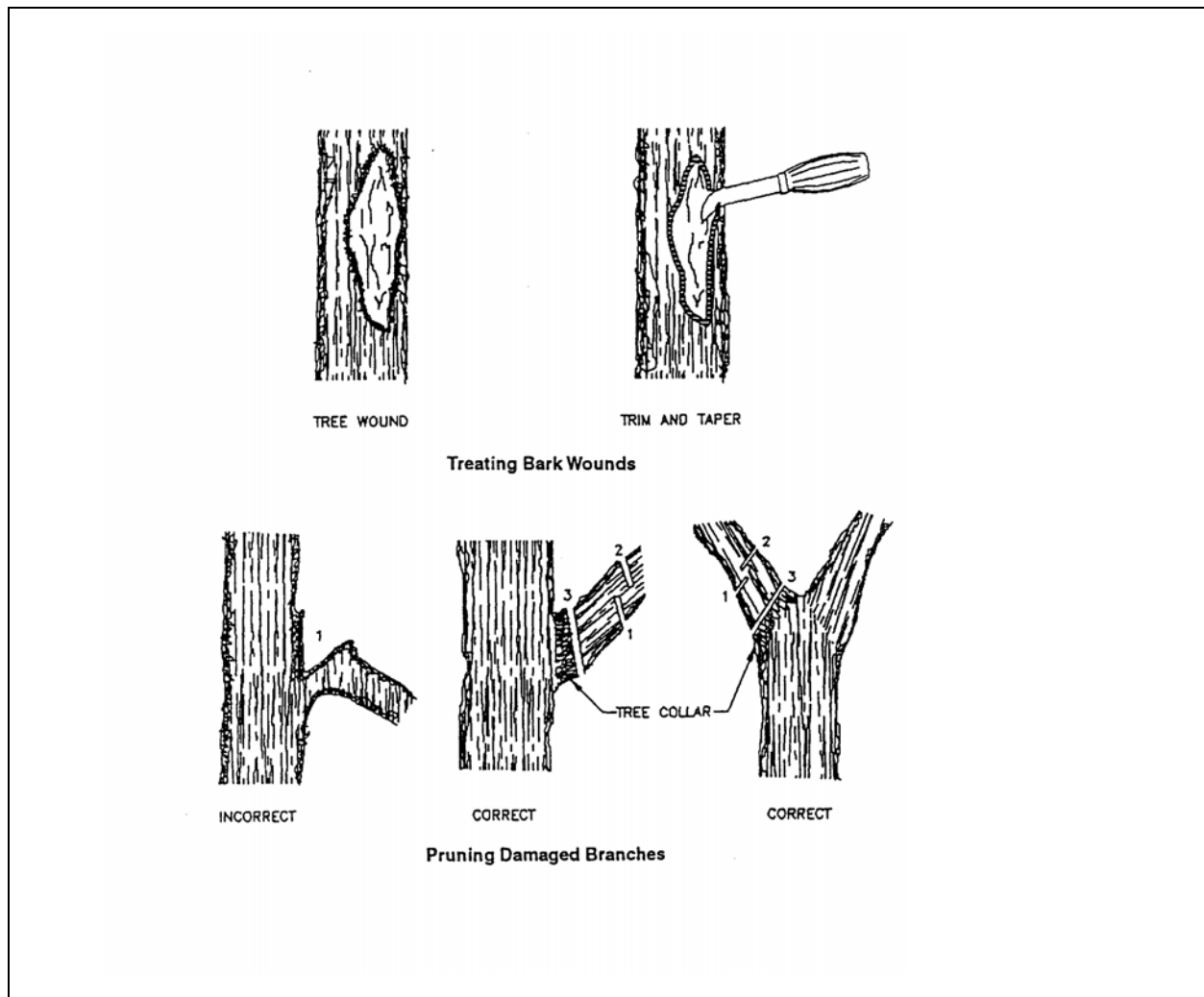

Plate 6.85d Tree Care

Source: Public Facilities Manual, Vol. III, Fairfax County, Virginia 1976

c. Fertilization: Broadleaf trees that have been stressed or damaged shall receive a heavy application of fertilizer to aid their recovery.

(1) Trees shall be fertilized in the late fall (after October 1) or the early spring (from the time frost is out of the ground until May 1). Fall applications are preferred, as the nutrients will be made available over a longer period of time.

(2) Fertilizer shall be applied to the soil over the feeder roots. (See Plate 6.85e). In no case should it be applied closer than 3 feet (90 cm) to the trunk. The root system of conifers extends some distance beyond the drip line. Increase the area to be fertilized by 1/4 the area of the crown.

(3) Fertilizer shall be applied using approved fertilization methods and equipment.

(4) Formulations and application rates shall conform to the guidelines given in Table 1.85a of The Florida Development Manual.

Maintain a ground cover or organic mulch layer around trees that is adequate to prevent erosion, protect roots, and hold water.

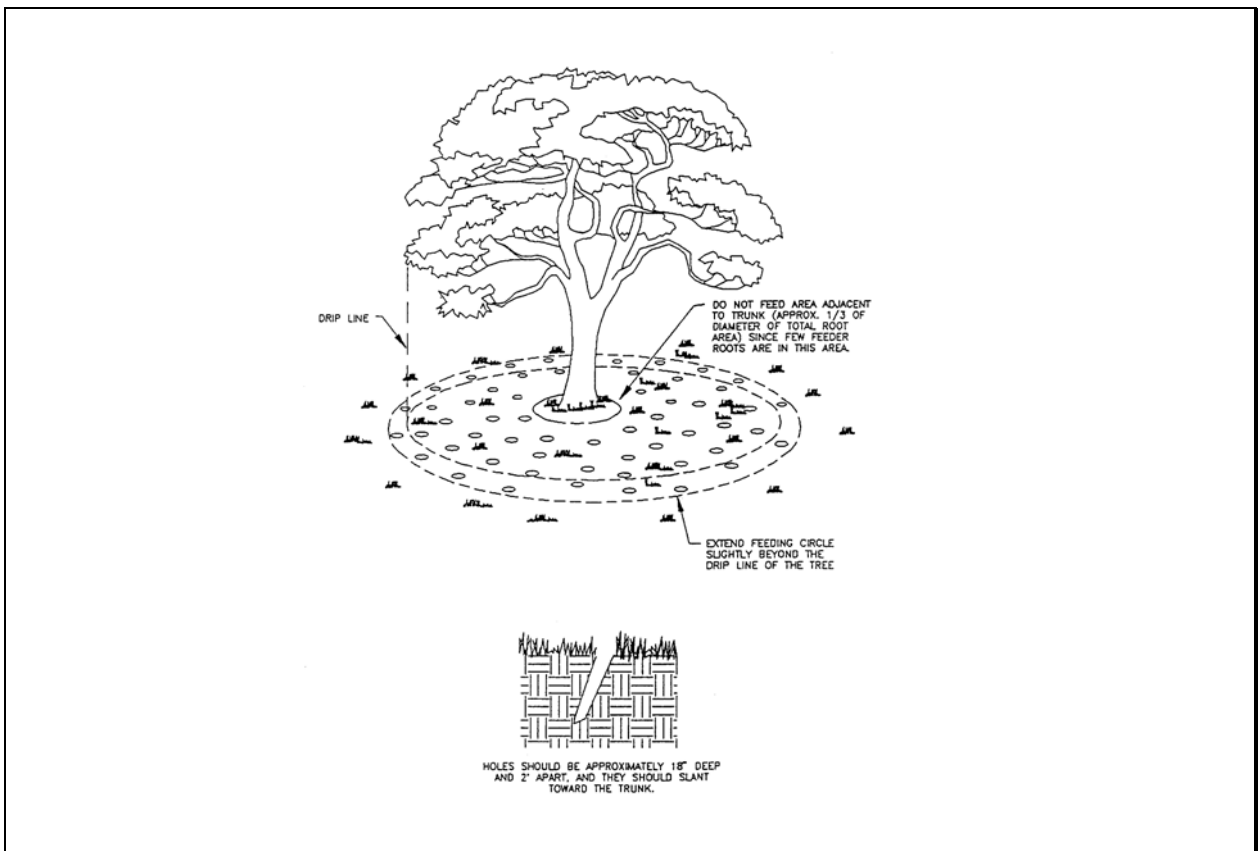

Plate 6.85e Tree Fertilization

Source: Tree Maintenance, Pirone 1979

6.98 VEGETATIVE STREAMBANK STABILIZATION

ES BMP 1.98

Definition

The use of vegetation in stabilizing streambanks.

Purpose

To protect stream banks from the erosive forces of flowing water.

Conditions Where Practice Applies

Along banks in creeks, streams, and rivers subject to erosion from excess runoff. This practice is generally applicable where bank-full flow velocity does not exceed five ft./sec. (1.5 m/sec.) and soils are erosion resistant. Above five ft./sec. (1.5 m/sec.), structural measures are generally required. This practice does not apply where tidal conditions exist.

Planning Considerations

A primary cause of stream channel erosion is the increased frequency of bank-full flows which often results from upstream development. Most natural stream channels are formed with a bank-full capacity to pass the runoff from a storm with a one and one half to two year recurrence interval. However in a typical urbanizing watershed, stream channels are subject to a three to five fold increase in the frequency of bank-full flows. As a result, stream channels that were once parabolic in shape with banks covered with vegetation are transformed into wide channels with barren banks.

In recent years, a number of structural measures have evolved to strengthen and protect the banks of rivers and streams. These methods, if employed correctly, immediately insure satisfactory protection for the banks. However, many such structures are expensive to build and maintain, and frequently contribute to downstream velocity problems. Without constant upkeep they are exposed to progressive deterioration by natural agents. The materials used often prevent the reestablishment of native plants and animals, especially when the design is executed according to standard cross-sections, which ignore natural variation of the stream system. Very often these structural measures diminish the appearance of the site.

In contrast, the utilization of living plants in conjunction with structures has many advantages. The degree of protection, which may be low to start with, increases as the plants grow and spread. The repair and maintenance of structures is unnecessary where self-maintaining streambank plants are established. The protection provided by natural vegetation is more reliable and effective where the cover consists of natural plant communities which are native to the site. Planting vegetation is less damaging to the environment than installing structures. Vegetation also provides a habitat for fish and wildlife and is aesthetically pleasing. Plants provide erosion protection to streambanks by absorbing stream velocity, binding soil in place with a root mat, and covering the soil surface when high flows tend to flatten vegetation against the banks. For these reasons,

vegetation should always be considered first.

One disadvantage of streambank vegetation is that it lowers the carrying capacity of the channel, which may promote flooding. Therefore, maintenance needs and the consequences of flooding should be considered. The erosion potential for the stream needs to be evaluated to determine the best solutions. The following items should be considered in the evaluation:

1. The frequency of bank-full flow based on anticipated watershed development.
2. The channel slope and flow velocity, by design reaches.
3. The antecedent soil conditions.
4. Present and anticipated channel roughness ("n") values.
5. The location of channel bends along with bank conditions.
6. The location of unstable areas and trouble spots. Steep channel reaches, high erosive banks, and sharp bends may require structural stabilization measures such as riprap, while the remainder of the streambank may require only vegetation.

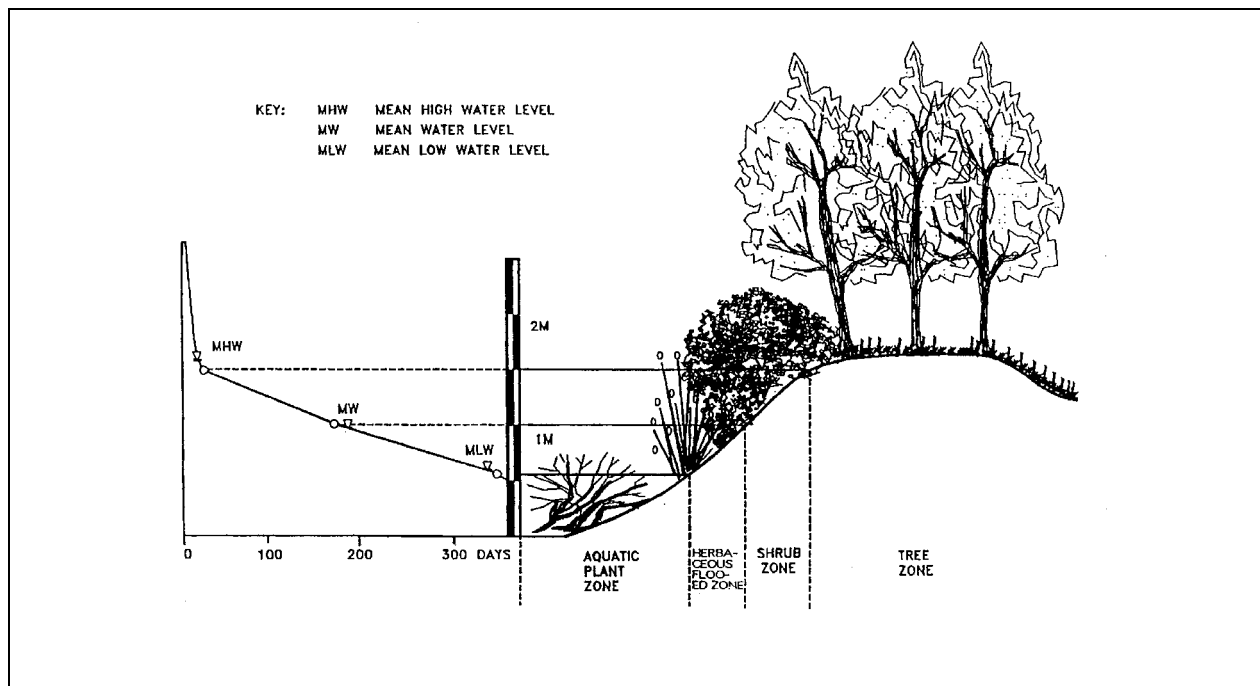

Plate 6.98a Typical Annual Curve of Water Levels Correlated with Typical Vegetative Zones

Source: Importance of Natural Vegetation for the Protection of the Banks of Streams, Rivers, and Canals, Seibert

Where streambank stabilization is required and velocities appear too high for the use of vegetation, one should consider structural measures or the use of permanent erosion control matting as per MULCHING - Section 6.75 - ES BMP 1.75. **Notably, any**

applicable approval or permits from other state or federal agencies must be obtained prior to working in such areas.

Vegetation Zones Along Watercourses

At the edge of all natural watercourses, plant communities exist in a characteristic succession of vegetative zones, the boundaries of which are dependent upon site conditions such as the steepness and shape of the bank and the seasonal and local variation in water depth and flow rate. Streambanks commonly exhibit the following zonation (See Plate 6.98a)

Zone 1. Aquatic Plant Zone This zone is normally permanently flooded. This zone is inhabited by plants such as alligator weed, hydrilla, parrotfeather, and water lilies which reduce the water's flow rate by friction. The roots of these plants help bind the soil, and further protect the channel from erosion, because the water flow tends to flatten them against the banks.

Zone 2. Herbaceous Flooded Zone The lower part of this zone is normally flooded for only about half the year. In Florida, this zone is inhabited by rushes, sedges, pickerel weed, smartweeds, cattails, and other plants which bind the soil with their roots, rhizomes, and shoots and slow the waters flow rate by friction.

Zone 3. Shrub Zone This zone is flooded only during periods of average high water. In Florida, the shrub zone is inhabited by trees and shrubs such as willow, red maple, button-bush, and sweet bay with a high regenerative capacity. These plants hold the soil with their root systems and slow water speed by friction. They prevent the formation of strong eddies around large trees during flood flows. Woody zone vegetation is particularly beneficial along the impact bank of a stream meander where maximum scouring tends to occur. Infringement of shrub vegetation into the channel tends to reduce the channel width, which increases the probability of floods.

Zone 4. Tree Zone Infrequently Flooded This zone is flooded only during periods of very high water (i.e., the two year bank-full flow or greater flows). Typical plants in Florida are trees in the oak family. These trees hold soil in place with their root system. However, brief flooding of riverside woods and undeveloped areas does no significant damage and the silt deposits in these wooded area are less of a problem than failed banks.

Design Criteria

Table 6.98 provides general guidelines for the maximum allowable velocities in streams to be protected by vegetation.

1. Ensure that channel bottoms are stable before stabilizing channel banks.
2. Keep velocities at bank-full flow non-erosive for the site conditions.
3. Provide mechanical protection such as riprap on the outside of channel bend if

bank-full stream velocities approach the maximum allowable for site conditions.

4. Be sure that requirements of other state or federal agencies are met in the design in case other approvals or permits are necessary.

TABLE 6.98
CONDITIONS WHERE VEGETATIVE STREAMBANK STABILIZATION IS ACCEPTABLE

<u>Frequency of Bank-full Flow</u>	<u>Max. Allowable Velocity for Highly Erodible Soil</u>	<u>Maximum Allowable Velocity for Erosion Resistant Soil</u>
> 4 times/yr	4 ft./sec.	5 ft./sec.
1 to 4 times/yr.	5 ft./sec.	6 ft./sec.
< 1 time/yr.	6 ft./sec.	6 ft./sec.

Source: Virginia DSWC

Planting Guidelines

Guidelines will be presented only for Zone two and Zone three. Zone one is difficult to implant and establish naturally when herbaceous flooded zone vegetation is present. Presently there are many experts in this field at the federal, state, and private sector levels who can be of assistance concerning successful establishment of plants in the aquatic zone. Zone four is least significant zone in terms of protecting banks from more frequent erosion force flows, since this zone is seldom flooded. Also, shade from trees in this zone can prevent an adequate establishment of vegetation in other zones.

1. Establishing Herbaceous Flooded Zone

There are various ways of planting this vegetation. The following plants are considered suitable:

Maidencane grass	<i>(Panicum hemitoman)</i>
Common Reed	<i>(Phragmites communis)</i>
Great Bulrush	<i>(Scirpus lacustris)</i>
Pickerelweed	<i>(Pontetaria cordata)</i>
Smartweed	<i>(Polygonum spp.)</i>
Arrowhead	<i>(Sagittaria spp.)</i>
Wild millet	<i>(Echinochloa spp.)</i>
Catgrass	<i>(Leersia spp.)</i>
Blue flag	<i>(Zizaniopsis miliacea)</i>

Other plants may be used if approved in advance by local planning authorities or Water Management Districts. Consultation should also be made with the local NRCS and IFAS. Another source of information would be a local Professional Nursery.

a. Planting in Clumps: Most plants can be planted in clumps. (See Plate 6.98a) Square clumps of entire plants are cut out of the ground and placed in pits prepared in advanced on the chosen site. The clumps are planted at a depth where they will be submerged to a maximum of two-thirds their height.

b. Planting Rhizomes and Shoots: Less material is needed for the planting of rhizomes and shoots, which can be used to establish the Common Reed, Maddencane grass, Bulrush, Smartweed, and other plants. Slips are taken from existing beds during the dormant season after the stems have been cut. Rhizomes and shoots are carefully removed from the earth without bruising the buds or the tips of the sprouts. They are placed in holes or narrow trenches along the line of the average summer water level, so that only the stem sprouts are showing above the soil.

c. Planting Stem Slips: It is possible to plant stem slips of the Common Reed along slow-moving streams. (See Plate 6.98a) Usually, three slips are set in a pit 12 to 20 inches (30 to 50 cm) deep. If the soil is packed or strong, the holes must be located approximately 1 foot (30 cm) apart.

d. Reed Rolls: In many cases, the previously described methods do not consolidate the banks sufficiently during the period immediately after planting. Combined structures have therefore been designed, in which protection of the bank is at first insured by structural materials. Along slow to fairly fast streams, the most effective method of establishing herbaceous vegetation has been found to be the use of Reed Rolls also known as Wattles. (See Plate 6.98b).

e. Seeding: Wild millet can be sown 1/2 inch (13 mm) deep on very damp soil, provided that the seeded surface is not covered by water for several months after sowing. Seed at a rate 20 lbs./acre (22 kg/ha).

f. Vegetation and Stone Facing: Vegetation can be planted in conjunction with riprap or other stone facing by planting clumps, rhizomes, or shoots in the crevices and gaps along the line of the average summer water level.

2. **Establishing Shrub Zone Vegetation:** Stands of fullgrown trees are of little use for protecting streambanks apart from the binding of soil with their roots. Shrub wood provides much better protection; and in fact riverside stands of willow trees are often replaced naturally by colonies of shrub-like willows. Plants should be used which can easily adapt to the stream and site conditions.

NOTE:

1. STRAW WATTLES ARE TUBES MADE FROM STRAW BOUND W/ PLASTIC NETTING. THEY ARE APPROX. 8" DIA. AND 20 - 30 FT. LONG.
2. STRAW WATTLES TRAP SEDIMENT AND REDUCE SHEET & RILL EROSION BY REDUCING SLOPE GRADIENT, INCREASING INFILTRATION RATES AND BY PRODUCING A FAVORABLE ENVIRONMENT FOR PLANT ESTABLISHMENT.
3. STRAW WATTLE INSTALLATION REQUIRES THE PLACEMENT AND SECURE STAKING OF THE WATTLE IN A TRENCH, 3" - 5" DEEP, DUG ON CONTOUR. RUNOFF MUST NOT BE ALLOWED TO RUN UNDER OR AROUND WATTLE.

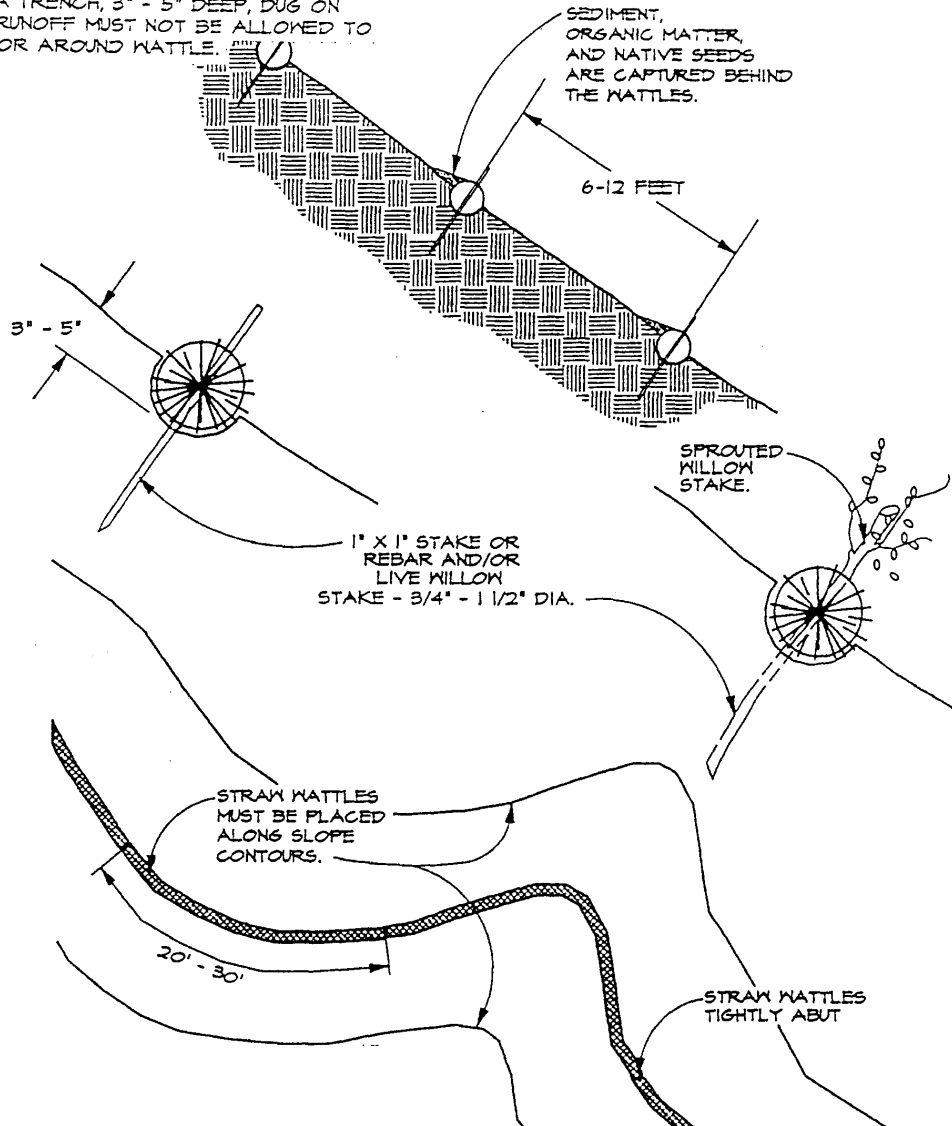

Plate 6.98b Straw Wattles

Source: Erosion Draw

a. Seeding and Sodding: Frequently, if the stream is small and a good seedbed can be prepared, grasses can be used alone to stabilize the streambanks. To seed the shrub zone, first grade eroded or steep streambanks to a maximum slope of 2:1 (3:1 preferred). Existing trees greater than four inches (10 cm) in diameter should be retained whenever possible. Topsoil should be conserved for reuse. Seeding mixtures should be selected and operations performed according to PERMANENT SEEDING - Section 6.66 - ES BMP 1.66. Some type of erosion control blanket, such as jute netting, excelsior blankets, or an equivalent structure should be installed according to MULCHING - Section 6.75 - ES BMP 1.75. Sod can also be placed in areas where grass is suitable. Sod should be selected and installed according to SODDING - Section 6.67 - ES BMP 1.67. Turf should only be used where the grass will provide adequate protection, necessary maintenance can be provided, and the establishment of other streambank vegetation is not practical or possible.

b. Planting Cuttings and Seedlings: Shrub willows, shrub dogwoods, and alders can be put into the soil as cuttings, slips, or stems. Willow (*Salix spp.*) and the Swamp Dogwood (*Cornus foemina*) or evergreen ground covers such as Lily Turf (*Liriope muscari*). On larger streams, Willow (*Salix spp.*) have been widely used with success. Again the first step in the planting process is to grade eroded or steep slopes to a maximum slope of 2:1 (3:1 preferred), making sure to remove overhanging bank edges.

Willows can be planted as one year old nurserygrown, rooted cuttings or as fresh hardwood cuttings gathered from local motherstock plantings. Swamp Dogwood and the alders should be nursery grown seedlings one or two years old.

This page left intentionally blank

REFERENCES

Florida Department of Environmental Regulation, 1988, The Florida Development Manual: A Guide to Sound Land and Water Management (Chapter 6). Tallahassee, FL

CHAPTER 7
THE EROSION AND SEDIMENTATION CONTROL PLAN

7.1	ELEMENTS OF AN EROSION AND SEDIMENT CONTROL PLAN	1
7.2	PREPARING AN EROSION AND SEDIMENT CONTROL PLAN	3
7.3	EVALUATING AN EROSION AND SEDIMENT CONTROL PLAN	13
7.4	IMPLEMENTING AN EROSION AND SEDIMENT CONTROL PLAN	17

CHAPTER NOTE

The erosion and sedimentation control plan is the document which describes who and what will control erosion; and when, where, and how this will be done. The plan is the common link of communication between the designer, the contractor, and the inspector. The plan is based on the principles found in Chapters 1 - 3, and incorporates the practices found in Chapters 4 - 6. A thorough understanding of the plan is essential for proper implementation. This chapter presents a comprehensive discussion of the erosion and sedimentation control plan.

7.1 ELEMENTS OF THE EROSION AND SEDIMENT CONTROL PLAN

The erosion and sediment control plan submitted to the approving agency with the project application should contain all the pertinent information for review and implementation. The following elements should be present and are required in many communities:

1. Narrative
2. Map / Site plan
3. Construction details
4. Calculations

1. The narrative

The narrative is a brief description of the overall strategy for erosion and sediment control. It should summarize for the plan reviewer and the project superintendent the aspects of the project that are important for erosion control and should include:

- a. A brief description of the proposed land-disturbing activities, existing site conditions, and adjacent areas (such as creeks and buildings) that might be affected by the land disturbance.
- b. A description of critical areas on the site--areas that have potential for serious erosion problems such as severe grades, highly erodible soils, and areas near wetlands or water bodies.
- c. A construction schedule that includes the date grading will begin and the expected date of stabilization.
- d. A brief description of the measures that will be used to minimize erosion and control sediment on the site, when they will be installed, and where they will be located.
- e. A maintenance program; including frequency of inspection, provisions for repair of damaged structures, and routine maintenance of erosion and sediment control practices

2. The Map / Site plan

The map is the key item in an erosion and sediment control plan. It should show:

- a. Existing and final elevation contours at an interval and scale sufficient for distinguishing runoff patterns before and after disturbance.
- b. Critical areas within or near the project area, such as streams, lakes, wetlands, highly erodible soils, public streets, and residences.

- c. Existing vegetation.
- d. Limits of clearing and grading.
- e. Locations and names of erosion and sediment control measures, with dimensions.

It is strongly recommended that standard symbols be used on the map to denote erosion and sediment control measures. Use of standardized symbols will speed up plan review time and make it easier for site superintendents and inspectors to understand plans quickly. These symbols were designed to be both pictorially representative of the control measures and easy to draw.

3. Construction Details, Specifications, and Notes

Construction details, often in large-scale, detailed drawings, provide key dimensions and spatial information that will not fit on the map. Other important information should also be provided; examples are seeding and mulching specifications; equivalent opening size (EOS) and strength requirements for filter fabric; specifications for wire mesh, fence posts, and staples; installation procedures for control measures; and maintenance instructions.

4. Calculations

Include the calculations used to size the control measures, particularly the data for the design storm (recurrence interval, duration and magnitude, and peak intensity for the time of concentration) and the design assumptions for sediment basins and traps (design particle size, trap efficiency, discharge rate, and dewatering time). Also include calculations to support the sizing of storm drain systems when an engineered design was necessary.

7.2 PREPARING AN EROSION AND SEDIMENT CONTROL PLAN

Preparing an erosion and sediment control plan is a four-step process:

- Step 1 Collect data
- Step 2 Analyze data
- Step 3 Develop site plan
- Step 4 Develop erosion and sediment control plan

This process is described step by step in the following section. It is primarily designed for relatively large projects (i.e., more than one building) on several acres or more. For very small sites, such as a single-home site, a more streamlined process may be appropriate. For example, doing a soil particle size analysis for sizing a sediment basin for a very small site would be overkill. It would also be unnecessary to do runoff calculations for sizing conveyances, since runoff from the site would probably be very minimal and a standard design would do the job in most cases.

Step 1: Collect Data

The purpose of data collection is to gather the information on site conditions that will enable you to develop an effective erosion and sediment control plan. Most of this data describes the natural environment of the site. Drainage information is particularly important (see Step 2).

It is best to collect all data in map form, if possible, and to plot it on one or more site maps at the same scale. Mapping the data at the same scale greatly facilitates the planning process by enabling you to overlay different maps and read through them on a light table. Use of a modern Geographic Information Systems (GIS) can greatly facilitate this process.

Topography

A good topographic map should form the basis of any kind of land planning, including site development planning and erosion and sediment control planning. From a topographic base map, you can determine drainage patterns, slope lengths and angles, and locations of sensitive features on or adjacent to the site such as water bodies, buildings, and streets. All of these are critical concerns in erosion control.

Prepare a topographic map of the site which shows the existing contours at a suitable interval for determining drainage patterns over small areas. The contour lines must be close enough together to show which way water will flow. On relatively flat sites, a 2-ft (0.6-m) or smaller interval will probably be needed. On a sloping site, a 10-ft (3-m) interval may be acceptable.

Drainage

The drainage pattern of a site has two components: overland flow and channel flow. Both

are important in erosion control. In the data collection stage, it is helpful to clearly mark all existing streams and major conveyances on the topographic base map. Major watercourses are shown as blue lines on U.S. Geological Survey topographic maps, but lesser drainageways will also be important to show. Delineating drainageways now will make it easier to determine watershed boundaries in the data analysis stage (Step 2).

Rainfall

In erosion control, rainfall data is primarily used for sizing large conveyances and sediment basins. Rainfall frequency and intensity are the key types of data. Rainfall intensity determines the *i* value used in runoff calculations. Rainfall intensity is also a component of the R factor in the universal soil loss equation. This equation can be used to estimate the sediment storage requirements of sediment basins. Rainfall frequency data is used for determining "a design storm". The use of rainfall data for designing stormwater and erosion / sediment control measures is described in detail in Chap. 3.

On small sites and in small drainage areas it is often unnecessary to size control measures by using rainfall data. Most of the control measures described in this handbook have been designed to handle a major storm in a small drainage area [typically 1 to 5 acres (0.4 to 2 ha)]. Since a fairly large margin of error has been incorporated in the standard designs, these structures, if used properly in small watersheds within the specified size limits, should be able to withstand major storms anywhere in Florida.

Project planners should use their knowledge of the yearly pattern of rainfall to schedule construction during the times of year when erosion potential is lowest. In Florida the dry season generally occurs from November to March with the rainy season lasting from March to November. Special attention to BMP installation and maintenance must be made when grading or construction must take place during periods of high erosion hazard. Rainfall data can be obtained from the National Climatic Data Center in Asheville, North Carolina, and the National Technical Information Service in Springfield, Virginia. Local rainfall data can be obtained from the Florida Department of Transportation. If you are not aware of the best source of rainfall data in your area, start by contacting the city or county public works department or the local Water Management District.

Soils

Soils data is used to locate highly erodible areas on a site, where extra erosion control precautions may be needed. It also shows the distribution of particle sizes in the soil, a critical factor in sizing sediment basins and traps. A high content of clay and fine silt in a soil should suggest a strategy of erosion control by using vegetation and mulch rather than a strategy of sediment control by using straw bales and sediment basins.

Soils data for many parts of the country can be obtained from soil surveys published by the U.S. Natural Resources Conservation Service (NRCS). For many projects, a soils report is specially prepared by a soils engineer. On hillside sites, many jurisdictions routinely require a soils report. If a soils report is to be prepared, it is desirable to include in it a particle size analysis for sediment basin or trap design. Such an analysis can be performed for a nominal extra cost.

Ground Cover

"Ground cover" primarily refers to existing vegetation, which should be preserved to the greatest extent possible because it is the most effective form of erosion prevention. Many communities also wish to preserve trees and certain vegetation for aesthetic and other reasons. Ground cover, along with other physical characteristics of the watershed, is used to determine the C factor in the rational method for calculating runoff (Chap. 3). It is also used to calculate the erosion rate in the universal soil loss equation.

Adjacent Areas

Off-site features, such as streams, lakes, wetlands, buildings, and roads, are particularly sensitive to erosion and sediment damage. Such areas should therefore be noted on the site map. If including the off-site features on the same map would result in an unwieldy document, one of the following options can be chosen:

- a. Describe on the margin of the map the nature and location of the adjacent feature.
- b. Draw a smaller-scale map (vicinity map) showing the site and all the pertinent adjacent features.

Step 2: Analyze Data

The purpose of this step is to interpret the data collected in Step 1 for its significance in erosion and sediment control. This interpretation may require stating the data in a different form (e.g., translating a topographic map into a slope map). The result of this step is a map that highlights areas of importance in erosion and sediment control.

Drainage Areas

The most important part of Step 2 is to understand the site's surface water flow pattern. You must determine:

- a. Where will concentrated and sheet flows enter the site?
- b. How will runoff, both concentrated and sheet flow, travel across the site?
- c. Where will runoff leave the site and will it be concentrated or sheet flow?
- d. How much water will flow?

Map the drainage boundaries of each of the water courses delineated in Step 1, and then estimate the area of each major watershed. If the site is larger than 5 acres (2 ha), you may have to subdivide the watersheds into smaller units. Bear in mind that many control measures discussed in this handbook have a 5 acre (2 ha) maximum drainage area and that straw bale dikes, silt fences, and most inlet protection structures have a 1 acre (0.4 ha) limit. Define watersheds that are appropriate for the control measures to be used. If grading will alter natural watershed boundaries, you will later need to map the drainage boundaries that will exist after grading is completed (see Step 4). If grading will not be

completed before the rainy season, you may have to have several interim drainage plans.

Rainfall and Runoff

Examine the rainfall data collected in Step 1 to determine the times of year when erosion potential is at its lowest and highest. Try to schedule grading during times of low erosion potential and take extra precautions during times when heavy, intense rainfalls are likely.

If a project will require permanent waterways and sediment basins draining large areas, rainfall frequency and intensity data will be used to calculate runoff volumes to be expected. Since these calculations must be based on specific watershed areas that drain to each planned facility, the calculations must be done at a later stage of plan development (see Step 4).

Slope Steepness and Slope Length

Slope steepness and slope length are critical factors in erosion control. The longer and steeper the slope, the greater the erosion potential. If an existing long or steep slope is disturbed or a new one is created by grading, carefully designed and installed erosion control measures will be required. These measures may include benches or ditches at regular intervals, temporary vegetative stabilization, or stabilization using a covering of punched straw or other mulch material.

Erosion potential is closely related to slope steepness. The following slope categories can be used as a rough guide for evaluating erosion potential:

0-7 percent slope	Low to moderate potential
7-15 percent slope	Moderate to high potential
Over 15 percent slope	High to very high potential

It is a good idea to outline on the topographic base map the above slope categories. Slopes that are over 15 percent and 7 to 15 percent slopes that are very long [over 100 ft (30 m)] should be highlighted as critical.

Soils

A soils report or soil survey covering the site should indicate soil erodibility. The K factor in NRCS soil surveys is an estimate of soil erodibility. Highly erodible soils should be left undisturbed. If they must be disturbed, they should be mulched and revegetated as soon as possible after grading is completed.

If the soils report gives a soil particle size distribution, check what percentage of the soil is composed of fine particles (typically 0.02 mm or smaller). If a high percentage of the soil is smaller than 0.02 mm, much of the suspended sediments will escape capture unless a very large sediment basin is constructed. Remember that grading will mix topsoils with subsoils and move them around the site. If fill will be imported, this material should be analyzed also.

Ground Cover

Note any areas of critical vegetation. Vegetation on or above long or steep slopes and on highly erodible soils is particularly important for erosion control.

Adjacent Areas

Examine areas downslope from the project. Note any watercourses or other sensitive features which receive runoff from the site. Analyze the potential for sediment pollution of these watercourses and the potential for downstream channel erosion due to increased volume, velocity, and peak flow of storm runoff from the site.

Step 3: Develop Site Plan

When a site plan is developed, erosion and sediment control should be considered along with such traditional planning criteria as economics, utility access, and traffic patterns. After analyzing the erosion hazards on site in Step 2, develop a site plan with erosion control in mind. Consider the following points when preparing a site plan.

Fit Development to the Terrain

Tailor the locations of building pads and roads to the existing contours of the land as much as possible. Locate them to take advantage of the natural strengths of the site and to minimize disturbance.

Confine Construction Activities to the Least Critical Areas

Land disturbance in critically erodible areas, such as steep slopes, will require installation of costly control measures. Keeping construction out of these areas will minimize the costs.

Cluster Buildings Together

Clustering buildings minimizes land disturbance for roads and utilities and reduces erodible area. Other benefits of clustering are reduced runoff, preservation of open space, and reduced development costs.

Minimize Impervious Areas

Make paved areas, such as streets, driveways, and parking lots, as small as possible. Preserve trees, grass, and other natural vegetation. Consider paving driveways with gravel or porous paving stones. French drains, infiltration trenches, and dry wells can be used to percolate runoff from impervious surfaces into the soil if soil conditions allow. Gravel-filled trenches can be located along drip lines below roof eaves. These measures will keep runoff volumes low and minimize the need for conventional storm drains - drop inlets and underground pipes. However, to prevent these infiltration practices from failing it is crucial that heavy equipment be kept away from these areas to prevent soil compaction. Additionally, infiltration areas should never be used for erosion and sediment control.

In many communities, residential streets are wider than they need to be. Typically, these streets are designed to carry two lanes of traffic and two rows of parked cars, one on each side of the street. An alternate approach, if parking is not a critical problem, is to eliminate the space for the two rows of parked cars and, instead, provide parking bays at regular intervals. This approach will substantially reduce the size of paved areas.

Retain the Natural Stormwater System

Use the natural stormwater system to convey runoff from the site wherever possible. If possible, augment the natural system with vegetated swales rather than storm sewers or concrete channels. If impervious surfaces are kept to a minimum and runoff from these surfaces is percolated into the soils on-site, it may be possible, without installing channel protection measures, to use the natural stormwater system to drain a development. The cost of using the natural drainage system can be substantially lower than the cost of constructing a conventional storm drain system. Preserving the natural stormwater system can also retain a visual amenity that will enhance the value of a development.

If runoff flows will be increased by development, route these augmented flows into a stormwater conveyance system and preserve the natural stormwater system in its preexisting condition. If the stability of the natural system is upset, it may be very difficult to prevent a longterm erosion process from beginning. A constructed stormwater conveyance system can be designed to resemble a natural creek.

STEP 4 Develop the Erosion and Sediment Control Plan

Determine Limits of Clearing and Grading

Start with a topographic base map that shows existing and finished contours and proposed improvements. On this base map, delineate the limits of the disturbed area. This line defines the area that must be protected.

Reexamine Drainage Areas

Check to see if the drainage boundaries defined in Step 2 have been altered by the development plan. If so, outline the drainage areas that will exist after grading. Since many control measures have a 1-acre (0.4-ha) or a 5-acre (2-ha) drainage area limit, you may want to break large watersheds into smaller units (see the following subsection). Enlarged drainage areas and/or increased impervious surface within a drainage area will produce increased flows. Discharging the increased flows to existing swales and watercourses will cause channel erosion, unless/until the conveyances are adequately prepared.

As was done in Step 2, determine where concentrated flows will originate on and off-site, how runoff will cross the site, and where runoff will leave the site. Check for and avoid unnaturally concentrated flows in natural swales created by pipes, ditches, berms, etc.

Apply the Principles of Erosion and Sediment Control

1. *Fit development to the terrain*

This principle is applied in the site development process (see Step 3).

2. *Time grading and construction to minimize soil exposure*

Schedule the project so that grading is done during a time of low erosion potential. On large projects, stage the construction, if possible, so that one area can be stabilized before another is disturbed. Apply erosion control measures as soon after land disturbance is completed as is practical.

3. *Retain existing vegetation wherever possible*

When laying out site improvements, try to site buildings between existing tree clusters and build roads around trees. Route construction traffic to avoid existing or newly planted vegetation. Avoid unnecessary clearing of vegetation around building pads, where construction will not be taking place. Also avoid disturbing vegetation on steep slopes or in other critical areas. Physically mark off the limits of land disturbance on the site with rope, fencing, surveyors' flags, or signs so that workers can clearly see areas to be protected. A bulldozer operator will probably not know to protect a clump of trees that is only noted on a set of plans.

4. *Vegetate and mulch denuded areas*

Reestablish vegetation on all denuded areas that will not be covered with buildings or pavement. If graded areas are to be paved or built upon at a later date they must be stabilized temporarily by mulching or establishing a temporary vegetative cover on those areas. It is often cheaper to establish and remove a temporary cover on such an area than to repair the gulying and sediment damage that is likely to occur. Before seeding an area, make sure necessary stormwater controls are installed (see the following subsection). Plant establishment will be more successful if graded slopes are roughened or scarified before seeding.

5. *Divert runoff away from denuded areas*

Determine how runoff should be conveyed from the top to bottom of each drainage area. Is a diversion or a slope drain required? If so, locate it where it can intercept potentially erosive flows and route them to a well-protected outlet such as a storm drain or a lined channel. Do not allow runoff to cross a denuded or newly seeded slope or other critical areas. All conveyances and systems should be fully stabilized before allowing flows into them. If there is a significant drainage area above a cut or fill slope construct a diversion and slope drain at the top of the slope to convey the water to the bottom without causing erosion. Diversions and conveyances also can be used at the base of a disturbed slope to protect downstream areas by diverting sediment-laden runoff to a sediment trap or basin. It is often good strategy to construct a diversion or swale all the way around a disturbed area to prevent clean runoff from entering the area and also to prevent silt-laden runoff from escaping before being desilted.

6. Minimize length and steepness of slopes

On long or steep disturbed or constructed slopes construct benches, diversions, or swales at regular intervals to intercept runoff. Each bench should be tilted at a gentle grade into the hill to channel the flow along the inner edge of the bench. Route the intercepted runoff to a protected outlet.

7. Keep runoff velocities low

Keep runoff velocities low by:

- a. Minimizing flow path lengths
- b. Constructing channels with gentle gradients
- c. Lining channels with rough surfaces
- d. Using check dams in channels

8. Prepare conveyances and outlets to handle concentrated or increased flows

Design stormwater conveyance channels to withstand the expected flow volume and velocity from a design storm. Compute the expected discharge and velocity for both existing and newly constructed swales and for on- and off-site channels which will carry increased flow as a result of the project. By using these calculations, determine whether any drainage channels will require protection. If the computations indicate the runoff flow will be erosive, first determine whether a vegetative lining will be sufficient. If the expected velocity exceeds the limit for the specified grasses, choose between rock, asphalt, or concrete linings. Remember, grass and rock linings are desirable because they keep velocities low, allow runoff to percolate into the soil, and are aesthetically pleasing. Because they resemble natural conveyances, they can enhance the appearance of a development.

Also determine whether outlet protection will be needed. Pay particular attention to transitions from pipes or paved channels to natural or unlined channels. Locate riprap aprons or other energy-dissipating devices at discharge points where erosion is likely.

9. Trap sediment on site

Install sediment basins or traps, silt fences, or straw bale barriers below denuded areas so that runoff will be detained long enough for suspended sediment to settle out. Try to locate sediment barriers in relatively level areas or in natural depressions. A flat area at the base of a slope is a good location for a silt fence or straw bale dike because the runoff can slow down before reaching the barrier and the sediment has a place to settle. Avoid placing sediment barriers where their construction would cause excessive soil disturbance. For example, excavating a sediment trap on a hillside is likely to cause more soil erosion and sedimentation than the device was intended to prevent. Also, locate sediment barriers above sensitive areas such as streams, lakes, public streets, and adjacent properties.

Make sure there will be adequate access in wet weather for maintenance and sediment removal.

Individual lots can be surrounded by dikes to create small sediment traps called lot ponds. Gravel- or fabric-covered driveway aprons can serve as the outlets. If standing water on lots will interfere with construction activities, this type of sediment control should not be used. However, lots are often graded but are not built upon for months or even years. In these situations, lot ponding may be a good approach. It should be realized, however, that lot ponding may necessitate recompaction of pads prior to building construction. Consult the soils report for the soil engineer's recommendation on this issue.

The size of the drainage area determines which type of sediment barrier should be used. Straw bale dikes and silt fences have a 1-acre (0.4-ha) drainage area limit. A sediment trap is generally adequate in drainage areas of less than 5 acres (2 ha). A sediment basin is needed if the drainage area exceeds 5 acres (2 ha). Unless the basin is designed as a permanent pond, its maximum drainage area should be less than 150 acres (60 ha). Drainage areas larger than 150 acres (60 ha) can be subdivided into smaller subcatchments by creating barriers to trap runoff in stages, perhaps in a group of basins. Basins must drain in parallel, not in series. When a watershed is subdivided into smaller drainage areas, each with its own sediment basin, the degree of risk is likely to be substantially lower. That is, the damage which could be caused by the failure of a small basin in a small watershed is minor compared to the damage potential of the failure of a large basin in a large watershed.

Dividing a watershed into smaller drainage areas also can save money. Sediment basins are more costly than simple sediment traps to construct. In addition, sediment basins require an engineered design, whereas sediment traps are typically based on standard designs.

Sediment basins and traps are commonly located below large disturbed areas, at the lowest point in a watershed, and in swales and small conveyances. Do not locate a sediment basin in a major stream, such as one designated with a blue line on a U.S. Geological Survey topographic map or in a wetland. It is unnecessary, costly, and dangerous to impound runoff from large, undisturbed areas. Trap the sediment-laden runoff before it enters a stream.

10. *Inspect and maintain control measures*

Develop a maintenance schedule and instructions for maintaining control measures. The instructions should specify where sediment dredge spoils should be placed, what spare materials (such as extra filter fabric, straw bales, stakes, and gravel) are needed, and where they should be stockpiled.

It is the responsibility of the contractor to make sure that all workers understand the major provisions of the erosion and sediment control plan. If they understand the plan, they are less likely to disturb drainage patterns and control measures, as by running over a dike with a truck. A routine end-of-day maintenance check is strongly advised, while inspections are required after any storm with a quarter inch or more of rainfall. In particular, the site superintendent should look for breaches in dikes and for erosion or sedimentation near

wetlands, waterbodies, discharge points, or roads. All maintenance procedures and the maintenance schedule should be specified on the plans. The plans should also remind the contractor of his or her responsibility to inform construction site workers about the erosion and sediment control features on the site.

7.3 EVALUATING AN EROSION AND SEDIMENT CONTROL PLAN

The following section is written from the perspective of a public agency plan reviewer. It describes what to look for when evaluating an erosion and sediment control plan. A checklist is helpful, however, over reliance on checklists can give a false feeling of completeness. A checklist can be developed using Appendix 8-D-1.

General Approach

Responsibility

It is not the responsibility of the plan reviewer to see that the plan is the best possible one. The reviewer can only ensure that the plan meets the minimum standards set by the reviewing agency and its authorizing regulations.

Communications

Encourage informal communications between the plan reviewer and the plan preparer. This will enable the reviewer to make informal suggestions that may save the developer money and the preparer time, and it may result in a better, more effective plan. It will also enable the preparer to explain and justify the plan. Pre-application conferences are strongly encouraged.

Required Information

Make sure all the required information has been submitted. Checklists can be used by both plan reviewers and plan preparers. However, checklists can encourage laziness. Having everything checked off does not necessarily mean that everything is in order.

Incomplete Plans

Do not review seriously incomplete plans. Send them back with a request for the missing information.

First Review

The first review should be a complete review. In subsequent reviews, deal only with items identified in the first review. It is unfair to the developer to keep injecting new requirements in subsequent reviews.

Plan Concept

The concept should be examined first, starting with the general and moving to the specific. Does the plan make sense?

Schedule

Examine the construction schedule. Will grading be completed before the rainy season? When will stormwater management facilities, paving, and utilities be installed in reference

to the rainy season? If grading will take place during months when there is a high probability of heavy rains, what extra precautions will be taken to protect against erosion, sedimentation, and changing drainage patterns?

Site Stormwater

Make sure you understand where all runoff, including roof-top runoff, comes from on and above the site, where it goes, and how it traverses the site. For large sites, require or prepare a drainage area map. If runoff patterns are unclear, ask for clarification.

Sediment Basins and Traps

Locate all sediment basins and traps, and define their contributing areas.

Erosion Control

Check the method used to prevent erosion. Hydraulic seeding and mulching may adequately stabilize some areas, but other areas, because of their proximity to sensitive features such as watercourses or their steepness or lack of backup protection such as sediment basins, may need far more intensive Revegetation efforts. On critical slopes, a reliable backup system for hydraulic seeding, such as punched straw, is strongly recommended. Even better, these areas should be sodded.

Channels and Outlets

Examine all conveyances where concentrated flows will occur. Be sure adequate erosion protection is provided both along channels and at channel and pipe outlets. Check the sources of runoff to be sure that all the runoff comes from undisturbed or stabilized areas or has been desilted by sediment basins or other sediment retention devices.

Miscellaneous

Look for haul roads, stockpile areas, and borrow areas. They are often overlooked and can have a substantial effect on drainage patterns. Look at all points of vehicle access to the site and be sure mud and dirt will not be tracked onto paved streets and that sediment-laden runoff will not escape from the site at these points. Pay particular attention to watercourses and their protection.

Plan Details

Once the plan concept has been shown to be sound, check the details to be sure the concept is adequately executed in the plans.

Structural Details

Be sure that sufficiently detailed drawings of each structure (sediment basin, dike, swale, silt fence, etc.) are included so there is no doubt about locations, dimensions, or method of construction.

Calculations

See if calculations have been submitted to support the capacity and structural integrity of all structures. Were the calculations made correctly?

Vegetation

Look at seed, fertilizer, and mulch specifications. Check quantities and methods of application to be sure they are appropriate and consistent with local guidelines.

Maintenance

Be sure that general maintenance requirements and specific maintenance criteria, such as the frequency of sediment basin cleaning, are included. Are there stockpiles of spare materials (filter fabric, straw bales, stakes, gravel, etc.) to repair damaged control measures? Routine maintenance inspections should be part of the plans.

Contingencies

The plan must provide for unforeseen field conditions, scheduling delays, and other situations that may affect the assumed conditions.

Technical Review

The erosion and sediment control plan should be reviewed by the soils or geotechnical consultant for the project, if there is one.

Signature

The erosion and sediment control plan should be signed by a qualified design professional.

This page left intentionally blank

7.4 IMPLEMENTING THE PLAN

Installation of an erosion and sediment control plan will be discussed in seven distinct steps, primarily from the standpoint of the job superintendent. The steps are:

1. Study of the plan and site to organize implementation.
2. Pre-construction conference between the job superintendent and inspector.
3. Site preparation
4. Inspection and maintenance
5. Grading and utilities installation
6. Building construction
7. Permanent stabilization.

1. Study the plan and the site.

The job superintendent must be thoroughly familiar with both the erosion and sediment control plan and the construction site. Note all of the critical areas indicated in the plan and then actually identify their location and extent on the ground. These should include stream channels and associated flood plain areas, drainageways, and outlets into streams, points where land-disturbing activities are adjacent to or must cross streams and drainageways, steep slopes and highly erodible soils, and runoff entering the site from adjacent areas. Note what practices are specified to protect these areas. Also, be aware of critical areas not specifically treated in the plan; and discuss these with the inspector at the pre-construction conference.

Next determine the locations of all control measures and determine their "fit" on the land. Note any needed adjustments, and plan to discuss these at the pre-construction conference.

Check the schedule for the installation of erosion and sediment control practices, the schedule for all earth-disturbing activities, and the relationship between the sequence and timing of BMP installation and the earth-disturbing activities. The timing and sequence of installation are important elements of an erosion and sediment control plan. The site must be ready for rain before the earth-disturbing activities are started. For this reason, certain practices must be in place and ready to provide protection before other areas are exposed.

The staging of major earth-disturbing activities to limit the size of bare area exposed at any time is another important element of the plan which should be noted.

2. The pre-construction conference.

The next step is a pre-construction conference and site review with the erosion and sediment control inspector. It should be called for by the job superintendent and should be held on the construction site. The conference may also include the design professional,

the owner, and inspectors from other agencies. The site review will help all parties in meeting their responsibilities. All aspects of the plan should be discussed to ensure that the job superintendent and the inspector are in agreement in interpreting the plan, scheduling, procedures, and practices which are to be used. They should agree particularly on the critical problem areas and on the perimeter practices specified to prevent damage to adjacent properties.

The location of all measures should be discussed. If the study of the plan indicates that adjustments in location are needed, these should be discussed with the permitting agency and the inspector. The inspector may authorize minor adjustments such as moving a diversion from a property line to a grading limit, or shifting an outlet to match a natural depression in the land. Major adjustments will require formal revision of the plan and should be approved by the permitting agency.

The sequence of installation of practices and earth-disturbing activities should also be discussed. The guidelines for erosion and sediment control planning require that sediment basins and other appropriate erosion and sediment control measures be installed prior to or as a first phase of land grading. Other appropriate measures include construction entrances, diversion dikes, interceptor dikes, perimeter dikes, gravel outlet structures, level spreaders, swales, protected outlets, and grade stabilization structures. The superintendent and the inspector must be firm about establishment of these practices before grading begins. A sample pre-construction checklist is provided in Appendix 8-D-2.

3. Site preparation.

One of the first things to do in preparing the site is to lay out all traffic circulation routes and storage areas. Route locations should be chosen to pose the least threat to the critical areas which have been identified. Well-vegetated areas should be damaged as little as possible. Soil stockpiles should be located a safe distance from waterways and streams. Barriers may be required to keep traffic within the delineated areas or at least out of the critical areas. If needed, barriers should be installed before opening the site to general construction traffic.

Required sediment trapping practices should be installed. Note that compacting, seeding, and mulching are required to stabilize these practices. Next, waterways and outlets should be installed with the vegetation or lining material called for in the plan.

The work force should be instructed about the location of critical areas and sediment control practices and the need to protect these areas from damage.

4. Inspection and maintenance of erosion control measures.

Maintenance differs from the other activities. It must begin as soon as the first practice is installed and must continue through all the succeeding activities until the permanent erosion control measures are established and functioning. The features of a maintenance program are described in the narrative part of the plan. All structural measures should be checked at the close of each work day and, particularly, at the end of the work week. Also, they must be checked before and after each rainstorm of one quarter inch or more. Diversion berms should be checked to see that they have not been breached by

equipment. The condition of level spreader areas, waterways, and other outlets should also be checked. Traffic should be moving within the established access routes. Channels should be checked for sediment deposits or other impeding material. Repairs should be made promptly when damages are discovered. When repairing swales or other channels, the new lining material should be at least as erosion resistant as the original material. Vegetative practices and vegetative cover on structural practices require maintenance fertilizer and, perhaps, mowing. All sediment traps should be checked and cleaned out after each storm. Sediment basins should be cleaned out when the deposited material reaches the level designated in the plan or standards and specifications. A sample maintenance checklist is provided in Appendix 8-D-3.

5. Grading and utility construction.

The fifth major step is the grading and utility installation. If stockpiling of fill or topsoil is planned, a pre-selected, relatively safe stockpile area should be used. To minimize the hazard of erosion, the slopes of the stockpile should be flattened at the end of each working period. The stockpile should be mulched and seeded as soon as it is completed.

Disturbed areas which can be brought to final grade at this stage during a satisfactory season for seeding should be seeded, sodded, or otherwise stabilized with the permanent material and techniques indicated in the plan. If they cannot be seeded, they should be stabilized with anchored mulch. Areas which are to remain at rough grade for more than 14-days before permanent stabilization must be mulched and seeded to temporary cover immediately following rough grading.

Utilities such as storm sewers, sanitary sewers, electrical conduits, water mains, and gas mains are usually installed at this time. To minimize the amount of area disturbed, the work should be organized and the trenches sized to take several utilities in one trench. The installation should be carefully coordinated to reduce the time that the trenches must stay open. Excavated materials should be placed on the side of the trench away from streams and conveyances. If sediment-laden water must be pumped from utility trenches, it should be conveyed safely to a sediment trap or basin. As soon as possible, trenches should be filled, compacted, mulched, and seeded to temporary or permanent vegetation.

As soon as the storm sewers are installed, inlet sediment traps should be installed to prevent sediment from entering the system. If called for, storm drain outlet protection should be installed.

6. Building construction.

The sixth major step or stage is building construction. Two major hazards are common during this step. The first major hazard is that additional equipment and work force bring added risks to areas which should be protected. Efforts to control traffic must be increased during this period. All types of traffic should be made to stay on the established travel routes.

The second major hazard is from the excavated material. This phase usually results in high volumes of soil for disposal and stockpiling. Stockpiles should be located where they will not wash into drainageways or onto previously stabilized areas. The slopes on these

areas should be flattened and they should be protected by anchored mulch and temporary seeding. Excavations should be backfilled as soon as possible, and appropriate surface protection should be provided.

Runoff from roof-tops should be directed to stabilized areas upon completion of the structure. Whenever possible the runoff should be treated or infiltrated in swales or retention facilities. Roof-top runoff should never be tied in to sanitary sewers.

7. Permanent stabilization.

The seventh and last step is permanent stabilization. As mentioned earlier, this need not and should not be delayed until the entire development is completed. A significant reduction in erosion damage repair costs and regrading costs can be made if smaller areas are stabilized with permanent vegetation as soon as they are ready.

Most sediment basins, dikes, sediment traps, and other control structures should be removed, regraded, mulched, and seeded before leaving the site. However, the inspector should be consulted before removing them--they should not be removed until the surrounding area is stabilized and they are no longer needed.

In some cases, sediment basins, diversions, and swales are to remain as part of the permanent runoff management system. In such cases, sediment basins should be cleaned out to provide the required capacity and stabilized with suitable permanent vegetation. Diversions and swales should be checked, repaired if needed, and left in good condition. The inspector will check on the final condition of measures which are to be retained.

When final grading is completed, all bare areas should be stabilized with permanent vegetation. The standards and specifications for permanent vegetative practices in the Chapter 6 of this manual and Chapter 6 of The Florida Development Manual give information on various materials and methods for permanent stabilization. A sample final inspection checklist is provided in Appendix 8-D-4.

REFERENCES

Delaware Technical and Community College Terry Campus, 1991. Sediment and Stormwater Management Certified Construction Reviewer Course. Dover, DE

Goldman, S.J., K. Jackson, and T.A. Bursztynsky, 1986. Erosion and Sediment Control Handbook. McGraw-Hill, Inc. New York, NY

CHAPTER 8 INSPECTION AND ENFORCEMENT

8.1	THE ROLE OF THE INSPECTOR	1
8.2	SITE INSPECTION	3
8.3	INSPECTING EROSION AND SEDIMENT CONTROL PRACTICES	11
8.4	INSPECTING STORMWATER SYSTEMS DURING CONSTRUCTION	17
8.5	INSPECTING VEGETATION USED FOR EROSION CONTROL	27

APPENDICES:

8-A	HUMAN RELATIONS	31
8-B	CONDUCT GUIDELINES AS A WITNESS	37
8-C	ESTIMATING QUANTITIES	40
8-D	SAMPLE INSPECTION CHECKLISTS (GENERAL)	41
1.	PLAN REVIEW	43
2.	PRE-CONSTRUCTION CONFERENCE	45
3.	ROUTINE INSPECTION	47
4.	FINAL INSPECTION	51

CHAPTER NOTE

The specific duties and responsibilities of the inspector depend in part on the employing agency or company, however many of these duties and responsibilities are common to all inspectors. This chapter presents only the essential functions that are common to all inspectors. There is no substitute for on-the-job training from experienced inspectors or supervisors.

8.1 THE ROLE OF THE INSPECTOR

This section is intended primarily for inspectors employed by regulatory agencies. Except for enforcement issues, most of the material will also apply to inspectors working for private firms. Additionally, private inspectors may be called upon to monitor and document other matters such as costs, schedule adherence, and consumption of supplies.

Conduct

The inspector must have technical expertise in erosion prevention and sediment control. In addition, in order to achieve full compliance, the inspector must be able to deal effectively with people. For example, disputes sometimes arise about a site violation. The person responsible for the site may disagree with your assessment of the site. Neighboring landowners may be upset and demand that corrective action be taken immediately. At times like these, it is easy to become overly emotional. The inspector must remain impartial in order to gain the respect of all parties, steer them toward resolution, and achieve compliance. No matter what the situation, inspectors need to carry out their responsibilities in a professional manner and in accordance with the rules. Inspectors must be consistent in their inspections and enforcement, handling all sites, individuals, problems, and violations in the same manner. Inspectors must maintain their integrity if they are to do the job well and be respected as professionals.

In dealing with the public it is most important to follow proper legal procedures and to remain courteous and fair. If you fail to follow proper legal procedures you may not be able to bring enforcement action against a violator. By showing proper courtesy and fairness, you encourage mutual respect among all persons involved. Parties responsible for construction sites are less likely to violate the rules if they see the inspector as a competent professional.

Inspectors need to know how to deal with people. See Appendix 8-A for guidelines on dealing with people who are angry or upset. The guidelines can be a big help in your job.

Compliance

Remember that the goal of the program is to prevent accelerated erosion and off-site sedimentation. As the inspector, you are the first person to determine if the performance standards and intent of the rule are being met. You are the key person ensuring that construction sites are evaluated fairly and consistently and that the responsible party keeps the site in compliance.

The erosion and sediment control rules are performance oriented. That is, the measures used at a construction site ***must be effective in controlling erosion and preventing off-site sedimentation for the site to be in compliance.*** Following an approved plan and installing the control measures may not be enough for a site to be in compliance with the rules. If erosion and off-site sedimentation occur, the person responsible must install additional measures to correct the problem.

The rules are also flexible, allowing the responsible parties to decide the most economical and effective means for erosion control. This encourages the use of innovative techniques

and specifically designed erosion control systems. The inspector is a key individual in making this kind of performance based rule work because the inspector is the first person to recognize performance failures and report problems. The inspector's job is to:

1. Determine that an erosion and sediment control plan for the site has been approved.
2. Determine that all specified practices have been installed and are being maintained according to the plan.
3. Determine that off-site sedimentation and turbidity is being prevented.

If the inspector finds deficiencies, appropriate action must be taken to attain compliance.

Handling violations

As the inspector of the site, you play a central role in providing details of violations and subsequent corrections. The inspection records that you write are the basis for enforcement and civil penalties. You are the first person to determine whether the measures on the site are performing properly; thus, you are the first link in enforcing the erosion and sedimentation rule. Inspectors are often called to appear at enforcement meetings or hearings as witnesses to document a violation. For information on how to conduct yourself as a witness, refer to Appendix 8-B.

You should write a report for every inspection of a site. When writing your inspection report, remember that it is a legal document. Your report must be written legibly, accurately, consistently, and in clear and concise language. Report all violations observed each time you visit a site even if you have reported some of them on previous visits. ***Always write inspection reports while you are on the site*** so that you will not forget items and can recheck conditions if you have doubts.

Field notes are very effective in meetings. They should be organized, thorough, concise and legible. Make a habit of taking organized, well-written notes. It will pay off in your first enforcement case.

The private inspector must also document activities thoroughly and accurately. This will be the client's best defense in the event of a violation. Good documentation will show whether the client is a "habitual offender" or a conscientious professional who has been overwhelmed by unusual events, often an important factor in determining a resolution.

8.2 SITE INSPECTION

Inspections don't "just happen". A great deal of planning and preparation goes into a proper and thorough inspection. Inspectors need to review construction plans, attend preconstruction conferences and be knowledgeable of the law and standards. Knowing why a site is or is not in compliance is a key part of the inspector's duty.

The inspection

An erosion control plan is designed to minimize erosion and control sedimentation. However, components of the plan may fail or the responsible party may not adhere to the plan. As an inspector of construction sites, your job is:

1. To be certain that all erosion and sediment control measures in the approved plan have been properly installed and maintained.
2. That erosion is being controlled.
3. That off-site sedimentation is being prevented.
4. That no turbidity in adjacent streams is being generated.

It takes time to learn how to inspect a construction site properly. Project sites are often large and can have many land-disturbing activities occurring at the same time, which can be confusing. Also, there are many considerations to keep in mind while conducting the inspection. You must be familiar with the rules, and many erosion and sedimentation control practices. With some experience, however, you will soon feel comfortable about making an official erosion control inspection.

A proper inspection requires planning and a systematic approach. With careful preparation, you can carry out your duty and work cooperatively with all responsible parties so that those involved can do their jobs efficiently.

Tolerances

The inspector must be reasonable regarding dimensional and performance criteria while performing inspections. This requires an understanding of the intended function of the various BMPs. Obviously a catch basin with an opening designed to support a grate has a zero tolerance for being too small because the grate will not fit. If the opening is one-half inch too wide, the grate will fit and still be supported by the sill or lip. If the opening is two inches wide, the grate will fall in. This dimensional tolerance can be described as "half inch plus, zero minus".

A stormwater pond is often designed with 1' (30 cm) of freeboard over the riser or spillway. High spots or slightly low spots will probably not affect the performance of the pond. On the other hand, it is critical that the lip of a level spreader is installed "perfectly" level. In this situation, high or low spots will both have the effect of producing concentrated flows. Thus there is almost zero tolerance, plus or minus.

Other situations are not as simple to define. The allowable (minor) amount of mud tracked, or dust generated, from a site may be somewhat subjective. Many factors are involved in determining performance tolerances, such as severity and frequency of infractions, efforts by the contractors, limitations of the technology and products available, and possibly several other factors. However tolerances are determined, it is essential to the integrity of the inspector and the agency that they are applied with consistency and impartiality.

Preparing for an inspection

The first step in inspecting a project is to review plans when first submitted. This review will alert you to potential problems at the site and weaknesses in the erosion and sedimentation control system design. While at your office, look for the following items in the plan. (There are other items that you may want to include as you gain more experience.)

1. Check contour maps and available aerial photos to see how the water flows through the site. Note where water enters and leaves the site. Determine the direction of flow in the general area and in the watershed where the project is located.
2. Note whether the site borders a sensitive area such as a stream or high quality water body. The boundary should be especially well protected from sedimentation.
3. Pay particular attention to critical areas such as step cut-and-fill slopes, stream crossings, channels, outlets of pipes and diversions, construction access routes and highly erodible soils.
4. Look for adequate access and space to maintain erosion and sediment control measures.
5. Make sure that the plan provides an installation sequence for measures to control erosion and sedimentation, with measures for one phase being installed before grading of the next phase begins.
6. Study the construction schedule to determine whether long periods of time exist between phases of construction. If so, temporary seeding or other temporary soil stabilization will be required.
7. Check to make sure that the plan requires all surfaces to be stabilized as soon as possible after completion of the project and within seven working days. Temporary and permanent seeding should also be specified.
8. Remember that when the contractor is finished, the entire site should be stabilized - no accelerated erosion and no off-site sedimentation should occur.
9. Be sure that the perimeter of the site is protected to prevent off-site sedimentation and keep off-site runoff from flowing across highly erodible areas during construction.
10. Make sure that maintenance plans are adequate and the contractor's procedure in monitoring the performance of control measures is specified. For example, it should

be clearly specified whether the general contractor, subcontractor, or construction manager is to do the inspection and maintenance.

11. Note any proposed borrow or waste areas and proposed measures for controlling erosion and sedimentation there.
12. Watch for existing areas that may not be in compliance, such as old highways and abandoned railroad rights-of-way. Those parties responsible for the land disturbance are responsible for erosion control even if ownership of the property has changed.
13. Make a list of the specific items of the plan that you want to inspect closely when you get to the site. This list can speed your inspection and remind you to check certain important points.
14. Reviewing the erosion and sedimentation control plan should provide you with a solid grasp of the proposed project. From the review you can identify parts of the erosion control system that may need to be strengthened and parts that should be watched carefully to see if the performance requirement is met. Your experience in the field and in the geographical area will provide valuable assistance in the approval or revision of the submitted plan.
15. Inspectors must also be familiar with the construction plans. Study these plans; identify and highlight sensitive areas, BMP placement and details, and other items of concern.

The ability to read aerial photos is important because some construction projects now use aerial photos on which to draw the construction plans. It will take some practice to be able to recognize ordinary objects from the air.

Many experienced people have found that aerial photos and topographic maps can help greatly in determining the effects of a project on the surrounding area. Aerial photos can be obtained from the Florida Department of Transportation (FDOT). The 1:660 Scale is usually used. The United States Geological Survey (USGS) is a good source for topographic maps. These maps are drawn on a scale of 1:24,000.

Reviewing the construction plan provides information needed for the next step of the inspection process, the preconstruction conference. Use the suggestions below to ensure that you are fully prepared for the conference.

Preconstruction conference

A preconstruction conference is one of the most valuable vehicles by which you can address and divert many potential erosion and sedimentation problems before they become catastrophes. This conference provides an opportunity for you to meet face-to-face with the responsible party and the contractor. In this way, you can establish the expectations for the project and start a good working relationship with the job superintendent. While holding the conference, keep the following suggestions in mind:

1. Clarify the objectives of erosion and sediment control and inform all parties about the specific requirements for compliance in this project. Also, discuss the inspection procedures and establish communications and scheduling so that everyone knows what will be happening during the project.
2. Designate a contact person for communicating concerns about erosion control. This will make future contacts much easier.
3. Be sure that all parties review a copy of the approved erosion and sediment control plan so that they know what is expected, and are prepared to carry out the plan.
4. Inform the responsible party and the contractor that the program is performance oriented and that the plan may need to be changed during the course of construction. Inform all parties about procedures for changing the plans.
5. Try to hold the conference on the site. There, the group can walk the site and compare the plans to see if the measures are appropriate, are located properly, and can be maintained once installed. Determine areas where sediment from the sediment traps and basins can be placed and stabilized when the devices are cleaned. The site is also the best place to determine if adequate access will be available to maintain the erosion control measures.
6. Discuss the schedule of clearing and grading. Emphasize that sediment control measures should be installed before the actual grading begins in order to capture sediment as it is generated. Be sure that the schedule allows for stabilizing surfaces with temporary and permanent measures during and between phases of grading and construction.
7. Discuss the maintenance requirements so that the responsible party and the contractor know who is responsible for inspecting, cleaning and repairing the measures. Regular inspection and maintenance may need to be supplemented with extra work if there is a forecast of a large storm, or to clean up after a large storm.
8. Establish open communications at the preconstruction conference; this provides a good foundation for your relationship with the responsible parties during the project.

Before you leave the office

Take the time to review the plans thoroughly before you go to the site, even if you have already reviewed them when they were first submitted.

1. Outline your approach for each inspection. It is necessary to know in detail the erosion control system and why each measure is specified.
2. Always take a copy of the approved plans with you to the site for quick referral.
3. Always bring the project file and necessary reporting forms.

4. Always take equipment for measuring (level, tape measure, turbidity sampling kit, etc.) and documenting (camera, camcorder).
5. Be sure to have all necessary personal protection such as boots, sun and insect protection, rain gear, water, First Aid kit, radio, etc.

Inspecting the site

At the construction site, ask yourself the following five questions:

1. Does this project have an approved permit?
2. Is the erosion and sediment control system installed as shown on the approved plans?
3. Is erosion being controlled on the site?
4. Is sediment being contained on the site?
5. Is the potential for turbidity in adjacent streams minimized?

If the answer to ***all*** of these questions is YES, then the site is in compliance. File an inspection report stating that the site is in compliance and take field notes to support the inspection report. It is a good idea to keep track of the sites where the erosion and sedimentation control plans work well so that you can show others examples of good sites.

If the answer to ***any*** of the above questions is NO, then the site is not in compliance. File an inspection report listing the items that are not in compliance. Your field notes should describe precisely the noncompliance and its location. Remember that others may need to use your field notes, so make them readable and understandable. The following points will help you in checking for compliance.

1. Carry a set of the approved plans to the site for your reference. They are necessary to determine what measures make up the erosion control system and how they are to be installed and maintained.
2. Take detailed, orderly field notes as you do the inspection. Eventually, this procedure will save you time and possibly a second trip to the site. Be sure that your notes are neat, concise and complete. (Remember, your notes may be needed as evidence in court.)
3. Check in with the job superintendent when you arrive so that the contractor knows who you are and what you are doing. When possible, schedule appointments so that the contractor and other responsible parties know when to expect you.
4. Walk the perimeter of the site on your first inspection. This procedure will give you a good idea of the terrain and will alert you to any problems occurring from off-site water and off-site sedimentation.

5. You may want to start your inspection from the lowest point of the perimeter and work your way upstream through the stormwater management system. This helps to make you aware of the amount of sediment leaving the site and can help you in locating its source.
6. If sediment is flowing off the site, go far enough downstream to see the extent of the damage. In these situations, it is very important to document the damage. Make an estimate of the sediment volume. Photos and videotapes make very good evidence. Be sure to write the time, date and other items in your notes and on the inspection report.
7. If turbidity is present in nearby waters, sampling of the stream upstream and downstream of the discharge point can provide the best possible evidence that the site is in or out of compliance.
8. Bring necessary tools to measure the devices and disturbed areas in the field. Be sure that basins and traps are sized according to the plans; channels and diversions have the proper grade, and contributing areas for the control devices are no larger than those used in the design.
9. Pay particular attention to the maintenance of erosion and sediment control measures. All measures require regular maintenance and may require special attention after severe storms.
10. Keep in mind that when certain structural measures fail from improper installation or maintenance, more off-site sediment damage may occur than if the device had not been installed.
11. Always fill out an inspection report for each trip to a site while you are still at the site. The pertinent inspection points are still fresh in your mind and you can easily recheck items that may be in question.

Causes of noncompliance

When you find a site that is not in compliance, it is important to determine why. By determining the cause(s), solutions become more apparent. Problems of erosion and sediment control on sites fall into three categories:

1. The responsible party has not made efforts to comply with the rule.
2. There are design errors in the erosion control system or the site conditions have changed.
3. The installation or maintenance of a measure is faulty or inadequate.

1. Little or No Effort to Comply

Noncompliance in the first category is easy to spot. The responsible party may believe that the project does not come under the jurisdiction of the rule or may intentionally disregard

the provisions of the rule. Quite often these sites are found by inspectors while driving by. Therefore, be observant in your territory.

Once you have found a noncomplying site, inform the responsible party that compliance is mandatory by Rule. On the inspection report, note that the responsible party has been informed of the law and list the items that are not in compliance. Appropriate enforcement action should then be taken. These are some of the causes of noncompliance within this category:

1. Not submitting a plan
2. Failing to follow the approved plan.

2. Inadequate Design or Changes in Site Conditions

Violations and failures may occur because the design was inadequate or the site conditions have changed since the plan was prepared. In this event the plan needs to be revised and approved. The inspection report should note all items of noncompliance and the need for a revised plan.

Compare the original design in the plan to conditions in the field. Look for changes in the site, conditions and construction plan. Ask yourself the following questions when checking for violations caused by design errors and changes.

1. Are the planned measures retaining the sediment on the site?
2. Are there modifications to the plan?
3. Are ground covers adequate for the slope and orientation of the areas to be protected? Is the slope too steep for the ground cover chosen?
4. Is the perimeter protected, given the conditions at the site?
5. Have the contributing drainage areas changed significantly, thereby potentially overloading the control measures? Are additional control measures needed?
6. Is the planned and ongoing maintenance adequate for the existing conditions?

Again, appropriate enforcement action should be taken.

3. Faulty Installation and/or Poor Maintenance

Most noncompliance occurs because measures were not installed correctly or maintained properly, or both. Determining the reasons why the measures are failing requires technical knowledge about the devices and how to construct them properly.

In the following three sections, you will find ideas on how to inspect erosion control devices

and stormwater management systems, and what to look for in their construction. Section 8.3 presents information on inspecting erosion control practices, Section 8.4 discusses inspection of stormwater management systems during construction, and Section 8.5 presents information on inspecting vegetation used for erosion control.

8.3 INSPECTING EROSION AND SEDIMENT CONTROL PRACTICES

INSPECTING INDIVIDUAL PRACTICES

The effectiveness of an erosion and sediment control system depends on the design, installation, and maintenance of the individual practices. It is only when all three efforts have been done properly that the system will function to prevent accelerated erosion and off site sedimentation.

Each practice has specific requirements to function properly. Inspectors must be familiar with these requirements to ensure that each practice has been designed, installed and maintained properly. When you are inspecting a practice in the field, first check that the practice has been installed according to the design specifications on the approved plan. If the practice has been installed as shown on the plan, then check the appropriate section in this chapter for items that should be given special attention for each practice group.

Entrances and Exits

Erosion can be a special problem around all entrances and exits, access roads and construction roads. Erosion in these places can cause mudholes, gullies, muddy pavement, dust, and complaints from neighboring landowners. Construction roads, even temporary roads, need to be stabilized to prevent erosion. Look for the following while conducting your inspection.

1. Entrance and exit pads should be built with coarse gravel and stone that are sufficient to prevent tracking of sediment onto streets or other public rights-of-way and prevent the pad from sinking into the soil.
2. Sites with heavy clay soils may require the installation of a wash rack to control tracking of sediment onto roads.
3. On unstable or wet soil, the stone should be spread over a layer of geotextile fabric to keep the stone from being pressed into the soil.
4. Pads may need to be extended to be effective.
5. All runoff from construction roads should be diverted to sedimentation traps to retain sediments on the site.
6. Pads and roads must be maintained (adding more clean stone) to ensure proper functioning.
7. Public roads must be swept as required to keep them free of sediments and stone from the site.

Inlet Protection

Inlet protection prevents sediment from entering the storm drains and leaving the construction site. By using inlet protectors (excavated, fabric, gravel, block and gravel, or

prefabricated filter bags), the designers can make use of the storm drains to discharge storm waters during construction. Look for problem areas within each of these practices.

Excavated Drop-inlet Protectors

1. If sediment has filled the excavated pool around the inlet, the contributing area for the inlet may be too large or the inlet protection structure may not have been maintained properly.
2. The capacity of the excavation around the drop-inlet protectors must be adequate for the contributing area. Also, the excavated area should be frequently cleaned and maintained.

Fabric Drop-inlet Protectors

1. These structures frequently fail because the posts are not set against the inlet and the tops of the posts are not supported or braced to one another.
2. Water should fall directly into the inlet opening, not onto the unprotected soil around the inlet box.
3. The fabric must always be buried at the bottom to prevent undercutting and to provide structural strength. The fabric should be set a minimum of 12 inches (30 cm) in the soil, and the trench backfilled with compacted earth or crushed stone.
4. Drop-inlet protectors should be set low, no more than 1.5 feet high (45 cm), to allow water to flow over them without collapsing, and to prevent water from overflowing the pool behind the fabric, thus bypassing the storm inlet. In some cases a dike may be required to prevent bypassing.

Gravel and Block & Gravel Inlet Protectors

1. Gravel and block & gravel inlet protectors should be set low, no more than 2 feet (60 cm) high, to prevent water from overflowing the pool and bypassing the structures. The blocks must be set against the base of the inlet for support and to prevent erosion between the blocks and the inlet. A few blocks must be set on their sides to allow the pool to drain.
2. The stone used for the gravel inlet protector should be large enough that it will not wash into the inlet. The slope of the inside face of the gravel must not be too steep or the gravel will fall into the inlet. A few blocks must be set on their sides to allow the pool to drain.
3. The fine, "washed stone" must be on the outside face of the gravel inlet protector in order to slow the flow of the water through the larger stone. The fine stone does not filter the sediment from the water. Sediment drops out of the water because the velocity is reduced when the water is pooled behind the inlet protector.
4. Gravel and block and gravel inlet protectors require flat approaches with adequate

storage to allow sediment to settle.

5. A dike may be required on the low side of the pool to prevent runoff bypassing the protector.

Prefabricated Filter Bag (Siltsack)

1. Remove the grate and then remove the sack when sediments are within one foot of the grate. Proper use of heavy equipment will help avoid accident or injury.
2. The bag may be replaced, or it may be emptied, cleaned, and reused.

Sediment Traps and Barriers

Sediment traps, basins, and barriers are used to retain sediment on the site to protect streams, lakes, drainage systems, and adjacent property. These devices are used at the outlets of channels, diversions, and other runoff conveyance measures to allow sediment-filled water to pool and sediment to settle. These measures are often used as the last line of defense to stop sediment from leaving the site; therefore, inspect them closely.

Sediment Traps

1. The drainage area must be limited to 5 acres (2 ha) or less.
2. The size of the sediment pool must be adequate for the disturbed area.
3. The spillway of sediment traps must be large enough to carry the design flow. The crest of the spillway should be level to allow even distribution of flow.
4. Geotextile fabric (filter cloth) must be installed under the outlet section to prevent undercutting.
5. The slopes of the inside and outside faces of the outlet section must not be greater than 2:1 to prevent stone from washing away.
6. The earth dike forming the basin must be compacted to prevent it from failing when pool is full. The height and top width must be adequate to hold the water in the pool.
7. The dike must be higher than the outlet weir section or the water will wash out the dike at its lowest point.
8. Sediment traps should be cleaned when the sediment is one-half the design depth to maintain adequate storage volume.

Sediment Basins

1. The size of the sediment basin must be adequate for the disturbed area. Limit the

drainage area to 100 acres (40 ha).

2. Sediment basins require special attention because their large size makes them very hazardous if they fail. Thus, it is important that sediment basins are carefully constructed to follow the dimensions, grades, elevations, pipe sizes, emergency spillway sections and other specifications as shown on the approved plans.
3. The conduit must be installed and function properly. The conduit joints must be watertight and must have anti-seep collars to prevent piping along the conduit.
4. Anti-flotation weights must be used to prevent conduit movement.
5. The soil in the embankment must be compacted to prevent piping. Hand tamping is necessary around the conduit.
6. Trash racks can cause failures if they are improperly designed. They should catch large debris to prevent the conduit from being clogged but should not have such fine openings that they become clogged with leaves and cause water to overtop the embankment.
7. There should be at least 1 foot (30 cm) of freeboard above the emergency spillway flow depth to prevent overtopping of the embankment.
8. The emergency spillway should be large enough to carry a 25 year, 24 hour storm flow safely without eroding. It should be constructed in undisturbed soil and properly stabilized.
9. Large basins must be accessible to allow frequent cleaning. The sediment removed from the basins should be placed where it will not be lost off-site.

Perimeter Controls (silt fences and straw bales)

1. Silt fences fail because they are improperly designed, installed, or maintained. Silt fences must be buried at least 8 inches (20 cm) and backfilled with compacted soil or stone to prevent undercutting. These fences must be adequately supported to prevent collapse from the pressure of the water and accumulated sediment.
2. Silt fences should never be placed across streams, conveyances, or areas of concentrated flow. The flowing water will collapse or undermine the fence.
3. Silt fences cannot withstand flows from large areas or steep slopes. The size of the contributing area must be limited to 1 acre per 100 feet (0.4 ha per 30 m) of fence.
4. Sediment fences require frequent maintenance. The accumulated sediment should be removed often.

Stream Crossings

Stream crossings must be specifically addressed and allowed by the permit. Inspect stream crossings carefully because any sediment will enter the stream directly.

1. Debris and construction material should be removed from the stream to prevent water cutting around culverts and bridge abutments.
2. Culverts cause additional soil disturbance when they are installed or removed. Provisions should be made to reduce sedimentation in the stream during installation and removal of culverts.
3. Fords should be used only for shallow or intermittent streams. Use geotextile fabric covered with properly sized stone to prevent the stone from being carried downstream.
4. Bridges cause the least disturbance to the stream and should be used where practical.
5. Banks should not be filled to shorten the length of bridge required. Fills restrict the stream channel and can easily wash out.
6. Approaches to stream crossings should be stabilized and should have diversions to prevent runoff from entering the stream.

Buffer Zones

The use of buffer zones to protect streams, lakes, and other bodies of water is always recommended and frequently required. Check for the following points when buffer zones are required on a site.

1. Buffer zones along water bodies must be wide enough to stop all visible sediment in the first one-fourth of the buffer nearest the construction work.
2. Avoid the use of in-stream controls such as check dams, weirs and the like.

Maintenance

Maintenance of erosion control devices is frequently overlooked on many construction sites. It is one of the most critical points in preventing accelerated erosion and off-site sedimentation.

1. The responsible party should provide for continued inspection and maintenance of erosion control practices. Maintenance for a disturbed site should be planned to continue through the life of the project.
2. All devices in the erosion and sediment control system should be inspected regularly (especially after storms). The erosion control plan should specify regular inspections and proper maintenance, such as cleaning and repairs, for each

practice.

3. Sediment traps and basins should be cleaned when the settling pools are half full.
4. Contractors frequently run over diversions with heavy equipment, breaking down the dike and allowing overtopping. If the contractor must drive over the diversion, it should be stabilized with gravel and built up to the design elevation above the channel.
5. Silt fences should be repaired immediately if they are damaged.

Remember that the regulations are performance-oriented. Even if practices are installed on a site according to the approved plan, the site is only in compliance where erosion and sediment are effectively controlled.

8.4 INSPECTING STORMWATER SYSTEMS DURING CONSTRUCTION

No stormwater management system can function properly unless it has been properly designed and constructed. A review of the design should be conducted under the supervision of a Florida registered professional engineer. The responsibility of insuring proper construction falls upon the inspector. While some inspectors operate from a regulatory prospective, many public and most private inspectors function as "the owner's representative". Their job is to make sure that the owners, public or private, get the quality facilities that they pay for. Improper construction of a single element of the system will cause premature failure and/or increased maintenance. This expense will initially, and often finally, be borne by the owner.

The following items highlight important issues in the construction of stormwater management systems.

Stormwater Impoundments (Ponds)

Stormwater management ponds are the largest component of a stormwater system. Both water quality treatment and flood control are achieved in these impoundments. Due to the volume of water contained in ponds, failure can cause considerable damage. Carefully examine the following when inspecting ponds under construction.

1. Does the construction comply with local material and equipment requirements for earthwork, concrete, other masonry, reinforcing steel, pipe, water gates, metal, and woodwork? Look for defects such as broken bells and spigots on concrete pipe, dented metal pipe, chipped coatings, improper aggregated or fill material, etc.. Is appropriate compaction equipment, including small tampers, on hand? What is the dewatering method, discharge, volume, and frequency?
2. Has the subgrade been stripped of topsoil, vegetation, organic debris, and large rocks? Are all fills compacted to specifications? Is the cut-off trench to dimensions and properly backfilled?
3. A major cause of detention system failure is water traveling along the outside of the principal spillway. This is called piping, and it generally occurs along a corrugated metal or concrete pipe. Is the method of installation on the plans? Is the trench bottom compacted, uniformly smooth, and dry? Are pipe cradles and anti-seep collars in proper location, and of specified dimensions and materials? Is the riser in proper location, and of specified dimensions and materials? Are all connections water-tight? Is backfill around structures and pipes accomplished with small tampers and rollers in 8 inch (20 cm) maximum lifts? Retention basins operate purely by infiltration and evaporation, and generally do not have a principle spillway
4. The reason most stormwater embankment ponds remain stable is that the mass of earth in the embankment is heavy enough to prevent slippage of material caused by water pressure on the upstream slope. Steep side slopes are not only more dangerous to the general public, but they also reduce the total mass of earth material in the embankment. This can increase the potential for embankment failure. Are interior side slopes no steeper than 4-to-1 and exterior side slopes no

- steeper than 3-to-1? Has proper compaction been achieved according to visual inspection, and according to engineering testing?
5. Use a Locke hand level (Locke level) or surveyor's level and rod to check elevations in and around the impoundment. Is the floor at the design elevation? Check grading on any "benches" or shallow littoral slopes. Are inlet and outlet elevations in proper relation to the pond bottom, the embankment top, and the emergency spillway? If a retention basin, has the floor been excavated with light weight or low ground pressure equipment? Has the retention basin floor been disced or plowed to a depth of one foot?
 6. Is the emergency spillway constructed on a cut or properly compacted fill? Is the emergency spillway in the proper location and built to approved dimensions? Are elevations and grades as shown on the plans?
 7. Are all pretreatment forebays, sediment traps, stilling basins, etc. built according to plan?
 8. Are all inlets to the pond provided with energy dissipators? Are the outlets from the principle and emergency spillways provided with energy dissipators? Do outlets discharge to stabilized areas or flowpaths?
 9. Are all vegetated areas topsoiled and mulched? Is the seed and/or plant selection effective? Is all vegetation warranted for one or two years? Are all non-vegetated surfaces covered with properly installed impervious or semi-pervious materials? Are those in the right place? Are dimensions and materials per plan?
 10. Impoundments are generally located in the lowest area of the site. Look for sediment accumulation in or approaching the pond. While this does not indicate a defect in the pond, it will adversely affect the performance of the pond. Trace the sediments back to their source, and notify the contractor to fix the problem.

Underdrains and Filters

Stormwater underdrain and filtration systems are used in stormwater management facilities to provide treatment where natural soils or high ground water restrict percolation. They usually consist of a system of perforated pipes surrounded by gravel and/or filter fabric. The following installation issues are important for the system to perform as designed:

1. Filters may be installed at the toe of the inside embankment slope (i.e. in-bank filter), they may be trenched into the basin floor, or they may be mounded on top of the basin floor. Regardless of location, is the bed for the pipe uniformly smooth in either undisturbed or properly compacted soil?
2. Examine the materials to be used. Is the geotextile as specified? Is the aggregate of the specified size and composition, and is it washed? Are pipe materials, sizes, perforations and connections correct?
3. Underdrains are generally designed with minimal slope. Look down the length of

the pipe to spot high or low spots. Double check with a level.

4. Look at the pipe connections. Are there any gaps larger than 1/4 inch (3 mm)? Are the pipe ends capped or connected to clean-outs? Any pipe connections which will not be in gravel envelopes should be water-tight.
5. Where does the filter fabric belong? Some designs call for fabric wrapping the pipe (i.e. a "socked" pipe). Others call for a fabric envelope outside of the gravel.
6. Gravel is often installed in two operations: first a 3 inch (8 cm) bed is placed, then the pipe is installed, then the sides and top are backfilled with gravel. Is there a minimum of 3 inches (8 cm) of gravel all around the pipe? Has the gravel placement disturbed the pipe?
7. What happens next? Some designs call for filter cloth over the gravel. Others require filter cloth, topsoil, and sod.

Exfiltration Trenches

Exfiltration trenches are very vulnerable to clogging of filter fabric. Because they are built underground and then buried, they are difficult and expensive to repair. Do not begin trench construction until it is certain that sediment-laden runoff can be kept out of the trench. During construction, look for the following:

1. Is all contributing runoff diverted? If not, is runoff from a stabilized area? If not, is runoff filtered or allowed to settle?
2. Check the location and dimensions of the trench. Also, check distances to foundations, wells, septic systems. Know the location of any nearby underground utilities.
3. Excavation should be from above with a backhoe, wheel trencher, or ladder trencher. Heavy equipment should not enter the trench as this will cause compaction of the soil. Excavated soil should be hauled away or stockpiled at least 10 ft.(3 m) from the edge of the trench. If kept on site it should be protected from erosion by plastic. By day's end, is the trench protected from stockpile or roadway sediments?
4. When excavation is complete check dimensions again. Are there any roots or rocks which could puncture the filter fabric? Is dewatering required? If so, determine and record the water table elevation and compare with the approved plans.
5. Verify that filter fabric is as specified. Has fabric been installed without tears or gaps? Adjacent sheets should overlap 12" - 18" (30 - 45 cm) and overlap the top of the trench by 18" - 24" (45 - 60 cm).
6. The aggregate material should be inspected prior to placement to ensure that it is clean material and free of debris. The type and size of the material should be as specified on the approved plans.

7. Inspect the exfiltration pipe before placement. Is it of the specified material and size? Are the perforations of the approved size and spacing? Are there any defects or damage to pipes, joints, or connections? Is fabric required around the perforated pipe?
8. An observation well should be installed in the aggregate to allow future inspections to determine whether the facility is functioning as designed. The observation well should consist of a perforated PVC pipe, 4 to 8 inches (10 -20 cm) in diameter and have a foot plate and a cap. The footplate will prevent the entire observation well from lifting up when the cap is removed during future inspections.
9. When course aggregate backfill is complete, it may be covered with filter fabric or plastic, as specified. Is fine aggregate or ordinary fill placed over the rock and fabric? What are the compaction requirements and procedures prior to final roadway pavement?
10. Maintain sediment controls and good housekeeping through project completion.

Infiltration Paving (Porous Pavement, Concrete Grid, Modular Paving, Grid Confinement Systems)

Infiltration paving refers to road and parking lot surfaces whose design allows for stormwater runoff to travel through the surface into the ground. These practices consist primarily of a "reservoir" layer of course aggregate, underlaid by a geotextile and covered with a hard yet pervious surface. The fabric keeps the aggregate separated from the subgrade soil and the hard surface keeps the aggregate in place and protects it from compaction. The geotextile and the hard surface work together to provide the structural support for vehicular traffic. While the concepts are quite simple, installation is very sensitive to workmanship and housekeeping. During construction, look at the following:

1. To help preserve the natural infiltration rate of the subgrade soils prior to excavation, the infiltration paving area should not be excessively traveled by heavy construction equipment that causes excessive compaction of soil pores. Has the area been marked off and traffic kept off it to the greatest extent possible? Are dimensions and location as per plan?
2. The area of the paving should be carefully excavated to prevent excessive compaction of the soils during the subgrade preparation. Has grading been carried out using low ground pressure equipment?
3. Once the subgrade has been reached, filter fabric should be placed. Is the fabric as specified? Are adjacent sheets overlapped 12" - 18" (30 - 45 cm)? Look for tears or gaps in the fabric. Check the type, size, and spacing of staples or pegs. What details are shown along the perimeter?
4. Once the fabric has been placed, the reservoir course is placed to the design depth. Is the aggregate clean, washed stone having a void ratio between 30 and 40%? The reservoir course should be laid in 12" (30 cm) maximum lifts and lightly compacted. Has the aggregate been uniformly spread?

5. In grid confinement systems, the HDPE grid is placed directly on top of the geotextile. The open cells of the grid are then filled with aggregate or soil. The filled cells will then support the weight of equipment. Have any cells been crushed prior to filling? Some of the modular paving systems are also placed directly on the geotextile and then filled.
6. Porous pavement and some modular paving systems use the reservoir layer of course aggregate. This is then covered with a two inch (5 cm) granular filter layer of washed 1/2" (13 mm) gravel. Is this layer also uniformly smooth and lightly compacted?
7. Modular pavers are laid on the granular filter layer. Open face types are then filled with aggregates or soil.
8. Pervious concrete is poured on the granular filter layer. The pouring temperature and the mix (% coarse and fine aggregates, cement, and water) should be consistent with those recommended in the specifications prepared by a Florida registered professional engineer. The engineer or designate should be present during placement. Samples of the concrete should be taken from each truck for immediate and future analysis.
9. Test the final product by pouring several gallons of water in different locations and recording the results.
10. As with all filtration and infiltration BMPs, infiltration paving systems are very sensitive to clogging. Sediment control must be maintained before, during, and after construction. All contributing areas must be stabilized in order to attain a reasonable service life.

Swales

Swales use infiltration as their primary means of reducing stormwater pollutants and total volume. They are considered as a subset of biofilters since vegetative filtration is also important. While biofiltration swales and filters rely on passage of water through vegetation for pollutant reduction, infiltration swales have designed blockages, such as swale blocks or check dams, which ponds water and induces infiltration. In both situations, slopes must be very gradual to increase residence time and reduce flow velocities. Examine the following when inspecting the construction of infiltration swales:

1. To help preserve the natural infiltration rate of the subgrade soils prior to excavation, the infiltration swale area should not be excessively traveled by heavy construction equipment that causes excessive compaction of soil pores. The area should be marked off and traffic kept off the area to the greatest extent possible. This is especially important at residential construction sites where individual residential contractors enter building sites with numerous trucks. The driveway areas should be the access points for contractors.
2. Has runoff been diverted to allow construction of the swale and establishment of vegetation?

3. Is excavation performed with light weight or low ground pressure equipment? Are all roots, rocks, and unsuitable soils removed?
4. Are excavated materials removed, stockpiled and covered, used for fill, or otherwise stored where sediments will not migrate back into the swale?
5. Check the dimensions, location, and grade of the initial excavation.
6. Are swale blocks required? How many, what size and what spacing? What materials are used? Are they properly compacted? Are they covered with sod, gravel, or erosion control blankets or nets?
7. Examine the proposed swale lining. Will topsoil, mulch, or sod decrease the cross-sectional area below the approved design? Is there a stone or riprap center drain which would reduce capacity? Recheck the dimensions after the lining has been installed.
8. Reinspect after several weeks for vegetative establishment. Look for accumulated sediments and trace back to their source. Maintain traffic control and restrict crossings to driveway locations. Monitor standing water to verify volume recovery within 72 hours.

Runoff Control Diversions

Diversions (dikes and channels) should be constructed as shown on the approved plans or failure of these measures is likely to occur. The most important factors in installing a diversion are its size, the grade, the elevation of the dike above the channel, compaction of the dike, and stabilization of the channel. To help assure compliance, the following should be evaluated:

1. A dike and its channel must be on the proper grade to ensure that the water flows in the desired direction. ***Watch for abrupt changes or reversal of grade on diversions -- overflows and failures occur in these places.***
2. Dikes must be large enough to meet the design water flow with 6 inches (15 cm) of freeboard. Be sure that they are sufficiently wide at the top, a minimum of 2 feet (60 cm) and the side slopes are 2:1 or flatter.
3. Dikes must always be compacted because loose soil will wash out.
4. Channels must have a large enough flow area to carry the expected volume of water.
5. Channels on steep grades must be lined to withstand the expected water velocity.
6. Diversions should generally parallel the site contours.
7. Diversions must be maintained routinely for proper performance, with special attention after severe storms.

Runoff Conveyance - Channels, Conveyance Swales, Slope Drains, and Flumes

Runoff must be controlled to ensure that it will not cause accelerated erosion or off-site sedimentation. Channels, swales, slope drains, and flumes must carefully follow the design specifications. Check these key points as you conduct your inspection.

1. Vegetated channels require protection until the vegetation is fully established. Well-anchored sod, mulch, mats, or netting should be used. Water should not be allowed into the system until it is stabilized.
2. Make sure that the flow cross-section is not reduced when riprap is used to line a channel. The channel excavation must be increased (or overcut) to compensate for the thickness of the riprap.
3. Look to see that channels lined with riprap have a layer of geotextile fabric (filter cloth) under the riprap. Also, the riprap should be inlaid into the channel bank to a depth of 1.5 times the d_{max} size of the riprap and set into the soil surface to prevent undercutting.
5. Inspect outlets of all runoff conveyances to ensure proper outlet protection.
6. Be sure that the slope drains have watertight joints in the pipe and that the pipe is well anchored to prevent movement.
7. Slope drains frequently fail because the water "pipes" around the inlet to the pipe. Check to see that the soil at the inlet is compacted to prevent piping. Anti-seep collars are also effective in controlling piping.
8. Flumes have steep slopes and carry water at very high velocities. Check that the outlets are stabilized to prevent erosion and that the inlets are designed to prevent water from washing around or under the chute.
9. Determine if the flumes have subdrains, necessary to prevent hydrostatic uplift.
10. Bends in flumes are difficult to design and build and should be avoided. Check any bends in a chute for signs of overtopping or erosion.
11. Gullies in the channel bottom mean that the velocities are too high. In this case, the channel must be redesigned by either lining the channel to withstand the flow velocities, changing the grade, or altering the channel cross-section to lower the velocity.
12. Sloughing from the channel sides indicates stability problems. Causes of sloughing include a high water table, unstable soils, channel banks that are too steep, or water velocities that are too high.
13. Overbank erosion, or flooding, may result from debris and sediment accumulation. The damaged areas should be rebuilt and the channel restabilized according to plan specifications.

14. Sediment below the channel outlet indicates that erosion is occurring either in the channel or its watershed. The problem should be located and corrected.

Outlet Protection

Outlet protection is used to reduce high velocity flows from channels, culverts, pipes, and other high velocity structures. Concrete stilling basins may be required for outlets that have overfalls or where a riprap apron would be too long. Check the following points of outlet protection practices:

1. The installation of riprap is often problematic for outlet stabilization structures. The riprap should be inlaid into the soil to a depth of 1.5 ft. (45 cm) times the d_{max} size and have a layer of geotextile fabric under the stone.
2. The finished structure should be large enough to handle the full volume that the outlet was designed to carry. The cross-sectional flow area can be seriously reduced if no compensation is made for the thickness of the riprap.
3. The riprap should extend far enough downstream to reach a stable section of the stream. The purpose of the stabilization structure is to dissipate the energy of the water and slow water movement to keep the channel from eroding.
4. The apron of the outlet structure must be level to prevent the water from undercutting the downstream edge of the apron.
5. Level spreaders must be constructed on undisturbed soil; no fill is allowed (the fill will settle and the lip no longer will be level). Also, the lip must be level if the spreader is to work.
6. The natural discharge area of the level spreader should handle the flow without eroding and not reconcentrate the flow (which will cause rills or gullies).

Ground Covers (Surface Stabilization)

Types of ground cover can be divided into three groups:

1. Hard surfaces
2. Semi-hard surfaces
3. Soft (vegetative) covers

This section provides some ideas on what to look for when you are inspecting a site using ground cover for erosion control.

1. Hard Surfaces

Hard surfaces are those that include pavement, concrete, and revetment. Some of these surfaces can be cast in place using wooden or fabric forms, or they can be installed in

large mats.

1. Look for proper hydrostatic pressure relief for solid slabs or liners.
2. Make sure that liners on channel slopes extend far enough up or away from the water to prevent water from undercutting, overtopping, or bypassing the liners.
3. Be certain that proper vegetation is planted in the hollows of the surface. Also, the soil filling the hollows should be well prepared to provide the best growing conditions for the plants.
4. Watch for accelerated erosion and high water velocities at the toe and top of hard-surfaced slopes and at the outlets from hard surfaces.

2. Semi-hard Surfaces

Semi-hard surfaces include riprap, gabion mattresses, modular pavement, and grid confinement systems. These surfaces are often used to line channels and cover slopes.

1. Semi-hard surfaces can be washed away by high water velocities. Look for failure by washout, or look for filling of voids by smaller particles to indicate success.
2. Flexible channel liners should be placed to blend with surrounding land surface to ensure that water will flow into the channel without erosion, not along the side of the lining.
3. Check to see if the channel lining is installed according to the plan, has not decreased the cross-sectional area, and is performing properly (ie. stays in place).
4. Ensure that adequate flow area has been provided.
5. Semi-hard surfaces should have geotextile fabric or a crushed stone filter underneath to prevent washing of the fine soil particles.
6. Make sure that dust control is being practiced for areas covered with stone aggregates or gravel.

3. Soft Ground Covers

Soft ground covers (such as vegetative ground covers) are the most common and are used on moderate slopes not exposed to high water velocities. Mulches are sometimes used alone as ground cover but require frequent maintenance. In depth information for inspection is found in the following section, INSPECTING VEGETATION FOR USED FOR EROSION CONTROL - Section 8.5

This page left intentionally blank

8.5 INSPECTING VEGETATION USED FOR EROSION CONTROL

More area is protected from erosion with vegetation than with any other erosion control means. Knowing how to choose and establish the proper vegetation can prevent soil loss and sediment problems.

VEGETATION FOR EROSION CONTROL

Vegetative cover is the principal means used to stabilize soil surfaces. With the selection of the proper species and appropriate maintenance, vegetative cover provides inexpensive, long term protection with moderate maintenance. Construction projects present a wide range of conditions for vegetation. This section describes what to look for when vegetation is used for erosion control.

A vegetative plan is one of the keys to a well-executed project. An effective plan specifies the appropriate plants for each disturbed area, describes proper soil preparation methods and indicates when and where to plant. Vegetation should be established as soon as possible after grading. Planting should be coordinated with construction so that areas do not remain uncovered, thereby reducing unnecessary amounts of runoff and sediment.

Consider the Site and Its Intended Uses

Vegetation works well only if the selected plant species is suitable for the climate, the soil, and the intended use for the area. Remember that at certain times of the year or under special conditions it may be necessary to use temporary vegetation before establishing permanent vegetation. Ask these questions when you inspect sites using vegetation for erosion control.

1. *Is the plant type appropriate for the soil and the slope?*

Plants must have fertile, well-prepared soils to grow properly, a requirement rarely met on a graded slope. Heavy, dense subsoils may be too infertile to support certain plants. Graded slopes may be too steep or too rocky to prepare adequate seedbeds. Steep slopes may need to be sodded or covered with riprap or concrete.

2. *Is the plant properly chosen, given the climate and orientation of the area?*

It is very important that the right plant be placed in the right location for the most effective use. Guidance is provided by the NRCS, FDEP, your regional Water Management District, or a qualified nurseryman.

3. *Is the vegetated area being maintained?*

Frequently the degree of maintenance required to keep a certain type of plant growing is overlooked. The responsible party must provide higher maintenance for some ornamental shrubs and grasses. Also, check that the maintenance crews can reach the planted area to provide the necessary care.

4. *Is the area subject to high velocity flow?*

Some areas, such as channels and steep slopes, may require sod, riprap, or concrete linings to prevent erosion.

5. *Is the area going to be occasionally inundated?*

This would have an effect on what should be planted and where.

Check Seedbed Preparation

Graded areas are usually compacted and have little topsoil when planting is started. If practical, the soil should be tested so that the proper amounts of lime and fertilizer can be added. Check the following to determine if the vegetation will be adequate.

1. Keep in mind the essentials for plant growth; an adequate supply of nutrients, water, and air in the root zone. Slopes that have been graded are often too compacted and smooth to establish plants. It is necessary to apply fertilizer and lime, prepare a proper seedbed, and roughen the surface to provide required nutrients and adequate rooting depth.
2. Fertilizer and lime must be added, and then incorporated to a depth of 4 or more inches (20 cm) by chiseling, plowing, or roto-tilling. This preparation also enhances water and air infiltration to the root zone.

Check for Proper Mulching

Seeded areas should be mulched to protect and help establish erosion control vegetation. Mulching holds the seed and fertilizer in place, protects the soil, and conserves moisture. Mulching also encourages rapid seed germination by preventing soil crusting and insulates the soil against rapid temperature changes. The following points will help you determine if mulching is adequate.

1. Look for a proper thickness of mulch. Few areas can develop a strong growth of vegetation without mulching, and mulches are often too thin to be of much help.
2. Mulch needs to be well-anchored to work properly. This requirement is often overlooked, causing many failures and much added expense for re-seeding. On flatter slopes, mulches can be tacked by spraying on tacking agents that bind the mulch, preventing it from being washed or blown away. Crimping also works well on flatter slopes and level areas.
3. For steeper slopes, mulches overlaid with netting or mats can be used. Netting and mats should be anchored with long staples at the proper spacing to provide the best resistance to washing. Thicker and more durable mats should be used on steep slopes, areas that are exposed to high-velocity flows, and areas where vegetation needs more help to become established.

Ensure Maintenance of Vegetative Cover

Maintenance is the key to adequate erosion control vegetative cover. The inspector must ensure that the vegetation is protected to allow the best germination and strongest growth.

Even after the vegetation has emerged, mulches and mats must be maintained to prevent washing during the next rain.

Watch for areas where the mulch is too light - the mulch can blow away or wash away in the next rain. The owner/developer must have new mulch applied and must anchor it to prevent washing.

Damage to seeded areas usually happens where the mulch is improperly anchored. These areas will require immediate repair. The responsible party should fill the eroded area if needed, apply new seed, lime, and fertilizer, and apply an adequate layer of well-anchored mulch. If the area is in a zone where the erosion potential is high or if the practice called for in the plans is inadequate, the responsible person may need to use a heavier mat to provide more protection for the vegetation.

Look for a means of access to the vegetated areas. The responsible party cannot provide maintenance if crews cannot get to the area. This is especially important for areas where high-maintenance ornamental shrubs and turfgrasses have been planted.

This page left intentionally blank

APPENDIX 8-A HUMAN RELATIONS

The hardest part of an inspector's job is dealing with people. You will be working with contractors, developers, neighbors, and concerned citizens. All have rights as citizens and as human beings.

To deal effectively with people, you must be fair and consistent. You must follow the rules governing erosion and sediment control, and you must apply them fairly. Fairness means treating all people with courtesy and respect. If you show respect for the other person, that person is more likely to show respect for you. It is important to be as consistent as possible. If you apply the rules consistently to every situation, the people you deal with will know what to expect from you and your agency.

Perhaps the most challenging part of being an inspector is carrying out your responsibilities in a professional manner. Sometimes you may feel pressured not to cite violations, but it is your job to make sure all rules are followed. The objective is to prevent accelerated erosion and off-site damage from sediment. To do this job well and be respected as a professional, you must maintain your integrity.

You will visit many construction sites, offices, and other agencies. For these visits, prepare a short introduction explaining who you are, what your job is, and why you are there. Give a business card to those you meet to help them remember your name and the role of your organization.

DEALING WITH ANGRY OR DIFFICULT PEOPLE

Individuals who have complaints frequently come to the inspector. Consequently, the inspector often has to handle heated confrontations.

When a person voices a complaint, you will not have time to prepare a response. Therefore, you must resolve the situation spontaneously. You can be prepared, however, by developing skills for dealing with conflict situations. The general guidelines in the following section will help in handling angry people.

Key Steps

A situation with an angry person should be handled in a manner that is satisfactory to the person, yourself and the organization you represent. Your organization relies on you to handle these situations effectively. Use these steps as a guide for developing your skills in dealing with angry people. You can tailor these skills to fit your own personality and style.

Step 1. Maintain a friendly and professional manner.

You are likely to be the first person an angry individual confronts. Be careful not to argue because it will only make the person become defensive and even more difficult.

- * Show an interest in the person's problem and express your desire to solve it.

- * Do not let the person's anger arouse your desire to retaliate. Handling a conflict situation diplomatically is your professional responsibility and can be rewarding.
- * Do not take what the individual says personally. Though the anger may be directed at you, the person is probably angry with your agency or regulations, or another agency, person, or rule. The individual probably feels that someone has treated him or her unfairly.

Step 2. Acknowledge that a difficult situation exists.

Show that you take the complaint seriously. It is important that you help the person maintain self esteem. The complaint must not be viewed as unimportant. The person would not be complaining if he or she did not consider the problem important.

- * Choose words and use a tone of voice that show sensitivity to the party's situation. The person wants to know that you understand the situation. An angry person does not want to hear (and probably is unable to hear) that he or she is wrong.
- * Express empathy by responding to what the person says and feels. Expressing empathy does not mean you agree with the individual. It means simply that you recognize and respond to what the person is experiencing.
- * If an apology is in order, apologize for the specific incident and no more.

Step 3. Calm the individual by questioning and verifying.

By asking questions you can verify your understanding of the situation and also demonstrate that you are willing to work with the person. This also helps the person to work with you.

- * Ask questions to get specific information about the problem. Never assume that you understand.
- * Give the person responses to show that you understand the problem.
- * Be sure that you and the person fully understand the problem.

Step 4. Involve the person in solving the problem.

The next step is to get the person to cooperate in exploring alternate solutions. Show that you are interested in solving the problem. By discussing all alternatives and the consequences of each solution, you can keep the party focused on the problem and thereby avoid side issues.

- * Ask the person to help you solve the problem. Request suggestions for solving the problem, and offer your assistance to help correct the situation. Your knowledge

of erosion and sediment control can guide the party to a reasonable and legal solution.

- * Explain the applicable regulation and the reasoning behind it. Often frustration and adversity are reduced when citizens are made aware of the intent of the rules.
- * Continue to ask questions in order to keep the person focused on solving the problem. If the individual is still angry, continue to empathize, showing that you understand the problem.

Step 5. Handle the problem

Having explored the possible solutions, focus on the most feasible and satisfying solution. Be positive with the person. Explain what you are going to do in a way that the person understands.

- * If he resists, go on to another alternative. Be as helpful as you can. Satisfying the person's desire for service and special attention can sometimes turn an opponent into an advocate.
- * Decide upon a follow-up action to ensure that the problem has been resolved satisfactorily.

BEING THE BEARER OF BAD NEWS

There will be times when you will have to be the bearer of bad news. You may have to tell a person that you cannot solve a complaint to his or her satisfaction, or you may have to inform a responsible party of a violation. These situations can be very stressful for both you and the other person. The following section lists key steps that will help prepare you to deliver bad news.

Key Steps

Step 1. Present the situation.

Explain the situation to the person with as few words as possible. When your discussion is concise, direct, and to the point, the person is spared the anxiety of wondering how bad the news is.

- * Prepare the person for the negative information. It may be necessary to provide a short background about the events leading up to the present situation.
- * Provide reasons why the situation has occurred. You may be able to show that the person's actions were not responsible for the situation.
- * Do not try to give the person good news first and then the bad news--this can appear patronizing.
- * Do not make the bad news seem insignificant; it probably is not insignificant to the person involved.

Step 2. Allow the person time to adjust.

Most people need a little time to collect their thoughts and react emotionally to bad news. Allow the person some time, but try not to leave long periods of silence. Some people perceive silence as pressure to react and therefore may react inappropriately.

- * Try discussing the positive aspects of the situation. The person may or may not hear you, but positive comments can help keep the conversation constructive and the outlook optimistic.

Step 3. Accept the person's reaction.

Allow the person to express his or her feelings and opinions. It is normal to react emotionally to bad news. Allowing people to ventilate their emotions shows that you accept their feelings and helps to reduce the negative aspects of the situation.

- * If the person does not offer a reaction, try talking briefly about how you have felt or would feel in a similar situation. Then ask for the person's reaction. Use this technique to stress that you are empathetic to the other person's dilemma. However, do not get caught up in discussing your own troubles.

Step 4. Demonstrate acceptance of the person's reaction.

A person may react emotionally in many different ways and may not clearly express his or her feelings. By accepting their emotions you reaffirm them as valuable and important. Most of us find it hard to talk about emotions in the workplace, and we have trouble accurately identifying the emotions of others. You must observe and listen carefully to determine if the person's true feelings are being expressed.

- * When receiving bad news, the person may feel a wide range of emotions, such as anger, dissatisfaction, embarrassment, or confusion. Respond to these emotions by remaining calm, expressing empathy, offering reassurance, or providing further explanation.
- * Try to mentally identify or name the emotion that the person is feeling. Identifying the person's reaction allows you to accept the reaction for what it is -- that is, not a personal affront to you. Understanding how the other party feels also helps you anticipate upcoming statements and remain in control of your own emotions.
- * People often react by blaming another person, a group, or the system. The person is simply reacting from his anger -- try not to take it personally.
- * Avoid being caught in answering questions that are really meant as statements. For instance, "Don't you think this is unfair?" really means "I think this is unfair." Restate the question as "I understand that you think this is unfair."

- * Sometimes you may be able to use self-disclosure to diffuse the situation. In other words, state how you have felt in similar situations. Statements such as, "I know just how you feel," can be taken as patronizing. Rather, say, "I know how I've felt in situations like this."

Step 5. Restate positive points.

Once the initial emotional reaction has passed, help the person put the situation into perspective.

- * You can help the person see the situation more positively by expressing confidence in his or her ability to meet the challenge and by providing genuine praise for efforts put forth.
- * Reemphasize the basic facts about the situation and discuss any steps that can be taken to address the problem.

Step 6. Offer assistance.

If appropriate, you can offer to assist the person in future actions or planning.

- * Do not offer to do something that you are not authorized to do.
- * Inform the person that it may be necessary to submit revised plans and/or seek professional help.

Step 7. Clearly express that violations must be corrected.

An emotionally upset person may not be able to fully understand the situation or may intentionally misunderstand the conversation. Be sure that the person understands the information you have provided and knows what is expected to correct or address the situation.

- * Repeat the actions that must be taken by all parties, and the required time frames.
- * Discuss the required action. If you cannot change the requirements or time frames, tell the person that you regret that you cannot change them.
- * A good way to ensure that the person understands the information you have discussed is to ask the person to repeat the details of your discussion in his or her own words. For example, "I want to be sure I haven't said something that might be misunderstood. Would you tell me, in your own words, your understanding of this discussion?"

Step 8 Allow for future contact and follow-up.

Give the person a chance to contact you for further discussion. You may need to schedule a future meeting. You should always give the person your business card and phone numbers where you can be reached.

- * Confirm, in writing, the conclusions reached so that all parties have a similar basis for their understanding of the situation.

APPENDIX 8-B CONDUCT GUIDELINES AS A WITNESS

1. Before you testify, try to picture the scene, the objects there, the distances, and just what happened so that you can recall more accurately when you are asked. If the question is about distances or time, and your answer is only an estimate, be sure you say it is only an estimate.
2. A neat appearance and proper dress in court are important.
3. Avoid distracting mannerisms, such as chewing gum, while testifying. While taking the oath, stand upright, pay attention, and say "I do" clearly,
4. Don't try to memorize what you are going to say, because your testimony will not be as believable to the judge or jury if it is too "pat".
5. Be serious in the courtroom. Avoid laughing and talking about the case in the hallway or restrooms of the courthouse in such a way that a juror or defense witness or lawyer may see or overhear you.
6. Speak clearly and loudly enough so that the farthest juror can hear you easily. Remember to talk to the members of the jury, to look at the jurors and talk to them frankly and openly, as you would to any friend or neighbor.
7. Listen carefully to the questions asked of you. No matter how nice the attorney may seem on cross examination, he may be trying to hurt your testimony. Understand the question, have it repeated if necessary - then give a thoughtful, considered answer. Do not give a snap answer without thinking. You can't be rushed into answering (although, of course, it would look bad to take so much time on each question that the judge or jury would think you were making up an answer). Never answer a question you don't understand.
8. Explain your answer, if necessary. Give the answer in your own words, and if a question can't be truthfully answered with a "yes" or "no", you have a right to explain the answer.
9. Answer directly and simply only the question asked you, and then stop. Do not volunteer information not actually asked for.
10. If your answer was not correctly stated, correct it immediately. If your answer was not clear, clarify it immediately.
11. The judge and the jury are interested only in the facts. Therefore, don't give your conclusions and opinions.
12. Don't say "That's all of the conversation" or "Nothing else happened". Instead say, "That's all I recall", or "That's all I remember happening". It may be that after more thought or another question, you will remember something important .

13. Always be courteous, even if the lawyer questioning you may appear discourteous. Don't appear to be a cocky witness. This will lose you the respect of the judge and jury.
14. You are sworn to tell the truth. Tell it. Every material truth should be readily admitted, even if not to the advantage of the prosecution. Do not stop to figure out whether your answer will help or hurt your side. Just answer the questions to the best of your memory. Do not exaggerate.
15. Stop instantly when the judge interrupts you, or when an attorney objects to a question. Do not try to sneak your answer in.
16. Give positive, definite answers when at all possible. Avoid saying, "I think", "I believe", or "In my opinion", if you can be positive. If you do not know, say so. Don't make up an answer. You can be positive about important things, which you naturally would remember. If asked about little details which you would normally not remember, it is best just to say that you don't remember. But don't let the defense lawyer get you in a trap of answering question after question with "I don't know."
17. Try not to seem nervous. Avoid mannerisms which will make the judge or jury think you are scared, or not telling the truth or all that you know .
18. If you don't want to answer a question, don't ask the judge whether you must answer it. If it is an improper question, the Enforcement Attorney trying the case will take it up with the judge. Don't ask the judge for advice.
19. Don't look at the Enforcement Attorney or at the judge for help in answering a question. You are on your own. If the question is improper, the Enforcement Attorney will object. If the judge wants you to answer it, do so.
20. Do not "hedge" or argue with the defense attorney .
21. Do not nod your head for a "yes" or "no" answer. Speak so that the court reporter (or recording device) can hear the answer.
22. When you leave the witness stand after testifying, wear a confident expression, but don't smile or appear downcast.
23. Sometimes, not often, a defense attorney may ask a "trick question". For example, "Have you talked to anybody about this case?". If you say "No," the judge or jury knows that is incorrect because good prosecutors try to talk to witnesses before they take the stand. If you say, "Yes", the defense lawyer may try to infer that you have been told what to say. The best thing to do is to say very frankly that you have talked with whomever you have talked with -- Enforcement Attorney, victim, other witness, etc. -- and that you were just asked what the facts were. All that we want you to do is just to tell the truth as clearly as possible.

25. Above all -- this is most important -- **DO NOT LOOSE YOUR TEMPER**. Remember that some attorneys on cross examination will try to wear you out so you will lose your temper and say things that are not correct or that will hurt you or your testimony. **KEEP YOUR "COOL"**.

26. Now, go back and re-read these suggestions so you will have them firmly in your mind. We hope they will help. These aren't to be memorized. If you remember that you are just talking to some neighbors on the jury, you will get along just fine.

APPENDIX 8-C ESTIMATING QUANTITIES

Piles

Piles can often be conveniently measured by calculating the volume of regular masses of similar outline, and making plus or minus adjustments for differences. A pile of clean, dry sand may have a conical shape, or be a ridge with a triangular cross section, ending in half cones. Measurements should be taken to determine base size and height.

The area of the circular base of a cone is found approximately from the circumference by the formula:

$$\text{Area} = \frac{\text{Circumference}^2}{12.6}$$

and from half the diameter by:

$$\text{Area} = 3.14 \times \text{Radius}^2$$

The volume of a cone is the height times one third the base area. The long part of the pile is figured by the formula:

$$\text{Volume} = \frac{\text{Height} \times \text{Width} \times \text{Length}}{2}$$

A long pile will have the volume of the center section, plus the volume of one cone, as each of the ends is a half cone.

Excavated Pond

The volume of excavation required can be estimated with sufficient accuracy by use of the prismoidal formula:

$$V = \frac{(A + 4B + C)}{6} \times \frac{D}{27}, \text{ where:}$$

V = Volume of excavation, in cubic yards.

A = Area of the excavation at the ground surface, in square feet.

B = Area of the excavation at the mid-depth point (1/2 D), in square feet

C = Area of the excavation at the bottom of the pond, in square feet.

D = Average depth of the pond, in feet

27 = Factor converting cubic feet to cubic yards.

APPENDIX 8-D Sample Check Lists

The example checklists provided can be a basis for creating specific checklists tailored for the specific duties and conditions of each public or private concern.

GENERAL INFORMATION

Some or all of the following information should appear on all checklists:

Project name
Permit number
Property parcel number
Name of inspector / reviewer
Name of design professional
Weather; or date and amount of last rain event

WARNING !

The checklist is an excellent tool for organizing yourself for an inspection or plan review. Like any other tool, the checklist can and will hurt you if not used properly ! It is only a tool, not a substitute for the human mind. The checklist can lull you into a false sense of completeness and security. After using a checklist, ask yourself " Is there anything else?; anything which is not covered in the checklist? " Periodically examine your checklists to make sure that they cover the issues which you encounter and that they stay current with any changing regulations or other conditions.

This page left intentionally blank

1. Plan Review

Narrative

Project description A brief description of the nature and purpose of the land-disturbing activity and the amount of grading involved

Existing site conditions A description of the existing topography, vegetation, and drainage

Adjacent areas A description of neighboring areas, such as streams, lakes, residential areas, and roads that might be affected by the land disturbance

Soils A brief description of the soils on the site including erodibility and particle size distribution

Critical areas A description of areas within the developed site that have potential for serious erosion or sediment problems

Erosion and sediment control measures A description of the methods that will be used to control erosion and sediment on the site

Permanent stabilization A brief description of how the site will be stabilized after construction is completed

Maintenance A schedule of regular inspections and repairs of erosion and sediment control structures

Site Plan or Map

Vicinity Map A map which shows the project located within a larger region, including principle roads

North Arrow

Existing contours Existing elevation contours of the site at an interval sufficient to determine drainage patterns

Preliminary and final contours Proposed changes in the existing elevation contours for each stage of grading

Existing vegetation Locations of trees, shrubs, grass, and unique vegetation

Soils Boundaries of the different soil types within the proposed development

Critical areas Areas within or near the proposed development with potential for serious erosion or sediment problems

Existing and final drainage patterns A map showing the dividing lines and the direction of flow for the different drainage areas before and after development

Limits of clearing and grading A line showing the area to be disturbed

Erosion and sediment control measures Locations, names, and dimensions of the proposed temporary and permanent erosion and sediment control measures

Stormwater management system Location of permanent storm drain inlets, pipes, outlets, and other permanent stormwater management facilities (swales, waterways, etc.); and sizes of pipes, channels, and structures

Details

Detailed drawings Enlarged, dimensioned drawings of such key features as sediment basin risers, energy dissipators, and waterway cross sections

Seeding and mulching specifications Seeding dates, seeding, fertilizing, and mulching rates in pounds per acre (kilograms per hectare), and application procedures

Maintenance program Inspection schedule, spare materials needed, stockpile locations, and instructions for sediment removal and disposal and for repair of damaged structures

Calculations

Calculations and assumptions Data for design storm used to size pipes and channels, and sediment basins and traps; design particle size for sediment traps and basins; estimated trap efficiencies; basin discharge rates; size and strength characteristics for filter fabric, wire mesh, fence posts, etc.; and other calculations necessary to support stormwater, erosion, and sediment control systems

2. Pre-construction Conference

Verify the following

Permits Check that contractor / developer has all required permits, including, but not limited to: Federal, FDEP, FDOT, Water Management District, local or municipal, building permit if required.

Licenses Get the name, license number, and type of license for all contractors involved in site development.

Contacts Get the name, phone number, and mailing address of the property owner and all contractors involved in site development.

Special Conditions Check for special conditions attached to any permits. This could be one of the most crucial aspects of the permit.

Discuss the following

Plans and scope of work Be sure that the contractor understands the plans and the tasks to be performed.

Special Conditions Point out that any special conditions are as valid and enforceable as the permit itself, they are not optional. Make sure that everything is clearly understood. Write down any unresolved issues and follow up quickly.

Erosion and sediment controls Discuss the location, proper installation, and maintenance requirements of BMPs. Examine the erosion and sediment control details.

Buffers and natural areas must be protected Discuss the methods used to protect these areas. Be sure that they will not be used for parking, portable toilets, material storage, waste disposal, or other unintended uses.

Tree Protection Verify the location and type of protected trees which will remain. Discuss protection requirements and methods. Be sure that protected areas will not be used for parking, etc.

Construction sequencing The construction sequence will be enforced. Perimeter controls, sediment traps and basins, and necessary conveyances will be installed and stabilized **before** the rest of the site is cleared.

Performance oriented regulations Be sure that the contractor understands that the site will be out of compliance if erosion and sediment controls fail, even if everything has been done according to plan. In that event additional measures will be required.

Plan Changes No construction will be allowed which differs from the plans. Major changes to the erosion and sediment control plan, and any changes to the site development plan will require re-approval. Minor changes to the erosion and sediment control plan must be approved by the inspector.

Routine Inspections Advise the contractor that you will be monitoring this site for proper installation and diligent maintenance of BMPs

Final Inspection A final inspection will be performed when all permitted improvements have been completed. Inform the contractor about the documents which will be required at that time (ie. Operating permit, Post-construction certification, As-built drawings, etc.).

Penalties for non-compliance Save the best news for last.

Inspect the site

Walk or drive around the site with the contractor. Point out any potential problems on- or off-site. Tell the contractor what you will be looking for on your next inspections.

Affirmation

Provide the owner /contractor with a copy of your check list and make sure again that everything has been discussed and clearly understood. Note any clarifications, agreements, and unresolved issues. Sign and date all copies and have them do the same.

3. Routine Inspection - Maintenance Inspection

Control measure	Problems to look for	Possible remedies
Vegetation	Rills or gullies forming	Check for top-of-slope diversion and install if needed.
	Bare soil patches	Fill rills and regrade gullied slopes, revegetate.
	Sediment at toe of slope	Remove sediments, revegetate using site appropriate methods.
Dikes	Gully on slope below dike breach; wheel track or low spot in dike	Add soil to breaches or low spots and compact.
	Loose soil	Compact loose soil.
	Erosion of dike face	Line upslope face with riprap, or revegetate using site appropriate methods.
Swales	Gully on slope below swale	Repair breaches.
	Wheel track, low point (water ponded in swale)	Build up low areas with compacted soil or sandbags or rebuild swales w/ positive slope.
	Sediment or debris in channel	Remove obstructions.
	Erosion of unlined channel surface	Mulch and install anchored sod or erosion control blanket; or line swale w/ riprap; or install check dams; or realign swale on gentler gradient; or divert some or all stormwater to a more stable facility.
	Erosion of channel lining	Install larger riprap; or reseed, mulch, and anchor w/ netting; or install check dams; or pave swale
Pipe slope drain or flume	Blocked inlet or outlet	Remove sediment and debris.
	Runoff bypassing inlet	Enlarge headwall or flare out entrance section.
	Erosion at outlet	Enlarge riprap apron and use larger riprap; or convey runoff to a more stable outlet.

Grassed waterways	Bare areas	Revegetate w/ anchored sod or erosion control blanket; divert flow during establishment period.
	Channel capacity reduced by tall growth	Mow grass
Riprap lined waterway	Scour beneath stones	Install proper geotextile or graded bedding. Make sure edges of geotextile are buried.
	Dislodged stones	Replace w/ larger stones.
Outlet protection	Erosion below outlet	Enlarge riprap apron; or line receiving channel below outlet; or convey runoff directly to a more stable outlet. make sure discharge point is on level or nearly level grade.
	Outlet scour	Install proper geotextile or graded bedding beneath riprap apron.
	Dislodged stones	Replace w/ larger stones.
Sediment traps and basins	Sediment level near outlet elevation	In traps, remove sediment if less than 1 ft.(0.3 m) below outlet elevation; in basins, remove sediments if less than 2 ft.(0.6 m) below top of riser.
	Obstructed outlet	Remove debris from trash rack.
	Basin not dewatering between storms	Clear holes. Clean or replace sediment-choked gravel surrounding dewatering hole or subsurface drain.
	Damaged embankments	Rebuild and compact damaged areas.
	Spillway erosion	Line spillway w/ rock, geotextile, or pavement.
Sediment traps and basins (continued)	Outlet erosion	Make sure outlet is flush w/ ground and on level grade. Install, extend or repair riprap apron as required; or convey discharge directly to a more stable outlet.
	Riser flotation	Anchor riser in concrete footing.
	Excessive discharge to and	Check runoff patterns for

	from basin or trap	consistency w/ plans. Reroute part of volume to another basin or enlarge the basin.
	Sediment storage zone fills too quickly.	Increase size of basin; or stabilize more of the contributing area.
Straw bale barrier	Bale displacement	Anchor bales securely w/ proper stakes or rebar. Check drainage area, slope length and gradient behind each barrier.
	Undercutting of bales	Entrench bales to proper depth, backfill, and compact the soil.
	Gaps between bales	Restake bales. Drive first stake in each bale at an angle to force it snug against the adjacent bale.
	Baling wire broken	Retie bale or replace w/ fresh bale.
	Bale disintegrating	Replace w/ fresh bale.
	Runoff escaping around barrier	Extend barrier or reposition in center of flow path.
	Sediment level near top of bales	Remove sediment when level reaches half of barrier height.
Silt fence	Undercutting of fence	Entrench wire mesh and fabric to proper depth, backfill, and compact.
Silt fence (continued)	Fence collapsing	Check post size and spacing, gauge of wire mesh and fabric strength. Check drainage area, slope length and gradient behind barrier. Correct any substandard condition.
	Torn fabric	Replace w/ continuous piece of fabric from post to post, attach w/ proper staples.
	Runoff escaping around fence	Extend fence.
	Sediment level near top of fence	Remove sediment when level reaches half of fence height.
Check dam	Sediment accumulation	Remove sediment after each storm.

	Flow escaping around sides of check dam	Build up ends of dam and provide low center area for spillway.
	Displacement of sandbags, stones, or straw bales	Check drainage areas and peak flows. Reinforce dam w/ larger stones, etc.; or divert part of flow to another outlet.
Inlet protection	Flooding around or below inlet	Remove accumulated sediment; or convert sediment barrier to an excavated sediment trap; or reroute runoff to a more suitable area.
	Undercutting of bales or silt fence, bale displacement, torn fabric, etc.	See remedies for straw bale barriers and silt fences.

4. Final Inspection

General

Are all Final Inspection documents in order (As-Built drawings, Compliance Report, Post-construction Certification, Operating Permit, etc.)?
Are all applicable easements recorded with the Clerk of the Court?
Are the roads, buildings, parking, sidewalks, etc. as shown on plans?
Is there any significant change in impervious area?
Did natural or undisturbed areas remain that way?
Are all utilities installed (not necessarily hooked-up)?
Are there any outstanding violations or fees?
Is there any off-site disturbance or adverse impact from this project?

Stormwater Facilities

Is the stormwater management facility (pond or ponds) where it should be?
If the facility is underground, is there access for maintenance?
Is the facility the size and depth it should be?
Are the slopes as shown on plans and stabilized?
If applicable, is the stormwater facility fenced?
Are the control structures as shown and clean?
Is the filter system as shown and clean?
Are energy dissipators as shown and stabilized?
Is the pond bottom free of sediments?
Are aquatic plantings installed as shown and in good condition?
Does the facility meet minimum performance standards as permitted (treatment and volume recovery)?

Stormwater Conveyance

Is the conveyance system as shown and free of debris, stabilized?
Are all inlets as shown and clean?
Are roof drains as shown?
Is all water on site directed to ponds, except accessways?

Landscaping/Natural Areas

Are natural buffers existing and undisturbed?
If buffers were to be augmented, have they been?
Is uncomplimentary land use buffer, if applicable, as shown and planted or fenced to meet permit/code requirements?
Can buffer areas be accessed for maintenance?
Are landscape islands in parking areas as shown?
Is perimeter landscaping as shown?
Are all landscape areas protected by curbing, wheelstops, or other physical barrier?
Do all landscape areas have access to irrigation?
Do all plantings conform to the approved landscape schedule?
Are all seeded areas firmly established?
Is all sod firmly established, properly anchored?

REFERENCES

City of Jacksonville Water Quality Division. Erosion and Sediment Control Inspector's Guide. Jacksonville, FL

North Carolina Department of Environment, Health, and Natural Resources. State of North Carolina Erosion and Sediment Control Inspector's Guide. Raleigh, NC

Goldman, S.J, K. Jackson, and T.A. Bursztynsky. 1986 Erosion and Sediment Control Handbook. McGraw-Hill, Inc. New York, NY

Leon County Growth & Environmental Management. 1990 "Inspection Checklists"
Tallahassee, FL

GLOSSARY OF TERMS

The list of terms that follows is representative of those used by soil scientists, engineers, developers, conservationist planners, etc. The terms are not necessarily used in the text; nonetheless they are in common use in conservation matters. This glossary was compiled from definitions supplied by the Soil Conservation Service, Soil Conservation Society of America Resource Conservation Glossary, and other state, federal, and private publications.

Florida Erosion and Sediment Control Inspector's Manual

AASHTO CLASSIFICATION (soil engineering) -- the official classification of soil materials and soil aggregate mixtures for highway construction used by the American Association of State Highway Transportation Officials.

ACID SOIL -- A soil with preponderance of hydrogen ions, and probably of aluminum in proportion to hydroxyl ions. Specifically, soil with a pH value less than 7.0. For most practical purposes, a soil with a pH value less than 6.6. The pH values obtained vary greatly with the method used; consequently, there is no unanimous agreement on what constitutes an acid soil. The term is usually applied to the surface layer or to the root zone unless specified otherwise.

ACRE-FOOT -- the volume of water that will cover 1 acre to a depth of 1 foot.

ACTIVE FRACTION -- The component of the soil having an ion exchange capacity, specifically clay and organic matter.

ADSORB -- Collect and adhere relatively loosely on a surface.

AEOLIAN -- Wind borne.

AGGRADATION -- the process of building up a surface by deposition. This is a long-term or geologic trend in sedimentation

ALKALINE SOIL -- A soil that has pH greater than 7.0, particularly above 7.3, throughout most or all of the root zone, although the term is commonly applied to only the surface layer or horizon of a soil.

ALLUVIAL -- Pertaining to material that is transported and deposited by running water.

ALLUVIAL LAND -- Areas of unconsolidated alluvium, generally stratified and varying widely in texture, recently deposited by streams, and subject to frequent flooding. A miscellaneous land type.

ALLUVIAL SOILS -- an axonal great soil group of soils, developed from transported and recently deposited material (alluvium) characterized by a weak modification (or none) of the original material by soil forming processes

ALLUVIUM -- a general term for all detrital material deposited or in transit by streams, including gravel, sand, silt, clay, and all variations and mixtures of these. Unless otherwise noted, alluvium is unconsolidated.

ANGLE OF REPOSE -- Angle between the horizontal and the maximum slope that a soil assumes through natural processes.

ANTECEDENT SOIL WATER -- Degree of wetness of a soil prior to irrigation or at the beginning of a runoff period, expressed as an index or as total inches soil water.

Glossary

ANTI-SEEP COLLAR -- a device constructed around a pipe or other conduit and placed through a dam, levee, or dike for the purpose of reducing seepage losses and piping failures.

ANTI-VORTEX DEVICE -- a facility placed at the entrance to a pipe conduit structure such as a drop inlet spillway or hood inlet spillway to prevent air from entering the structure when the pipe is flowing full.

APRON (soil engineering) -- a floor or lining to protect a surface from erosion. An example is the pavement below chutes, spillways, or at the toes of dams.

AUXILIARY SPILLWAY -- a dam spillway built to carry runoff in excess of that carried by the principal spillway. See Emergency Spillway.

BACKFILL -- the material used to refill a ditch or other excavation, or the process of doing so.

BEDROCK -- the solid rock underlying soils and the regolith in depths ranging from zero (where exposed by erosion) to several hundred feet.

BEDLOAD -- The sediment that moves by sliding, rolling, or bounding on or very near the streambed; sediment moved mainly by tractive or gravitational forces or both but at velocities less than the surrounding flow.

BLINDING MATERIAL -- Material placed on top and around a closed drain to improve the flow of water to the drain and to prevent displacement during backfilling of the trench.

BLIND INLET -- Inlet to a drain in which entrance of water is by percolation rather than open flow channels.

BORROW AREA -- a source of earth fill material used in the construction of embankments or other earth fill structures.

BOTTOM LANDS -- a term often used to define lowlands adjacent to streams.

BOX-CUT -- the initial cut driven in a property where no open side exists, resulting in a highwall on both sides at the cut.

BRUSH MATTING --

(1) A matting of branches placed on badly eroded land to conserve moisture and reduce erosion while trees or other vegetative covers are being established.

(2) A matting of mesh wire and brush used to retard streambank erosion.

CALCAREOUS -- Soil or rock material with high calcium carbonate content.

Glossary

CHANNEL -- a natural stream that conveys water; a ditch or channel excavated for the flow of water. See Watercourse.

CHANNEL IMPROVEMENT -- the improvement of the flow characteristics of a channel by clearing, excavation, realignment, lining, or other means in order to increase its capacity. Sometimes used to connote channel stabilization.

CHANNEL STABILIZATION -- Erosion prevention and stabilization of velocity distribution in a channel using jetties, drops, revetments, vegetation, and other measures.

CHANNEL STORAGE -- Water temporarily stored in channels while enroute to an outlet.

CLAY --

(a) Particle size less than 0.002 mm.

(b) Soil containing more than 45 percent clay, less than 40 percent silt, and less than 45 percent sand.

COLLOID -- in soil, organic or inorganic matter having very small particle size and a correspondingly large surface area per unit of mass. Most colloidal particles are too small to be seen with the ordinary compound microscope.

COLLUVIUM -- a deposit of rock fragments and soil material accumulated at the base of steep slopes as a result of gravitational action.

COMPACTION -- in soil engineering, the process by which the silt grains are rearranged to decrease void space and bring them into closer contact with one another, thereby increasing the weight of solid material per cubic foot.

CONDUIT -- any channel intended for the conveyance of water, whether open or closed.

CONSERVATION -- the protection, improvement, and use of natural resources according to principles that will assure their highest economic or social benefits.

CONSERVATION DISTRICT -- A public organization created under state enabling law as a special purpose district to develop and carry out a program of soil, water, and related resource conservation, use, and development within its boundaries; usually a subdivision of state government with a local governing body. Often called a soil conservation district or a soil and water conservation district.

CONTOUR --

(1) An imaginary line on the surface of the earth connecting points of the same elevation.

(2) A line drawn on a map connecting points of the same elevation.

Florida Erosion and Sediment Control Inspector's Manual

COVER CROP -- a close-growing crop grown primarily for the purpose of protecting and improving soil between periods of permanent vegetation.

CRADLE -- a device, usually concrete, used to support a pipe conduit or barrel.

CREEP (SOIL) -- Slow mass movement of soil and soil material down relatively steep slopes, primarily under the influence of gravity, but facilitated by saturation with water and by alternate freezing and thawing.

CRITICAL AREA -- A severely eroded sediment producing area that requires special management to establish and maintain vegetation in order to stabilize soil conditions.

CUT -- A portion of land surface or area from which earth has been removed or will be removed by excavation; the depth below original ground surface to excavated surface. Syn. excavation

CUT-AND-FILL -- Process of earth moving by excavating part of an area and using the excavated material for adjacent embankments or fill areas.

CUTOFF -- a wall, collar or other structure, such as a trench; filled with relatively impervious material intended to reduce seepage of water through porous strata.

DAM -- a barrier to confine or raise water for storage or diversion, to create a hydraulic head, to prevent gully erosion, or for retention of soil, rock, or other debris.

DEBRIS -- the loose material arising from the disintegration of rocks and vegetative material; transportable by streams, ice, or floods.

DEBRIS DAM -- a barrier built across a stream channel to retain rock, sand, gravel, silt, or other material.

DEBRIS GUARD -- a screen or grate at the intake of a channel, drainage, or pump structure for the purpose of stopping debris.

DEGRADATION -- to wear down by erosion, especially through stream action.

DESIGN HIGH WATER -- the elevation of the water surface as determined by the flow conditions of the design floods.

DESIGN LIFE -- the period of time for which a facility is expected to perform its intended function.

DESILTING AREA -- an area of grass, shrubs, or other vegetation used for inducing deposition of silt and other debris from flowing water; located above a stock tank, pond, field, or other area needing protection from sediment accumulation. See Filter Strip.

DETENTION -- The practice of temporarily storing runoff prior to its' gradual release, usually not greater than the pre-development discharge rate.

Glossary

DETENTION DAM -- a dam constructed for the purpose of temporary storage of streamflow or surface runoff and for releasing the stored water at controlled rates.

DIKE (engineering) -- an embankment to confine or control water, especially one built along the banks of a river to prevent overflow of lowlands; a levee. **(Geology)**--A tabular body of igneous rock that cuts across the structure of adjacent rocks or cuts massive rocks.

DISCHARGE (hydraulics) -- Rate of flow, specifically fluid flow; a volume of fluid passing a point per unit time, commonly expressed as cubic feet per second, million gallons per day, gallons per minute, or cubic meters per second.

DISCHARGE COEFFICIENT (hydraulics) -- the ratio of actual rate of flow to the theoretical rate of flow through orifices, weirs, or other hydraulic structures.

DISCHARGE FORMULA (hydraulics) -- a formula to calculate rate of flow of fluid in a conduit or through an opening. For steady flow discharge, $Q = AV$, wherein **Q** is rate of flow, **A** is cross-sectional area, and **V** is mean velocity. Common units are cubic feet per second, square feet, and feet per second, respectively. To calculate the mean velocity, **V** for uniform flow in pipes or open channels sees Manning's Formula.

DISPERSION, SOIL -- the breaking down of soil aggregates into individual particles, resulting in single-grain structure. Ease of dispersion is an important factor influencing the erodibility of soils. Generally speaking, the more easily dispersed the soil, the more erodible it is.

DIVERSION -- a channel with or without a supporting ridge on the lower side constructed across the top or at the bottom of a slope for the purpose of intercepting surface runoff.

DIVERSION DAM -- a barrier built to divert part or all of the water from a stream into a different course.

DRAIN --

- (1) A buried pipe or other conduit (closed drain).
- (2) A ditch (open drain) for carrying off surplus surface water or groundwater.
- (3) To provide channels, such as open ditches or closed drains, so that excess water can be removed by surface flow or by internal flow.
- (4) To lose water (from the soil) by percolation.

DRAINAGE --

- (1) The removal of excess surface water or groundwater from land by means of surface or subsurface drains.
- (2) Soil characteristics that affect natural drainage.

DRAINAGE, SOIL -- As a natural condition of the soil, soil drainage refers to the frequency and duration of periods when the soil is free of saturation; for example, in

well-drained soils the water is removed readily but not rapidly; in poorly drained soils the root zone is waterlogged for long periods unless artificially drained, and the roots of ordinary crop plants cannot get enough oxygen; in excessively drained soils the water is removed so completely that most crop plants suffer from lack of water. Strictly speaking, excessively drained soils are a result of excessive runoff due to steep slopes or low available water holding capacity due to small amounts of silt and clay in the soil material. The following classes are used to describe soil drainage:

WELL DRAINED -- excess water drains away rapidly and no mottling occurs within 36 inches of the surface.

MODERATELY WELL DRAINED -- water is removed from the soil somewhat slowly, resulting in small but significant periods of wetness. Mottling occurs between 18 and 36 inches.

SOMEWHAT POORLY DRAINED -- water is removed from the soil slowly enough to keep it wet for significant periods but not all of the time. Mottling occurs between 8 and 18 inches.

POORLY DRAINED -- water is removed so slowly that the soil is wet for a large part of the time. Mottling occurs between 0 and 8 inches.

VERY POORLY DRAINED -- water is removed so slowly that the water table remains at or near the surface for the greater part of the time. There may also be periods of surface ponding. The soil has a black to gray surface layer with mottles up to the surface.

DRAWDOWN -- Lowering of the water surface (in open channel flow), water table, or piezometric surface (in groundwater flow) resulting from a withdrawal of water.

DROP-INLET SPILLWAY -- Overfall structure in which the water drops through a vertical riser connected to a discharge conduit.

DROP SPILLWAY -- Overfall structure in which the water drops over a vertical wall onto an apron at a lower elevation.

DROP STRUCTURE -- a structure for dropping water to a lower level and dissipating its surplus energy; a fall. A drop may be vertical or inclined.

EARTH DAM -- Dam constructed of compacted soil material.

EMBANKMENT -- a man-made deposit of soil, rock, or other material used to form an impoundment.

EMERGENCY SPILLWAY -- a spillway used to carry runoff exceeding a given design flood. Syn. Auxiliary Spillway.

ENERGY DISSIPATOR -- a device used to reduce the energy of flowing water.

Glossary

ERODIBLE (geology and soils) -- Susceptible to erosion.

EROSION

(1) The wearing away of the land surface by running water, wind, ice, or other geological agents, including such processes as gravitational creep.

(2) Detachment and movement of soil or rock fragments by water, wind, ice, or gravity. The following terms are used to describe different types of water erosion:

ACCELERATED EROSION -- Erosion much more rapid than normal, or geologic erosion, primarily as a result of the influence of the activities of man, or in some cases, of other animals or natural catastrophes that expose base surfaces, for example, fires.

GEOLOGICAL EROSION -- The normal or natural erosion caused geological processes acting over long geologic periods and resulting in the wearing away of mountains, the building up of floodplains, coastal plains, etc. See Natural Erosion.

GULLY EROSION -- The erosion process whereby water accumulates in narrow channels and, over short periods, removes the soil from this narrow area to considerable depths, ranging from 1 to 2 feet to as much as 75 to 100 feet.

NATURAL EROSION -- Wearing away of the earth's surface by water, ice, or other natural agents under natural environmental conditions of climate, vegetation, etc.; undisturbed by man. See Geological Erosion.

NORMAL EROSION -- the gradual erosion of land used by man, which does not greatly exceed natural erosion. See Natural Erosion.

RILL EROSION -- An erosion process in which numerous small channels only several inches deep are formed; occurs mainly on recently disturbed and exposed soils. See Rill.

SHEET EROSION -- the removal of a fairly uniform layer of soil from the land surface by runoff water.

SPLASH EROSION -- the spattering of small soil particles caused by the impact of rain drops on wet soils. The loosened and spattered particles may or may not be subsequently removed by surface runoff.

EROSION AND SEDIMENTATION CONTROL PLAN -- A plan for the control of erosion and sedimentation resulting from a land-disturbing activity.

EROSION CLASSES (soil survey) -- a grouping of erosion conditions based on the degree of erosion or on characteristic patterns; applied to accelerated erosion, not to normal, natural, or geological erosion. Four erosion classes are recognized for water erosion and three for wind erosion.

EROSION INDEX -- An interaction term of kinetic energy times maximum 30-minute rainfall intensity that reflects the combined potential of raindrop impact and turbulence of runoff to transport dislodged soil particles from a field.

EROSIVE -- having sufficient velocity to cause erosion; refers to wind or water. Not to be confused with erodible as a quality of soil.

ESCARPMENT -- A steep face or a ridge of high land; the escarpment of a mountain range is generally on that side nearest the sea.

EXCHANGE CAPACITY -- Interchange between an ion in solution and another ion on the surface of any surface-active material such as a clay or organic colloid.

EXISTING GRADE -- the vertical location of the existing ground surface prior to cutting or filling.

FERTILIZER -- any organic or inorganic material of natural or synthetic origin that is added to a soil to supply elements essential to plant growth.

FERTILIZER ANALYSIS -- the percentage composition of fertilizer, expressed in terms of nitrogen, phosphoric acid, and potash. For example, a fertilizer with a 6-12-6 analysis contains 6 percent nitrogen (N), 12 percent available phosphoric acid (P_2O_5) and 6 percent water-soluble potash (K_2O). Minor elements may also be included. Recent analysis expresses the percentages in terms of the elemental fertilizer (nitrogen, phosphorus, potassium).

FILLING -- the placement of any soil or other solid material either organic or inorganic on a natural ground surface or an excavation.

FILTER STRIP -- a long, narrow vegetative planting used to retard or collect sediment for the protection of diversions, drainage basins or other structures.

FINAL CUT -- the last cut or line of excavation made when mining a specific property or area.

FINISHED GRADE -- the final grade or elevation of the ground surface forming proposed design.

FLOOD -- an overflow or inundation that comes from a river or other body of water and causes or threatens damage.

FLOOD CONTROL -- Methods or facilities for reducing flood flows.

FLOOD CONTROL PROJECT -- a structural system installed for protection of land and other improvements from floods by the construction of dikes, river embankments, channels, or dams.

Glossary

FLOODGATE -- a gate placed in a channel or closed conduit to keep out floodwater or tidal backwater.

FLOOD PEAK -- the highest value of the stage or discharge attained by a flood. The peak stage or peak discharge.

FLOODPLAIN -- nearly level land situated on either side of a channel, which is subject to overflow flooding.

FLOOD ROUTING -- determining the changes in the rise and fall of floodwater as it proceeds downstream through a valley or reservoir.

FLOOD STAGE -- the stage at which overflow of the natural banks of a stream begins to cause damage in the reach in which the elevation is measured.

FLOODWATER RETARDING STRUCTURE -- A Structure providing for temporary storage and controlled release of floodwater.

FLOODWAY -- A channel, either natural, excavated, or bounded by dikes and levees, used to carry excessive flood flows to reduce flooding; sometimes considered to be the transitional area between the active channel and the floodplain.

FLUME -- a device constructed to convey water on steep grades lined with erosion resistant materials.

FRAGIPAN -- a natural subsurface horizon with high bulk density relative to the soil above seemingly cemented when dry but showing a moderate to weak brittleness when moist. The layer is low in organic matter, mottled, slowly or very slowly permeable to water, and usually shows occasional or frequent bleached cracks forming polygons. It may be found in profiles of either cultivated or virgin-soils but not in calcareous material.

FREEBOARD (hydraulics) -- Vertical distance between the maximum water surface elevations anticipated in design and the top of retaining banks or structures provided to prevent overtopping because of unforeseen conditions.

GAGE OR GAUGE -- Device for registering precipitation, water level, discharge, velocity, pressure, temperature, etc.

GAGING STATION -- a selected section of a stream channel equipped with a gage, recorder, or other facilities for determining stream discharge.

GRADATION (geology) -- the bringing of a surface or a streambed to grade by running water. As used in connection with sedimentation and fragmental products for engineering evaluation, the term gradation refers to the frequency distribution of the various sized grains that constitute a sediment, soil, or material.

GRADE

- (1) The slope of a road, channel, or natural ground.
- (2) The finished surface of a canal bed, roadbed, top of embankment, or bottom of excavation; any surface prepared for the support of construction like paving or laying a conduit.
- (3) To finish the surface of a canal bed, roadbed, top of embankment, or bottom of excavation.

GRADED STREAM -- a stream in which, over a period of years, the slope is delicately adjusted to provide, with available discharge and with prevailing channel characteristics, just the velocity required for transportation of the load (of sediment) supplied from the drainage basin. The graded profile is a slope of transportation. It is a phenomenon in which the element of time has a restricted connotation. Works of man are limited to his experience and of design and construction.

GRADE STABILIZATION STRUCTURE -- a structure for the purpose of stabilizing the grade of a gully or other watercourse, thereby preventing further headcutting or lowering of the channel grade.

GRADIENT -- Change of elevation, velocity, pressure, or other characteristics per unit length; slope.

GRADING -- Altering surfaces to specified elevations, dimensions, and/or slopes; this includes stripping, cutting, filling, stockpiling, and shaping, or any combination thereof; and shall include the land in its cut or filled condition.

GRASS -- a member of the botanical family ***Gramineae***, characterized by bladelike leaves arranged on the culm or stem in two ranks.

GRASSED WATERWAY -- a natural or constructed waterway, usually broad and shallow, covered with erosion-resistant grasses, used to conduct surface water from cropland.

GULLY -- a channel or miniature valley cut by concentrated runoff but through which water commonly flows only during and immediately after heavy rains or during the melting of snow. A gully may be dendritic or branching; or it may be linear, rather long, narrow, and of uniform width. The distinction between gully and rill is one of depth. A gully is sufficiently deep that it would not be obliterated by normal tillage operations, whereas a rill is of lesser depth and would be smoothed by use of ordinary tillage equipment. See Erosion, Rill.

GULLY EROSION -- See Erosion.

GULLY CONTROL PLANTINGS -- The planting of forage, legume, or woody plant seeds, seedlings, cuttings, or transplants in gullies to establish or reestablish a vegetative cover adequate to control runoff and erosion and incidentally produce useful products.

Glossary

HABITAT -- the environment in which the life needs of a plant or animal organism, population or community are supplied.

HEAD (hydraulics)

(1) The height of water above any plane of reference.

(2) The energy, either kinetic or potential, possessed by each unit weight of a liquid, expressed as the vertical height through which a unit weight would have to fall to release the average energy possessed; used in various compound terms such as pressure head, velocity head, and lost head.

(3) The internal pressure expressed in feet, or pounds per square inch, of an enclosed conduit.

HEADGATE -- Water control structure; the gate at the entrance to a conduit.

HEAD LOSS -- Energy loss due to friction, eddies, changes in velocity, or direction of flow. Syn. friction head.

HEADWATER

(1) The source of stream.

(2) The water upstream from a structure or point on a stream.

HOOD INLET -- Entrance to a closed conduit that has been shaped to induce full flow at minimum water surface elevation.

HYDROGRAPH -- A graph showing variation in stage (depth) or discharge of a stream of water over a period of time.

IGNEOUS ROCK -- Rock formed from the cooling and solidification of molten rock, and that has not been changed appreciably since its formation.

IMPOUNDMENT -- Generally, an artificial collection or storage of water, as a reservoir, pit, dugout, sump, etc. Syn. reservoir.

INFILTRATION -- the gradual downward flow of water from the surface through soil to groundwater and water table reservoirs.

INFILTRATION RATE -- A soil characteristic determining or describing the maximum rate at which water can enter the soil under specified conditions, including the presence of an excess of water.

INLET (hydraulics)

(1) A surface connection to a closed drain.

(2) A structure at the diversion end of a conduit.

(3) The upstream end of any structure through which water may flow.

INOCULATION -- the process of introducing pure or mixed cultures of micro-organisms into natural or artificial cultural media.

INTAKE

- (1) The headworks of a conduit, the place of diversion.
- (2) Entry of water into soil. See Infiltration.

INTAKE RATE -- the rate of entry of water into soil. See Infiltration Rate.

INTENSITY -- Rainfall rate, usually expressed in inches / hour.

INTERCEPTION (hydraulics) -- the process by which precipitation is caught and held by foliage, twigs, and branches of trees, shrubs, and other vegetation. Often used for "interception loss" or the amount of water evaporated from the precipitation intercepted.

INTERCEPTION CHANNEL -- a channel excavated at the top of earthcuts, at the foot of slopes or at other critical places to intercept surface flow; a catch drain. See Interception Ditch.

INTERCEPTOR DRAIN -- Surface or subsurface drain, or a combination of both, designed and installed to intercept flowing water.

INTERFLOW -- that portion of rainfall that infiltrates into the soil and moves laterally through the upper soil horizons until intercepted by a stream channel or until it returns to the surface at some point downslope from its point of infiltration.

INTERMITTENT STREAM -- a stream or portion of a stream that flows only in direct response to precipitation. It receives little or no water from springs and no long-continued supply from melting snow or other sources. It is dry for a large part of the year, ordinarily more than three months.

INTERNAL SOIL DRAINAGE -- the downward movement of water through the soil profile. The rate of movement is determined by the texture, structure, and other characteristics of the soil profile and underlying layers; and by the height of the watertable, either permanent or perched. Relative terms for expressing internal drainage are: none, very slow, slow, medium, rapid, and very rapid.

LAND -- the total natural and cultural environment within which production takes place; a broader term than soil. In addition to soil, its attributes include other physical conditions, such as mineral deposits, climate, and water supply; location in relation to centers of commerce, populations, and other land; the size of the individual tracts or holdings; and existing plant cover, works of improvement, and the like. Some use the terms loosely in other senses: as defined above but without the economic or cultural criteria; especially in the expression "natural land" as a synonym for "soil"; for the solid surface of the earth; and also for earthy surface formations, especially in the geomorphological expression "land form".

LAND CAPABILITY -- the suitability of land for use without permanent damage. Land capability, as ordinarily used in the United States, is an expression of the effect of physical land conditions, including climate, on the total suitability for use without damage for crops that require regular tillage, for grazing, for woodland, and for wildlife.

Glossary

Land capability involves consideration of (1) the risks of land damage from erosion and other causes and (2) the difficulties in land use owing to physical land characteristics, including climate.

LAND CAPABILITY CLASSIFICATION -- a grouping of kinds of soils into special units, subclasses, and classes according to their capability for intensive use and the treatments required for sustained use. (Prepared by the Soil Conservation Service, USDA.)

LAND CAPABILITY MAP -- a map showing land capability units, subclasses and classes, or a soil survey map colored to show land capability classes.

LAND CAPABILITY UNIT -- Capability units provide more specific and detailed information for application to specific fields on a farm or ranch than the subclass of the land capability classification. A capability unit is a group of soils that are nearly alike in suitability for plant growth and responses to the same kinds of soil management.

LAND CLASSIFICATION -- the arrangement of land units into various categories based on the properties of the land or its suitability for some particular purpose.

LAND-DISTURBING ACTIVITY -- Any land change which may result in soil erosion from water or wind and the movement of sediments into State water or onto lands within the State, including, but not limited to, clearing, dredging, grading, excavating, transporting and filling of land.

LAND FORM -- A discernible natural landscape, such as a floodplain, stream terrace, plateau, valley, etc.

LAND RECLAMATION -- Making land capable of more intensive use by changing its general character, as by drainage of excessively wet land; irrigation of arid or semiarid land; or recovery of submerged land from seas, lakes, and rivers. Large-scale reclamation projects usually are carried out through collective effort. Simple improvements, such as cleaning of stumps or stones from land, should not be referred to as land reclamation.

LEACHING -- the removal from the soil in solution of the more soluble materials by percolating waters.

LEGUME -- a member of the legume or pulse family, *Leguminosae*. One of the most important and widely distributed plant families. The fruit is a "legume" or pod that opens along two sutures when ripe. Flowers are usually papilionaceous (butterflylike). Leaves are alternate, have stipules, and are usually compound. Includes many valuable food and forage species, such as the peas, beans, peanuts, clover, alfalfas, sweet clovers, lespedezas, vetches, and kudzu. Practically all legumes are nitrogen-fixing plants.

LEVEL SPREADER -- a shallow channel excavation at the outlet end of a diversion with a level section for the purpose of diffusing the diversion out-flow.

LIME -- Lime, from the strictly chemical standpoint, refers to only one compound, calcium oxide (CaO); however, the term "lime" is commonly used in agriculture to include a great variety of materials which are usually composed of the oxide, hydroxide, or carbonate of calcium or of calcium and magnesium. The most commonly used forms of agricultural lime are ground limestone (carbonates), hydrated lime (hydroxides), burnt lime (oxides), marl, and oyster shells.

LIME, AGRICULTURAL -- A soil amendment consisting principally of calcium carbonate, but including magnesium carbonate and perhaps other materials, used to furnish calcium and magnesium as essential elements for the growth of plants and to neutralize soil acidity.

LIMING -- the application of lime to land, primarily to reduce soil acidity and supply calcium for plant growth. Dolomitic limestone supplies both calcium and magnesium. May also improve soil structure, organic matter content, and nitrogen content of the soil by encouraging the growth of legumes and soil microorganisms. Liming an acid soil the pH value of about 6.5 is desirable for maintaining a high degree of availability of most of the nutrient elements required by plants.

LIQUEFICATION (spontaneous liquefaction) -- The sudden large decrease of the shearing resistance of a cohesionless soil, caused by a collapse of the structure from shock or other type of strain and associated with a sudden but temporary increase in the pore-fluid pressure. It involves a temporary transformation of the material into a fluid mass.

LIQUID LIMIT (LL) -- the water content corresponding to the arbitrary limit between the liquid and plastic states of consistency of a soil.

LITTER -- in forestry, a surface layer of loose organic debris in forests, consisting of freshly fallen or slightly decomposed organic materials.

LOAMY -- Intermediate in texture and properties between fine-textured and coarse-textured soils.

LOESS -- Material transported and deposited by wind and consisting primarily of silt-sized particles.

LOOSE ROCK DAM -- a dam built of rock without the use of mortar, a rubble dam. See Rock-Fill Dam.

MADE LAND -- Areas filled with earth or earth and trash mixed, usually made by or under the control of man. A miscellaneous land type.

Glossary

MANNING'S FORMULA (hydraulics) -- A formula used to predict the velocity of water flow in an open channel or pipeline:

$$V = \frac{1.49 R^{2/3} S^{1/2}}{n}$$

Where in **V** is the mean velocity of flow in feet per second, **R** is the hydraulic radius, **S** is the slope of the energy gradient or for assumed uniform flow the slope of the channel in feet per foot, and **n** is the roughness coefficient or retardance factor of the channel lining.

MEAN DEPTH (hydraulics) -- Average depth; cross-sectional area of a stream or channel divided by its surface or top width.

MEAN VELOCITY -- Average velocity obtained by dividing the flow rate discharge by the cross-sectional area for that given cross-section.

MEASURING WEIR -- a shaped notch through which water flows are measured. Common shapes are rectangular, trapezoidal, and triangular.

MECHANICAL ANALYSIS -- the analytical procedure by which soil particles are separated to determine the particle size distribution.

MECHANICAL PRACTICES -- Soil and water conservation practices that primarily change the surface of the land or that store, convey, regulate, or dispose of runoff water without excessive erosion. See Structural Practices.

METAMORPHIC ROCK -- Rock derived from pre-existing rocks but differing from them in physical, chemical, and mineralogical properties as a result of natural geologic processes, principally heat and pressure, originating within the earth. The pre-existing rock may have been igneous, sedimentary, or another form of metamorphic rock.

MONOLITHIC -- of or pertaining to a structure formed from a single mass of stone.

MOVEABLE DAM -- a moveable barrier that may be opened in whole or in part, permitting control of the flow of water through or over the dam.

MUCK SOIL

(1) An organic soil in which the organic matter is well decomposed (USA usage).

(2) A soil containing 20 to 50 percent organic matter.

MULCH -- a natural or artificial layer of plant residue or other materials, such as sand or paper, on the soil surface.

NATURAL GROUND SURFACE -- the ground surface in its original state before any grading, excavation, or filling.

NOISE POLLUTION -- the persistent intrusion of noise into the environment at a level that may be injurious to human health.

NORMAL DEPTH -- Depth of flow in an open conduit during uniform flow for the given conditions. See Uniform Flow.

OPEN DRAIN -- Natural watercourse or constructed open channel that conveys drainage water.

ORGANIC MATTER -- any organisms, alive or dead, and any material derived therefrom.

OUTFALL -- Point where water flows from a conduit, stream, or drain.

OUTLET -- Point of water disposal from a stream, river, lake, tidewater, or artificial dam.

OUTLET CHANNEL -- a waterway constructed or altered primarily to carry water from man-made structures, such as terraces, tile lines, and diversions.

OVERFALL -- Abrupt change in stream channel elevation; the part of a dam or weir over which the water flows.

OVERHAUL -- Transportation of excavated material beyond a specified haul limit, usually expressed in cubic yard stations (1 cubic yard hauled 100 feet).

PARENT MATERIAL (soils) -- the unconsolidated, more or less chemically weathered, mineral or organic matter from which the solum of soils has developed by pedogenic processes. The C horizon may or may not consist of materials similar to those from which the A and B horizons developed.

PARGE -- To apply a smooth plaster or sand & cement mixture to masonry walls for waterproofing or esthetics. Also used to fill "honeycombs" or voids in poured concrete.

PEAK DISCHARGE -- the maximum instantaneous flow from a given storm condition at a specific location.

PEDS -- Units of soil structure formed by natural processes.

PEDOLOGICAL AGE -- Maturity of a soil in terms of its developmental characteristics rather than its chronological age.

PERCOLATION -- The downward movement of water through soil, especially the downward flow of water in saturated or nearly saturated soil at hydraulic gradients of the order of 1.0 or less.

PERMEABILITY -- Capacity for transmitting a fluid. It is measured by the rate at which a fluid of standard viscosity can move through material in a given interval of time under a given hydraulic gradient.

Glossary

PERMEABILITY (soil engineering) -- the quality of soil horizon that enables water or air to move through it. The permeability of a soil may be limited by the presence of one nearly impermeable horizon even though the others are permeable.

pH -- a numerical measure of the acidity or hydrogen ion activity. The neutral point is pH 7.0. All pH values below 7.0 are acid and all above are alkaline.

PIPE DROP -- a circular conduit used to convey water down steep grades.

PLASTICITY INDEX (PI) -- the numerical difference between the liquid limit and the plastic limit.

PLASTIC LIMIT (PL) -- the water content corresponding to an arbitrary limit between the plastic and semisolid states of consistency of soil.

PLASTIC SOIL -- A soil capable of being molded or deformed continuously and permanently by relatively moderate pressure.

PLUNGE POOL -- a device used to dissipate the energy of flowing water that may be constructed or made by the action of flowing. These facilities may be protected by various lining materials.

POOLS -- Areas of a stream where the velocity provides a favorable habitat for plankton. Silts and other loose materials that settle to the bottom of pools are favorable for burrowing forms of benthos. Syn. riffle.

PRINCIPAL SPILLWAY -- a water conveying device generally constructed of permanent material and designed to regulate the normal water level, provide flood protection and/or reduce the frequency of operation of the emergency spillway.

RATIONAL FORMULA -- $Q = CIA$. Where **Q** is the peak discharge measured in cubic feet per second, **C** is the runoff coefficient reflecting the ratio of runoff to rainfall, **I** is the rainfall intensity for the duration of the storm measured in inches per hour, and **A** is the area contributing drainage measured in acres.

RELIEF DRAIN -- a drain designed to remove water from the soil in order to lower the watertable and reduce hydrostatic pressure.

RELIEF WELL -- well, pit, or bore penetrating the watertable to relieve hydrostatic pressure by allowing flow from the aquifer.

RESIDUAL SOIL (RESIDUUM) -- Unconsolidated and partly weathered mineral materials accumulated by disintegration of rock in place.

RESTORATION -- the process of restoring site conditions as they were before the land disturbance.

RETENTION -- The practice of capturing and storing runoff for percolation into the ground.

RETURN FLOW -- That portion of the water diverted from a stream that finds its way back to the stream channel either as surface or underground flow.

RILL -- a small intermittent watercourse with steep sides, usually only a few inches deep and thus no obstacle to tillage operations.

RILL EROSION -- See Erosion

RIPRAP -- Broken rock, cobbles, or boulders placed on earth surfaces, such as the face of a dam or the bank of a stream, for protection against the action of water (waves); also applied to brush or pole mattresses, or brush and stone, or other similar materials used for soil erosion control.

RISER -- the inlet portions of drop inlet spillway that extend vertically from the pipe conduit barrel to the water surface.

RIVER BASIN -- a major water resource region. The United States has been divided into 20 river basin areas.

ROCK-FILL DAM -- a dam composed of loose rock usually dumped in place, often with the upstream part constructed of hand placed or derrick-placed rock and faced with rolled earth or with an impervious surface of concrete, timber, or steel.

RUNOFF (hydraulics) -- that portion of the precipitation on a drainage area that is discharged from the area in stream channels. Types include runoff, groundwater runoff, or seepage.

SAND

- (a) Particle size between 2 mm and 0.05 mm,
- (b) Soil containing more than 84 percent sand.

SCARIFY -- to abrade, scratch, or modify the surface; for example, to scratch the impervious seed coat of hardseed or to break the surface of the soil with a narrow-bladed implement.

SCREENING -- the use of any vegetative planting, fencing, ornamental wall of masonry, or other architectural treatment, earthen embankment, or a combination of any of these, which will effectively hide from view any undesirable areas from the main traveled way.

SEDIMENT -- Solid material, both mineral and organic, that is in suspension, is being transported, or has been moved from its site of origin by air, water, gravity, or ice, as a product of erosion.

SEDIMENT BASIN -- a depression formed from the construction of a barrier or dam built at a suitable location to retain sediment and debris.

Glossary

SEDIMENT DISCHARGE -- the quantity of sediment, measured in dry weight or by volume, transported through a stream cross-section in a given time. Sediment discharge consists of both suspended load and bedload.

SEDIMENT LOAD -- See Sediment Discharge.

SEDIMENT POOL -- the reservoir space allotted to the accumulation of submerged sediment during the life of the structure.

SEDIMENTARY ROCK -- Rock formed from materials deposited from suspension or precipitated from solution, usually more or less consolidated.

SEEDBED -- the soil prepared by natural or artificial means to promote the germination of seed and the growth of seedlings.

SEEPAGE

(1) Water escaping through or emerging from the ground along an extensive line or surface as contrasted with a spring where the water emerges from a localized spot.

(2) The slow movement of gravitational water through the soil (percolation).

SHEETFLOW -- Water, usually storm runoff, flowing in a thin layer over the ground surface; also called overland flow.

SHRINK-SWELL POTENTIAL -- Susceptibility to volume change due to loss or gain in moisture content.

SHRINKAGE INDEX (SI) -- the numerical difference between the plastic and shrinkage limits.

SHRINKAGE LIMIT (SL) -- the maximum water content at which a reduction in water content will not cause a decrease in the volume of the soil mass. This defines the arbitrary limit between the solid and semi-solid states.

SILT

(1) A soil separate consisting of particles between 0.05 and 0.002 millimeter in equivalent diameter.

(2) A soil textural class containing more than 80 percent silt and less than 12 percent clay.

SILTING -- See Sediment.

SILT LOAM -- a soil textural class containing a large amount of silt and small quantities of sand and clay.

SILTY CLAY -- a soil textural class containing a relatively large amount of silt and clay and a small amount of sand.

SILTY CLAY LOAM -- a soil textural class containing a relatively large amount of silt, a lesser quantity of clay, and a still smaller quantity of sand.

SLOPE -- the degree of deviation of a surface from horizontal, measured in a numerical ratio, percent, or degrees. Expressed as a ratio or percentage, the first number is the vertical distance (rise) and the second is the horizontal distance (run), as 2:1 or 200 percent. Expressed in degrees, it is the angle of the slope from the horizontal plane with a 90 slope being vertical (maximum) and 45 being a 1:1 slope.

SLOPE CHARACTERISTICS -- Slopes may be characterized as concave (decrease in steepness in lower portion), uniform, or convex (increase in steepness at base). Erosion is strongly affected by shape, ranked in order of increasing erodibility from concave to uniform to convex.

SOIL -- the unconsolidated mineral and organic material on the immediate surface of the earth that serves as a natural medium for the growth of land plants.

SOIL AMENDMENT -- any material, such as lime, gypsum, sawdust, or synthetic conditioner that is worked into the soil to make it more amenable to plant growth.

SOIL HORIZON -- A layer of soil or soil material approximately parallel to the surface, occurring naturally, and distinguishable from adjacent horizons by differences in color, texture, quantity of organic matter, etc. Simplified horizon designations are: O = the surface litter, A = topsoil, root zone, B = subsoil, containing more clay and less organic matter than A, C = parent material, and R = bedrock.

SOIL PROFILE -- a vertical section of the soil from the surface through all horizons, including C horizons.

SOIL SERIES -- The basic unit of soil classification, being a subdivision of a family and consisting of soils which are essentially alike in all major profile characteristics except the texture of the A horizon.

SOIL STRUCTURE -- a combination or arrangement of soil particles into larger units, or peds.

SOIL TEXTURE -- the relative proportions of various soil sized particles characterizing a soil, as described by the classes of soil texture shown on the textural triangle.

SPILLWAY -- an open or closed channel, or both, used to convey excess water from a reservoir. It may contain gates, either manually or automatically controlled, to regulate the discharge of excess water.

SPOIL -- Soil or rock material excavated from a canal, ditch, basin, or similar construction.

STABILIZATION -- the process of establishing an enduring soil cover of vegetation and/or mulch or other ground cover in combination with installing temporary or

Glossary

permanent structures for the purpose of reducing to a minimum the transport of sediment by wind, water, ice, or gravity.

STABILIZED GRADE -- the slope of a channel at which neither erosion nor deposition occurs.

STAGE (hydraulics) -- the variable water surface or the water surface elevation above any chosen datum. See Gaging Station.

STORM DRAIN OUTLET PROTECTION STRUCTURE -- a device used to dissipate the energy of flowing water. Generally constructed of concrete or rock in the form of a partially depressed or partially submerged vessel and may utilize baffles to dissipate velocities.

STORM FREQUENCY -- an expression or measure of how often a hydrologic event of a given size or magnitude should on an average be, based on a reasonable sample.

STEAMBANKS -- the usual boundaries, not the flood boundaries, of a stream channel. Right and left banks are named facing downstream.

STREAM GAGING -- the quantitative determination of stream flow using gages, current meters, weirs, or other measuring instruments at selected locations. See Gaging Station.

STREAMLOAD -- Quantity of solid and dissolved material carried by a stream. See Sediment Load.

STRUCTURAL PRACTICES -- Soil and water conservation measures, other than vegetation, utilizing the mechanical properties of matter for the purpose of either changing the surface of the land or storing, regulating, or disposing of runoff to prevent excessive sediment loss. Including but not limited to riprap, sediment basins, dikes, level spreaders, waterways or outlets, diversions, grade stabilization structures, sediment traps, land grading, etc. See Mechanical Practices

SUBSOIL -- The B horizons of soils with distinct profiles. In soils with weak profile development, the subsoil can be defined as the soil below the plowed soil (or its equivalent of surface soil), in which roots normally grow. Although a common term, it cannot be defined accurately. It has been carried over from early days when "soil" was conceived only as the plowed soil and that under it as the "subsoil".

SUBWATERSHED -- a watershed subdivision of unspecified size that forms a convenient natural unit.

TERRACE -- an embankment or combination of an embankment and channel across a slope to control erosion by diverting or storing surface runoff instead of permitting it to flow uninterrupted down from the soil.

TILE, DRAIN -- Pipe made of burned clay, concrete, or similar material, in short lengths, usually laid with open joints to collect and carry excess water from the soil.

TILE DRAINAGE -- Land drainage by means of a series of tile lines laid at a specified depth and grade.

TOE (engineering) -- Terminal edge or edges of a structure; the bottom of a slope.

TOE DRAIN -- Interceptor drain located near the downstream toe of a structure.

TOPSOIL -- Earthy material used as top-dressing for house lots, grounds for large buildings, gardens, road cuts, or similar areas. It has favorable characteristics for production of desired kinds of vegetation or can be made favorable.

TRASH RACK -- a structural device used to prevent debris from entering a spillway or other hydraulic structure.

UNIFIED SOIL CLASSIFICATION SYSTEM (engineering) -- a classification system based on the identification of soils according to their particle size, gradation, plasticity index, and liquid limit.

UNIFORM FLOW -- a state of steady flow when the mean velocity and cross-sectional area are equal at all sections of a reach.

UNIVERSAL SOIL LOSS EQUATION -- an equation used for the design of water erosion control systems: $A = RKLSPC$ wherein **A** = average annual soil loss in tons per acre per year, **R** = rainfall factor, **K** = soil erodibility factor, **L** = length of slope, **S** = percent of slope, **P** = conservation practice factor, and **C** = cropping and management factor.

VEGETATIVE PRACTICE -- Stabilization of erosive or sediment-producing areas by covering the soil with:

- (a) Permanent seeding, producing long-term vegetative cover, or
- (b) Short-term seeding, producing temporary vegetative cover, or
- (c) Sodding, producing areas covered with a turf of perennial sod-forming grass.

WATER CLASSIFICATION -- Separation of water of an area into classes according to usage, such as domestic consumption, fisheries, recreation, industrial, agricultural, navigation, waste disposal, etc.

WATER CONSERVATION -- the physical control, protection, management, and use of water resources in such a way as to maintain crop, grazing, and forest lands; vegetal cover; wildlife; and wildlife habitat for maximum sustained benefits to people, agriculture, industry, commerce, and other segments of the national economy.

WATER CONTROL (soil and water conservation) -- the physical control of water by such measures as conservation practices on the land, channel improvement, and installation of structures for water retardation and sediment detention (does not refer to legislative or regulatory control or water rights).

Glossary

WATER CUSHION -- Pool of water maintained to absorb the impact of water flowing from an overfall structure.

WATER DEMAND -- Water requirements for a particular purpose, such as irrigation, power, municipal supply, plant transpiration, or storage.

WATER DISPOSAL SYSTEM -- the complete system for removing excess water from land with minimum erosion. For sloping land, it may include a terrace system, terrace outlet channels, dams, and grassed waterways. For level land, it may include only surface drains or both surface and subsurface drains.

WATER QUALITY STANDARDS -- Minimum requirements of purity of water for various uses; for example, water for agricultural use in irrigation systems should not exceed specific levels of sodium bicarbonates, pH, total dissolved salts, etc.

WATER RESOURCES -- the supply of groundwater and surface water in a given area.

WATERCOURSE -- Any natural or artificial watercourse, stream, river, creek, channel, ditch, canal, conduit, culvert, drain, waterway, gully, ravine, or wash in which water flows either continuously or intermittently and which has a definite channel, bed and banks, and including any area adjacent thereto subject to inundation by reason of overflow or floodwater.

WATERSHED AREA -- All land and water within the confines of a drainage divide or a water problem area consisting in whole or in part of land needing drainage or irrigation.

WATERSHED LAG -- Time from center of mass of effective rainfall to peak of hydrograph.

WATERSHED MANAGEMENT -- Use, regulation, and treatment of water and land resources of a watershed to accomplish stated objectives.

WATERSHED PLANNING -- Formulation of a plan to use and treat water and land resources.

WATERWAY -- a natural course or constructed channel for the flow of water. See Grassed Waterway.

WEIR -- Device for measuring or regulating the flow of water.

WEIR NOTCH -- the opening in a weir for the passage of water.

WETTING AGENT -- a chemical that reduces the surface tension of water and enables it to soak into porous material more readily.