

MAC[®] 1200

resting ECG analysis system
Operator's Manual

Version 1.1
227 492 04 GA (USA) Revision D



marquette

A GE Medical Systems Company

The information contained in this manual describes version 1.1 of the MAC® 1200 resting ECG analysis system and reflects software version 5.1.

© 1999 GE Marquette Medical Systems, Inc. All rights reserved.

Trademarked names appear throughout this document. Rather than list the names and entities that own the trademarks or insert a trademark symbol with each mention of the trademarked name, the publisher states that it is using the names only for editorial purposes and to the benefit of the trademark owner with no intention of improperly using the trademark.

900 SC, ACCUSKETCH, AccuVision, APEX, AQUA-KNOT, ARCHIVIST, Autoseq, BABY MAC, C Qwik Connect, CardioServ, CardioSmart, CardioSys, CardioWindow, CASE, CD TELEMETRY, CENTRA, CHART GUARD, CINE 35, COROLAN, CORO, COROMETRICS, Corometrics Sensor Tip, CRG PLUS, DASH, Digistore, Digital DATAQ, E for M, EAGLE, Event-Link, FMS 101B, FMS 111, HELDIGE, IMAGE STORE, INTELLIMOTION, IQA, LASER SXP, MAC, MAC-LAB, MACTRODE, MARQUETTE, MARQUETTE MAC, MARQUETTE MEDICAL SYSTEMS, MARQUETTE UNITY NETWORK, MARS, MAX, MEDITEL, MEI, MEI in the circle logo, MEMOPOINT, MEMOPOINT C, MINISTORE, MINNOWS, Monarch 8000, MULTI-LINK, MULTISRIPTOR, MUSE, MUSE CV, Neo-Trak, NEUROSCRIPT, OnlineABG, OXYMONITOR, Pres-R-Cuff, PRESSURE-Scribe, QMI, QS, Quantitative Medicine, Quantitative Sentinel, RAC, RAMS, RSVP, SAM, SEER, SILVERTRACE, SOLAR, SOLARVIEW, Spectra 400, Spectra-Overview, Spectra-Tel, ST GUARD, TRAM, TRAM-NET, TRAM-RAC, TRAMSCOPE, TRIM KNOB, Trimeline, UNITY logo, UNITY NETWORK, Vari-X, Vari-X Cardiomatic, VariCath, VARIDEX, VAS, and Vision Care Filter are trademarks of GE Marquette Medical Systems, Inc., registered in the United States Patent and Trademark Office.

12SL, 15SL, Access, AccuSpeak, ADVANTAGE, BAM, BODYTRODE, Cardiomatic, CardioSpeak, CD TELEMETRY®-LAN, CENTRALSCOPE, Corolation, EK-Pro, EDIC, Event-Link Cumulus, Event-Link Cirrus, Event-Link Nimbus, HI-RES, ICMMS, IMAGE VAULT, IMPACT.wf, INTER-LEAD, LIFEWATCH, Managed Use, MARQUETTE PRISM, MARQUETTE® RESPONDER, MENTOR, MicroSmart, MMS, MRT, MUSE CardioWindow, NST PRO, NAUTILUS, OCTANET, O2 SENSOR, OMRS, PHi-Res, Premium, Prism, QUIK CONNECT V. QUICK CONNECT, QT Guard, SMARTLOOK, SMART-PAC, Spiral Lok, Sweetheart, UNITY, Universal, Waterfall, and Walkmom are trademarks of GE Marquette Medical Systems, Inc.

Revision History

This manual is subject to the GE Marquette change order service. The revision letter which follows the document part number, changes with every update of the manual.

Part No./ Revision	Date	Comment
227 492 04-A	January 1999	Initial Release
227 492 04-B	March 17, 1999	ECO 061 952
227 492 04-C	May 7, 1999	ECO 062 136
227 492 04-D	October 11, 1999	ECO 062 920

MAC 1200 Option Codes

In addition to the software supplied with the unit, optional programs may be purchased to upgrade the MAC 1200 performance features. In order to use a new option, you need to activate it by entering the option code number (refer to section 9.8 for details). The option codes are entered into the MAC 1200 prior to shipping.

Software package	Functionality	Option Code
MEAS	measurement (measurement of the 10-second resting ECG)	-----
DIAG	interpretation (interpretation of the 10-second resting ECG)	-----
MEMO	memory (storage of a maximum of 40 10-second resting ECGs)	-----
C100	activates the three options MEAS, DIAG, MEMO for a maximum of 100 ECGs	-----
C500	activates the three options MEAS, DIAG, MEMO for a maximum of 500 ECGs	-----
EVAL	activates the three options MEAS, DIAG, MEMO for a maximum of 4 weeks	-----

Serial No:	-----
-------------------	-------

How to Reach Us . . .

Service Calls and Product Support

To open a service call or obtain product support call the numbers below:

Service calls	All products	800-558-7044 (U.S. & Canada) 561-575-5000 (outside U.S.)
	Product support	
	Monitors	800-558-7044 (U.S. & Canada) 561-575-5000 (outside U.S.)
	Cardiology	800-558-5120 (U.S.) 414-355-5000 (outside U.S.)

or contact your local sales and service representative:

Name: _____

Telephone: _____

For other product information please contact one of the offices listed on the next page.

Ordering Supplies and Service Parts

Order supplies (leadwires, electrode paste, thermal paper, etc.) or service parts (circuit boards, cables, software, etc.) and manuals from:

Supplies

GE Marquette Supplies
2607 North Grandview Blvd.
Mail Code: SN-471
Waukesha, WI 53188
Telephone: 800-558-5102 (U.S. only)
414-521-6856 (outside U.S.)
Fax: 800-232-2599 (U.S. only)
414-521-6855 (outside U.S.)

Service parts

GE Marquette Service Parts
P.O. Box 9100, 100 Marquette Drive
Jupiter, FL 33468-9100
Telephone: 800-321-3251 (U.S. only)
561-575-5000 (outside U.S.)
Fax: 800-421-6841 (U.S. only)
561-575-5050 (outside U.S.)

Have the following information handy before calling:

- part number of the defective part, or
- model and serial number of the equipment,
- part number/name of the assembly where the item is used,
- item name, and
- where applicable, reference designation (eg. R13, S12)

Ordering Manuals When ordering additional operator manuals, be sure to include the software version of the product.

Other Questions or Problems

For additional information contact one of the offices listed below.

Headquarters

GE Marquette Medical Systems, Inc.
8200 West Tower Avenue
Milwaukee, Wisconsin 53223
USA
Telephone: 414-355-5000
800-558-5120 (U.S. only)
Fax 414-355-3790

Europe

GE Marquette Hellige GmbH
Postfach 60 02 65
D-79032 Freiburg
Germany
Telephone: +49-761-4543-0
Fax: +49-761-4543-233

Australia

Marquette Medical Systems (Australia) Pty Ltd.
Forest Corporate Centre, Suite 7
19 Rodborough Road
Frenchs Forest NSW 2086
Australia
Telephone: (61) (2) 9975-5501
Fax: (61) (2) 9975 5503

Japan

Marquette Medical System, Japan
Waseda Hirai Building, 7th Floor
1-18-9, Nishi-Waseda
Shinjuku-KuTokyo, Japan
Telephone: (81) (3) 3203-1631
Fax: (81) (3) 3202-1626

Hong Kong

Marquette Medical Systems (HK)
26/F, Catic Plaza
8 Causeway Road
Causeway Bay, Hong Kong
Telephone: (852) 2804-2320
Fax: (852) 2804 1776

Southeast Asia

Marquette Electronics (SEA) Pte.
#2 Leng Kee Road
04-04A Thye Hong Centre
Singapore 0315
Telephone: (65) 471-2133
Fax: (65) 471-1540

General Information

- Standards compliance:

European Council Directive 93/42/EEC

IEC60601-1-2/EN 60601-1-2 "Electromagnetic Compatibility - Medical Electrical Equipment"

CISPR11 / EN 55011 "Radio interference emission"

IEC 60601, protection class I

MDD class IIa

UL 2601-1

- The symbol  means: Consult accompanying documents. It indicates points which are of particular importance in the operation of the device.
- The warranty does not cover damage resulting from the use of accessories and consumables from other manufacturers.
- On request GE Marquette will provide a service manual.
- The GE Marquette quality management system complies with the standards EN ISO 9001 and EN 46001.



Discount
CARDIOLOGY
www.discountcardiology.com

1	INTENDED USE AND FUNCTIONAL DESCRIPTION	9
2	CONTROLS AND INDICATORS	10
3	PUTTING THE DEVICE INTO OPERATION AND PERFORMANCE TEST	12
3.1	SAFETY INFORMATION	12
3.2	POWER SUPPLY	16
3.3	INSTALLATION AND MAINS CONNECTION	17
3.4	PERFORMANCE CHECK	17
3.5	GENERAL DEVICE SETTINGS	18
3.6	CONNECTING EXTERNAL DEVICES	19
4	PREPARATIONS FOR ECG RECORDING	20
4.1	CONNECTING THE PATIENT CABLE	20
4.2	APPLYING THE ELECTRODES	21
4.3	ARTIFACT DUE TO POOR ELECTRODE APPLICATION	23
4.4	ENTERING PATIENT DATA	24
5	RECORDING IN 12 LEAD MODE	26
5.1	SOME BASIC FACTS	26
5.2	RECORDING	27
5.3	THE MEMORY FUNCTION	29
5.4	THE REPORT FORMATS	31
5.5	ECG TRANSMISSION	32
5.6	BRIEF OPERATING INSTRUCTIONS - 12 LEAD MODE	38
6	RECORDING IN 6 LEAD MODE	39
6.1	SOME BASIC FACTS	39
6.2	RECORDING	39
6.3	BRIEF OPERATING INSTRUCTIONS - 6 LEAD MODE	41
7	ARRHYTHMIA MODE	42
7.1	SOME BASIC FACTS	42
7.2	RECORDING	43
7.3	BRIEF OPERATING INSTRUCTIONS - ARRHYTHMIA MODE	45

8	ECGS OF PACEMAKER PATIENTS / ECG RECORDING DURING DEFIBRILLATION	46
8.1	RECORDING ECGS OF PACEMAKER PATIENTS	46
8.2	ECG RECORDING DURING DEFIBRILLATION	46
9	SYSTEM SETUP	47
9.1	SOME BASIC FACTS	47
9.2	12 LEAD MODE	47
9.3	6 LEAD MODE	49
9.4	ARRHYTHMIA MODE	50
9.5	GENERAL DEVICE SETTINGS	51
9.6	COMMUNICATION	52
9.7	PATIENT DATA	53
9.8	OPTION CODE	54
9.9	ECG TRANSMISSION VIA MODEM	54
9.10	DIRECT ECG TRANSMISSION	55
10	LOADING CHART PAPER	56
11	CLEANING, DISINFECTION AND MAINTENANCE	58
11.1	CLEANING AND DISINFECTING THE RECORDER HOUSING	58
11.2	CLEANING AND DISINFECTING THE PATIENT CABLE	58
11.3	CLEANING AND DISINFECTING THE ELECTRODES	58
11.4	MAINTENANCE	59
12	TROUBLESHOOTING	60
13	TECHNICAL SPECIFICATIONS	62
<u>APPENDIX</u>		
	ENTERING SPECIAL CHARACTERS	67
	INDEX	68

1 Intended Use and Functional Description

The MAC 1200 is an ECG acquisition and recording system designed and manufactured by GE Marquette Medical Systems.

- It is intended to be used for resting ECG recording and realtime ECG recording with or without arrhythmia detection.
- It is not intended for use as a vital signs physiological monitor.
- The arrhythmia detection portion of the MAC 1200 is provided to the customer for the convenience of automatic documentation. It is not designed to provide alarms for arrhythmia detection.
- The MAC 1200 offers no diagnostic opinion to the user. Instead it provides analytical statements when configured with the appropriate options.
- It is intended to be used by trained operators under direct physician supervision when ECG records are required.
- It is not suitable for intracardiac application.
- It is designed for continuous operation.
- It is not intended for home use.
- The MAC 1200 is designed as a portable device and can easily be moved from one patient to another or to different locations. It is not intended to be used during patient transport.

Equipped with the standard software, the MAC 1200 supports the following operating modes:

- 12 Lead Mode (acquisition of 12 leads of ECG for a period of 10 seconds),
- 6 Lead Mode (real-time recording of 6 ECG leads), and
- Arrhythmia Mode (continuous ECG analysis for arrhythmias).

The graphics display shows 3 leads at a time.

Resting ECGs can be transferred to the MUSE CV Information System via the RS232 interface.

The device operates from both AC and DC (rechargeable batteries) power sources.

The unit's performance features can be upgraded with the following optional programs:

- MEAS - measurement (measurement of the 10-second resting ECG)
- DIAG - interpretation (interpretation of the 10-second resting ECG)
- MEMO - memory (storage of a maximum of 40 10-second resting ECGs)
- C100 - activates the three options MEAS, DIAG, MEMO for a maximum of 100 ECGs
- C500 - activates the three options MEAS, DIAG, MEMO for a maximum of 500 ECGs
- EVAL - activates the three options MEAS, DIAG, MEMO for a period of 4 weeks

The MAC 1200 resting ECG analysis system has a setup menu to customize the system parameters.

Patient and user data can be entered for reliable and safe archiving of patient records. The patient name is annotated on each printed report page. All other data is printed on request.

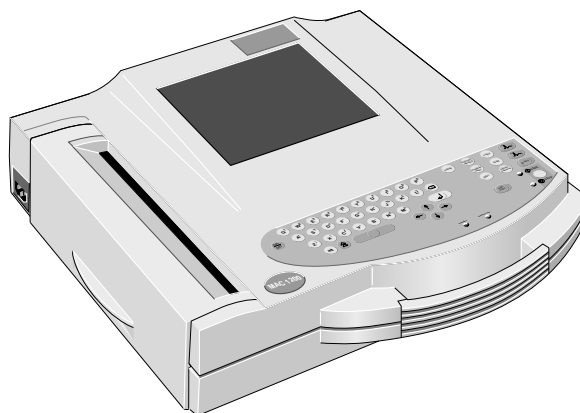

Figure 1-1. MAC 1200

2 Controls and Indicators

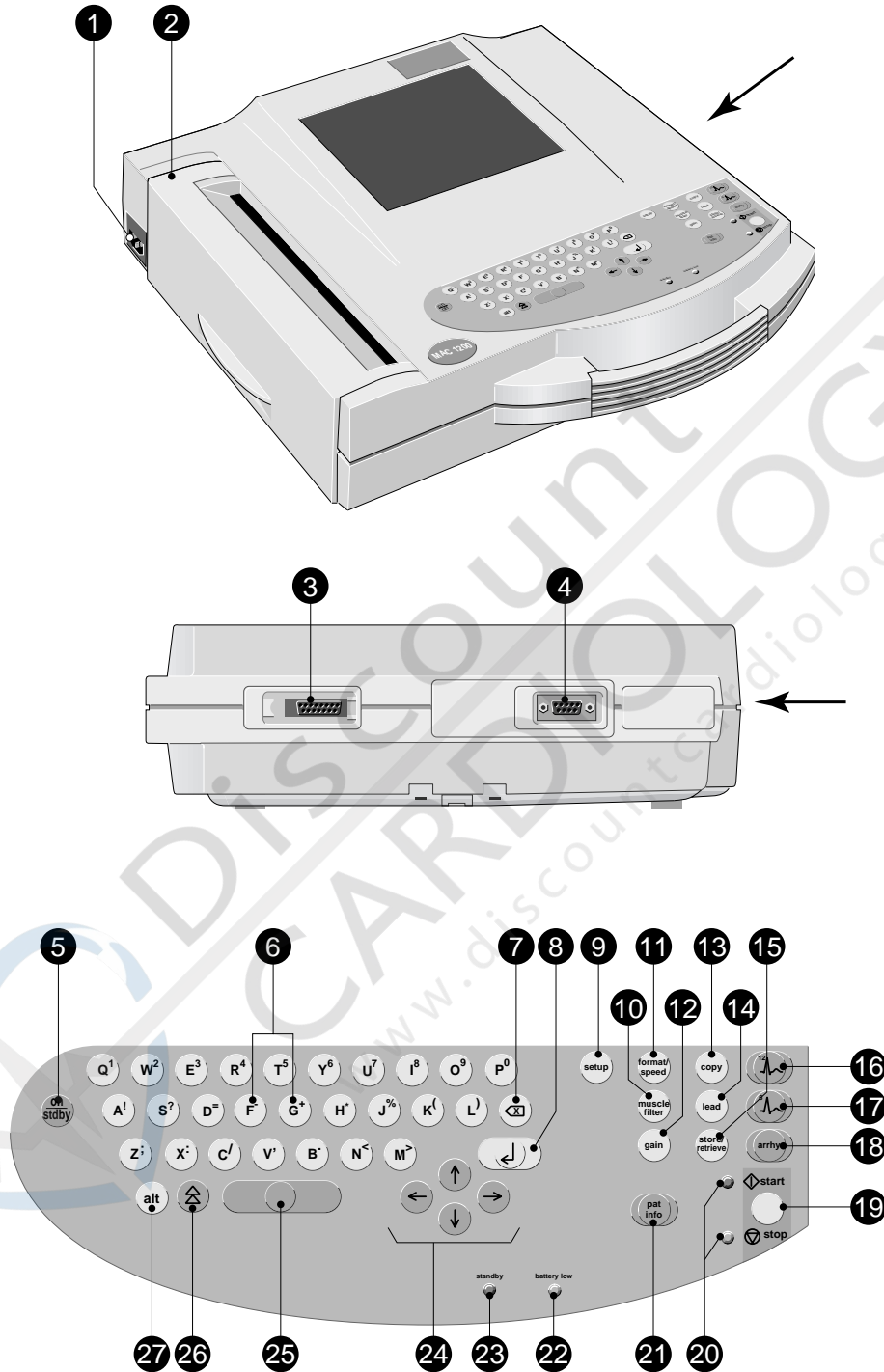

Figure 2-1. Controls and indicators of the MAC 1200 resting ECG analysis system

- | | |
|---|---|
| <p>1 Power input</p> <p>2 Paper door, windows allows you to check the paper supply</p> <p>3 Patient cable connector</p> <p>4 Serial interface (see chapter 13 "Technical Specifications")</p> <p>5 Power switch (ON/STANDBY)</p> <p>6 Keys to select a higher or lower HR alarm limit</p> <p>7 Backspace key (to correct entered data)</p> <p>8 Confirms entered data (Enter)</p> <p>9 Displays the setup menu</p> <p>10 Enables/disables the muscle filter (elimination of muscle artifact)</p> <p>11 Selects the writer speed (25, 50, 5 mm/s) in 6 Lead Mode and the report formats in 12 Lead Mode</p> <p>12 Selects the gain (5, 10, 20, 40 mm/mV)</p> <p>13 Press to print the report or additional copies of the ECG, or to send/receive ECGs</p> | <p>14 Selects the ECG lead in 6 Lead Mode (in 12 Lead Mode, on the display only)</p> <p>15 Sends ECG to memory/retrieves ECG from memory</p> <p>16 Selects the 12 Lead Mode</p> <p>17 Selects the 6 Lead Mode</p> <p>18 Selects the Arrhythmia Mode</p> <p>19 Starts/stops the selected operating mode, exits the setup menu and patient data entry</p> <p>20 Indicators, green: selected mode started, amber: selected mode stopped</p> <p>21 Enables entry of patient data</p> <p>22 Indicator is illuminated when battery needs to be charged</p> <p>23 Indicator is illuminated when unit is connected to the power line</p> <p>24 Cursor control keys</p> <p>25 Space bar</p> <p>26 Shift key</p> <p>27 Press to access special characters</p> |
|---|---|

Explanation of symbols used on the device



Consult accompanying documents



Signal input



Type CF signal input, highly insulated, defibrillation-proof



Start



Stop

3 Putting the Device into Operation and Performance Test

3.1 Safety Information

- This manual is an integral part of the device. It should always be kept near the device. Close observance of the information given in the manual is a prerequisite for proper device performance and correct operation and ensures patient and operator safety. **Please note that information pertinent to several chapters is given only once. Therefore, carefully read the manual once in its entirety.**
- Patient safety, the specified measuring accuracy, and interference-free operation can be guaranteed only if original GE Marquette components are used. The user is responsible for application of accessories from other manufacturers.
- This manual is in conformity with the device specifications and standards on safety of electro-medical equipment valid at the time of printing. All rights are reserved for devices, circuits, techniques, software programs, and names appearing in this manual.
- The terms danger, warning, and caution are used throughout this manual to point out hazards and to designate a degree or level of seriousness. Hazard is defined as a source of potential injury to a person.

Danger

indicates an imminently hazardous situation which, if not avoided WILL result in death or serious injury.

Warning

indicates a potentially hazardous situation which, if not avoided, COULD result in death or serious injury.

Caution

indicates a potentially hazardous situation which, if not avoided, may result in minor or moderate injury or product/property damage.

- GE Marquette is responsible for the effects on safety, reliability, and performance of the device, only if
 - assembly operations, extensions, readjustments, modifications, or repairs are carried out by persons authorized by GE Marquette,
 - the electrical installation of the relevant room complies with the requirements of the appropriate regulations, and
 - the device is used in accordance with the instructions for use.

The safety statements presented in this chapter refer to the equipment in general and, in most cases, apply to all aspects of the device. There are additional safety statements in the other chapters which are specific to the topic described. The order in which safety statements are presented in no way implies order of importance.

DANGERS

EXPLOSION HAZARD — Do not use this equipment in the presence of flammable anesthetics, vapors or liquids.

WARNINGS

ACCESSORIES (SUPPLIES) — Use only the original GE Marquette cables. Do not connect other signal sources to the cables. The user is responsible for the use of accessories from other manufacturers.

ACCIDENTAL SPILLS — To avoid electric shock or device malfunction liquids must not be allowed to enter the device. If liquids have entered a device, take it out of service and have it checked by a service technician before it is used again.

BEFORE USE — Before putting the system into operation visually inspect all connecting cables for signs of damage. Damaged cables and connectors must be replaced immediately.

BEFORE USE — Before using the device, the operator must verify that it is in correct working order and operating condition. For instructions, refer to section 3.2.2 “Performance Check” in this chapter.

CONDUCTIVE CONNECTIONS — Do not allow electrodes to come into contact with conductive parts. The neutral electrode, in particular, must not be connected to earth.

DISCONNECTION FROM MAINS — When disconnecting the system from the power line, remove the plug from the wall outlet first. Then you may disconnect the power cord from the device.

MOISTURE CONDENSATION — Devices intended for emergency application must not be stored or transported at temperatures which cause moisture condensation at the application site. Wait until all moisture condensation has evaporated before using the device.

MPSO—The use of a multiple portable socket outlet (MPSO) for a system will result in an enclosure leakage current equal to the sum of all individual earth leakage currents of the system if there is an interruption of the MPSO protective earth conductor. Do not use an additional extension cable with the MPSO as it will increase the chance of the single protective earth conductor interruption.

OPERATOR — The user must have received adequate training in the use of the MAC 1200 and must be capable of applying it properly.

POWER SUPPLY — The device must be connected to a properly installed power outlet with protective earth contacts only. If the installation does not provide for a protective earth conductor, disconnect the monitor from the power line and operate it on battery power, if possible.

If the installation of this equipment in the USA will use 240V rather than 120V, the source must be a center-tapped, 240V, single phase circuit.

CAUTIONS

MAINTENANCE — Regular preventive maintenance should be carried out annually, inspections of equipment with measuring functions should be done every two years (refer to chapter 11 “Cleaning, Disinfection and Maintenance”).

PERFORMANCE CHECKS — Check the device performance once a month, strictly following the instructions outlined in section 3.2.2 “Performance Check”.

POWER REQUIREMENTS — Before connecting the device to the power line, check that the voltage and frequency ratings of the power line are the same as those indicated on the unit’s label. If this is not the case, do not connect the system to the power line until you adjust the unit to match the power source.

VENTILATION REQUIREMENTS — Set up the device in a location which affords sufficient ventilation. The ventilation openings of the device must not be obstructed. The ambient conditions specified in the technical specifications must be ensured at all times.

DEFIBRILLATOR PRECAUTIONS — Patient signal inputs labeled with the CF and BF symbols with paddles are protected against damage resulting from defibrillation voltages. To ensure proper defibrillator protection, use only the recommended cables and leadwires. Proper placement of defibrillator paddles in relation to the electrodes is required to ensure successful defibrillation.

DISPOSAL — Dispose of the packaging material, observing the applicable waste control regulations and keeping it out of children’s reach.

ELECTROCAUTERY PRECAUTIONS — To prevent unwanted skin burns, apply electrocautery electrodes as far as possible from all other electrodes, a distance of at least 15 cm/ 6 in. is recommended.

EMC — Magnetic and electrical fields are capable of interfering with the proper performance of the device. For this reason make sure that all external devices operated in the vicinity of the monitor comply with the relevant EMC requirements. X-ray equipment or MRI devices are a possible source of interference as they may emit higher levels of electromagnetic radiation.

INTERFACING OTHER EQUIPMENT — Devices may only be interconnected with each other or to parts of the system when it has been determined by qualified biomedical engineering personnel that there is no danger to the patient, the operator, or the environment as a result. In those instances where there is any element of doubt concerning the safety of connected devices, the user must contact the manufacturers concerned (or other informed experts) for proper use. In all cases, safe and proper operation should be verified with the applicable manufacturer’s instructions for use, and system standards IEC 60601-1-1/EN 60601-1-1 must be complied with.

NOTES

- The MAC 1200 is designed to comply with IEC 60601/ EN 60601 requirements. It is Class I equipment/equipment with a built-in rechargeable electrical power source. The device is not suitable for intracardiac use. The device is suitable for continuous operation.
- Choose a location which affords an unobstructed view of the monitor's screen and easy access to the operating controls.
- The MAC 1200 has no additional protection against ingress of water.
- Medical technical equipment such as the MAC 1200 must only be used by persons who have received adequate training in the use of such equipment and who are capable of applying it properly.
- At the end of its service life; the MAC 1200 and its accessories must be disposed of in compliance with the special waste control regulations for electronic parts. If you have any questions in this matter, please contact GE Marquette Medical Systems.

Literature

Medical Device Directive 93/42/EEC

EN 60601-1/1990 + A1: 1993 + A2: 1995: Medical electrical equipment. General requirements for safety

EN 60601-1-1/9.1994 + A1 12.95: General requirements for safety. Requirements for the safety of medical electrical systems. Requirements for the safety of medical electrical systems.

EN 60601-2-25/1993: Medical electrical equipment. Part 2: Special requirements for the safety of electrocardiographs.

IEC Publication 513/1994: Fundamental aspects of safety standards for medical equipment.

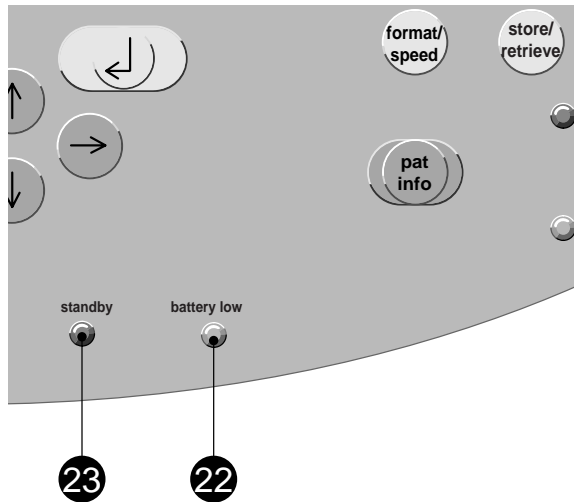

Figure 3-1. Indicators

3.2 Power Supply

The units are powered from the power line or from the rechargeable battery.

The battery charges automatically when the unit is connected to the power line and the **standby** indicator **23** is illuminated (Figure 3-1). It is not necessary to switch on the device for charging. To ensure that the battery is always fully charged, leave the MAC 1200 resting ECG analysis system connected to the power line whenever possible. After 4 hours the battery has regained its full capacity.

The **battery low** indicator **22** is illuminated when battery needs to be charged.

With a full battery, about 50 ECGs (1 page) can be recorded in 12 Lead Mode. When its capacity drops to about 25 recordings, the battery is used up and must be replaced by a service specialist.

Note

To prolong the battery life, discharge the battery at least once per month (by operating the resting ECG analysis system on battery power).

Note

In standby mode, a fully charged battery is drained within approx. 4 hours. Therefore, when operating the device on battery power, be sure to turn it off when it is not in use.

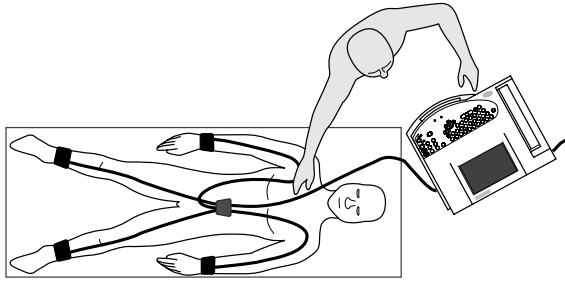

Figure 3-2. Arranging device and couch

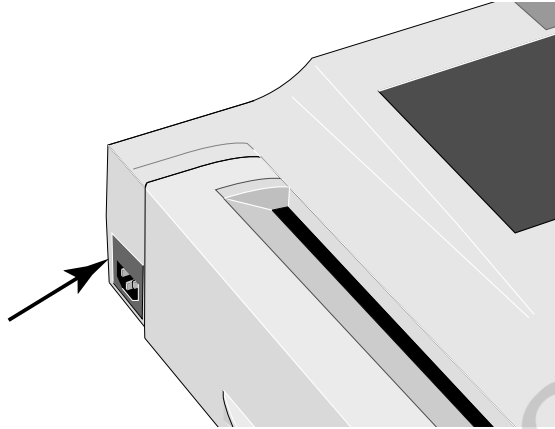

Figure 3-3. AC power input



Figure 3-4. Power switch

Note

- When turning off the MAC 1200 (standby mode), be sure to press the power switch long enough.
- The backlighting of the display switches off automatically when no key is activated for 5 minutes (adjustable).
- Run the full self-test at least once a day to ensure that the device is functioning properly.

3.3 Installation and Mains Connection

Figure 3-2 shows a practical arrangement of patient and recorder. For interference-free operation, it is important that the patient cable and the power cord do not run parallel.

- Using the power cord, connect the device to the power line (Figure –3-1). Use only the original power cord or an equivalent cable.

The **standby** indicator **23** will illuminate.

- Check the paper supply (the window in the paper door allows you to look inside the compartment). If it is necessary to insert a new paper pad, refer to chapter 10 for instructions.

3.4 Performance Check



- Press the power switch to switch on the device (Figure 3-4).

The amber **stop** indicator  **20** will illuminate.

After power-up, the resting ECG analysis system runs an automatic self-test. When no problem is detected, it defaults to the 12 Lead Mode. If a malfunction is identified, the display will show an error message “Error...”. In this situation, notify service to check and repair the device.

The self-test can be aborted with the  button. In this case, the device immediately activates the 12 Lead Mode.

Contrast Adjustment

- To adjust the contrast, simultaneously press  and the appropriate cursor key:
 for more contrast,  for less contrast.

3.5 General Device Settings

The table at left shows the general device settings that can be modified and the system defaults. For instructions on changing the device setup, refer to section 9.5 "General Device Settings".

Parameter	System Defaults	Options
Ordering Physician	empty text box	selection from a list of 10 names
Referring Physician	empty text box	selection from a list of 10 names
Technician	empty text box	selection from a list of 10 names
Institution Name	empty text box	text box (40 chrs)
Cart #	1	1 to 9999
Site #	1	1 to 255
Location	1	1 to 600
Date (dd.mm.yyyy)	current date	
Time (hh:mm)	current time	
Lead Fail Beep	No	Yes
High HR Beep	No	Yes
Lead Labels	AAMI	IEC
Date	mm/dd/yyyy	dd.mm.yyyy
Time	12	24
Units	in, lb	cm, kg
Mains	60 Hz	50 Hz
LCD light off after	5 min	1 to 99 minutes
Default mode	12 Lead	6 Lead, Arrhythmia
Language	English	English, French, Spanish
Enable password	No	Yes
Test DATA	No	Yes
Restore defaults	No	Yes
Print setup lists	No	Yes

Warning

Shock Hazard — *Strictly observe the following warnings. Failure to do so may endanger the lives of the patient, the user and bystanders.*

- *Connecting peripheral devices to the RS232 interface of the resting ECG analysis system creates a medical system. This system must meet the requirements of IEC 60601-1-1.*
- *Use only the original Marquette Hellige connection cables.*
- *All non-medical devices of a system must be connected to the same electric circuit. Devices which are not connected to the same circuit must be electrically isolated (use isolated RS232 interface as per IEC 60601-1).*
- *A PC connected to the resting ECG analysis system should meet the requirements of EN 60601. If it doesn't, it must be set up outside the patient environment. If the PC fulfills the requirements of EN 60950, it must be set up within the medically used area, but outside the patient environment.*
- *Do not connect PCs to the resting ECG analysis system that fulfill neither EN 60601 nor EN 60950.*
- *Modems connected to the resting ECG analysis system must meet the requirements of EN 60950 or UL1950 (all modems recommended by Marquette Hellige meet these requirements). The specific regulations valid in your country must also be observed.
The modem must be set up within the medically used area, but outside the patient environment.*

3.6 Connecting External Devices

Via the serial interface, the resting ECG analysis system can be connected to a MUSE CV Information System. These external devices can be connected directly or via a modem. Please contact GE Marquette Application Support for details. Resting ECGs acquired in the 12 Lead Mode as well as the corresponding data can be transferred to these external devices (see section 5.5 "ECG Transmission").

The table below shows the system defaults and all possible adjustments.

For instructions on changing the default setup, refer to section 9.6 "Communication".

Parameter	System defaults	Options
<i>Choices for "Modem → Other"</i>		
		none user-defined MultiTech 19.32 MultiTech 56.6 Elsa 28.8 Elsa 33.6 Elsa 56.6
<i>Choices for "Modem → user-defined"</i>		
telephone init string dial string hangup	AT&FM0&D0 &Q1V0 ATDT +++ATH	
<i>Choices for "Modem → MultiTech 19.32, 56.6, ELSA 28.8, 33.6, 56.6"</i>		
dial mode phone outside line	tone	pulse 0 to 9 (28 digits) 0 to 9 (20 digits)

4 Preparations for ECG Recording

4.1 Connecting the Patient Cable

Use the 10-leadwire patient cable for acquisition of the 12 standard ECG leads.

- Connect the patient cable to connector **3** (Figure 4-1).

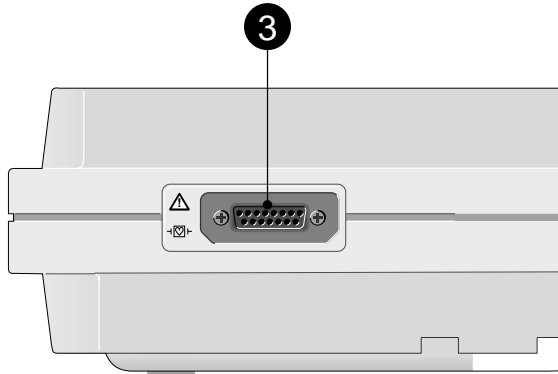

Figure 4-1. ECG signal input

Warning

Shock Hazard — *Strictly observe the following warnings. Failure to do so may endanger the lives of the patient, the user and bystanders.*

- *For reasons of patient safety, use only the original GE Marquette patient cable. Before connecting the cable to the device, check it for signs of mechanical damage. Do not use a damaged cable.*
- *Ensure that conductive parts (such as the patient, connectors, electrodes, transducers) that are connected to the isolated patient signal input do not come into contact with other grounded, conductive parts. This would bridge the patient's isolation and cancel the protection provided by the isolated input. The neutral electrode, in particular, must not come into contact with ground.*

Caution

Use only silver-silver chloride electrodes, if the patient may have to be defibrillated. (Refer to chapter 8 “ECG Recording during Defibrillation”.)

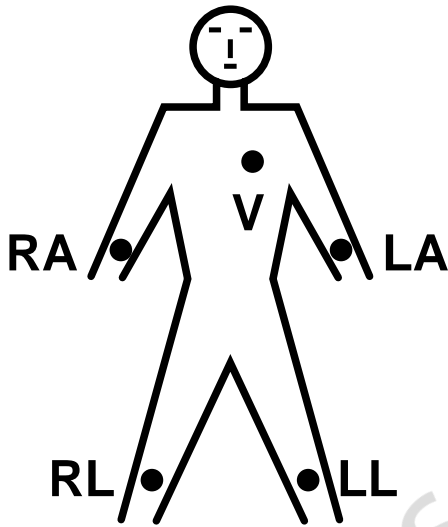

Figure 4-2. Applying limb-lead electrodes

4.2 Applying the Electrodes

Careful application of the electrodes and skin preparation is the key to an interference-free ECG.

4.2.1 Applying Electrodes (Limb Leads)

Refer to the illustration shown in Figure 4-2.

- | | |
|------------|------------------------|
| RA (white) | electrode on right arm |
| LA (black) | electrode on left arm |
| LL (red) | electrode on left leg |
| RL (green) | electrode on right leg |

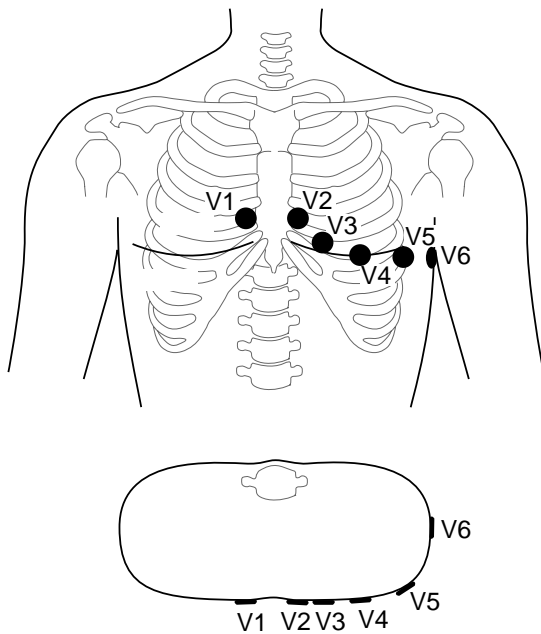

Figure 4-3. Chest electrode placement

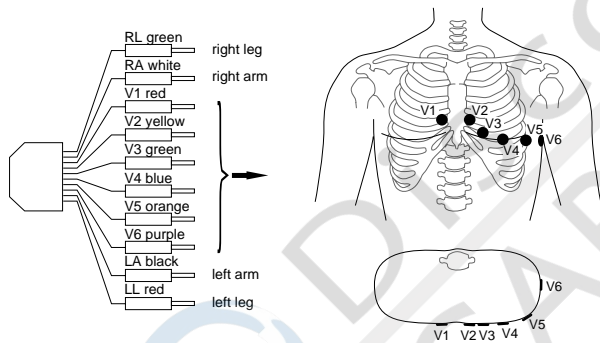

Figure 4-4. Connecting the patient cable
(10-lead cable, standard ECG leads)

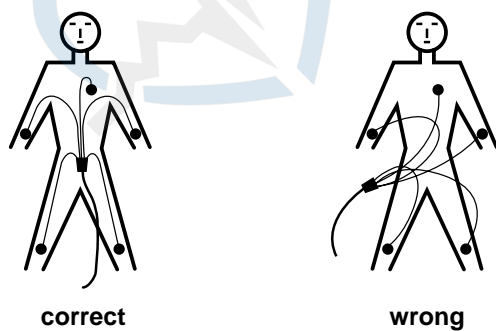

Figure 4-5. Arranging the patient cable

4.2.2 Applying Electrodes (Thorax)

- Shave application points, if necessary.

4.2.3 Electrode Placement for Standard Leads (I, II, III, aVR, aVL, aVF, VI...V6)

For acquisition of the standard ECG leads four electrodes must be applied on the limbs and six on the chest. The limb electrodes should be placed above the wrists and ankles. Figure 4-3 shows the chest electrode application points.

- V1 4th intercostal space at the right border of the sternum
- V2 4th intercostal space at the left border of the sternum
- V3 midway between locations V2 and V4
- V4 at the mid-clavicular line in the 5th intercostal space
- V5 at the anterior axillary line on the same horizontal level as V4 and V6
- V6 at the mid-axillary line on the same horizontal level as V4

- Connect the 10-lead patient cable as shown in Figure 4-4.

- Arrange the leadwires and patient cable as shown in Figure 4-5.

4.3 Artifact Due to Poor Electrode Application

The resting ECG analysis system is equipped with state-of-the-art electronic utilities that ensure artifact-free recordings. Among these are the automatic baseline adjustment and the anti-drift system (cubic spline) (ADS).

At the beginning of the recording the automatic baseline adjustment algorithm verifies the incoming signal and adjusts the baseline position accordingly.

During the recording, the anti-drift system (cubic spline) continuously checks the baseline position and returns it to the normal level, if required (Figure 4-6).

For the 6 Lead Mode, the anti-drift system (cubic spline) can be enabled and disabled from the setup menu, in the 12 Lead and Arrhythmia Modes, it is **always** enabled.

When electrodes are not properly applied, these measures may not fully compensate for artifact. High polarization voltages induced by electrodes applied without conductive gel may cause the amplifier to overrange, so that a straight line will be recorded instead of the ECG (see Figure 4-6). The device will then automatically block and return the baseline to its normal position. A baseline is then recorded for approx. 1 second. It is possible to block the amplifiers manually by disconnecting the RL electrode.

On the display this condition is indicated by **** instead of the electrode label (e.g. at **i**, Figure 5-1).

Remedy

- Apply the electrodes according to instructions.
- Do not apply the electrodes on top of clothing.
- Use a contact agent with reusable electrodes (e.g. moistened electrode paper, electrode cream, spray, etc.).
- Wait approx. 10 seconds before initiating a recording. After the 10-second period, the automatic functions are enabled and the polarization voltages have stabilized, provided the electrodes are properly applied. In case of improper electrode application, an error message will appear on the display (RL, LL, LA, LL, V1 to V6).
- If required, the ADS (cubic spline) and the filters (20/40 Hz, 60 Hz) can be disabled to verify the “raw” ECG signal.

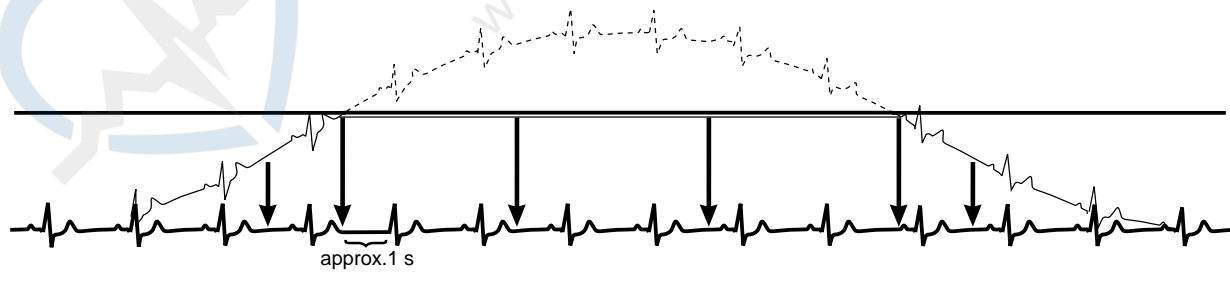



Figure 4-6. Sample recording







Parameter	Factory Default		Options
	adjusted	Menu item displayed	
New Patient	No	Yes	Yes
Last Name		Yes	
First Name		Yes	
Date of Birth	00.00.0000 (mm.dd.yy yy)	Yes	
Patient ID		Yes	
Secondary ID		No	
Pacemaker	No	Yes	Yes
Gender	-	Yes	female, male
Height		No	
Weight		No	
Race	unknown	Yes	other
Systolic BP	0 mmHg	No	
Diastolic BP	0 mmHg	No	
Ordering physician		Yes	selection from a list of 10 names
Referring physician		No	selection from a list of 10 names
Technician ID		Yes	selection from a list of 10 names
Telephone		Yes	
Medication		No	
1.	unknown	No	other
2.	unknown	No	other
Comments		No	
Location #		No	1 to 600
Room		No	
Order Number		No	
Prompt 1		No	
Prompt 2		No	
Prompt 3		No	
Prompt 4		No	

Table 4-1. Patient data entry menu

4.4 Entering Patient Data

It is possible to enter patient data and have them annotated on the recording for easy archiving of patient records.

- Press  to enter the patient data mode.
 - The recorder displays the menu items in a defined order.

In the patient data setup menu (section 9.7 "Patient Data") you determine the items to be included in the menu (In the table at left, the items that appear in the patient data menu in the default setup are marked as "Yes" in the "Menu item displayed" column, the other menu items are marked as "No").
 - To skip a menu item, press  or the cursor key  or .
 - It is not possible to write capital and small letters (do not use the Shift key).
 - For entry of numbers (e.g. date of birth), it is not necessary to press the Shift key.
 - All entries must be confirmed with .
 - Press  or  or  to exit the patient data mode.

The table at left shows the menu items in the correct order. On the display, selected options are shown in brackets. Refer to section 9.7 for details on setting up the patient data menu.

Note

Please refer to the Appendix for instructions on entering special characters.

New patient

yes: existing patient data are deleted

no: entered data can be edited

Last Name / First Name

Enter the patient's last and first names (18 characters maximum each) and confirm entries with .

Date of birth

The slash key  must be entered between month/day/year.

Patient ID / Secondary ID

16 characters maximum each

Pacemaker

Influences the identification of pacer pulses in Arrhythmia Mode. Enable the function ("Yes") when recording the ECG of a pacemaker patient. The recording will then be annotated with the message "Pacemaker Patient".

Gender/Race

If you do not intend to enter all demographic data, select the neutral entries "-" and "unknown".

Height/Weight

Enter the patient's height (in inches) and weight (in pounds). The weight can be entered with one decimal place.

Systolic BP/Diastolic BP



Enter the blood pressure readings in mmHg.

Phone No.

Enter the patient's telephone number.

Ordering Physician / Referring Physician / Technician

When you choose "yes" for "New patient", the default names entered in the General Settings will appear here. When you choose "other", you can pick a name from the list. It is also possible to choose "no".

You can exit the menu with  .

The "Referring Physician" is only relevant if you send ECGs to the MUSE CV Information System. This name will not be annotated on the ECG recording.

Medication

Enter the patient's medications and confirm entries with .

Comments

4 lines of 30 characters each

Location #

ID number of the sending system (3 digits). The default value entered in System Setup will be used, but this value can be changed.

Room

Enter the hospital room number (5 characters maximum).

Order number

Enter order number of the ECG recording, if available (5 characters maximum).

Prompts



Answer the prompts entered in the patient data setup menu (section 9.7).

5 Recording in 12 Lead Mode

Note

Please bear in mind that no automated analysis of ECG signals is completely reliable. Therefore a physician should always overread and reassess the system interpretation before performing patient diagnosis.

5.1 Some Basic Facts

In 12 Lead Mode, 12 leads of ECG are acquired simultaneously for a period of 10 seconds. When initiated with  , ECG acquisition and recording proceed automatically. The system, however, may be set up to start recording only when specific patient data (ID, Secondary ID, name) have been entered (see section 9.7 "Patient Data").

Depending on the implemented software options, the ECG

- is only printed out (options MEAS - measurement -, DIAG - interpretation - not implemented)
- is measured and printed out with the measurement results (with option MEAS - measurement)
- is measured, interpreted (analyzed) and printed out with the interpretative statements (with option DIAG - interpretation)

Units equipped with the optional "Memory" function can save up to 40 resting ECG. These ECGs can be

- printed or
- sent to the MUSE CV Information System (CSI protocol) (see section 5.3 "The Memory Function").

The unit offers different report formats for printout of the ECG. With the system defaults, all 12 leads including the measurement and analysis results will be documented on a single page (see section 5.4 "The Report Formats").



Several system settings can be customized. In this manual they are labeled "configurable".

The following information refers to a unit with the system defaults (see table below). For instructions on changing the system setup, refer to section 9.2 "12 Lead Mode".

Parameter	System defaults	Options
Report sequence	STANDARD	CABRERA
Rhythm leads	II, V1, V5	I, III, aVR, aVL, aVF, V2, V3, V4, V6
Gain	10 mm/mV	"*auto", 5, 20, 40 mm/mV
Report format	4x2.5R1	1x10R12, 2x5R1, 2x5_50, 4x2.5R1, 1x10R3, 4x2.5R3
Detailed results	No	Yes
Muscle filter	No	Yes
Frequency	40 Hz	20 Hz
AC line filter	Yes	No
Manual copy to	EKG	HOST
No. of copies	1	0 to 9
Delete ECG after transm.	No	Yes
Auto save ECG	No	Yes
Use screen. crit.	No	Yes
Suppr. normal st.	No	Yes
Suppr. abnormal st.	No	Yes
Interpretation	Yes	No
Print interpretation	Yes	No
Override function	Yes	No



5.2 Recording

On power up, the unit defaults to the 12 Lead Mode (system defaults) (configurable).

- Before recording the ECG, patient data can be entered (). We recommend to enter the patient's name to annotate it on every report.
- After applying the electrodes, please wait about 10 seconds for the signal to stabilize (stabilization of polarization voltages, see section 4.3 "Artifact Due to Poor Electrode Application"). If you initiate a recording with   immediately after selection of the 12 Lead Mode, a waiting period of 10 to 12 seconds ensues (message "Collecting data").
- Before initiating a recording, check the display for error messages (see table at left). Check all electrodes; if the message persists, there must be a break in the patient cable. Replace the cable with a new one.
- The MAC 1200 continuously saves 10 seconds of the incoming ECG signal.
- The device can be set up to allow a recording only when specific patient data have been entered (last name, first name, ID, 2nd ID, section 9.7 "Patient Data").

<p>*RL*: <i>right leg electrode disconnected</i></p> <p>*RA*: <i>right arm electrode disconnected</i></p> <p>*LA*: <i>left arm electrode disconnected</i></p> <p>*LL*: <i>left leg electrode disconnected</i></p> <p>*V1*: <i>chest electrode V1 disconnected</i></p> <p>*V2*: <i>chest electrode V2 disconnected</i></p> <p>*V3*: <i>chest electrode V3 disconnected</i></p> <p>*V4*: <i>chest electrode V4 disconnected</i></p> <p>*V5*: <i>chest electrode V5 disconnected</i></p> <p>*V6*: <i>chest electrode V6 disconnected</i></p>

Messages indicating disconnected electrodes

When you initiate a recording with  , the unit prints the most recent 10 seconds of ECG data and analyzes it. Therefore it is recommended to wait until the patient has been lying relaxed and motionless for about 10 seconds before starting the recording.

Note

Please note that filters may suppress diagnostically relevant portions of the signal, because they limit the transmission range. Filters should therefore only be enabled if necessary.

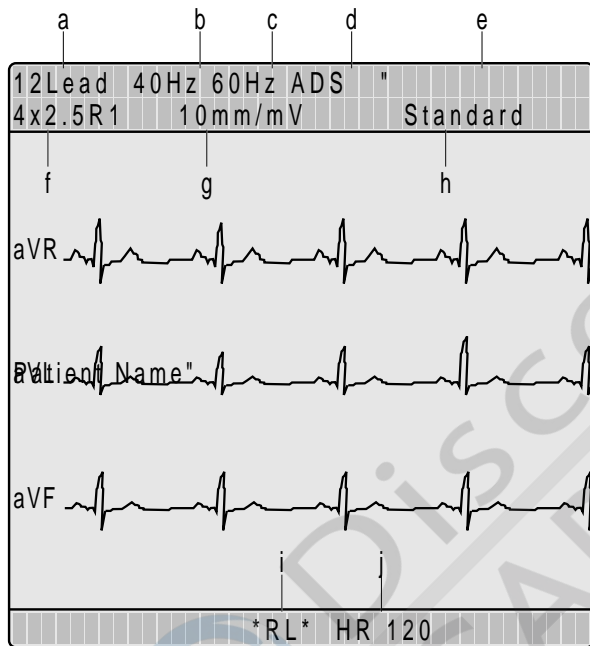

Figure 5-1. 12 Lead mode display

- a** Operating mode
- b** Muscle filter enabled
- c** AC line filter enabled
- d** Anti-drift system enabled
- e** Patient name
- f** Report format or "REC OFF" when no recordings are made
- g** Gain 10 mm/mV (automatic gain adjustment off)
- h** Report sequence
- i** Right leg electrode failure message
- j** Heart rate

With the system defaults unchanged, the unit will activate the following functions and settings after power-up:



- the 12 Lead Mode (configurable)
- the Standard report sequence: I, II, III, aVR, aVL, aVF, VI, V2, V3, V4, V5, V6
- rhythm leads II, V1 and V5 (configurable)
- a gain of 10 mm/mV (configurable) (calibration pulse at the beginning of the recording)
- the AC line filter is on (configurable)
- the muscle filter is off (^{muscle}filter) (configurable)
- the anti-drift system (cubic spline) is enabled (wandering baselines are automatically restored to their original position)
- the report format is "4x2.5R1", i.e. 12 leads and all data are printed on one page (configurable)
- the "Detailed results" page (including the median complexes and the ST measurement results) is not printed (configurable)
- pressing ^{copy} will print one copy of the ECG (configurable)
- units with MEMO option: documented ECGs are not automatically saved (configurable)
- units with MEMO option: after transmission to a host system via the RS232 interface, the ECGs remain stored in the MAC 1200 memory (configurable)
- the "Override Function" is enabled (configurable)
- QTC is calculated with the Bazett formula (only with option MEAS (measurement) or DIAG (interpretation))

All relevant device settings are shown on the display (Figure 5-1).

The display shows 3 leads at a time. With ^{lead} you can successively display all leads of the report sequence in groups of 3.

- The recording can be stopped with .
- For a description of the different reports, refer to section 5.4 "The Report Formats".

Note

When the unit runs out of paper while printing all stored ECGs (menu item "All stored ECGs - Print"), press   after inserting a new paper pad. Then print the remaining ECGs successively, or restart a printout of all recordings (All stored ECGs - Print).

Memory Program			
All stored ECGs	[Print]	Send	Delete
1	2	3	5
ECG Recording of Walker, John	4	5	(S)
6	Print	Send	Delete
ECG Recording of Doe, John	Print	Send	Delete
ECG Recording of Doe, Jane	Print	Send	Delete
ECG Recording of Walker, Jane	Print	Send	Delete
			Change
			Change
			Change

Figure 5-2. ECG identified by patient name



- 1 All stored ECGs will be printed
- 2 All stored ECGs will be transmitted
- 3 All stored ECG will be deleted
- 4 All transmitted ECGs will be deleted
- 5 ECG has been sent (S)
- 6 John Walker's ECG will be printed
- 7 Select to edit the patient data

Note

With a fully charged battery and the unit turned off, ECGs will remain stored for approx. 4 weeks.

5.3 The Memory Function

Units equipped with the optional MEMO function permit storage of the ECG including patient, measurement and interpretation data with . A message informs the user that ECGs are being saved and indicates the number of stored ECGs (40 max.).

To retrieve an ECG from memory, hold down  and press .

You will see the memory program as shown in Figure 5-2.

The first line refers to all stored ECGs. The Print, Send, and Delete commands following this line will therefore print, send or delete all stored ECGs.

With the command in the line below all ECGs that have been transmitted to another system can be deleted.

The individual ECGs (either identified by name or, if the patient name was not entered, by date and time) follow.

The cursor is positioned at "All stored ECGs [Print]" **1**, which means that all stored ECGs will be printed when you press the .

To transmit or delete **all stored** ECGs, position the cursor on "Send" **2** or "Delete" **3** and confirm the command with .



To delete **all sent** ECGs (identified with the letter "S" **5**), position the cursor on field **4** and confirm the command with .

To print, transmit or delete an individual ECG or change the corresponding patient data, position the cursor in the appropriate field (e.g. **6** [Print] or **7** [Change]).

Memory full			
Delete Walker, John	[Yes]	No	
Delete Doe, John	Yes	No	
Delete Doe, Jane	Yes	No	



Figure 5-3. "Memory full" message

Note

- *If you intend to print a large number of stored ECGs, we recommend to connect the unit to the power line or to check that the battery is fully charged.*
- *When you terminate the memory function with  , it is not possible to save the current ECG again.*

If you try to save an ECG when the memory is full, you are informed of the memory status and can remove one of the stored ECGs from memory. Use the cursor keys to select the ECG to be deleted. After discarding the ECG, the unit will automatically save the new data (Figure 5-3).

The unit may be set up to automatically save ECGs (without pressing ) and to remove ECGs from memory that were successfully transmitted to a host system (MUSE) (see section 9.2 "12 Lead Mode").

The memory program can be terminated at any time with  .

5.4 The Report Formats

The length and scope of the reports depends on the implemented software (standard, MEAS (measurement), DIAG (interpretation)).

The table below shows all of the 12 different report formats available with the MAC 1200 units.

Format	ECG traces length/leads	Rhythm lead length/leads	Speed	Measurement*	Interpretation*	Pages
4x2.5R1 (default format)	4x2.5s/4x3	10 s/1	25 mm/s	yes	yes	1
4x2.5R3	4x2.5 s/4x3	3x10 s/3	25 mm/s	yes	yes	1
2x5R1	2x5 s/2x6	10 s/1	25 mm/s	yes	yes	1
2x5_50	2x5 s/2x6	no	50 mm/s	yes	yes	2
1x10R12	10 s/1x12	no	25 mm/s	no	no	1
1x10R3	10 s/1x3	10 s/3	25 mm/s	yes	yes	1

* measurement results and interpretative statements are only available from MAC 1200 with the appropriate software options

Note
<ul style="list-style-type: none"> - <i>The printed reports are unconfirmed documents. They must be overread, verified, and signed by a physician for confirmation.</i> - <i>The heart rate HR annotated on the report pages is calculated from all beats of the 10 second ECG.</i> - <i>To obtain a printout of the full patient data, select the 6 Lead Mode and press .</i>

Detailed results

In the setup menu of units equipped with the MEAS or DIAG option, you can choose the "Detailed results" page. When selected, this page will be appended to the reports. It contains patient data, measurement results (MEAS), interpretative statements (DIAG), medians and the tabular measurement values.

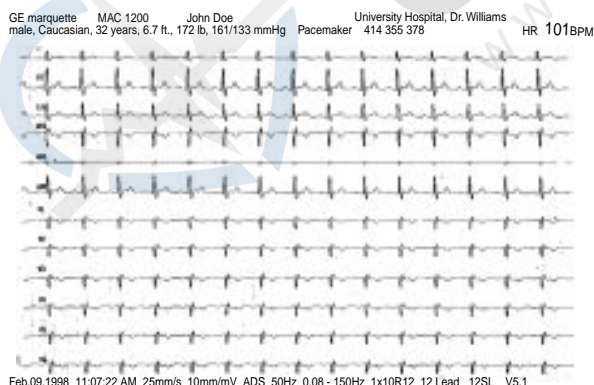

Figure 5-4. 1x10R12 report format

Note

Observe the safety information given in section 3.6 "Connecting External Devices".

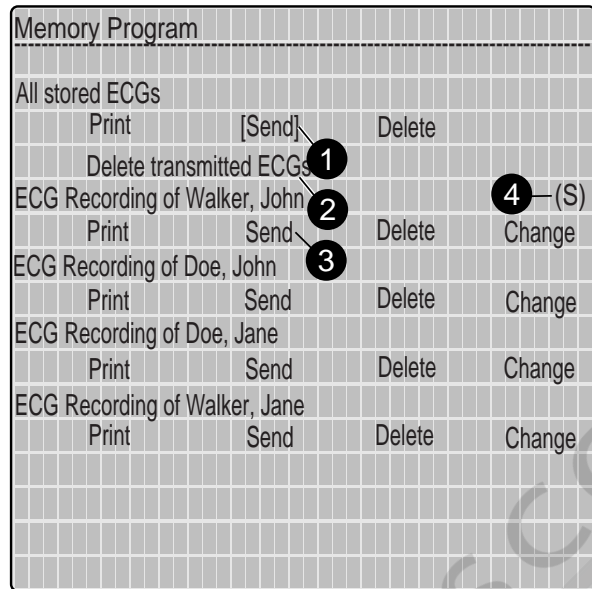

Figure 5-5. Memory program

- 1 All stored ECGs will be transmitted
- 2 All transmitted ECGs will be deleted
- 3 John Walker's ECG will be transmitted
- 4 ECG has been sent (S)

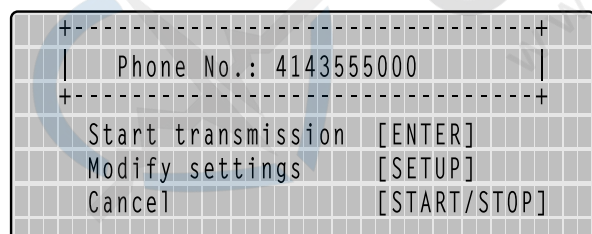

Figure 5-6. Transmission menu

5.5 ECG Transmission

Resting ECGs acquired in 12 Lead Mode can be transferred to host systems (e.g. to the MUSE CV Information System (version 004A or higher)). The units can either communicate via modem or directly via a connection cable (see section "Direct Transmission" below).

5.5.1 Transmission via Modem

Depending on the modem model used, the modem **must** be connected either with the 9-pole cable 223 378 01 or with the 25-pole cable 223 378 02.

For transmission of the ECG, the unit must be set up as described in section 9.9 "ECG Transmission via Modem".

After acquisition of the ECG, the transmission is initiated with (if "Manual copy" is set to "Host" in the setup menu - see section 9.2 "12 Lead Mode").

The recorder is also capable of transmitting stored ECGs (if MEMO option is installed). To retrieve ECGs from memory, hold down while pressing . You will see the memory menu (Figure 5-5).

- To transmit all stored ECGs in one pass, position the cursor on "All stored ECGs - Send" (1, Figure 5-5), to transmit individual ECGs, position the cursor on the "Send" command of that ECG (e.g. 3, Figure 5-5).

- Confirm the command with .

You will see the transmission menu as shown in Figure 5-6.

- Check the displayed telephone number and press to initiate the transfer.
- If it is necessary to change the number, press to display the setup menu.
- With and , the transmission can be stopped.
- ECGs that were successfully transmitted are identified with the letter "S" (for "Sent", 4, Figure 5-5).

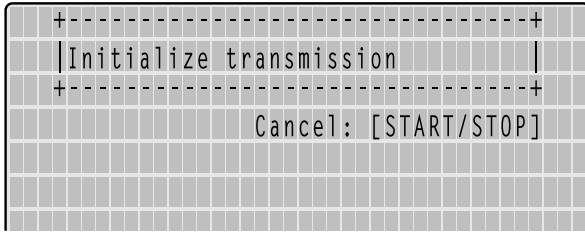

Figure 5-7. Initializing the transmission

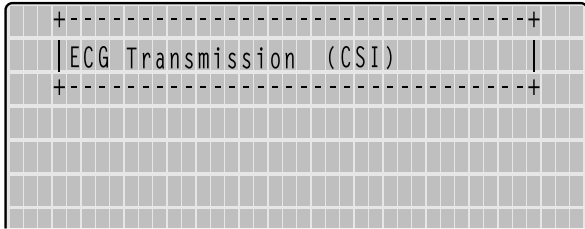

Figure 5-8. Display during ECG transfer

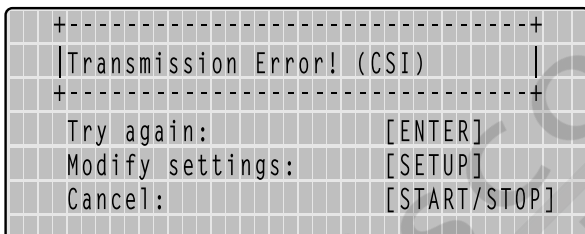



Figure 5-9. Error message





As soon as you initiate the transmission with , the unit will automatically dial the number of the modem at the receiving end and establish a connection (Figure 5-7). Then it will send the ECG (Figure 5-8).

After the transmission, a message on the display indicates the number of successfully transmitted ECGs. As soon as you acknowledge the message with , the 12 Lead Mode acquisition screen appears.

The system identifies ECGs that were successfully sent to the host system with the letter "S" (4, Figure 5-5). All of these ECGs can be deleted with the command "Delete transmitted ECGs" (2, Figure 5-5).

If it is not possible to transmit the ECG (wrong modem setup, modem off), the unit will display an error message, such as "Transmission error! (CSI)" (Figure 5-9).

In this situation you have the following choices:

- you can repeat the transmission with 
- you can change the settings with 
- you can stop the transmission with  .

Modem Error Messages	Cause
Transmission Error! (CSI)	The connection was interrupted due to a fault.
Check interface!	Fault in RS232 interface or modem. Modem may be switched off.
No dial tone!	No dial tone detected.
Busy!	Busy signal detected.
No answer!	No answer at remote end.
No carrier!	Carrier signal lost or not detected.
Check modem setup!	Modem configuration error.

Note

Pacemaker information, telephone number and comments entered in the patient data are not transmitted to MUSE.

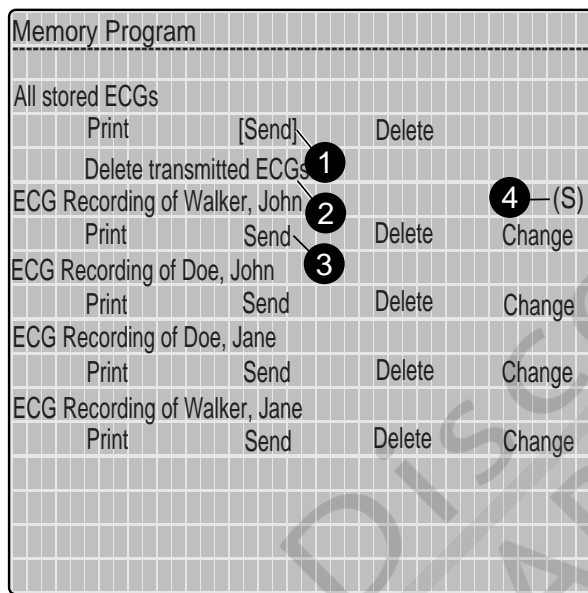

Figure 5-10. Memory program

- 1 All stored ECGs will be transmitted
- 2 All transmitted ECGs will be deleted
- 3 John Walker's ECG will be transmitted
- 4 ECG has been sent (S)

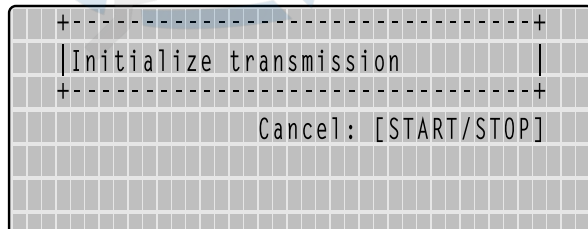

Figure 5-11. Initializing the transmission

5.5.2 Sending Data to a MUSE CV System via Modem

Before sending data to the MUSE CV system, the MAC 1200 automatically logs on to MUSE. Then the data will be transmitted. If the transmission is stopped, the MAC 1200 may take a few seconds before canceling the connection because it has to log off the MUSE system first. Then the communication link with the receiving modem is interrupted and the standard display reappears.



5.5.3 Direct Transmission

The unit must be connected to the PC or to the MUSE CV system by means of the connection cable 223 362 03.

For transmission of the ECG, the unit must be set up as described in section 9.10 "Direct ECG Transmission".

After acquisition of the ECG, the transmission is started with .

The MAC 1200 is also capable of transmitting stored ECGs (if Memory option MEMO is installed).

Activate the memory program by simultaneously pressing  and  (press the  button first and hold it depressed) (Figure 5-10).

- To transmit all stored ECGs in one pass, position the cursor on "All stored ECGs - Send" (1, Figure 5-10), to transmit only one ECG, position the cursor on the "Send" command of that ECG (e.g. 3, Figure 5-10).
- Confirm the command with .

The transmission is first initialized (Figure 5-11), then it starts (Figure 5-12).

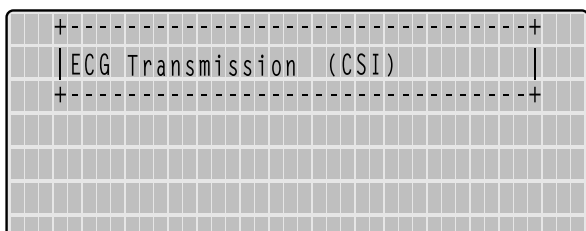

Figure 5-12. Display during ECG transfer

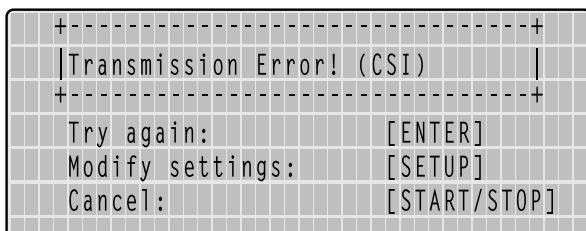







Figure 5-13. Error message

After the transmission, a message on the display indicates the number of successfully transmitted ECGs. As soon as you acknowledge the message with , the 12 Lead Mode acquisition screen appears.

If it is not possible to transmit the ECG (wrong modem setup, modem off), the unit will display an error message, such as "Transmission error! (CSI)" (Figure 5-13).

In this situation you have the following choices:

- you can repeat the transmission with 
- you can change the settings with 
- you can stop the transmission with  .

5.5.4 Direct Transmission of Data to a MUSE CV System

Before sending data to the MUSE CV system, the MAC 1200 automatically logs on to MUSE. Then the data will be transmitted. If the transmission is stopped, the MAC 1200 may take a few seconds before canceling the connection because it has to log off the MUSE system first. Then the standard display reappears.

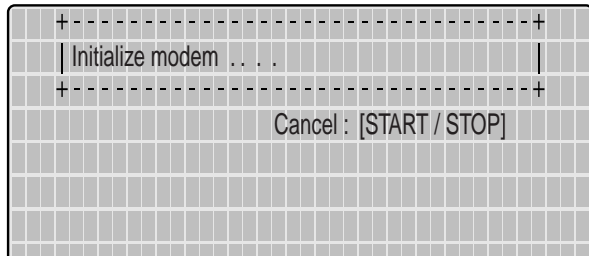

Figure 5-14. Screen display after activation of  and 

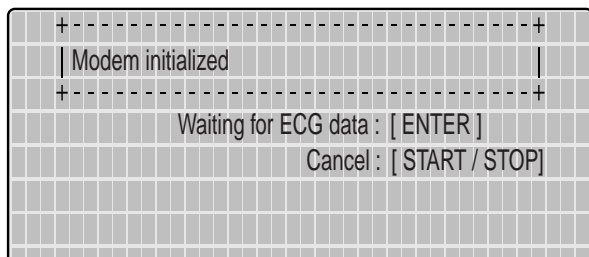

Figure 5-15. Screen display after modem initialization

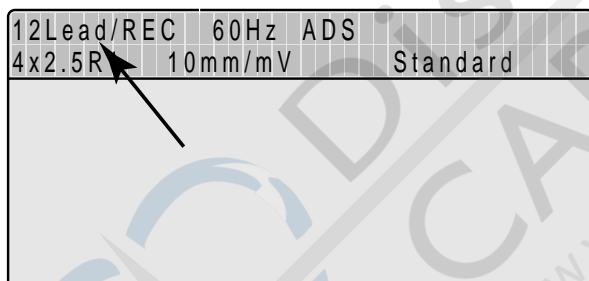

Figure 5-16. Unit is ready to receive data

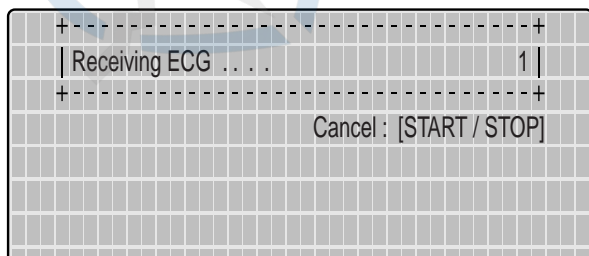









Figure 5-17. Unit is receiving ECG 1

5.5.5 Receiving Data with the CSI Communication Protocol



(see also chapter 13 "Technical Specifications")

Receiving ECGs is only possible in the 12Lead Mode.

- Use the key combination  and  to display the screen for receiving ECGs (Figure 5-14). The connected modem is automatically initialized. The procedure can be aborted with  .
- Press  to enable the "receive data" mode. The procedure can be aborted with  .

When you have enabled the "receive data" mode, the standard screen display of the 12 Lead Mode displays. The message "12Lead/REC" indicates that the unit is ready to receive data (Figure 5-16).

ECGs can be recorded in the 12 Lead Mode even while the unit is in the "receive data" mode.

A message displays on the screen when the unit is receiving data (Figure 5-17). The reception can be aborted with  .

The ECG which has just been received is processed for the printout. The report is printed in the selected format. Multiple ECGs are received and printed one after the other.

After printout of the last ECG, the "receive data" mode is automatically disabled. The mode is also disabled when you select another operating mode.

The following information is annotated in the bottom line of each report:

- the sender
- the software version and analysis program version used at the sending unit (e.g. "ACQ-DEV: M1200 V5.1M12i 12SL V1.13).

5.5.6 Cart to Cart Communication

Via modem, ECG data can be transmitted between two MAC 1200 units or between a MAC 1200 and any ECG recorder using the CSI protocol (see sections 5.5.1 and 5.5.2).

5.5.7 Modem Setup (for Modem --> other)

If you prefer to use another modem than the standard models listed in the setup menu (MultiTech, Elsa), you will have to enter a few parameters required for communication between the MAC 1200 and the modem.

For the AT commands which your modem understands, please refer to the modem user instructions. Three command sequences have to be entered in all, each of which defines a specific modem operating state:

1. the modem is initialized (init string)
2. a communication link is established (dial string)
3. the communication is terminated (hangup string)

These three strings are entered in the modem setup menu (see section 3.6 "Connecting External Devices").

The example below shows the command strings for the MultiTech ZDX modem.

1. AT Command for Modem Initialization

AT prefix that precedes every command line
 &F fetch factory configuration (loads the factory configuration from ROM into the active configuration memory (RAM))
 MO speaker is always off
 &DO ignore DTR status transition
 &QI standard AT result code
 VO digit result codes selected (0 to 999)

- init string: AT&FMO&DO&:QIVO

2. AT Command for Establishing a Communication Link

Example of a dial string for a modem connected to a branch (PBX system) and dialing a modem via the public telephone network, using the touch tone mode.

AT prefix that precedes every command line

DT touch tone dial mode

xxx after DT, enter the characters for access to the public telephone network (e.g. 0) 0)

W W, placed after a number, tells the modem in a PBX system to wait for the dial tone of an outside telephone line

- dial string: ATDTOW

3. AT Command for Termination of the Communication

The communication is terminated in two steps.

First of all, the MAC 1200 sends an escape command to return from the on-line state to the command state. Then the hangup command follows:





+++ escape command

AT prefix that precedes every command line

H hangup command

- hangup string: +++ATH

5.6 Brief Operating Instructions - 12 Lead Mode



- Switch on the unit and wait for self-test to end
- Apply electrodes to patient
- Enter patient data - 
- Check device settings
 - report sequence
 - report format
 - AC line filter
 - override function
 - 12SL interpretation configuration
- Modify device settings, if required - 
- Wait for patient to lie motionless and for the unit to collect 10 seconds of ECG data
- Check that no lead failure message is displayed
- Start recording with  .



Discount
CARDIOLOGY
www.discountcardiology.com

6 Recording in 6 Lead Mode

6.1 Some Basic Facts

In 6 Lead Mode, the system acquires 6 leads of ECG in realtime. Recordings are started and stopped with  . Some of the system settings can be customized. They are labeled with "configurable".

The following information refers to a unit with the system defaults (see table below). For instructions on changing the device setup, refer to section 9.3 "6 Lead Mode".

Parameter	System defaults	Options
Report sequence	STANDARD	CABRERA, SEQ.NO.4
Gain	10 mm/mV	"*auto", 5, 20, 40 mm/mV
Speed	25 mm/s	5, 50 mm/s
Muscle filter	No	Yes
Filter frequ.	40 Hz	20 Hz
AC line filter	Yes	No
Anti-drift system	No	Yes
Start at queue mark	No	Yes

6.2 Recording

After switching on the unit, press  to select the 6 Lead Mode.

- Before recording the ECG, patient data can be entered with . We recommend to enter the patient's name to annotate it on each page.

Note

In 6 Lead Mode, messages indicating disconnected electrodes are annotated on the recording, e.g. Lead fail V1.

- Before initiating a recording, check the display for error messages (see table below). Check all electrodes; if the message persists, there must be a break in the patient cable. Replace the cable with a new one.

**RL*: right leg electrode disconnected*
**RA*: right arm electrode disconnected*
**LA*: left arm electrode disconnected*
**LL*: left leg electrode disconnected*
**V1*: chest electrode V1 disconnected*
**V2*: chest electrode V2 disconnected*
**V3*: chest electrode V3 disconnected*
**V4*: chest electrode V4 disconnected*
**V5*: chest electrode V5 disconnected*
**V6*: chest electrode V6 disconnected*

Messages indicating disconnected electrodes

Note

- Please note that filters may suppress diagnostically relevant portions of the signal, because they limit the transmission range. Filters should therefore only be enabled if necessary.
- Before and during the recording, the second set of 6 leads can be selected with the  key.

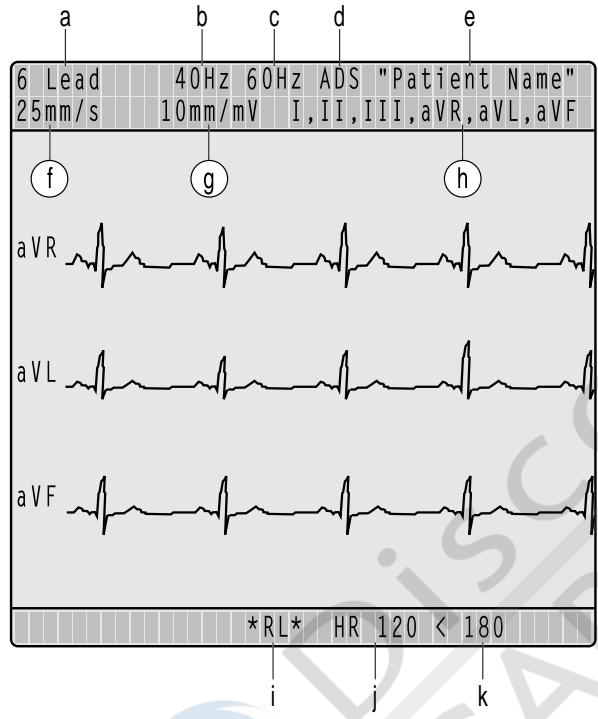





Figure 6-1. 6 Lead mode display

- a Operating mode
- b Muscle filter enabled
- c AC line filter enabled
- d Anti-drift system enabled
- e Patient name
- f Writer speed
- g Gain 10 mm/mV (automatic gain adjustment off)
- h Report sequence
- i Right leg electrode failure message
- j Heart rate
- k Heart rate limit (adjustable)



- The recording is started and stopped with .



With the system defaults, the MAC 1200 will activate the following functions and settings:

- the standard report sequence: I, II, III, aVR, aVL, aVF, V1, V2, V3, V4, V5, V6, also available: CABRERA, SEQ. NR. 4 (custom report sequence)
- a gain of 10 mm/mV (configurable) (calibration pulse at the beginning of the recording The unit can be set up to automatically adapt the gain to the ECG signal (see section 9.3 "6 Lead Mode"). Also, the gain setting can be changed with  (5, 10, 20 and 40 mm/mV).
- the AC line filter is enabled
- the muscle filter is disabled
- the anti-drift system (cubic spline) is disabled (configurable)
- the writer prints at a speed of 25 mm/s, the speed can be changed with 
- Pressing  will output the patient data after the ECG recording.
- The unit will not advance the paper to the beginning of a new page each time a recording is initiated (configurable)











All relevant device settings are shown on the display (Figure 6-1).

- If you change the writer speed, lead group or any filter settings during a recording, the unit will briefly stop.
- With  you advance to the next group of 6 leads of the selected report sequence.

- With  / , you toggle between the two lead sets (3 each) on the display that belong to the recorded group.
- When the anti-drift system is enabled, there will be a short delay before the recording starts. The ECG will then be recorded with a delay of 2.2 s.

The heart rate limit is automatically calculated from the date of birth (WHO 100% = 220 - age). When the date of birth is not entered, the unit will set the limit at 180 bpm. This value can be changed with  and  (in steps of 5 bpm). The minimum value for the heart rate limit is 30 bpm.

6.3 Brief Operating Instructions - 6 Lead Mode

- Switch on the unit and wait for self-test to end
- Apply electrodes to patient
- Select the 6 Lead Mode - 
- Enter patient data - 
- Check device settings
 - report sequence
 - AC line filter
 - ADS (cubic spline)
 - heart rate alarm limits
- Modify device settings, if required - 
- Watch ECG on display
- Check that no lead failure message is displayed
- Start recording with  
- Proceed to the next group of 6 leads with 
- Change the writer speed with 
- Switch on muscle filter with 
- Stop the recording with  
- Print patient data with 

7 Arrhythmia Mode

7.1 Some Basic Facts

In Arrhythmia Mode, the MAC 1200 continuously scans the ECG for arrhythmias.

From six simultaneously acquired leads, the MAC 1200 automatically selects the two that provide the best signal for analysis.

When the analysis algorithm detects an arrhythmia, the event is recorded with "context" (Figure 7-1). The length of the recording varies with the duration of the event episode. In the setup menu (section 9.4 "Arrhythmia Mode") you determine the conditions for a recording:

- the recorder starts each time it detects a single-beat event - all
- the recorder starts each time it detects an event different from the previous event - unequal
- the recorder does not start at all - no.

Some of the system settings can be customized. They are labeled with "configurable". The following information refers to a unit with the system defaults (see table at left). For instructions on changing the system setup, refer to section 9.4 "Arrhythmia Mode".



Figure 7-1. Event recording

Note

After starting the program, press  to select a continuous recording with a speed of 5 mm/s (configurable). If the unit identifies an arrhythmic event, it will automatically switch to the fast paper speed.

With the same key , the trend recording can be stopped. The unit can be set up to automatically start a trend recording when the Arrhythmia Mode is initiated.

Parameter	System defaults	Options
Report sequence	STD_C (chest leads V1 through V6)	STD_RED (I, II, III, V2, V4, V6) STD_LI, (I, II, III, aVR, aVL, aVF) CABR_LI (aVL, I, -aVR, II, aVF, III) HIGH_C (V1' through V6')
Gain	10 mm/mV	"*auto", 5, 20, 40 mm/mV
Muscle filter	No	Yes
Frequency	40 Hz	20 Hz
AC line filter	Yes	No
Trend rec.	No	Yes
Arrhythmia data	unequal	all, no
Episodes	chron.	prio, ventr., no





***RL*:** right leg electrode disconnected
***RA*:** right arm electrode disconnected
***LA*:** left arm electrode disconnected
***LL*:** left leg electrode disconnected
***V1*:** chest electrode V1 disconnected
***V2*:** chest electrode V2 disconnected
***V3*:** chest electrode V3 disconnected
***V4*:** chest electrode V4 disconnected
***V5*:** chest electrode V5 disconnected
***V6*:** chest electrode V6 disconnected

Messages indicating disconnected electrodes

Note

- With , a single-page recording can be initiated after program start.
- Please note that filters may suppress diagnostically relevant portions of the signal, because they limit the transmission range. Filters should therefore only be enabled if necessary.
- For proper functioning of the ECG analysis algorithm, pacemaker patients must be identified in the patient data: Pacemaker – yes (section 4.3 "Entering Patient Data").

7.2 Recording

- After switching on the unit, press  to select the Arrhythmia Mode.
- Before recording the ECG, patient data can be entered (). We recommend to enter the patient's name to annotate it on each page.
- Before initiating a recording, check the display for error messages (see table at left). Check all electrodes; if the message persists, there must be a break in the patient cable. Replace the cable with a new one.
- The recording is started and stopped with the   key.

Upon program start, the unit records 6 leads of ECG (1 page). During the following learn phase, the analysis algorithm learns the patient's typical QRS complex. After the learn phase, the recorder prints a report where the QRS complexes acquired in the learn phase are labeled "L" and the complex found to be the patient's typical complex is labeled "QRSL". Having completed the learn phase, the MAC 1200 is ready to identify arrhythmias.

With the system defaults, the MAC 1200 will activate the following functions and settings:

- the STD_C report sequence V1 through V6 (configurable)
- a gain of 10 mm/mV (configurable) (calibration pulse at the beginning of the recording The unit can be set up to automatically adapt the gain to the ECG signal (*auto))
- the AC line filter is enabled (configurable)
- the muscle filter is disabled (configurable)

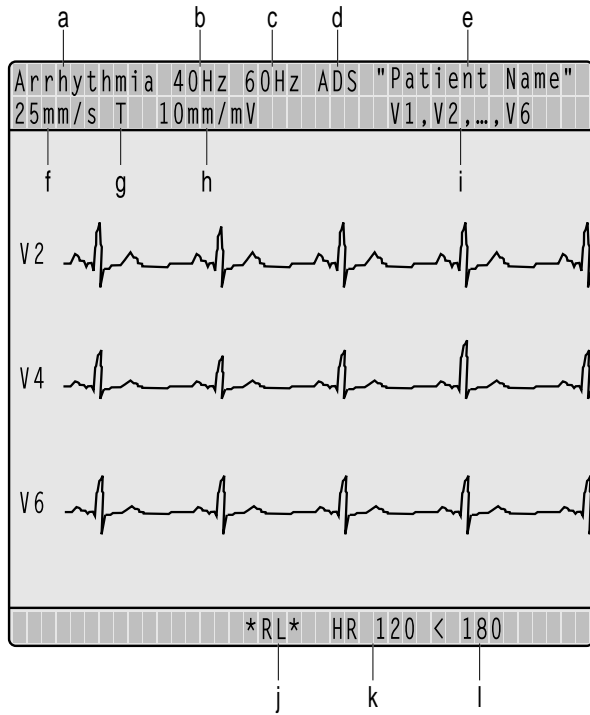

Figure 7-2. Arrhythmia mode display

- a Operating mode
- b Muscle filter enabled
- c AC line filter enabled
- d Anti-drift system enabled
- e Patient name
- f Writer speed (event episodes)
- g Trending enabled
- h Gain
- i Report sequence
- j Right leg electrode failure message
- k Heart rate
- l Heart rate limit

Note

The letter A on a recording indicates the presence of artifact which does not allow the algorithm to identify arrhythmias. Causes include wandering baselines. The anti-drift system largely prevents these disturbances. Still you should check the electrodes and leadwires.

- the anti-drift system is enabled
- the automatic baseline adjustment is enabled
- the slow trend recording is disabled (configurable)
- event episodes are recorded at a speed of 25 mm/s
- the unit documents all events that are different from the previous event (configurable). You can set up the unit to document all events or no event at all.

All relevant device settings are shown on the display (Figure 7-2).

The arrhythmia codes annotated on the recording are explained in table 7-1 (next page).

The heart rate limit is automatically calculated from the date of birth (WHO 100% = 220 - age). When the date of birth is not entered, the unit will set the limit at 180 bpm. This value can be changed with **F** and **G+** (in steps of 5 bpm). The minimum value for the heart rate limit is 30 bpm.

Final Report

The arrhythmia recording can be stopped with **⏏** and **⏏**.

The final report can then be printed with **copy**. The final report consists of

- the patient ID sheet (with all patient data as well as with all analyzed QRS complexes, type and number of detected events and the analysis duration in tabular form) and
- the episodes (3 sheets max. with 2 episodes each).

7.3 Brief Operating Instructions - Arrhythmia Mode

Arrhythmic Events	
– asystole, limit value	ASYSTO
– ventricular fibrillation/flutter	VFIB
– ventricular tachycardia (>3 PVCs)	VTAC
– ventricular run (3 PVCs)	RUN
– ventricular couplet (2 PVCs)	CPLT
– pause of 2 missed beats	PAU2
– pause of 1 missed beat	PAU1
– early PVC	EPVC
– ventricular bigeminy	VBIG
– new form (e.g. intermittent bundle branch block)	NF
– multiform PVCs	MULT
– supraventricular arrhythmia	SVAR
– paroxysmal supraventricular tachycardia	PSVT
– tachycardia	TACH
– bradycardia	BRAD
– pacemaker malfunction	PERR
– ventricular escape beat	ESC
– premature ventricular contraction	PVC
– premature supraventricular contraction	PSVC
– aberrant beat	ABR
– pacemaker capture	PCAP
– pause (>1.5 times the normal RR interval)	TL
– absolute pause, limit value	PAUA
– artifact	A
– learn phase	L
– learned QRS complex	QRSL







- Switch on the unit and wait for self-test to end
- Apply electrodes to patient
- Select the Arrhythmia Mode - 
- Enter patient data - 
- Check device settings
 - report sequence
 - AC line filter
 - trend recordings
 - episodes
 - heart rate alarm limits
- Modify device settings, if required - 
- Check that no lead failure message is displayed
- Start recording with 
- Switch on muscle filter with 
- Stop the recording with 
- Print patient data with 

Table 7-1. Arrhythmia codes

8 ECGs of Pacemaker Patients / ECG Recording during Defibrillation

8.1 Recording ECGs of Pacemaker Patients

Due to the slow paper speed it is not possible to display pacer pulses directly on the ECG recording. At a paper speed of 50 mm/s and a pulse duration of 0.5 ms, the width of the recorded pacer pulse would be only 0.025 mm.

For this reason the recorder reduces the pulse amplitude and expands the pulse width, so that the pacer pulse is easier to identify. The MAC 1200 records the pulse with the correct polarity, with a width of 5 ms and with the same amplitude in all leads (depending on the polarity of the pacer pulse in leads I and II, the pacer pulse in lead suppressed). The amplitude of the reverse current may differ from lead to lead. Figure 8-1 shows an ECG recording with pacer pulses.



Figure 8-1. ECG recording with pacer pulses

Warning

Incorrect HR, No HR Alarm — If several adverse conditions exist at once, the possibility that the pacer pulses are interpreted (and counted) as QRS complexes should be considered. At the same time, however, QRS complexes might be suppressed in certain situations. Therefore, pacemaker patients should always be watched closely.

8.2 ECG Recording During Defibrillation

The patient signal input is defibrillation-proof so it is not necessary to remove the ECG electrodes before defibrillating the patient. However, when using stainless steel or silver electrodes, the defibrillator discharge current may cause complete polarization at the electrode/skin interface. This condition may prevent ECG signal acquisition for several minutes. With silver/silver chloride electrodes, this will not happen.

Set the MAC 1200 to 6 Lead Mode when you may have to defibrillate the patient while recording the ECG, and disable the anti-drift system as this would cause a 2 second signal delay (section 9.3 "6 Lead Mode").

If electrodes made of other materials are used, disconnect the patient cable from the recorder while the shock is applied.

Warning

- **Equipment Damage** — For reasons of patient safety, use only the original GE Marquette patient cable. Before connecting the cable to the device, check it for signs of mechanical damage. Do not use a damaged cable.
- **Patient Hazard, Delayed ECG Display** — Use silver/silver chloride electrodes for ECG signal acquisition, if the patient may have to be defibrillated.
- **Shock Hazard** — The patient signal input of the recorder is protected against damage resulting from defibrillation shocks. Nevertheless, extreme care should be exercised when defibrillators are used on a patient connected to other devices while a shock is released. During defibrillation, do not touch the patient, the electrodes or the leadwires.

Note

Observe the safety information of the defibrillator.

9 System Setup

9.1 Some Basic Facts

- Press  to display the setup menu.



The setup menu with the following options will appear:

- Operating mode: 12 Lead (6 Lead, Arrhythmia)
- General Settings
- Communication
- Patient Data Setup
- Option Code



At "Operating mode", you will always see the currently selected mode. So be sure to select the appropriate mode before entering the setup menu.

- To access the menu options, position the bar cursor on the option with the cursor keys and confirm the selection with .

The operating steps to select a setting are always the same:

- Using the cursor keys  and , you select the option, then you confirm the selection with .

The cursor will move to the next menu item.

- Individual items can be skipped with  or .
- Press  to exit the setup mode.

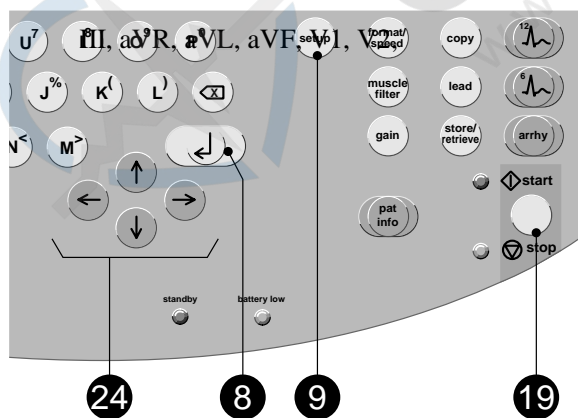



Figure 9-1. System setup keys

9.2 12 Lead Mode

- Use the cursor keys to position the bar cursor on "12 Lead" and confirm the selection with .

The setup menu for automatic 12 lead recording will appear.

The angular brackets [] denote the system defaults.

Report sequence

[STANDARD] (I, II, V3, V4, V5, V6)
CABRERA (aVL, I, -aVR, II, aVF, III, V1, V2, V3, V4, V5, V6)

Rhythm leads

Any three of the available ECG leads can be selected as rhythm leads. They are printed with report formats 4x2.5R3 and 1x10R3. Formats 2x5R1 and 4x2.5R1 will show only the first of the rhythm leads.

Gain

5, [10], 20, 40 mm/mV, *auto

Report format

For an overview of the available report formats, refer to section 5.4 "The Report Formats". The default format is 4x2.5R1.

Detailed results

The "Detailed results" page will be printed, yes/[no] (section 5.4 "The Report Formats", only available with option MEAS or DIAG).

Muscle filter/AC line filter

Elimination of muscle artifact and AC line interference.

Default: muscle filter [No], AC line filter [Yes]

Note

Please note that filters may suppress diagnostically relevant portions of the signal, because they limit the transmission range. Filters should therefore only be enabled if necessary.

Filter frequency

Cut-off frequency of the muscle filter ([40 Hz], 20 Hz).

The frequency range is indicated in the lower margin of the recording strip.

"0.08 - 40 Hz" (40-Hz muscle filter enabled)

"0.08 - 20 Hz" (20-Hz muscle filter enabled)

"0.08 - 150 Hz" (muscle filter off).

Manual copy to

When the  key is pressed, the unit will print a copy of the ECG [EKG] or send the ECG to a HOST system (MUSE CV Information System).

No. of copies

If you do not want to print the ECG, but only collect data, select "0" (message on display "REC OFF").

When a number greater than 1 is selected, multiple copies of the reports will be printed. Default: [1]

Autosave ECG (only with MEMO option)

After report generation, the ECG will or will not be automatically saved to the internal memory (yes, [no]).

Delete ECG after Transmission

(only with MEMO option)

ECGs that were successfully sent to a host system via the RS232 interface will be cleared from the recorder memory (yes, [no]).

If this menu item is set to "yes" and ECGs have already been sent from the recorder memory, these ECGs will be deleted after the next transmission of a stored ECG.

Configuration of the 12SL Interpretation**Use screening criteria**

The screening criteria can be enabled or disabled.

Default: [disabled]

Suppress "normal" statement

If you select 'Yes', the interpretation statement "normal ECG" will not be shown.

Suppress "abnormal" statement

If you select 'Yes', the interpretation statement "abnormal ECG" will not be shown.

Interpretation

Default: [Yes]. If you select 'No', 12 SL interpretation results will not be generated nor shown.

Print Interpretation

Only available if "Interpretation" is set to "Yes".

Default: [Yes]. The interpretative statements are printed on the reports. When you select "No", the interpretation will not be printed, but it can be sent to the MUSE CV Information System.

Override function

When this function is enabled [yes], the recorder will print in 12 Lead Mode, even when not all electrodes are applied or do not supply a good signal.

When electrodes are disconnected, a message informing the user of poor signal quality will be printed on the recording.

Furthermore, systems with interpretation capability will print a message indicating that the measurement results and interpretation may be incorrect.

9.3 6 Lead Mode

- Use the cursor keys to position the bar cursor on "6 Lead" and confirm the selection with .

The setup menu for continuous recording of 6 leads will appear.

Report sequence

- [STANDARD] (I, II, V3, V4, V5, V6)
- CABRERA (aVL, I, -aVR, II, aVF, III, VI, V2, V3, V4, V5, V6)
- SEQ. NO. 4 (here, users can define a custom report sequence):

- Position the cursor on "SEQ. NO. 4".
- Press .

The display shown in Figure 9-2 will appear.

Report sequence	SEQ. NO. 4
Lead	Label
Channel 1:	I I
Channel 2:	II II
Channel 3:	III III

Figure 9-2. Creating a custom report sequence

- Press .

The cursor will move to the position for entry of the lead in channel 1. Follow these steps, if you wish to record aVR in channel 1, for instance:

- Enter AVR and confirm the entry with .

The cursor moves to the position for entry of the lead designation. AVR appears there as well.

- If you wish to enter another designation, you can overwrite the default name (4 characters max.).
- Confirm your entry with  and repeat the above steps for channel 2, etc.

You can write over "SEQ. NO. 4" if you wish to enter another name for the report sequence.

Gain

*auto, 5, [10], 20, 40 mm/mV; with "*auto", the unit will automatically determine the appropriate gain setting for the 6 simultaneous leads.

Speed

Changes the writer speed. Default: [25 mm/s]

Muscle filter/AC line filter

Elimination of muscle artifact and AC line interference

Default: muscle filter [No], AC line filter [Yes]

Filter frequency

Cut-off frequency of the muscle filter ([40 Hz], 20 Hz).

The frequency range is indicated in the lower margin of the recording strip.

"0.08 - 40 Hz" (40-Hz muscle filter enabled)

"0.08 - 20 Hz" (20-Hz muscle filter enabled)

"0.08 - 150 Hz" (muscle filter off).

Anti-drift system (ADS) (cubic spline)

In case of wandering baselines, the anti-drift system restores the baseline to its original position (signal delay with ADS approx. 2 s). Default: [No]

Start at queue mark

Before each recording, the recorder advances the paper to the beginning of a new page (yes, [no]).

9.4 Arrhythmia Mode

- Use the cursor keys to position the bar cursor on "Arrhythmia" and confirm the selection with .

The arrhythmia mode menu will appear.

Report sequence

[STD_C]: V1, V2, V3, V4, V5, V6
 STD_RED: I, II, III, V2, V4, V6
 STD_LI: I, II, III, aVR, aVL, aVF
 CABR_LI: aVL, I, -aVR, II, aVF, III
 HIGH_C: V1', V2', V3', V4', V5', V6'
 (C = chest leads, RED = reduced number of leads, LI = limb leads)

Gain

*auto, 5, [10], 20, 40 mm/mV; with "*auto", the unit will automatically determine the gain setting.

Muscle filter/AC line filter

Elimination of muscle artifact and AC line interference

Default: muscle filter [No], AC line filter [Yes]

Filter frequency

Cut-off frequency of the muscle filter ([40 Hz], 20 Hz).

The frequency range is indicated in the lower margin of the recording strip.

"0.08 - 40 Hz" (40-Hz muscle filter enabled)

"0.08 - 20 Hz" (20-Hz muscle filter enabled)

"0.08 -100 Hz" (muscle filter off).

Trend rec.

The slow trend recording of 5 mm/s automatically begins at program start ([no]/yes).

Arrhythmia data

The recorder will document arrhythmias in the following situations:

- each time an arrhythmia occurs
- each time an arrhythmia occurs that is different from the preceding event
- arrhythmias are not documented all, [unequal], no.

Episodes



Final report includes episode report, with episodes listed by one of the following criteria

- in chronological order
 - according to priorities (see table 7-1)
 - ventricular beats only
 - no episodes
- [chron.], prio., ventr., no

9.5 General Device Settings

Ordering / Referring Physician / Technician

In the field at left, you see the last name of the physician or technician selected as the default name. When selecting "other", a menu displays where you can enter up to 10 names (2-digit ID number, first name, last name). The default name (and ID) is automatically selected at power-up.

The "Referring Physician" is only relevant if you send ECGs to the MUSE CV system. This name will not be annotated on the ECG recording. Press the   key to exit the menu.

Institution Name

The name entered here will be printed on each report page.

Cart

Enter any number between 1 and 9999 to identify the cart (local system). The cart # entered here is the default number that appears in "Patient Data".

Default: [1]

Site

Enter any number between 1 and 255 to identify the MUSE CV Information System to which the ECGs will be sent. The site # entered here is the default number that appears in "Patient Data".

Default: [1]

Location

Enter any number between 1 and 600 to identify the location of the sending system. The location # entered here is the default number that appears in "Patient Data".

Default: [1]

Date/Time

Enter date and time (enter 4 digits for the year).

Lead fail beep

Indicates when electrodes are not properly applied or disconnected (yes/[no]).

High HR beep

An audible signal sounds when the heart rate exceeds a limit value (yes/[no]) (only in 6 Lead and Arrhythmia Modes). The limit value (220 - age) can be changed manually.

Lead labels

[AAMI] codes: RA, LA, RL, LL, V1 to V6 or IEC codes: R, L, F, N, C1 to C6

Date

Format: [month/day/year] or day.month.year

Time

Time format [12] hours (am/pm) or 24 hours

Units

Units of measurement for the patient's height and weight: [in/lb] or cm/kg

Mains

AC line frequency (USA [60 Hz], Europe 50 Hz)

LCD light off after

If operating controls are not activated within the selected period of time the display backlighting automatically switches off (system default [5 min], adjustment range 1 to 99 min).

Default mode

This is the operating mode the unit defaults to after power-up: [12 Lead], 6 Lead, Arrhythmia

Language

Select the language for user interface and printouts.

Enable password protection

Select "yes" to protect the setup menu with a password. You will be asked to enter a password and to repeat it. The password protection is then active.

To change the password (only possible when password protection is active)

- select menu item "Enable password"
- enter the old password
- enter the new password
- repeat the new password

Test DATA

Used for demonstration purposes (yes). It must be set to [no] for proper clinical use.

Restore defaults

Selecting "Yes" will restore the default setup (including the defaults of the three operating modes).

The resting ECG analysis system must be switched off (standby) and on again for the new settings to become effective.

Print Setup Lists

Selecting "yes" will display a menu with all available setup lists.

- all lists
- System Setup / Communication / External Devices / Patient Data Setup
- 12 Lead
- 6 Lead
- Arrhythmia

9.6 Communication

Protocol

The recorder offers two communication protocols: "CSI" (Client Server Interface) and A5.

The CSI protocol supports the transfer of resting ECGs from the resting ECG analysis system to a MUSE CV system.

With the "A5" protocol, the 10-second resting ECG can be transmitted to CardioSys and CardioSoft.

Baud rate (HOST)

Transmission rate for the selected protocol. We recommend the default setting of [19200 baud].

Modem

Select the modem type. You can choose among the standard modems MultiTech (MT 19.32, 56.6), Elsa 28.8, Elsa 33.6, Elsa 56.6 and a user-defined modem.

When using one of the standard modems, all you have to enter is

- the dial mode (pulse or tone, depending on your telephone network)
- the telephone number (28 digits max.)
- the number to access the public telephone network (e.g. "0").

For a user-defined modem, enter

- the telephone number (28 digits max.)
- the init string (20 characters max.) (see modem operator's manual)
- the dial string (20 characters max.) (see modem operator's manual)
- the hangup mode (20 characters max.) (see modem operator's manual)

✂

The **master password** overriding all other passwords is

SYSTEM

Use this password if you cannot remember your own password.

9.7 Patient Data

The patient data menu can be set up to meet individual requirements. If you do not want to enter blood pressure readings, for instance, you can remove the corresponding prompts:

- Use the cursor keys to position the bar cursor on "Setup Patient Data" and confirm the selection with .

The patient data setup menu will appear.

- Select "no" for prompts that you want to remove from the dialog.

Items - Last name
 - First name
 - Date of birth
 - Patient ID

cannot be removed.

Items - Height
 - Weight
 - Diastolic BP
 - Systolic BP
 - Referring Physician
 - Medication
 - Comments
 - ID required
 - Secondary ID
 - Secondary ID required
 - Last name required
 - First name required
 - Extra Questions
 (Prompt 1 through Prompt 4)

are disabled. They can be enabled from the patient data setup menu.

"Required" Data Fields

If, for one of the data fields

- ID required
- 2nd ID required
- Last name required
- First name required

you choose "yes", an ECG can be recorded in 12 Lead Mode only if the corresponding patient data is entered.

Prompt 1 to 4

You can enter any text here (10 characters max.). When you have entered the text, you can select the format of the response field. There is a choice of 3 formats:

- alphanumeric field (17 characters max.)
- only numbers (9 numbers max.)
- yes or no

- To exit the menu, press  .

9.8 Option Code

In this menu you enter the option codes to enable a number of optional software functions. The respective option becomes active after you have entered the code number. The code numbers are listed on the option code sheet supplied with the different software options.

- In the setup menu, position the bar cursor on "Option Code" and confirm the selection with .

The option code menu appears. There is a choice of 6 options:

- MEAS: measurement of the 10-second resting ECG
- DIAG: measurement and interpretation of the 10-second resting ECG
- MEMO: program for storage of up to 40 resting ECGs
- C100: activates the three options MEAS, DIAG, MEMO for a maximum of 100 ECGs
- C500: activates the three options MEAS, DIAG, MEMO for a maximum of 500 ECGs
- EVAL: activates the three options MEAS, DIAG, MEMO for a maximum of 4 weeks







- Position the bar cursor on the option you wish to activate.
- Enter the 12-digit code number from the keyboard and confirm the entry with .

The unit will accept the entered number only if it corresponds to the unit's serial number. The serial number is indicated at the top of the menu (Ser.No. = xxxxxxxx). This number must be the same as printed on the nameplate (back of the device).





When you enter the code number for DIAG and MEMO, the fields for C100, C500 and EVAL will disappear.

- Exit the menu with  .







9.9 ECG Transmission via Modem

- Select the 12 Lead Mode and press .
- Press  to display the setup menu for the 12 Lead Mode.
- Use the cursor keys to position the bar cursor on "Manual copy to HOST" and confirm the selection with  ([HOST]).
- Press   to clear the setup menu.
- Use the cursor keys to position the bar cursor on "Communication" and confirm the selection with .

Selecting the Communication Protocol

- Using the cursor keys, position the bar cursor on "Protocol". Select the protocol CSI to send data to a MUSE CV system, or select A5 if you will send data to CardioSys/CardioSoft.
- Use the cursor keys to position the bar cursor on "Modem, other" and confirm the selection with .
- Choose the modem you use from the list and confirm the selection with . If your modem is not included in the list, select "other" and enter the required modem commands (see also "Modem Setup" in section 5.5).
- When you have selected a standard modem, position the bar cursor on "Dial mode" and select the appropriate mode.
- Enter the telephone number of the receiving modem and the number to access the public telephone network and terminate the setup with  .

9.10 Direct ECG Transmission

- Select the 12 Lead Mode and press .
- Press  to display the setup menu for the 12 Lead Mode.
- Use the cursor keys to position the bar cursor on "Manual copy to HOST" and confirm the selection with  ([HOST]).
- Press   to clear the setup menu.
- Use the cursor keys to position the bar cursor on "Communication" and confirm the selection with .
- Select the same baud rate as at the receiving modem (9600, 19200, 38400, 57600).

Selecting the Communication Protocol

- Using the cursor keys, position the bar cursor on "Protocol".
Select the protocol CSI to send data to a MUSE CV system, or select A5 if you will send data to CardioSys/CardioSoft.
- Use the cursor keys to position the bar cursor on "Modem, none" and confirm the selection with .

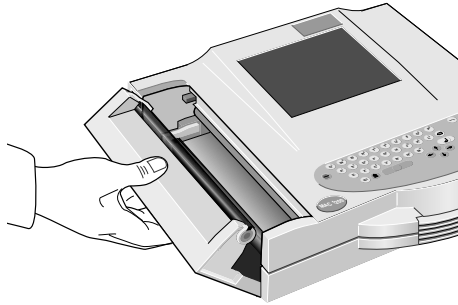

Figure 10-1. Opening the paper compartment door

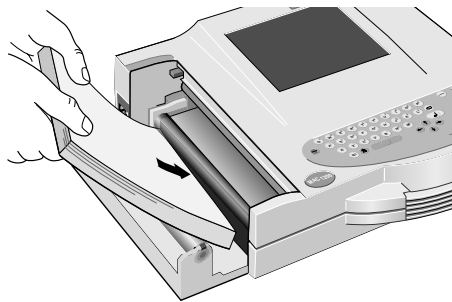

Figure 10-2. Inserting the new Z-fold pad

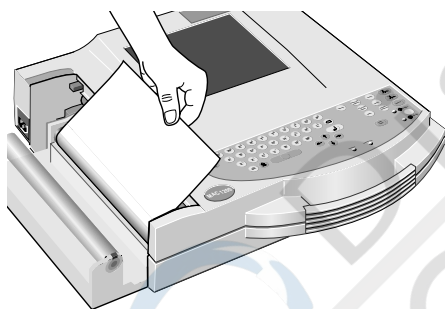

Figure 10-3. Guiding the leading paper edge over the guide roller

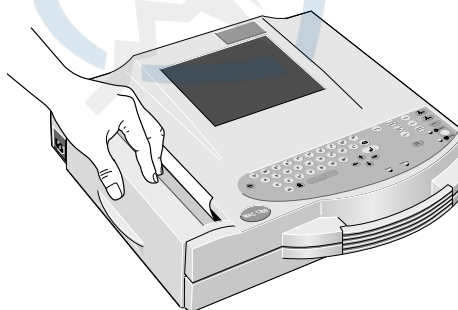





Figure 10-4. Closing the paper compartment door

10 Loading Chart Paper

- Switch on the recorder.
- Pull up the handle of the paper door and fold it out (Figure 10-1).
- Remove the cardboard backing of the previous paper pad.
- Remove the cardboard from the top of the new pad and place the pad, including the cardboard backing at the bottom and with the arrow pointing towards the unit, into the paper compartment (Figure 10-2).
- Pull the top sheet out of the compartment and guide it around the guide roller (Figure 10-3).
- Holding the leading edge of the paper in place between the two markers on the recorder, close the paper door (Figure 10-4). Ensure that it locks into place on both sides.

When inserting an already started Z-fold pad, the grid side must face up and the first fold must point towards the paper compartment.

Note

- *Having inserted a new paper pad, be sure to acknowledge the "end of paper" message with , not with  .*
- *When closing the paper door, take care that it locks into place on both sides.*
- *There is a window in the paper door that allows you to look inside the compartment and check the paper supply.*
- *Use only the original HELLIGE CONTRAST® chart paper or the GE Marquette thermal paper with queue marks or holes. This paper has a special coating that prevents*
 - *contamination and debris collecting on the printhead and*
 - *electrostatic build up.*
- *Furthermore, the thermosensitive layer and the printhead characteristics are exactly matched. Using other paper may result in recordings of poor quality. Moreover, the printhead may wear out prematurely. Use of other paper voids the warranty.*

End-of-Paper Indication

A stripe marks the last 10 pages of the Z-fold pad.

When the writer runs out of paper during a recording, it will emit an audio signal and displays the message "End of paper or paper jam, if OK, press ".

- Insert a new paper pad and acknowledge the message with .

Aging Stability

The standard ECG writer paper CONTRAST® is designed to guarantee full contrast for a period between 3 and 5 years if it is handled as described below before and after recording:

- Store the paper in suitable rooms at a temperature between 18° and 24° and a relative humidity between 40 % and 60 %.
- Avoid direct contact of the paper with
 - carbon and carbonless forms
 - chart papers and adhesives containing tributyl phosphate, dibutyl phthalate, or any other organic solvents
 - document protectors, envelopes, and sheet separators containing plasticizers.

Caution: The above components may also be found in recycled papers.

 - solvents or solvent-based products containing alcohols, ketones, esters, or other substances from this chemical group.
- We recommend archiving ECG recordings on our ECG filing cards only (P/N 217 043 03).
- If longer storage periods are required, we suggest using our ARCHIVIST 30 chart paper (image legibility up to 30 years) or other image storage technologies.

A stripe marks the last 10 pages of the Z-fold pad.

11 Cleaning, Disinfection and Maintenance

11.1 Cleaning and Disinfecting the Recorder Housing

Warning

Before cleaning or disinfecting the device, disconnect it from the power line.

- Clean the recorder housing with a moist cloth. Do not let liquid enter the device. All cleaning agents and disinfectants that contain alcohol and are commonly used in hospitals are suitable, but do not use disinfectants on a phenol base or peroxide compounds.

11.2 Cleaning and Disinfecting the Patient Cable

- Disconnect the cable from the recorder before cleaning or disinfecting it. When disconnecting the cable, be sure to pull on the connector, not on the cable.
- **Clean** the cable by rubbing it down with a cloth moistened with soap water. Use a disinfectant for **disinfection**. Do not immerse the cable in liquid.

11.3 Cleaning and Disinfecting the Electrodes

In addition to the information given in this manual, observe the instructions for use of the respective electrode types.

- Discard disposable adhesive electrodes immediately after use to prevent that they are reused.
- Clean reusable electrodes immediately after removing them from the patient.
- Peel off the adhesive foil before cleaning the electrodes (rests of the adhesive can be removed with benzine).
- Then use warm water and a small brush to clean the electrodes of cream or gel. Do not use pointed or sharp objects for cleaning.
- Disinfect the electrodes with alcohol-free disinfectant. Ensure that connectors and sockets do not become wet.
- The only approved sterilization method is gas sterilization. Frequently sterilizing the electrodes with ethylene oxide gas reduces the life of the plastic material.

11.4 Maintenance

Checks before each use

Before each use, visually inspect the device, the leads and electrodes for signs of mechanical damage.

If you detect damages or impaired functions that may adversely affect the safety of the patient or user, do not use the device before it has been repaired.

Technical Inspections

For safety, the devices require regular maintenance. To ensure functional and operational safety of the MAC 1200 units, Technical Inspections should be carried out on an annual basis.

These checks should be performed by persons with adequate training and experience.

The checks can be carried out by GE Marquette within the framework of a service contract. The inspections include the following checks:

- Visually inspect the device and the accessories for signs of mechanical damage that may impair the device functions.
- Check that the device labeling relevant for safety is legible.
- Run a performance test as described in the operator's manual.
- Measure the resistance of the protective earth conductor and the equivalent leakage current per your national regulations.



The device does not require any other maintenance.

Disposal at the End of Its Service Life

Note

At the end of their service life, the device described in this manual and its accessories must be disposed of in compliance with the applicable local waste control regulations. If you have questions regarding the disposal of the product or of accessories, please contact GE Marquette or its representatives.

12 Troubleshooting

Symptom	Cause	Remedy
Periodic superimposition of AC line interference (60 Hz) (Figure 12-1)	interference from the power line	Ground bed, verify position of the leadwires, switch on AC line filter
Superimposition of irregular AC line interference (Figure 12-2)	Muscle artifact caused by patient movements, hiccup, coughing	The patient should be warm enough and resting comfortably (place cushions under arms and knees). Comfort patient or distract patient's attention, enable muscle filter (20 Hz / 40 Hz), if necessary.
The printed date and time are incorrect	Built-in lithium battery is depleted. The battery has a life of approx. 5 years	Notify service to check and/or replace battery
The green standby indicator 23 does not light up, although the recorder is connected to the power line	Defective AC power adapter or fuse	Notify service to check and/or replace fuse
The recorder does not write over the entire paper width	Paper compartment not properly closed	Paper door must lock into place on both sides
In 12 Lead Mode, the recorder does not stop and continues to feed paper. This does not happen in 6 Lead Mode.	The paper pad was inserted the wrong way round so the recorder cannot detect the cue mark	Insert the paper pad as instructed
Recorder does not start after activation of the   key, or the recording is aborted.	Unit operated on battery power: battery discharged	Connect recorder to the power line. After a few minutes, the recorder is able to resume operation. Always connect recorder to the power line when the battery low indicator 22 lights up. The battery capacity depends on age, temperature and charge level (chapter 3 "Putting the Recorder into Operation").
No recording in 12 Lead Mode	Failure of at least one electrode	Check all electrodes or enable Override function (section 9.2 "12 Lead Mode").
Paper jam		Open paper compartment and removed jammed sheet, place beginning of paper between the marks, close paper compartment and press  .

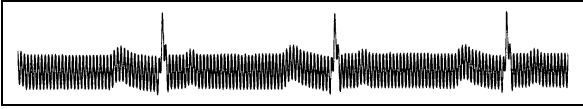

Figure 12-1. Regular AC line interference

Note

In the presence of very strong AC line interference in all leads, the thermal printhead may interrupt the recording. Activate the AC line filter (60 Hz) in these situations.

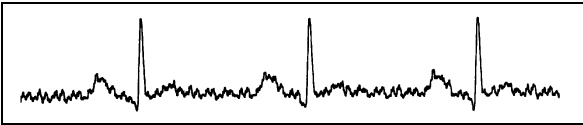

Figure 12-2. Irregular AC interference



13 Technical Specifications

Recording

Direct recording of waveforms and alphanumeric characters with rectangular coordinates by means of thermal-array printhead printing on thermosensitive paper.

- 3 or 6 recording channels, or 12 in 12 Lead Mode, overlapping
- baseline pitch 3 channels: 62 mm (arrhythmia)
6 channels: 31 mm (6 Lead)
12 channels: 16 mm (12 Lead.)
- writing width 200 mm max.
- annotation of recorder settings, date, time and entered patient name in the margin of the recording strip
- with appropriate software, documentation of analysis results in the respective operating mode
- resolution of the recording:
vertical 8 dots/mm
horizontal 25 µm at 25 mm/s

Printer paper

HELLIGE CONTRAST® Z-fold pad, 150 pages per pad, equivalent to a chart length of approx. 45 m

paper width: 8.5 inch

sheet length: 11 inch

To prevent damage to the printhead use only the original HELLIGE CONTRAST® paper or the GE Marquette thermal paper with queue holes or marks.

Paper transport

- paper speed
5-25-50 mm/s, key selectable
error limits at 25 and 50 mm/s, typ. ±1%
at 5 mm/s, ±10% max.
- At paper end, the recorder emits an audio signal and stops recording
the last pages of the pad bear a colored stripe in the lower margin

Membrane keypad

Pushbuttons with tactile feedback

- function keys for all routine operations
- alphanumeric keyboard for entry of text

Display

graphics display with 24 x 40 characters, contrast adjustment

resolution of 320 x 240 pixels with display backlighting

Indicators (LEDs)

For mains power, battery status and start/stop function

Automatic functions

They assist and facilitate operation by

- automatic control of lead selection, paper feed, calibration (configurable)
- report formatting (configurable)
- automatic baseline adjustment
- anti-drift system (cubic spline) compensating for polarization voltage fluctuations (configurable)

Detection of pacer pulses

- pulse length between 0.1 and 2.5 ms
- pacer pulse marker independent of pulse polarity
- pulse amplitude between ± 5 mV and ± 700 mV

Heart rate indication

derivation of the heart rate from all ECG signals

- display range between 30 and 300 bpm
- display update with every heart beat, maximum every 2 seconds

Signal inputs

isolated patient signal input, IEC type CF, high-voltage protection for all lead connections and neutral electrode, interference compensation via neutral electrode, monitoring for open leads

- electrode connections for RA, LA, LL, LA, V1 to V6
- input impedance for differential signals between any two electrode connections > 10 M Ω at 10 Hz
- input impedance for common-mode signals referred to neutral electrode > 50 M Ω up to 60 Hz
- dynamic range for differential signals between any two electrode connections for AC voltage ± 10 mV, for superimposed DC voltage (polarization voltage) ± 600 mV
- dynamic range for common-mode signals referred to neutral electrode ± 1 V, referred to chassis 263 V AC (rms)
- quiescent input current via any electrode connection for 1 k Ω termination referred to neutral electrode < 50 nA
- patient leakage current (rms values) according to IEC, class CF: in normal condition < 10 μ A,

in single-fault condition (e.g. patient in contact with line voltage) < 20 μ A

- non-destructive range for lead-electrode connections and the neutral electrode connection referred to neutral electrode ± 50 V, referred to chassis ± 1500 V
- pulse voltage resistance of all lead electrode connections and of the neutral electrode connection referred to chassis (either polarity, e.g. defibrillation) 5000 V
- monitoring of each electrode for open leads: RA, LA, LL, RL, V1, V2, V3, V4, V5, V6 audio signal at printer start

Data interface

one serial RS232 interface for exchange of data with suitable external devices and software handshake

RS232 interface (standard V.24 interface):

- input voltage range. ± 15 V max.
- output voltage range ± 5 V min.
- interface protected from electrostatic discharge for ± 10 kV max.

Transfer of ECGs with the CSI protocol between the MAC 1200 and the following units

MUSE CVIS	SW version 004A and later
MAC 5000	SW version 001B and later
MAC VU	SW version 002A and later
MAC 1200	SW version V5.01 and later

Receiving data with the CSI communication protocol from the following units

CardioSmart	SW version V4.21 and later
CardioSmart ST	SW version V4.21 and later

Sending ECGs to the following units with the A5 protocol

CardioSys / CardioSoft SW version V1.0 and later

Pin assignment of data port

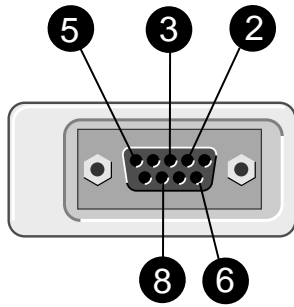

- 2 RXDE
- 3 TXDE
- 5 circuit reference
- 6 modem supply
- 8 remote start

Remote start (hardware)

Paper feed via remote control connection (depending on selected operating mode). External make contact referred to chassis via circuit reference:

- source impedance $R_i < 300 \Omega$
- contact dwell $> 100 \text{ ms}$
- non-destructive load $\pm 10 \text{ V}$
- ESD interface protection up to $\pm 10 \text{ kV}$

Signal Transmission

Patient input to recording

After lead formation and digitization simultaneous transmission of all electrode signals to the digital processing system; muscle filter, AC filter, pacing pulse identification, automatic or manual sensitivity adjustment, automatic baseline adjustment and drift compensation by means of the anti-drift system (A.D.S.) can be enabled or disabled simultaneously for all channels; digital output of processed signals via thermal-array printhead.

- low cut-off frequency (-3 db limits) 0.08 Hz, equivalent to a time constant of 2.04 s
- high cut-off frequency (3 dB limits) operating mode: 12 Lead, 6 Lead 150 Hz (IEC/AHA) operating mode: Arrhy 100 Hz (IEC)
- signal sampling rate: 1000/s
- resolution, referred to the input 5 μV

- output rate to recorder 2000/s
- for all leads, gain adjustment in four steps: 40-20-10-5 mm/mV
- with active muscle filter (low-pass characteristic) 3-dB drop of the amplitude frequency response at approx. 40 or 20 Hz
- with active AC line filter detection and compensation of periodic 50 or 60 Hz frequency components (depending on recorder model) attenuation $>40 \text{ dB}$
- non-linear distortion below values specified in IEC and AHA recommendations
- coincidence error limits between any two channels $\pm 0.5 \text{ mm}$
- detection of pacer pulses in V2 or other V leads and marking in all channels for signals referred to patient input: duration $\geq 0.1 \text{ ms}$, amplitude $> 5 \text{ mV}$
- noise in the signal transmission path below values specified in IEC and AHA requirements: $\leq 2.5 \mu\text{V rms}$
- common-mode rejection for 50 or 60-Hz signals (depending on recorder model) with AC filter switched on $>140 \text{ dB}$

ECG calibration

automatic recording of a defined voltage step, valid for all channels

- calibration voltage, referred to ECG signal input: 1 mV
calibration pulse width on recording depends on paper speed

25 mm/s	5 mm
50 mm/s	10 mm
5 mm/s	1 mm

Automatic ECG gain adjustment

The gain automatically adapts to the incoming signal. The maximum amplitude of the lead group or of all leads determines the gain setting.

- automatic adjustment range 5 to 40 mm/mV
- amplitude range (6 channels) 18 to 31 mm

Baseline

automatic adjustment of the baseline to the optimal recording range, in dependence of the signal amplitude

Anti-drift system (ADS) (cubic spline)

automatic compensation of baseline fluctuations caused by polarization voltage fluctuations at the lead electrodes (delay in recording: 4.2 s)

ECG storage

in 12 Lead Mode, storage of up to 40 ECGs

- stored ECGs can be deleted (individually or all in one pass), printed, transferred, and patient data can be edited
- when memory is full user is informed of the possible actions

Blocking

rapid charge reversal of the coupling capacitors in the preamplifiers after electrode application, ensures that the baseline is quickly restored to its original position after overranging

Electrode monitoring

audible and visual indication on the LCD of disconnected electrodes or line break; each single electrode is monitored

Text input

patient and user data as well as comments can be entered via the panel keyboard and are annotated on the recording strip

Copy function

after ECG recording in 12 Lead Mode, copies of the ECG can be printed from memory and/or transferred to a MUSE CV system (configurable)

Test

automatic performance test upon power up, including verification of the signal path starting at the signal input

stored test ECG data for demonstration of the device functions

Power supply

from the power line or from a built-in rechargeable battery, automatic switchover; automatic battery charging during line-power operation from integrated AC adapter module

Mains operation

- instrument design in protection class I according to IEC 60601-1
- Rated voltage range 95 to 240 V
- operating voltage range 85 to 264 V, 49 to 65 Hz
- rated current: 0.2 to 0.6 A
- fuse 2 x T1.25A, 5x20
- typical power consumption
battery charging 14 W
- max. power consumption 29 W

Battery operation

- type: nickel-cadmium
- rated battery voltage 18 V

- rated battery capacity 1.3 Ah
- fully charged battery sufficient for up to 50 12 Lead Mode, 1-page ECGs, if unit is only switched on to record the ECGs
- battery charge time approx. 4 hours (min. charge time for one 12 Lead Mode ECG: 10 minutes)
- battery life approx. 2 to 3 years, replacement by service only
- lithium battery for built-in clock, battery life approx. 5 years, replacement by service only

Recorder dimensions

- width 14.5 in.
- height 3.7 in.
- depth 12.6 in. (incl. handle)

Weight

- approx. 12.3 lb (with battery)

Operational readiness

After successful self-test, approx. 10 s after power-up

Operating position

horizontal

Environment

Operation

- temperature between 50 and 104 °F
- relative humidity between 25 and 95%
- atmospheric pressure between 700 and 1060 hPa

Transport and storage

- temperature between -22 and +140 °F (including battery)
- relative humidity between 25 and 95%
- atmospheric pressure between 500 and 1060 hPa

Appendix

Entering Special Characters

The following special characters can be entered by means of the appropriate keystroke combination.

charac- keystroke combination
ter

\	Alt + Q	Đ	Alt + A
@	Alt + W	Æ	Alt + J
#	Alt + E	Z	Alt + T, then Z
\$	Alt + R	Š	Alt + T, then S
&	Alt + Y	ı	Alt + X
ı	Alt + D		
—	Alt + F		
Ç	Alt + G		
Å	Alt + K		
Ü	Alt + L		
î	Alt + X		
Ñ	Alt + C		
"	Alt + V		
Ø	Alt + B		
Ö	Alt + N		
Ä	Alt + M		
Á	Alt + I, then A		
É	Alt + I, then E		
Í	Alt + I, then I		
Ó	Alt + I, then O		
Ú	Alt + I, then U		
À	Alt + O, then A (enter È, Ì, Ò, Ù in the same manner)		
Â	Alt + P, then A (enter Ê, Î, Ô, Û in the same manner)		
ÿ	Alt + U, then Y (enter Ĩ, Ä, Ö, Ü in the same manner)		
Ã	Alt + H, then A (enter Ñ, Õ in the same manner)		

Index

1		E	
12 Lead mode, brief operating instructions	38	ECG recording during defibrillation	46
12 Lead mode, system defaults	26	ECG transmission (modem)	32
12 Lead mode, system setup	47	ECG transmission to MUSE CV system	34, 35
12SL interpretation, configuration	48	ECG transmission via modem	32
6		ECGs, receive	36
6 Lead mode, brief operating instructions	41	Electrode placement	22
6 Lead mode, system defaults	39	End of paper while printing	29
6 Lead mode, system setup	49	End of writer paper	57
A		Entering patient data	24
AC line frequency	51	Environment, operation	66
AC line interference	48, 60	Environment, storage and transport	66
Activating options	54	Event episodes	50
Aging stability (recordings)	57	External equipment, connection	19
Anti-drift system	23, 49	F	
Arrhythmia codes	45	Final report	44, 50
Arrhythmia mode	42	Functional description	9
Arrhythmia mode, brief operating instructions	45	G	
Arrhythmia mode, system defaults	42	General device settings	18
Arrhythmia mode, system setup	50	General information	6
Arrhythmia recording	50	General settings, system setup	51
Automatic baseline adjustment	23	H	
B		Heart rate limit	41, 44
Battery, charging	16	HOST system	48
Baud rate	52	I	
Birthdate, enter	25	ID number, MUSE	51
Brief operating instructions, 12 Lead mode	38	Indicators, overview	10
Brief operating instructions, 6 Lead mode	41	Installation	17
Brief operating instructions, arrhythmia mode	45	Intended use	9
C		Interpretation, enable - disable	48
Cart number, enter	51	Interpretation, print	48
Cart to cart communication	37	L	
Caution, definition	12	Language	51
Cleaning	58	Lead fail beep	51
Connecting external equipment	19	Lead labels	51
Contrast, adjustment	17	Limb lead electrodes, application	21
Controls, overview	10	Lithium battery	60
Cubic spline	23	Location number, enter	25, 51
D		M	
Danger, definition	12	Mains connection	17
Date	51	Maintenance	58
Detailed results	31, 47	Master password	52
Disinfection	58	Medication	25
Display backlighting	51	Memory (optional MEMO function)	29
Disposal of the device	59	Memory option	26
		Modem	32

Index

Modem setup	37	Room number, enter	25
Muscle artifact	48		
Muscle filter	48		
MUSE CV Information System	19		
		S	
		Safety information	12
		Saving ECGs	29
		Secondary patient ID, enter	25
		Self-test, abort	17
		Service parts, how to order	4
		Service requests, where to call	5
		Setup	47
		Site number, enter	51
		Software version	2
		Specifications	62
		Standard leads	22
		Supplies, how to order	4
		Symbols, explanation	11
		System defaults, 12 Lead mode	26
		System defaults, 6 Lead mode	39
		System defaults, arrhythmia mode	42
		System setup, 12 Lead mode	47
		System setup, 6 Lead mode	49
		System setup, Arrhythmia mode	50
		System setup, general settings	51
		T	
		Technical specifications	62
		Technical support	4
		Test DATA	52
		Thorax electrodes, application	22
		Time	51
		Trend recording	50
		Troubleshooting	60
		U	
		Units	51
		W	
		Warning, definition	12
O			
Option codes	3, 54		
Options, how to activate	54		
Options, overview	9		
Order number, enter	25		
Ordering physician	25		
Override function	48		
P			
Pacemaker patient	46		
Paper feed, automatic	49		
Paper jam	60		
Paper, inserting new pad	56		
Password protection (setup menu)	52		
Patient data setup	53		
Patient data, entry	24		
Patient ID, enter	25		
Patient name, enter	25		
Performance check	17		
Physician, referring, ordering	25, 51		
Power supply	16		
Prompts	53		
Protocols	52		
R			
Receiving ECGs	36		
Recharging the battery	16		
Recording in 12 Lead mode	27		
Recording in 6 Lead mode	39		
Recording in Arrhythmia mode	43		
Recording problems	23		
Referring physician	25		
Report formats, 12 Lead mode	31		
Revision code	2		
Revision history	2		