Biotechnology Explorer™

Restriction Digestion and Analysis of Lambda DNA Kit

Instruction Manual

Catalog #166-0002EDU

explorer.bio-rad.com

The kit is packaged and shipped as two modules. **Open the modules immediately upon receipt** and store components at -20°C , 4°C , or room temperature as indicated.

Duplication of any part of this document
is permitted for classroom use only.



A Complete Teaching Guide

Developed over 5 years, Biotechnology Explorer kits and curricula have been written for teachers by teachers, and have been extensively field-tested in a broad range of classroom settings from high school through the undergraduate level. Easy-to-use Biotechnology Explorer kits are the perfect way to bring the excitement of biotechnology into the classroom. Each kit contains an innovative step-by-step protocol, which makes it the perfect choice for both experienced and beginning teachers.

The curriculum contained within the manual for each kit makes our products unique. Each kit contains its own curriculum manual which is divided into a Teacher's Guide and Student Manual. The Teacher's Guide contains background information and lecture topics that will enable each teacher, whether experienced or a newcomer to biotechnology, to prepare and design lectures and lessons which can precede the actual labs. This advance preparation will ensure that the labs run smoothly and that the students will understand the concepts behind each laboratory.

The manual also contains a section on the laboratory setup, complete with detailed procedures and graphic diagrams to assist you in the advance preparation for the laboratories. In addition, this section contains timetables that will help you plan your schedule. Each laboratory can be performed in a 50-minute period, which should fit into most schedules. The laboratory activities can also be combined and performed in a single 3-hour block period. Finally, we provide a detailed Teacher's Answer Guide that contains answers to all of the questions posed in the Student Manual. The teacher can use these answers as a guide when reviewing or grading the questions presented in the student section of the manual.

Each kit is designed to maximize student involvement in laboratory activities and the thought questions embedded in the manual. Student involvement in this process results in an increased understanding of the scientific process and the value of proceeding into a task in an organized and logical fashion. Students who engage in the science curriculum found in the Bio-Rad Biotechnology Explorer kits develop a positive sense of their ability to understand the scientific method.

We strive to continually improve our curriculum and products. Your input is extremely important to us. Incorporation of your ideas, comments, critiques, and suggestions will enable the Biotechnology Explorer products to evolve into even better teaching aids.

You can download this complete instruction manual on the Internet. Visit us on the Web at explorer.bio-rad.com or call us in the US at 1-800-4BIORAD (1-800-424-6723).

Ron Mardigian
Director, Biotechnology Explorer Program
ron_mardigian@bio-rad.com

Table of Contents

Teacher's Guide		Page
Overview for the Teacher		1
Kit Inventory Checklist.....		3
Background		4
Workstation Checklist		8
Teacher's Advance Preparation		9
Lesson 1		
Aliquot Restriction Enzymes		9
Aliquot Restriction Buffer.....		9
Aliquot Lambda DNA		9
Prepare Agarose Gels		9
Practice Using Micropipets (Optional)		12
Lesson 2		
Prepare and Aliquot DNA Marker		13
Aliquot Sample Loading Dye.....		13
Prepare the Electrophoresis Chamber		13
Prepare Fast Blast DNA Stain.....		14
Dry Agarose Gels		15
Quick Guide		16
Student Manual		
Overview		20
Lesson 1	Introduction to Restriction Analysis	21
	Restriction Digestion (Laboratory Procedure).....	24
	Review Questions	25
Lesson 2	Agarose Gel Electrophoresis (Laboratory Procedure)	28
	Review Questions	30
	Staining DNA with Fast Blast DNA Stain (Laboratory Procedure)	32
	Quick Staining.....	32
	Overnight Staining	34
Lesson 3	Analysis of Results	36
Appendices		
Appendix A	Teacher's Answer Guide	45
Appendix B	Complete Lambda Genome Analysis.....	56

Overview for the Teacher

Restriction Analysis — Links to Biotechnology

The techniques introduced in this exercise form the basis of recombinant DNA technology techniques, DNA fingerprinting, and forensic DNA analysis.

This kit introduces students to some important principles of genetic engineering. Specifically, the functions of restriction enzymes and their use as molecular biology tools will be stressed. Using agarose gel electrophoresis, students will examine the digestion patterns, analyze the migration distances, and determine the sizes of unknown DNA fragments.

Restriction enzymes were a catalyst for the molecular biology revolution, and now hundreds of such enzymes are known. In this investigation, the restriction enzymes *EcoRI*, *PstI*, and *HindIII* will be used to digest bacteriophage lambda DNA. Gel electrophoresis will be employed to separate the resulting DNA fragments, and a nontoxic blue dye (Fast Blast™ DNA stain) will be used to stain the DNA fragments for visualization.

Introduction to Guided Investigation

The intent of this curriculum is to guide students through the thought process involved in a laboratory-based scientific procedure. The focus here is not so much on the answer or result, but rather how the result was obtained and how it can be substantiated by careful observation and analysis of data. This is referred to as a “guided inquiry-based laboratory investigation”.

At each step along the way, student understanding of the process and the analysis of data is stressed. Instead of providing students with explanations or interpretations, the manual poses a series of questions to focus and stimulate students to think about all aspects of the investigation.

Intended Audience

This investigation is intended for use by any high school or college student, independent of the degree of prior familiarity with the chemistry of nucleic acids.

Student Objectives

- Understand the use of restriction enzymes as biotechnology tools
- Become familiar with principles and techniques of agarose gel electrophoresis
- Generate a standard curve from a series of DNA size standards
- Estimate DNA fragments sizes from agarose gel data

Safety Issues

Eating, drinking, smoking, and applying cosmetics are not permitted in the work area. Wearing protective eyewear and gloves is strongly recommended. Students should wash their hands with soap before and after this exercise. If any of the solutions gets into a student's eyes, flush with water for 15 minutes. Although Fast Blast DNA stain is not toxic, latex or vinyl gloves should be worn while handling the stain to keep hands from becoming stained. Lab coats or other protective clothing should be worn to avoid staining clothes.

Storage Temperatures

The kit is packaged and shipped as two modules. **Open the modules immediately upon receipt** and store components at -20°C , 4°C , or room temperature as indicated.

Implementation Timeline*

There are three student lessons in this manual. Each lesson is designed to be carried out in a 50-minute period. The lessons include:

- A series of prelaboratory considerations for students
- An active student investigation
- Questions for analysis and interpretation of results

Lesson 1 Introduction to Restriction Analysis

Consideration 1

Pour gels and digest DNA samples

Lesson 2 Agarose Electrophoresis

Considerations 2 and 3

Load and run gels

Stain gels (record results and dry gels if using the quick staining protocol)

Lesson 3 Analysis of Results

Record results and dry gels

(if using the overnight staining protocol)

Analyze results

Complete analysis questions

Generate standard curve

Discuss results

* The laboratory activities above can also be performed in a single 3-hour block period.

Kit Inventory Checklist

This section lists the components provided in the Biotechnology Explorer restriction digestion and analysis of lambda DNA kit. It also lists required and optional recommended accessories. Each kit is sufficient to outfit 8 student workstations (4 students per workstation). All reagents are packaged at their working concentration (1x) unless otherwise noted. Use this as a checklist to inventory your supplies upon receipt of the kit and before beginning the experiment.

Kit Contents	Quantity per Kit	(✓)
<i>Hind</i> III lambda digest, 0.2 µg/µl, 100 µl	1 vial	<input type="checkbox"/>
<i>Hind</i> III restriction enzyme, 500 units, 40 µl	1 vial	<input type="checkbox"/>
<i>Pst</i> I restriction enzyme, 500 units, 40 µl	1 vial	<input type="checkbox"/>
<i>Eco</i> RI restriction enzyme, 500 units, 40 µl	1 vial	<input type="checkbox"/>
Restriction buffer, 2x, 500 µl	1 vial	<input type="checkbox"/>
Lambda DNA uncut, 0.2 µg/µl, 100 µl	1 vial	<input type="checkbox"/>
Sample loading dye, 5x, 1 ml	1 vial	<input type="checkbox"/>
Fast Blast™ DNA stain, 500x, 100 ml	1 bottle	<input type="checkbox"/>
Colored micro test tubes	60	<input type="checkbox"/>
Foam micro test tube holders	8	<input type="checkbox"/>
Agarose, 5 g	1	<input type="checkbox"/>
Electrophoresis buffer, 50x TAE, 100 ml	1 bottle	<input type="checkbox"/>
Staining trays	4	<input type="checkbox"/>

Required Accessories Not Included in the Kit	Quantity per Station	(✓)
Adjustable micropipet, 2–20 µl, catalog #166-0506EDU	1	<input type="checkbox"/>
Horizontal electrophoresis chamber (Mini-Sub® Cell GT cell), catalog #166-4000EDU	1	<input type="checkbox"/>
Power supply, catalog #164-5050EDU	1	<input type="checkbox"/>
Permanent markers	1	<input type="checkbox"/>
Millimeter ruler	1	<input type="checkbox"/>
Laboratory tape (not 3M Scotch brand or similar tape)	1	<input type="checkbox"/>

Additional Required Accessories

Not Included in the Kit	Quantity per Kit	(✓)
Adjustable micropipet, 20–200 µl, catalog #166-0507EDU	1	<input type="checkbox"/>
Pipet tips, 2–200 µl, 1000/bag, catalog #223-9035EDU	1 bag	<input type="checkbox"/>
Microwave oven or hot plate	1	<input type="checkbox"/>

Recommended (Optional) Accessories

	Quantity per Kit	(✓)
Microcentrifuge, catalog #166-0602EDU	1	<input type="checkbox"/>
or mini centrifuge, catalog #166-0603EDU	4	<input type="checkbox"/>
Gel support film (50 sheets), catalog #170-2984EDU	1 pack	<input type="checkbox"/>
Rocking platform, catalog #166-0709EDU	1	<input type="checkbox"/>
Water bath, catalog #166-0504EDU	1	<input type="checkbox"/>
or Mini incubation oven, catalog #166-0501EDU		

Refills Available Separately

Fast Blast DNA stain, 500x, 100 ml, catalog #166-0420EDU
 Molecular biology agarose, 25 g, catalog #161-3103EDU
 Restriction Digestion Kit Refill package, catalog #166-0012EDU (contains *Hind*III, *Pst*I, and *Eco*RI restriction enzymes, restriction buffer, uncut lambda DNA, *Hind*III lambda DNA digest, sample loading dye, and Fast Blast DNA stain)

Note: Either 1x TBE (Tris-borate-EDTA) or 1x TAE (Tris-acetate-EDTA) buffer can be used for agarose gel electrophoresis. Instructions for preparing and using 1x TAE are given in this manual since 50x TAE concentrate is included in this kit.

Background

DNA splicing, the cutting and linking of DNA molecules, is one of the basic tools of modern biotechnology. The basic concept behind DNA splicing is to remove a functional DNA fragment — let's say a gene — from one organism and to combine it with the DNA of another organism in order to study how the gene works. The desired result of gene splicing is for the recipient organism to carry out the genetic instructions provided by its newly acquired gene. For example, certain plants can be given the genes for resistance to pests or disease, and in a few cases to date, functional genes have been given to people with nonfunctional genes, such as those who have a genetic disease like cystic fibrosis.

This activity may be used to simulate the real world application of gene splicing. You may suggest to your students that the DNA they are working with represents a chromosome that has been cut into many fragments. Of the fragments that are produced, one particular fragment may represent a specific gene. This imaginary gene can code for any number of traits, but before it can be given to a recipient organism, your students must first identify the gene by its size using agarose gel electrophoresis.

Restriction Enzymes

The ability to cut and paste, or cleave and ligate, a functional piece of DNA predictably and precisely is what enables biotechnologists to recombine DNA molecules. This is termed recombinant DNA technology. The first step in DNA splicing is to locate a specific gene of interest on a chromosome. A restriction enzyme is then used to cut out the targeted gene from the rest of the chromosome. This same enzyme is also used to cut the DNA of the recipient into which the fragment will be inserted.

Restriction enzymes are proteins that cut DNA at specific sites. Restriction enzymes, also known as restriction endonucleases, recognize specific sequences of DNA base pairs and cut, or chemically separate, DNA at that specific arrangement of base pairs. They were first identified in and isolated from bacteria that use them as a natural defense mechanism to cut up the invading DNA of bacteriophages — viruses that infect bacteria. Any foreign DNA encountering a restriction enzyme will be digested, or cut into many fragments, and rendered ineffective. These enzymes in bacteria make up the first biological immune system. There are thousands of restriction enzymes, and each is named after the bacterium from which it is isolated. For example:

EcoRI = The first restriction enzyme isolated from *Escherichia coli* bacteria

HindIII = The third restriction enzyme isolated from *Haemophilus influenzae* bacteria

PstI = The first restriction enzyme isolated from *Providencia stuartii* bacteria

Each restriction enzyme recognizes a specific nucleotide sequence in the DNA, called a restriction site, and cuts the DNA molecule at only that specific sequence. Many restriction enzymes leave a short length of unpaired bases, called a “sticky” end, at the DNA site where they cut, whereas other restriction enzymes make a cut across both strands creating double-stranded DNA fragments with “blunt” ends. In general, restriction sites are palindromic, meaning the sequence of bases reads the same forwards as it does backwards on the opposite DNA strand.

For example, here is a list of enzymes and the sites where they cut:

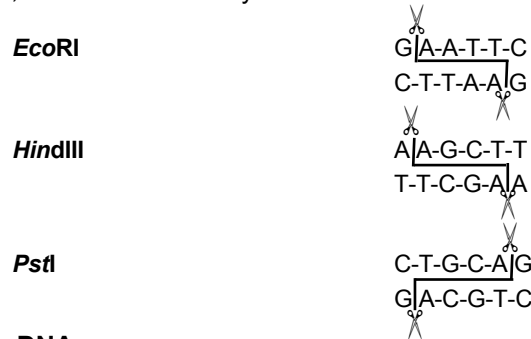

Lambda Phage DNA

Lambda DNA is the genomic DNA of a bacterial virus, or bacteriophage (phage), which attacks bacteria by inserting its nucleic acid into the host bacterial cell. Lambda is a phage that replicates rapidly inside host cells until the cells burst and release more phages to carry out the same infection process in other bacterial host cells. Bacteriophage lambda is harmless to man and other eukaryotic organisms, and therefore makes an excellent source of DNA for experimental study.

In this investigation, students observe the effects of three restriction enzymes on lambda DNA. Since the lambda genome is approximately 48,000 base pairs, each restriction enzyme will cut the DNA several times and generate restriction fragments of different sizes. In this activity, three separate samples of lambda DNA will be cut using three different restriction enzymes, and one sample will remain undigested. Each sample produces DNA fragments whose sizes can be estimated when run on an agarose gel using electrophoresis.

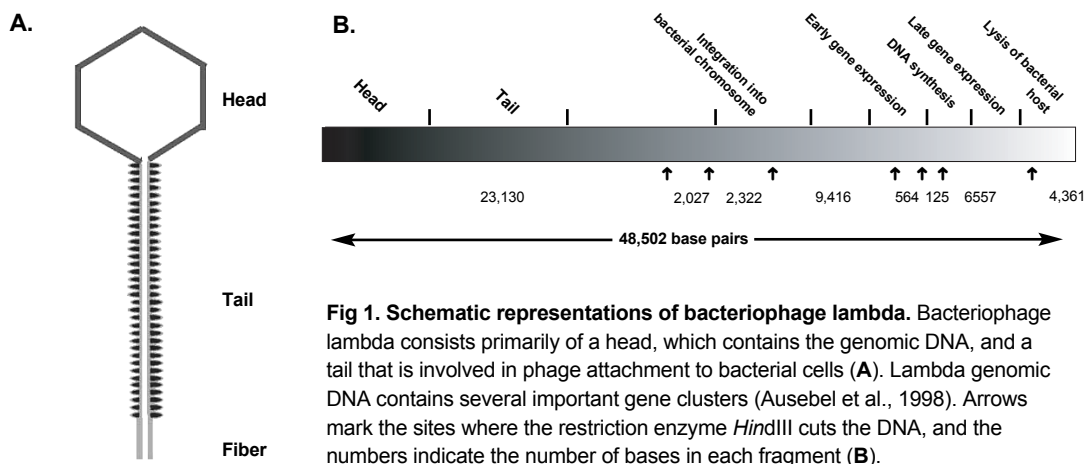

Electrophoretic Analysis of Restriction Fragments

A restriction enzyme acts like molecular scissors, making cuts at the specific sequence of base pairs that it recognizes. The three-dimensional structure or shape of a restriction enzyme allows it to fit perfectly in the groove formed by the two strands of a DNA molecule. When attached to the DNA, the enzyme slides along the double helix until it recognizes a specific sequence of base pairs which signals the enzyme to stop sliding. The enzyme then chemically separates, or cuts, the DNA molecule at that site — called a restriction site.

If a specific restriction site occurs in more than one location on a DNA molecule, a restriction enzyme will make a cut at each of those sites, resulting in multiple fragments of DNA. Therefore, if a given piece of linear DNA is cut with a restriction enzyme whose specific recognition sequence is found at five different locations on the DNA molecule, the result will be six fragments of different lengths. The length of each fragment will depend upon the location of restriction sites on the DNA molecule.

A DNA fragment that has been cut with restriction enzymes can be separated using a process known as **agarose gel electrophoresis**. The term electrophoresis means to *carry with electricity*. Agarose gel electrophoresis separates DNA fragments by size. DNA fragments are loaded into an agarose gel slab, which is placed into a chamber filled with a conductive buffer solution. A direct current is passed between wire electrodes at each end of the chamber. Since DNA fragments are negatively charged, they will be drawn toward the positive pole (anode) when placed in an electric field. The matrix of the agarose gel acts as a molecular sieve through which smaller DNA fragments can move more easily than larger ones. Therefore, the rate at which a DNA fragment migrates through the gel is inversely proportional to its size in base pairs. Over a period of time, smaller DNA fragments will travel farther than larger ones. Fragments of the same size stay together and migrate in single bands of DNA. These bands will be seen in the gel after the DNA is stained.

An analogous situation is one where all the desks and chairs in the classroom have been randomly pushed together. An individual student can wind his/her way through the maze quickly and with little difficulty, whereas a string of four students would require more time and have difficulty working their way through the maze.

Making DNA Visible

DNA is colorless so DNA fragments in the gel cannot be seen during electrophoresis. A loading dye containing two blue dyes is added to the DNA solution. The loading dye does not stain the DNA itself but makes it easier to load the gels and monitor the progress of the DNA electrophoresis. The dye fronts migrate toward the positive end of the gel, just like the DNA fragments. The “faster” dye comigrates with DNA fragments of approximately 500 bp, while the “slower” dye comigrates with DNA fragments approximately 5 kb in size. Staining the DNA pinpoints its location on the gel. When the gel is immersed in Fast Blast DNA stain, the stain molecules attach to the DNA trapped in the agarose gel. When the bands are visible, your students can compare the DNA restriction patterns of the different samples of DNA.

The band patterns that will be obtained by your students following electrophoresis of DNA samples that have been digested using three different restriction digestion enzymes are shown in Figure 2. By convention, the lanes are numbered from the top left. Notice that each restriction enzyme produces a unique banding pattern in each lane. The relative size of fragments in each band can be determined by measuring how far each band has traveled from its origin. Since the fragment sizes are known for the *Hind*III lambda digest, this sample will function as a DNA standard or marker.

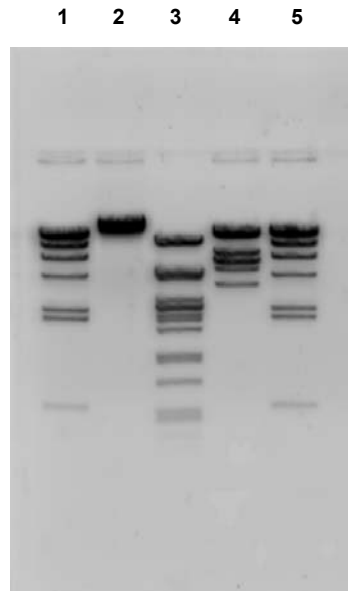

Fig. 2. Electrophoresis of lambda DNA digested using three different restriction enzymes. Lane 1, DNA markers (*Hind*III lambda digest); lane 2, uncut lambda DNA; lane 3, lambda DNA digested with *Pst*I; lane 4, lambda DNA digested with *Eco*RI; lane 5, lambda DNA digested with *Hind*III.

References

Ausubel FM et al., Current Protocols in Molecular Biology, John Wiley and Sons, New York (1998)

Workstation Checklist

Student Workstations. Materials and supplies that should be present at each student workstation prior to beginning each laboratory experiment are listed below. The components provided in this kit are sufficient for 8 student workstations (4 students per workstation).

Teacher's (Common) Workstation. A list of materials, supplies, and equipment that should be present at a common location, which can be accessed by all student groups, is also listed below. It is up to the discretion of the teacher as to whether students should access common buffer solutions and equipment, or whether the teacher should aliquot solutions and operate equipment. To avoid the potential for contamination and spills, you may choose to aliquot stock solutions of DNA and enzymes for the students. All other reagents should be kept at the front of the room for student teams to access as they need them.

	Quantity per Station	(✓)
LESSON 1		
Student Workstations		
Agarose gel electrophoresis system (Electrophoresis chamber, gel tray, 8-well comb)	1	<input type="checkbox"/>
Laboratory tape (not 3M Scotch brand or similar tape)	1 roll	<input type="checkbox"/>
Permanent marker	1	<input type="checkbox"/>
Micropipet, 2–20 μ l	1	<input type="checkbox"/>
Pipet tips, 2–200 μ l	20	<input type="checkbox"/>
Empty micro test tubes (4 colors)	1	<input type="checkbox"/>
Foam micro test tube holder	1	<input type="checkbox"/>
Teacher's Workstation		
Molten 1% agarose in 1x TAE	40–50 ml per gel	<input type="checkbox"/>
Three restriction enzymes on ice (<i>Hind</i> III, <i>Eco</i> RI, and <i>Pst</i> I)	8 vials of each	<input type="checkbox"/>
Lambda DNA	8 vials	<input type="checkbox"/>
Restriction buffer	8 vials	<input type="checkbox"/>
37°C waterbath or incubator (optional)	1	<input type="checkbox"/>
LESSON 2		
Student Workstation		
Agarose gel electrophoresis system	1	<input type="checkbox"/>
Agarose gel	1	<input type="checkbox"/>
Electrophoresis power supply	1	<input type="checkbox"/>
Micropipet, 2–20 μ l	1	<input type="checkbox"/>
Pipet tips, 2–200 μ l	20	<input type="checkbox"/>
Foam micro test tube holder	1	<input type="checkbox"/>
Sample loading dye	1 vial	<input type="checkbox"/>
<i>Hind</i> III lambda digest (DNA marker)	1 vial	<input type="checkbox"/>
Permanent marker	1	<input type="checkbox"/>
Gel support film (if applicable)*	1 sheet	<input type="checkbox"/>
Fast Blast DNA stain, 1x or 100x*	120 ml per 2 stations	<input type="checkbox"/>
Gel staining tray	1 per 2 stations	<input type="checkbox"/>
Large containers for destaining (if applicable)*	1–3 per 2 stations	<input type="checkbox"/>
Teacher's workstation		
Electrophoresis buffer (1x TAE)	275 ml per gel	<input type="checkbox"/>
LESSON 3		
Student Workstation		
Gel support film (if applicable)*	1 sheet	<input type="checkbox"/>
Millimeter ruler	1	<input type="checkbox"/>
Semilog graph paper	1	<input type="checkbox"/>
Teacher's workstation		
Rocking platform (optional)	1	<input type="checkbox"/>
Microcentrifuge	1	<input type="checkbox"/>
or Minicentrifuge (optional)	4	<input type="checkbox"/>

* Depending on whether the quick or overnight staining will be followed.

Teacher's Advance Preparation

This section describes preparation that may be performed in advance by the teacher. These procedures may be carried out 1 to 2 days ahead of time by the teacher or performed by the individual student teams during the laboratory activity.

Lesson 1: Restriction Enzymes: Molecular Scissors

Advance Preparation

Objectives	Aliquot reagents, such as restriction enzymes, buffers, and lambda DNA (optional) Pour agarose gels.* If you prefer to have your students pour their own gels during the lab, prepare the agarose ahead of time. If prepared in advance, dissolved agarose should be kept at 55–60°C until the gels are poured. Set up student and teacher workstations
Time required	Thirty minutes to 1 hour, depending on how you choose to prepare agarose gels
What is required	Electrophoresis chamber, casting trays, and combs Electrophoresis buffer (1x TAE) Agarose powder DNA loading dye

Procedures

Each student workstation will need samples of the restriction enzymes, lambda DNA, and restriction buffer. You may choose to aliquot tubes for each workstation, or you may leave the stock tubes at the front of the class for student groups to access.

1. **Aliquot restriction enzymes.** Aliquot 5 µl of each enzyme into eight clear micro test tubes (total of 24 tubes). Label the tubes: *HindIII*, *PstI*, and *EcoRI*.
Note: restriction enzymes are temperature sensitive and must be kept on ice at all times. Store enzymes in the freezer until they are ready to be used. The day of the laboratory, place the tubes on ice and distribute one tube to each team.
2. **Aliquot restriction buffer.** Aliquot 60 µl of restriction buffer into 8 clear micro test tubes. Label the tubes "RB". Place tubes on ice and distribute one tube to each team.
3. **Aliquot lambda DNA.** Aliquot 25 µl of lambda DNA into 8 clear micro test tubes. Label the tubes "lambda". Place tubes on ice and distribute one tube to each team.
4. **Prepare agarose gels.** The recommended agarose concentration for gels in this classroom application is 1% agarose. This concentration of agarose provides good resolution and minimizes run time required for electrophoretic separation of DNA fragments. The recommended thickness for the gel is 0.75–1.0 cm for easy sample loading and gel handling. **Be sure to use electrophoresis buffer, not water, to prepare agarose gels.**

* Convenient precast agarose gels (catalog #161-3057EDU) are available from Bio-Rad. These are 2 x 8-well, 1% TAE gels and fit into Bio-Rad's Mini-Sub Cell GT cell or any horizontal gel electrophoresis system that fits 7 x 10 cm gels.

- a. **Electrophoresis buffer preparation.** TAE (Tris-acetate-EDTA) electrophoresis buffer is provided as a 50x concentrated solution. In addition to the 1x TAE buffer needed to make the agarose gels, approximately 275 ml is also required for each electrophoresis chamber. Three liters of 1x TAE buffer will be sufficient to run 8 electrophoresis chambers and prepare 8 agarose gels. To make 3 L of 1x TAE from 50x TAE concentrate, add 60 ml of 50x concentrate to 2.94 L of distilled water.
- b. **Agarose preparation.** These procedures may be carried out 1 to 2 days ahead of time by the teacher or done during class by the individual student teams.
- i. To make a 1% agarose solution, use 1 gram of agarose for each 100 ml of 1x TAE electrophoresis buffer. Be sure to use electrophoresis buffer, not water.

If electrophoresis chambers are limiting, you can use a 7 x 10 cm tray and two 8-well combs to pour a gel that can be used to run two sets of student digests.

Use this table as a guide for gel volume requirements when casting single or multiple gels.

Volume of 1% agarose for:

<u>Number of gels</u>	<u>7 x 7 cm tray</u>	<u>7 x 10 cm tray</u>
1	40 ml	50 ml
2	80 ml	100 ml
4	160 ml	200 ml
8	320 ml	400 ml

- ii. Add the agarose powder to a suitable container (e.g., 500 ml Erlenmeyer flask for 200 ml or less). Add the appropriate amount of 1x TAE electrophoresis buffer and swirl to suspend the agarose powder in the buffer. If using an Erlenmeyer flask, invert a 25 ml Erlenmeyer flask into the open end of the 500 ml Erlenmeyer flask containing the agarose. The small flask acts as a reflux chamber, thus allowing long or vigorous boiling without much evaporation. The agarose can be melted for gel casting by boiling until agarose has melted completely on a magnetic hot plate, hot water bath, or in a microwave oven.

Caution: Always wear protective gloves, goggles, and lab coat while preparing and casting agarose gels. Boiling molten agarose or the flasks containing hot agarose can cause severe burns if allowed to contact skin.

Microwave oven method. This technique is the fastest and safest way to dissolve agarose. Place the gel solution in an appropriate bottle or flask into the microwave. LOOSEN THE CAP IF YOU ARE USING A BOTTLE. Use a medium setting and set to 3 minutes. Stop the microwave oven every 30 seconds and swirl the flask to suspend any undissolved agarose. Boil and swirl the solution until **all** of the small transparent agarose particles are dissolved. Set aside and cool to 55–60°C before pouring.

Magnetic hot plate method. Add a stirbar to the undissolved agarose solution. Heat the solution to boiling while stirring on a magnetic hot plate. Bubbles or foam should be disrupted before rising to the neck of the flask.

Boil the solution until all of the small transparent agarose particles are dissolved. Set aside to cool to 55–60°C before pouring gels.

Teacher's Advance Preparation

c. Procedure for Casting Gels

This laboratory activity requires that each gel has at least 4 wells. Follow the instructions above to prepare the agarose and to determine what volume of 1% agarose will be needed for your class(es). Pour enough agarose to cover the gel comb teeth or to a depth of 0.5–0.75 cm. Do not move or handle the gel tray until the gel has solidified. Solidified gels can be stored in sealable bags at room temperature for 1 day or in the refrigerator for up to 1 week before using. Have students label their plastic bags. The time needed to pour gels by an entire class is approximately 30 minutes. If possible, pour one or two extra gels for back-up. This section outlines the tape-the-tray method for casting gels. Other methods are detailed in the Sub-Cell[®] GT cell (electrophoresis chamber) instruction manual.

- i. Seal the ends of the gel tray securely with strips of standard laboratory tape (not Scotch tape or similar). Press the tape firmly to the edges of the gel tray to form a fluid-tight seal.
- ii. Level the gel tray on a leveling table or workbench using the leveling bubble provided with the chamber.
- iii. Prepare the desired concentration and amount of agarose in 1x TAE electrophoresis buffer.
- iv. Cool the agarose to at least 60°C before pouring.
- v. While the agarose is cooling to 60°C, place the comb into the appropriate slot of the gel tray. Gel combs should be placed within 1/2 inch of the end of the gel casting tray if a single-well, 7 x 7 cm gel is cast. To pour a double-well gel using a 7 x 10 cm tray and two 8-well combs, place one comb at one end of the tray and the other comb in the middle of the tray. The combs will form the wells into which the samples will be loaded.
- vi. Allow the gel to solidify at room temperature for 10 to 20 minutes. It will appear cloudy, or opaque, when ready to use.
- vii. Carefully remove the comb from the solidified gel.
- viii. Remove the tape from the edges of the gel tray.
- ix. You have two options:

Option one: If you do not have sufficient time to proceed to Lesson 2, store gels in a sealable plastic bag at room temperature for 1 day or in the refrigerator (4°C) for up to 1 week before using. Have your students label their plastic bags.

Option two: If there is sufficient time to proceed to Lesson 2, place the tray onto the leveled DNA electrophoresis chamber so that the sample wells are at the black (cathode) end of the base. DNA samples will migrate towards the red (anode) end of the chamber during electrophoresis.

Restriction Digests. A 30-minute incubation at 37°C is the optimum digestion condition. If a 37°C heating block, water bath or incubator is not available, samples can be digested by placing tubes in foam micro test tube holders, floating them in a large volume (1 liter or more) of 37°C water, and allowing them to incubate overnight as the water cools to room temperature.

Practice Using Micropipets (Optional)

We recommend that you familiarize your students with proper pipeting techniques prior to Lesson 1. Have your students learn how to transfer different volumes of a solution from one tube into another with a micropipet. Students may practice by using either sample loading dye or food coloring mixed with either a dense saturated sugar or glycerol solution. Here is a quick summary on how to use micropipets:

1. Look at the micropipet to determine the volume range.
2. Twist the dial on the micropipet to set the desired volume.
3. Attach a clean pipet tip.
4. Press the micropipet plunger to the **first** (soft) stop.
5. Insert the pipet tip into the solution to be transferred.
6. **Slowly** release the plunger to retrieve the liquid.
7. Insert the pipet tip into the desired tube.
8. Press the plunger past the first stop to the **second** (hard) stop to transfer the liquid. Make sure to keep the plunger pressed when lifting the pipet tip out of the tube.
9. Eject the pipet tip.

Lesson 2: Agarose Gel Electrophoresis and Visualization of DNA Fragments

Advance Preparation

Objectives Prepare *Hind*III lambda digest (DNA marker) and aliquot (optional)
Aliquot sample DNA loading dye (optional)
Prepare the electrophoresis chamber
Dilute Fast Blast to 1x (for overnight staining)
or 100x (for quick staining)
Set up student and teacher workstations

Time required 45 minutes

What is required *Hind*III lambda digest (DNA marker)
Sample loading dye
Electrophoresis chambers, casting trays, and combs
Electrophoresis buffer (1x TAE)
Fast Blast DNA stain, 500x

Procedures

- 1. Prepare *Hind*III lambda digest (DNA marker) and aliquot (optional).** Add 20 μ l of sample loading dye to the stock tube containing the *Hind*III lambda DNA marker. If possible, heat the marker to 65°C for 5 minutes, then chill on ice — this results in better separation of the marker bands. Label clear micro test tubes “M”. Aliquot 15 μ l of the DNA markers containing loading dye to 8 clear micro test tubes labeled “M”.
- 2. Aliquot sample loading dye.** Label eight clean micro test tubes “LD” for loading dye and aliquot 30 μ l of sample loading dye into each tube. Distribute one tube to each team.
- 3. Prepare the electrophoresis chamber.** When the agarose gel has solidified, sample loading and electrophoresis can begin.
 - When placing the gel tray into the electrophoresis chamber, make sure that the sample wells are at the black cathode end. DNA samples will migrate toward the red anode end during electrophoresis.
 - Prepare the required volume of 1x TAE buffer, if you have not prepared it already.
 - Submerge the gel under about 2 mm of 1x TAE buffer.
 - Prepare samples for gel loading. See laboratory protocol in the student section.

Note: Power requirements vary depending on gel thickness, length, and concentration, and on type of electrophoresis buffer used. For this exercise we recommend using a constant voltage of 100 V for 30 minutes.

4. Prepare Fast Blast DNA stain

- To prepare 100x stain (for quick staining), dilute 100 ml of 500x Fast Blast with 400 ml of distilled or deionized water in an appropriately sized flask or bottle and mix. Cover the flask and store at room temperature until ready to use.
- To prepare 1x stain (for overnight staining), dilute 1 ml of 500x Fast Blast with 499 ml of distilled or deionized water in an appropriately sized flask or bottle and mix. Cover the flask and store at room temperature until ready to use.

Making DNA Visible

Fast Blast DNA stain is a convenient, safe, and nontoxic alternative to ethidium bromide for the detection of DNA in agarose gels following electrophoresis. Fast Blast contains a cationic compound that is in the thiazin family of dyes. The positively charged dye molecules are attracted to and bind to the negatively charged phosphate groups on DNA molecules. The proprietary dye formula stains DNA deep blue in agarose gels and provides vivid, consistent results.

Fast Blast DNA stain is provided as a 500x concentrate that must be diluted prior to use. The stain can be used as a quick stain when diluted to **100x** to allow the visualization of DNA within 12–15 minutes or used as an overnight stain when diluted to **1x**. When the agarose gel is immersed in Fast Blast DNA stain, the dye molecules attach to the DNA molecules trapped in the agarose gel. When the DNA bands are visible, your students can compare the DNA restriction patterns of the different samples of DNA.

Detailed instructions on using Fast Blast are included in the student manual.

WARNING

Although Fast Blast DNA stain is nontoxic and noncarcinogenic, latex or vinyl gloves should be worn while handling the stain or stained gels to keep hands from becoming stained blue. Lab coats or other protective clothing should be worn to avoid staining clothes. Dispose of the staining solutions according to protocols at your facility. Use either 10% bleach solution or a 70% alcohol solution to remove Fast Blast from most surfaces. Verify that these solutions do not harm the surface prior to use.

Note:

- We recommend using 120 ml of diluted Fast Blast to stain two 7 x 7 cm or 7 x 10 cm agarose gels in individual staining trays provided in the kit (you may want to notch gel corners for identification). If alternative staining trays are used, add a sufficient volume of staining solution to completely submerge the gels.
- Following electrophoresis, agarose gels must be removed from their gel trays before being placed in the staining solution. This is easily accomplished by holding the base of the gel tray in one hand and gently pushing out the gel with the thumb of the other hand.
- Because the gel is fragile, special attention must be given when handling it. We highly recommend using a large spatula or other supportive surface to transfer the gel from one container to another during the destaining steps involved with the quick staining protocol.
- Destaining (when performing the quick staining protocol) requires the use of at least one large-volume container, capable of holding at least 500 ml, at each student workstation. Each student team may utilize separate washing containers for each wash step, or simply use a single container that is emptied after each wash and refilled for the next wash.
- 100x Fast Blast can be reused at least seven times.
- No washing or detaining is required when using the overnight staining protocol.

Teacher's Advance Preparation

To obtain a permanent record of the gel before it is dried, either trace the gel outline (including wells and DNA bands) on a piece of paper or acetate, take a photograph using standard cameras and film (Bio-Rad's standard Polaroid gel documentation system, catalog # 170-3742EDU), or photocopy the stained gel.

Drying the Agarose Gel as a Permanent Record of the Experiment

Note: Drying agarose gels requires the use of Bio-Rad's specially formulated high-strength analytical grade agarose. Other gel media may not be appropriate for this purpose.

We recommend using Bio-Rad's exclusive **gel support film** (catalog # 170-2984EDU) to dry agarose gels. Remove the stained agarose gel from its staining tray and trim away any unloaded lanes with a knife or razor blade. Place the gel directly upon the hydrophilic side of a piece of gel support film. (Water will form beads on the hydrophobic side but will spread flat on the hydrophilic side of the film.) Center the gel on the film and remove bubbles that may form between the gel and film. Place the film on a paper towel and let the gel dry, making sure to avoid direct exposure to light. As the gel dries it will bond to the film but will not shrink. If left undisturbed on the support film, the gel will dry completely at room temperature after 2–3 days. The result will be a flat, transparent, and durable record of the experiment.

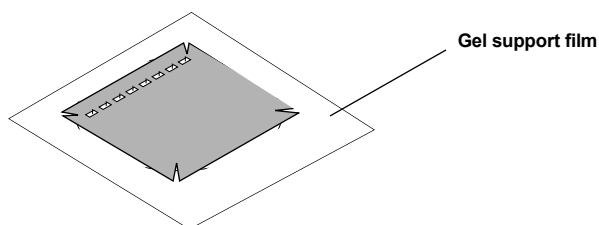

Note: Avoid extended exposure of dried gels to direct light to prevent band fading. However, DNA bands will reappear if the dried gels are stored in the dark for 2–3 weeks after fading.

Graphing the Data

Many of your students may not be familiar with logarithms and semilog graph paper. It is suggested that you prepare a short lesson to demonstrate the proper way to label the coordinates and plot the points. You might also choose to discuss the advantage of using semilog vs. standard graph paper in this instance. A math extension here can also provide an opportunity to explore linear and exponential (arithmetic and geometric) sequences of numbers. We have included semilog graph paper on page 42 of this manual.

Quick Guide For Restriction Digestion and Analysis

Lesson 1 Restriction Digestion

- Obtain micro test tubes that contain each enzyme stock solution, lambda DNA, and restriction buffer. Keep all the stock solutions on ice.

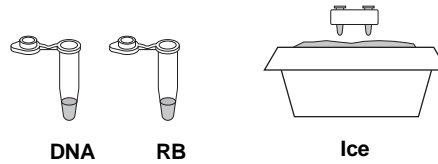

- Obtain one of each colored micro test tubes and label them as follows:
 yellow tube: **L** (lambda DNA)
 violet tube: **P** (*Pst*I lambda digest)
 green tube: **E** (*Eco*RI lambda digest)
 orange tube: **H** (*Hind*III lambda digest)

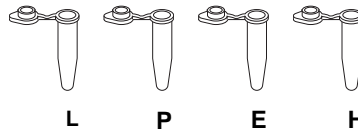

- Using a fresh tip for each sample, pipet the reagents into each tube according to the table below:

tube	DNA	buffer	<i>Pst</i> I	<i>Eco</i> RI	<i>Hind</i> III
L	4 μ l	6 μ l	–	–	–
P	4 μ l	5 μ l	1 μ l	–	–
E	4 μ l	5 μ l	–	1 μ l	–
H	4 μ l	5 μ l	–	–	1 μ l

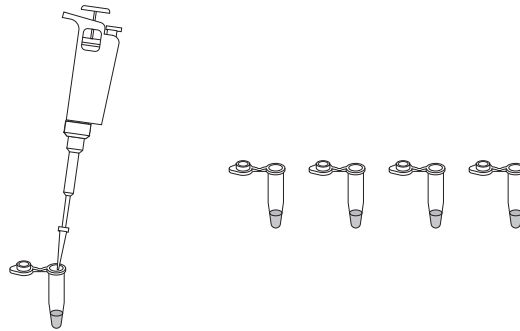

- Mix the components by gently flicking the tube with your finger and tapping gently on the table to collect liquid to the tube bottom. Pulse-spin the tubes in a centrifuge to collect all the liquid to the bottom, or tap them gently on the benchtop.

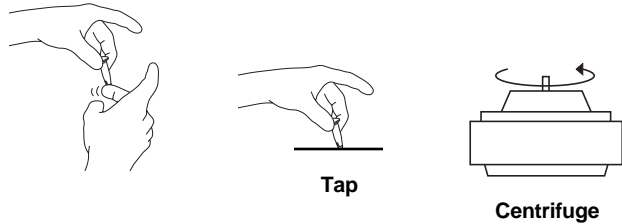

- Place the tubes in the floating rack and incubate for 30 minutes at 37°C or overnight at room temperature.

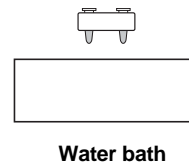

- After the incubation, place the samples in the refrigerator until the next laboratory period, or proceed directly to step 2 of Lesson 2.

Lesson 2 Agarose Gel Electrophoresis

1. Remove the digested DNA samples from the refrigerator (if applicable).

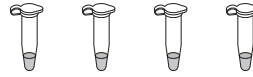

2. Add 2 μ l of sample loading dye into each tube. Mix the contents by flicking the tube with your finger. Collect the sample at the bottom of the tube by tapping it gently on the table or by pulse-spinning in a centrifuge.

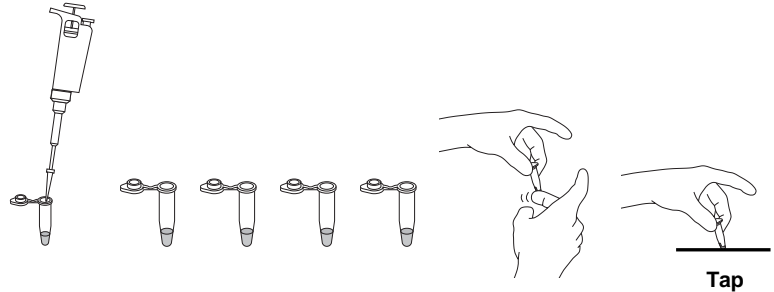

3. Obtain the DNA marker (M) from your teacher.

4. Optional: Heat your DNA samples at 65°C for 5 minutes and then put them on ice.

5. Remove the agarose gel from the refrigerator (if applicable) and remove the plastic wrap. Fill the electrophoresis chamber and cover the gel with 1x TAE buffer (about 275 ml of buffer).

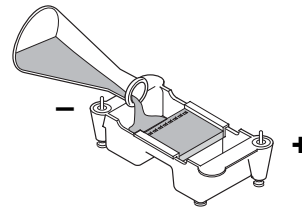

6. Check that the wells of the agarose gels are near the black (-) electrode and the bottom edge of the gel is near the red (+) electrode.

7. Load 10 μ l of each sample into separate wells in the gel chamber in the following order:

Lane	Sample
1	M, marker (clear tube)
2	L, uncut lambda DNA (yellow tube)
3	P, <i>Pst</i> I lambda digest (violet tube)
4	E, <i>Eco</i> RI lambda digest (green tube)
5	H, <i>Hind</i> III lambda digest (orange tube)

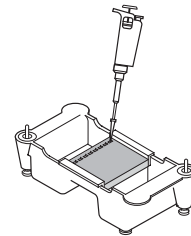

8. Carefully place the lid on the electrophoresis chamber. Connect the electrical leads into the power supply, red to red and black to black.

9. Turn on the power and run the gel at 100 V for 30 minutes.

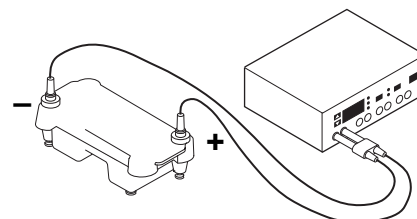

Visualization of DNA Fragments

1. When the electrophoresis run is complete, turn off the power and remove the top of the chamber. Carefully remove the gel and tray from the gel box. Be careful — the gel is very slippery. Slide the gel into the staining tray.

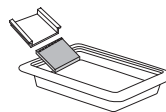

2. You have two options for staining your gel:
Quick staining (requires 12–15 minutes)

- a. Add 120 ml of **100x** Fast Blast stain into a staining tray (2 gels per tray).
- b. Stain the gels for 2 minutes with gentle agitation. Save the used stain for future use.
- c. Transfer the gels into a large washing container and rinse with warm (40–55°C) tap water for approximately 10 seconds.
- d. Destain by washing twice in warm tap water for 5 minutes each with gentle shaking for best results.
- e. Record results.
- f. Trim away any unloaded lanes.
- g. Air-dry the gel on gel support film and tape the dried gel into your laboratory notebook.

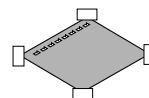
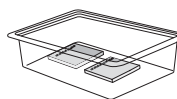
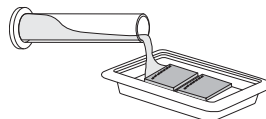

Overnight staining

- a. Add 120 ml of **1x** Fast Blast DNA stain to the staining tray (2 gels per tray).
- b. Let the gels stain overnight, with gentle shaking for best results. No destaining is required.
- c. Pour off the water into a waste beaker.
- d. Record results.
- e. Trim away any unloaded lanes.
- f. Air-dry the gel on gel support film and tape the dried gel into your laboratory notebook.

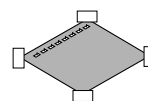
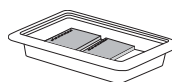
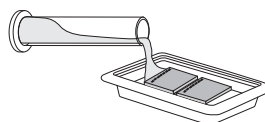

Student Manual

Restriction Digestion and Analysis of Lambda DNA Kit

Contents

Overview

Lesson 1 Introduction to Restriction Analysis

Restriction Digestion (Laboratory Procedure)

Review Questions

Lesson 2 Agarose Gel Electrophoresis (Laboratory Procedure)

Review Questions

Staining DNA with Fast Blast DNA Stain (Laboratory Procedure)

Quick Staining

Overnight Staining

Lesson 3 Analysis of Results

Introduction

Overview: How Can Pieces of DNA Solve a Puzzle?

DNA splicing, the cutting and linking of DNA molecules, is one of the basic tools of modern biotechnology. The basic concept behind DNA splicing is to remove a functional DNA fragment — let's say a gene — from the chromosome of one organism and to combine it with the DNA of another organism in order to study how the gene works. The desired result of gene splicing is for the recipient organism to carry out the genetic instructions provided by its newly acquired gene. For example, certain plants can be given the genes for resistance to pests or disease, and in a few cases to date, functional genes have been given to people with nonfunctional genes, such as those who have a genetic disease like cystic fibrosis.

In this laboratory activity, your task will be to cut (or digest) lambda DNA, the genomic DNA of a bacterial virus, and then determine the size of the DNA pieces using a procedure known as **gel electrophoresis**. This involves separating a mixture of the DNA fragments according to the size of the pieces. Once this is accomplished, you will compare your pieces of DNA with pieces of DNA whose size is already known.

Of the DNA fragments that are produced, imagine that one piece in particular represents a specific gene. This gene can code for any number of traits. But before it can be given to a recipient organism, you must first identify the gene by using gel electrophoresis.

Your tasks:

- **Cut lambda DNA into a series of fragments using restriction enzymes.**
- **To separate and sort a large group of DNA molecules according to their size.**
- **To determine the size of each molecule separated by gel electrophoresis.**

You will be provided with lambda DNA and three different restriction enzymes. The DNA restriction analysis that you are about to perform is fundamental to a variety of genetic engineering techniques, including gene splicing, DNA sequencing, gene localization, forensic DNA matching, or DNA fingerprinting. Before you begin, it might be helpful to review the structure of DNA and the activity of restriction enzymes.

Lesson 1 Introduction to Restriction Analysis

Consideration 1. How Does DNA Become Fragmented Into Pieces?

DNA consists of a series of nitrogenous base molecules held together by weak hydrogen bonds. These base pairs are in turn bonded to a sugar-phosphate backbone. The four nitrogenous bases are **adenine**, **thymine**, **guanine**, and **cytosine** (**A**, **T**, **G**, and **C**). Remember the base-pairing rule is **A - T** and **G - C**. Refer to the figure below of a DNA molecule.

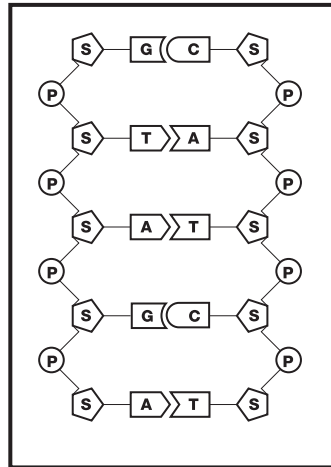

In this representation of DNA, the symbols are as follows:

Backbone:

S = Five-carbon sugar molecule known as deoxyribose

P = phosphate group

Nitrogenous Bases:

A = adenine

C = cytosine

G = guanine

T = thymine

If a **segment** of DNA is diagrammed without the sugars and phosphates, a base-pair sequence might appear as:



Look at the linear sequence of bases (**As**, **Ts**, etc.) on each of the strands.

- Describe any pattern you might see in the upper sequence of bases.
- Compare the **bases** in the upper DNA strand to those in the lower strand. Can you discover any relationship between the upper and lower strands? Describe it.
- Now look at the upper **sequence** of bases and compare it to the lower. Do you notice any grouping of bases that when read toward the right on the upper strand and read toward the left on the bottom strand are exactly the same?

You may have discovered that the sequence of base pairs is seemingly random and that the two strands are complementary to each other; **A**s are paired with **T**s, etc. You may have also noticed that a portion of the top strand, **GAATTC** (read toward the right), has a counterpart in the lower strand, **CTTAAG** (read toward the left). Similar sequences are **AAGCTT** and **TTCGAA**, and **CTGCAG** and **GACGTC**. When such a sequence is looked at together with its complementary sequence, the group reads the same in both directions. These sequences, called **palindromes**, are fairly common along the DNA molecule.

Restriction Enzymes — Molecular Scissors

Viruses called bacteriophages are major enemies of bacteria. These viruses infect bacteria by injecting their own DNA into bacteria to force the bacteria to multiply the DNA. Bacteria have responded by evolving a natural defense, called restriction enzymes, to cut up and destroy the invading DNA. Bacteria prevent digestion of their own DNA by modifying certain DNA bases within the specific enzyme recognition sequence, which allows them to protect their own DNA while cutting up foreign DNA. This could be considered a very primitive immune system. Restriction enzymes search the viral DNA for specific palindromic sequences of base pairs, such as **GAATTC**, and cut the DNA at these sites. The actual sequence of DNA is called a **restriction site**. Some restriction enzymes may leave a short length of unpaired nucleotide bases, called a “sticky” end, at the DNA site where they cut, whereas other restriction enzymes make a cut across both strands creating double stranded DNA fragments with “blunt” ends.

Look at the DNA sequence below.

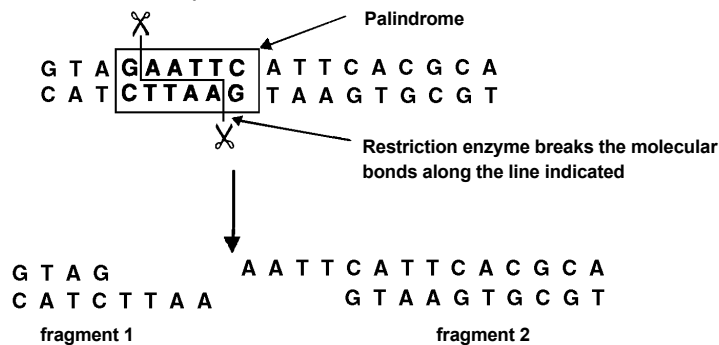

The restriction enzyme *EcoRI* cuts between **G** and **A** in the palindromic sequence **GAATTC**.

- How many base pairs are there to the left of the “cut”?

- How many base pairs are there to the right of the “cut”?

- Counting the number of base pairs, is the right fragment the same size as the left fragment?

- How could you describe the size of each fragment in terms of the number of base pairs in the fragment?

An important feature of restriction enzymes is that each enzyme only recognizes a specific palindrome and cuts the DNA only at that specific sequence of bases. A palindromic sequence can be repeated a number of times on a strand of DNA, and the specific restriction enzyme **will cut all those palindromes**, no matter what species the DNA comes from.

- If the **GAATTC** palindrome is repeated four times on the same piece of linear DNA, and the restriction enzyme that recognizes that base sequence is present and digests the DNA, how many DNA fragments will be produced?

- If the **GAATTC** palindrome repeats are randomly found along the DNA strand, then what can you say about the sizes of the fragments that will be produced when the DNA is digested with a restriction enzyme that recognizes that sequence?

The table below shows palindromic sequences that are recognized by the enzymes that are used to digest the DNA you will be analyzing in this activity.

Palindromic sequence	Name of restriction enzyme that recognizes the palindrome
GAATTC CTTAAG	<i>EcoRI</i>
AAGCTT TTCGAA	<i>HindIII</i>
CTGCAG GACGTC	<i>PstI</i>

Lesson 1 Restriction Digestion (Laboratory Procedure)

The DNA you will be provided with has been extracted from a bacteriophage — a bacterium-invading virus. The virus is known as lambda and is often written as “λ”. You will be working with three different restriction enzymes, also called endonucleases. These are referred to as *Pst*I, *Eco*RI, and *Hind*III.

Set up your restriction digest reactions:

1. Obtain micro test tubes that contain each enzyme solution, lambda DNA, and restriction buffer from the common station. Keep all the stock solutions on ice.
2. Label four micro test tubes **L**, **P**, **E**, and **H** and place them in the foam micro test tube holder.

L = Uncut lambda DNA (yellow tube)

P = *Pst*I restriction digest of lambda DNA (violet tube)

E = *Eco*RI restriction digest of lambda DNA (green tube)

H = *Hind*III restriction digest of lambda DNA (orange tube)

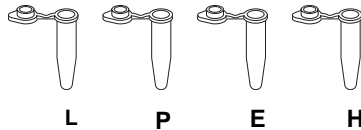

- Describe the appearance of the DNA in solution.
 - Is the DNA visible?
3. You will set up your digests in micro test tubes. To each tube, add 4 μl of uncut lambda DNA, 5 μl of restriction buffer and 1 μl of enzyme. **Add only one kind of enzyme to a tube. Do not add enzyme into the tube labeled “L”.**

Important note: First add DNA, then restriction buffer, and then the enzymes to the tubes. Use a fresh pipet tip for restriction buffer and each enzyme.

Fill in this chart as you go.

Tube	Lambda DNA	Restriction buffer	<i>Pst</i> I	<i>Eco</i> RI	<i>Hind</i> III
P	4 μl	5 μl	1 μl	–	–
E					
H					
L					

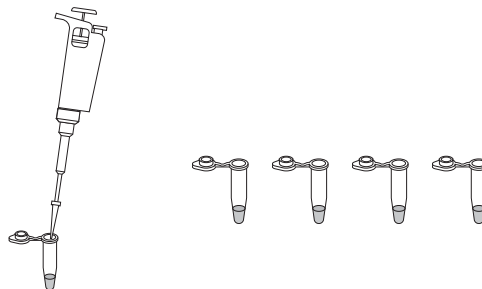

- In which tube do you expect no changes to occur—that is, no DNA fragments produced.
 - What is missing in that tube that leads you to that decision?
4. Tightly cap each tube. In order to mix all reagents, hold the top of a micro test tube between the index finger and thumb of one hand and flick the bottom of the tube with the index finger of the other hand. Gently tap the bottom of the tube on the table to collect the liquid. If you are using a centrifuge, place the four tubes from your tube into the centrifuge, being sure that the tubes are in a balanced arrangement in the rotor. Have your teacher check before spinning the tubes. Pulse-spin the tubes (hold the button for a few seconds).

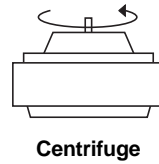
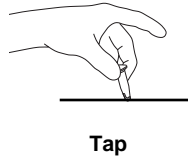
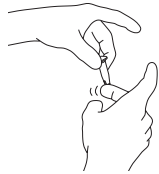

5. Place the sample tubes in a 37°C water bath for approximately 30 minutes or let them incubate at room temperature overnight. Restriction enzymes work best at 37°C since they were isolated from bacteria that live inside warm-blooded animals. After the incubation, place the samples in the refrigerator (4°C) until the next laboratory period, or proceed directly to step 2 of Lesson 2 if instructed by your teacher.

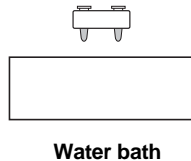

Note: While you are waiting, this a good time to cast your agarose gel, unless they have already been prepared for you. Check with your teacher for the proper procedure.

Review Questions

- Compare tube **P** to tube **L**; what do you expect to happen in the **P** tube compared to the **L** tube?
- Why do you expect this difference?
- If the DNA in the **L** tube becomes fragmented at the conclusion of the reaction, what can you conclude?
- Is there any visible change to the DNA after adding restriction enzymes?

Below is the summary of what we have learned so far:

- A sequence on one strand of DNA and its complementary sequence on the other strand can form a palindrome i.e.,

G	A	A	T	C	
C	T	T	A	A	G
- Palindromes can be detected by restriction enzymes
- Restriction enzymes cut the palindromes at restriction sites
- Restriction enzymes recognize specific palindromes
- Cutting DNA at restriction sites will produce DNA fragments
- Fragment size can be described by the number of base pairs a fragment contains

Applying What You Have Learned

A linear DNA molecule is represented below. The DNA is represented by one line, although in actuality, DNA has two strands.

- If the DNA molecule has two restriction sites, A and B, for a specific restriction enzyme, how many fragments would be produced if the DNA is cut by that enzyme?

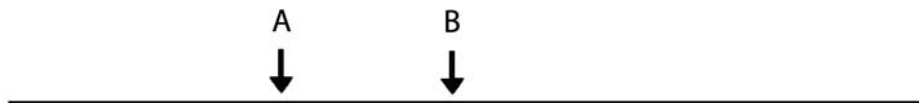

- Number each fragment.
- Which fragment would be the largest?
- Which fragment would be the smallest?

- Draw a DNA molecule that has five randomly spaced restriction sites for a specific palindrome. How many fragments would be produced if each site were cut by a restriction enzyme?
- Label each fragment.
- Rank them in order of size from largest to smallest.



In this diagram A and B are different palindrome sequences on a DNA strand. Only the restriction enzyme that recognizes site B is present.

- Explain why only two fragments would be produced.

Lesson 2 Agarose Gel Electrophoresis (Laboratory Procedure)

Part 1. Prepare Your Samples for Electrophoresis

Consideration 1. How Can Fragments of DNA Be Separated From One Another?

DNA is colorless so DNA fragments in the gel can't be seen during electrophoresis. A sample loading buffer containing two blue dyes is added to the DNA solution. The loading dyes do not stain the DNA itself but makes it easier to load the gels and monitor the progress of the DNA electrophoresis. The dye fronts migrate toward the positive end of the gel, just like the DNA fragments. The "faster" dye comigrates with DNA fragments of approximately 500 bp, while the "slower" dye comigrates with DNA fragments approximately 5 kb, or 5,000 bp, in size.

1. Following incubation, obtain your four micro test tubes **L**, **P**, **E**, and **H** and place them in the foam micro test tube holder at your laboratory desk.

L = Uncut lambda DNA (yellow tube)

P = *Pst*I restriction digest of lambda DNA (violet tube)

E = *Eco*RI restriction digest of lambda DNA (green tube)

H = *Hind*III restriction digest of lambda DNA (orange tube)

2. Set the digital micropipet to 2.0 μ l and transfer this amount of sample loading dye to each of the tubes marked **L**, **P**, **E**, and **H** in the foam tube holder. Use a fresh tip with each sample to avoid contamination.

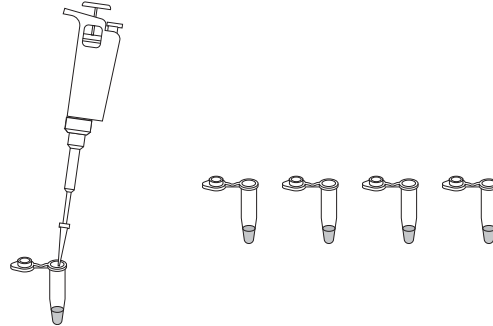

3. The DNA samples and the sample loading dye must be thoroughly mixed in each tube before placing the samples in the gel wells for electrophoresis. This is easily accomplished by holding the top of a microtube between the index finger and thumb of one hand and flicking the bottom of the tube gently with the index finger of the other hand.



Collect the liquid to the bottom of the tube by tapping it gently on your laboratory bench. If you have access to a centrifuge, place the four tubes from your foam tube holder (these tubes now have DNA and loading dye) into the centrifuge, be sure that the tubes are in a balanced arrangement in the rotor. Have your teacher check before spinning the tubes. Pulse-spin the tubes (hold the button for a few seconds). This forces all of the components to the bottom of the tube.

- Obtain the DNA marker (M) from your teacher. Optional: Heat all samples at 65°C for 5 minutes and then place the samples on ice — this results in better separation of the DNA bands.

Part 2. Set Up Your Gel Electrophoresis Chamber

- Obtain an agarose gel from your teacher, or, if your teacher instructs you to do so, pour your own gel.
- Place the casting tray, with the solidified gel in it, onto the central platform in the gel box. The wells should be at the negative (cathode) end of the box where the black electrical lead is connected. Very carefully remove the comb from the gel by gently pulling it straight up.
- Pour about 275 ml of electrophoresis buffer into the electrophoresis chamber. Pour enough buffer into the box until it just covers the wells of the gel by 1–2 mm.

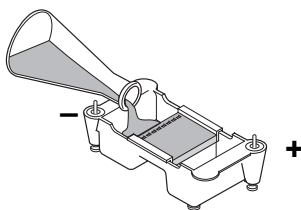

Part 3. Load your Samples and Run them by Electrophoresis

- Pipet 10 µl from each tube (**M**, **L**, **P**, **E**, and **H**) into separate wells in the gel chamber. Use a fresh tip for each tube. Gels are read from left to right. To keep things straight, the first sample is typically loaded in the well at the upper left-hand corner of the gel. For example

Lane	1	2	3	4	5
Sample	M	L	P	E	H

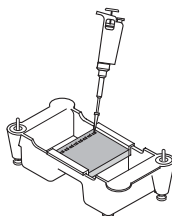

- Slide the cover of the chamber into place, and connect electrical leads to the power supply, anode to anode (red to red) and cathode to cathode (black to black). Make sure both electrical leads are attached to the same channel of the power supply.
- Electrophorese at 100 V for 30–40 minutes. Shortly after the current is applied, the loading dye can be seen moving through the gel toward the positive side of the gel chamber.
- When electrophoresis is complete, **turn off the power supply**, disconnect the leads from the inputs, and remove the top of gel chamber.
- Remove the casting tray from gel chamber. **The gel is very slippery. Hold the tray level.**
- Pour the excess buffer back into the original container for reuse, if desired.

Consideration 2. How Can Fragments of DNA Be Separated From One Another?

Agarose gel electrophoresis is a procedure used to separate DNA fragments based on their sizes. DNA is an acid and has many negative electrical charges. Scientists have used this fact to design a method that can be used to separate pieces of DNA. A solution containing a mixture of DNA fragments of variable sizes is placed into a small well formed in an agarose gel that has a texture similar to gelatin. An electric current causes the negatively-charged DNA molecules to move towards the positive electrode.

Imagine the gel as a strainer with tiny pores that allow small particles to move through it very quickly. The larger the size of the particles, however, the slower they are strained through the gel. After a period of exposure to the electrical current, the DNA fragments will sort themselves out by size. Fragments that are the same size will tend to move together through the gel and form bands.

A piece of DNA is cut into four fragments as shown in the diagram. A solution containing the four fragments is placed in a well in an agarose gel. Using the information given above, draw (to the right) how you think the fragments might be separated. Label each fragment with its corresponding letter.

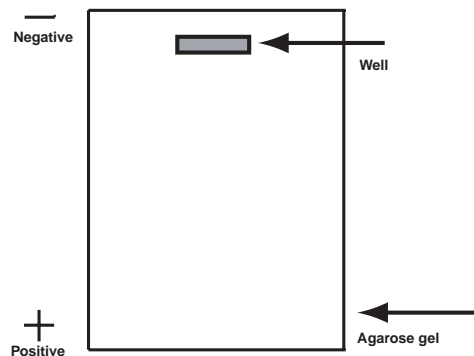
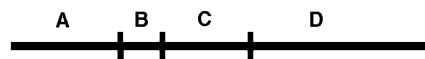

- Have your teacher check your diagram before you proceed.
- Where would the larger fragments, those with the greater number of base pairs, be located, toward the top of the gel or the bottom? Why?
- Suppose you had 500 pieces of each of the four fragments, how would the gel appear?
- If it were possible to weigh each of the fragments, which one would be the heaviest? Why?
- Complete this rule for the movement of DNA fragments through an agarose gel.

The larger the DNA fragment, the ...

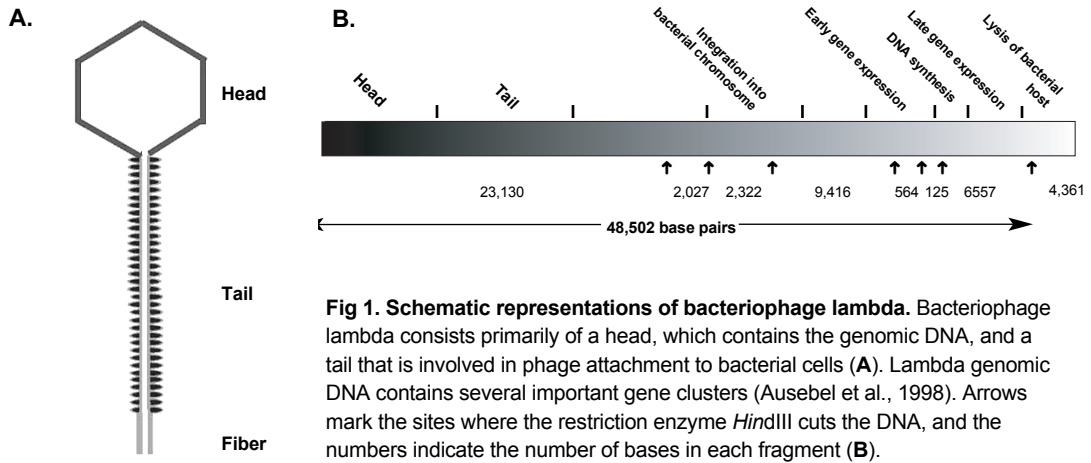
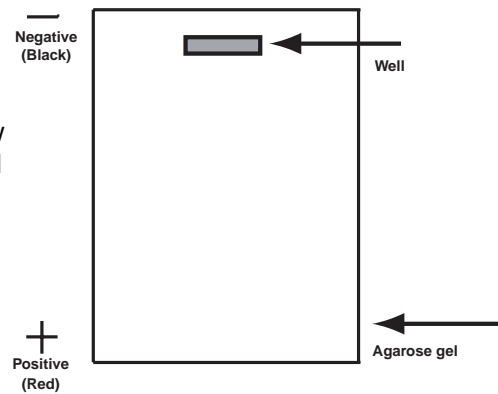

Fig 1. Schematic representations of bacteriophage lambda. Bacteriophage lambda consists primarily of a head, which contains the genomic DNA, and a tail that is involved in phage attachment to bacterial cells (A). Lambda genomic DNA contains several important gene clusters (Ausebel et al., 1998). Arrows mark the sites where the restriction enzyme *Hind*III cuts the DNA, and the numbers indicate the number of bases in each fragment (B).

- How many fragments were produced by the restriction enzyme *Hind*III?

On the gel diagram at the right, show how you believe these fragments will sort out during electrophoresis.

- Label each fragment with its correct number of base pairs.



Staining DNA with Fast Blast DNA Stain (Laboratory Procedure)

Consideration 3. How Can the DNA Be Made Visible?

- What color was the DNA before you added loading dye?

Since DNA is naturally colorless, it is not immediately visible in the gel. Unaided visual examination of the gel after electrophoresis indicates only the positions of the loading dyes and not the positions of the DNA fragments. DNA fragments are visualized by staining the gel with a blue stain called Fast Blast DNA stain. The blue stain molecules are positively charged and have a high affinity for the DNA. These blue stain molecules strongly bind to the DNA fragments and allow DNA to become visible. These visible bands of DNA may then be traced, photographed, sketched, or retained as a permanently dried gel for analysis.

There are two protocols for using Fast Blast DNA stain in the classroom. Use option 1 for quick staining of gels to visualize DNA bands in 12–15 minutes, and option 2 for overnight staining. Depending on the amount of time available, your teacher will decide which protocol to use. Two student teams will stain the gels per staining tray (you may want to notch gel corners for identification). Mark staining trays with initials and class period before beginning this activity.

WARNING

Although Fast Blast DNA stain is nontoxic and noncarcinogenic, latex or vinyl gloves should be worn while handling the stain or stained gels to keep hands from becoming stained blue. Lab coats or other protective clothing should be worn to avoid staining clothes.

Protocol 1: Quick Staining of Agarose Gels in 100x Fast Blast DNA Stain

This protocol allows quick visualization of DNA bands in agarose gels within 15 minutes. For quick staining, Fast Blast DNA stain (500x) should be diluted to a **100x** concentration. We recommend using 120 ml of 100x Fast Blast to stain two 7 x 7 cm or 7 x 10 cm agarose gels in individual staining trays provided in Bio-Rad's education kits. If alternative staining trays are used, add a sufficient volume of staining solution to completely submerge the gels.

Following electrophoresis, agarose gels must be removed from their gel trays before being placed in the staining solution. This is easily accomplished by holding the base of the gel tray in one hand and gently pushing out the gel with the thumb of the other hand. Because the gel is fragile, special attention must be given when handling it. We highly recommend using a large spatula or other supportive surface to transfer the gel from one container to another. Destaining requires the use of at least one large-volume container, capable of holding at least 500 ml, at each student workstation. Each student team may utilize separate washing containers for each wash step, or simply use a single container that is emptied after each wash and refilled for the next wash.

1. Mark the staining trays with your initials and class period. You will stain 2 gels per tray.

2. Stain gels

Remove each gel from the gel tray and carefully slide it into the staining tray. Pour approximately 120 ml of 100x stain into the staining tray. If necessary, add more 100x stain to completely submerge the gels. Stain the gels for 2–3 minutes, but not for more than 3 minutes. Using a funnel, pour the 100x stain into a storage bottle and save it for future use. **The stain can be reused at least 7 times.**

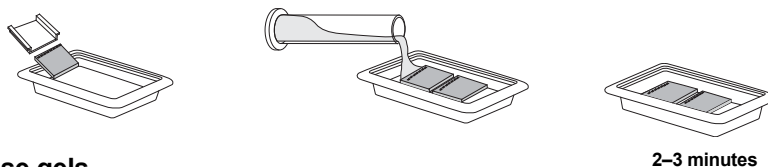

3. Rinse gels

Transfer the gels into a large container containing 500–700 ml of clean, warm (40–55°C) tap water. Gently shake the gel in the water for ~10 seconds to rinse.

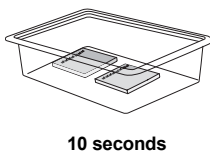

4. Wash gels

Transfer the gel into a large container with 500–700 ml of clean, warm tap water. Gently rock or shake the gel on a rocking platform for 5 minutes. If no rocking platform is available, move the gels gently in the water once every minute.

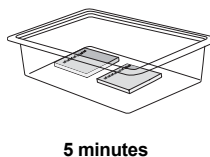

5. Wash gels

Perform a second wash as in step 4.

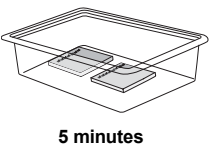

6. Analyze results

Pour off the water and examine the stained gels for expected DNA bands. The bands may appear fuzzy immediately after the second wash, but will begin to develop into sharper bands within 5–15 minutes after the second wash. This is due to Fast Blast stain molecules migrating into the gel and binding more tightly to the DNA.

To obtain maximum contrast, additional washes in warm water may be necessary. Destain to the desired level, but do not wash the gel in water overnight. If you cannot complete the destaining in the allocated time, you may transfer the gel to 1x Fast Blast stain for overnight staining. **See Protocol 2.**

- a. Place your gel on a light background and record your results by making a diagram as follows. Place a clear sheet of plastic sheet or acetate over the gel. With a permanent marker, trace the wells and band patterns onto the plastic sheet to make a replica picture of your gel. Remove the plastic sheet for later analysis. Alternatively, gels can be photocopied on a yellow piece of transparent film for optimal contrast.
- b. Dry the agarose gel as a permanent record of the experiment.
 - i. Trim away any unloaded lanes with a knife or razor blade. Cut your gel from top to bottom to remove the lanes that you did not load samples into, leaving only lanes 1–4.
 - ii. Place the gel directly upon the hydrophilic side of a piece of gel support film. (Water will form beads on the hydrophobic side of a piece of gel support film.) Center the gel on the film and remove bubbles that may form between the gel and film. Place the film on a paper towel and let the gel dry in a well-ventilated area, making sure to avoid direct exposure to light. As the gel dries it will bond to the film but will not shrink. If left undisturbed on the support film, the gel will dry completely at room temperature after 2–3 days. The result will be a flat, transparent, and durable record for the experiment.

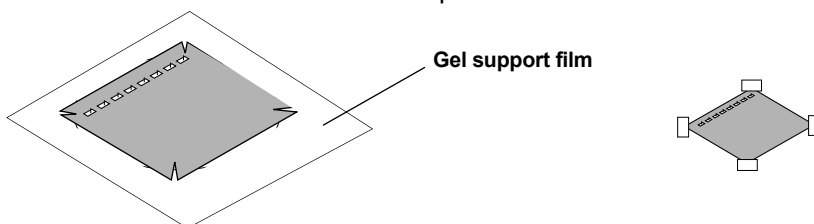

Protocol 2: Overnight Staining of Agarose Gels in 1x Fast Blast DNA Stain

For overnight staining, Fast Blast DNA stain (500x) should be diluted to a **1x** concentration. We recommend using 120 ml of 1x Fast Blast to stain two 7 x 7 cm or 7 x 10 cm agarose gels in individual staining trays provided in Bio-Rad's education kits. If alternative staining trays are used, add a sufficient volume of staining solution to completely submerge the gels.

Following DNA electrophoresis, agarose gels must be removed from their gel trays before being placed in the staining solution. This is easily accomplished by holding the base of the gel tray in one hand and gently pushing out the gel with the thumb of the other hand. Because the gel is fragile, special attention must be given when handling it.

1. Mark the staining tray with your initials and class period. You will stain 2 gels per tray.

2. Stain gels (overnight)*

Pour **1x** stain into a gel staining tray. Remove the gel from the gel tray and carefully slide it into the staining tray containing the stain. If necessary, add more 1x staining solution to completely submerge the gels. Place the staining tray on a rocking platform and agitate overnight. If no rocking platform is available, agitate the gels staining tray a few times during the staining period. You should begin to see DNA bands after 2 hours, but at least 8 hours of staining is recommended for complete visibility of stained bands.

* It is crucial that you shake gels gently and intermittently while performing the overnight staining in 1x Fast Blast stain since smaller fragments tend to diffuse without shaking.

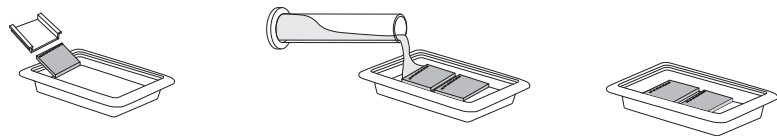

Stain overnight

2. Analyze results

No destaining is required after staining with 1x Fast Blast. The gels can be analyzed immediately after staining.

- a. Place your gel on a light background and record your results by making a diagram as follows. Place a clear sheet of plastic sheet or acetate over the gel. With a permanent marker, trace the wells and band patterns onto the plastic sheet to make a replica picture of your gel. Remove the plastic sheet for later analysis. Alternatively, gels can be photocopied on a yellow piece of transparent film for optimal contrast.
- b. Dry the agarose gel as a permanent record of the experiment.
 - i. Trim away any unloaded lanes with a knife or razor blade. Cut your gel from top to bottom to remove the lanes that you did not load samples into, leaving only lanes 1–4.
 - ii. Place the gel directly upon the hydrophilic side of a piece of gel support film. (Water will form beads on the hydrophobic side of a piece of gel support film.) Center the gel on the film on a paper towel and let the gel dry in a well-ventilated area, making sure to avoid direct exposure to light. As the gel dries it will bond to the film but will not shrink. If left undisturbed on the support film, the gel will dry completely at room temperature after 2–3 days. The result will be a flat, transparent, and durable record for the experiment.

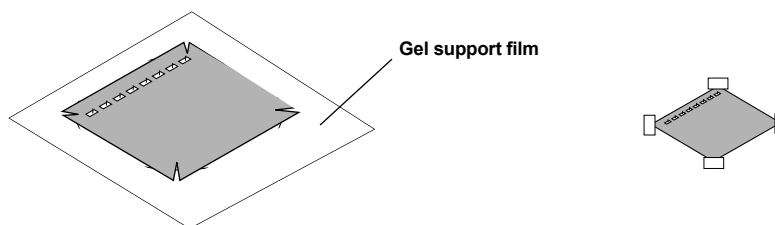

Note: Avoid extended exposure of dried gels to direct light to prevent band fading. However, DNA bands will reappear if the dried gels are stored in the dark for 2–3 weeks after fading.

Lesson 3: Analysis of Results

If the overnight staining protocol was used to stain gels, record your results and dry gels as described in the gel staining procedures in Lesson 2.

Attach the plastic sheet tracing of the banding patterns from the DNA electrophoresis below.

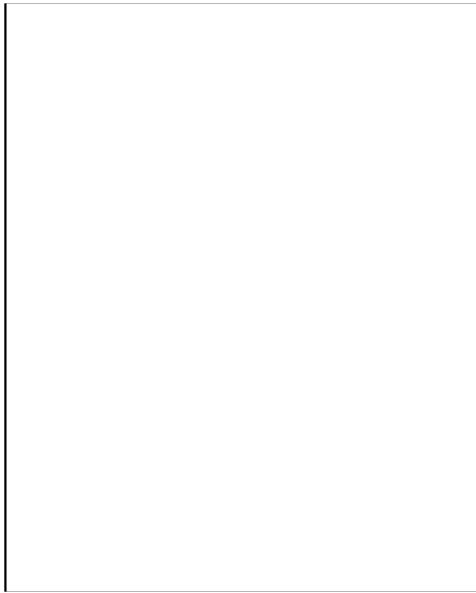

Tracing of electrophoresis gel

Attach the dried gel showing the banding patterns from the DNA electrophoresis below.

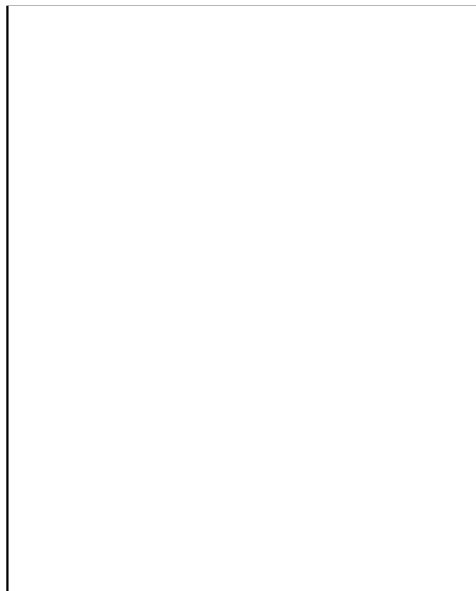

Dried electrophoresis gel

Organize Your Data

One of the first steps to analyze your data is to determine the approximate sizes of each of your restriction fragments. This can be done by comparing the DNA restriction fragments with DNA fragments of known sizes, or standards. You will use two methods to estimate the size of the fragments in the uncut lambda DNA, the *Pst*I lambda digest, and the *Eco*RI lambda digest lanes. The first method is based on visual estimation and is less precise than the second method, which involves creating a standard curve. Both methods rely on using the *Hind*III lambda digest as a DNA standard, or marker.

1. Using a ruler, measure the distance (in mm) that each of your DNA fragments or bands traveled from the well. Measure the distance from the bottom of the well to the bottom of each DNA band and record your numbers in the table on the next page.
2. Estimate the sizes, in base pairs (bp), of each of your restriction fragments. Hint: Compare the distance that the unknown bands (lambda DNA, *Pst*I digested, and *Eco*RI digested) traveled with those of the *Hind*III bands. Write the estimated sizes in the data table.
3. A more accurate way of estimating unknown DNA band sizes is to first construct a standard curve based upon the measurements obtained from the known *Hind*III lambda bands. Later in the analysis you will construct a standard curve and more accurately determine the size of each of the DNA bands.

Electrophoresis data: Measure the distance (in millimeters) that each fragment traveled from the well and record it in the table. Estimate its size, in base pairs, by comparing its position to the *HindIII* lambda DNA markers. **Remember: some lanes will have fewer than 6 fragments.**

Largest fragment first ▼	M = DNA marker		L = lambda DNA- no enzyme		P = <i>PstI</i> restriction digest of lambda DNA		E = <i>EcoRI</i> restriction digest of lambda DNA		H = <i>HindIII</i> restriction digest of lambda DNA	
	Distance in mm	Actual base pairs	Distance in mm	Estimated base pairs	Distance in mm	Estimated base pairs	Distance in mm	Estimated base pairs	Distance in mm	Estimated base pairs
Band 1		23,130								
Band 2		9,416								
Band 3		6,557								
Band 4		4,361								
Band 5		2,322								
Band 6		2,027								

Analysis of DNA Fragments

The data you entered for the lambda *Hind*III digest were the relative positions of DNA bands of known size. Since the exact size and position of these fragments are known, they can be used as standard reference points to estimate the size of unknown fragment bands. A set of fragments of known sizes is called a **molecular weight ruler** or **standards** or **marker** (or sometimes a **ladder** because of the bands' appearance).

Now look at the diagram of the agarose gel (below). It shows two **lanes**. A lane is the column below a well. The right lane contains a banding pattern from four fragments of known length (6,000, 5,000, 3,000, and 1,000 bp).

- Which lane contains the molecular weight standards? How do you know?
- Label each band in the right lane with its base-pair size.
- Compare the two lanes of bands. Estimate the size of the fragments in the left lane.

Upper band _____
Lower band _____

- How did you determine the sizes of the two bands in the left lane?

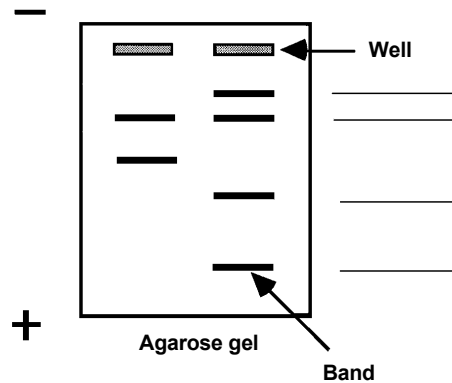

Examine the practice gel above.

- **Measure the distance in millimeters (mm)** that each band moved.
Measure from the bottom edge of the well to the bottom edge of the band.
- Record the data in the table to the right, including the unit of measurement, mm.

Left lane		Right lane	
1		1	
2		2	
		3	
		4	

The number of base pairs in each of the DNA fragments on your gel can be determined using another method that can be more accurate. This involves graphing the size of the known fragments from the DNA standards against the distance each DNA band moved through the gel, to generate a standard curve. This is most conveniently done on semilog graph paper.

Look at the data from the practice gel on page 39. The fragments of known size were plotted on semilog graph paper, producing the standard curve below.

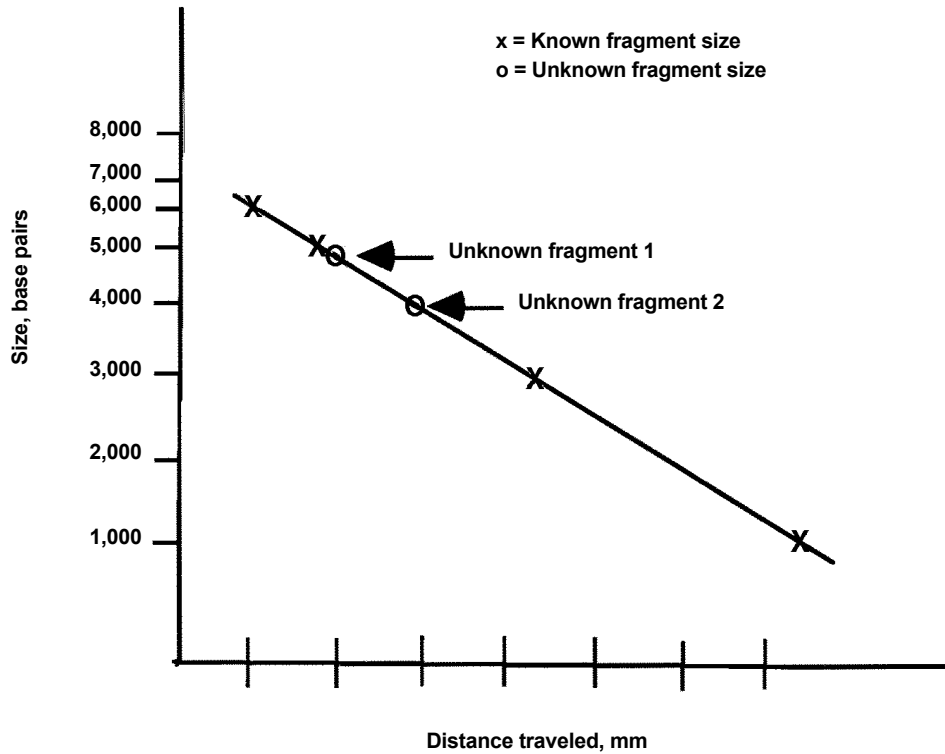

The distances migrated by two fragments of unknown length were also marked on the standard curve.

1. For each fragment, line up a ruler vertically from the distance traveled position on the horizontal x-axis to the line that you constructed.
2. From the point where your ruler intersected your line, place the ruler horizontally and note where it intersects with the vertical y-axis for fragment size. This will be your determination of the size for that fragment.

- How many base pairs does fragment 2 contain?
- How accurate is this estimation of size?

Determining the Size of the DNA Fragments by Creating a Standard Curve

From your laboratory data, you were able to estimate the approximate size of each of the DNA fragments that you separated on your gel. This was done in terms of the number of base pairs.

- Explain how you made this determination.

You have been provided with three-cycle semilog graph paper.

1. Fragment size will be on the vertical (y) axis.
2. The horizontal (x) axis is your scale for distance traveled through the gel in millimeters.
3. Using the fragments from the *Hind*III lambda digest, plot the distance traveled in relationship to fragment size for each fragment. Connect as many of the points as you can by drawing a straight line through them. This will provide a standard curve with which you will be able to determine the size of your unknown fragments from the other three samples.
4. Determine the sizes of the fragments in your uncut and digested lambda DNA samples using the method described on the previous page.

Semilog Graph Paper

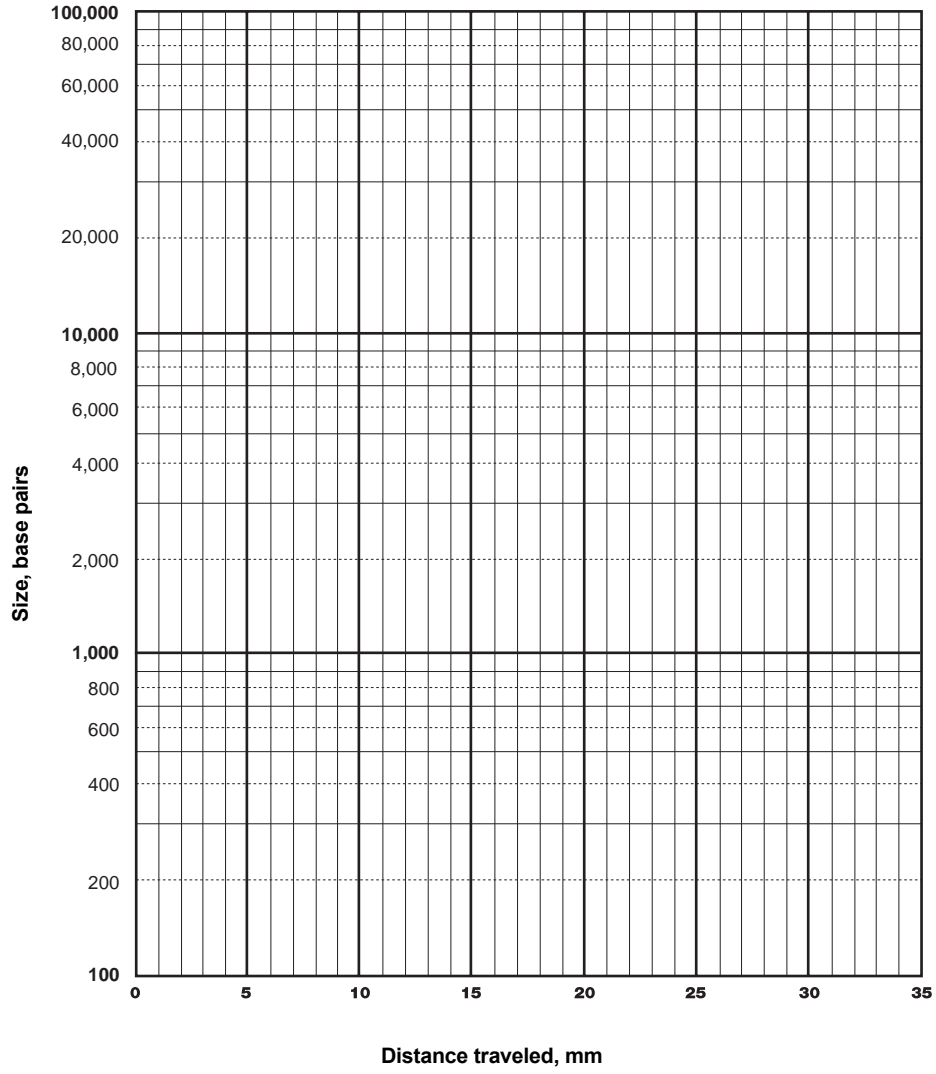

Base pair (size) determination based on standard curve. Construct your own table below to record the size of each unknown fragment as determined by the semilog graphing procedure. It might also be interesting to indicate on this same table the values you arrived at by comparing band positions in the original gel analysis. Compare the two sets of values.

	M = DNA marker		L = lambda DNA- no enzyme		P = <i>Pst</i> I restriction digest of lambda DNA		E = <i>Eco</i> RI restriction digest of lambda DNA		H = <i>Hind</i> III restriction digest of lambda DNA	
	Distance in mm	Actual base pairs	Distance in mm	Estimated base pairs	Distance in mm	Estimated base pairs	Distance in mm	Estimated base pairs	Distance in mm	Estimated base pairs
Band 1		23,130								
Band 2		9,416								
Band 3		6,557								
Band 4		4,361								
Band 5		2,322								
Band 6		2,027								

Largest fragment first

Remember that the three samples of DNA were originally the same size. Next, each sample was cut into pieces by the addition of three different restriction enzymes.

- What evidence do you have that each enzyme cuts the DNA at different locations?
- When this data table has been completed, describe what you have done to determine DNA fragment sizes in this investigation. Use no more than two sentences.
- Explain how you think you could make your DNA size estimation more accurate.
- Compare the two methods — direct gel examination and semilog graph — of determining the fragment size in base pairs. Which method seems to be more accurate? Explain your answer.

Appendix A: Teacher's Answer Guide

Lesson 1: Restriction Enzymes Consideration Questions

Look at the linear sequence of bases (As, Ts, etc.) on each of the strands.

- Describe any pattern you might see in the upper sequence of bases.

There is no specific type of pattern associated with the upper sequence of bases.

- Compare the bases in the upper DNA strand to those in the lower strand. Describe any relationship you can see.

A always pairs with T; G always pairs with C.

- Now look at the upper sequence of bases and compare it to the lower. Do you notice any grouping of bases that when read toward the right on the upper strand and read to the left on the bottom strand are exactly the same?

CTTAAG.

A restriction enzyme cuts between **G** and **A** in the palindromic sequence **GAATTC**.

- How many base pairs are there to the left of the cut?

4

- How many base pairs are there to the right of the cut?

10

- Counting the number of base pairs, is the right fragment the same size as the left fragment?

No, it is larger.

- How could you describe the fragment size in reference to the number of base pairs in the fragment?

Fragment 1 is a 4-base-pair fragment.

Fragment 2 is a 10-base-pair fragment.

- If the **GAATTC** palindrome is repeated four times on the same piece of linear DNA, and the restriction enzyme that recognizes that base sequence is present, how many DNA fragments will be produced?

5

- If the **GAATTC** palindrome repeats are randomly spaced along the DNA strand, then what can you say about the size of the fragments that will be produced when the DNA is digested with a restriction enzyme that recognizes that sequence?

Random sized fragments will be produced.

The Digestion

- Describe the appearance of the DNA in solution.

The DNA is colorless.

- Is the DNA visible?

No. DNA in solution is not visible.

Fill in this chart below as you go:

Tube	Lambda	Buffer	<i>Pst</i> I	<i>Eco</i> RI	<i>Hind</i> III
P	4 μ l	5 μ l	1 μ l		
E	4 μ l	5 μ l		1 μ l	
H	4 μ l	5 μ l			1 μ l
L	4 μ l	6 μ l			

- In which tube do you expect no changes to occur—that is, no DNA fragments produced?

The DNA in the uncut lambda DNA tube, which gets no enzyme, should remain intact as a single band.

- What is missing in that tube that leads you to that decision?

No restriction enzymes are added to that tube, thus no digestion will occur, and no fragments will be produced.

This tube (L) is the control tube.

- Compare tube P to tube L; What do you expect to happen in the P tube compared to the L tube.

The P tube contains the restriction enzyme *Pst*I. There should be an enzymatic digestion that occurs in that tube, which results in the production of restriction fragments. The L tube only contains DNA and no enzyme and so should not produce any restriction fragments.

- Why do you expect this difference?

Restriction enzymes digest DNA at specific sites. If lambda DNA contains restriction sites for the enzyme *Pst*I, then the DNA should be cut into fragments. With no added enzyme, no digestion should occur.

- If the DNA in tube L becomes fragmented at the conclusion of the reaction, what can you conclude?

Most likely a restriction enzyme was inadvertently added to the L tube. This could have happened by accidentally adding an enzyme to the tube, or by not changing pipet tips, which could result in enzyme being carried over between tubes.

- Is there any visible change to the DNA after adding restriction enzymes?

No. The DNA still appears colorless.

Applying What You Have Learned

- If a DNA molecule has two restriction sites, A and B, for a specific restriction enzyme, how many fragments would be produced, if it is cut by that enzyme?

3

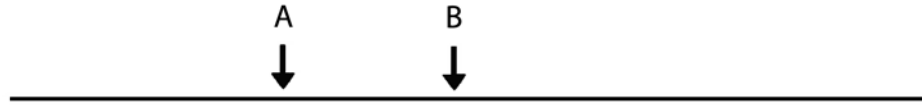

- Number each fragment.

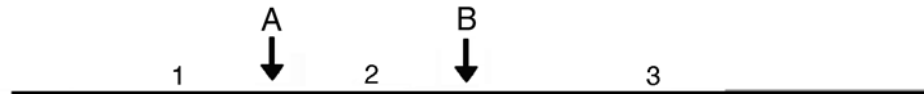

- Which fragment would be the largest?

Fragment 3.

- Which fragment would be the smallest?

Fragment 2.

- Draw a DNA molecule that has five randomly spaced restriction sites for a specific palindrome. How many fragments would be produced if they were each cut by a restriction enzyme?

6.

- Label each fragment

Answers will vary.

- Rank them in order of size from largest to smallest.

Answers will vary.



In this diagram A and B are different palindrome sequences on a DNA strand. Only the restriction enzyme that recognizes site B is present.

- Explain why only two fragments would be produced.

The enzyme would cut only at site B, producing two DNA fragments.

Lesson 2: Agarose Gel Electrophoresis

Consideration 2

A piece of DNA is cut into four fragments as shown in the diagram. A solution of the four fragments is placed in a well in an agarose gel. Using the information given above, draw on the diagram how you think the fragments might be separated. Label each fragment with its corresponding letter.

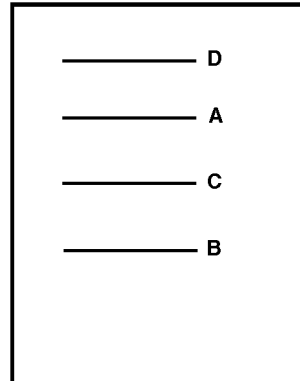
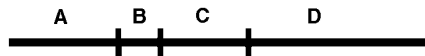

- Have your teacher check your diagram before you proceed.
- Where would the larger fragments, those with the greater number of base pairs, be located; toward the top of the gel or the bottom? Why?

The large fragments would be towards the top of the gel because it is more difficult for the larger pieces to be strained through the gel.

- Suppose you had 500 pieces of each of the four fragments, how would the gel appear?

There would still be only 4 bands present.

- If it were possible to weigh each of the fragments, which one would be the heaviest? Why?

Fragment D would be heaviest because it is the largest piece of DNA and would thus have the greatest mass.

- Complete this rule for the movement of DNA fragments through an agarose gel.

The larger the DNA fragment, the slower it migrates through an agarose gel.

A.

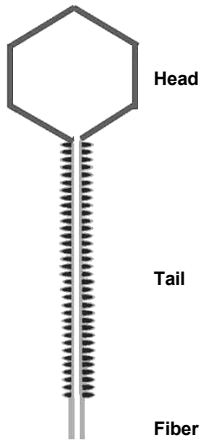

B.

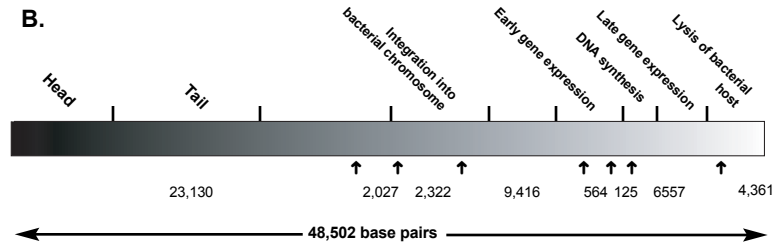

Tail

Fiber

Fig 1. Schematic representations of bacteriophage lambda. Bacteriophage lambda consists primarily of a head, which contains the genomic DNA, and a tail that is involved in phage attachment to bacterial cells (A). Lambda genomic DNA contains several important gene clusters (Ausebel et al., 1998). Arrows mark the sites where the restriction enzyme *Hind*III cuts the DNA, and the numbers indicate the number of bases in each fragment (B).

- How many fragments were produced by the restriction enzyme *Hind*III?

8

On the gel diagram at the right, show how you believe these fragments will sort out during electrophoresis.

- Label each fragment with its correct number of base pairs.

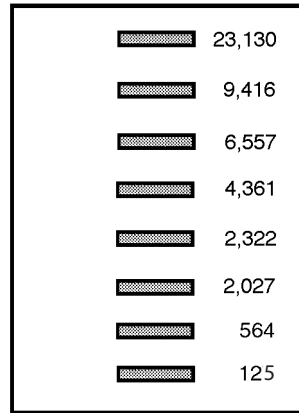

Note: Only the 6 largest *Hind*III lambda digest bands may be visible on the Fast Blast stained gels because there may not be sufficient DNA present in the smaller bands for the stain to detect them.

Lesson 3: Lab

Consideration 3. How Can the DNA Be Made Visible?

What color was the DNA before you added loading dye?

The DNA is a colorless solution.

1. Attach the plastic sheet tracing of the band patterns from the DNA electrophoresis below.

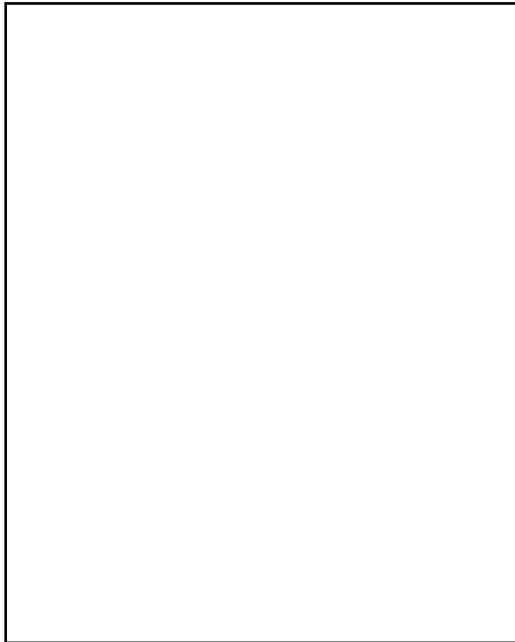

2. Attach the dried gel showing the band patterns from the DNA electrophoresis below.

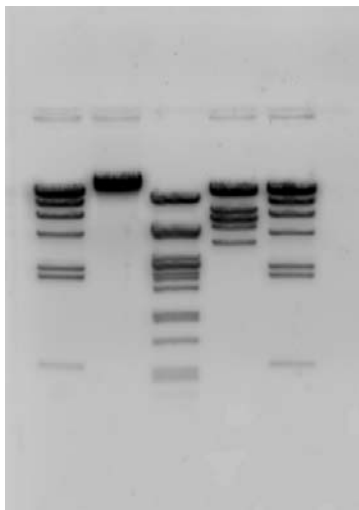

Electrophoresis data: Measure the distance (in millimeters) that each fragment traveled from the well and record it in the table. Estimate its size, in base pairs, by comparing its position to the *HindIII* lambda DNA markers. **Remember: some lanes will have fewer than 6 fragments.**

Largest fragment first ↓	M = DNA marker		L = uncut lambda no enzyme		P = <i>PstI</i> restriction digest of lambda DNA		E = <i>EcoRI</i> restriction digest of lambda DNA		H = <i>HindIII</i> restriction digest of lambda DNA	
	Distance in mm	Actual base pairs	Distance in mm	Estimated base pairs	Distance in mm	Estimated base pairs	Distance in mm	Estimated base pairs	Distance in mm	Estimated base pairs
Band 1	10	23,130	9	35,000	11	9,400	10	23,100	10	23,100
Band 2	11	9,416			15	4,400	13	6,500	11	9,400
Band 3	13	6,557			18.5	2,700	14	5,100	13	6,600
Band 4	15	4,361			19	2,500	14.5	4,700	15	4,400
Band 5	20	2,322			21	2,000	16	3,800	20	2,300
Band 6	21	2,027			22	1,500			21	2,000

Analysis of Your DNA Fragments

- Which lane is the molecular weight standards? How do you know?

The right lane is the molecular weight standards because it contains the known DNA fragments.

- Label each band in the right lane with its base-pair size.
- Compare the two columns of bands. Estimate the size of the fragments in the left lane.

Upper band 5,000
Lower band 4,000

- How did you determine the sizes of the two bands in the left lane?

Compared both unknown bands to the migration of the known bands in the reference lane.



Examine the Practice Gel Above

- Measure the distance, in millimeters, that each band moved from the bottom edge of the well to the bottom edge of the band.
- Record the data in the table to the right, including the units of measurement in millimeters (mm).

Left lane		Right lane	
1	9 mm	1	6 mm
2	20 mm	2	9 mm
		3	20 mm
		4	29 mm

The distance migrated by the fragments of unknown length were also marked on the standard curve.

- How many base pairs does fragment 2 contain?

~ 4000 bp.

- How accurate is this estimation of size?

Because this standard curve is fairly linear, this estimation is fairly accurate, probably within 10% of the true value.

From your laboratory data you were able to estimate the approximate size of each of the DNA fragments that you separated on your gel. This was done in terms of the number of base pairs.

- Explain how you made this determination:

Each of the unknown fragments was compared to the migration of the closest band in the reference lane. Because the sizes of the *HindIII* standard bands are known, you could estimate the size of the unknown fragments based upon their positions relative to the *HindIII* bands in the gel.

DNA Marker Standard Curve

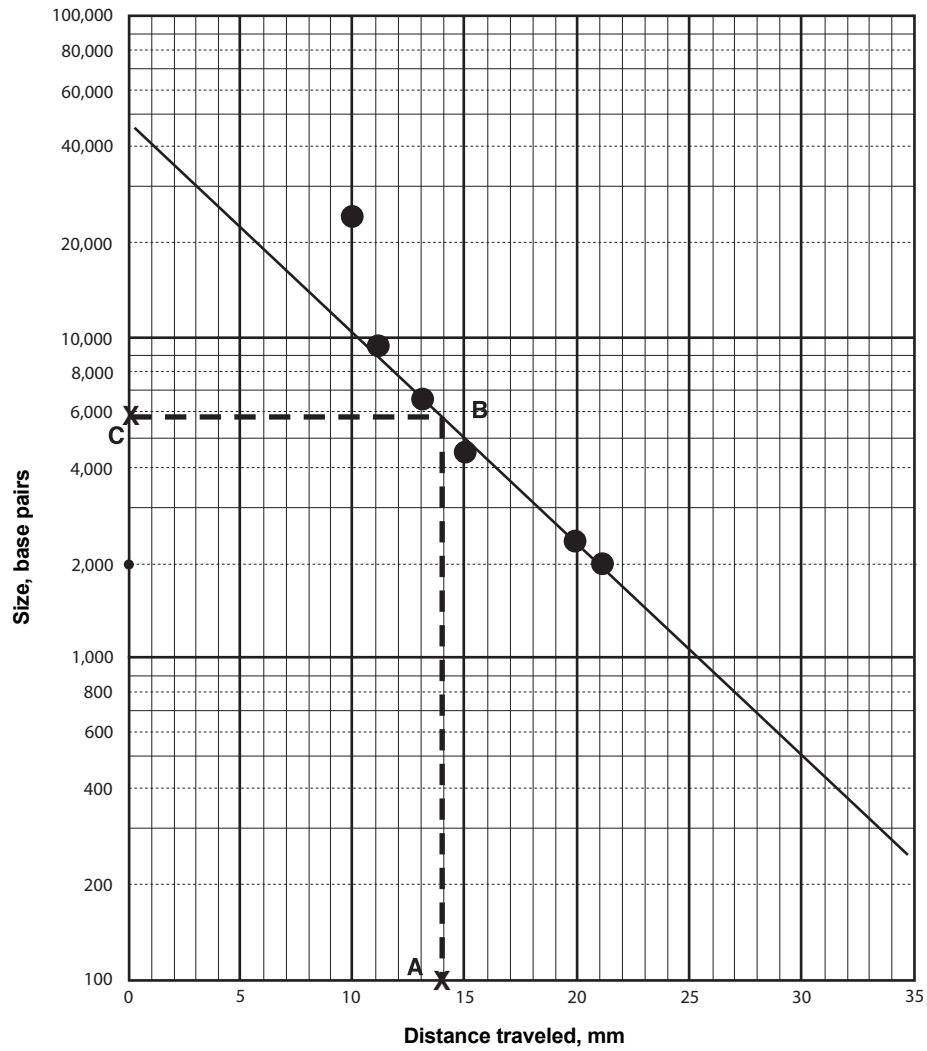

Band 3 of the *Eco*RI digest migrated 14 mm. A straight line up from the 14 mm point on the x-axis (A) intersects the standard curve at point B. A line straight to the left intersects the y-axis at point C, indicating a size of around 5,700 bp.

Largest fragment first
↓

	M = DNA marker		L = uncut lambda no enzyme		P = <i>Pst</i> I restriction digest of lambda DNA		E = <i>Eco</i> RI restriction digest of lambda DNA		H = <i>Hind</i> III restriction digest of lambda DNA	
	Distance in mm	Actual base pairs	Distance in mm	Estimated base pairs	Distance in mm	Estimated base pairs	Distance in mm	Estimated base pairs	Distance in mm	Estimated base pairs
Band 1	10	23,130	9	(35,000)	11	8,000 (9,400)	10	10,000 (23,100)	10	10,000 (23,100)
Band 2	11	9,416			15	5,000 (4,400)	13	6,800 (6,500)	11	9,000 (9,400)
Band 3	13	6,557			18.5	2,900 (2,700)	14	5,700 (5,100)	13	6,600 (6,600)
Band 4	15	4,361			19	2,750 (2,500)	14.5	5,500 (4,700)	15	5,000 (4,400)
Band 5	20	2,322			21	2,000 (2,000)	16	4,200 (3,800)	20	2,300 (2,300)
Band 6	21	2,027			22	1,800 (1,500)			21	2,000 (2,000)

(Numbers in parentheses are from the data from the gel comparison of bands.)

- What evidence do you have that each enzyme cuts the DNA at different locations?

Each enzyme produces very different sizes of restriction fragments that migrate with very different patterns. This would suggest that the different enzymes are cutting at different locations on the lambda DNA.

- When this data table has been completed, describe what you have done to determine DNA fragment sizes in this investigation. Use no more than two sentences.

The first determination of size involved the approximation of unknown DNA band size by comparison to the migration of known DNA samples directly on the agarose gel. The second determination more accurately determined unknown DNA size by plotting a standard curve from known DNA bands, and then using the curve to determine the sizes of unknown samples.

- Explain how you think you could make your DNA size estimation more accurate.

Drawing two standard curves, rather than one, would make the size estimation more accurate. One curve could be drawn for the larger data points (bands 1, 2, and 3) and a second curve could be drawn for the smaller points (4, 5, and 6). Estimation of unknown fragment sizes could then be made from the most appropriate curve.

- Compare the two methods — direct gel examination and semilog graph — of determining the fragment size in base pairs. Which method seems to be more accurate? Explain your answer.

Both methods have advantages and disadvantages. With the gel examination method, it is possible to estimate sizes over the entire range of the gel, in particular for extremely large fragments. Because large fragments are outside of the linear range of the standard curve, you cannot accurately estimate sizes from the curves, but you can estimate the sizes from the gel.

Use of the semilog graph standard curve is very accurate within the linear range. The logarithmic cycles on the graph paper allow you to accurately estimate sizes of fragments, such as band 3 of the *Eco*RI lane, which migrated between standard band points. It is harder to estimate these intermediate sizes directly on the gel.

Appendix B: Complete Lambda Genome Analysis

Some of the descriptions of the DNA fragment banding patterns produced in this kit have been simplified to facilitate student understanding of DNA restriction analysis and agarose gel electrophoresis. For teachers who would like to explore further the restriction analysis of the lambda genome, a few clarifications may be helpful. There are seven *HindIII* restriction sites in the lambda genome, so digestion of lambda DNA with *HindIII* produces eight DNA fragments. Six of these fragments are large enough for students to see because they contain sufficient amounts of DNA to be detected by Fast Blast stain. Digestion of lambda DNA with *EcoRI* generates six fragments, but two of them are so close in size that they cannot be separated under the gel conditions used. The *PstI* restriction enzyme produces 29 lambda DNA fragments! Some of these fragments migrate so closely together on a gel that they appear as one band, while other fragments are so small that they cannot be detected. Changing the agarose concentration, running the gels for longer time periods, and using a much more sensitive DNA stain would enable the detection of more DNA bands.

The following table lists the exact sizes of all the fragments produced when lambda DNA is digested with the indicated enzymes.

Uncut lambda DNA	<i>PstI</i> lambda digest	<i>EcoRI</i> lambda digest	<i>HindIII</i> lambda digest
48,502 bp	11,497 bp	21,225 bp	23,129 bp
	5,077	7,421	9,416
	4,749	5,804	6,557
	4,507	5,643	4,361
	2,838	4,878	2,322
	2,559	3,530	2,027
	2,459		564
	2,443		125
	2,140		
	1,986		
	1,700		
	1,159		
	1,093		
	805		
	514		
	468		
	448		
	339		
	264		
	247		
	216		
	211		
	200		
	164		
	150		
	94		
	87		
	72		
	15		

The complete lambda bacteriophage genomic DNA sequence can be found on the National Center for Biotechnology Information web site (ncbi.nlm.nih.gov/), under the accession number J02459.



**Bio-Rad
Laboratories, Inc.**

*Life Science
Group*

Web site www.bio-rad.com **USA** (800) 4BIORAD **Australia** 02 9914 2800 **Austria** (01)-877 89 01 **Belgium** 09-385 55 11 **Brazil** 55 21 507 6191
Canada (905) 712-2771 **China** (86-21) 63052255 **Czech Republic** + 420 2 41 43 05 32 **Denmark** 44 52 10 00 **Finland** 09 804 22 00
France 01 47 95 69 65 **Germany** 089 318 84-177 **Hong Kong** 852-2789-3300 **India** (91-124)-6398112/113/114, 6450092/93 **Israel** 03 951 4127
Italy 39 02 216091 **Japan** 03-5811-6270 **Korea** 82-2-3473-4460 **Latin America** 305-894-5950 **Mexico** 55-52-00-05-20
The Netherlands 0318-540666 **New Zealand** 64 9 415 2280 **Norway** 23 38 41 30 **Poland** + 48 22 331 99 99 **Portugal** 351-21-472-7700
Russia 7 095 721 1404 **Singapore** 65-6415 3188 **South Africa** 00 27 11 4428508 **Spain** 34 91 590 5200 **Sweden** 08 555 12700
Switzerland 061 717-9555 **Taiwan** (8862) 2578-7189/2578-7241 **United Kingdom** 020 8328 2000