

**DESIGN AND CONSTRUCTION
OF LOW COST
RETAINING
WALLS**

**THE NEXT
GENERATION
IN
TECHNOLOGY**

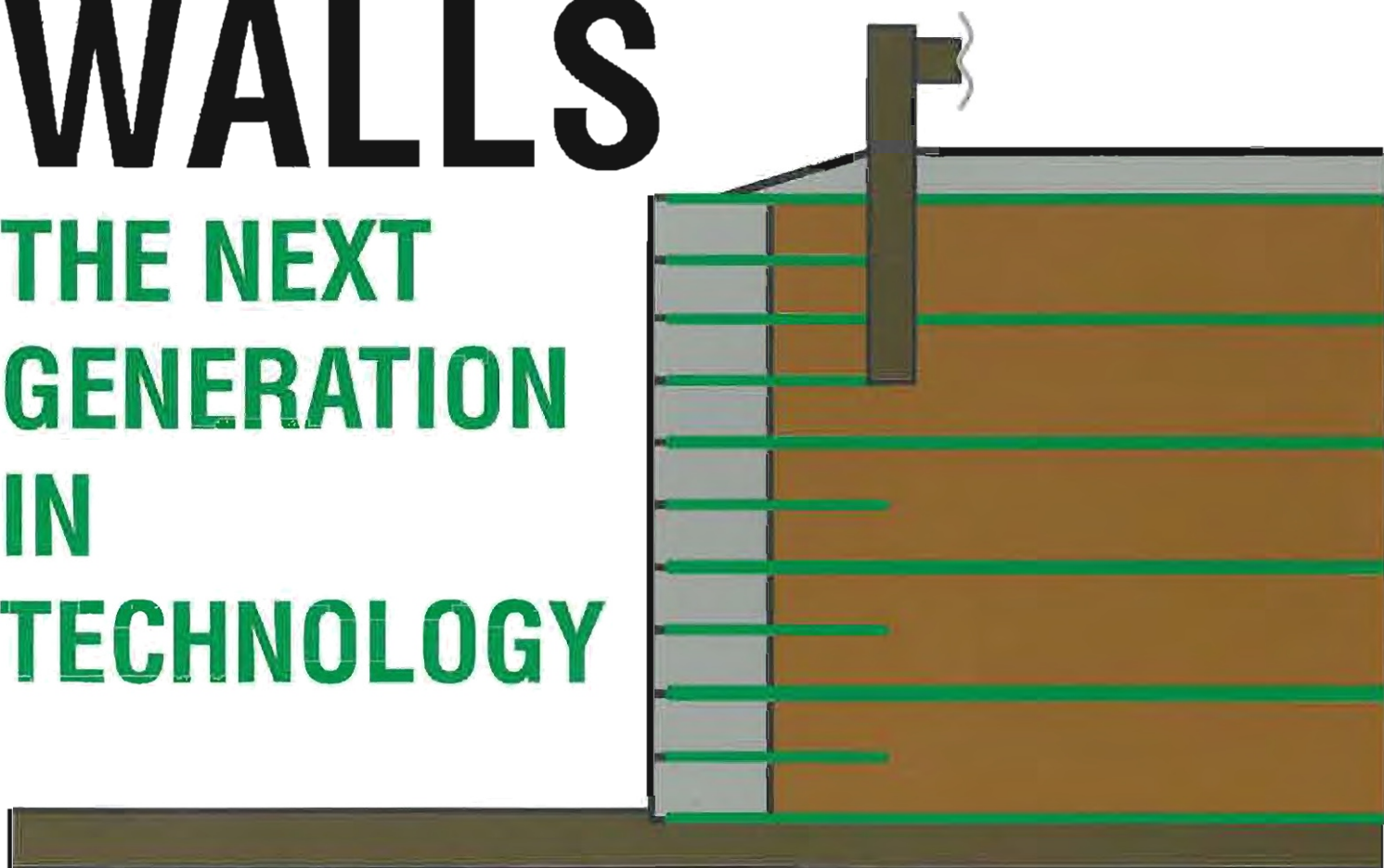

Colorado Transportation Institute

and the

Colorado Department of Transportation

U.S. Forest Service

University of Colorado at Denver

Jonathan T.H. Wu

FEBRUARY, 1994

1. Report No. CTI-UCD-1-94		2. Government Accession No.		3. Recipient's Catalog No.	
4. Title and Subtitle Design and Construction of Simple, Easy and Low Cost Retaining Walls				5. Report Date February 1994	
				6. Performing Organization Code	
7. Author(s) Dr. Jonathan T.H. Wu				8. Performing Organization Report No. CTI-UCD-1-94	
9. Performing Organization Name and Address Colorado Transportation Institute 4201 E. Arkansas Avenue, Room A100 Denver, CO 80222				10. Work Unit No. (TRAIS)	
				11. Contract or Grant No. 270.02 035	
12. Sponsoring Agency Name and Address U.S. Forest Service, Portland, Oregon Colorado Department of Transportation University of Colorado at Denver				13. Type of Report and Period Covered	
				14. Sponsoring Agency Code	
15. Supplementary Notes					
16. Abstract Recent advances in technologies that are related to earth reinforcement with tensile inclusions has led to a suite of retaining walls and steepened slopes that are simple to design, easy to construct, and relatively low in cost. This report presents an overview of the history behind these innovations and a summary of the comparative advantages of these earth-reinforced features. A basic limiting equilibrium analysis is presented as the CTI Method, and design charts based on those equations are included. Cost factors are included. Also included is a dry-stacked rockery design that is used by the Colorado Department of Transportation.					
17. Key Words retaining wall, mechanically stablized earth, rockery, geosynthetics, reinforced soil, reinforced slope, tensile inclusions, space constraint, limit equilibrium			18. Distribution Statement		
19. Security Classif. (of this report) None		20. Security Classif. (of this page)		21. No. of Pages	22. Price

Table of Contents

	<u>Page</u>
1. Introduction	1
1.1 Overview	1
1.2 Geosynthetic-Reinforced Soil Retaining Walls	6
1.2.1 USFS Wrapped-Faced Geotextile-Reinforced Wall	10
1.2.2 CTI Timber-Faced Geosynthetic-Reinforced Wall	15
1.2.3 Modular Block Geosynthetic-Reinforced Wall	21
1.3 Rockery	27
2. Design of the Low-Cost Retaining Walls	29
2.1 Design of Geosynthetic-Reinforced Soil Retaining Walls	29
2.1.1 Design Concept	29
2.1.2 Design Methodologies	32
2.2 Ultimate Strength Design Methods for GRS Walls	32
2.2.1 Earth Pressure Methods	33
2.2.2 Slope Stability Methods	35
2.2.3 U.S. Forest Service Method - An Ultimate Strength Design Method	38
2.2.3.1 Design Procedure	38
2.2.3.2 Design Example	47
2.2.4 Limitations of the Ultimate Strength Design Methods	57
2.3 Service-Load Design Methods for GRS Walls	61
2.3.1 CTI Design Method - A Service-Load Design Method	63
2.3.1.1 Design Procedure	64
2.3.1.2 Design Example	78
2.3.2 Simplified CTI Design Method	85
2.3.2.1 Design Procedure	86
2.3.2.2 Design Example	87
2.3.2.3 Design Chart	90
2.3.3 Limitations of the Service-Load Design Methods	96
2.4 Performance-Limit Design Methods for GRS Walls	96
2.4.1 GREWS - A Comprehensive Design Tool for GRS Structures	97
2.4.2 Four Levels of Sophistication of GREWS	99
2.4.3 Design Example (Level-2)	102
2.5 Design of Rockery	110

3.	Construction of the Low-Cost Retaining Walls	111
3.1	Construction Considerations for GRS Walls	111
3.2	USFS Wrapped-Faced Geotextile-Reinforced Wall	115
3.2.1	Construction Procedure	115
3.2.2	Construction Guidelines	118
3.3	CTI Timber-Faced Geosynthetic-Reinforced Wall	120
3.3.1	Construction Procedure	120
3.3.2	Construction Guidelines	122
3.4	Modular Block Geosynthetic-Reinforced wall	124
3.4.1	Construction Procedure	127
3.4.2	Construction Guidelines	130
3.5	Rockery	131
3.5.1	Construction Procedure	131
3.5.2	Construction Guidelines	132
4.	Applications of the Low-Cost Retaining Walls	133
4.1	USFS Wrapped-Faced Geotextile-Reinforced Wall	133
4.1.1	Case Histories	133
4.1.2	Advantages	137
4.1.3	Disadvantages	139
4.2	CTI Timber-Faced Geosynthetic-Reinforced Wall	140
4.2.1	Case Histories	140
4.2.2	Advantages	144
4.2.3	Disadvantages	146
4.3	Modular Block Geosynthetic-Reinforced wall	146
4.3.1	Advantages	146
4.3.2	Disadvantages	147
4.4	Rockery	148
	REFERENCES	149

Chapter 1

INTRODUCTION

1.1 Overview

When there is a substantial change of elevation in earthwork construction, one may opt for one of the three solutions: an un-reinforced slope, a reinforced slope, or a retaining wall, as depicted in Figure 1.1. The primary difference among the three solutions is the space requirement between the two elevations. The first solution, un-reinforced slope, requires an adequate space for gradual change in elevation without inducing instability of the slope. Stability of a slope can be evaluated by the limit equilibrium methods using a stability chart (e.g., Taylor, 1948; Duncan and Buchignani, 1975) or a computer program such as STABL (Siegel, 1975; Carpenter, 1984; Humphrey and Holtz, 1986). The space required is less for the second solution, reinforced slope, which assumes a steeper slope angle than an un-reinforced slope under otherwise identical conditions. The slope reinforcement can be achieved by using geosynthetic inclusions (Christopher and Holtz, 1985; Mitchell and Villet, 1987), micropiles (Lizzi, 1971), flexible soil nailing (Mitchell and Villet, 1987), or large-diameter rigid piles (Yamada, et al, 1971; Fukuoka, 1977), etc. The third solution, retaining wall, requires the least space for the change in elevation, thus, provides the largest levelled area. However, retaining wall is generally higher in costs than the other two solutions. The use of a retaining wall, therefore, is generally limited to situations where space constraint is a main issue. The design and construction of low-cost retaining walls is the focus of this Manual.

(a) Un-reinforced Slope

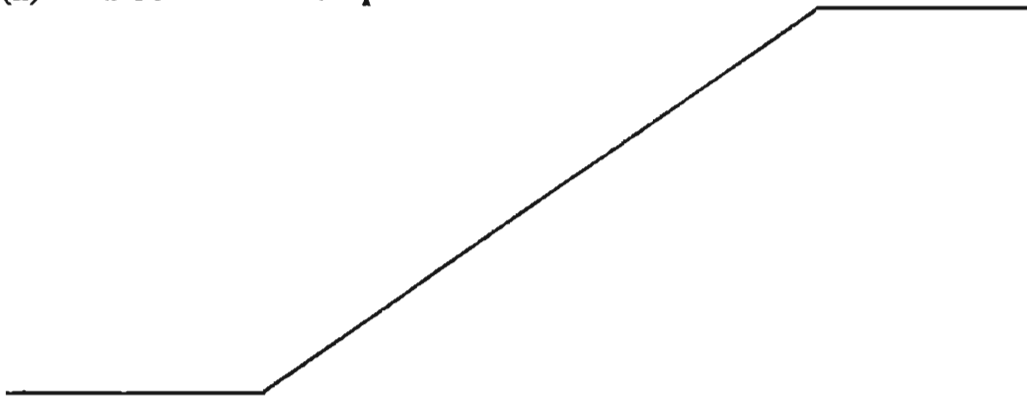

(b) Reinforced Slope

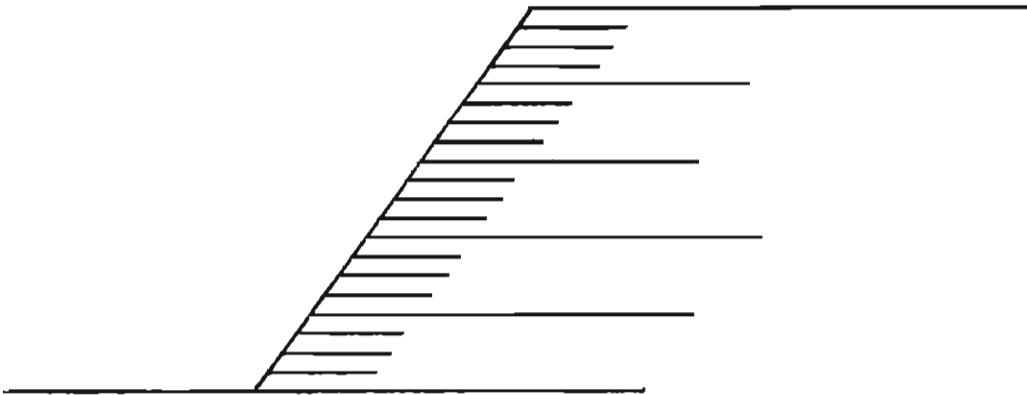

(c) Retaining Wall

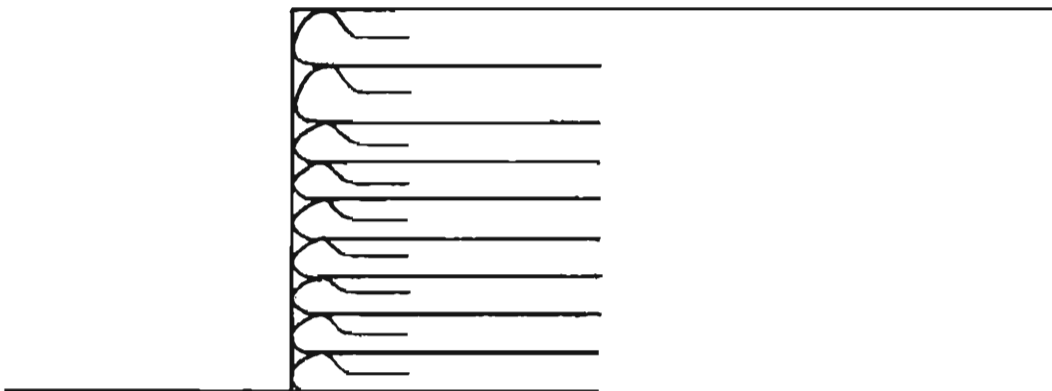

Figure 1.1 Change of Elevation in Earthwork Construction

In the past, concrete gravity walls and concrete cantilever walls were the most popular retaining wall systems, especially in highway construction. These systems were simple to design, and could be constructed by general contractors with conventional construction equipment and techniques. Complacency developed within the structural design community in the 1940's to 1960's, and innovation and experimentation were not common in the area of retaining walls.

That complacency was rudely upset circa 1970 with the advent of a number of innovative retaining wall systems, many of them stemming from the concept of reinforced soil. The term "reinforced soil" refers to a soil which is strengthened by a material able to resist tensile stresses and which interacts with the soil through friction and/or adhesion. The historic development of reinforced soil retaining walls and the reinforcing mechanism has been described by Jones (1985), Mitchell and Villet (1987), and Hausmann (1990).

Over the last decade, the technology of reinforced soil retaining wall has evolved to a point that it is replacing the roles of concrete gravity walls and concrete cantilever walls, and becoming the prevailing wall system. Reinforced soil retaining walls have demonstrated many distinct advantages over conventional concrete walls, including:

- 1) Reinforced soil retaining walls are more flexible, hence more tolerant to foundation settlement.
- 2) When properly designed and constructed, reinforced soil retaining walls are remarkably stable. In spite of many attempts to load a number of geosynthetic-reinforced soil retaining walls to failure (in order to examine their ultimate load carrying capacities and safety margins), no one has

succeeded in bringing about "major" or catastrophic failure of any of the walls—even for those designed with a safety factor less than one.

- 3) Reinforced soil retaining walls do not require embedment into the foundation soil for stability. This characteristic is especially important when an environmental problem (such as excavation of contaminated soil) is involved.
- 4) The tensile inclusions of reinforced soil retaining walls will significantly reduce the lateral earth pressure exerted on wall facing provided that the movement of the facing will allow mobilization of tensile resistance in the inclusions.
- 5) Construction of reinforced soil retaining walls is rapid and requires only "ordinary" construction equipment.
- 6) Reinforced soil walls are generally less expensive to construct than "conventional" retaining walls. Figure 1.2 shows the comparative costs of reinforced soil retaining walls and conventional reinforced concrete walls. For walls with height less than 25 ft, reinforced soil walls using geosynthetics as reinforcement ("geosynthetic-reinforced walls") are generally the least expensive to construct. In fact, when backfill costs are included, the saving will often be more dramatic than that indicated by Figure 1.2. This is because many on-site soils can be used as backfill for geosynthetic-reinforced soil walls but not for the other wall systems.

This Manual presents guidelines for design and construction of three geosynthetic-reinforced soil retaining walls: the USFS wrapped-faced geotextile-reinforced retaining wall,

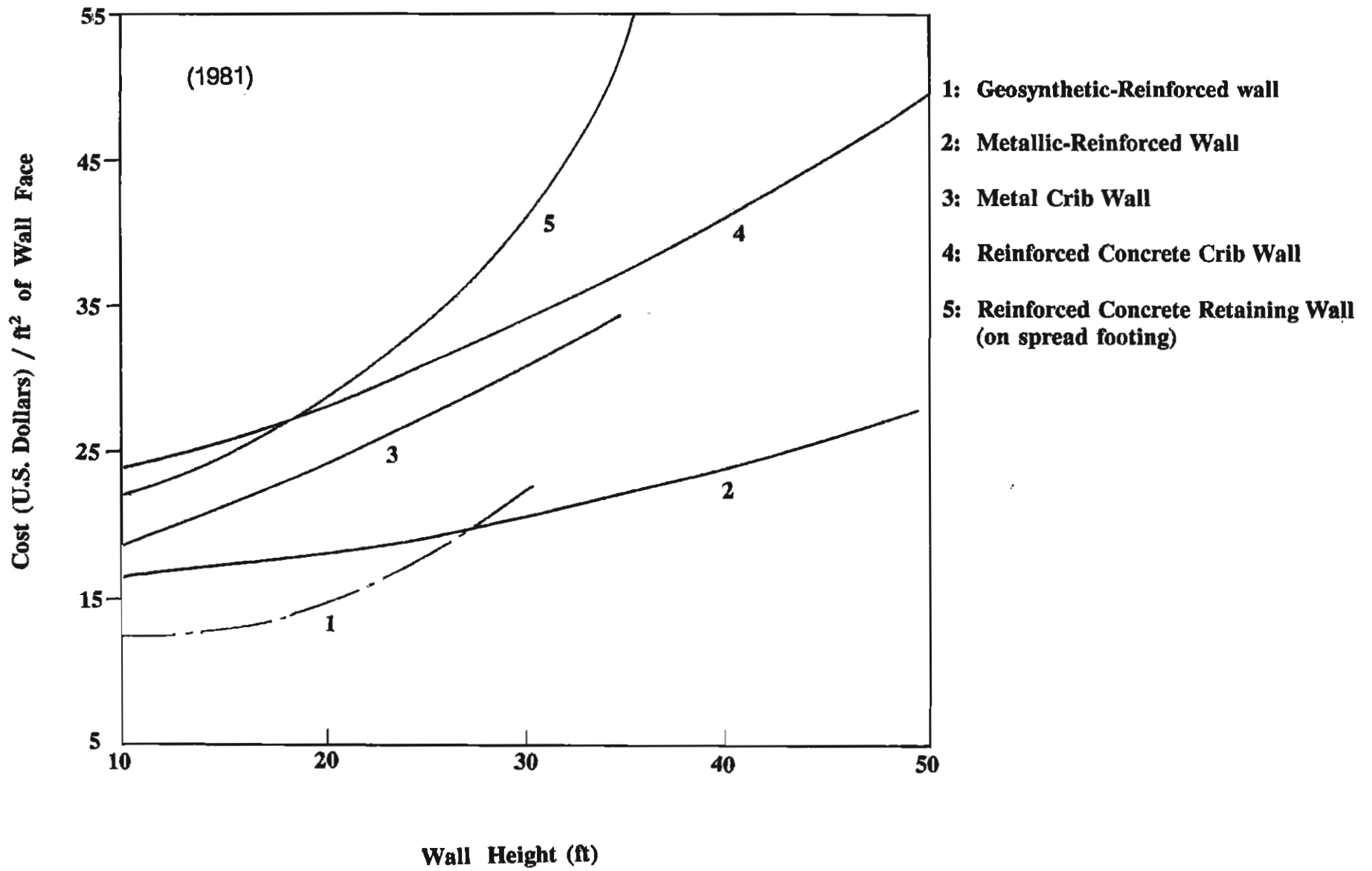

Figure 1.2 Cost Comparison of Different Soil Retaining Walls (after Christopher and Holtz, 1985)

the CTI timber-faced geosynthetic-reinforced wall, and modular block geosynthetic-reinforced walls. In addition, another low-cost retaining wall system, "rockery" (stacked rock wall), is addressed. The remaining of this Chapter gives a brief description of the four wall systems. The design of geosynthetic-reinforced soil retaining walls and rockery are presented in Chapter 2. The design of geosynthetic-reinforced soil walls includes design methods and design examples for using a ultimate-strength design method, a service-load design method, and a performance-limit design method. Chapter 3 outlines the construction procedure and construction guidelines for each wall system. Chapter 4 addresses the applications, including case histories, advantages and disadvantages, of each wall system.

1.2 Geosynthetic-Reinforced Soil Retaining Walls

Geosynthetic-Reinforced Soil (GRS) walls derive their support from multiple layers of geosynthetic sheets or strips embedded in the backfill behind the face of the wall. Figure 1.3 illustrates the concept of soil reinforcement, in which the reinforcement (strips of paper in this case) allows the soil to maintain a much steeper slope than the unreinforced soil. Use of geosynthetics (geotextile and geogrid) as reinforcement has the following advantages over other reinforcement materials such as metals:

- 1) Geosynthetics have strong resistance to corrosion and bacterial action, compared with metallic reinforcements.
- 2) Granular backfill, although preferred, is not required. A cohesive backfill may be used when the following criteria are met (Chou and Wu, 1993): (a) cost of obtaining granular soil is prohibitive, (b) the wall is to be constructed

(a) Unreinforced Sand (with maximum stable slope)

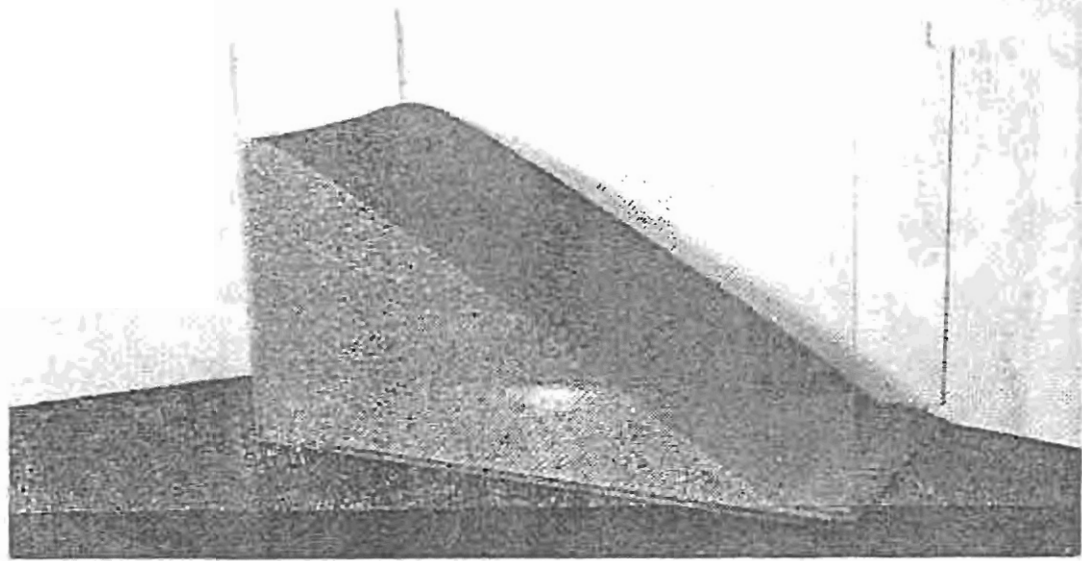

(b) Reinforced sand

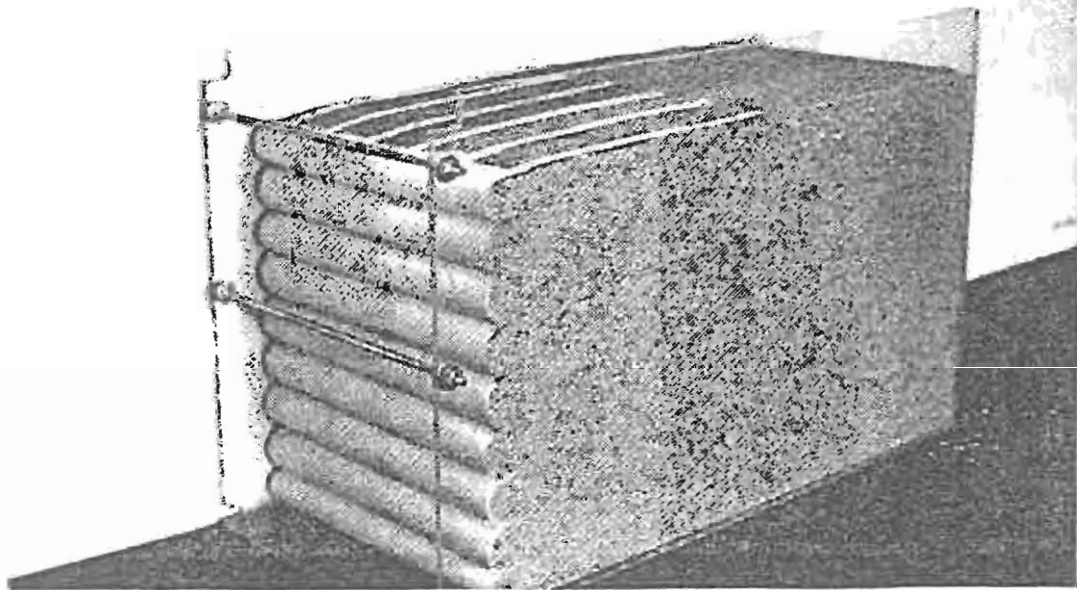

Figure 1.3 Reinforced and Unreinforced Dry Sand (after Mitchell and Villet, 1987)

in an arid or semi-arid area, (c) the grading of the wall site is such that surface runoff is unlikely to infiltrate the backfill, and (d) adequate drainage in the backfill is provided.

- 3) Geosynthetics are generally lower in cost.
- 4) Geosynthetics are readily available and are easy to transport to remote sites.
- 5) Other than the function of reinforcing soil, most geosynthetics fulfill multiple functions, e.g., control ground water flow, alleviate drainage problems, prevent particle migration, maintain separation of different soil layers during construction or under repeated external loading.

On the other hand, there are also a number of drawbacks of using geosynthetics as reinforcement:

- 1) Construction equipment may cause some degree of damage of geosynthetics during installation.
- 2) Some geosynthetics are susceptible to chemical degradation. Table 1.1 gives a general guide to soil environments of potential concern when using geosynthetics.
- 3) Geosynthetics may creep with time if the surrounding soil has a strong tendency to deform with time. In-air testing of geosynthetics alone shows that most geosynthetics tend to creep with time. In-soil testing which allows the confining soil to deform with time, however, indicates creep deformation will not occur if the surrounding soil does not exhibit time-dependent deformation (Wu and Helwany, 1994).

Table 1.1 Soil Environments of Potential Concern when Using Geosynthetics (after Elias, 1990)

Soil Type	Characterization and area of occurrence
acid sulfate soils	characterized by low pH and considerable amount of CL^{-1} and SO_4^{-2} ions (e.g., pyritic soils in the Appalachian region)
organic soils	characterized by high organic contents and susceptibility to microbiological attack (e.g., dredged fills)
salt affected soils	occur in areas of seawater saturation or in dry alkaline areas as the Southwestern U.S.
ferruginous soils	contain Fe_2SO_3
calcareous soils	occur in dolomitic areas
modified soils	soils subject to deicing salts; cement stabilized soil; or lime stabilized soil

A number of different GRS walls have been constructed using different facing types, as shown in Figure 1.4. In this section, an introduction to the three low-cost GRS walls: the USFS wrapped-faced geotextile-reinforced wall, the CTI timber-faced geosynthetic-reinforced wall, and modular block geosynthetic-reinforced wall, is presented.

1.2.1 USFS Wrapped-Faced Geotextile-Reinforced Wall

Geotextile-reinforced walls with wrapped-face were first constructed in Siskiyou National Forest in Oregon in 1974 and Olympic National Forest in Shelton, Washington in 1975 by the U. S. Forest Service (Steward and Mohny, 1982). The excellent performance and low cost of these two walls provide impetus for many wrapped-faced geotextile-reinforced walls to be constructed in the U. S. and many countries around the world.

The typical configuration of the USFS wrapped-faced geotextile-reinforced wall is shown in Figure 1.5. The wall facing is constructed by wrapping each geotextile sheet around its overlying layer of backfill and then re-embedding the free end into the backfill. The wrapped geotextile wall facing retains the soil immediately behind the wall face; and the embedded portion of the geotextile restrains lateral deformation of the backfill by soil-geotextile friction. The geotextile face is usually covered with gunite (shotcrete) or asphalt emulsion to prevent the geotextile's weakening due to UV exposure and possible vandalism. Figure 1.6 shows a completed wrapped-faced wall.

For the wrapped-faced geotextile-reinforced walls that have been constructed to date, the backfill typically consists of granular fill ranging from silty sand to coarse gravel. Compacted cohesive backfill has also been used in numerous walls. A wide variety of

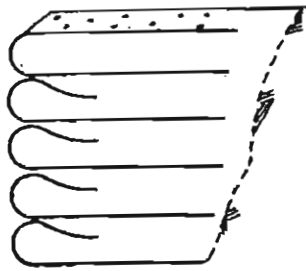

wrapped-faced wall

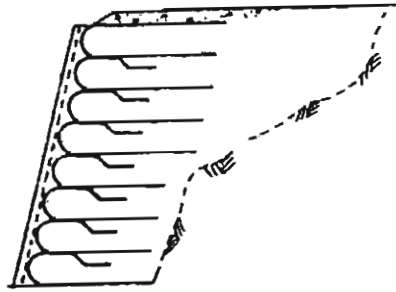

*wrapped-faced wall
with shotcrete cover*

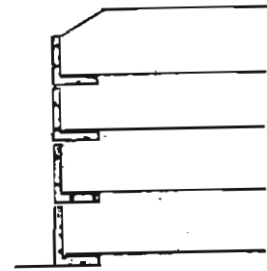

*GRS wall with
articulated concrete
facing*

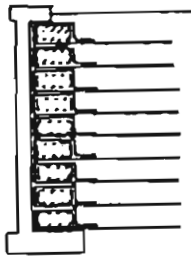

*GRS wall with
full-height concrete
facing
(two-phase construction)*

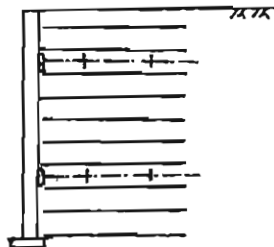

*full-height concrete
MSB wall
(CTI MSB Wall)*

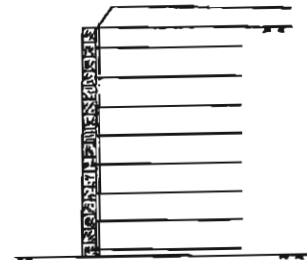

timber-faced wall

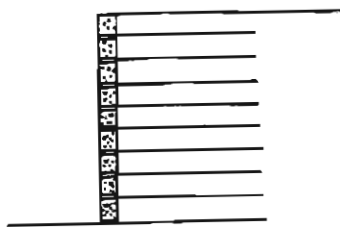

modular block wall

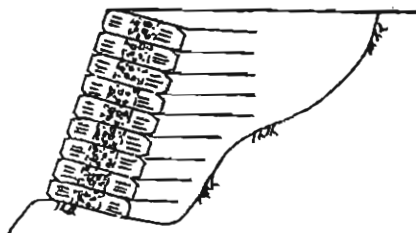

tire-faced wall

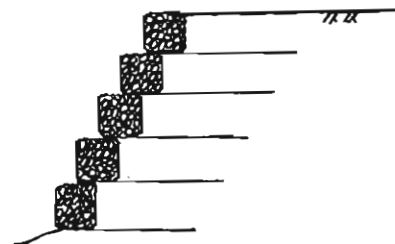

gabion-faced wall

Figure 1.4 Geosynthetic-Reinforced Soil Walls with Different Facings

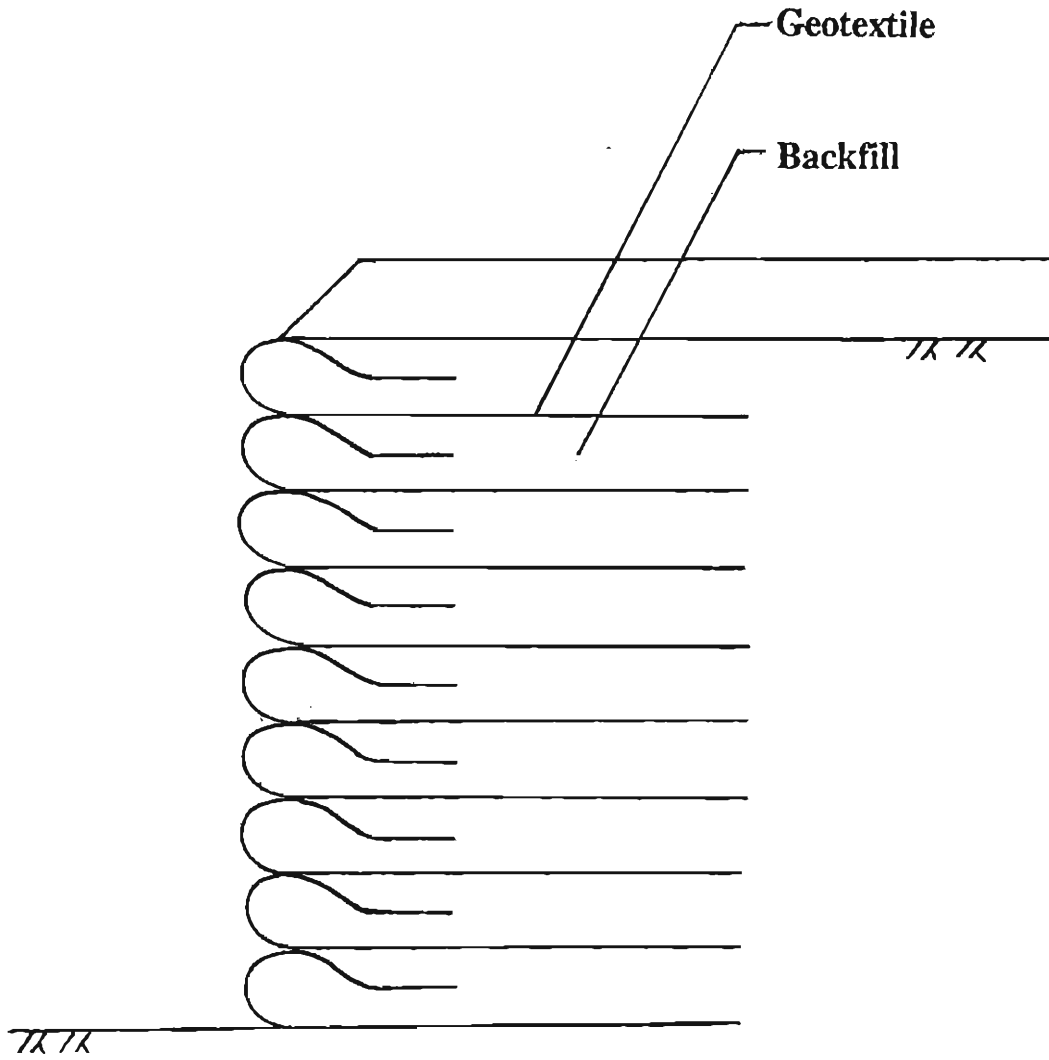

Figure 1.5 Typical Configuration of a USFS Wrapped-Faced Geotextile-Reinforced Wall



Figure 1.6 A Completed Wrapped-Faced GRS Wall (courtesy Washington Department of Transportation)

geotextiles with a wide range of mechanical properties and environmental resistances have been used, including nonwoven, needle-punched or heat-bonded polyester and polypropylene, and woven polypropylene and polyester. The wrapped-faced geotextile-reinforced walls have in the past been constructed in remote areas or were used for temporary purposes; however, they are now being used for permanent urban installations, as well (Mitchell and Villet, 1987). The wrapped-faced geotextile-reinforced walls generally range in height from 3 to 20 ft. A 40-ft high temporary vertical wall has been constructed in Seattle, Washington, and a sloping wall with a height of 66 ft has been constructed in Allemand, France.

Experiences gained from construction of the USFS wrapped-faced geotextile-reinforced walls can be summarized as follows:

- 1) The wrapped-faced geotextile-reinforced wall is very economical, and can be built by a general contractor.
- 2) The wall will not exhibit any appreciable creep as long as the backfill is predominantly granular.
- 3) The geotextile reinforcement can effectively induce an apparent cohesion for cohesionless backfill to assume a vertical slope even without a facing.
- 4) The wall can tolerate large settlement and differential settlement without distress.
- 5) The wall may experience large, short-term deformations if a weak geotextile is used or if it is not properly constructed.

- 6) The wrapped-face wall facing covered with asphalt products or gunite is considered by some people to be less aesthetically appealing than some other wall systems.

It is to be noted that most of the wrapped-face geotextile-reinforced walls constructed to date are designed by the U.S. Forest Service method (to be presented in Chapter 2). Measurement of wall performance in the field has indicated that the design is very conservative.

1.2.2 CTI Timber-Faced Geosynthetic-Reinforced Wall

In early 1980's, a geosynthetic-reinforced wall utilizing a timber forming/facing system, known as the CTI timber-faced geosynthetic-reinforced wall, was developed at the the Colorado Department of Transportation. Figure 1.7 depicts the typical configuration of the CTI timber-faced wall. A completed CTI timber-faced geosynthetic-reinforced wall is shown in Figure 1.8.

The timber-faced wall is constructed with preservative-treated wooden timbers that serve as temporary forming and final facing. All the timbers are inter-connected behind the facing by forming elements (e.g., plywood boards) with nails, as shown in Figure 1.9. The inter-connected timber facing offers both local and global bending resistance, thus reduce lateral deformation of the wall (Tatsuoka, et al., 1992; Wu, 1992b). The geotextile reinforcement is securely attached to the facing by nailing between the forming elements and timbers, and its "tail" is fold flat toward the back of the wall.

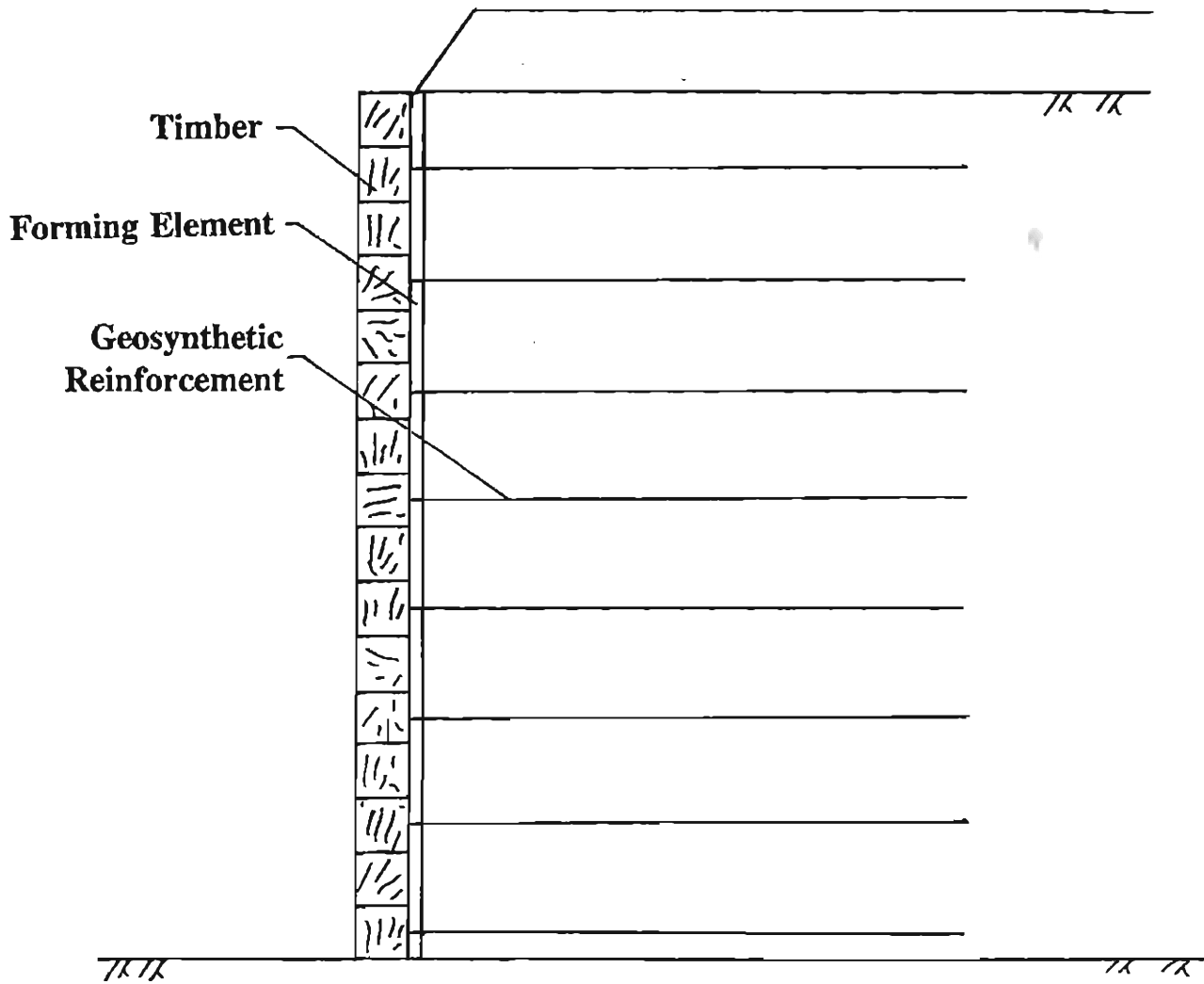

Figure 1.7 Typical Configuration of a CTI Timber-Faced GRS Wall

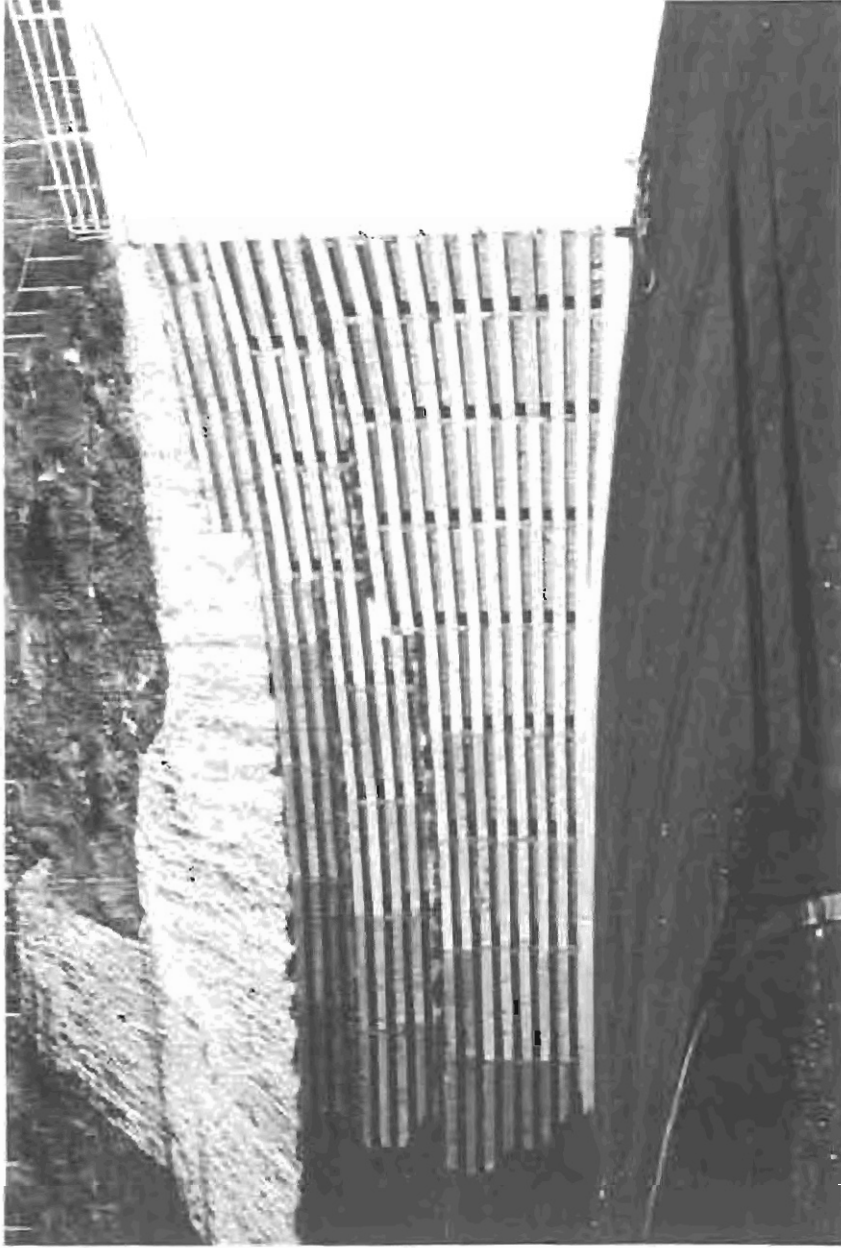

Figure 1.8 A Completed CTI Timber-Faced GRS Wall

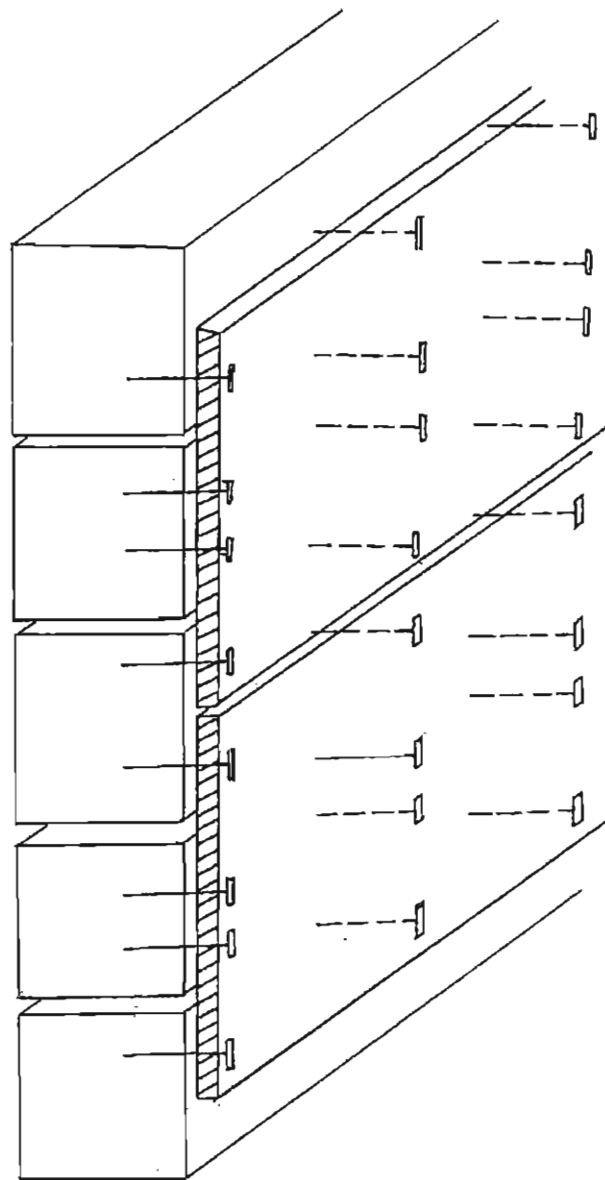

Figure 1.9 Attachment of Forming Elements to Timber Facing (Wu, 1992a)

Most of the timber-faced walls that have been constructed to date are less than 20 ft in height. For higher walls, the facing can be constructed in tiers, which not only allow room for plantings but also soften the appearance of the wall. A wide variety of soils, ranging from granular fill to low-quality clayey soil, have been used as backfill. Various geosynthetics, including woven geotextiles, nonwoven geotextiles, and geogrids, can be used as reinforcement.

Where there are no constraints on materials or appearance, the CTI timber-faced geosynthetic-reinforced wall is usually the least expensive wall system. The economies are realized through low-cost backfill, low-cost facing/forming materials, utilizing the forming as the permanent facing, relatively inexpensive reinforcement, placing the wall on the ground (not into the ground) and the option in some cases to truncate the depth of the lower-most layers of reinforcement.

This retaining wall system has been extensively researched. In 1991, two 10-ft high CTI timber-faced geotextile-reinforced walls (the "Denver test walls"), one with a cohesive backfill and the other with a granular backfill, were constructed and tested. A light-weight (3 oz/yd²) nonwoven, heat-bonded, polypropylene geotextile at 11-inch vertical spacing was used as reinforcement. The test walls were featured in the International Symposium on Geosynthetic-Reinforced Soil Retaining Walls held in Denver, Colorado. The measured behavior and the predictions of the Denver walls were included in the Proceedings of the Symposium (Wu, 1992c). The tests indicated that:

- 1) The CTI timber-faced test walls are very stable. The "failure" surcharge pressure for the granular-backfill wall was 29 psi; while the cohesive-backfill

wall was approaching "failure" at a surcharge pressure of 33 psi. It is to be noted that current design methods gave failure surcharge pressures (i.e., for factor of safety = 1) ranging from less than 0 psi (i.e., the wall can not be erected) to 7.3 psi for the granular-backfill wall (Claybourn and Wu, 1992). None of the current design methods can accommodate the use of a cohesive backfill.

- 2) The cohesive-backfill wall is at least as stable as the granular-backfill wall provided that the soil was not wetted. However, when the cohesive backfill was saturated, the deformation of the wall would become excessive. Neither walls under the placement condition (placement moisture of the cohesive-backfill wall was 2% wet of optimum) exhibited any creep deformation under 15 psi surcharge.

The CTI timber-faced geosynthetic-reinforced wall has also been successfully demonstrated in the field on several projects. Wu, Barrett, and Chou (1994) reported recent applications in Colorado including the use of a double-faced wall as rock fall barrier. Some of the case histories are presented in Chapter 4.

Field installation of the CTI timber-faced geosynthetic-reinforced wall has indicated that:

- 1) Where there are no constraints on materials or appearance, the CTI timber-faced geosynthetic-reinforced wall is usually the least expensive wall system.

- 2) The construction is simple and rapid as there is no requirement for external forming system for wall construction. The wall can be built by a general contractor.
- 3) The wall will not exhibit any appreciable creep provided that (a) the backfill is predominantly granular, or (b) surface and subsurface drainage is properly provided to prevent wetting of cohesive backfill.
- 4) The wall can tolerate large settlement and differential settlement without distress.
- 5) The life span of the timber facing tends to dictate the design life of the wall. When timber is properly treated, the design life of a timber-faced wall can be well above 50 years.

1.2.3 Modular Block Geosynthetic-Reinforced Wall

Since their introduction in 1985 by Keystone Wall Systems, more than 5000 modular block geosynthetic-reinforced walls have been constructed. Typical configuration of modular block geosynthetic-reinforced wall is depicted in Figure 1.10. The facing is composed of stacked concrete blocks which are small and light enough to be easily handled. The blocks may be dry-cast machine molded or wet-cast. A variety of modular blocks, varying in size, shape, weight, color and texture, are available from more than a dozen companies, as shown in Figure 1.11. These blocks typically range in heights from 4 to 8 inches, and 8 to 30 inches in width. The blocks are stacked vertically or battered to form the wall face. Mortar or cement is not used between blocks. Most blocks have build-in hollow cores which are filled

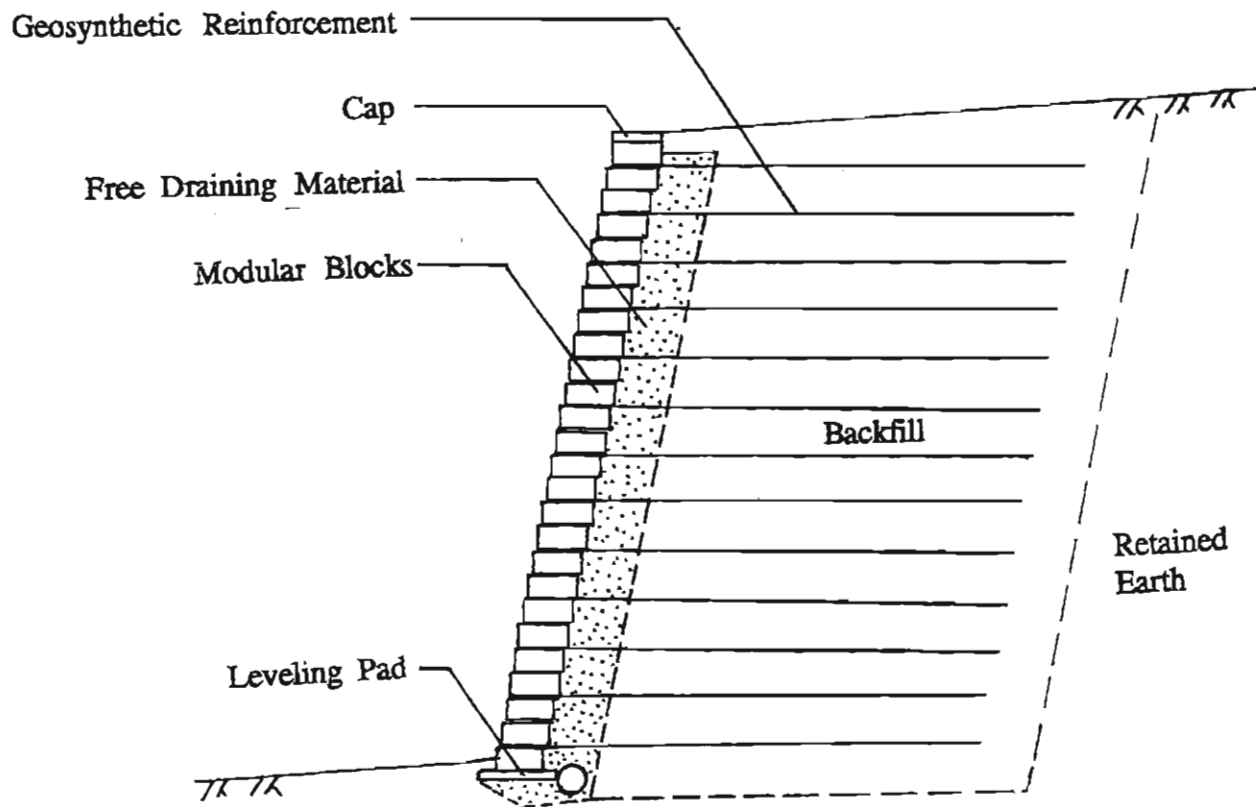

Figure 1.10 Typical Configuration of a Modular-Block GRS Wall

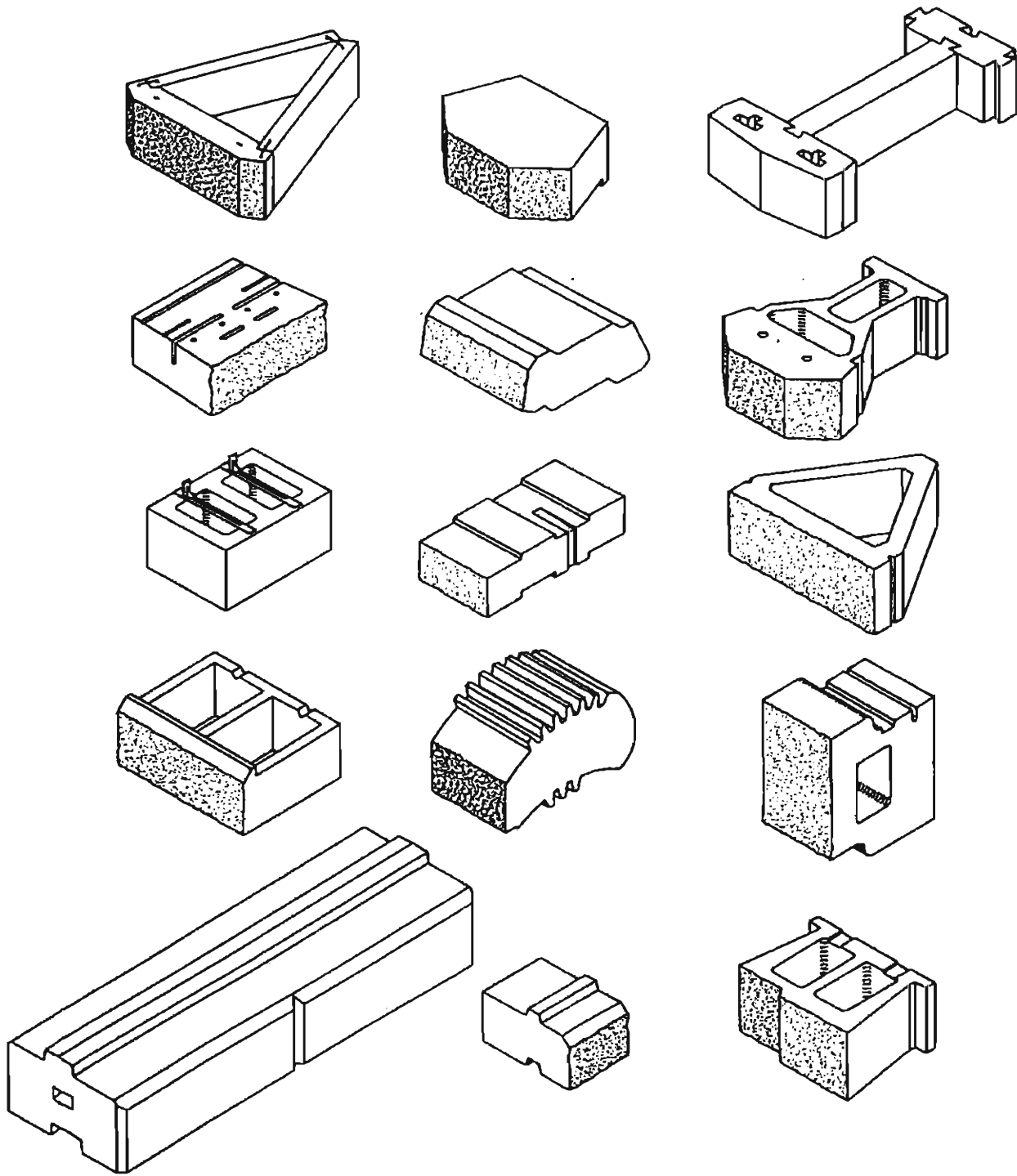

Figure 1.11 Various types of Modular Blocks (Simac, et al., 1993)

with crushed stone or sand during construction to increase their weight (hence the stability of the facing). The geosynthetic reinforcement is placed between blocks such that it is connected to the wall face through interface friction developed between vertically adjacent blocks, with or without the aid of cast-in lips and/or mechanical shear pins (shown in Figure 1.12).

When modular block wall was first developed, they were used mostly as low-gravity landscaping walls of less than 6 ft in height. The use of geosynthetic reinforcement, however, has taken them to new heights. The geosynthetic reinforcement strengthens the backfill and reduces the lateral earth pressure. The modular blocks, while providing some degree of local bending resistance, become primarily an architectural facade. Most geosynthetic-reinforced modular block walls range from 6 to 25 ft in height, although walls as high as 40 ft has been constructed (Anderson, et al., 1991). Modular block geosynthetic-reinforced walls are often battered and commonly built in tiers.

In addition to sharing the advantages of geosynthetic-reinforced walls described in Section 1.1, aesthetic appeal is a distinct advantage of modular block walls over other wall systems. Figure 1.13 shows a completed modular block wall with a rough textured face finish simulating the appearance of natural stone. The combination of a concave face and rough textured finish help mask some construction mis-alignment or post-construction settlement. The narrow width of the articulated blocks also make them adaptable to walls with fairly sharp curves along their length.

Material and engineering costs for modular block geosynthetic-reinforced walls typically range from \$5.50 to \$10 per square foot of wall face, exclusive of the cost of soil

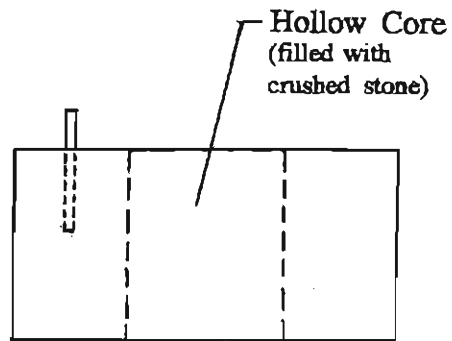

a. Shear Pin

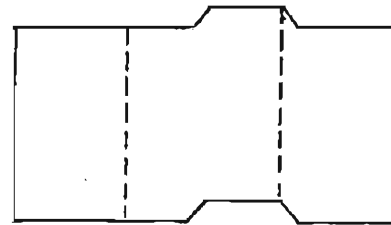

b. Shear Key

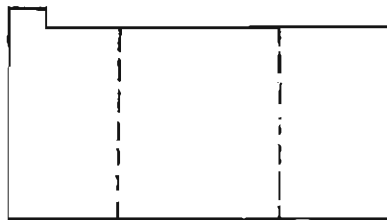

c. Leading Shear Lip

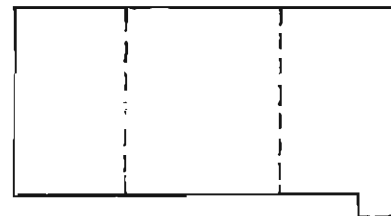

d. Trailing Shear Lip

Figure 1.12 Generic Connections between Vertically Adjacent Blocks (Berg, 1991)



Figure 1.13 A Completed Modular Block GRS Wall (courtesy John Tryba, Amastone Earth Retention Systems)

fill. Like other GRS walls, judicious use of many on-site soils is permitted in the construction of modular block walls.

1.3 Rockery

The term rockery is used for several configurations of stacked rocks. In this Manual, a rockery is defined as a dry-stacked feature of rocks whose base width is at least seventh-tenths of the height, as shown in Figure 1.14.

In most cases, rockeries are selected primarily for aesthetic reasons. However, for locales where large rocks are abundantly available, rockeries may be more cost-effective than other wall systems. There is little research on rockeries, and field monitoring of the performance of rockeries has hardly ever been conducted or reported. Design and construction of a rockery can be considered as an art form. The design and construction guidelines presented in this Manual are provided by Robert K. Barrett of the Colorado Department of Transportation. These guidelines are based on numerous successful construction of rockeries by the Colorado Department of Transportation.

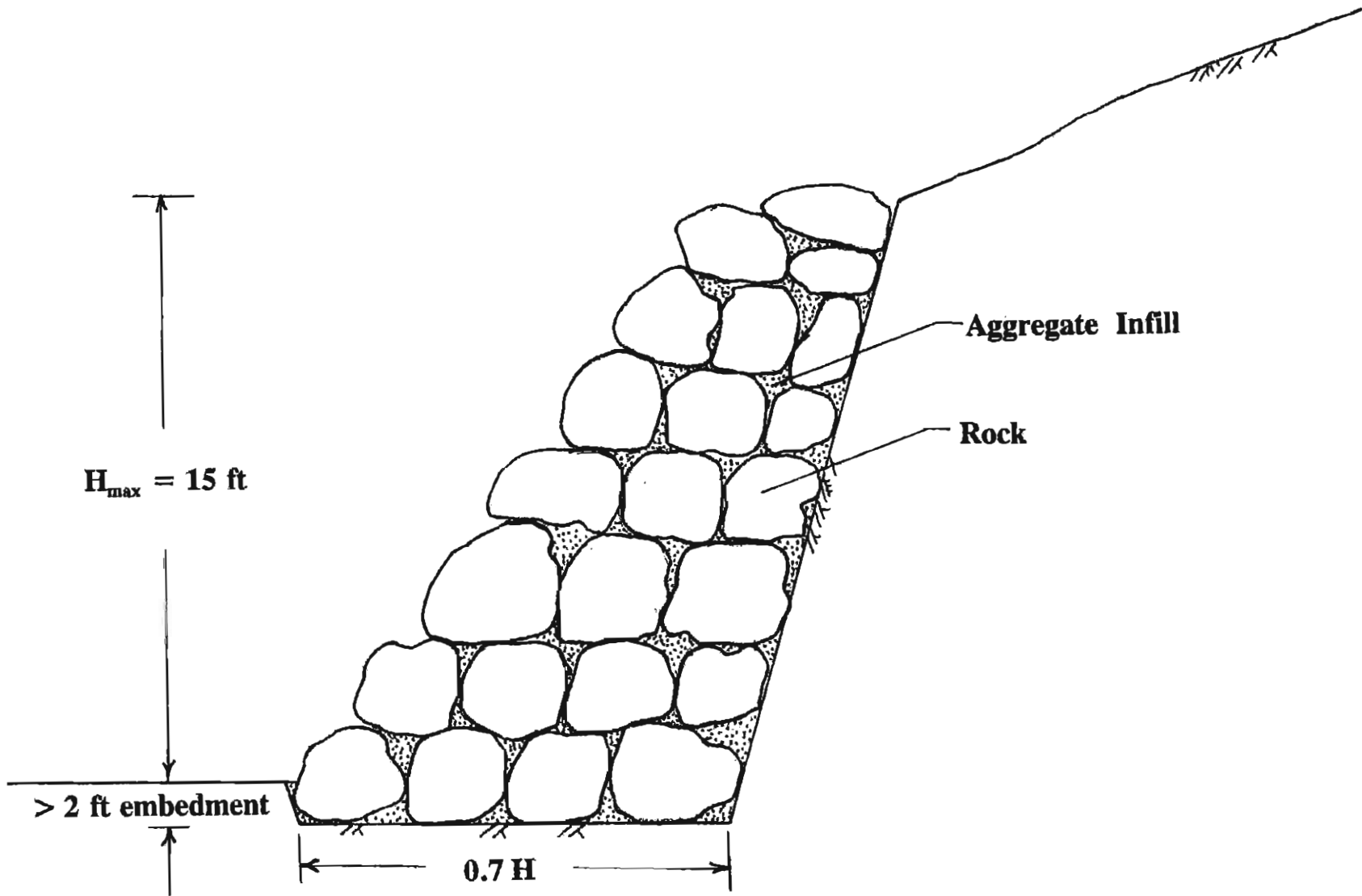

Figure 1.14 Typical Configuration of a Rockery

Chapter 2

DESIGN OF LOW-COST RETAINING WALLS

2.1 Design of Geosynthetic-Reinforced Soil Retaining Walls

2.1.1 Design Concept

The design of Geosynthetic-Reinforced Soil (GRS) retaining walls, including the USFS wrapped-faced geotextile-reinforced wall, the CTI timber-faced geosynthetic-reinforced wall, and modular block geosynthetic-reinforced walls, involves satisfying external stability and internal stability. External stability refers to the stability of the reinforced soil mass as a whole in relation to the soil adjacent to it. Internal stability, on the other hand, refers to stability within the reinforced soil mass.

The external stability is generally evaluated by considering the reinforced soil mass as a rigid gravity retaining wall with earth pressure acting behind the wall. The wall is checked, using methods similar to those for conventional stability analysis of rigid earth retaining structures, for stability against three potential failure modes: sliding failure, foundation bearing failure, and overall slope failure (see Figure 2.1). A fourth potential failure mode, overturning failure, also needs to be addressed if the facing is rigid and the wall is founded on a firm ground.

The internal stability of GRS walls requires that the wall be sufficiently stable against failure within the reinforced soil mass, i.e., the reinforcement is not over-stressed and its length is adequately embedded. Internal failure modes include tensile rupture failure of reinforcement and pullout failure of reinforcement, as shown in Figure 2.2.

(a) Sliding Failure

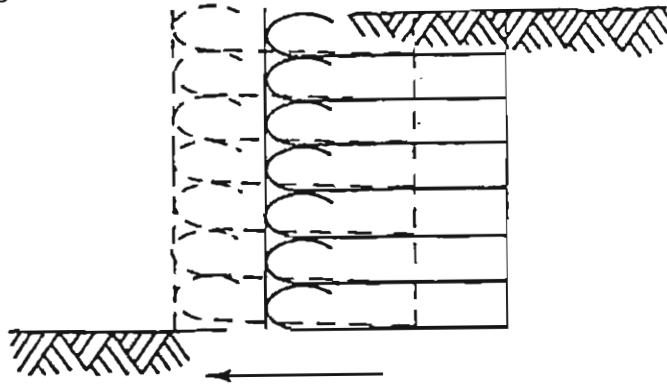

(b) Bearing Failure

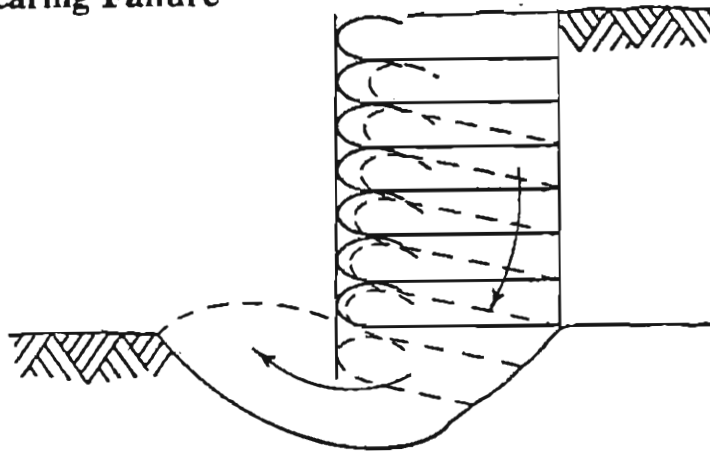

(c) Slope Failure

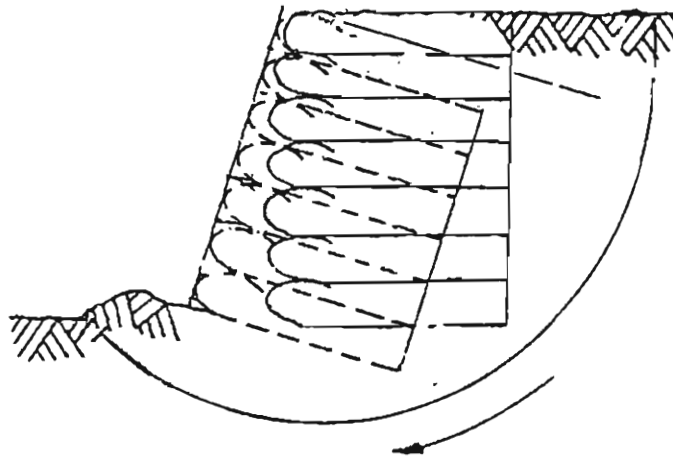
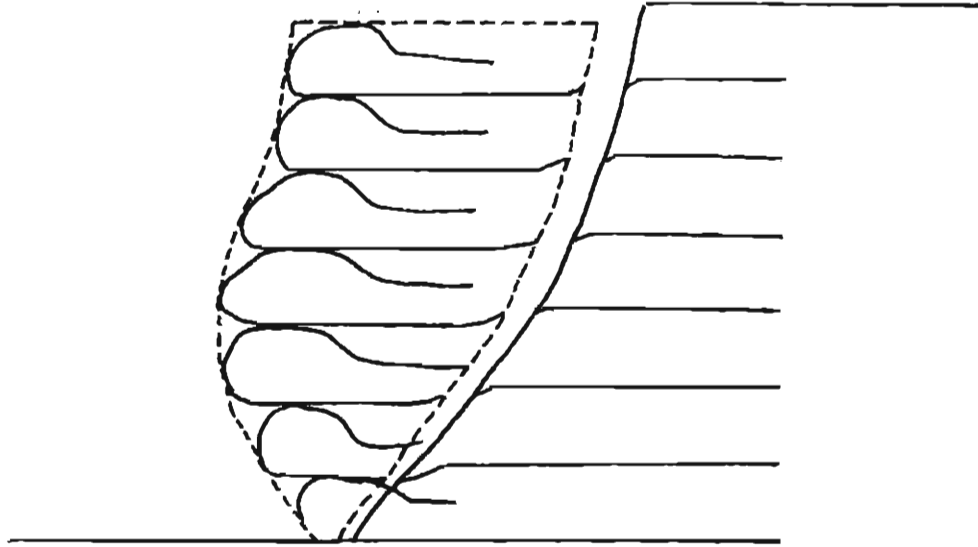

Figure 2.1 External Failure Modes of GRS Walls

(a) Rupture Failure



(b) Pullout Failure

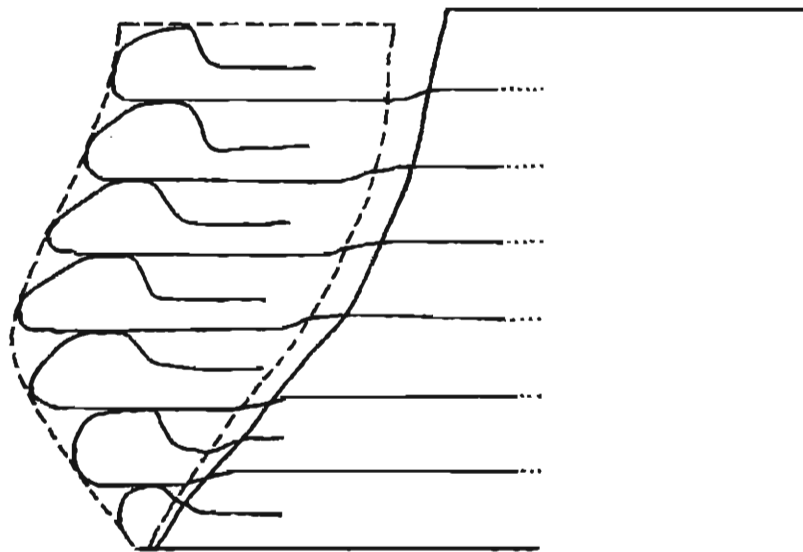

Figure 2.2 Internal Failure Modes of GRS Walls

2.1.2 Design Methodologies

A number of different design methods have been proposed for evaluation of GRS walls against internal failure. They can be categorized into three groups: ultimate-strength method, service-load method, and performance-limit method. The ultimate-strength method is based on the method of limit equilibrium. To provide adequate safety margins, the ultimate-strength design method applies safety factors to the ultimate strength of the materials (soil, reinforcement and facing), to the calculated quantities (forces and moments) obtained by using the ultimate strength, or to both the ultimate strength and calculated quantities. The service-load method is similar to the ultimate-strength method in that it is also based on the method of limit equilibrium. However, the design is primarily for the service loads at which the wall movement and required reinforcement stiffness and strength are determined. The performance-limit approach, on the other hand, allows direct determination of the wall movement and (for some methods) other performance characteristics of the wall. The design is obtained by limiting the wall deformation and/or other wall performance characteristics to ensure satisfactory performance of the wall. It is noted that safety factors are generally used in the performance-limit method to account for long-term performance of the wall.

2.2 Ultimate-Strength Design Methods for GRS Walls

In North and South America and Asia, the most commonly used ultimate-strength design methods have been (1) the U.S. Forest Service method (Steward, Williamson, and

Mohney, 1977, revised 1983), (2) Broms method (Broms, 1978), (3) Bonaparte et al. method (Bonaparte, Holtz, and Giroud, 1987), (4) Collin method (Collin, 1986), (5) Schmertmann et al. method (Schmertmann, Chourey-Curtis, Johnson and Bonaparte, 1987), and (6) Leshchinsky-Perry method (Leshchinsky and Perry, 1987). These design methods can be further divided into two groups: earth pressure methods and slope stability methods. The first four methods belong to the former, while the last two methods belong to the latter.

2.2.1 Earth Pressure Methods

In the earth pressure methods, destabilizing horizontal forces resulting from an assumed lateral earth pressure behind the reinforced fill are resisted by stabilizing horizontal forces provided by the reinforcement. Limiting equilibrium analysis is used to equate the horizontal forces with safety factors to assure adequate safety margins. Two independent safety factors are determined for each layer of reinforcement. The factor of safety for reinforcement rupture is the ratio of reinforcement strength to the lateral earth pressure thrust for the layer. The factor of safety for pullout is the ratio of pullout resistance to the lateral earth pressure thrust for the layer.

All the earth pressure methods assume a planar failure surface through the reinforced mass described by the Rankine active failure condition. For a wall with horizontal crest and subject to a uniform vertical surcharge, the failure surface slopes upward at an angle of $45^\circ + \phi/2$ from the horizontal (ϕ is the angle of internal friction of the backfill), as depicted in Figure 2.3. The reinforcements extend beyond the assumed failure surface and are considered to be tension-resistant tiebacks for the assumed failure wedge. As a result, they

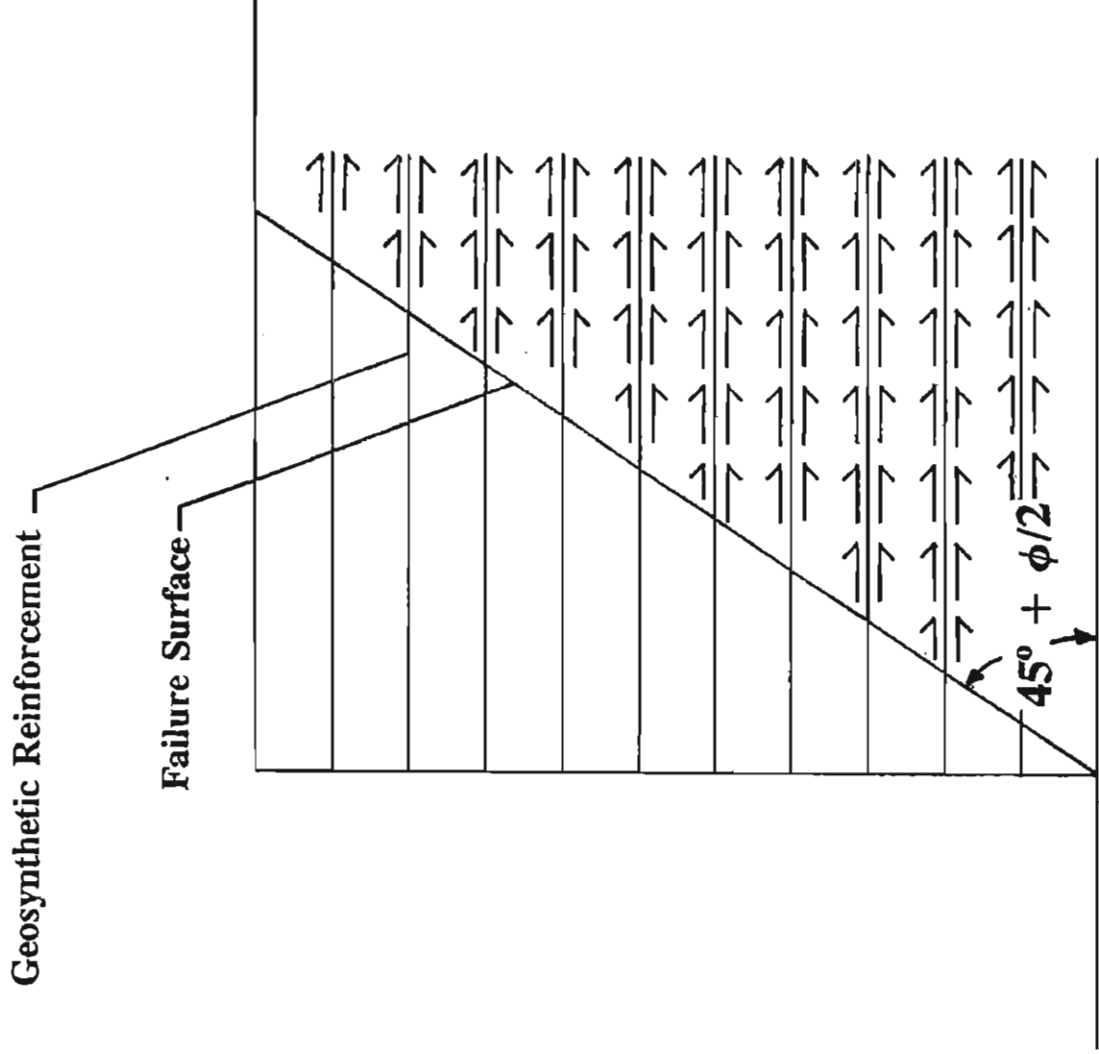

Figure 2.3 Assumed Failure Surface in Earth Pressure Methods

are frequently referred to as tied-back wedge methods.

The four earth pressure methods: the U.S. Forest Service method, Broms method, Bonaparte et al. method, and Collin method, assume different lateral earth pressure distributions to describe the horizontal forces that need to be resisted, as shown in Figure 2.4. The Forest Service method, one of the earliest developed, assumes a linear earth pressure distribution based on the at-rest earth pressure condition. Broms selected a constant earth pressure distribution similar to that recommended by Terzaghi and Peck (1967) for estimating strut loads for braced open cuts in sands. Collin developed constant and linear/constant (trapezoidal) pressure distributions for geotextiles and geogrids, respectively, based on finite element analyses utilizing data from instrumented walls. The Bonaparte et al. method uses a non-linear distribution which is based on the Rankine active earth pressure but accounts for a vertical component of the earth pressure thrust from the retained earth (soil behind the reinforced zone).

2.2.2 Slope Stability Methods

The slope stability methods employ the approach commonly used in conventional slope stability analysis modified to account for the inclusion of tension reinforcements and using varying assumptions concerning the inclination of the reinforcements at the failure surface (see Figure 2.5 for an example). Leshchinsky and Perry used limiting equilibrium analyses of rotational (log-spiral) and translational (planar) failure surfaces. The Schmertmann et al. method is based on limiting equilibrium analysis using wedge failure models. Straight line and bi-linear wedges are used for different aspects of the analysis.

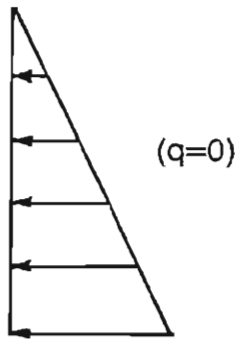

$$\sigma_h = K_o \gamma z$$

(a) FOREST SERVICE

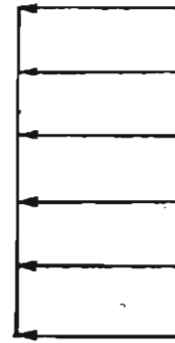

$$\sigma_h = 0.65 K_a (1.5q + \gamma H)$$

(b) BROMS

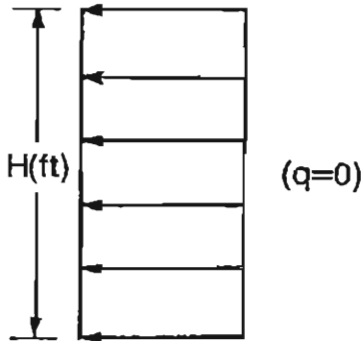

$$\sigma_h = 15H \text{ (psf)}$$

(c) COLLIN (GEOTEXTILE)

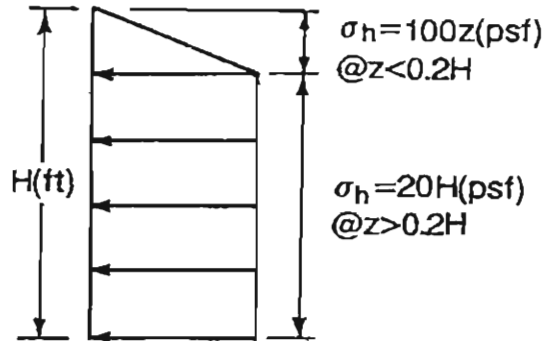

$$\sigma_h = 100z \text{ (psf)} \\ @z < 0.2H$$

$$\sigma_h = 20H \text{ (psf)} \\ @z > 0.2H$$

(d) COLLIN (GEOGRID)

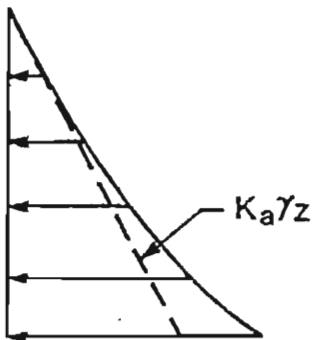

$$\sigma_h = \frac{K_a(\gamma z + q)}{1 - \left[\frac{K_a(\gamma_r z + 3q)}{3(\gamma_r z + q)} \left(\frac{z}{L} \right)^2 \right]}$$

(e) BONAPARTE ET AL

LEGEND

- σ_h = Lateral earth pressure
- H = Height of wall
- γ = Backfill unit weight
- q = Vertical surcharge at top of wall
- $K_o = 1 - \sin \phi$
- $K_a = \tan^2(45^\circ - \phi/2)$
- ϕ = Internal friction angle of backfill soil
- z = depth below top of wall

Figure 2.4 Lateral Earth Pressure Diagrams of Different Earth Pressure Methods (Claybourn and Wu, 1993)

Extended versions of Bishop's modified and Spencer's methods of slope stability analysis were used to modify the results of the wedge analyses. Due to their complicated computations, the Leshchinsky and Perry and Schmertmann et al. methods both use design charts. Both methods can be used for steep slopes as well as vertical to nearly vertical walls.

2.2.3 U.S. Forest Service Method - An Ultimate-Strength Design Method

In this section, the design procedure of the U.S. Forest Service method (developed in 1977 and revised in 1983) is presented, followed by a design example to illustrate the design method. The design method has been implemented in a computer program called GREWSON ("son of GREWS"). The design method is applicable to all three types of GRS walls, although the CTI timber-faced wall (whose facing possesses a fair degree of local and global rigidity, as long as the timber and forming element retain their strength) and modular block geosynthetic-reinforced walls (whose facing possesses a high local rigidity) will have a larger inherent safety margin than the USFS wrapped-faced wall.

2.2.3.1 Design Procedure

Step 1: Establish wall profile and check design assumptions

A wall profile should be established from the grading plan of the wall site. The following design assumptions should be verified:

- The wall face is vertical or near vertical.
- The crest is horizontal.
- The backfill is granular and free draining.

- The wall is constructed over a firm foundation.
- The live loads are vertical.
- Seismic loading is not a concern.

If any of the design assumptions is not satisfied, the design method should not be used.

Step 2: Determine backfill properties ϕ and γ

The friction angle, ϕ , can be estimated conservatively by a soils engineer or determined by performing appropriate direct shear or triaxial tests. The unit weight, γ , can be determined in a moist density test. Generally, the unit weight at 95% Standard Proctor relative compaction (i.e., 95% of AASHTO T-99 maximum unit weight) is specified. However, other densities can also be specified as long as the friction angle ϕ is consistent with that density.

Step 3: Develop lateral earth pressure diagram due to overburden pressure

The friction angle ϕ determined in Step 2 can be used to calculate the coefficient of earth pressure at rest, $K_o = 1 - \sin \phi$, which in turn can be used to establish the linear lateral earth pressure diagram along the height of the wall (see Figure 2.6). The lateral earth pressure at depth z (measured from the crest) is:

$$\sigma_{h(o)} = K_o (\gamma z + q)$$

in which, q is the vertical surcharge pressure uniformly applied on the crest.

Step 4: Develop lateral earth pressure diagram due to live loads

The lateral earth pressure due to live loads can be calculated by Boussinesq equation. For a vertical load P applied at a point located at distances x (perpendicular to the wall

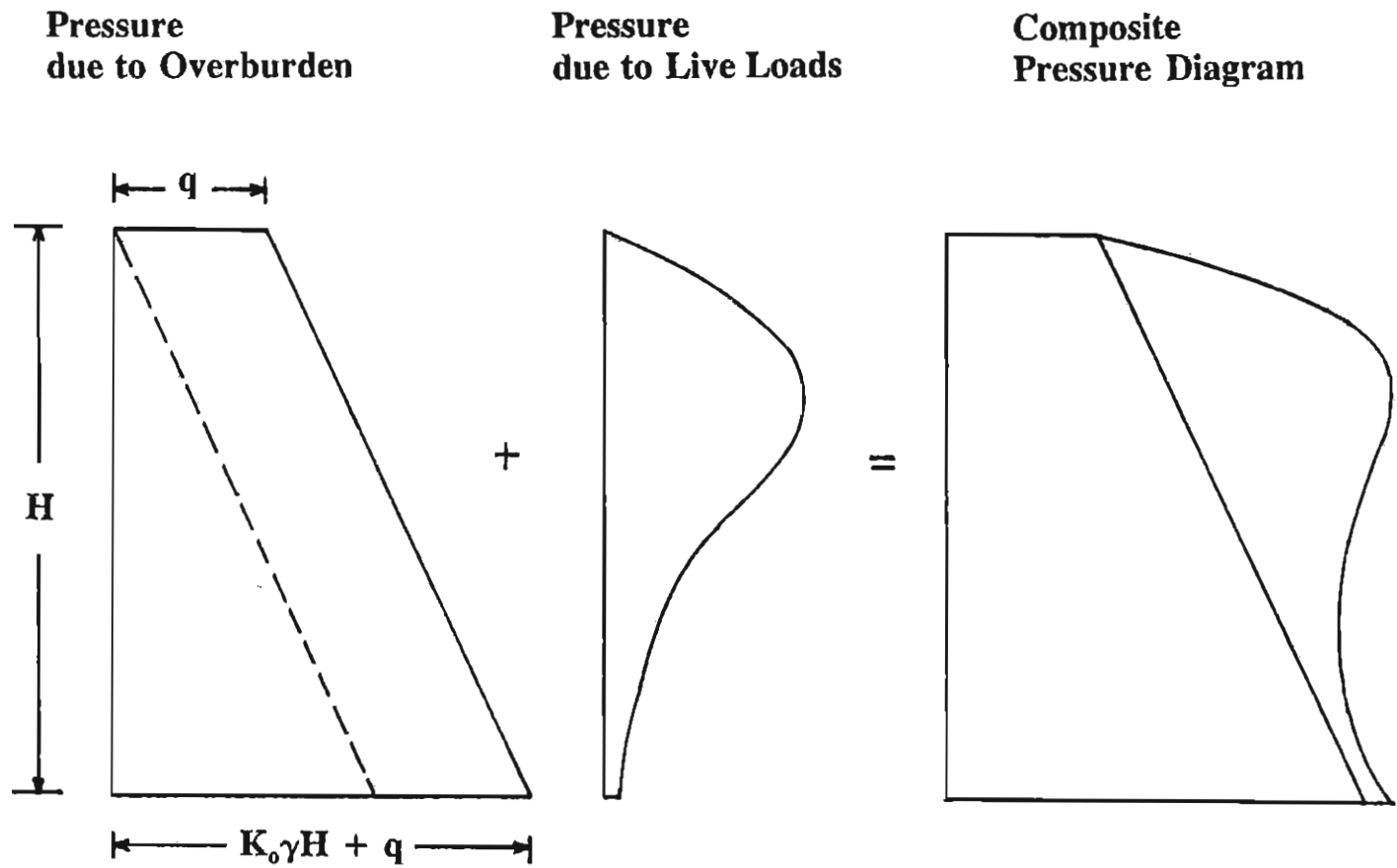

Figure 2.6 Lateral Earth Pressure due to Overburden and Live Loads

face) and y (parallel to the wall face) from a selected section along the wall, the lateral pressure at depth z along the selected section is:

$$\sigma_{h(z)} = \frac{P x^2 z}{R^5}$$

in which $R = (x^2 + y^2 + z^2)^{1/2}$. The lateral pressure is typically evaluated at 2-ft vertical intervals (i.e., $z = 2$ ft, 4 ft, etc.) over the height of the wall. Figure 2.7 shows the influence diagrams for lateral earth pressure due to a line load and a point load. The figure can greatly aid the calculations of $\sigma_{h(z)}$. When multiple live loads are applied, $\sigma_{h(z)}$ can be obtained by superimposing the pressure due to each live load. An example for calculating lateral earth pressure due to an eight wheel 40-kip dual tandem axle truck can be found in Steward, et al. (1983) and Koerner (1990). Normally, from one to three sections along the wall should be checked to determine the most critical one. The values of live loads P can be determined as the larger value between $1.5 *$ (legal loads) and $1.2 *$ (heavy loads).

Step 5: Develop composite lateral earth pressure diagram due to overburden pressure and live loads

The lateral earth pressure diagrams determined from Steps 3 and 4 are superimposed to form a composite lateral earth pressure diagram, as shown in Figure 2.6.

Step 6: Determine vertical spacing of reinforcement layers

The vertical spacing between reinforcement layers, s , can be determined by the following equation:

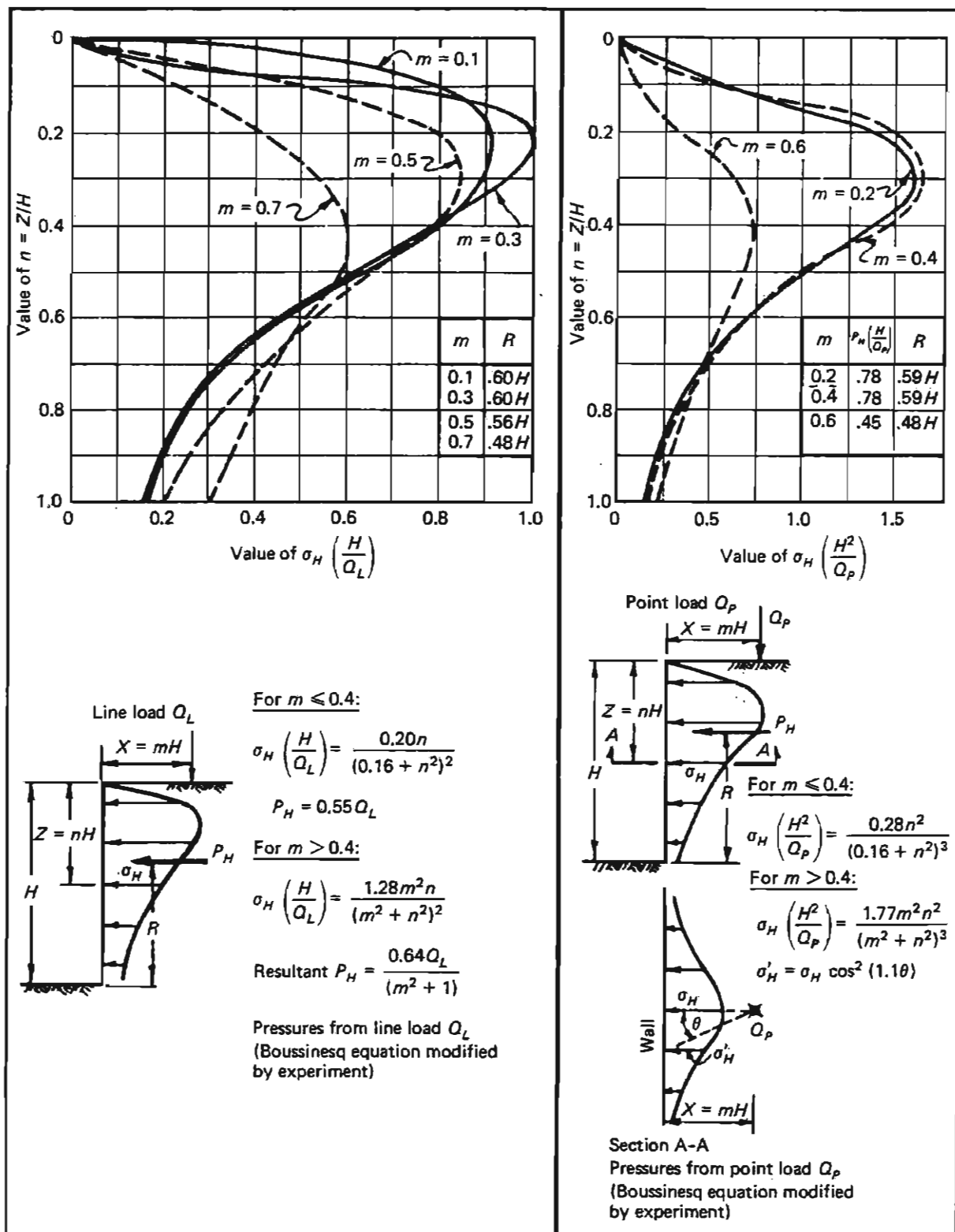

Figure 2.7 Lateral Earth Pressure Influence Diagrams due to a Surface Line Load and a Surface Point Load (NAVFAC, 1982)

$$s = \frac{T_{ult}}{F_s \sigma_h}$$

in which F_s , the factor of safety, should be at least between 1.2 to 1.5, depending on the confidence level in the ultimate strength of the reinforcement. σ_h is the lateral earth pressure at the middle of the layer, which is obtained from the combined pressure diagram (Step 5).

T_{ult} is the ultimate strength of the reinforcement. The value of T_{ult} can be specified by either (A) wide cut strip tensile test, or (B) a combination of grab tensile and 1-in. cut strip tests. The tests should be performed with the reinforcement in its weakest principal direction, and Method A is preferred over Method B.

To account for long-term creep potential, a reduction factor should be applied to the tensile strength obtained from the tests. The value of the reduction factor depends on the test method as well as the polymer type and style of the reinforcement as follows:

<u>Polymer Type & Style</u>	<u>Test Method A</u>	<u>Test Method B</u>
Polyester needled	0.7	1.0
Polypropylene needled	0.55	0.8
Polypropylene bonded	0.4	0.6
Polypropylene woven	0.25	0.4

When Method A is used to determine T_{ult} , the following conditions should be observed:

- The aspect ratio (the ratio between width and gage length) of the test specimen should be no less than 2 : 1. The minimum gage length (between test grips) should be 4 inches.
- The test should be performed at a constant strain rate of 10% per minute.
- The test should be performed in the conditions of $65 \pm 2\%$ relative humidity and 70 ± 2 °F (21 ± 1 °C) temperature.
- The test specimen should be soaked in water for at least 12 hours and maintained surface damp during test.
- The grips used in the test should not weaken the specimen and should be able to hold the specimen without slippage. Tests which fail at the grips should be disallowed. If slippage cannot be sufficiently limited, elongation must be measured between points on the specimen rather than between the grips.
- Test results should include applied tensile force per unit width of specimen vs. strain curve, failure load per unit width, and strain at failure.

When using Method B to determine T_{ult} , the lesser value of the following two strengths should be used: (1) 90% of the 1-in. cut strip strength, or (2) 33% of the grab tensile strength.

Step 7: Determine the length of reinforcement required to develop pullout resistance

As shown in Figure 2.8, the total length of reinforcement, L , required to prevent pullout failure from occurring is equal to the sum of the anchored length behind the potential failure plane, L_c , and the length within the potential failure zone, L_r . For a reinforcement at depth z below the crest,

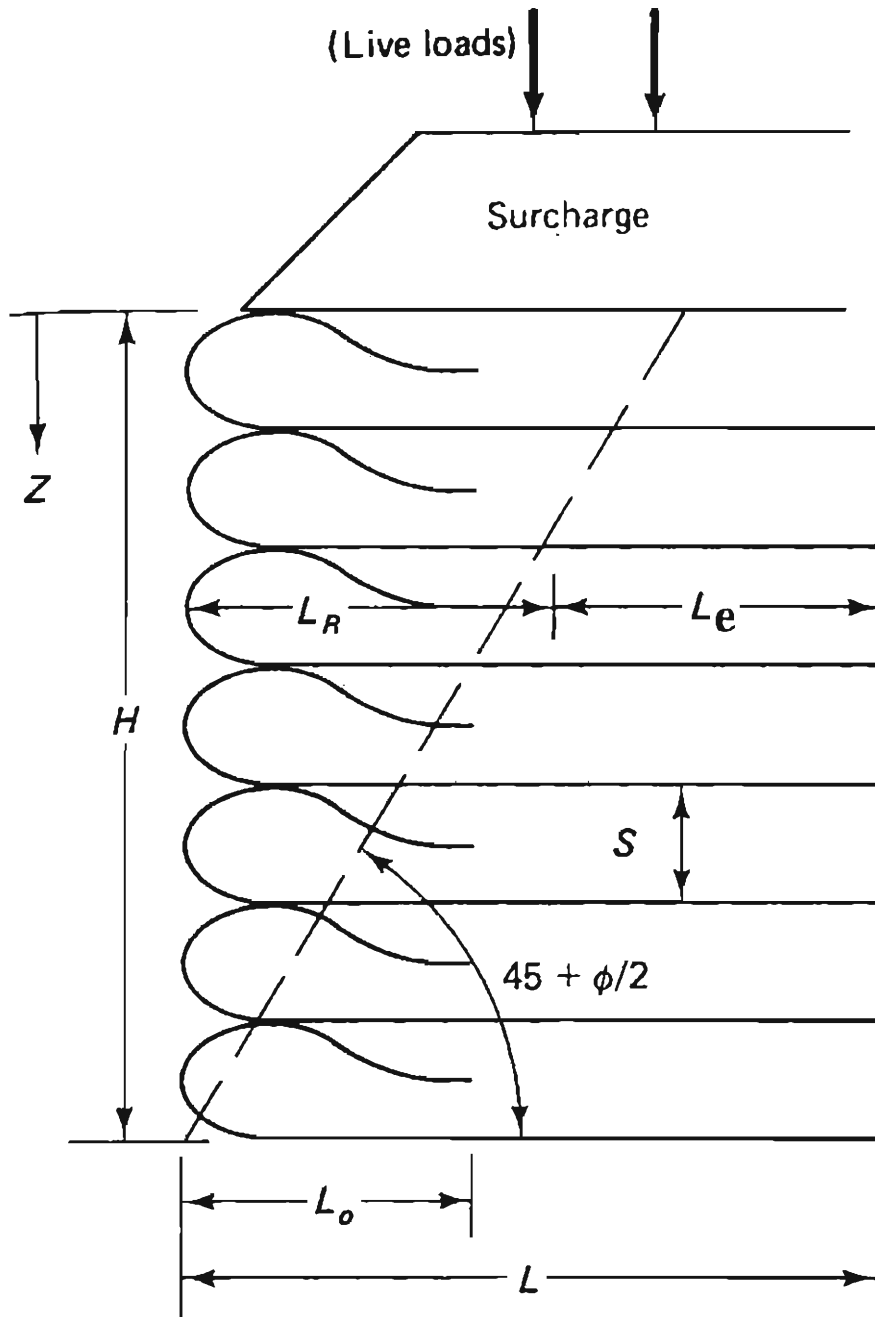

Figure 2.8 Notations used in the USFS Design Method

$$L = L_e + L_f$$

where,

$$L_f = (H - z) \tan\left(45^\circ - \frac{\phi}{2}\right)$$

$$L_e = \frac{K_o s F_s}{2 \tan\left(\frac{2}{3} \phi\right)}$$

in which, H is the wall height, z is the depth of reinforcement layer being considered. The safety factor against pullout failure, F_s , should be at least 1.5 to 1.75. A minimum value of $L_e = 3$ ft should be used.

Where different soils are used above and below a reinforcement layer, the equation for calculating L_e is modified as:

$$L_e = \frac{K_o s F_s}{\tan\left(\frac{2}{3} \phi_1\right) + \tan\left(\frac{2}{3} \phi_2\right)}$$

in which, ϕ_1 and ϕ_2 are the friction angles of the soils above and below the reinforcement layer.

Theoretically, the reinforcement layers at the base can be shorter than at the top to satisfy the internal stability of the reinforced structure. However, because of external stability considerations (Step 9), particularly with respect to sliding and bearing capacity, all reinforcement layers are normally of uniform length.

Step 8: Determine the wrapped length of reinforcement at the wall face

The wrapped length of reinforcement at the wall face, L_o (see Figure 2.8), can be determined by the following equation:

$$L_o = \frac{\sigma_h s F_s}{2 (\gamma z + q) \tan\left(\frac{2}{3} \phi\right)}$$

The minimum value for the safety factor, F_s , is 1.2 to 1.5. The minimum value for L_o is 3 ft.

Step 9: Check external stability

The external stability against overturning, sliding and foundation bearing capacity should be checked.

Overturning loads are developed from the lateral earth pressure diagram for the back of the wall. This may be different from the lateral earth pressure diagram used in checking internal stability (Step 5), particularly due to placement of live loads. Overturning is checked by summing moments of external forces about the bottom at the face of the wall.

Sliding along the base is checked by summing external horizontal forces. Bearing capacity is checked using foundation bearing capacity factors (Navy, 1971; Terzaghi and Peck, 1968; Leonards, 1962).

2.2.3.2 Design Example

Given Conditions

The cross-section of a USFS wrapped-faced geotextile-reinforced soil retaining wall is shown in Figure 2.9.

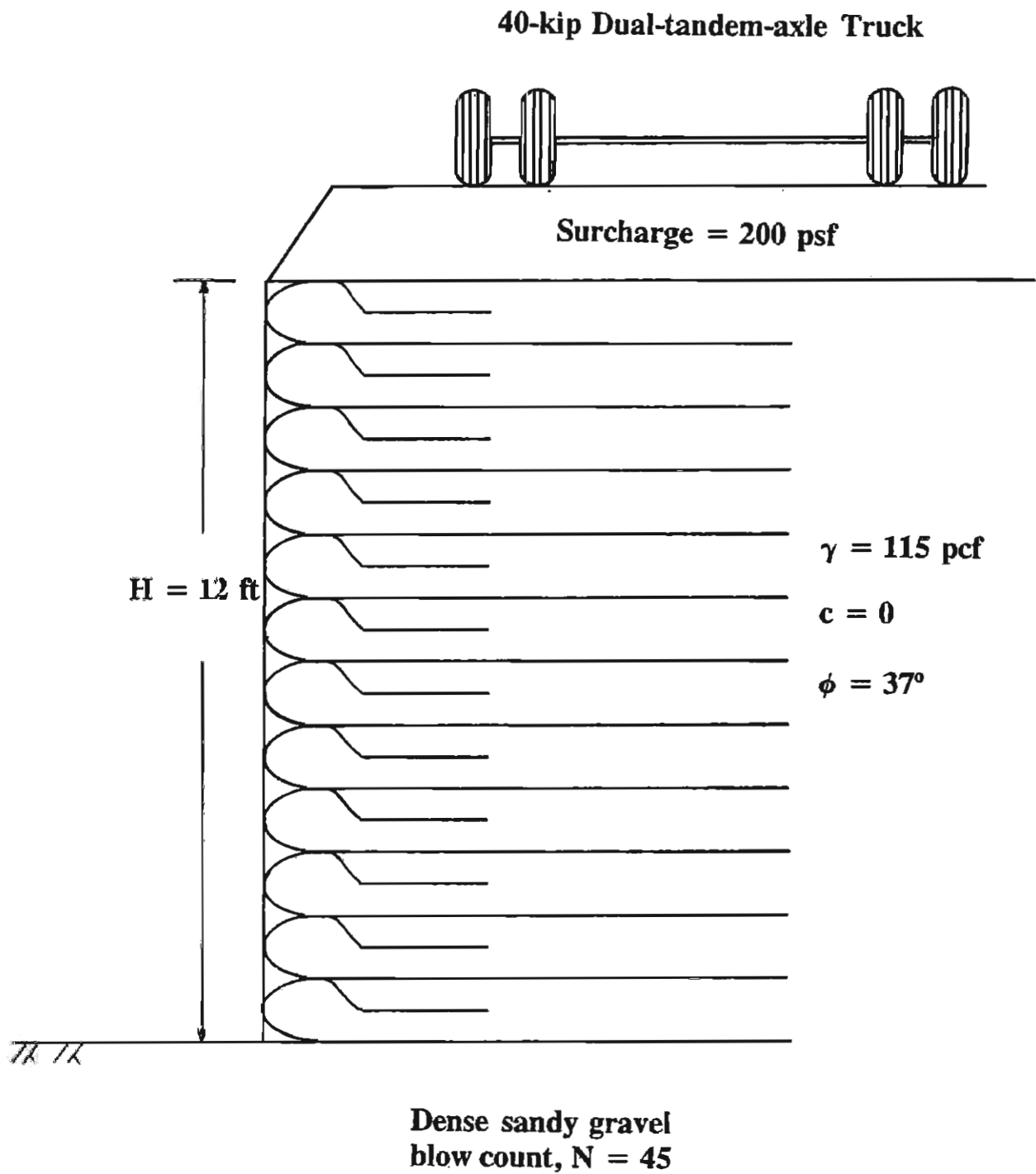

Figure 2.9

Cross-Section of a GRS Wall - Design Example for the USFS Method

Characteristics of the wall:

- uniform wall height: $H = 12$ ft
- vertical wall
- all geosynthetic reinforcement layers are to have the same length
- no embedment (wall constructed directly on the ground)

Characteristics of the backfill and retained earth:

- The same soil is to be used for the backfill and retained earth (the soil behind the reinforced zone), and the density and moisture in the backfill and retained earth are similar.
- the soil is granular, with moist unit weight $\gamma = 115$ pcf, $c = 0$, and $\phi = 37^\circ$ at 95% of AASHTO T-99 maximum density.
- surface drainage are properly provided

Characteristics of the foundation soil:

- the soil is a dense sandy gravel with a uniform blow count of 45
- deep water table

Characteristics of a "trial" reinforcement material:

- a polyester needled geotextile which has an ultimate strength, T_{ult} , of 2,520 lb/ft, determined by the wide cut strip tensile test (Method A described in Section 2.2.3.1).

Characteristics of loading:

- vertical surcharge uniformly distributed over the crest, $q = 200$ psf

- a 40-kip live load on the crest due to a dual-tandem-axle truck whose wheel dimensions and positions with respect to the wall face are shown in Figure 2.10.
- no concern of seismic loading

Design Computations:

Step 1: Establish wall profile and check design assumptions

The wall profile is as shown in Figure 2.9. The design assumptions listed in Section 2.2 are verified, including granular backfill and a firm foundation.

Step 2: Determine backfill properties ϕ and γ

The backfill is granular, with moist unit weight $\gamma = 115$ pcf, $c = 0$, and $\phi = 37^\circ$ at 95% of AASHTO T-99 maximum density.

Step 3: Develop lateral earth pressure diagram due to self weight of backfill and surcharge pressure

The coefficient of earth pressure at-rest, $K_o = 1 - \sin\phi = 1 - \sin(37^\circ) = 0.4$.

The lateral earth pressure (in psf) at depth z is:

$$\begin{aligned}\sigma_{h(o)} &= K_o (\gamma z + q) \\ &= 0.4 (115 * z + 200)\end{aligned}$$

The lateral earth pressure along the wall height is tabulated in Table 2.1 and depicted in Figure 2.11.

Step 4: Develop lateral earth pressure diagram due to live loads

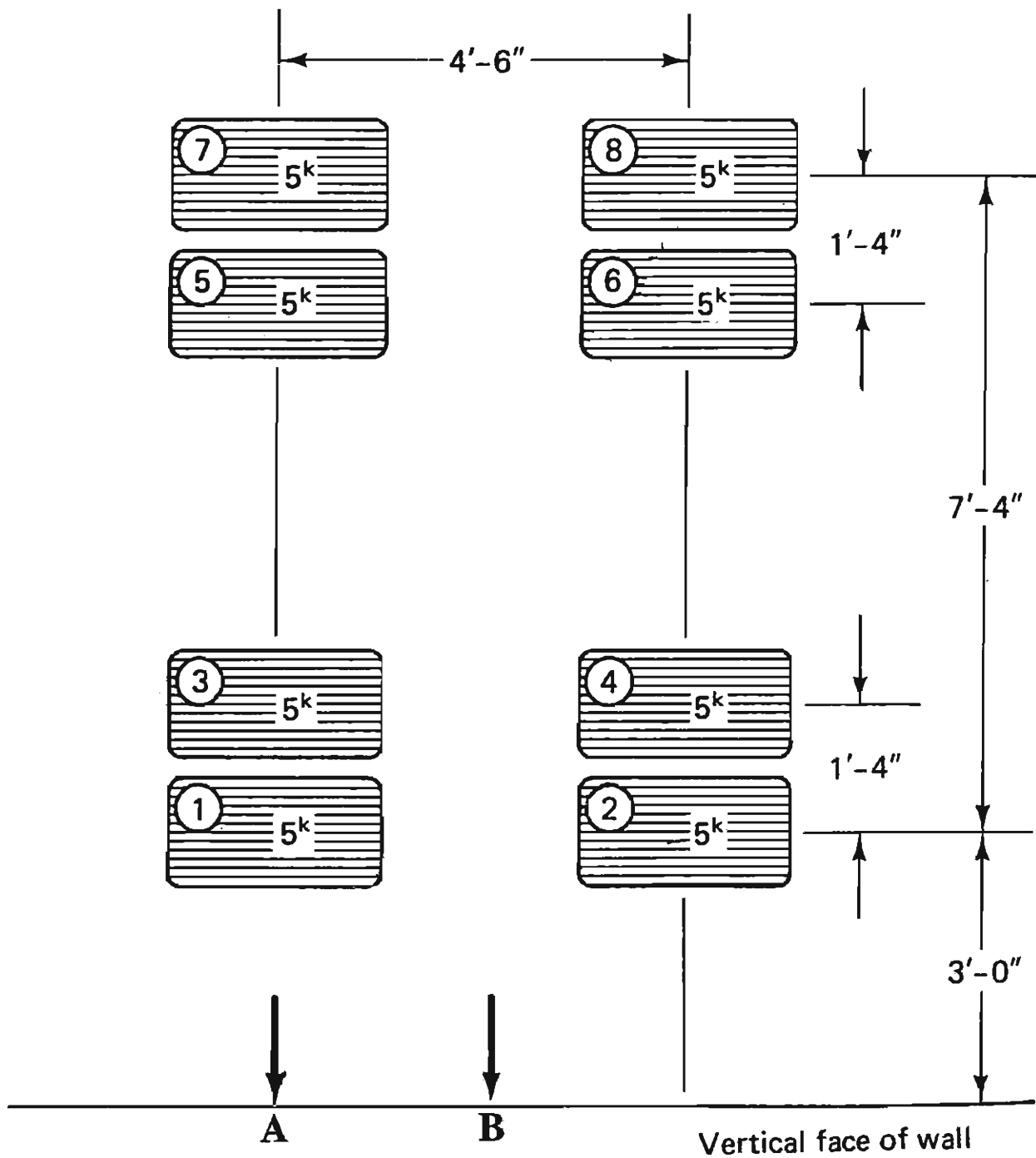

Figure 2.10 Live Loads on Wall Crest due to a 40-kip Dual-Tandem-Axle Truck (Top View)

Table 2.1 Reinforcement length calculations

Depth (ft)	$\sigma_{h(o)}$ (psf)	$\sigma_{h(0)}$ [*] (psf)	σ_h ^{**} (psf)	s (ft)	L_c (ft)	L_r (ft)	L ^{***} (ft)	L_o (ft)
0	80	0	80	14.7	3.0	6.0	9.0	0.8
2	172	137	309	3.8	3.0	5.0	8.0	1.4
4	264	181	445	2.6	3.0	4.0	7.0	1.3
6	356	134	490	2.4	3.0	3.0	6.0	1.1
8	448	85	533	2.2	3.0	2.0	5.0	0.9
10	540	46	586	2.0	3.0	1.0	4.0	0.9
12	632	24	656	1.8	3.0	0	3.0	0.8

Note: * obtained from Table 2.2 (at Section A)

$$^{**} \sigma_h = \sigma_{h(o)} + \sigma_{h(0)}$$

$$^{***} L = L_c + L_r$$

scale  300 psf

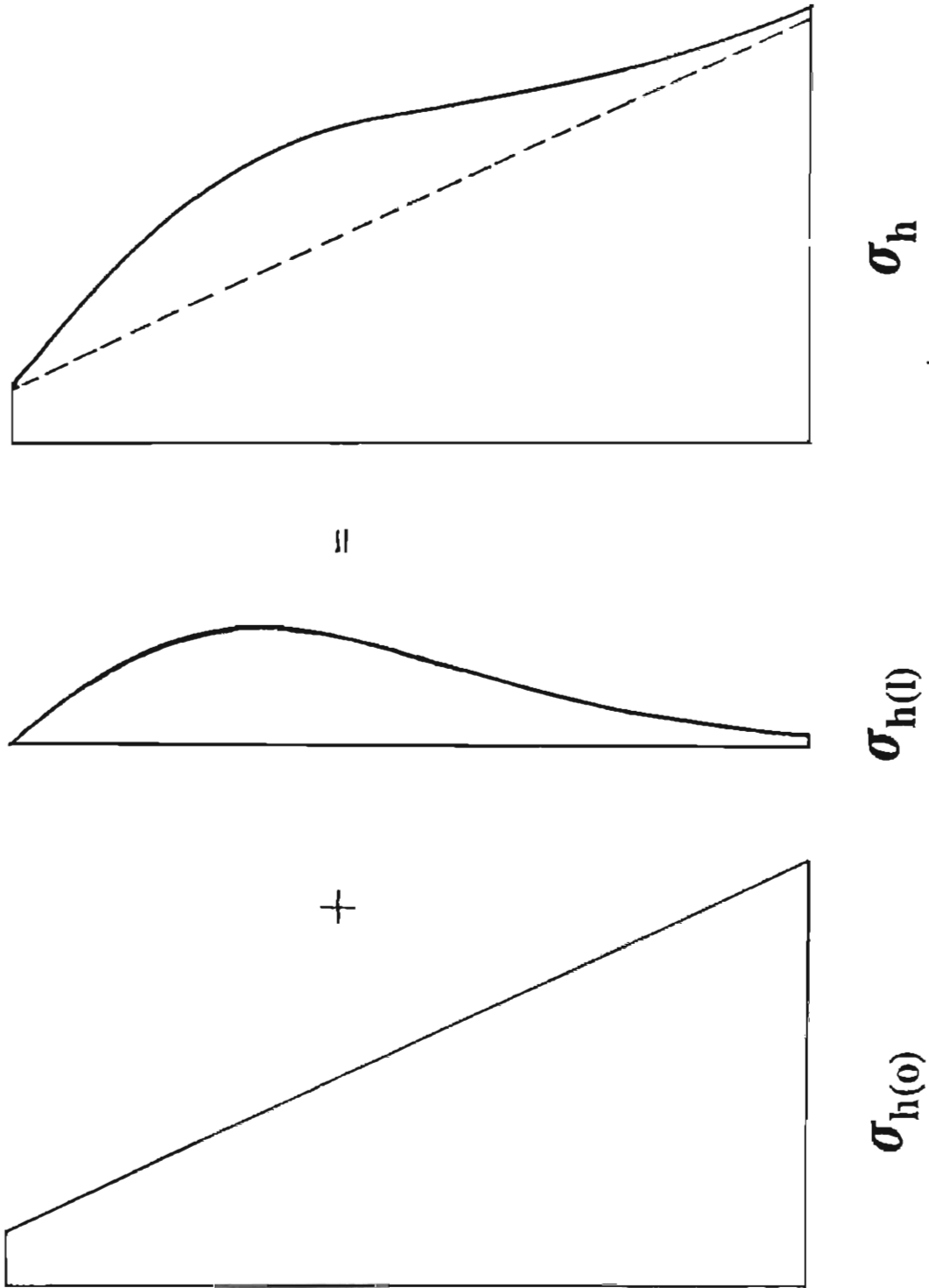

Figure 2.11 Lateral Earth Pressure of the Design Example

The lateral earth pressures due to the eight-wheel live load of 40 kips are determined with the aid of Figure 2.7. The earth pressure due to the live load at 2-ft increment of the wall height was evaluated at two vertical sections: Sections A and B in Figure 2.10. The earth pressure is found to be larger in Section A than in Section B (see Table 2.2); thus, the pressure at Section A is used in the design. The earth pressure due to the live load is plotted in Figure 2.11.

Step 5: Develop composite lateral earth pressure diagram

The composite earth pressure diagram is obtained by combining the earth pressures obtained in Steps 3 and 4. The composite earth pressure along the wall height is tabulated in Table 2.1 and plotted in Figure 2.11.

Step 6: Determine vertical spacing of reinforcement layers

For the trial reinforcement (a polyester needled geotextile), the ultimate strength is reduced by a factor of 0.7; thus $T_{ult} = 0.7 (2,520) = 1,760$ lb/ft. Using a F_s of 1.5, the vertical spacing, s , can be calculated as:

$$s \text{ (ft)} = \frac{1760}{(1.5) \sigma_h}$$

The required minimum vertical spacing along the wall height is tabulated in Table 2.1. A uniform vertical spacing of 1.5 ft (or 18 in.) is selected for the design.

Step 7: Determine the length of reinforcement

With $F_s = 1.5$, the required anchored length behind the potential failure plane, L_a , and the length within the potential failure plane, L_r , are calculated as:

Table 2.2 Lateral earth pressure due to live load

(a) at Section A

Depth (ft)	Wheel Number								σ_{h0} (psf)
	1	2	3	4	5	6	7	8	
0	0	0	0	0	0	0	0	0	0
2	45.1	9.9	45.1	18.0	6.9	5.3	3.5	2.8	136.6
4	55.5	12.2	59.0	23.6	10.4	7.9	6.9	5.6	181.1
6	34.7	7.6	34.7	13.9	13.8	10.5	10.4	8.4	134.0
8	20.8	4.6	20.8	8.3	10.4	7.9	6.9	5.6	85.3
10	10.4	2.3	10.4	4.2	6.9	5.2	3.5	2.8	45.7
12	3.5	0.8	5.2	2.1	3.4	2.6	3.5	2.8	23.9

Note: σ_h (from wheels 2) = 0.22 σ_h (from wheel 1); $\theta = 56.3^\circ$
 σ_h (from wheels 4) = 0.40 σ_h (from wheel 3); $\theta = 46.1^\circ$
 σ_h (from wheels 6) = 0.76 σ_h (from wheel 5); $\theta = 26.5^\circ$
 σ_h (from wheels 8) = 0.81 σ_h (from wheel 7); $\theta = 23.5^\circ$

(b) at Section B

Depth (ft)	Wheel Number				σ_{h0} (psf)
	1 & 2	3 & 4	5 & 6	7 & 8	
0	0	0	0	0	0
2	23.4	31.6	6.4	3.3	129.4
4	28.9	41.3	9.7	6.4	172.6
6	18.0	24.3	12.8	9.7	129.6
8	10.8	14.6	9.7	6.4	83.0
10	5.4	7.3	6.4	3.3	44.8
12	1.8	3.6	3.2	3.3	23.8

Note: σ_h (from wheels 1 & 2) = 0.52 σ_h (from wheel 1 @ Section A); $\theta = 39.8^\circ$
 σ_h (from wheels 3 & 4) = 0.70 σ_h (from wheel 3 @ Section A); $\theta = 30.2^\circ$
 σ_h (from wheels 5 & 6) = 0.93 σ_h (from wheel 5 @ Section A); $\theta = 15.5^\circ$
 σ_h (from wheels 7 & 8) = 0.93 σ_h (from wheel 7 @ Section A); $\theta = 13.6^\circ$

$$\begin{aligned}
 L_e &= \frac{K_o s F_s}{2 \tan\left(\frac{2}{3} \phi\right)} \\
 &= \frac{0.4 * 1.5 * 1.5}{2 * \tan\left(\frac{2}{3} * 37^\circ\right)} = 1.0 \text{ (ft)}
 \end{aligned}$$

$$\begin{aligned}
 L_f &= (H - z) \tan\left(45^\circ - \frac{\phi}{2}\right) \\
 &= (12 - z) \tan\left(45^\circ - \frac{37^\circ}{2}\right)
 \end{aligned}$$

It is to be noted that the length L_e is less than the minimum required length of 3 ft; thus $L_e = 3$ ft was used. The values of L_e and L_f as well as the total reinforcement length L ($L = L_e + L_f$) along the wall height are listed in Table 2.1. A uniform length of 9 ft is selected for all reinforcement layers.

Step 8: Determine the wrapped length of reinforcement

The wrapped length, L_o , at the wall face is calculated as:

$$\begin{aligned}
 L_o &= \frac{\sigma_h s F_s}{2 (\gamma z + q) \tan\left(\frac{2}{3} \phi\right)} \\
 &= \frac{\sigma_h * 1.5 * 1.2}{2 * (115 * z + 200) \tan\left(\frac{2}{3} * 37^\circ\right)}
 \end{aligned}$$

The values of L_o along the wall height are listed in Table 2.1. All the L_o values are less than the minimum required length of 3 ft; therefore L_o of 3 ft is selected for all reinforcement layers.

Step 9: Check external stability

External stability against overturning, sliding, and bearing capacity should be checked before accepting the design.

2.2.4 Limitations of the Ultimate-Strength Design Methods

There are several limitations that should be recognized when designing a GRS retaining wall by one of the ultimate-strength design methods mentioned in Section 2.2. The following are four major limitations of the ultimate-strength design methods:

- (1) *The design methods use somewhat arbitrarily assigned safety factors.*

Due to the lack of reliable empiricism with geosynthetic-reinforced soil retaining walls, the safety factors assigned in the design methods are somewhat arbitrary. A study conducted by Claybourn and Wu (1991) to compare six design methods revealed that there are very significant discrepancies in the safety factors for the various design methods. In a typical wall examined in that study, the combined factor of safety (in terms of the total quantity of reinforcement required) ranged from 3 to 23 depending on the method used. Due largely to the wide disparity in the safety factors, the design obtained by different design methods can be very different. The design

of a 12-ft high wall by using six ultimate-strength design methods is shown in Figure 2.12.

(2) *The design methods can not determine the wall deformation under service loads*

All the ultimate-strength design methods are based on the method of limit equilibrium. An inherent problem with the limit equilibrium method is its inability to estimate the wall deformation under service loads.

Moreover, geosynthetics having comparable ultimate strength may have very different stiffness (see Figure 2.13). The ultimate-strength methods apply the factor of safety to the ultimate strength without any regard to the stiffness. Consequently, the wall deformation for walls designed by the ultimate-strength methods can be very different under service loads.

(3) *The design methods are limited to firm foundation, granular backfill and ignore facing rigidity.*

One of the advantages of GRS walls is that they are capable of withstanding large deformations due to foundation settlement. However, none of the ultimate-strength design methods address the effects of foundation settlement. The design methods simply assume that the wall is to be constructed over a rigid foundation. In addition, facing rigidity which is known to have very significant effects on wall performance (Tatsuoka, et al., 1992) is not addressed in any of the ultimate-strength design methods.

Perhaps more importantly, the ultimate-strength design methods are limited to the use of granular backfill. The performance of the hundreds of

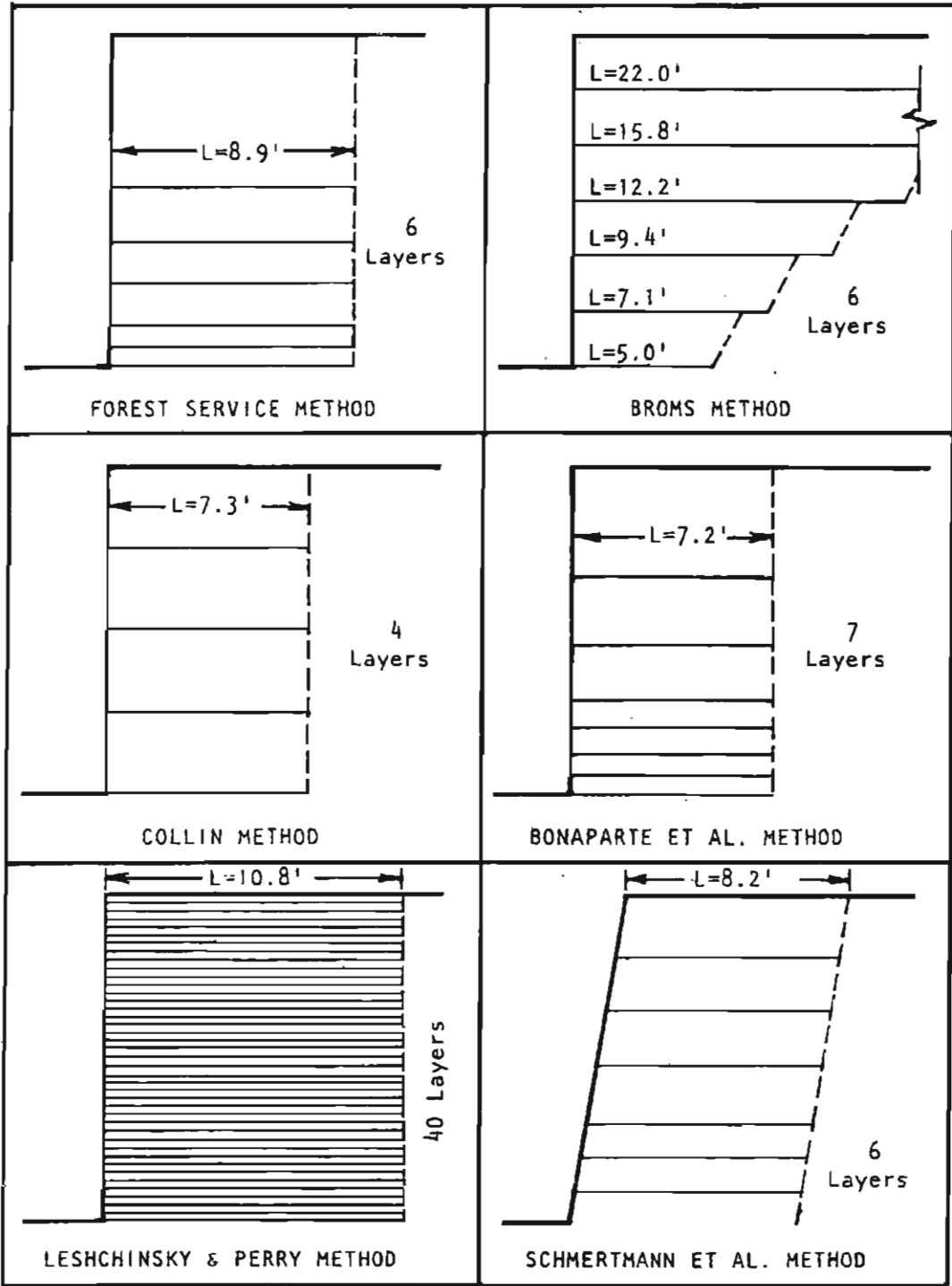

Figure 2.12 Design of a 12-ft High GRS Wall by Six Different Ultimate Strength Design Methods (Claybourn and Wu, 1991)

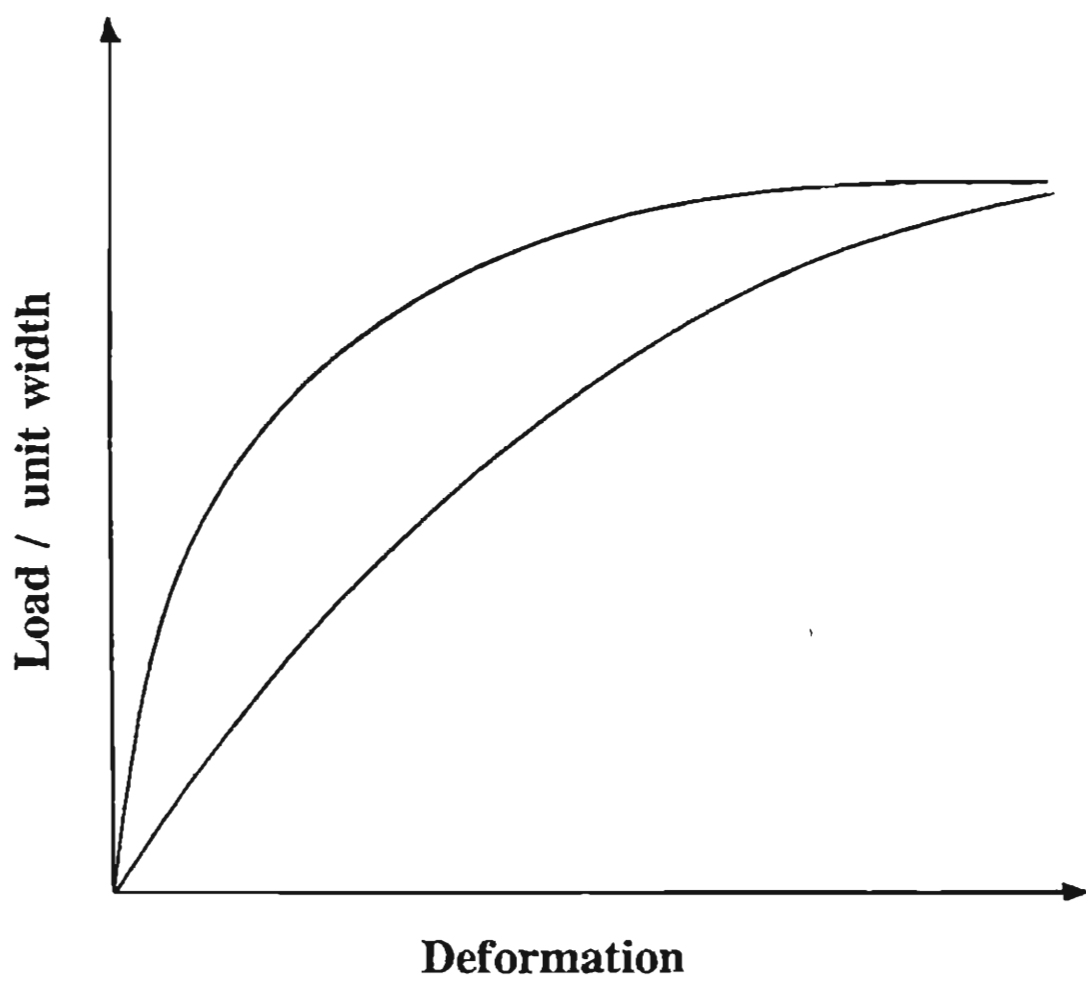

Figure 2.13 Schematic Load-Deformation Curves of Two Geosynthetics with Comparable Ultimate Strength

many GRS walls constructed to date has indicated that many on-site soil can be used satisfactorily as backfill for GRS walls provided that adequate precautions are taken.

2.3 Service-Load Design Methods

Wall deformation is of particular importance in the design of GRS walls because: (a) the strains corresponding to the ultimate strength for geosynthetics are very large (well over 100% for more extensible geosynthetics) and can vary drastically for different geosynthetics; and (b) geosynthetics of similar ultimate strengths can have very different tensile stiffnesses--resulting in different wall deformation under service loads. To alleviate the problem of not being able to determine the wall deformation under service loads, design methods based on service-load condition have been proposed. Giroud (1989) proposed a service-load design method, known as the GeoService method. Christopher, et al. (1989) also proposed a design method for estimating wall deformation. In 1993, the author modified the GeoService method based on findings of instrumented full-scale test walls and finite element analyses. The method is the first design method for GRS wall that allows judicious use of on-site soil as backfill. This is a very important measure as the cost of backfill typically plays a major role in the total cost of a GRS wall (see Figure 2.14). This design method is referred to as the CTI design method, and will be presented in Section 2.3.1.

The design methodology for the service-load methods are similar to that of the earth pressure based ultimate-strength design methods described in Section 2.2.1. Namely, the reinforced soil zone is subjected to an assumed lateral earth pressure distribution, which is

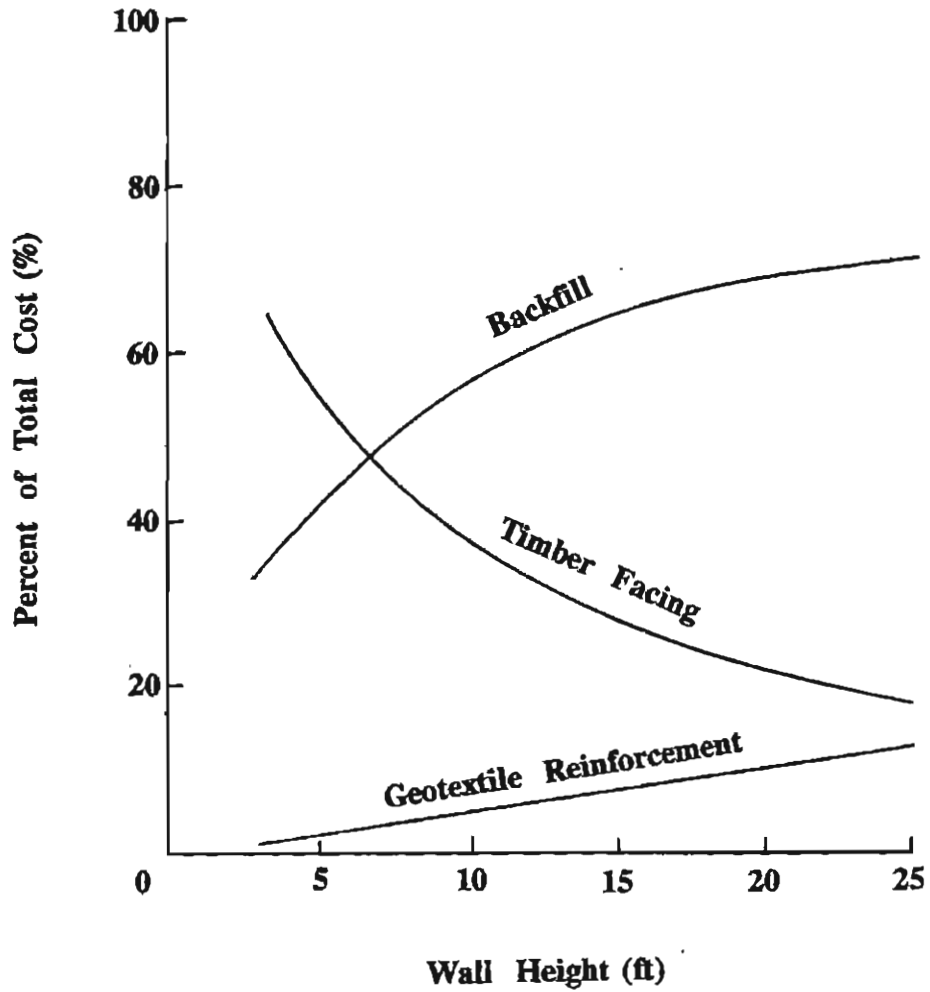

Figure 2.14

Relative Costs of the Components of Geotextile-Reinforced Soil Walls
(Richardson and Bove, 1988)

resisted by the tensile forces induced in the reinforcement. In the service-load design methods, however, a design limit strain of the reinforcement (generally far less than the strain corresponding to the ultimate strength) is selected to impose a performance limit on the wall deformation. The selection of a geosynthetic reinforcement, therefore, is based not only on the ultimate tensile strength requirement, but also on a required tensile resistance at the limit strain.

2.3.1 CTI Design Method - A Service-Load Design Method

In this section, the CTI design method, including the design procedure and an design example, for geosynthetic-reinforced soil retaining walls is presented. The design method was developed based on findings of instrumented full-scale GRS walls and state-of-the-art finite element analyses. The design method employs the service-load design methodology, in which the wall deformation is accounted for in a semi-empirical manner and the selection of reinforcement is calculated based on the "working stress" (stress at the service loads) as well as the ultimate strength of the reinforcement. The conditions (assumptions) of the design method, which should be checked prior to using the design method, are:

- The wall face is vertical or near vertical (more than 80 degrees from the horizontal).
- The wall height does not exceed 20 ft.
- The backfill has less than 20% of fines (i.e., less than 20% of its weight passes the U.S. No.200 sieve), with liquid limit less than 35 and plasticity index not more than 8.

- The backfill is uniform and free draining (or effective drainage is properly provided).
- The crest is horizontal.
- The foundation soil is competent, i.e., the undrained shear strength is greater than $(30 * \text{wall height in feet})$ psf for a clayey foundation, and the standard penetration blow count is at least 8 for a granular foundation.
- The vertical surcharge pressure, q , on the crest is uniformly distributed and its value is less than $0.25\gamma H$ (γ is the moist unit weight of the backfill and H is the height of the wall).
- Seismic loading is not a concern.

This design method has also been implemented in the computer program GREWSON.

2.3.1.1 Design Procedure

Step 1: Establish wall profile and check design assumptions

A wall profile should be established from the grading plan of the wall site. When the project involves variation in wall height along the longitudinal direction, one should choose a proper height interval, say 2 to 3 ft, to allow a gradual change in elevation. An example is depicted in Figure 2.15.

The design assumptions listed in Section 2.3.2 should then be verified. If one or more of the assumptions are not satisfied, the design method should not be used. Levels 2, 3, or 4 of the computerized design tool GREWS (see Section 2.3) are recommended for

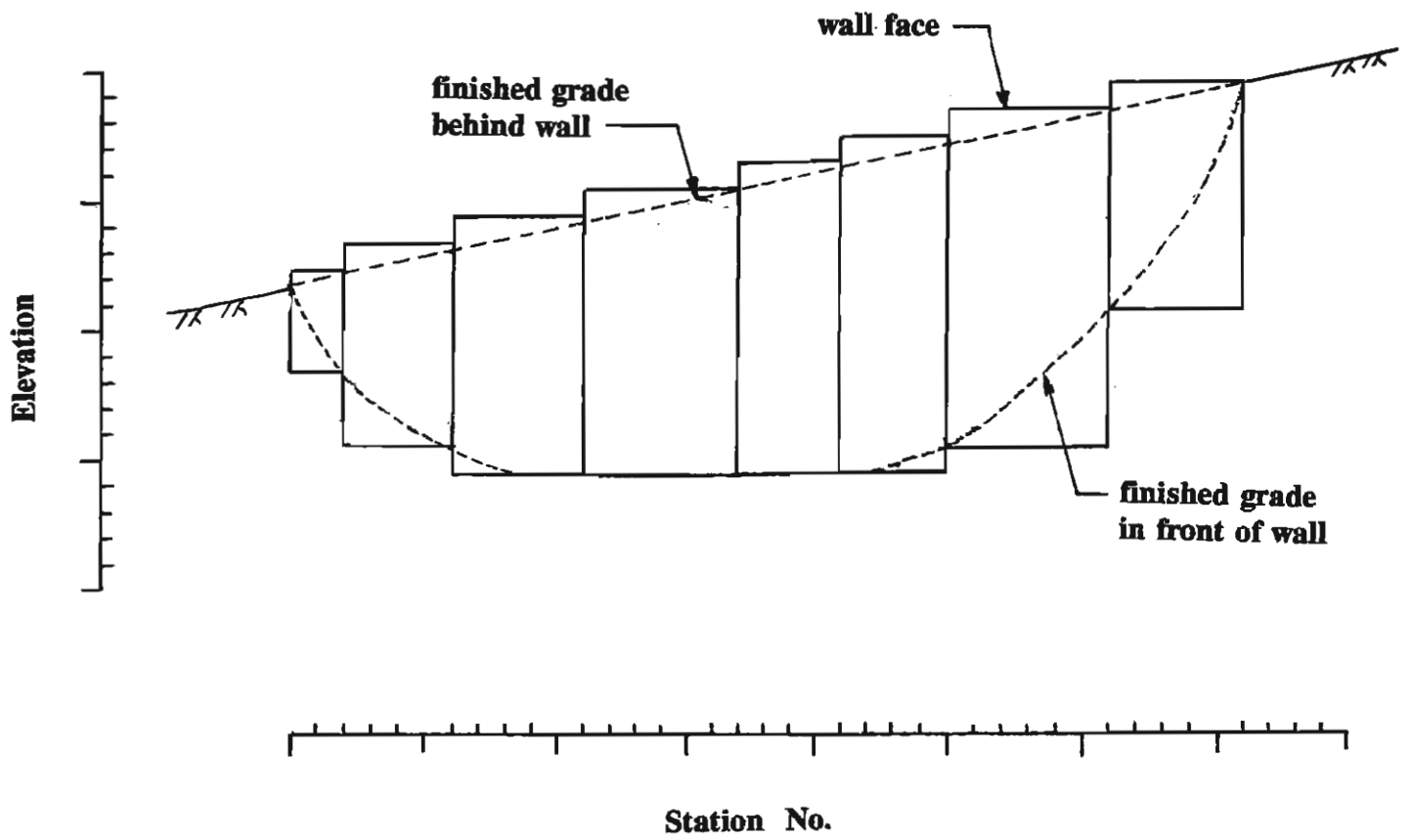

Figure 2.15 A GRS Wall Profile

these cases.

Step 2: Determine soil parameters

The soil parameters needed for design include:

- moist unit weight of the backfill (γ)
- moist unit weight of the foundation. (γ_f)
- c and ϕ (from Mohr-Coulomb failure envelope determined at peak strains) of the backfill
- c_f and ϕ_f (from Mohr-Coulomb failure envelope determined at peak strains) of the foundation (for a purely cohesive foundation: $\phi_f = 0$, and c_f is the undrained shear strength of the foundation soil; for a granular foundation: $c_f = 0$, and ϕ_f can be estimated from the standard penetration blow count.

Step 3: Calculate K_a for the retained earth

The coefficient of Rankine active earth pressure for the retained earth (i.e., the soil behind the reinforced zone), under the conditions of a horizontal crest and $c = 0$, is calculated as:

$$K_a = \tan^2 \left(45^\circ - \frac{\phi}{2} \right)$$

Step 4: Determine a tentative reinforcement length

A tentative reinforcement length can be determined based on the consideration of three potential failure modes: (a) external sliding failure, (b) foundation bearing failure, and (c) anchorage failure. If all the reinforcement layers are to have the same length, the

reinforcement length should be the largest of the lengths obtained from the three potential failure modes.

a) external sliding failure

The required length of reinforcement to resist external sliding at the lowest layer of reinforcement, L_1 , is:

$$L_1 = \frac{F_s H [(\gamma H + 2q) K_a - 4c\sqrt{K_a}]}{2 [\tan\delta (\gamma H + q) + c_a]}$$

in which, δ and c_a are, respectively, the friction angle and the adhesion between the base of the reinforced zone and the foundation soil. If the lowest layer of reinforcement is placed directly on the ground, δ and c_a are the friction angle and the adhesion between geosynthetic reinforcement and foundation soil. The values of δ and c_a can be obtained by performing foundation soil-geosynthetic interface shear tests in a direct shear apparatus. In the absence of direct shear test results, $\delta = (2/3) \phi_f$ and $c_a = c_f$ are generally assumed. If a layer of backfill material (a minimum thickness of 4 in.) is placed on the ground surface before laying the first layer of geosynthetic reinforcement, $\delta = 2/3 \phi$ and $c_a = c$ are commonly assumed. The recommended minimum F_s for external sliding failure is 1.5.

b) foundation bearing failure

The required length of reinforcement to resist foundation bearing failure of the reinforced zone, L_2 , can be determined by the following two equations:

$$F_s = \frac{0.5 \gamma (L_2 - 2e)^2 N_\gamma + c_f N_c (L_2 - 2e)}{(\gamma H + q) L_2}$$

$$e = \frac{(3qK_a + \gamma HK_a - 6c\sqrt{K_a}) H^2}{6 L_2 (q + \gamma H)}$$

The value of L_2 can be determined by solving the above two equations in an iterative procedure, or simply substituting the second equation into the first equation. The safety factor against foundation failure, F_s , should be at least 2.0 (noted that the side shear in the reinforced zone is ignored in the computations). The values of the bearing capacity factors, N_γ and N_c , are given as a function of the foundation friction angle (ϕ_f) in Figure 2.16. It should be noted that for a cohesive foundation, $N_\gamma = 0$ and $N_c = 5.14$.

In the above computations, the reinforced zone is assumed to be subjected to a lateral thrust exerted by the retained earth (the side shear resistance between the reinforced zone and the retained earth is ignored for simplicity). Consequently, the resultant load on the foundation soil is inclined and eccentric. After the values of L_2 and e are determined, it should be checked whether the length L_2 is at least 6 times the eccentricity e to prevent excessive stresses being developed beneath the wall face. This can be expressed by the following equation:

$$L_2 \geq 6 e$$

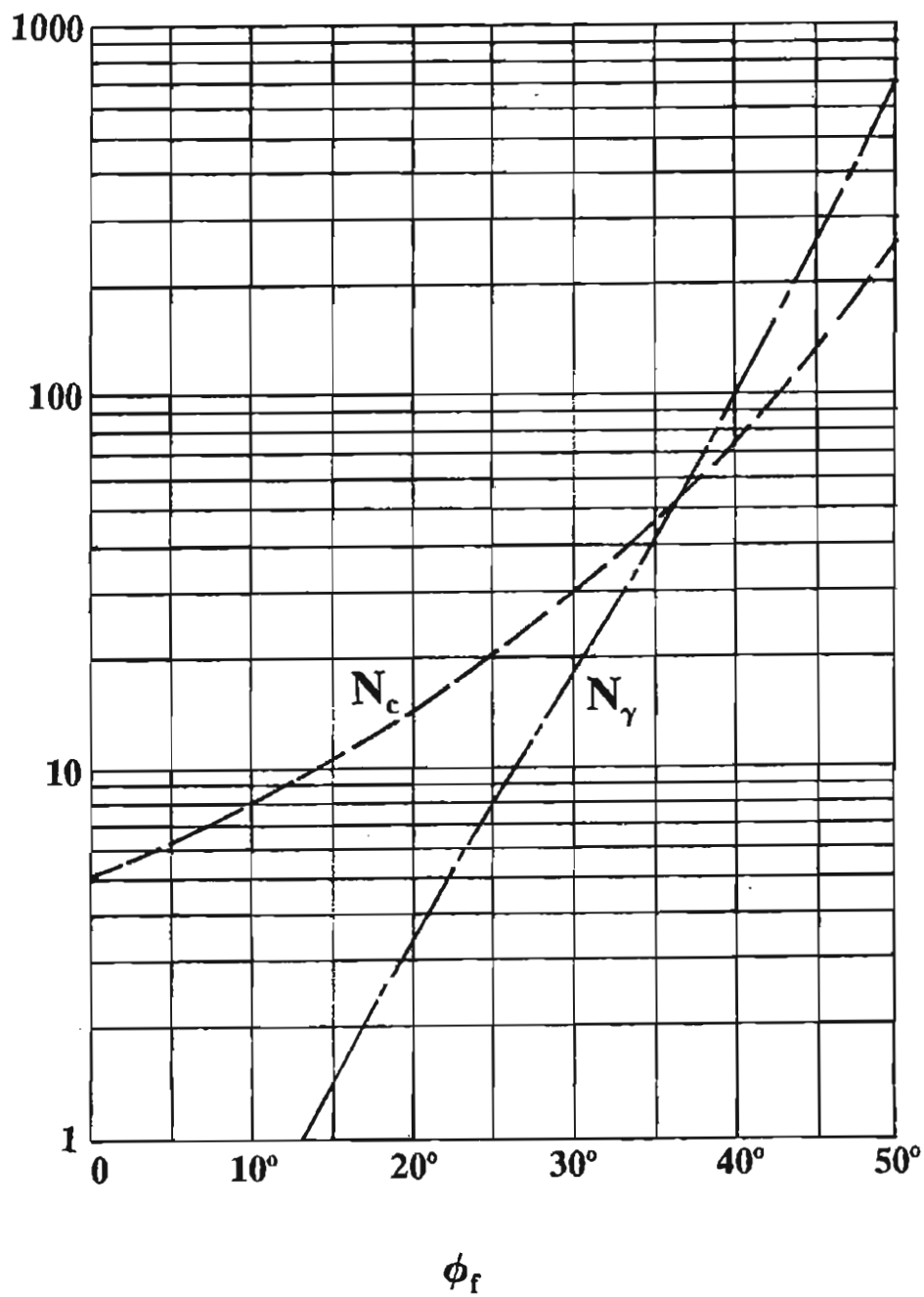

Figure 2.16 Bearing Capacity Factors, N_γ and N_c (Terzaghi and Peck, 1967)

If L_2 is less than $6e$, L_2 should be set equal to $6e$.

(c) anchorage failure

To provide adequate anchorage for the potential failure mass, the length of reinforcement must be at least 3 ft beyond the extent of the active Rankine failure surface, which assumes an angle of $45^\circ + \phi/2$ from the heel. The required length of reinforcement to resist anchorage failure, L_3 , is:

$$L_3 \text{ (ft)} = H \tan\left(45^\circ - \frac{\phi}{2}\right) + 3$$

A tentative reinforcement length L_1 can then be determined as the maximum value of L_1 , L_2 , and L_3 . The final decision on the reinforcement length will be made after checking the safety margin against pullout failure (Step 11).

Step 5: Select vertical spacing between reinforcement layers

For wall height less than 12 ft, a uniform vertical spacing of 1 ft is generally selected for all reinforcement layers. However, varying the vertical spacing may be economical for higher walls (height greater than 15 ft) or walls that have large wall face area. In those cases, one may choose two or more spacings. A smaller spacing is generally selected for reinforcement in lower layers than in upper layers.

Step 6: Calculate the maximum horizontal stresses in the reinforcement

The maximum horizontal stress in the reinforcement at depth z (measured from the crest) can be calculated by the following equation:

$$\sigma_{h(\max)} = K_a (\gamma z + q) - 2 c \sqrt{K_a}$$

The maximum horizontal stresses $\sigma_{h(\max)}$ should be calculated at each layer of the reinforcement.

Step 7: Determine the maximum tensile force in the reinforcement

The maximum tensile force in the reinforcement, T_{\max} , can be determined by:

$$T_{\max} = \sigma_{h(\max)} s$$

in which, s is the vertical spacing of reinforcement layers. The maximum tensile force should be calculated for each selected vertical spacing. For a wall with uniform vertical spacing and reinforcement length for all layers, $\sigma_{h(\max)}$ at the lowest reinforcement layer (i.e., depth z_1 in Figure 2.17(a)) should be used for calculating T_{\max} . For a wall with more than one vertical spacing, T_{\max} should be calculated at the lowest reinforcement layer of each spacing (e.g., depths z_1 and z_2 in Figure 2.17(b) for a wall with two vertical spacings).

Step 8: Select a design limit strain for the reinforcement

Deformation (strains) in the geosynthetic reinforcement generally accounts for a major part of wall deformation. For most cases, one should select a design limit strain of 1% to 3% for the reinforcement. For temporary walls, one may select a design limit strain as high as 10%. If a small limit strain (1% to 3%) is selected, a stiff geosynthetic such as a high-modulus geogrid or woven geotextile is generally needed. On the other hand, if a large limit strain is selected, a wide range of geosynthetics, including nonwoven geotextiles, may be chosen.

(a) A Wall with Uniform Spacing

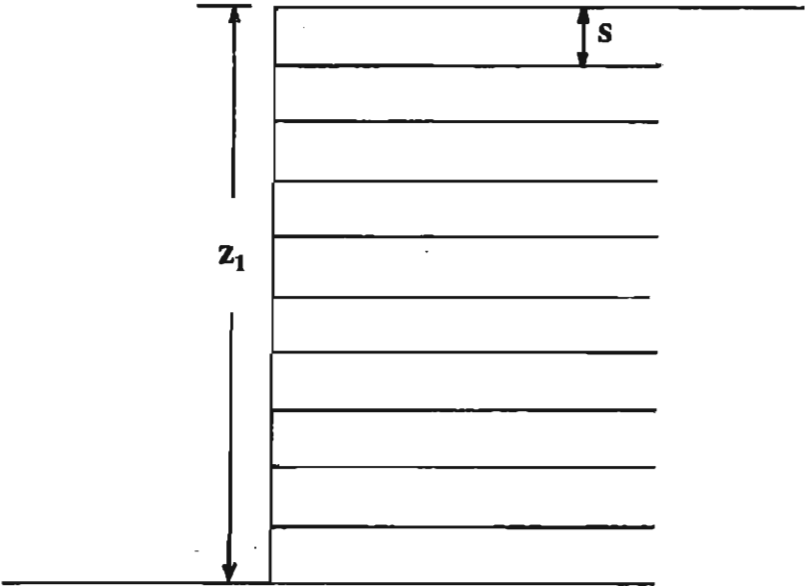

(b) A Wall with Two Spacings

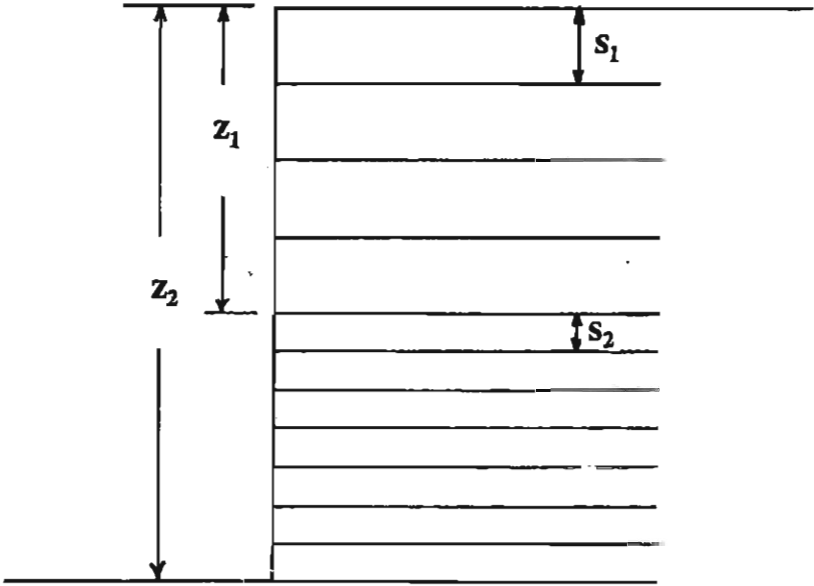

Figure 2.17 Depths at which the Maximum Tensile Forces are to be Computed

Step 9: Estimate the maximum lateral displacement of the wall

The maximum lateral displacement of the wall, Δ_{\max} , can be estimated by the following semi-empirical equation:

$$\Delta_{\max} = \epsilon_d \left(\frac{H}{1.25} \right)$$

in which, ϵ_d is the design limit strain selected in Step 8, and H is the wall height.

If the maximum wall displacement exceeds the performance limit, a smaller design limit strain than that selected in Step 8 should be used such that the maximum lateral displacement of the wall will satisfy the performance requirement.

Strictly speaking, the above equation applies only to the USFS wrapped-faced wall. The CTI timber-faced wall and modular block GRS walls, under otherwise identical conditions, will experience a smaller lateral wall displacement (typically about 15% smaller) than that calculated by the equation.

Step 10: Select a geosynthetic

A geosynthetic should be selected such that its tensile stress at the limit strain (determined in Step 8 or 9) be greater than the maximum tensile force calculated in Step 7 for each selected vertical reinforcement spacing. This condition can be expressed as:

$$T(@ \text{ design limit strain}) \geq F_s T_{\max}$$

The safety factor F_s in the above equation is needed to avoid excessive creep deformation *when a backfill with an appreciable amount of fines is employed*. The following values of F_s are recommended:

- For fines content $\leq 12\%$, and plasticity index ≤ 4 ,
 $F_s = 1.5$ for all geosynthetics
- For fines content $\geq 13\%$, and plasticity index ≥ 6 ,
 $F_s = 3.0$ for polypropylene geosynthetics
 $F_s = 2.4$ for polyethylene geosynthetics
 $F_s = 2.0$ for polyester geosynthetics
- For soils not meeting either of the above requirements,
 $F_s = 2.5$ for polypropylene geosynthetics
 $F_s = 2.0$ for polyethylene geosynthetics
 $F_s = 1.7$ for polyester geosynthetics

In addition, the ultimate strength of the reinforcement should be at least 3 times the stress at the limit strain to provide adequate ductility, i.e.,

$$T_{ub} \geq 3 T(@ \text{ design limit strain})$$

It is to be noted that alternate selections of geosynthetic can be made by choosing a different vertical spacing in Step 5.

The tensile properties (i.e., load/unit width versus deformation curve) of the geosynthetic should be determined in a wide-width tensile test (ASTM D 4595). For confining pressure sensitive geosynthetics (e.g., needle-punched nonwoven geotextiles), the intrinsic confined test proposed by Wu and his associates (Wu, 1991; Ling, Wu and Tatsuoka, 1992; Ballegeer and Wu, 1993) is recommended. The increase in stiffness due to pressure confinement is generally much more pronounced than the increase in ultimate

strength. For nonwoven needle-punched geotextiles, the increase in stiffness (secant modulus) can be as high as 100% under a confining pressure of 12 psi, whereas the corresponding increase in ultimate strength is only about 30%.

Step 11: Check the stability against pullout failure

The safety factor against pullout failure for a reinforcement layer located at depth z can be determined by the following equation:

$$F_s = \frac{2 \tan \delta (\gamma z + q) [L_t - (H - z) \tan(45^\circ - \frac{\phi}{2})]}{\sigma_{h(\max)} S}$$

in which, L_t is the tentative reinforcement length obtained from Step 4, $\sigma_{h(\max)}$ is the maximum horizontal stress obtained from Step 6, δ is the angle of friction at soil-geosynthetic interface. The coefficient of interface friction, $\tan \delta$, can be determined from the results of a pullout test as (Sobhi and Wu, 1994):

$$\tan \delta = \frac{E t \ln(\frac{F}{E t} + 1)}{2 \sigma_n L}$$

where, F = applied pullout force at failure (per unit width of reinforcement); L = total length of the reinforcement specimen; E = inherent confined Young's Modulus per unit width of reinforcement; t = thickness of reinforcement; σ_n = normal stress (overburden) on reinforcement specimen. In the absence of pullout test results, the angle δ is generally assumed as 2/3 of the friction angle of the backfill, i.e., $\delta = (2/3)\phi$.

The safety factor should be calculated at every reinforcement layer. If the values of F_s at all depths of reinforcement are no less than 1.5, the design reinforcement length $L =$

L_1 . On the other hand, if the value of F_s at any depth is less than 1.5, L_1 should be increased until all F_s are greater than or equal to 1.5.

For simplicity, the same reinforcement length is generally used for all layers. However, a trapezoidal (or truncated) reinforcement configuration, with the shortest reinforcement at the bottom, as shown in Figure 2.18, can also be used. Such a configuration is especially economical when excavation of the retained soil is involved in the construction of the wall. To prevent external sliding failure, the length of the lowest reinforcement layer should be no less than L_1 determined from Equation (2) or 4 ft, whichever is larger. The minimum required length of reinforcement at depth z below the crest can be calculated by assigning $F_s = 1.5$ in the following equation:

$$L_{req} = \frac{F_s \sigma_{h(max)} s}{2 \tan \delta (\gamma z + q)} + (H - z) \tan(45^\circ - \frac{\phi}{2})$$

It is to be noted that in the case of the USFS wrapped-faced geotextile-reinforced soil retaining walls, the wrapped portion of reinforcement should be at least 3-ft long to prevent pullout failure at the wall face. For the timber-faced wall, the tail length (folded length) on the final layer should be greater than 8 ft.

Step 12: Check overall rotational slide-out failure

After the reinforcement length is selected, rotational slide-out failure encompassing the entire reinforced soil mass should be analyzed. This can be accomplished by using a reliable slope stability computer program such as STABL. The factor of safety should be at least 1.3. Otherwise, the reinforcement length should be increased to provide an

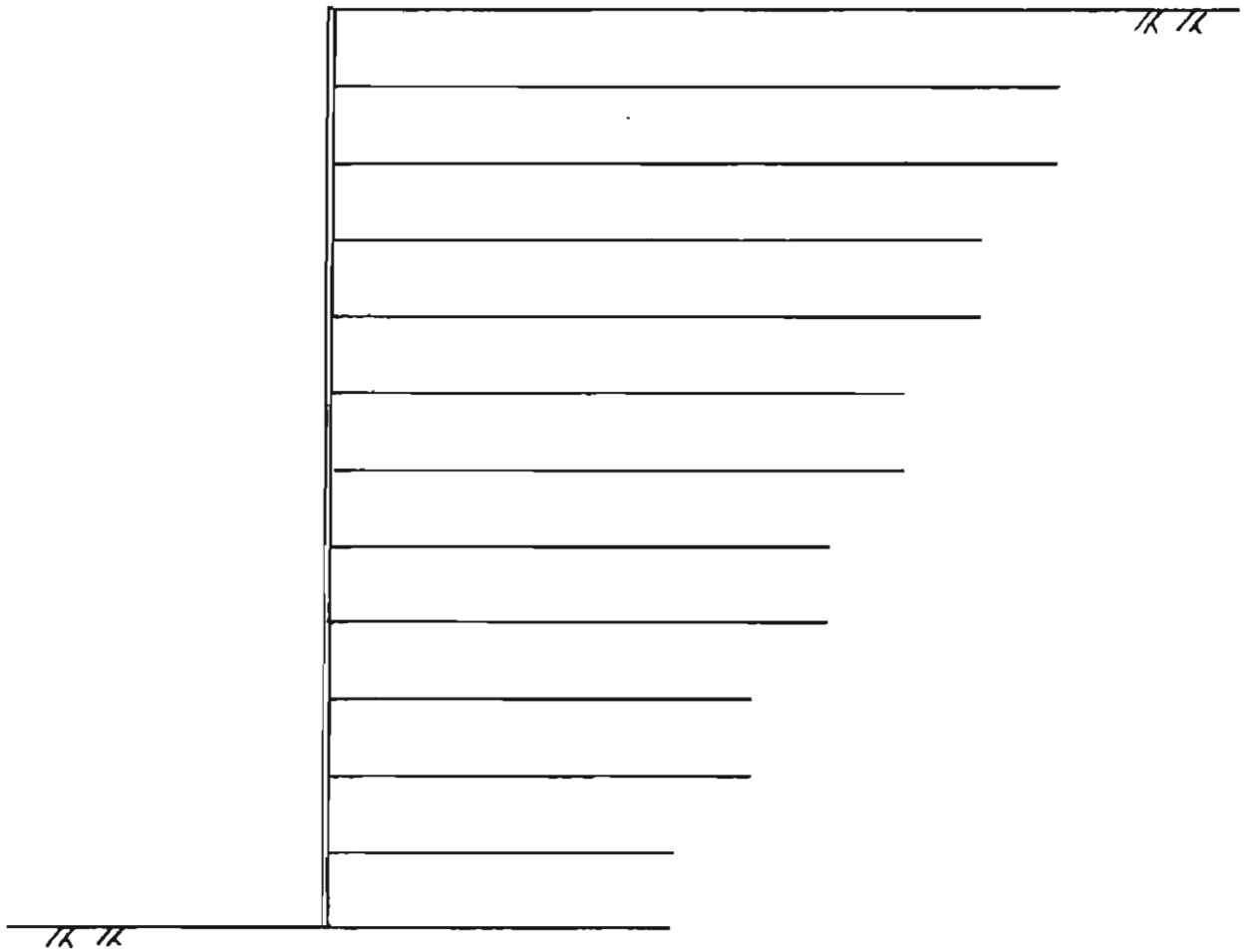

Figure 2.18 A Trapezoidal (Truncated) Reinforcement Configuration

adequate safety margin.

2.3.1.2 Design Example

Given Conditions

The cross-section of a CTI timber-faced geosynthetic-reinforced soil retaining wall is shown in Figure 2.19.

Characteristics of the wall:

- uniform wall height: $H = 15$ ft
- vertical wall
- all geosynthetic reinforcement layers are to have the same length
- no embedment (wall constructed directly on the ground)

Characteristics of the backfill and retained earth:

- The same soil is to be used for the backfill and retained earth (the earth behind the reinforced zone), and the density and moisture in the backfill and retained earth are similar.
- the soil is a silty sand with 12% (by weight) of fines, liquid limit = 18, plasticity index = 3, moist unit weight $\gamma = 120$ pcf, $c = 100$ psf and $\phi = 33^\circ$ (at peak strain)
- surface and subsurface drainage is properly provided

Characteristics of the foundation soil:

- the soil is uniform up to 35 ft below ground surface, and moist unit weight $\gamma_f = 120$ pcf; $c_f = 200$ psf, $\phi_f = 30^\circ$

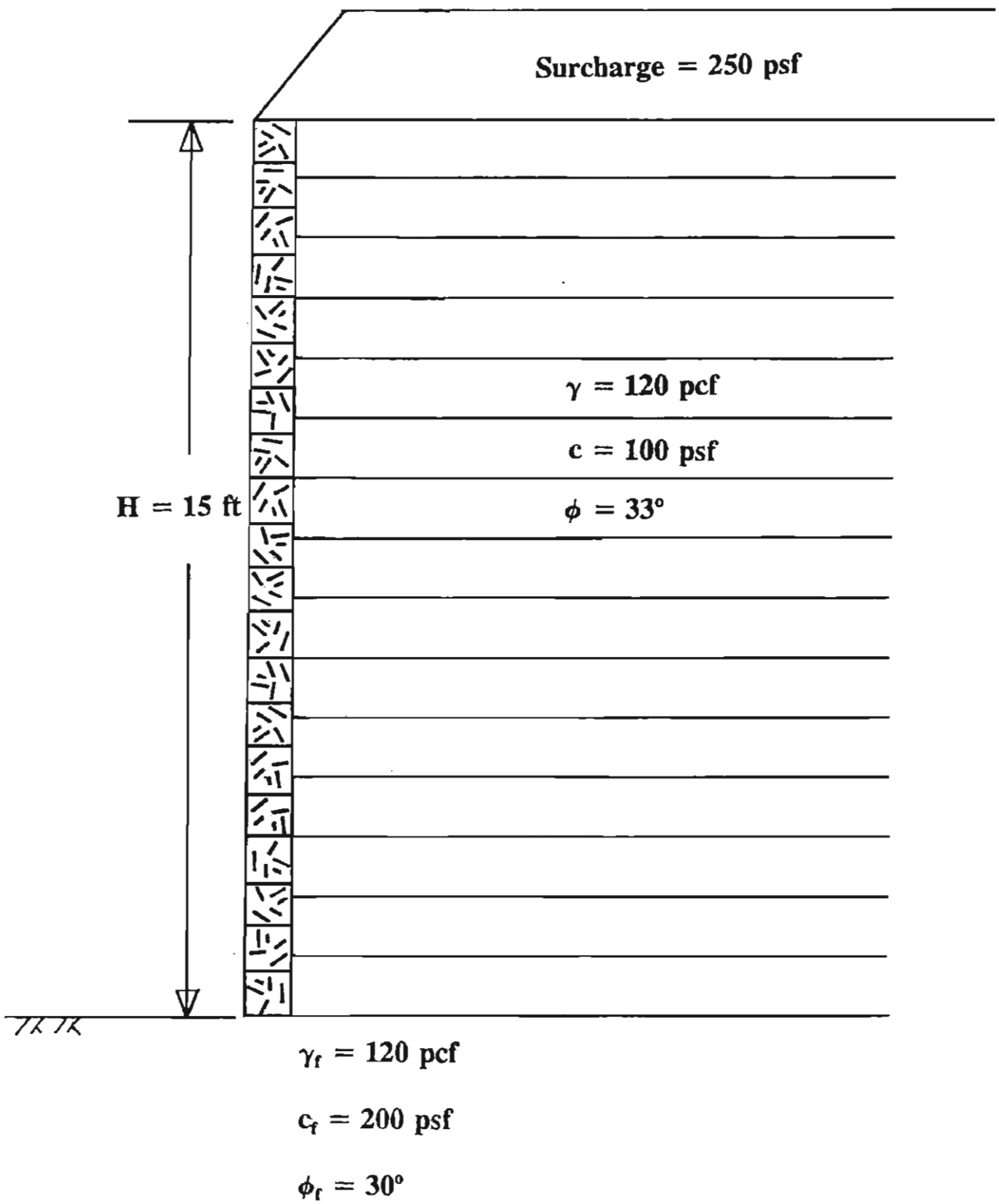

Figure 2.19 Cross-Section of a GRS Wall - Design Example for the CTI Method

- deep water table

Characteristics of the loading:

- vertical surcharge uniformly distributed over the crest, $q = 250$ psf
- no concern of seismic loading

Performance limit:

- maximum allowable lateral movement of the wall is 2% of the wall height, i.e., $\Delta_{\max} = (15 \text{ ft} * 12 \text{ in./ft}) (2\%) = 3.6 \text{ in.}$

Design Computations:

Step 1: Establish wall profile and check design assumptions

The cross section of the wall is as depicted in Figure 2.19. The design assumptions listed in Section 2.2 are verified, including wall height = 15 ft < 20 ft, fines content of backfill = 12% < 20%, liquid limit = 18 < 35, plasticity index = 3 < 8, surcharge pressure $q = 250$ psf < $0.25\gamma H = 0.25(120)(15) = 450$ psf.

Step 2: Determine soil parameters

The values of the soil parameters are:

$$\gamma = 120 \text{ pcf}; \quad \gamma_f = 120 \text{ pcf}$$

$$c = 100 \text{ psf}; \quad \phi = 33^\circ; \quad c_f = 200 \text{ psf}; \quad \phi_f = 30^\circ$$

Step 3: Calculate K_a

The active Rankine earth pressure coefficient of the retained earth is

$$K_a = \tan^2 (45^\circ - 33^\circ/2) = 0.29$$

Step 4: Determine a tentative reinforcement length

Three tentative reinforcement lengths with respect to (a) external sliding failure (L_1), (b) foundation bearing failure (L_2), and (c) anchorage failure (L_3) are first determined:

(a) Determination of L_1

$$\begin{aligned} L_1 &= \frac{F_s H [(\gamma H + 2q) K_a - 4c\sqrt{K_a}]}{2 \tan \delta (\gamma H + q)} \\ &= \frac{(1.5)(15)[(120 \cdot 15 + 2 \cdot 250) (0.29) - 4(100)\sqrt{0.29}]}{2 \tan\left[\left(\frac{2}{3}\right)33^\circ\right] (120 \cdot 15 + 250)} \\ &= 6.1 \text{ (ft)} \end{aligned}$$

(b) Determination of L_2

From Figure 2.16, $N_c = 30$, $N_\gamma = 19$ for $\phi_f = 30^\circ$; thus,

$$\begin{aligned} F_s &= \frac{0.5 \gamma (L_2 - 2e)^2 N_\gamma + c_f N_c (L_2 - 2e)}{(\gamma H + q) L_2} \\ 2.0 &= \frac{0.5 \cdot 120 \cdot 19 \cdot (L_2 - 2e)^2 + 200 \cdot 30 \cdot (L_2 - 2e)}{(120 \cdot 15 + 250) L_2} \end{aligned}$$

and,

$$\begin{aligned} e &= \frac{(3qK_a + \gamma HK_a - 6c\sqrt{K_a}) H^2}{6 L_2 (q + \gamma H)} \\ &= \frac{(3 \cdot 250 \cdot 0.29 + 120 \cdot 15 \cdot 0.29 - 6 \cdot 100 \cdot \sqrt{0.29}) (15)^2}{6 * L_2 * (250 + 120 \cdot 15)} \\ &= \frac{7.62}{L_2} \end{aligned}$$

Substituting e into the equation for F_s yields:

$$L_2 = 5.3 \text{ (ft)}$$

$$e = 1.4 \text{ (ft)}$$

Since $L_2 < 6 e$,

$$L_2 = 6 e = 8.4 \text{ (ft)}$$

(c) Determination of L_3

$$\begin{aligned} L_3 &= H \tan\left(45^\circ - \frac{\phi}{2}\right) + 3 \\ &= 15 * \tan\left(45^\circ - \frac{33^\circ}{2}\right) + 3 \\ &= 11.1 \text{ (ft)} \end{aligned}$$

The tentative reinforcement length, L_t , is the largest value of L_1 , L_2 , and L_3 ; i.e.,

$$L_t = 11.1 \text{ ft (use } L_t = 11.5 \text{ ft for design)}$$

Step 5: Select vertical spacing between reinforcement layers

For simplicity, a uniform vertical spacing of 1 ft between all reinforcement layers can be selected. For the purpose of illustration, however, a constant vertical spacing of 0.75 ft will be selected for the lower half of the wall and 1.5 ft for the upper half of the wall (i.e., $s_1 = 1.5$ ft and $s_2 = 0.75$ ft in Figure 2.?).

Step 6: Calculate the maximum horizontal stresses in the reinforcement

The maximum horizontal stresses in the reinforcement at each reinforcement layer are calculated. The results are shown in Table 2.3.

Step 7: Determine the maximum tensile forces in the reinforcement

The maximum tensile forces at $z = 7.5$ ft and $z = 15$ ft are calculated as:

$$T_{\max} (@ z = 7.5 \text{ ft}) = \sigma_{h(\max)} s = 226 (1.5) = 340 \text{ (lb/ft)}$$

$$T_{\max} (@ z = 15 \text{ ft}) = \sigma_{h(\max)} s = 487 (0.75) = 365 \text{ (lb/ft)}$$

Table 2.3 Horizontal stresses in the reinforcement and safety factors against pullout failure

Depth (ft)	$\sigma_{h(max)}$ (psf)	Fs (pullout failure)
1.5	17	56.9
3.0	69	23.8
4.5	121	20.4
6.0	174	19.9
7.5	226	20.4
8.25	252	41.6
9.0	278	42.5
9.75	304	43.6
10.5	330	44.7
11.25	356	45.9
12.0	382	47.1
12.75	408	48.3
13.5	435	49.5
14.25	461	50.8
15.0	487	52.2

Step 8: Select a design limit strain for the reinforcement

A design limit strain of 3% in the reinforcement is selected for the design of the wall.

Step 9: Estimate the maximum lateral displacement of the wall

With the design limit strain of 3%, ignoring the reduction in the displacement due to the rigidity of the timber facing, the maximum lateral movement of the wall is estimated as:

$$\Delta_{\max} = (3\%) (15/1.25) = 0.36 \text{ (ft)} = 4.3 \text{ (in.)}$$

The maximum lateral movement is greater than the maximum allowable lateral movement of 3.6 in., the design limit strain of reinforcement is then changed to 2.5%. The corresponding maximum lateral wall movement becomes:

$$\Delta_{\max} = (2.5\%) (15/1.25) = 0.3 \text{ (ft)} = 3.6 \text{ (in.) (o.k.)}$$

Step 10: Select the geosynthetic

The backfill has 12% of fines, thus, the geosynthetic selected must have the following properties in the transverse direction of the wall:

$$(a) \quad T (@ \text{ design limit strain of } 2.5\%) \geq F_s * T_{\max}$$

Since fines content = 12% and plasticity index = 3, $F_s = 1.5$; thus,

$$T(@\epsilon=2.5\%) \geq (1.5)(340) = 510 \text{ (lb/ft)} \quad (\text{for upper 7.5 ft})$$

$$T(@\epsilon=2.5\%) \geq (1.5)(365) = 550 \text{ (lb/ft)} \quad (\text{for lower 7.5 ft})$$

$$(b) \quad T_{\text{ult}} \geq 3 * T(@\epsilon=2.5\%)$$

$$T_{\text{ult}} \geq 3 (510) = 1,530 \text{ (lb/ft)} \quad (\text{for upper 7.5 ft})$$

$$T_{\text{ult}} \geq 3 (550) = 1,650 \text{ (lb/ft)} \quad (\text{for lower 7.5 ft})$$

Step 11: Check the stability against pullout failure

The safety factors at all depths of reinforcement are calculated and listed in Table 2.3. In the absence of pullout test results, the soil-geosynthetic interface friction angle δ is taken as $(2/3)\phi$, i.e., $\delta = 22^\circ$. The safety factor against pullout failure are well above a minimum of 1.5 at all reinforcement layers.

Step 12: Check overall rotational slide-out failure

The overall rotational slide-out failure is checked by a slope stability computer program. The factor of safety is greater than 1.3.

Design Summary (for reinforcement):

length (uniform st all depths) = 11.5 ft

vertical spacings:

$s = 1.5$ ft for the upper 7.5 ft of wall

$s = 0.75$ ft for the lower 7.5 ft of wall

$T(@\epsilon=2.5\%) \geq 510$ lb/ft (for upper 7.5 ft)

$T(@\epsilon=2.5\%) \geq 550$ lb/ft (for lower 7.5 ft)

$T_{ult} \geq 1,530$ (lb/ft) (for upper 7.5 ft)

$T_{ult} \geq 1,650$ (lb/ft) (for lower 7.5 ft)

2.3.2 Simplified CTI Design Method

A simplified CTI method, which is a simplified version of the CTI design method described in Section 2.3.2, is presented in this Section. The simplified design method can

be used when the wall height is not greater than 15 ft, the foundation is firm, the backfill is granular, and a "quick" design is desired and warranted.

2.3.2.1 Design Procedure

Step 1: Establish wall profile and check design assumptions

The design assumptions are than same as those for the CTI design method (see Section 2.3.1), expect that:

- wall height should be no more than 15 ft
- backfill should be granular
- foundation should be firm

Step 2: Determine the moist unit weight γ and angle of internal friction ϕ of the backfill

The angle of internal friction, ϕ , can be estimated or determined by appropriate direct shear or triaxial tests. The moist unit weight, γ , can be determined in a moist density test. Generally, a unit weight of 95% AASHTO T-99 maximum density is specified. However, other densities are also allowed provided that the angle ϕ is consistent with that density.

Step 3: Determine the reinforcement length

The reinforcement length, L , is:

$$L = \left[\tan\left(45^\circ - \frac{\phi}{2}\right) + 0.2 \right] H$$

Step 4: Calculate the maximum tensile force in the reinforcement

The maximum tensile force in the reinforcement, T_{\max} , is calculated as:

$$T_{\max} = s (\gamma H + q) \tan^2(45^\circ - \frac{\phi}{2})$$

in which, s = vertical spacing between reinforcement layers, and H = wall height. For wall height not greater than 12 ft, a uniform spacing of 1 ft is generally selected for all reinforcement layers.

Step 5: Determine a design limit strain for the reinforcement

The design limit strain, ϵ_d , can be determined as:

$$\epsilon_d = 1.25 \left(\frac{\Delta_{\max}}{H} \right)$$

in which, Δ_{\max} is the maximum allowable lateral displacement of the wall, and H is the wall height.

Step 6: Select a geosynthetic

A geosynthetic reinforcement can be selected such that:

$$T(@ \text{ design limit strain}) \geq F_s T_{\max}$$

and

$$T_{ult} \geq 3 T(@ \text{ design limit strain})$$

in which, the factor of safety, F_s , should be at least 1.5.

2.3.2.2 Design Example

Given Conditions

The cross-section of a CTI timber-faced geosynthetic-reinforced soil retaining wall is shown in Figure 2.20.

Characteristics of the wall:

- uniform wall height: $H = 12$ ft
- vertical wall
- all geosynthetic reinforcement layers are to have the same length
- no embedment (wall constructed directly on the ground)

Characteristics of the backfill and retained earth:

- The same soil is to be used for the backfill and retained earth (the earth behind the reinforced zone), and the density and moisture in the backfill and retained earth are similar.
- the soil is a sandy gravel, with moist unit weight $\gamma = 115$ pcf, $c = 0$, and $\phi = 35^\circ$ at 95% AASHTO T-99 maximum density.
- surface and subsurface drainage are properly provided

Characteristics of the foundation soil:

- the standard penetration blow count is 40 uniform to 35 ft below ground surface
- deep water table

Characteristics of the loading:

- vertical surcharge uniformly distributed over the crest, $q = 250$ psf
- no concern of seismic loading

Performance limit:

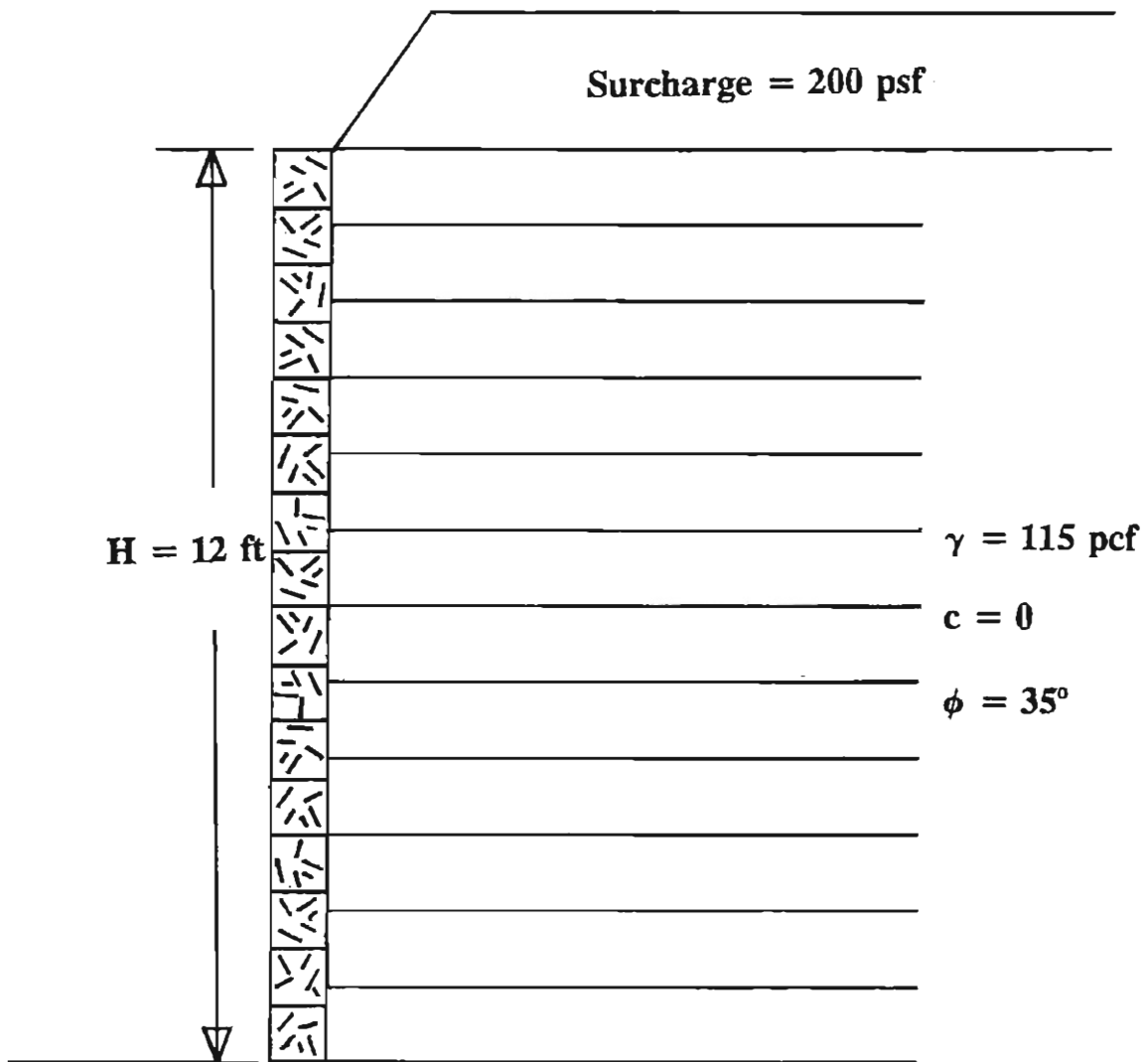

Figure 2.20 Cross-Section of a GRS Wall - Design Example for the Simplified CTI Method

- maximum allowable lateral movement of the wall is 3% of the wall height, i.e., $\Delta_{\max} = (12 \text{ ft} * 12 \text{ in./ft}) (3\%) = 4.3 \text{ in.}$

Design Computations:

Step 1: Establish wall profile and check design assumptions

The cross section of the wall is as depicted in Figure 2.20. The design assumptions are verified, including wall height < 15 ft, granular backfill and a firm foundation.

Step 2: Determine γ and ϕ of the backfill

At 95% AASHTO T-99 maximum density, $\gamma = 115 \text{ pcf}$ and $\phi = 35^\circ$.

Step 3: Determine the reinforcement length

$$L = [\tan (45^\circ - 35^\circ/2) + 0.2] 12 = 8.6 \text{ ft}$$

Step 4: Calculate the maximum tensile force

$$T_{\max} = (1) (115 * 12 + 250) \tan^2(45^\circ - 35^\circ/2) = 442 \text{ (lb/ft)}$$

Step 5: Determine the design limit strain

$$\epsilon_d = 1.25 (4.3/12)/12 = 3.75\%$$

Step 6: Select geosynthetic

The geosynthetic selected must have the following tensile properties:

$$T (@ 3.75\% \text{ strain}) \geq 1.5 (442) = 660 \text{ (lb/ft)}$$

$$T_{\text{ult}} \geq 3 (660) = 1,980 \text{ (lb/ft)}$$

2.3.2.3 Design Charts

The design charts shown in Table 2.4 are based on the simplified CTI design method described in Section 2.3.2.1. The design charts can be used when the wall height is not

Table 2.4(a) Design Charts based on the Simplified CTI Method for Wall Height, H = 8 ft

Wall Height, H = 8 ft

Friction Angle of Backfill, ϕ (degree)		30°	32°	34°	36°	38°	40°	42°
Reinforcement Length, L (ft)		6.2	6.0	5.9	5.7	5.5	5.3	5.2
T_{ed} (lb/ft)	s = 8"	380	350	320	290	270	250	220
	s = 12"	570	520	480	440	400	370	340
	s = 16"	750	690	640	590	540	490	450
T_{ult} (lb/ft)	s = 8"	1130	1040	960	880	810	740	670
	s = 12"	1700	1560	1440	1320	1210	1110	1010
	s = 16"	2260	2090	1920	1760	1610	1470	1340

Note:

1. Design limit strain, $\epsilon_d = (1.3 * \Delta_{max})\%$, where Δ_{max} is the maximum allowable lateral wall movement (in inches)
2. T_{ed} : required force/width of geosynthetic reinforcement at design limit strain (ϵ_d)
3. T_{ult} : minimum required ultimate strength of geosynthetic reinforcement
4. s : vertical spacing of reinforcement
5. Surcharge pressure = 250 psf (increase T_{ed} and T_{ult} each by 22 % for every additional 250 psf surcharge pressure)

Table 2.4(b) Design Charts based on the Simplified CTI Method for Wall Height, H = 10 ft

Wall Height, H = 10 ft

Friction Angle of Backfill, ϕ (degree)		30°	32°	34°	36°	38°	40°	42°
Reinforcement Length, L (ft)		7.8	7.5	7.3	7.1	6.9	6.7	6.5
T_{ed} (lb/ft)	s = 8"	450	420	380	350	320	290	270
	s = 12"	680	620	570	530	480	440	400
	s = 16"	900	830	760	700	640	590	540
T_{ult} (lb/ft)	s = 8"	1350	1240	1150	1050	960	880	800
	s = 12"	2030	1870	1720	1580	1450	1320	1200
	s = 16"	2700	2490	2290	2100	1930	1760	1610

Note:

1. Design limit strain, $\epsilon_d = (1.05 * \Delta_{max})\%$, where Δ_{max} is the maximum allowable lateral wall movement (in inches)
2. T_{ed} : required force/width of geosynthetic reinforcement at design limit strain (ϵ_d)
3. T_{ult} : minimum required ultimate strength of geosynthetic reinforcement
4. s : vertical spacing of reinforcement
5. Surcharge pressure = 250 psf (increase T_{ed} and T_{ult} each by 18 % for every additional 250 psf surcharge pressure)

Table 2.4(c) Design Charts based on the Simplified CTI Method for Wall Height, H = 12 ft

Wall Height, H = 12 ft

Friction Angle of Backfill, ϕ (degree)		30°	32°	34°	36°	38°	40°	42°
Reinforcement Length, L (ft)		9.3	9.1	8.8	8.5	8.3	8.0	7.7
T_{ed} (lb/ft)	s = 8"	520	480	440	410	370	340	310
	s = 12"	790	720	670	610	560	510	470
	s = 16"	1050	970	890	820	750	680	620
T_{ult} (lb/ft)	s = 8"	1570	1480	1330	1220	1120	1020	930
	s = 12"	2360	2170	2000	1830	1680	1540	1400
	s = 16"	3140	2890	2660	2450	2240	2050	1870

Note:

1. Design limit strain, $\epsilon_d = (0.9 * \Delta_{max})\%$, where Δ_{max} is the maximum allowable lateral wall movement (in inches)
2. T_{ed} : required force/width of geosynthetic reinforcement at design limit strain (ϵ_d)
3. T_{ult} : minimum required ultimate strength of geosynthetic reinforcement
4. s : vertical spacing of reinforcement
5. Surcharge pressure = 250 psf (increase T_{ed} and T_{ult} each by 16 % for every additional 250 psf surcharge pressure)

Table 2.4(d) Design Charts based on the Simplified CTI Method for Wall Height, H = 15 ft

Wall Height, H = 15 ft

Friction Angle of Backfill, ϕ (degree)		30°	32°	34°	36°	38°	40°	42°
Reinforcement Length, L (ft)		11.7	11.3	11.0	10.6	10.3	10.0	9.7
T_{ed} (lb/ft)	s = 8"	630	580	540	490	450	410	380
	s = 12"	950	880	810	740	680	620	570
	s = 16"	1270	1170	1070	990	900	830	750
T_{ult} (lb/ft)	s = 8"	1900	1750	1610	1480	1360	1240	1130
	s = 12"	2850	2630	2420	2220	2030	1860	1700
	s = 16"	3800	3500	3220	2960	2710	2480	2260

Note:

1. Design limit strain, $\epsilon_d = (0.7 * \Delta_{max})\%$, where Δ_{max} is the maximum allowable lateral wall movement (in inches)
2. T_{ed} : required force/width of geosynthetic reinforcement at design limit strain (ϵ_d)
3. T_{ult} : minimum required ultimate strength of geosynthetic reinforcement
4. s : vertical spacing of reinforcement
5. Surcharge pressure = 250 psf (increase T_{ed} and T_{ult} each by 13 % for every additional 250 psf surcharge pressure)

greater than 15 ft, the foundation is firm, the backfill is granular, and a "quick" design is desired and warranted.

To use the charts for design of a GRS wall, the following four parameters are needed:

- the wall height, H
- the friction angle of the backfill, ϕ
- the vertical spacing of reinforcement, s
- the maximum allowable lateral wall movement, Δ_{max}

The design charts allow one to determine:

- the minimum reinforcement length, L
- the minimum force/width of the geosynthetic reinforcement at the design limit strain, T_{ed} (note: the design limit strain for each wall height is shown in the footnotes of Table 2.4)
- the minimum required ultimate strength of the geosynthetic reinforcement, T_{ult}

Design Example:

The same as the design example described in Section 2.3.2.3, i.e., $H = 12$ ft, $\phi = 35^\circ$, and $\Delta_{max} = (3\%) * H$.

Use Table 2.4(c) for wall height $H = 12$ ft,

$$\Delta_{max} = (3\%) H = (3\%)(12)(12) = 4.3 \text{ in.}$$

The design limit strain $\epsilon_d = (0.9 * \Delta_{max})\% = (0.9 * 4.3)\% = 3.9\%$

For $\phi = 35^\circ$ (interpolate between $\phi = 34^\circ$ and $\phi = 36^\circ$) and $s = 12$ in.,

$$L = (8.8 + 8.5) / 2 = 8.65 \text{ (ft)}$$

$$T_{ed} = T (@ 3.9\%) = (670 + 610) / 2 = 640 \text{ (lb/ft)}$$

$$T_{nt} = (2,000 + 1,830) / 2 = 1,920 \text{ (lb/ft)}$$

2.3.3 Limitations of the Service-Load Design methods

The service-load design methods determine the required resistance of the geosynthetic reinforcement under service loads, thus alleviate some of the problems associated with applying a safety factor to the ultimate strength (as in the ultimate-strength design methods). However, the calculation of wall deformation is *very crude*. many of the factors that have been known to affect wall deformation are not included in the calculation. Some of the important factors are load-deformation behavior of backfill during construction and under service loads, compaction operation of the backfill, deformation characteristics of the foundation, construction sequence, and facing rigidity. In addition, the design methods are limited to their respective design assumptions regarding wall height, wall geometry, magnitude of surcharge, uniformity of the retained earth and foundation, etc.

2.4 Performance-Limit Design Methods

There are a number of design methods that allow the designer to determine the deformation of GRS walls in a more realistic manner than the service-load methods. Among them, the methods proposed by Gourc et al. (1986), Jewell and Milligan (1989) have received most attention.

Recently, the author and his associates developed a comprehensive computerized design tool for geosynthetic-reinforced soil retaining walls and steep slopes. The design tool,

in the form of a computer program called "GREWS," allows the designer to choose among four levels of sophistication, from the ultimate-strength design methods to a state-of-the-art performance-limit method. The performance-limit design method incorporated in GREWS is based on the finite element method of analysis. The design method can accommodate (a) any geometries of backfill, retained soil, and foundation; (b) any static loading conditions; (c) stress-strain-strength behavior of the soils and the geosynthetic reinforcement; and (d) construction sequence. Most importantly, it is possible to use GREWS with "conventional input" (i.e., those required by the service-load design methods) and little or no working knowledge of the finite element method. A description of GREWS is presented in the following Section.

2.4.1 GREWS - A Comprehensive Design Tool for GRS Structures

GREWS, the acronym for Geosynthetic-Reinforced Walls and Slopes, is a comprehensive design/analysis tool for geosynthetic-reinforced soil retaining walls and steep slopes. The computer program was developed by Wu, Helwany and Macklin in 1993 on behalf of CTI and CDOT. The design/analysis tool has four levels of sophistication:

1. **Level-1** uses existing limit equilibrium design methods, including the Forest Service ultimate-strength method, AASHTO ultimate-strength method, and the CTI service-load method, for design of GRS walls.
2. **Level-2** is capable of performing design and analysis of a wide variety of GRS walls in prescribed conditions by the finite element method.

3. **Level-3** allows the user to make modifications to the "canned" configurations and properties of Level-2 design.
4. **Level-4** involves "standard" analysis of GRS walls using the finite element method.

Levels-2, -3 and -4 are derived from a finite element program DACSAR (Deformation Analysis Considering Stress Anisotropy and Reorientation), which was developed by Iizuka and Ohta (1987) at Kyoto University, Japan. Extensive work has been conducted to verify DACSAR through comparisons with various soil "element" tests laboratory model tests, full-scale controlled tests of geosynthetic-reinforced soil retaining walls, and field tests.

Chou (1992) conducted a comparative study of four finite element computer codes: CRISP (developed at Cambridge University in England), CON2D (developed at Virginia Polytechnic Institute and State University), SSCOMP (developed at the University of California at Berkeley) and DACSAR. DACSAR was judged to be the best code for time-dependent analysis of soil-structure interaction problems.

Depending on the chosen level of sophistication, GREWS allows the user to perform analysis and/or design of GRS walls. Level-1 is for design only; Levels-2 and -3 can be used for design or analysis; while Level-4 is for analysis only. In the "analysis" mode, the user inputs the geometry of the wall, reinforcement configuration (i.e., length and spacing), reinforcement properties and soil properties. GREWS will calculate the response of the reinforced soil wall. In the "design" mode, the user supplies information similar to that in the "analysis" mode, except that the performance limits (e.g., allowable wall movement) are

input in place of reinforcement configuration and reinforcement properties. GREWS will design the wall and determine the wall response.

When using Level-2 or -3 in the "design" mode, a finite element analysis will first be performed on a trial design selected by the program. If the calculated performance of the reinforced structure is not within the acceptable limits (e.g., the deformation is excessive or the safety factor is too low), modifications to the trial design will be made by GREWS and additional finite element analyses will be performed until a satisfactory design is obtained.

All four levels assume plane strain geometry (i.e., the wall is far much wider than its height). Levels -2, -3, and -4 are cast in incremental form to simulate sequential construction operation. The soil behavior is simulated by either Sekiguchi-Ohta model (1977) or the modified Duncan Model (Duncan, et al., 1980).

2.4.2 Four Levels of Sophistication of GREWS

A summary of the four levels of sophistication is presented in Table 2.5. Some details of each level of sophistication are given in the following:

Level-1: Empirical Design

Level-1 can be used for design of GRS walls using limit equilibrium methods, including the Forest Service ultimate-strength method (presented in Section 2.2.3), AASHTO ultimate-strength method (AASHTO, 1992), and the CTI service-load method (presented in Section 2.3.1). Level-1 design may be used for preliminary design or merely as a benchmark for final design.

Level-2: Automated Design/Analysis

Table 2.5 A Summary of the Four Levels of Sophistication

Characteristics	Level-1	Level-2	Level-3	Level-4
Geometry	vertical or near vertical walls only	walls and steep slopes of prescribed geometries	allows modification to Level-2 geometries	any geometries
Soil Zones	homogeneous backfill; wall on rigid foundation	three soil zones: reinforced fill, retained earth, and foundation	allows modification to level-2 soil zones	no prescribed soil zones
External Loading	uniform surcharge	uniform surcharge	uniform surcharge	any static loads (distributed and/or concentrated loads)
Analytical Approach	limit equilibrium method	finite element method with automatic mesh generation	finite element method with automatic mesh generation	"standard" finite element method
Design/Analysis capability	design only	analysis and (automated) design	analysis and (semi-automated) design	analysis only
Design Methodology	ultimate-strength design and service-load design methods	performance-limit design method	performance-limit design method	not applicable
Knowledge of Finite Element Method	not needed	not needed	need working knowledge	needed
Typical Computer Run Time	a few seconds	a few minutes to several hours	a few minutes to several hours	a few minutes to several hours

Level-2 is capable of performing analysis and design of GRS walls in a variety of different conditions. The design and analysis, performed by the finite element method, is automated in such a way that the user only needs to supply "conventional" input. For example, when using the "design mode" of Level-2, the designer needs to supply only the information regarding the geometry and the soil type (and compaction), although he/she can always specify more project-specific information (if available). GREWS will determine the reinforcement configuration and required reinforcement strength and print out the corresponding deformation and safety factors. A design example using Level-2 is given in Section 2.4.3. A number of different automated finite element meshes have been implemented to accommodate GRS walls of different heights, different backfills, different foundations, and walls different retained soil conditions.

Level-3: Semi-Automated Design/Analysis

Level-3 design/analysis allows the user to make modifications to the input of Level-2 design/analysis. For example, if the geometry of the retained earth deviates from that generated by the automated mesh of Level-2 design, the designer may use Level-3 to specify the changes in Level-2 input so that the design can still be performed in an automated manner.

Level-3 can also be used in situations where the user wants to specify the material properties in a more discriminating manner. For example, the user can use Level-3 to assign different material types in any soil elements generated by Level-2 in order to simulate nonhomogeneous backfills or foundations.

Level-4: Standard Finite Element Analysis

Level-4 uses "standard" finite element method for analysis of GRS walls. In other words, the designer needs to input the finite element mesh, the material properties, the boundary conditions, and the loadings just like when one uses any finite element programs. Use of Level-4 design requires a good working knowledge of the finite element method and will allow analysis of virtually an geosynthetic-reinforced soil structures.

2.4.3 Design Example - Level 2

Given Conditions:

It is desired to design a vertical GRS wall depicted in Figure 2.21.

Input Data:

The input data for the design example are listed in Table 2.6. In this case, the input contains only a total of 22 numbers. The input data supply the following information:

1. *geometry, i.e., H_1 , H_2 , L_1 , L_3 , and L_5 (see Figure 2.22)*

Only the parameter H_1 is mandatory. Default values for the other parameters, if not provided, will be selected by GREWS.

2. *types of material for the backfill, the retained soil, and the foundation soil*

The material types can be specified by identifying their soil classification and other index properties. Typical soil parameters will then be selected from a material library in GREWS; in cases where test data for the backfill are readily available, the user has the option of specifying the soil parameters.

3. *type of facing, such as wrapped, articulated, or continuous*

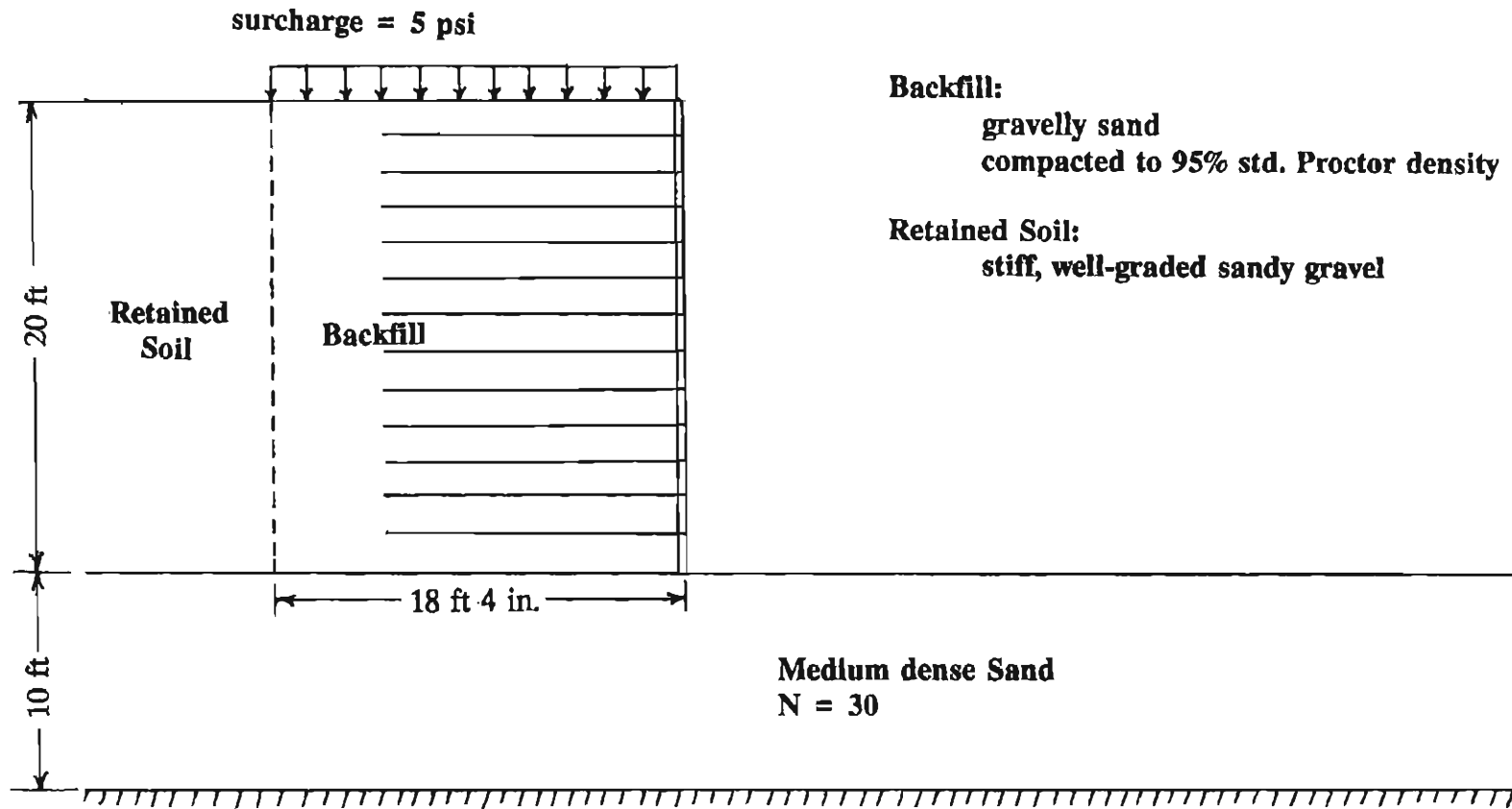

Figure 2.21 Cross-Section of a GRS Wall - Design Example for Level-2 of GREWS

Table 2.6 Input Data for the Design Example - Level 2

Line No.	Input Data
1	2
2	1 3 1 5.0
3	3 99 99 0 0 3 1
4	240 120 220 160 700 160
5	0
6	0
7	0 0
8	0.5

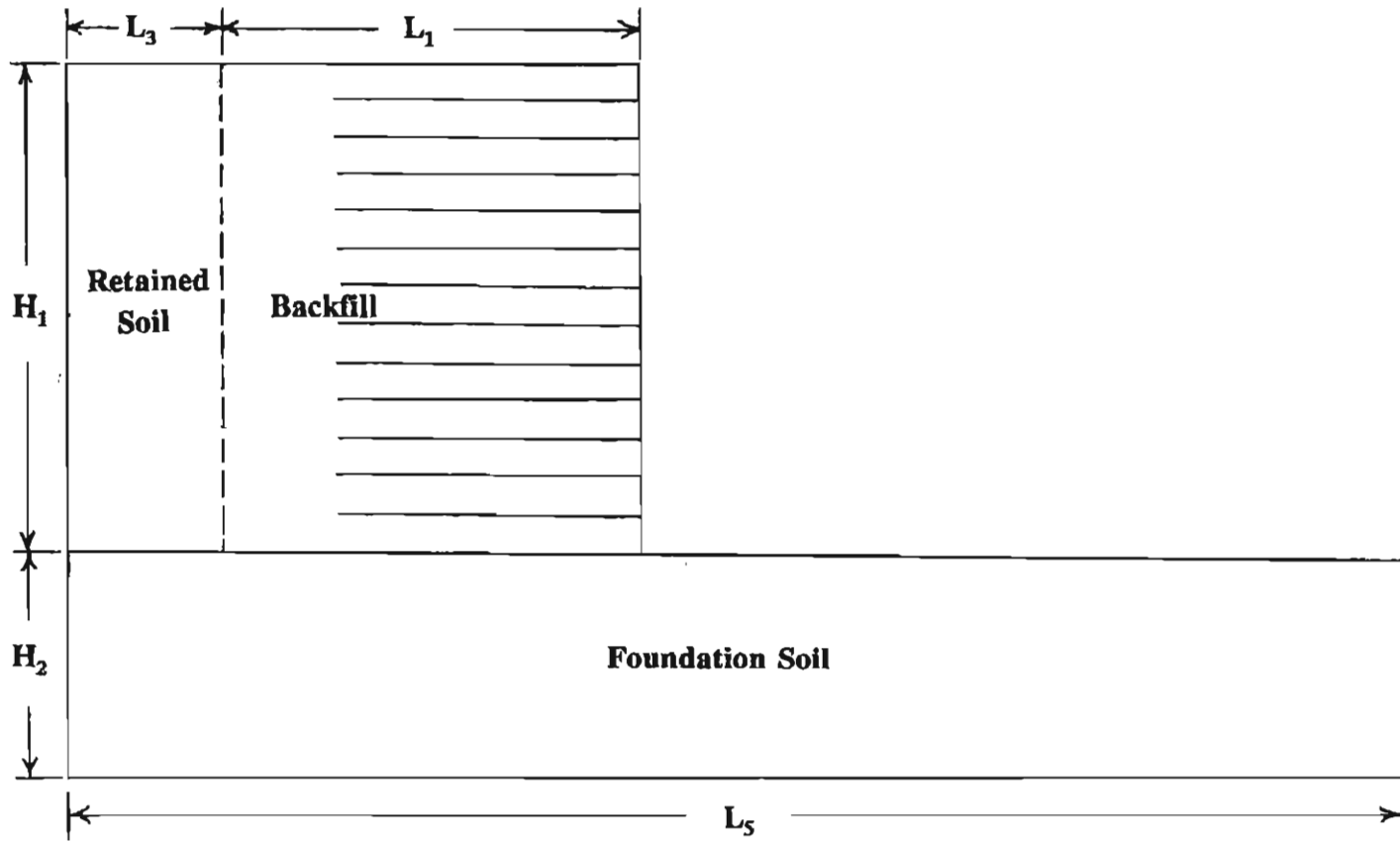

Figure 2.22 Input of Wall Geometry for the Design Example

For articulated and continuous facings, GREWS will also print out the required facing rigidity.

4. *allowable performance limits*

The performance limits include allowable lateral wall displacement and factor of safety against shear failure.

Program Execution:

After accepting the input from the designer, GREWS will automatically establish a finite element mesh corresponding to the selected geometry, as shown in Figure 2.23. A finite element analysis will then be performed on a trial design selected by GREWS. If the calculated performance of the reinforced structure is not acceptable (e.g., the deformation is excessive or the safety factors are too low), modifications to the trial design will be made by GREWS and additional finite element analyses will be performed until a satisfactory design is obtained.

Output:

GREWS will calculate the response of the GRS wall, including the displacements of the wall face; the displacements, stresses, strains in the backfill, retained soil and foundation; the displacements and tensile forces in the reinforcement; and safety factor against shear failure. GREWS allows the designer to choose among three levels of output which contain different degrees of detail. Figure 2.24 shows the simplest level of output for the design example. Figure 2.25 shows the deformed geometry of the GRS wall.

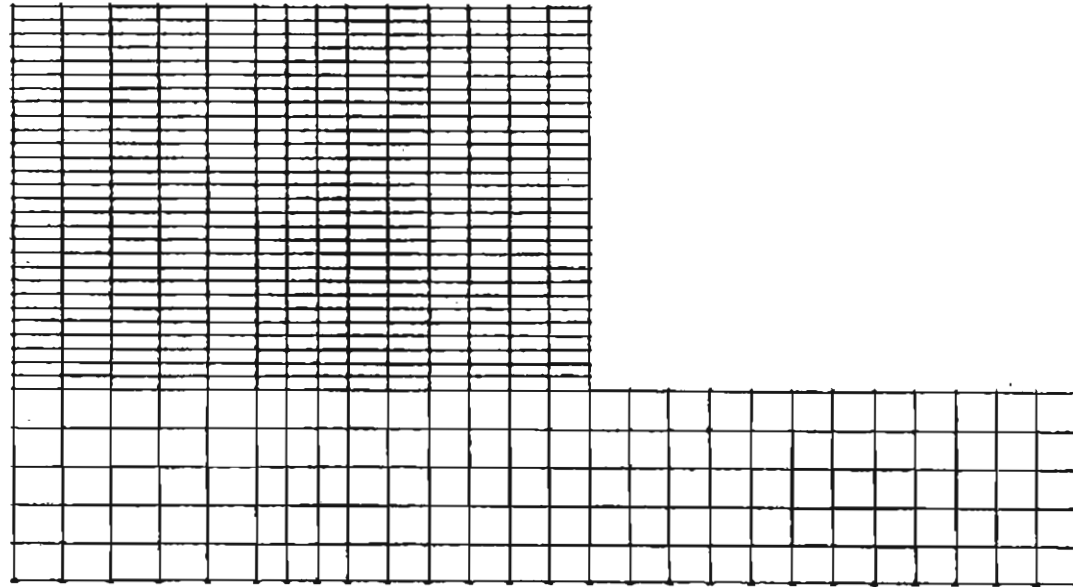

Figure 2.23 Finite Element Mesh Generated by Level-2 of GREWS

Solution Level:	2
IDSGN = 1	
IDSGN = 1	Design
IDSGN = 2	Analysis
ICASE = 3	
ICASE = 1	Walls on rigid foundation
ICASE = 2	Walls on deformable foundation
ICASE = 3	Walls on deformable foundation and with retained soil
ICASE = 4	Slopes on rigid foundation
ICASE = 5	Slopes on deformable foundation
ICASE = 6	Slopes on deformable foundation and with retained soil
ISURCH = 1	
ISURCH = 0	Without surcharge on crest
ISURCH = 1	With surcharge on crest
SIGSUR = 5.0	
SIGSUR is the magnitude of surcharge pressure (in psi)	
<hr/>	
Design Trial No.:	11
Backfill soil type:	3
Facing Type:	articulated timber facing
Apparent Fs: (against shear failure)	3.5
Displacements at wall face:	
Maximum horizontal displacement = 1.5 in.	
(@ x = 380 in. ; y = 214 in.)	
Maximum vertical displacement = 1.9 in.	
(@ x = 273 in. ; y = 360 in.)	
Reinforcement:	
Vertical Spacing	8 in.
Length	160 in.
Required reinforcement stiffness/strength:	
T (lb/ft) \geq	209
@ design limit strain	1%
T _{ult} (lb/ft) \geq	627

Figure 2.24 The Simplest Output for the Design Example

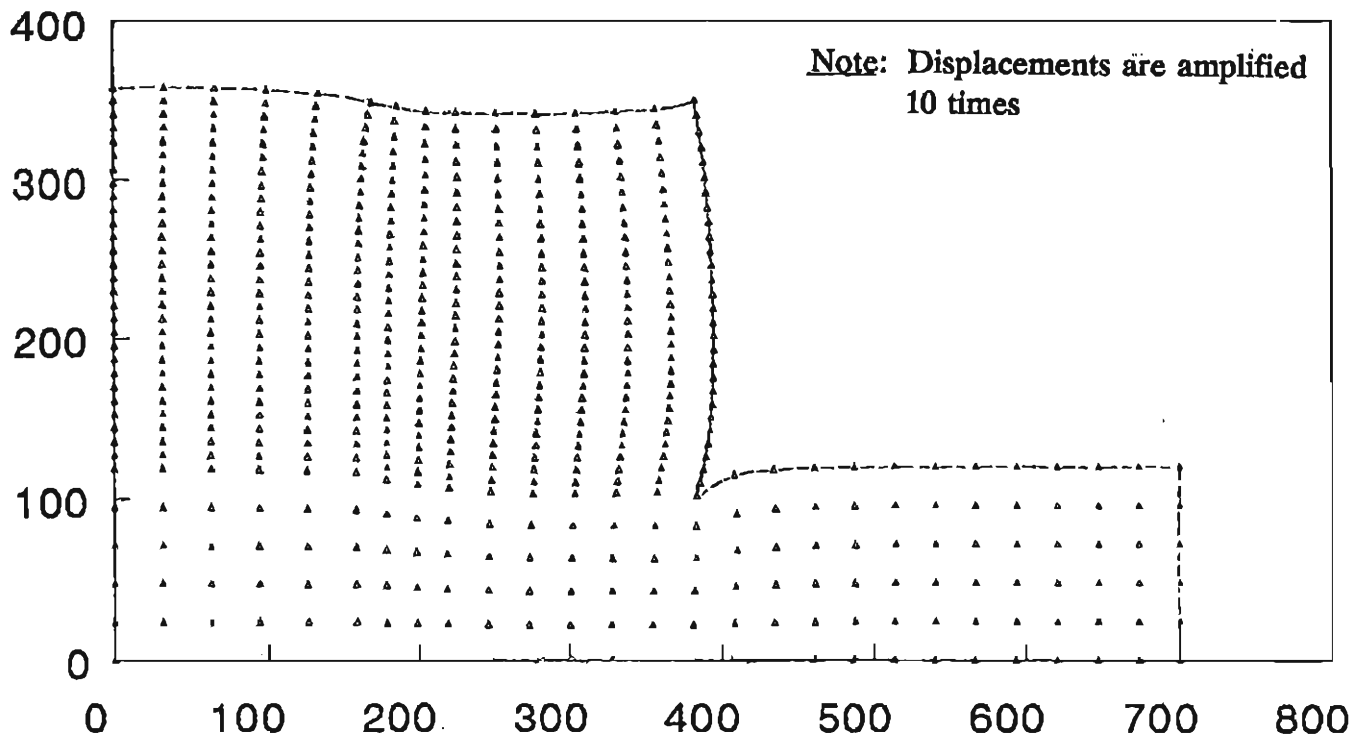

Figure 2.25 Deformation of GRS Wall for the Design Example

2.5 Design of Rockery

No two rockeries are alike. Design of rockeries is more an art than a science. The following are design recommendations derived from field experiences:

- 1) The base-to-height ratio of a rockery should not be greater than 0.7.
- 2) maximum height of a rockery should not exceed 15 ft.
- 3) The first course of rocks must be embedded under ground surface. The depth of embedment should be at least one half of the rock diameter or 2 ft, whichever is larger.
- 4) The allowable steepness of a rockery face depends largely on the rock size and shape. Rocks with weight greater than 500 lb and rectangular in shape can be used to create a rock face of steepness up to 2 (vertical) to 1 (horizontal) slope. Smaller or rounded rocks should be limited to the construction of rockeries not steeper than 4 (vertical) to 3 (horizontal) slope.
- 5) Rocks should be placed in fairly uniform lifts, and infilled with a granular material such as a road base aggregate. The infilling should be as complete as possible. Since large rocks typically have diverse sizes and shapes, lift lines will not be visible in the final appearance of rockeries.

Chapter 3

CONSTRUCTION OF LOW-COST RETAINING WALLS

3.1 Construction Considerations for GRS walls

Earthwork construction control for geosynthetic-reinforced soil walls, including the USFS wrapped-faced geotextile-reinforced wall, the CTI timber-faced geosynthetic-reinforced wall, and modular block geosynthetic-reinforced walls, is essentially the same as that required for conventional retaining structures, but with a few additional details that requires special attention. Field substitutions of backfill materials or changes in construction sequence, procedures, or details should only be permitted with the express consent of the responsible geotechnical or preconstruction design engineer.

Site Preparation

Before placement of the reinforcement, the ground should be graded to provide a smooth, fairly level surface. The surface should be clear of vegetation, large rocks, stumps, and the like. Depressions may need to be filled; soft spots may need to be excavated and replaced with backfill material; and the site may need to be proof rolled. However, it is usually not necessary to sub-excavate the ground for embedment and frost heave protection, as is commonly done in the construction of conventional reinforced concrete walls. It is recommended that a nominal thickness (about 4 to 6 in.) of granular soil be placed at the base of the wall for drainage and leveling purposes.

If site preparation involves excavation, the construction site should be excavated to the limits shown in the plans. The excavation width at any depth should be equal to or exceed the length of the reinforcement layer designed for that elevation.

Handling of Geosynthetic Reinforcement

Geosynthetics, especially geotextiles, should not be exposed to sunlight and extreme temperatures for an extended period of time. Damaged or improperly handled geosynthetic reinforcement should be rejected.

Placement of Geosynthetic Reinforcement

After the reinforcement is in place, it should be examined carefully. Damaged or torn materials should be replaced or repaired as prescribed in the specifications. In no case should construction equipment be allowed to operate directly on any geosynthetic reinforcement before fill is placed. When using a geotextile reinforcement, a minimum backfill cover of 6 in. should always be maintained between the geotextile and moderate size construction equipment (e.g, Caterpillar D6 or 955).

The geosynthetic reinforcement should be unrolled in the direction perpendicular to the wall face whenever feasible. In which case, overlapping of adjacent geosynthetic sheets should be at least 6 in., and sewing or other connections is usually not necessary. If the reinforcement is not unrolled perpendicular to the wall face, joining adjacent geosynthetic sheets should be performed strictly according to the plan and specifications. Generally, overlapping the layers should be of a minimum of 3 ft; sewing of layers should be made on a minimum of 4 in. overlaps.

Wrinkles and folds in the geosynthetic reinforcement prior to placement of fill should be kept to a minimum. Slight pre-tension of geosynthetic reinforcement (e.g., by stretching) is beneficial.

Fill Placement and Compaction

Backfill should be progressively dumped and spread toward the wall face. Special attention should be given to ensuring good compaction of the backfill, especially near the face of the wall. Otherwise detrimental settlements behind the face may cause a downward drag on the reinforcement, which might induce excessive tensile stress in the reinforcement, particularly near the face of the CTI timber-faced geosynthetic-reinforced wall and modular block walls for which the reinforcement is attached to the facing.

Each lift should not exceed 12 in. in loose thickness and should be compacted to achieve a minimum of 95% of the maximum dry density according to ASTM D698 or AASHTO T-99. It is recommended that the placement moisture content for a granular fill be $\pm 2\%$ of the optimum, and within 4% wet of optimum (i.e., between the optimum and 4% wet-of-optimum) for a cohesive fill. At the end of each day's backfilling operation, the last lift of fill should be sloped away from the wall facing to direct any possible runoff away from the wall face.

Alignment of Wall Face

For all the wall systems, care should be taken not to allow heavy construction equipment to operate too close (within 1 to 2 ft) to the wall face. Otherwise undesirable bulging of face may result. For the USFS wrapped-face geotextile-reinforced wall, especially when wall height is greater than 6 ft, the use of a formwork against the wall face during

placement of backfill can help maintain the alignment. For modular block walls, the alignment of the first few courses of blocks is critical to the alignment of the wall face.

Control of Water During Construction

Surface runoff should be directed away from the site during construction. Also, surface runoff from adjacent areas should be prevented from encroaching on the site. The simplest way to control surface water is to excavate a trench or construct a dike or curb around the perimeter of the site, and disposal of the water by gravity or by pumping from sumps.

For walls constructed below the ground water table, dewatering may be required to provide a working platform. Although there are many methods available for this purpose (e.g., well points, horizontal drains, etc.), the simplest technique is to construct perimeter trenches and connect them to sumps. This method is most effective when the excavation is in cohesive material and the ground water is not too high. The trench should be installed as far from the location of the wall base as practical to prevent disturbance due to ground water seepage. In certain cases, impermeable barrier to reduce or eliminate the inflow of ground water into the work site may be more effective than dewatering. Usually the selection of the method is left to the contractor.

Surface Runoff Drainage

To reduce percolation of surface water into the backfill during the service life of a wall, the crest should be graded to direct runoff away from the back slope. Sometimes interceptor drains on the back slope can be used. Periodic maintenance is also necessary to minimize runoff infiltration.

Subsurface Drainage

The GRS walls described in this Manual all provide inherent drain capability at their face. Therefore, subsurface drainage at wall face is generally not necessary. However, when a cohesive backfill is used, measures should be taken to minimize wetting of the cohesive soil. This can be achieved by providing a combination of granular drain materials and geotextiles, or a geocomposite drain (Christopher and Holtz, 1985; Koerner, 1990) along the top, the back, and the base of the cohesive backfill. Chou (1992) recommended that layers of free draining granular soil (6-in. thick) be placed intermittently within the cohesive backfill to facilitate subsurface drainage.

3.2 USFS Wrapped-Faced Geotextile-Reinforced Wall

3.2.1 Construction Procedure

The following construction sequence has been proposed by the U.S. Forest Services and illustrated in Figure 3.1:

Step 1: level wall site, place a series of L-shaped form of height slightly greater than the lift thickness on the (ground) surface. The L-shaped form composed of a series of metal L brackets and a continuous wooden brace board running along the wall face (see Figure 3.2).

Step 2: place a layer of geotextile sheet on the surface and position it in such a way that approximately 3 ft of the geotextile extends over the top of the form and hang loose; backfill to approximately three-fourths of the lift thickness and compact with conventional light earth moving equipment.

Step 1



Step 2



Step 3



Step 4



Step 5

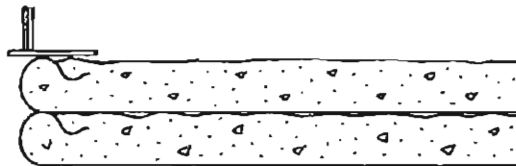

Figure 3.1 Construction Sequence of USFS Wrapped-Faced Wall



Figure 3.2 **Erection of a USFS Wrapped-Faced Wall with the Use of a L-Shaped Form (courtesy Gorden Keller, USDA Forest Service)**

- Step 3: Make a windrow 12 to 24 in. from wall face with a road grader or with hands, and fold the loose end of the geotextile ("tail") back over the L-shaped form into the windrow.
- Step 4: backfill and compact the remaining lift thickness; remove the form and reset it on the top of the first lift.
- Step 5: Repeat Steps 2 through 4 for the subsequent lifts until the planned height is reached. For the final layer, the tail length must be at least 6 ft.
- Step 6: Cover the exposed face of the wall with bituminous emulsions, other asphalt products, or gunite (shotcrete) to prevent weakening of geotextile due to UV exposure and possible vandalism. Figure 3.3 shows a wrapped face is being covered with shotcrete.

3.2.2 Construction Guidelines

The following are some construction guidelines for the USFS wrapped-faced geotextile-reinforced walls:

- If the geotextile is sufficiently wide for the required reinforcement length, it can be unrolled parallel to the wall (i.e., in the longitudinal direction). Two rolls of geotextile can be sewn together if a single roll is not wide enough. Alternatively, the geotextile can be deployed perpendicular to the wall (i.e., in its transverse direction) and adjacent sheets can be overlapped or sewn. In this way the machine direction of the geotextile, which is usually the strongest, is oriented in the maximum stress direction.



Figure 3.3 **A Wrapped-Faced Wall Face being Covered with Shotcrete**

- The backfill is preferably granular. However, a clayey soil with 20% smaller than No. 200 sieve can be used as backfill.
- Compaction shall be done with equipment that will not damage the geosynthetic reinforcement, and no compaction is allowed within 1 to 2 ft from the wall face.
- Typical lift thickness ranges from 8 in. to 18 in., however, lift thickness of 1 ft is most common.
- When making the windrow, care must be exercised not to dig into the geotextile beneath or at the face of the wall.
- Before apply a coating to a vertical or near vertical wall, a wire mesh may need to be anchored to the geotextile to keep the coating on the wall face.
- It is usually necessary to have scaffolding in front of the wall when the wall is higher than 6 ft.

3.3 CTI Timber-Faced Geosynthetic-Reinforced Wall

3.3.1 Construction Procedure

The typical construction sequence of the CTI timber-faced geosynthetic-reinforced wall, as illustrated in Figure 3.4, can be described in the following steps:

- Step 1: level wall site, place the initial row of ties or timbers, and place the first geosynthetic reinforcement layer with a minimum of 12 in. tail length;
- Step 2: attach the first reinforcement layer to the initial ties or timbers by nailing forming element (3 1/2 in. in width) to ties or timbers;

Step 1

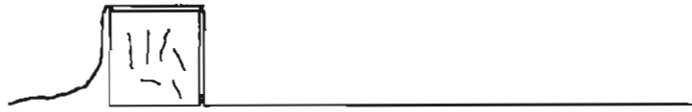

121

Step 2

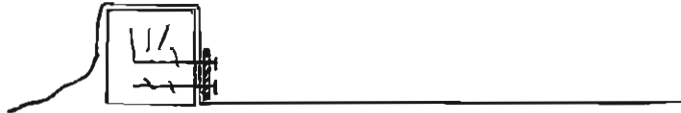

Step 3



Step 4

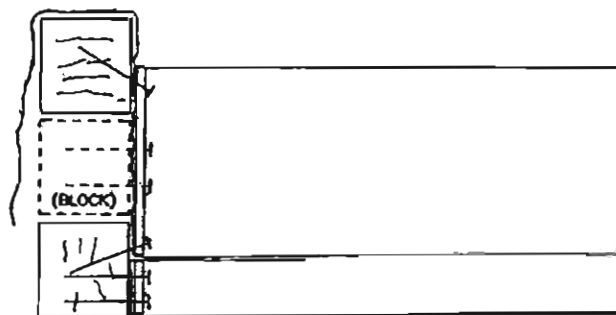

Figure 3.4

Construction Sequence of CTI Timber-Faced GRS Wall

- Step 3: backfill to the top of forming element, compact the lift, and fold back the tail of the reinforcement (see Figure 3.5);
- Step 4: place the second tie and block, place the second layer of geosynthetic reinforcement, attach the reinforcement layer to the ties and blocks by nailing through the forming element (12 in. in width), backfill with a nominal lift thickness of 12 in. and compact;
- Step 5: repeat Step 4 for subsequent layers until the planned height is reached. For the final layer, the fold-back tail length should be at least 6 ft.

3.3.2 Construction Guidelines

The following are some construction guidelines for the timber-faced geosynthetic-reinforced wall:

- The timber typically has a 6 in. x 8 in. or 6 in. x 6 in. cross-sectional dimension and shall be treated to an acceptable level with copper chromate or approved equivalent preservative. The bottom row of timber shall be treated for direct burial. The color may be green or brown, but not mixed.
- Forming elements may consist of wood (minimum 1 in. nominal thickness treated to an acceptable level with copper chromate or approved equivalent), fiberglass, plastic, or other approved material.
- Typical reinforcement used is a nonwoven geotextile, although other geosynthetics that satisfy the design criteria can also be used.



Figure 3.5 Construction of a CTI Timber-Faced GRS Wall

- Nails shall be 16d galvanized ring shank nails and shall be placed at the top and bottom of the timbers at 1-ft intervals.
- Compaction shall be consistent with project embankment specifications, except that no compaction is allowed within 1 to 2 ft of the wall face.
- Compaction shall be done with equipment that will not damage the reinforcement.
- Outward batter on the face of the is not acceptable. An inward batter of 0 to 4 in. horizontal to 10 ft vertical shall be required to maintain verticality of wall face (see Figure 3.6). Shimming of timber to maintain the verticality is permissible.
- Type-3 guardrail posts shall be driven no closer than 30 in. from the face of the wall (30 in. from back of guard rail post to outside face of wall) and shall be metal posts.
- All reinforcement overlaps shall be 1-ft wide and shall be perpendicular to the wall face.
- All exposed fabric shall be painted with a latex paint matching the color of the timbers.
- If the on-site material used as backfill is not free-draining soil (< 5% minus No. 200 sieve), a drainage system such as the one shown in Figure 3.7) should be provided.

3.4 Modular Block Geosynthetic-Reinforced Walls



Figure 3.6 Inward Batter of Timber Wall Face

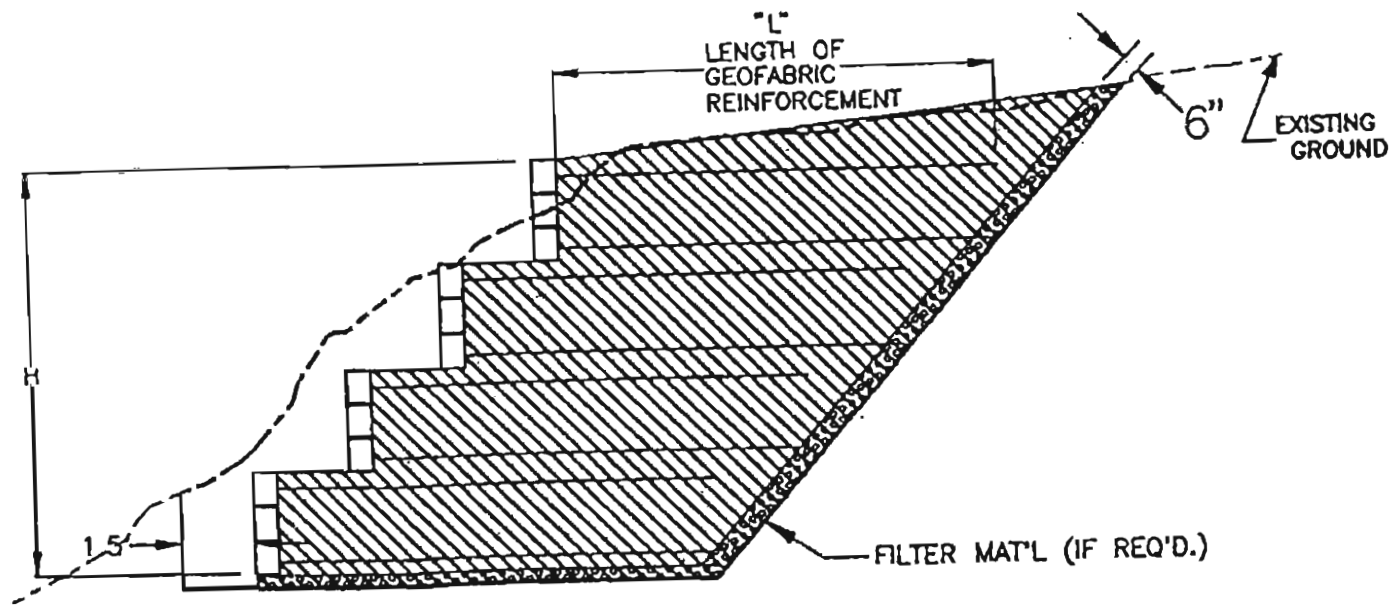

Figure 3.7 A Timber-faced GRS Wall with Filter Material at Bottom and Back

3.4.1 Construction Procedure

The typical construction sequence of modular block geosynthetic-reinforced walls, as illustrated in Figure 3.8, can be described as follows:

- Step 1: level wall site, and cut a shallow trench along the planned location of the wall base, pour and level an unreinforced concrete pad with a minimum thickness of 3 1/2 to 4 in.
- Step 2: Lay the first course of modular blocks side-by-side on the concrete pad, check the alignment and level the blocks, and insert pins (if used) into the top of the blocks; Place crush stone or sand into the hollow cores of the modular blocks and the space between the blocks, and clean the surface by sweeping away the debris.
- Step 3: Place backfill behind the modular blocks and compact to the top of the block elevation. If the backfill is not a free draining material, a free draining gravel of 1-ft wide should be placed immediately behind the blocks.
- Step 4: Repeat Steps 2 and 3 for subsequent courses of modular blocks until a reinforcement layer is to be placed as per the design, install geosynthetic reinforcement across the blocks and soil fill at the specified elevation (see Figure 3.9).
- Step 5: Repeat Step 2 for the next course of blocks, pull taut and anchor the reinforcement, and backfill behind the blocks and compact.
- Step 6: Repeat Steps 4 and 5 until the planned height is reached. The last course of blocks are usually capped according to the manufacturer's recommendation.

Step 1



Step 2



Step 3



Step 4

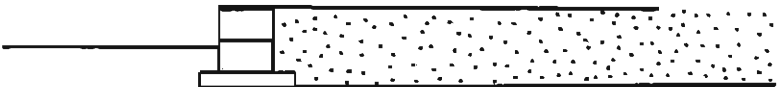

Step 5

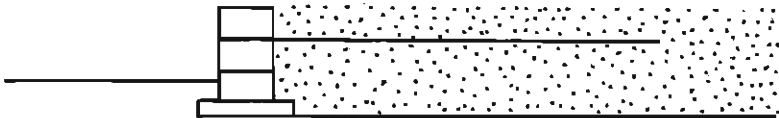

Step 6

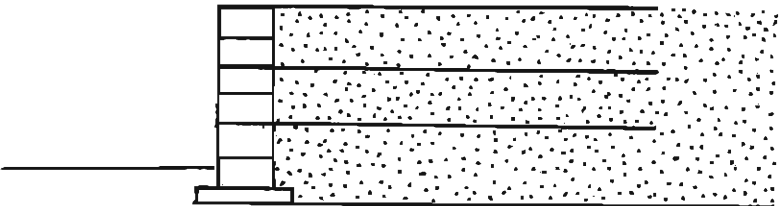

Figure 3.8

Construction Sequence of Modular Block GRS Wall

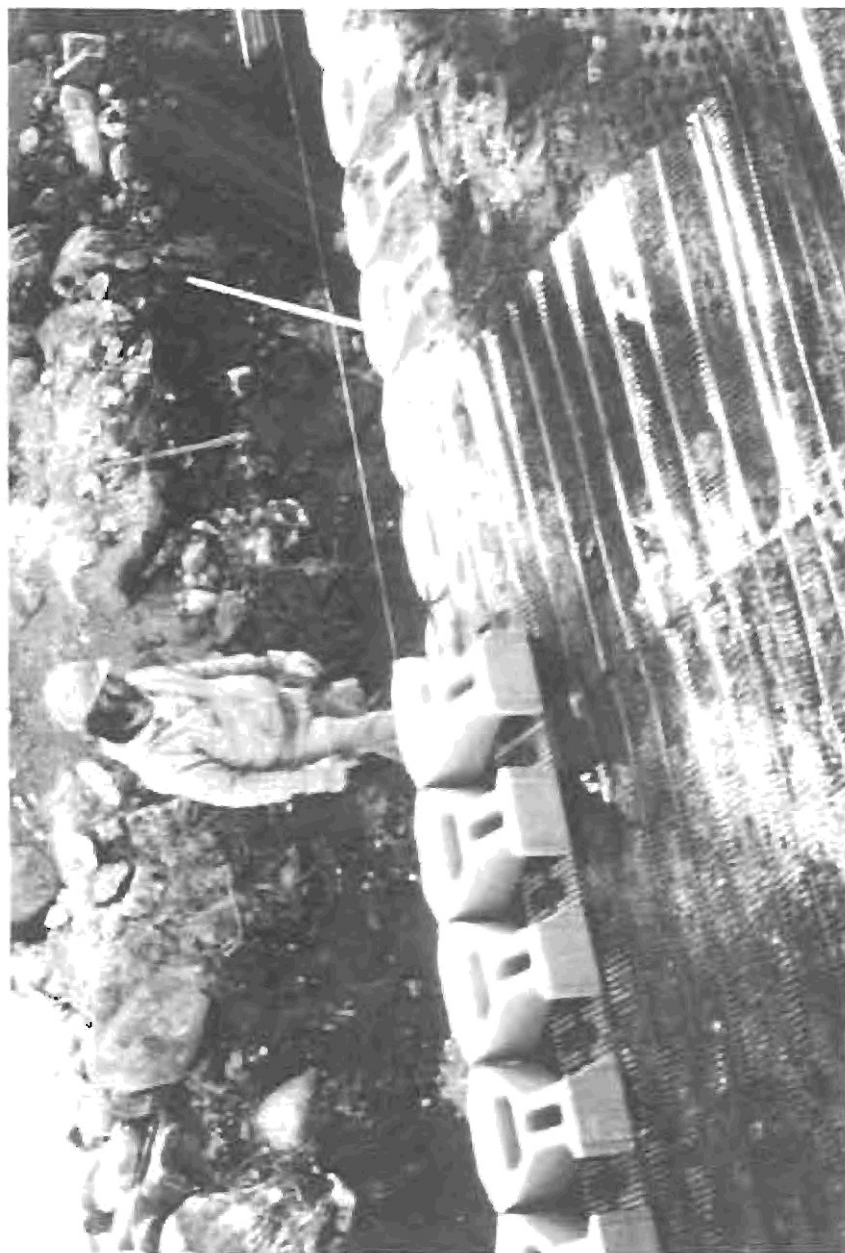

Figure 3.9 Construction of a Modular Block GRS Wall

3.4.2 Construction Guidelines

The following guidelines should be observed when constructing a modular block geosynthetic-reinforced wall:

- The concrete leveling pad under the first course of modular blocks can be replaced with a leveling pad of compacted gravel (or compacted in-situ soil). However, the use of a concrete leveling pad is recommended when the foundation soil is relatively incompressible and not susceptible to significant shrinkage and swell due to moisture changes. A properly poured and leveled concrete pad will speed up construction, ease the leveling process, and facilitate the construction of a straighter wall.
- Walls with curves along their length require that the leveling pad be poured to the proper radius. In general, a curve radius of 10 ft or greater is not a problem; however, tight curves of 3 to 6 ft radius require special consideration (Moreno, et al., 1993). In some cases, field modification of the blocks may be necessary for tight curves.
- The blocks should be laid from one end of the wall to the other to preclude laborious block cutting and fitting in the middle. When curves are involved in a wall, the blocks on the curves should be laid first as their alignment is more critical and less forgiving. Tight curves often require cutting blocks to fit or breaking off the block tail. A diamond-tipped blade saw is recommended for the cutting.

- When shear pins are used, they should be tapped into well-seated position immediately after setting each block to avoid getting fill into the block's pin holes.
- Leveling of the first course of blocks is especially important for wall alignment. A string line set over the pins from one end of the wall to the other will help leveling the blocks.
- Geosynthetic reinforcement should be placed up to front face of the blocks to ensure maximum interface contact with the blocks.
- After front of the geosynthetic reinforcement is properly secured (i.e., after the hollow cores of the next course is filled and compacted), the reinforcement should be pulled tight and pre-tensioned while the backfill is being placed.
- Care should be exercised when placing backfill over geosynthetic reinforcement. The backfill should be emplaced from the wall face to the back of the wall to ensure that no slack is left in the reinforcement.
- To avoid movement of blocks during construction, a hand-operated tamper should be used to compact the soil within 3 ft of the wall face, and no construction vehicles is allowed within the 3 ft region.

3.5 Rockery

3.5.1 Construction Procedure

The following construction procedure for rockeries is recommended:

- Step 1: Excavate a strip of at least 0.7 times the height of the rockery at the planned location of the rockery. The depth of excavation should be at least one half of the rock diameter or 2 ft, whichever is greater.
- Step 2: Place the first course of rock in the excavated area, and infill the rocks with a granular material such as a road base aggregate to create a fairly uniform surface.
- Step 3: Place subsequent lifts of rocks and road base infills; repeat the procedure until the design height is reached.

3.5.2 Construction Guidelines

The following guidelines should be observed when constructing a rockery:

- Do not exceed the height and slope angles delineated in the design without evidence that higher or steeper features will be stable.
- Rocks should be placed by skilled operators; and should be placed in fairly uniform lifts.
- Care should be exercised in placing the infill. The infilling should be as complete as possible.

Chapter 4

APPLICATIONS OF THE LOW-COST RETAINING WALLS

Both the USFS wrapped-faced geotextile-reinforced wall and the CTI timber-face geosynthetic-reinforced wall can be constructed at most sites where a retaining wall is deemed necessary. Typical applications include highway embankment wall over compressible foundations, temporary or permanent widening or diversion embankment wall, highway retaining walls on steep mountain slopes, slide stabilization on remote mountain roads, rock fall barriers, small dams, noise barrier walls for highways or airports, and various urban retaining wall projects.

In this Chapter, a number of case histories for each low-cost retaining wall system is presented. In addition, the inherent advantages and disadvantages of each system are addressed.

4.1 USFS Wrapped-Faced Geotextile-Reinforced Wall

4.1.1 Case Histories

Glenwood Canyon Test Wall

In 1982, the Colorado Department of Highways constructed the first instrumented geotextile-reinforced soil wall on Interstate-70 through Glenwood Canyon. The wall was 300-ft long, 15-ft high, and was divided into ten 30-ft-long test segments. The cost of the test wall ranged from \$11.00 to \$12.50 per square foot of wall face. Design, construction, and measurement data of the test wall have been reported by Bell, et al. (1983).

Figure 4.1 shows a typical cross section of the test wall, of which the geotextile reinforcement extended 12 ft into the backfill. Four non-woven geotextiles, each in two different weights, were used as reinforcement. A surcharge load up to 15 ft high was placed on top of the wall four months after its completion. Although portions of the wall had very low safety factors and were expected to be highly stressed or to fail, the wall withstood 1.4 ft of settlement one year after construction, and no major distress has been observed since then.

To investigate long-term durability of the geotextiles, a portion of the test wall was excavated in 1985 to obtain geotextile samples. The excavation has remained unprotected ever since (see Figure 4.2). Surprisingly, the integrity of the wall has been maintained for the past eight years despite the fact that the backfill is essentially cohesionless, and the unprotected facings are in southern exposure. The geotextile reinforcement is obviously very effective in stabilizing the near vertical wall even in the absence of a facing. Recently (in 1993), tensile tests were conducted on geotextile samples exhumed from the test wall. The results indicated no loss of strength compared with post-construction tests performed in 1982.

It is to be noted that most of the wrapped-face geotextile-reinforced walls constructed to date have been designed by the U.S. Forest Service method (presented in Chapter 2). Measurement of wall performance has indicated that the design is much too conservative.

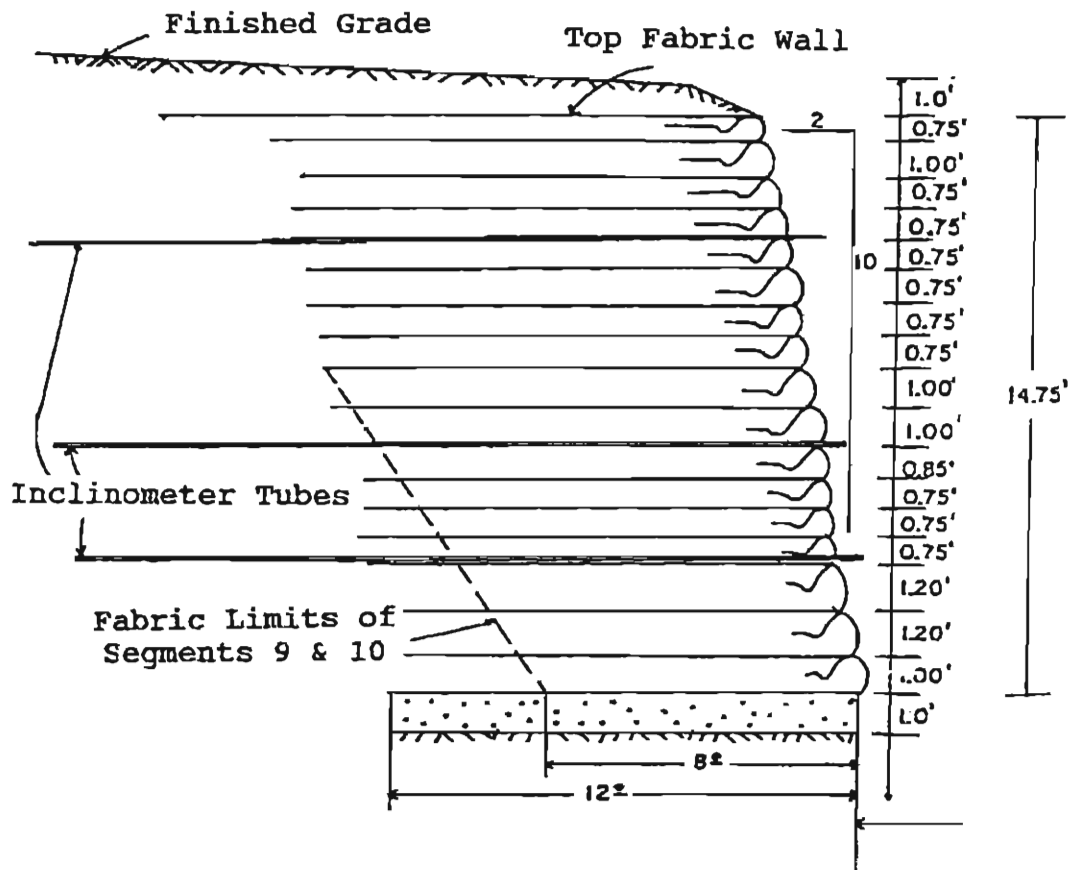

Figure 4.1

A Typical Cross-Section of the Glenwood Canyon Test Wall (Bell, et al., 1983)



Figure 4.2 Glenwood Canyon Test Wall Five Years after Excavation

4.1.2 Advantages of the USFS Wrapped-Faced Wall

The USFS geotextile-reinforced soil retaining wall has the following inherent advantages over conventional reinforced concrete walls (and to a lesser degree over other types of reinforced soil walls):

- 1) The USFS geotextile-reinforced wall is flexible. The wall can tolerate large foundation settlement and differential settlement without distress.
- 2) When properly designed and constructed, the wall has a high load carrying capacity and is very ductile (i.e., can deform significantly without collapse).
- 3) The wall does not require embedment into the foundation soil, thus eliminate the need for sub-excavation. This feature is especially important when environmental constraints are involved. If the wall is to be constructed over a contaminated soil, elimination of soil excavation will reduce the risk of spreading contaminated soil. Besides, damages to adjacent streams and root systems due to excavation can be avoided. Figure 4.3 shows a geosynthetic-reinforced soil wall constructed immediately next to a grown tree. Since excavation is eliminated, the tree is saved.
- 4) Granular backfill, although preferred, is not required provided that adequate drainage in the backfill is provided.
- 5) The wall will not exhibit any appreciable long-term creep as long as (a) the backfill is predominantly granular, or (b) surface and subsurface drainage is properly provided to prevent wetting of a cohesive backfill.



Figure 4.3 **Construction of a Timber-Faced GRS Wall adjacent to a Grown Tree**

- 6) A large variety of geotextiles with different strength and costs are readily available; geotextiles are easy to transport to remote sites; and most geotextiles have strong resistance to corrosion and bacterial action, compared with metallic reinforcements.
- 7) The geotextile reinforcement can effectively induce an apparent cohesion of cohesionless backfill to assume a vertical slope even without a facing.
- 8) Other than the function of reinforcing soil, geotextile fulfills multiple functions, e.g., alleviate drainage problems, prevent particle migration, maintain separation of different soil layers during construction or under repeated external loading.
- 9) Construction of the wall is rapid and requires limited or no heavy construction equipment.
- 10) The cost of the USFS wrapped-faced geotextile-reinforced wall is low.

4.1.3 Disadvantages of the USFS Wrapped-Faced Wall

The USFS geotextile-reinforced wall has the following disadvantages:

- 1) Construction equipment may cause damage of geotextiles during installation.
- 2) Some geotextiles are susceptible to chemical degradation.
- 3) Geotextiles may exhibit creep deformation with time if a cohesive backfill is used and the backfill becomes saturated.
- 4) The wall may experience large deformations if a weak geotextile is used or if it is not properly constructed.

- 5) Most geotextiles will deteriorate when exposed to UV lights.
- 6) The wrapped-face wall facing covered with asphalt products or gunite has less desirable aesthetic appearance than some other wall systems.

4.2 CTI Timber-Faced Geosynthetic-Reinforced Wall

4.2.1 Case Histories

Highway 13 North of Craig

The first CTI timber-face geosynthetic-reinforced wall was built near Craig, Colorado. Widening of Highway 13 north of Craig required a fill slope into an adjacent stream. Permits for this encroachment were difficult to obtain, and a wall was deemed necessary to avoid placing fill into that stream. The wall was 7-ft high and 300-ft long, and was backfilled with on-site clay soils. The contractor bid less than \$4 per square face foot to construct this wall. The wall has performed satisfactorily since construction.

Junction of Highways-67 and -96, Wetmore

A timber-faced geosynthetic-reinforced wall with cohesive backfill was built at the junction of Colorado Highways 67 and 96 in Wetmore. The wall was about 14 ft high, 120 ft long, and the length of geotextile reinforcement varied from 3 to 10 ft. Two 8-ft diameter metal culverts ran through the backfill and wall. A woven geotextile was selected as reinforcement, with a minimum tensile stiffness of 1,500 lb/in at 4 % axial strain along the working direction. An on-site gravelly sandy clay was selected as backfill. This soil was classified as A-6(4) per AASHTO classification, with LL = 32, PL = 17, and about 50% of particles passing the No. 200 sieve.

Subsequent to completion of wall construction, a lateral deformation of about 8 in. near the mid-height of the wall was discovered following a 2 to 3 weeks of raining season (as the name implied, the town is getting "wet more and more"). Since this wall was designed as a temporary wall (used only for 4 months), the on-site cohesive backfill was allowed and no subsurface drainage system was provided in the backfill. The runoff from rain seeped into the wall and saturated the cohesive backfill. The two 8-ft diameter drainage pipes, bringing a heavy flow of water through the backfill, might also have contributed to further wetting of the backfill and lead to the large wall deformation.

Another cause for the large wall deformation is attributed to mis-communication between the designer and field engineer. The designer gave an equation for reinforcement length as: $W = 0.7 H$, where W = reinforced length and H = wall height. The field engineer interpret the term H as the "current" wall height, which increases from a small number (after the first construction lift) to 14 ft (at the last construction lift). This resulted in a trapezoidal configuration for the reinforcement, and the length of reinforcement was much shorter than designed in the lower part of the wall.

Highway-34 at Wray

An additional lane was required at an intersection on Highway 34 at Wray, Colorado. The toe of the embankment was at the existing right-of-way, and purchase of additional lands would have been both expensive and time consuming. The timber-faced geosynthetic-reinforced wall was selected as the least expensive solution to the problem. The wall was 400 ft long and 7 ft high. Cost was \$11.35 per square face foot of wall.

This wall was constructed with a truncated base. The bottom sheet of reinforcement was 4 ft wide. This minimized excavation into the existing fill slope. There was a grove of large trees on the right-of-way line. The wall was not embedded into the ground, thus avoiding an excavation that would have damaged or killed some of the trees.

Interstate-25 at Colorado Springs

Widening of Interstate 25 in Colorado Springs, Colorado required a fill that encroached to Fountain Creek. Designers opted to use a retaining wall to avoid that encroachment. The design was complicated by an extensive wire-basket rip-rap installation that was constructed seven years previously. A conventional wall would have required foundation excavation through the rip-rap, which would have destroyed the integrity of the installation. Permitting time for the redesigned rip-rap would have impacted the project schedule.

The CTI timber-faced geosynthetic-reinforced wall was selected that could be placed on the ground above the rip-rap and which did not require embedment. Cost for this 16-ft high, 400-ft long wall was estimated at 25% of a conventional concrete cantilever wall, and, perhaps more importantly, the project schedule was maintained.

Highway-82 at Aspen

The City of Aspen, Colorado and the Colorado Department of Transportation (CDOT) constructed a timber-faced geosynthetic-reinforced wall to correct an over-steepened soil cut slope along Highway 82 east of Aspen. The cut was the source of continual sloughing and often produced rocks that rolled onto the roadway.

In order to minimize the height (and therefore, the cost) of the wall, the wall was placed near the roadway. Safety requirements mandate the use of a safety-shape or "Jersey" concrete barrier where fixed objects are placed near the traveled way. The wall was built on this barrier, thus minimizing both cost and space. On this project, the wall was located 8 ft from the edge of the roadway to allow minimal room for a bicycle path.

The wall facing was stepped back 12 in. each 30 in. in height to allow room for plantings, which "softens" the appearance of the wall. A secondary benefit of the steps is that construction/appearance irregularities are much less visible.

The wall was constructed with surplus earth from another City of Aspen project, resulting in a positive cost factor for backfill. The soil was reinforced with a geotextile contributed by Polyfelt, Inc. City of Aspen and CDOT personnel constructed the wall, and utilized ordinary maintenance equipment. The construction procedure was easily learned by the City of Aspen crew.

The City of Aspen saved money by disposing of the low-quality surplus soil in the wall, and the use of existing crews and equipment did not require new funds above those already budgeted. This was a case where the timber-faced geosynthetic-reinforced wall was the only one that could be afforded by either entity. This case history illustrates some of the versatilities of the timber-faced geosynthetic-reinforced wall.

Rockfall Barrier Walls

Over the years, CDOT has aggressively pursued effective and inexpensive methods and structures to arrest falling rock in motion. Research had proven that the CTI timber-faced geosynthetic-reinforced wall is one of the least expensive methods as rockfall barrier.

Such a barrier has two vertical faces, one facing upslope and the other facing downslope occupies the least amount of space which is often very limited on mountainous highways.

The response of the double-faced timber wall to a large, lateral impact force was unknown. There was concern that decoupling or sliding could occur at the interfaces between soil and geotextile. CDOT built a series of the timber-faced walls in 1989 and tested these walls by swinging a 2300-lb rock into them (see Figure 4.4). The rock was suspended on a cable from a crane boom. No tendency to decouple was observed in the test.

In July 1992, CDOT built another instrumented doubled-faced timber wall at the Rifle Rockfall Test Site. The wall was 100 ft long, 10 ft high, and 6 ft across. Rocks up to 6 ft in diameter were rolled into the wall from the cliffs above. Rock velocity and impact energy parameters were determined through subsequent video analyses. The largest rock imparted 1,000,000 ft-lb of impact energy and displaced the wall about 2 ft at the point of impact.

4.2.2 Advantages of the CTI Timber-faced Wall

The CTI geosynthetic-reinforced wall shares all the advantages of the USFS geotextile-reinforced wall outlined in Section 4.1.2 of this Chapter. In addition, the CTI geosynthetic-reinforced wall has three advantages over the USFS geotextile-reinforced wall:

- 1) The construction is simple and rapid as there is no requirement for external forming system for wall construction.



Figure 4.4 Doubled-Faced CTI Timber Wall as Rockfall Barrier

- 2) Since the timber facing offers a moderate degree of local and global compressive and bending resistance, the deformation of the CTI geosynthetic-reinforced wall is typically smaller than that of the USFS geotextile-reinforced wall.
- 3) Where timbers are readily available, the CTI timber-faced geosynthetic-reinforced wall is usually less expensive.

4.2.3 Disadvantages of the CTI Timber-Faced Wall

The CTI geosynthetic-reinforced wall shares most of the disadvantages of the USFS geotextile-reinforced wall described in Section 4.1.3, except:

- 1) Timber must be acquirable at a reasonable cost to make the wall cost-effective.
- 2) The life span of the timber facing tends to dictate the design life of the wall. When the timber is not treated properly, the facing can deteriorated in a short time.
- 3) The timber wall face, although is somewhat more aesthetically pleasing than the face of the USFS geotextile-reinforced wall covered with asphalt products or gunite, does not have the appearance of a "permanent" structure.

4.3 Modular Block Geosynthetic-Reinforced Wall

4.3.1 Advantages of Modular Block Geosynthetic-Reinforced Wall

Modular block geosynthetic-reinforced walls also share all the advantages of the USFS geotextile-reinforced wall outlined in Section 4.1.2. In addition, the modular block geosynthetic-reinforced wall has the following advantages:

- 1) The construction is simple and rapid as there is no requirement for external forming system for wall construction.
- 2) The modular block wall face is durable and aesthetically appealing; the "natural stone" facing gives modular block GRS walls the appearance of a "permanent" structure.
- 3) The wall can be easily adapted to situations where fairly sharp curves are warranted along the length of the wall face.
- 5) Since the concrete blocks offer high *local* compressive and bending resistance, the deformation of modular block geosynthetic-reinforced walls is typically smaller than that of wrapped-faced geosynthetic-reinforced walls.
- 6) A wide variety of modular blocks with different size, shape, weight, texture and color are readily available.

4.3.2 Disadvantages Modular Block Geosynthetic-Reinforced Wall

With the exception of aesthetics, modular block geosynthetic-reinforced wall also shares most of the disadvantages of the USFS geotextile-reinforced wall described in Section 4.1.3. In the construction of modular block geosynthetic-reinforced walls, close attention and control of block placement are required to avoid mis-alignment and uneven batter of the wall face. Moreover, the walls require excavation for a leveling pad which is not required

for most GRS walls; however, the excavation is far less extensive than the construction of concrete cantilever walls.

4.4 Rockery

Where there is an abundant supply of large rocks, rockery can be a cost effective wall system, although it is usually selected primarily for aesthetic reasons. Due to stability considerations, the maximum height of a rockery should not exceed 15 ft. Selection of a rockery implies some level of experience with field constructions. This experience requirement becomes more important as the criticality of the wall increases. Operator's skill level is a major, but non-quantifiable factor in the construction of a rockery.

REFERENCES

- AASHTO Standard Specifications for Highway Bridges*, 15th edition (1992), AASHTO subcommittee on Bridges and Structures.
- Anderson, R.B., Boyd, F.N., and Shaw, L. (1991), "Modular Block Faced Polymer Geogrid Reinforced Soil Walls - U.S. Postal Service Combined Carrier Facility," Proceedings, Geosynthetics '91 Conference, Vol. 2, pp. 889-902.
- Ballegeer, J. P., and Wu, J. T. H. (1993), "Intrinsic Load-Deformation Properties of Geotextiles," Geosynthetic Soil Reinforcement Testing Procedures, ASTM STP 1190, S. C. Jonathan Cheng, Ed., American Society for Testing and Materials, Philadelphia.
- Bell, J.R., Barrett, R.K., and Ruckman, A.C. (1983), "Geotextile Earth Reinforced Retaining Wall Test: Glenwood canyon, Colorado," Transportation Research Record 916, pp. 59-69.
- Berg, R.R. (1991), "The Techniques of Building Highway Retaining Walls," Geotechnical Fabric Report, July/August, pp. 38-43.
- Bonaparte, R., Holtz, R.D. and Giroud, J.P. (1987), "Soil Reinforcement Design Using Geotextiles and Geogrids," Geotextile Testing and the Design Engineer, ASTM STP 952, J.E. Fluet, Jr., Ed., American Society for Testing and Materials, Philadelphia, pp. 69-116.
- Broms, B. B. (1978), "Design of fabric Reinforced Retaining Structures," Proceedings, Symposium on Earth Reinforcement, Pittsburgh, Pennsylvania, pp. 282-304.
- Carpenter, J. (1984), *Slope Stability Analysis with STABLA*, Joint Highway Research Project No. 84-19, School of Civil Engineering, Purdue University, West Lafayette, Indiana.
- Chou, N.N.S. (1992), "Performance of Geosynthetic-reinforced Soil walls," Ph.D. Thesis. Department of Civil Engineering, University of Colorado at Denver, Colorado. 197 pages.
- Chou, N.N.S. and Wu, J.T.H. (1993), *Investigating Performance of Geosynthetic-Reinforced Soil Walls*, Report No. CDOT-UCD-R-93-21, Colorado Department of Transportation, 318 pages.
- Christopher, B.R. and Holtz, R.D. (1985), *Geotextile Engineering Manual*, National Highway Institute, Federal Highway Administration, Contract No. DTFH 61-80-C-00094.
- Christopher, B.R., Gill, S.A., Giroud, J.P., Mitchell, J.K., Schlosser, F. and Dunncliff (1989), *Reinforced Soil Structures, Vol. 1: Design and Construction Guidelines*, FHWA-RD-89-043.

- Claybourn, A.F. and Wu, J.T.H. (1991), "Case History Comparison of Geosynthetic-Reinforced Soil Walls," *Geosynthetics '91*, pp. 485-494.
- Claybourn, A.F. and Wu, J.T.H. (1992), "Failure Loads of the Denver Walls by Current Design Methods," *Proceedings, International Symposium on Geosynthetic-Reinforced Soil Retaining Walls*, Balkema Publishers, Netherlands, pp. 61-77.
- Claybourn, A.F. and Wu, J.T.H. (1993), "Geosynthetic-Reinforced Soil Wall Design," *Geotextiles and Geomembranes*, Vol. 12, pp. 707-724.
- Collin, J.G. (1986), "Earth Wall Design," Ph.D. Thesis, Department of Civil Engineering, University of California, Berkeley, California.
- Duncan, J.M. and Buchignani, A.L. (1975), *An Engineering Manual for Slope Stability Studies*, Department of Civil Engineering, University of California, Berkeley, 83 pages.
- Duncan, J.M., Byrne, P., Wong, K.S., and Mabry, P. (1980), *Strength, Stress-Strain and Bulk Modulus Parameters for Finite Element Analyses of Stresses and Movements in Soil Masses*, Report No. UCB/GT/80-01, Department of Civil Engineering, University of California at Berkeley, 77 pages.
- Elias, V.E. (1990), *Durability/Corrosion of Soil Reinforced Structures*, FHWA-RD-89-186, Washington, D.C.
- Fukuoka, M. (1977), "Some New Methods of Protecting Natural Slope without Disturbing Environment," *Proceedings, International Conference on Soil Mechanics and Foundation Engineering*, Specialty Session 11.
- Giroud, J.P. (1989), "Geotextile Engineering Workshop--Design Examples," GeoService, Inc., Federal Highway Administration Publication No. FHWA-HI-89-002.
- Gourc, J.P., Ratel, A. and Delmas, P. (1986), "Design of Fabric Retaining Walls--the Displacement Method," *Proceedings, 3rd International Conference on Geotextiles*, Vienna, Austria, Vol. IV, pp. 1067-1072.
- Hausmann, M.R. (1990), *Engineering Principles of Ground Modification*, McGraw-Hill Publishing Company, 632 pages.
- Humphrey, D.N. and Holtz, R.D. (1986), *STABL6 with Reinforcing Layer Option - User's Manual*, Joint Highway Research Project, Purdue University, West Lafayette, Indiana.
- Iizuka, A. and Ohta, H. (1987), "A Determination Procedure of Input Parameters in Elasto-Viscoplastic Finite Element Analysis," *Soils & Foundation*, Vol. 27, No. 3, pp. 71-87.

Jewell, R.A. and Milligan, G.W.E. (1989), "Deformation Calculations for Reinforced Soil Walls," Proceedings, 12th International Conference of Soil Mechanics and Foundation Engineering, Rio de Janeiro, pp. 1257-1262.

Jones, C.J.F.P. (1985), *Earth Reinforcement and Soil Structures*, Butterworths Publishers, London, United Kingdom.

Koerner, R.M. (1990), *Designing with Geosynthetics*, Prentice Hall, Englewood Cliffs, N. J. 652 pages.

Leonards, G. A., editor (1962), *Foundation Engineering*, McGraw-Hill Book Co.

Leshchinsky, D. and Perry, E.B. (1987), "A Design Procedure for Geotextile-Reinforced Walls," Proceedings of the Geosynthetics '87 Conference, New Orleans, Vol. 1, pp. 95-107.

Ling, H.I., Wu, J. T. H., and Tatsuoka, F. (1992), "Short-Term Strength and Deformation Characteristics of Geotextiles Under Typical Operational Conditions," *Geotextiles and Geomembranes*, pp. 185-219.

Lizzi, F. (1971), "Special Patented Systems of Underpinning and Subsoil Strengthening by Means of Root Piles (Pali Radice)," Conference Donnee a l' MIT, Boston, Universite de L' Illinois; US Buerau de Reclamation, Denver, USA; Club of Civil Engineers, Vancouver, Canada.

Mitchell, J.K. and Villet, W.C.B. (1987), *Performance of earth Slopes and Embankments*, NCHRP Report No. 290, Transportation Research Board, Washington, D. C.

Moreno, O. A., King, J. L., and McDonald, R. A. (1993), "From a Contractor's Viewpoint: Construction Techniques of a Tiered Modular Block Wall - The Fiesta, Texas Case," Proceedings, Geosynthetics '93 Conference, Vancouver, British Columbia, Canada, pp. 167-180.

NAVFAC, DM-7.2 (1982), Bureau of Yards and Docks, U. S. Navy.

Richardson, G.N. and Bove, J. (1988), "The Use of Construction Fabrics in Retaining Walls and Steep Embankments," Report submitted to Amoco Fabrics and Fibers Company.

Schmertmann, G.R., Chouery-Curtis, V.E., Johnson, R.D. and Bonaparte, R., (1987), "Design Charts for Geogrid-Reinforced Soil Slopes," Proceedings of the Geosynthetics '87 Conference, New Orleans, Vol. 1, pp. 108-120.

Sekiguchi, H. and Ohta, H. (1977), "Induced Anisotropy and Time Dependency in Clays," the 9th International Conference on Soil Mechanics and Foundation Engineering, Tokyo, Japan.

Siegel, R.A. (1975), *STABL User Manual*, Joint Highway research Project No. 75-9, School of Civil Engineering, Purdue University, West Lafayette, Indiana.

Simac, M.R., Bathurst, R.J., Berg, R.R., and Lothspeich, S.E. (1993), *Design Manual for Segmental Retaining Walls*, National Concrete Masonry Association, 336 pages.

Sobhi, S. and Wu, J.T.H. (1994), "A Pullout Interface Formula for Extensible Sheet Reinforcement," submitted to ASCE Geotechnical Journal (under review).

Steward, J.E., Williamson, R., and Mohny, J. (1977, Rev. 1983), *Guidelines for Use of Fabrics in Construction and Maintenance of Low-Volume Roads*, Chapter 5: Earth Reinforcement. USDA, Forest Service.

Steward, J.E. and Mohny, J. (1982), "Trial use Results and Experience for Low Volume Forest Roads," Proceedings, 2nd International Conference on Geotextiles, Las Vegas, Vol. II, pp. 335-340.

Tatsuoka, F., Murata, O. and Tateyama, M (1992), "Permanent Geosynthetic-Reinforced Soil Retaining Walls used for Railway Embankments in Japan," Proceedings, International Symposium on Geosynthetic-Reinforced Soil Retaining Walls, Balkema Publishers, Netherlands, pp. 101-130.

Taylor, D.W. (1948), *Fundamentals of Soil Mechanics*, Wiley, London.

Terzaghi, K. and Peck R. (1967), *Soil Mechanics in Engineering Practice*, John Wiley and Sons, N.Y.

Wu, J. T. H. (1991), "Measuring Inherent Load-Extension Properties of Geotextiles for Design of Reinforced Structures," Geotechnical Testing Journal, GTJODJ, Vol. 14, No. 2, pp. 157-165.

Wu, J.T.H. (1992a), "Predicting Performance of the Denver Walls: General Report," Proceedings, International Symposium on Geosynthetic-Reinforced Soil Retaining Walls, Wu (editor), Balkema Publishers, Netherlands, pp. 3-20.

Wu, J.T.H. (1992b), "Construction and Instrumentation of the Denver Walls," Proceedings, International Symposium on Geosynthetic-Reinforced Soil Retaining Walls, Wu (editor), Balkema Publishers, Netherlands, pp. 21-30.

Wu, J.T.H., Editor (1992c). *Geosynthetic-Reinforced Soil Retaining Walls*. Balkema Publishers, Netherlands, 375 pages.

Wu, J.T.H. and Helwany, M.B. (1994), "A Performance Test for Soil-Geosynthetic Interaction," submitted to Geotextiles and Geomembranes (under review).