

GSM RANGE

(CELLCOM PRIME & IGATE)



 **AES**
G L  B A L

INNOVATIVE SECURITY TECHNOLOGY
WWW.AESGLOBALONLINE.COM



**Powered
by Vodafone**

“Earn £1 per month per GSM install”

Did you know using our optional Vodafone sims can earn you an ongoing revenue of £12 per year as long as the sim remains active?

- Call or email support@aesglobaltelecom.com to be sent sim cards and an information pack.
- The sign up process is easy. Go to www.aesglobaltelecom.com put in your sim number and installer code then pass onto your customer to fill in the payment details.
- We will pay you annually on receipt of an invoice.
- Make programming easier by using our 'Cellcom Prime programmer' app.
- We also have the 'Cellcom Prime' homeowner app to give your end user extra features.

Cellcom**Prime** Advanced GSM Intercom

- Calls your home phone and mobiles on roll-over when a visitor presses the call button.
- Never miss a call with mobile calling.
- Works with standard sim cards on contract or pre pay.
- Built in time clock to set up automatic opening and closing settings on selected time and days.
- Remote programmable keypad so you don't need to be on site to change codes.
- Optional keypad, proximity reader or both.



Set automatic gate open & close times.



Do-not-disturb watershed time.



User history log to your phone.



Illuminated call button and keypad.



Add keypad codes by App.



Issue time restricted codes.



High gain antenna as standard!



2x Relays

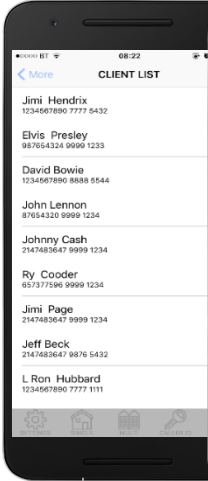

Create a list of all your installs for later editing or diagnostics

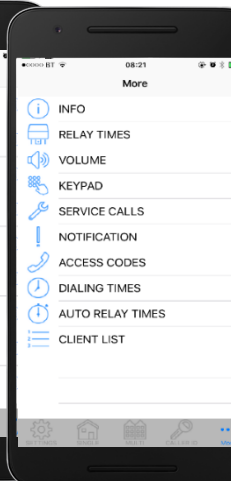

Complete menu of all parameters for editing by app

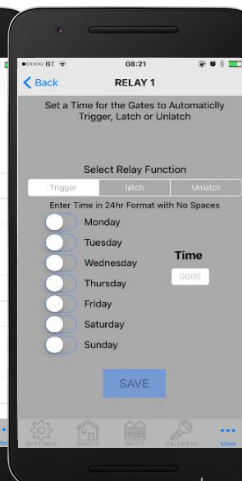

Program auto opening and closing times

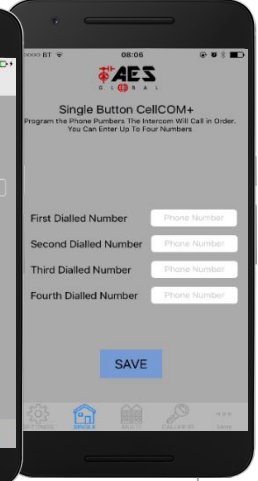

Program phone numbers easily!

Technical Details

Dial Out Numbers	4	Relays	2
Permanent Codes	200	Relay Type	N/C and N/O
Time Restricted Codes	20	Relay Load	2 amps, 24v ac max
Temporary Codes	30	Power Consumption	300mA on dial out, 2amp peak demand
Automatic Trigger Events per Week	40	Modem Models	2G quad band, 3G EU, 3G USA, 4G Europe, 4G USA, 4G AUS/NZ
Caller ID Numbers	100		
Time Restricted Caller ID Numbers	20	Power Supply	12-24v dc (24v dc adaptor included)

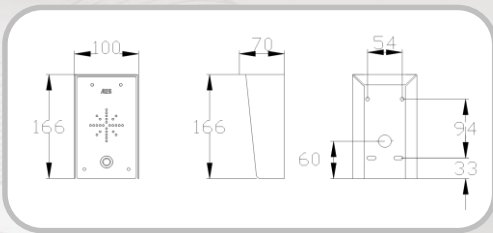

PRIME6-IMP

2G AS STANDARD,
ALSO AVAILABLE IN **3G / 4G**

Ultra stylish all black panel with textured powder coated aluminium hood and gloss black acrylic facia trim over a tough metal back plate. Complete with modern white illuminated push button.

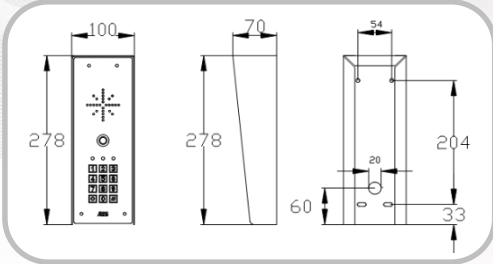

PRIME6-IMPK

2G AS STANDARD,
ALSO AVAILABLE IN **3G / 4G**

Ultra stylish all black panel with textured powder coated aluminium hood and gloss black acrylic facia trim over a tough metal back plate. Complete with modern white illuminated push button and keypad.

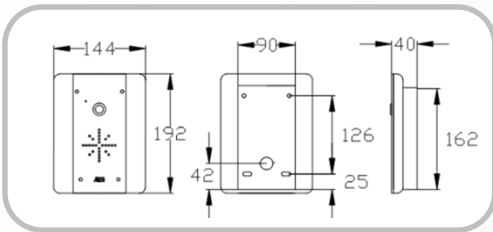

PRIME6-AB

2G AS STANDARD,
ALSO AVAILABLE IN **3G / 4G**

Stylish curved architectural model. Constructed from BS316 marine grade stainless steel and finished with gloss black acrylic trim. Modern blue backlighting.

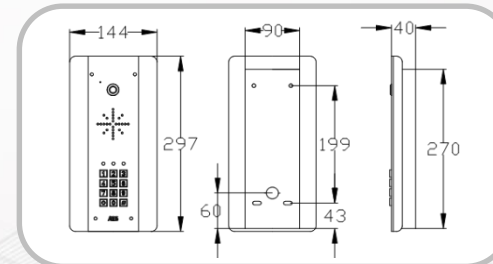

PRIME6-ABK

2G AS STANDARD,
ALSO AVAILABLE IN **3G / 4G**

Stylish curved architectural model. Constructed from BS316 marine grade stainless steel and finished with gloss black acrylic trim. Modern blue backlighting with integrated keypad.

Did you know you can add additional slave keypads and prox readers to these kits?



PRIME6-AS
2G AS STANDARD,
 ALSO AVAILABLE IN **3G/4G**

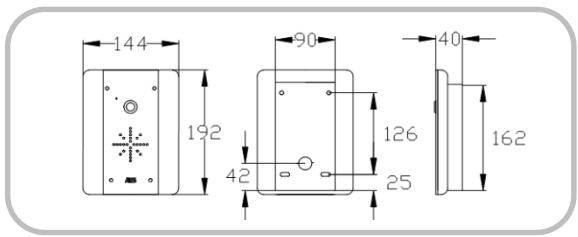

Stylish curved architectural model in an attractive and rugged all brushed BS316 marine grade stainless steel with modern cool white back lighting illumination.



PRIME6-ASK
2G AS STANDARD,
 ALSO AVAILABLE IN **3G/4G**

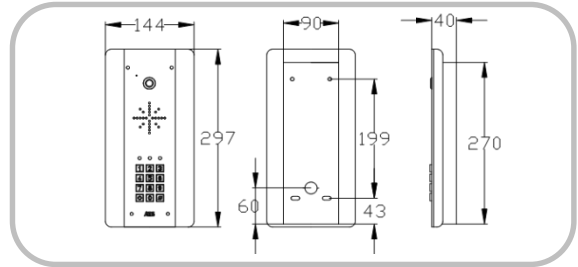

Curved architectural model in an attractive and rugged all brushed BS316 marine grade stainless steel with modern cool white back lighting illumination and integrated keypad.



PRIME6-IMP-PED
2G AS STANDARD,
 ALSO AVAILABLE IN **3G/4G**

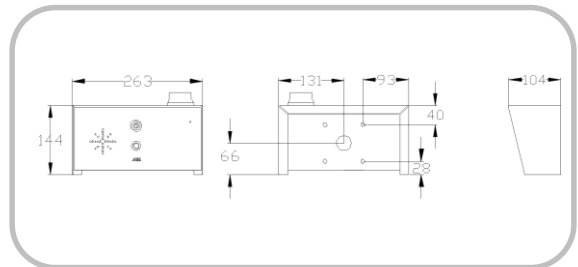

Stylish curved architectural model. Constructed from BS316 marine grade stainless steel and finished with gloss black acrylic trim. Modern blue backlighting with integrated keypad.



PRIME6-IMPK-PED
2G AS STANDARD,
 ALSO AVAILABLE IN **3G/4G**

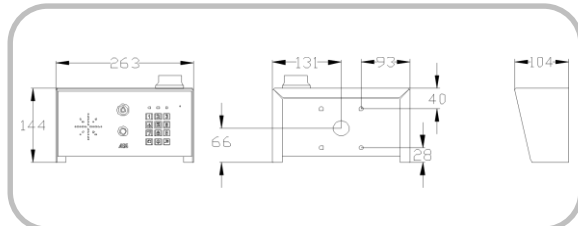

Stylish curved architectural model in an attractive and rugged all brushed BS316 marine grade stainless steel with modern cool white back lighting illumination.

CellcomProx

Advanced GSM Intercom



Set automatic gate open & close times.



Do-not-disturb watershed time.



User history log to your phone.



Add up to 200 cards or tags to intercom remotely by SMS text or app!



Add up to 20 time restricted tags or cards by app!



Add keypad codes by app.



Issue time restricted codes.



High gain antenna as standard!

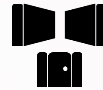

2x Relays.

Technical Details

Dial Out Numbers	4	Relays	2
Permanent Codes	200	Relay Type	N/C and N/O
Time Restricted Codes	20	Relay Load	2 amps 24v ac max
Temporary Codes	30	Power Consumption	300mA on dial out, 2amp peak demand
Automatic Trigger Events per Week	40	Modem Models	2G quad band, 3G EU, 3G USA, 4G Europe, 4G USA, 4G AUS/NZ
Caller ID Numbers	100	Tag/Card Type	125kHz fixed digit code card, passive type
Time Restricted Caller ID Numbers	20	Tag/Card Quantity	200 permanent, 20 time restricted, 30 temporary users
Power Supply	12-24v dc (24v dc adaptor included)		



2G
AS STANDARD,
ALSO AVAILABLE IN
3G /4G

▶ **PRIME6-PX-IMP**

Ultra stylish all black panel with textured powder coated aluminium hood and gloss black acrylic facia trim over a tough metal back plate. Complete with modern white illuminated push button and integrated Prox reader. Kits complete with 3 proximity cards with additional cards available to purchase. Also available with modern white illuminated push button and keypad.



2G
AS STANDARD,
ALSO AVAILABLE IN
3G /4G

▶ **PRIME6-PX-IMPK**



2G
AS STANDARD,
ALSO AVAILABLE IN
3G /4G

▶ **PRIME6-PX-AB**

Stylish curved architectural model. Constructed from BS316 marine grade stainless steel and finished with gloss black acrylic trim. Complete with modern blue illuminated push button and integrated Prox reader. Kits complete with 3 proximity cards with additional cards available to purchase. Also available with modern white illuminated push button and keypad.



2G
AS STANDARD,
ALSO AVAILABLE IN
3G /4G

▶ **PRIME6-PX-ABK**



2G
AS STANDARD,
ALSO AVAILABLE IN
3G /4G

▶ **PRIME6-PX-AS**

Stylish curved architectural model. Constructed from BS316 marine grade stainless steel. Complete with white illuminated push button and integrated Prox reader. Kits complete with 3 proximity cards with additional cards available to purchase. Also available with modern white illuminated push button and keypad.



2G
AS STANDARD,
ALSO AVAILABLE IN
3G /4G

▶ **PRIME6-PX-ASK**



▶ **PROXCARD-125K-AES**

Single Proximity Card

- 125KHz fixed 10 digit code Card.
- Add to intercom remotely by SMS text or APP.
- Also available in packs of 10 & 50.

Did you know you can add additional slave keypads and prox readers to these kits?

CellcomPrime

Slave Devices

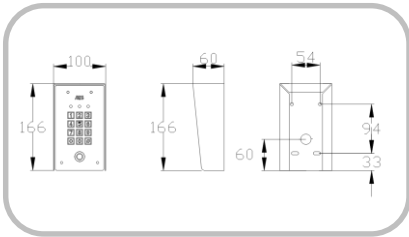

PRIME-SLV-KP-IMP

Imperial Slave Keypad.
Works with any "PRIME6-" product.
Compatible with Multi-Classic and Multi-Lite kits.

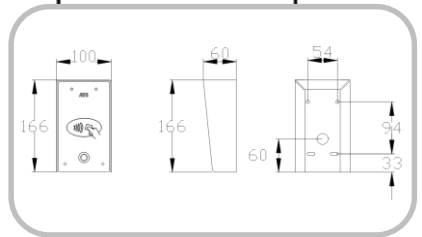

PRIME-SLV-PX-IMP

Imperial Slave Prox Reader.
Works with any "PRIME6-" product.

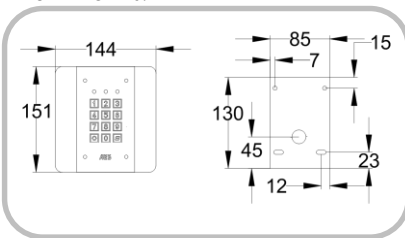

PRIME-SLV-KP-AB

Architectural Slave Keypad.
Works with any "PRIME6-" product.
Compatible with Multi-Classic and Multi-Lite kits.

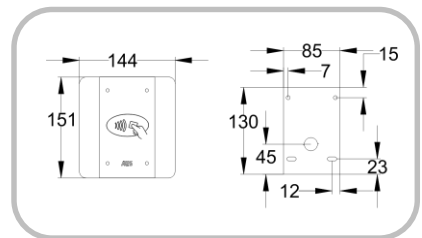

PRIME-SLV-PX-AB

Architectural Slave Prox Reader.
Works with any "PRIME6-" product.
Compatible with Multi-Classic and Multi-Lite kits.

CellcomPrime Multi Button System

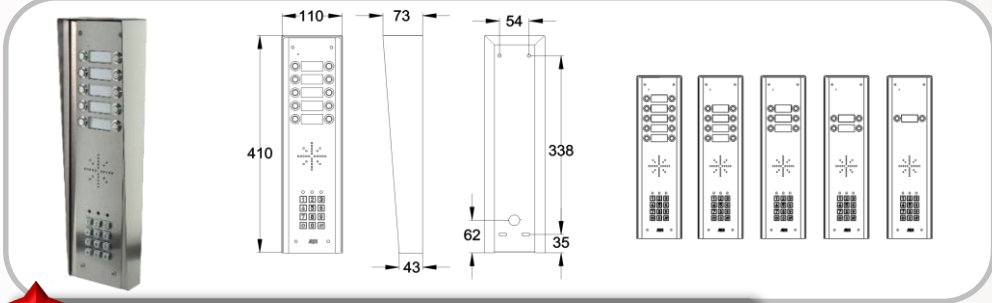
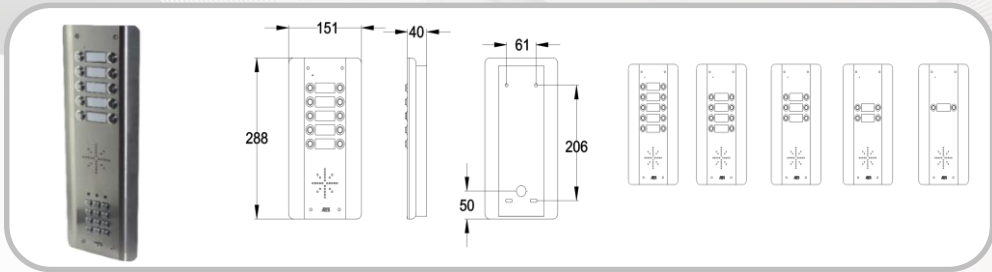
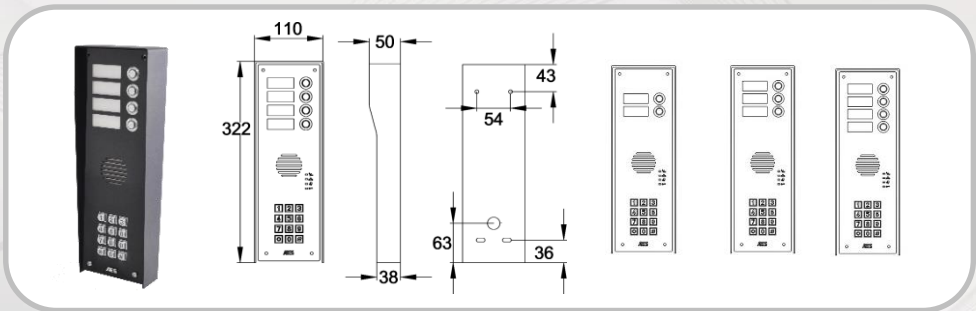

Look out for our new modular intercom, replacing these models in late 2019

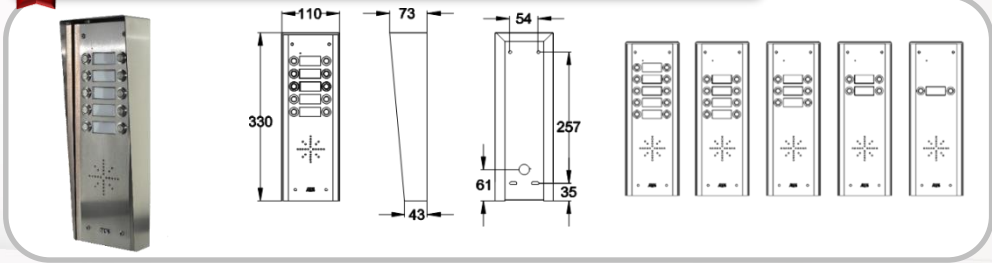

PRIME6-XX N / YYY

- IMPK** = Hooded Imperial & Keypad
- ASK** = Architectural Stainless & Keypad
- HS** = Hooded Stainless
- HSK** = Hooded Stainless & Keypad

- 2** = two button
- 4** = four button
- 6** = six button
- 8** = eight button
- 10** = ten button

- Nothing = 2G model
- 3GE** = Euro 2G/3G model
- 4GE** = Euro 2G/4G model
- 4GA** = USA 3G/4G model
- 4GSA** = AU/NZ 3G/4G model

Did you know you can add additional slave keypads and prox readers to these kits?

i-GATE PRIME

Advanced GSM Gate Opener

Now includes
7 day time
clock



Activity log
feature added



igate-PRIME	2G only
igate-PRIME/3GE	Dual 3G/2G capability (Europe)
igate-PRIME/4GE	4G capability (Europe) 3G/4G

- GSM gate opener with IOS & Android apps.
- Stores up to 100 numbers for caller ID access (ring gates to open).
- Trigger, latch and unlatch gates by SMS text or with app.
- 2 x Volt free momentary relay outputs.
- Simple programming by SMS text or app.
- Check if gates are opened or closed!
- Can also ring 4 phones when alarm or gates are triggered.
- Check stored numbers by SMS.
- Auto call feature to schedule outgoing call (prevents SIM card being deactivated).

Technical Details

Power	12-24v ac/dc
Current	45mA standby. 200mA when called
Weather Rating	IP67
Relay Load	24v ac, 2 amps max
Relay Type	N/C and N/O. Latching & momentary

Multicom

CLASSIC



4G
LTE Ready



- ▶ **MULTI-CLASSIC-SSK/4GE**
Hooded, all stainless model in marine grade stainless steel, with keypad
- ▶ **MULTI-CLASSIC-IMPK/4GE**
Sleek, all black panel, marine grade stainless steel, powder coated aluminium hood and gloss black acrylic faceplate, with keypad.
- ▶ **MULTI-CLASSIC-PROX-IMPK/4GE**
Sleek, all black panel, marine grade stainless steel, powder coated aluminium hood and gloss black acrylic faceplate, with keypad and prox reader.
- ▶ **MULTI-CLASSIC-FSK/4GE**
Flush model in marine grade stainless steel, with gloss black acrylic faceplate, with keypad.

- Calls up to 500 families from a single SIM card.
- Visitors can scroll for residents, or enter apartment number to call.
- Dials up to 3 phone numbers per family on roll over.
- 4G Ready.
- HD voice with VOLTE*.
- Programme via app or software

Did you know you can add additional slave keypads and prox readers to these kits?

Multicom

LITE & Mini



Welcome to 232 Washington Drive Apartments

1. Jones	11 Harrington
2. Smith	12. Waters
3. Edens	13. Anderson
4. Murray	14. Boucher
5. Hopper	15. White
6. Hargrove	16. Evans
7. Byers	17. Owens
8. Hermann	18. Brown
9. Radfield	19. Rooney
10. Flintoff	20. Potter

To CALL, enter Apartment number, then press #
To open, enter door code, then press *

Welcome to 232 Washington Drive Apartments

Installer LOGO

To CALL, enter Apartment number, then press #
To open, enter door code, then press *

- ▶ Customisable name directory – free template downloadable from our website: www.aesglobalonline.com/downloads
- ▶ Free programming app downloadable from the App Store and Google Play store.



- ▶ MULTI-LITE-IMP/4GE
- ▶ MULTI-MINI-IMP/4GE
- ▶ MULTI-LITE-PROX-IMP/4GE



- **Multicom Life** - 4G LTE capable, GSM multiapartment intercom.
- Programmable remotely by free APP.
- Up to 30 family using illuminated directory screen, or up to 100 family direct dialling from the keypad.
- **Multicom mini** - 4G GSM multi-apartment intercom, in imperial finish.
- Up to 20 family direct dialling from the keypad.
- Features an illuminated nameplate with led indicators and illuminated keypad.

Did you know you can add additional slave keypads and prox readers to these kits?

Did you know AES offer free installer or distribution training either at our Aylesbury branch or we can come to you. Contact us for more information.
 Email: sales@aesglobalonline.com | Tel: 01296 821 844

