

Rexroth IndraDrive Drive Controllers Power Sections HCS01

R911325518
Edition 06

Instruction Manual



Title Rexroth IndraDrive
Drive Controllers
Power Sections HCS01

Type of Documentation Instruction Manual

Document Typecode DOK-INDRV*-HCS01*UL***-IB06-EN-P

Internal File Reference RS-49e64cb2ef966abc0a6846a001598e31-8-en-US-2

Record of Revision

Edition	Release Date	Notes
DOK-INDRV*-HCS01*UL***-IB01-EN-P	09/2009	First edition
DOK-INDRV*-HCS01*UL***-IB02-EN-P	07/2010	Corrected edition
DOK-INDRV*-HCS01*UL***-IB03-EN-P	05/2011	Corrected edition
DOK-INDRV*-HCS01*UL***-IB04-EN-P	01/2012	Corrected edition
DOK-INDRV*-HCS01*UL***-IB05-EN-P	05/2012	Corrected edition
DOK-INDRV*-HCS01*UL***-IB06-EN-P	05/2014	Corrected edition

Purpose of Documentation This documentation provides information on the installation and operation of the described products, by persons trained and qualified to work with electrical installations.

Copyright © Bosch Rexroth AG 2014

This document, as well as the data, specifications and other information set forth in it, are the exclusive property of Bosch Rexroth AG. It may not be reproduced or given to third parties without its consent.

Liability The specified data is intended for product description purposes only and shall not be deemed to be a guaranteed characteristic unless expressly stipulated in the contract. All rights are reserved with respect to the content of this documentation and the availability of the product.

Published by Bosch Rexroth AG
Bgm.-Dr.-Nebel-Str. 2 ■ 97816 Lohr a. Main, Germany
Phone +49 9352 18 0 ■ Fax +49 9352 18 8400
<http://www.boschrexroth.com/>
DC-IA/EDY4 (CR)

Table of Contents

	Page
1 Important Notes.....	3
1.1 Safety Instructions.....	3
1.1.1 General Information.....	3
1.1.2 Protection Against Contact with Electrical Parts and Housings.....	4
1.1.3 Battery Safety.....	5
1.2 Appropriate Use.....	6
2 Ratings and Dimensions.....	7
2.1 Data.....	7
2.2 Dimensional Drawings.....	11
3 Documentations.....	15
3.1 Motors.....	15
4 Instructions for Use.....	17
4.1 Overcurrent Protection.....	17
4.2 Connection.....	18
4.2.1 Connection Diagram.....	18
4.2.2 Connection Points.....	19
5 Service and Support.....	21
Index.....	23

1 Important Notes

1.1 Safety Instructions

1.1.1 General Information

- Do not attempt to install and operate the components of the electric drive and control system without first reading all documentation provided with the product. Read and understand these safety instructions and all user documentation prior to working with these components. If you do not have the user documentation for the components, contact your responsible Rexroth sales partner. Ask for these documents to be sent immediately to the person or persons responsible for the safe operation of the components.
- If the supplied documents contain some information you do not understand, it is absolutely necessary that you ask Rexroth for explanation before you start working at or with the components.
- If the component is resold, rented and/or passed on to others in any other form, these safety instructions must be delivered with the component in the official language of the user's country.
- Only qualified persons may work with components of the electric drive and control system or within its proximity.

In terms of this Instruction Manual, qualified persons are those persons who are familiar with the installation, mounting, commissioning and operation of the components of the electric drive and control system, as well as with the hazards this implies, and who possess the qualifications their work requires. To comply with these qualifications, it is necessary, among other things,

- to be trained, instructed or authorized to switch electric circuits and components safely on and off, to ground them and to mark them,
- to be trained or instructed to maintain and use adequate safety equipment,
- to attend a course of instruction in first aid.
- The technical data, connection and installation conditions of the components are specified in the respective application documentations and must be followed at all times.
- If the components take the form of hardware, then they must remain in their original state, in other words, no structural changes are permitted. It is not permitted to decompile software components or alter source codes.
- Do not mount damaged or faulty components or use them in operation.
- Only use accessories and spare parts approved by Rexroth.
- Follow the safety regulations and requirements of the country in which the electric components of the electric drive and control system are operated.
- Proper and correct transport, storage, mounting and installation, as well as care in operation and maintenance, are prerequisites for optimal and safe operation of the component.

Improper use of these components, failure to follow the safety instructions in this document or tampering with the product, including disabling of safety devices, could result in property damage, injury, electric shock or even death.

Important Notes

1.1.2 Protection Against Contact with Electrical Parts and Housings



This section concerns components of the electric drive and control system with voltages of **more than 50 volts**.

Contact with parts conducting voltages above 50 volts can cause personal danger and electric shock. When operating components of the electric drive and control system, it is unavoidable that some parts of these components conduct dangerous voltage.

High electrical voltage! Danger to life, risk of injury by electric shock or serious injury!

- Only qualified persons are allowed to operate, maintain and/or repair the components of the electric drive and control system.
- Follow the general installation and safety regulations when working on power installations.
- Before switching on, the equipment grounding conductor must have been permanently connected to all electric components in accordance with the connection diagram.
- Even for brief measurements or tests, operation is only allowed if the equipment grounding conductor has been permanently connected to the points of the components provided for this purpose.
- Before accessing electrical parts with voltage potentials higher than 50 V, you must disconnect electric components from the mains or from the power supply unit. Secure the electric component from reconnection.
- With electric components, observe the following aspects:
 - Always wait **30 minutes** after switching off power to allow live capacitors to discharge before accessing an electric component. Measure the electrical voltage of live parts before beginning to work to make sure that the equipment is safe to touch.
- Install the covers and guards provided for this purpose before switching on.
- Never touch electrical connection points of the components while power is turned on.
- Do not remove or plug in connectors when the component has been powered.
- Under specific conditions, electric drive systems can be operated at mains protected by residual-current-operated circuit-breakers sensitive to universal current (RCDs/RCMs).
- Secure built-in devices from penetrating foreign objects and water, as well as from direct contact, by providing an external housing, for example a control cabinet.

High housing voltage and high leakage current! Danger to life, risk of injury by electric shock!

- Before switching on and before commissioning, ground or connect the components of the electric drive and control system to the equipment grounding conductor at the grounding points.

Important Notes

- Connect the equipment grounding conductor of the components of the electric drive and control system permanently to the main power supply at all times. The leakage current is greater than 3.5 mA.
- Establish an equipment grounding connection with a minimum cross section according to the table below. With an outer conductor cross section smaller than 10 mm² (8 AWG), the alternative connection of two equipment grounding conductors is allowed, each having the same cross section as the outer conductors.

Cross section outer conductor	Minimum cross section equipment grounding conductor Leakage current ≥ 3.5 mA	
	1 equipment grounding conductor	2 equipment grounding conductors
1.5 mm ² (16 AWG)	10 mm ² (8 AWG)	2 × 1.5 mm ² (16 AWG)
2.5 mm ² (14 AWG)		2 × 2.5 mm ² (14 AWG)
4 mm ² (12 AWG)		2 × 4 mm ² (12 AWG)
6 mm ² (10 AWG)		2 × 6 mm ² (10 AWG)
10 mm ² (8 AWG)		-
16 mm ² (6 AWG)	16 mm ² (6 AWG)	-
25 mm ² (4 AWG)		-
35 mm ² (2 AWG)		-
50 mm ² (1/0 AWG)	25 mm ² (4 AWG)	-
70 mm ² (2/0 AWG)	35 mm ² (2 AWG)	-
...

Tab. 1-1: Minimum Cross Section of the Equipment Grounding Connection

1.1.3 Battery Safety

Batteries consist of active chemicals in a solid housing. Therefore, improper handling can cause injury or property damage.

Risk of injury by improper handling!

- Do not attempt to reactivate low batteries by heating or other methods (risk of explosion and cauterization).
- Do not attempt to recharge the batteries as this may cause leakage or explosion.
- Do not throw batteries into open flames.
- Do not dismantle batteries.
- When replacing the battery/batteries, do not damage the electrical parts installed in the devices.
- Only use the battery types specified for the product.

Important Notes



Environmental protection and disposal! The batteries contained in the product are considered dangerous goods during land, air, and sea transport (risk of explosion) in the sense of the legal regulations. Dispose of used batteries separately from other waste. Observe the national regulations of your country.

1.2 Appropriate Use

This product may only be used for the mentioned applications under the specified application, ambient and operating conditions.

This product is exclusively intended for use in machines and systems in an industrial environment. This is to be understood as applications according to IEC 60204-1 "Safety of machinery, Electric equipment of machines" and NFPA 79 "Electrical Standard for Industrial Machinery".



Components of the Rexroth IndraDrive Cs system are **products of category C3** (with limited availability) according to IEC 61800-3. To ensure that this category (limit values) is maintained, suitable line filters must be used in the drive system.

These components are not provided for use in a public low-voltage network supplying residential areas with power. If these components are used in such a public network, high-frequency interference is to be expected. This can require additional measures of radio interference suppression.

2 Ratings and Dimensions

2.1 Data

UL Ratings and Dimensions

Description	Symbol	Unit	HCS01.1E -W0003- _02	HCS01.1E -W0006- _02	HCS01.1E -W0009- _02	HCS01.1E -W0013- _02	HCS01.1E -W0018- _02	
Listing in accordance with UL standard			UL 508C					
Listing in accordance with CSA standard			C22.2 No. 14-10					
UL files			E134201					
Pollution degree			2					
Ambient temperature with nominal data	T _{amax}	°C	40					
Ambient temperature with reduced nominal data	T _{amax_red}	°C	55					
Mass	m	kg	0,72				1,70	
Device height ¹⁾	H	mm	215				268	
Device depth ²⁾	T	mm	196					
Device width ³⁾	B	mm	50				70	
Minimum distance on the top of the device ⁴⁾	d _{top}	mm	90					
Minimum distance on the bottom of the device ⁵⁾	d _{bot}	mm	90					
Horizontal spacing on the device ⁶⁾	d _{hor}	mm	10				0	
Rated control voltage input ⁷⁾	U _{N3}	V	24 ± 20%					
Rated power consumption control voltage input at U _{N3} ⁸⁾	P _{N3}	W	27	28		34		
Short circuit current rating	SCCR	A rms	42000					
Rated input voltage, power ⁹⁾	U _{LN_nenn}	V	1 or 3 x AC 110...230					
Tolerance U _{LN}		%	± 10					
Mains frequency	f _{LN}	Hz	50...60					
Tolerance input frequency		Hz	± 2					
Rated input current	I _{LN}	A	1.8 or 0.6	2.8 or 1.2	5.0 or 2.3	8.3 or 4.5	12.8 or 9.6	
Branch circuit protection fuse ¹⁰⁾			2.5 or 1.0	3.5 or 2.0	7.0 or 3.0	12.0 or 5.0	17.5 or 15.0	
Last modification: 2013-12-12								

Ratings and Dimensions

Description	Symbol	Unit	HCS01.1E -W0003- _02	HCS01.1E -W0006- _02	HCS01.1E -W0009- _02	HCS01.1E -W0013- _02	HCS01.1E -W0018- _02
Required wire size in accordance with NFPA 79 and UL 508 A (internal wiring); ¹¹⁾	A _{LN}	AWG	AWG 14				
Field wiring material (material; conductor temperature; class)			Cu; 60/75 °C; 1				
Output voltage	U _{out}	V	3 x AC 0...230				
Output current	I _{out}	A	1,1	2,0	3,0	4,5	7,6
Output frequency range ¹²⁾	f _{out}	Hz	0...1600				
Power dissipation at continuous current and continuous DC bus power respectively ¹³⁾	P _{Diss_cont}	W	8,00	10,00	12,00	20,00	70,00
Last modification: 2013-12-12							

- 1) 2) 3)
4) 5) 6)
7)
8)
- Housing dimension; see also related dimensional drawing
See fig. "Air Intake and Air Outlet at Device"
Observe supply voltage for motor holding brakes
HMS, HMD, HCS: Plus motor holding brake and control section; HCS01: Incl. control section, plus safety option; KCU: Max. power consumption from 24V supply; KSM: Incl. motor holding brake (if available), plus power consumption of externally connected inputs/outputs, plus safety option; KMS: Plus motor holding brake, plus power consumption of externally connected inputs/outputs, plus safety option
- 9) Mains input L1, L2, L3 (for HMV and HCS only); For use on a solidly grounded wye source only.
- 10) Use listed AC input line fuses (class J; 600 V AC). Suitable for use on a circuit capable of delivering not more than 42000 rms symmetrical amperes, 500 Volts maximum (HMV and HCS04.2 480 Volts maximum). If using inverse-time circuit breakers or type E combination motor controllers instead of recommended fuses, see UL 508C section 45.8.2.
- 11) Copper wire; PVC-insulation (conductor temperature 90 °C; T_a ≤ 40 °C) in accordance with NFPA 79 chapter 12 and UL 508A chapter 28
- 12) Depending on switching frequency which was set in parameter P-0-0001
- 13) Plus dissipation of braking resistor and control section
- Tab. 2-1: HCS - UL Ratings and Dimensions

UL Ratings and Dimensions

Description	Symbol	Unit	HCS01.1E -W0005- _03	HCS01.1E -W0008- _03	HCS01.1E -W0018- _03	HCS01.1E -W0028- _03	HCS01.1E -W0054- _03
Listing in accordance with UL standard			UL 508C				
Listing in accordance with CSA standard			C22.2 No. 14-10				
Last modification: 2013-12-12							

Ratings and Dimensions

Description	Symbol	Unit	HCS01.1E -W0005- _03	HCS01.1E -W0008- _03	HCS01.1E -W0018- _03	HCS01.1E -W0028- _03	HCS01.1E -W0054- _03
UL files			E134201				
Pollution degree			2				
Ambient temperature with nominal data	T _{amax}	°C	40				
Ambient temperature with reduced nominal data	T _{amax_red}	°C	55				
Mass	m	kg	0,72		1,70		4,22
Device height ¹⁾	H	mm	215		268		
Device depth ²⁾	T	mm	196				
Device width ³⁾	B	mm	50		70		130
Minimum distance on the top of the device ⁴⁾	d _{top}	mm	90				
Minimum distance on the bottom of the device ⁵⁾	d _{bot}	mm	90				
Horizontal spacing on the device ⁶⁾	d _{hor}	mm	10		0		
Rated control voltage input ⁷⁾	U _{N3}	V	24 ± 20%				
Rated power consumption control voltage input at U _{N3} ⁸⁾	P _{N3}	W	27	28	34		45
Short circuit current rating	SCCR	A rms	42000				
Rated input voltage, power ⁹⁾	U _{LN_nenn}	V	3 x AC 200...500				
Tolerance U _{LN}		%	± 10				
Mains frequency	f _{LN}	Hz	50...60				
Tolerance input frequency		Hz	± 2				
Rated input current	I _{LN}	A	1,5	2,5	5,0	10,0	28,0
Branch circuit protection fuse ¹⁰⁾			2	4	10	15	30
Required wire size in accordance with NFPA 79 and UL 508 A (internal wiring); ¹¹⁾	A _{LN}	AWG	AWG 14				AWG 10
Field wiring material (material; conductor temperature; class)			Cu; 60/75 °C; 1				
Output voltage	U _{out}	V	3 x AC 0...500				
Output current	I _{out}	A	1,7	2,7	7,6	11,5	21,0
Output frequency range ¹²⁾	f _{out}	Hz	0...1600				
Power dissipation at continuous current and continuous DC bus power respectively ¹³⁾	P _{Diss_cont}	W	37,00	46,00	80,00	120,00	400,00

Last modification: 2013-12-12

1) 2) 3) Housing dimension; see also related dimensional drawing

Ratings and Dimensions

- 4) 5) 6) See fig. "Air Intake and Air Outlet at Device"
- 7) Observe supply voltage for motor holding brakes
- 8) HMS, HMD, HCS: Plus motor holding brake and control section; HCS01: Incl. control section, plus safety option; KCU: Max. power consumption from 24V supply; KSM: Incl. motor holding brake (if available), plus power consumption of externally connected inputs/outputs, plus safety option; KMS: Plus motor holding brake, plus power consumption of externally connected inputs/outputs, plus safety option
- 9) Mains input L1, L2, L3 (for HMV and HCS only); For use on a solidly grounded wye source only.
- 10) Use listed AC input line fuses (class J; 600 V AC). Suitable for use on a circuit capable of delivering not more than 42000 rms symmetrical amperes, 500 Volts maximum (HMV and HCS04.2 480 Volts maximum). If using inverse-time circuit breakers or type E combination motor controllers instead of recommended fuses, see UL 508C section 45.8.2.
- 11) Copper wire; PVC-insulation (conductor temperature 90 °C; $T_a \leq 40$ °C) in accordance with NFPA 79 chapter 12 and UL 508A chapter 28
- 12) Depending on switching frequency which was set in parameter P-0-0001
- 13) Plus dissipation of braking resistor and control section

Tab. 2-2: HCS - UL Ratings and Dimensions

Distances

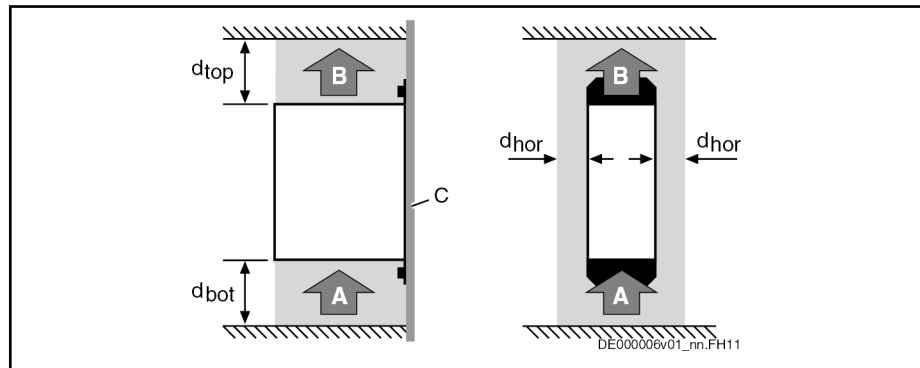

- A Air intake
- B Air outlet
- C Mounting surface in control cabinet
- d_{top} Distance top
- d_{bot} Distance bottom
- d_{hor} Distance horizontal

Fig. 2-1: Air Intake and Air Outlet at Device

2.2 Dimensional Drawings

HCS01.1E-W0003/5/6/8/9/13 Standard mounting:

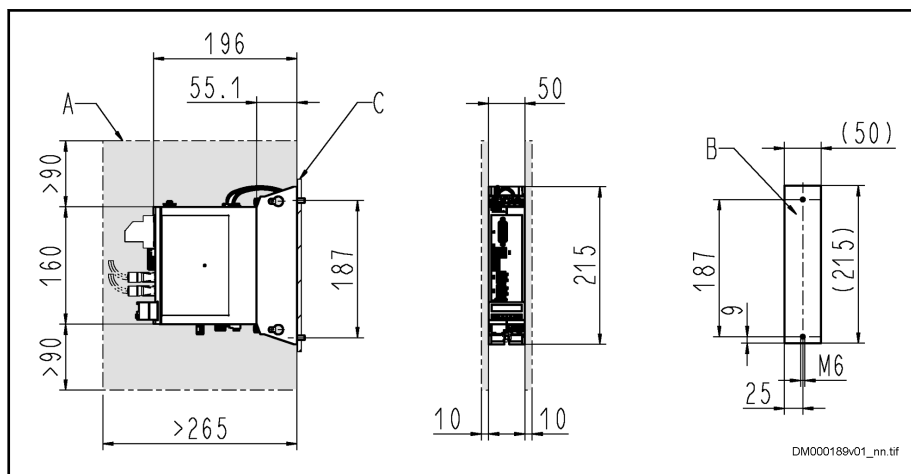

- A** Minimum mounting clearance
- B** Boring dimensions
- C** Mounting surface

Fig. 2-2: Dimensional Drawing HCS01.1E-W0003/5/6/8/9/13 (Standard Mounting)

Left-hand or right-hand mounting:

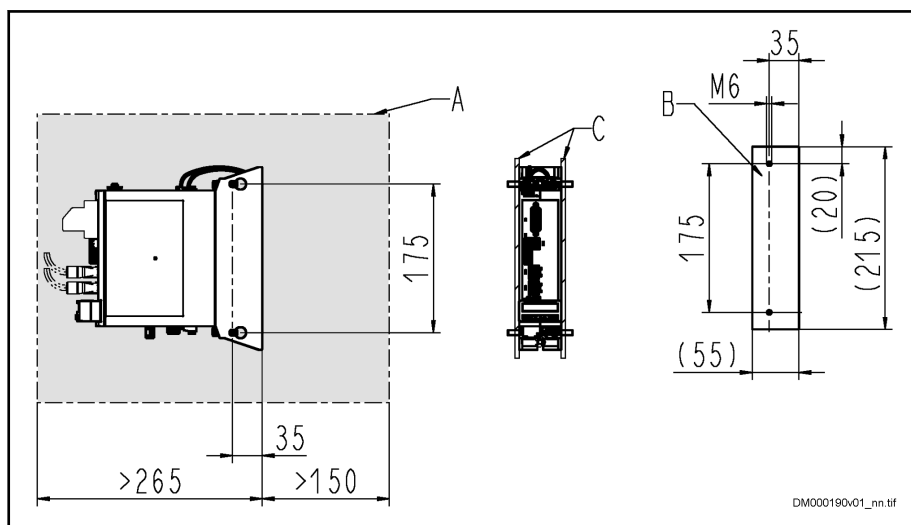

- A** Minimum mounting clearance
- B** Boring dimensions
- C** Mounting surface

Fig. 2-3: Dimensional Drawing HCS01.1E-W0003/5/6/8/9/13 (Left-Hand or Right-Hand Mounting)

Ratings and Dimensions

HCS01.1E-W0018/28 Standard mounting:

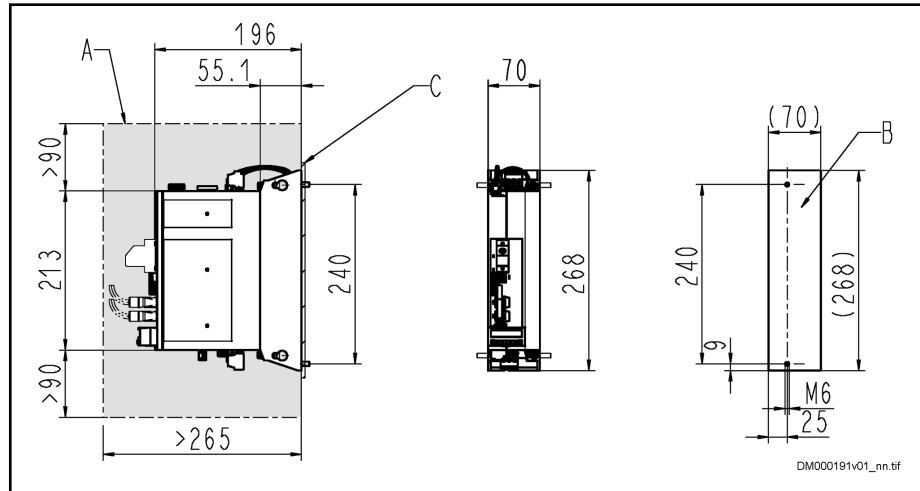

- A** Minimum mounting clearance
- B** Boring dimensions
- C** Mounting surface

Fig. 2-4: Dimensional Drawing HCS01.1E-W0018/28 (Standard Mounting)

Left-hand or right-hand mounting:

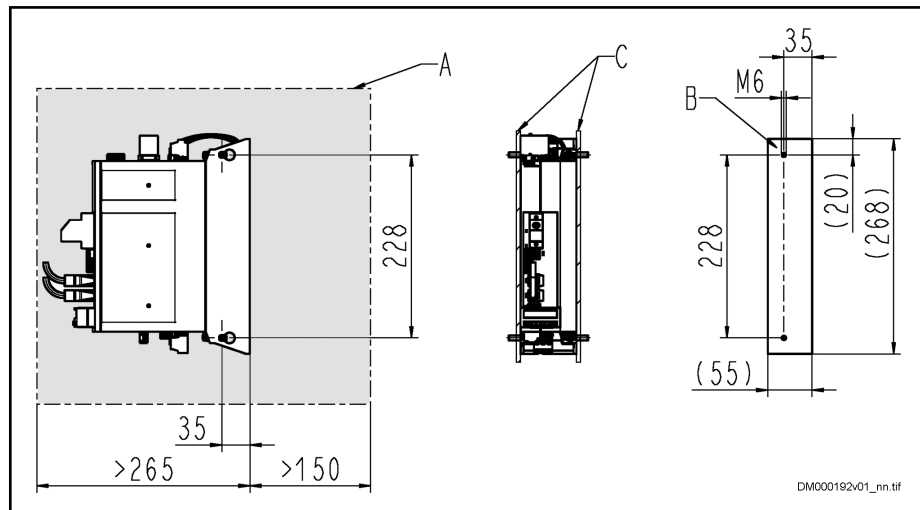

- A** Minimum mounting clearance
- B** Boring dimensions
- C** Mounting surface

Fig. 2-5: Dimensional Drawing HCS01.1E-W0018/28 (Left-Hand or Right-Hand Mounting)

Ratings and Dimensions

HCS01.1E-W0054 Standard mounting:

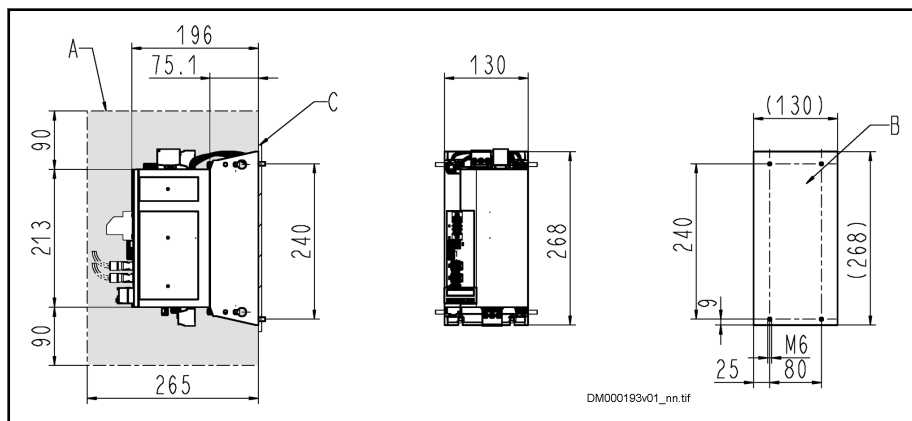

- A** Minimum mounting clearance
- B** Boring dimensions
- C** Mounting surface

Fig. 2-6: Dimensional Drawing HCS01.1E-W0054 (Standard Mounting)

Left-hand or right-hand mounting:

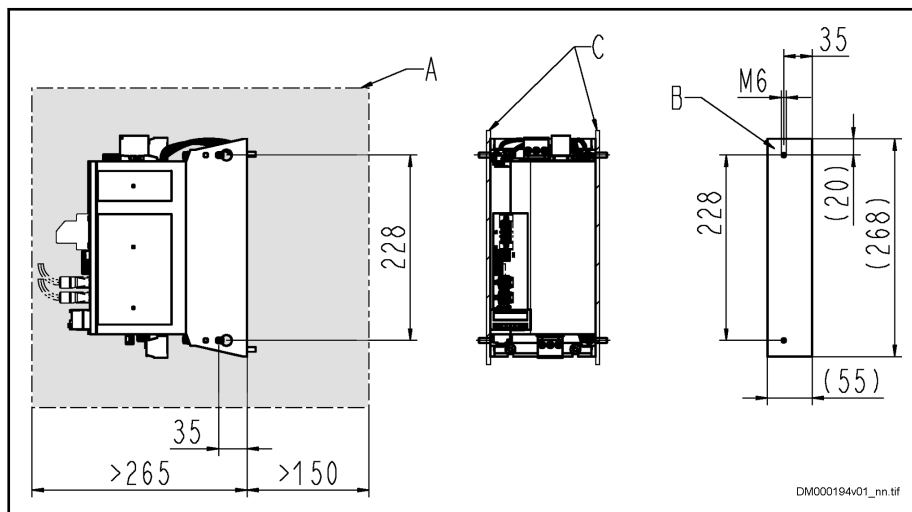

- A** Minimum mounting clearance
- B** Boring dimensions
- C** Mounting surface

Fig. 2-7: Dimensional Drawing HCS01.1E-W0054 (Left-Hand or Right-Hand Mounting)

3 Documentations

3.1 Motors

Title Rexroth IndraDyn ...	Kind of documentation	Document typecode ¹⁾ DOK-MOTOR*-*...	Material number R911...
A Asynchronous Motors MAD / MAF	Project Planning Manual	MAD/MAF****-PRxx-EN-P	295781
H Synchronous Kit Spindle Motors	Project Planning Manual	MBS-H*****-PRxx-EN-P	297895
L Synchronous Linear Motors	Project Planning Manual	MLF*****-PRxx-EN-P	293635
L Ironless Linear Motors MCL	Project Planning Manual	MCL*****-PRxx-EN-P	330592
S Synchronous Motors MKE	Project Planning Manual	MKE*GEN2***-PRxx-EN-P	297663
S Synchronous Motors MSK	Project Planning Manual	MSK*****-PRxx-EN-P	296289
S Synchronous Motors MSM	Data Sheet	MSM*****-DAxx-EN-P	329338
S Synchronous Motors QSK	Project Planning Manual	QSK*****-PRxx-EN-P	330321
T Synchronous Torque Motors	Project Planning Manual	MBT*****-PRxx-EN-P	298798

1) In the document typecodes, "xx" is a wild card for the current edition of the documentation (example: PR01 is the first edition of a Project Planning Manual)

Tab. 3-1: Documentations – Motors

4 Instructions for Use

4.1 Overcurrent Protection

Protect the components against overcurrent:

- Branch circuit protection has to be provided externally
- Dimension the branch circuit protection according to the data "Branch circuit protection fuse" (see Ratings and Dimensions)

Instructions for Use

4.2 Connection

4.2.1 Connection Diagram

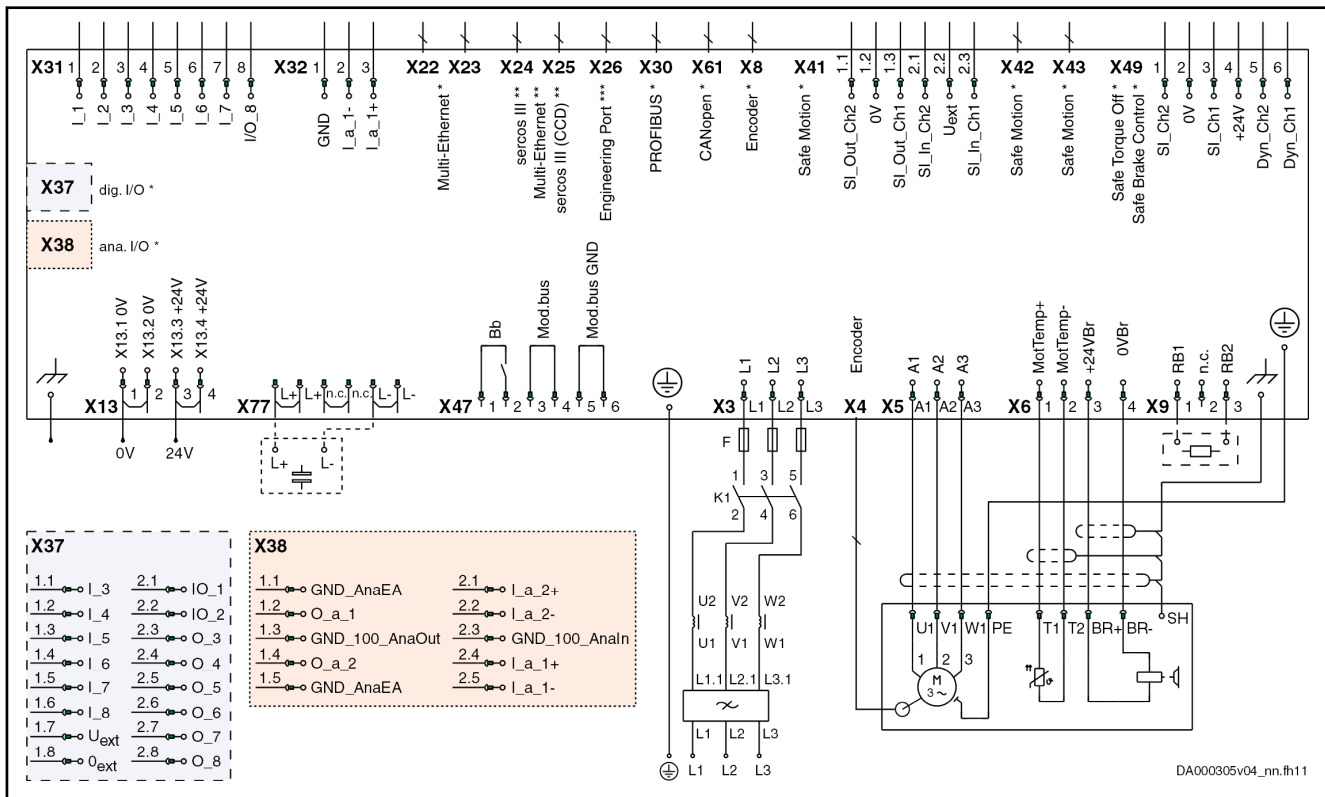









DA000305v04_nn.fn11

































- * Optional
- ** **ECONOMY** = sercos III; **BASIC** = Multi-Ethernet; **ADVANCED** = sercos III cross communication (CCD)
- *** Only available at HCS01.1E-W00**-A-0*-A-CC (ADVANCED) devices
- X6.1, X6.2** T1 and T2 are not available at MSM motors. For proper function of the motor thermal management connect the motor thermal sensor as described in the wiring diagram. Otherwise motor overtemperature sensing is not provided by the drive. For Rexroth motors with data memory in the motor encoder, such as MSK, the motor overload protection level is set automatically while connecting the motor to the drive. There is no adjustment necessary. Otherwise refer to the Rexroth firmware documentation.
- X31** No standard assignment preset; make the assignment by means of firmware documentation (see Functional Description, index entry "Digital inputs/outputs")
- X47.1, X47.2** For the "ready for operation" message of the device, the Bb relay contact (X47.1, X47.2) must be wired
- X47.3...6** Module bus only available at HCS01.1E-W00xx-x-03 devices
- X77** DC bus connection (L+, L-) only available at HCS01.1E-W00xx-x-03 devices

Fig. 4-1: Connection Diagram

4.2.2 Connection Points

Symbols used to describe the connection points								
Screw terminal block	Spring terminal	D-Sub	RJ-45	Industrial Mini I/O	Thread	Max. connection cross section	Stripped length	Max. tightening torque
								

Tab. 4-1: Symbols

Connection point	HCS01	     	\varnothing mm ² (AWG)	 mm	 Nm
	A, B, C		M5	-	5
X3	A ¹⁾		2,5 (14)	8	0,6
	B ²⁾		6,0 (10)	10	0,8
	C ³⁾		10,0 (8)	14	1,7
X4	A, B, C		-	-	-
X5	A		2,5 (14)	8	0,6
	B		6,0 (10)	10	0,8
	C		10,0 (8)	14	1,7
X6	A, B, C		1,5 (16)	10	-
X8	A, B, C		-	-	-
X9	A, B, C	- ⁵⁾	-	-	-
X13	A, B, C		2,5 (14)	10	-
X22 P2, X23 P1	A, B, C		-	-	-
X24 P2, X25 P1	A, B, C		-	-	-
X26	A, B, C		-	-	-
X30	A, B, C		-	-	-
X31	A, B, C		1,5 (16)	10	-
X32	A, B, C		1,5 (16)	10	-
X37	A, B, C		1,5 (16)	10	-
X38	A, B, C		1,5 (16)	10	-
X41	A, B, C		1,5 (16)	10	-
X42, X43	A, B, C		-	-	-
X47	A, B, C		1,5 (16)	10	-
X49	A, B, C		1,5 (16)	8	-

Instructions for Use

Connection point	HCS01		\varnothing mm ² (AWG)	 mm	 Nm
X61	A, B, C		-	-	-
X77	D ⁴⁾		6 (8)	15	-

- 1) **A:** HCS01.1E-W0003...W0013-x-02, -W0005-x-03, -W0008-x-03
2) **B:** HCS01.1E-W0018-x-02, -W0018-x-03, -W0028-x-03
3) **C:** HCS01.1E-W0054-x-03
4) **D:** HCS01.1E-W00xx-x-03
5) Connector available at braking resistor
Tab. 4-2: Connection Points

5 Service and Support

Our worldwide service network provides an optimized and efficient support. Our experts offer you advice and assistance should you have any queries. You can contact us **24/7**.

Service Germany Our technology-oriented Competence Center in Lohr, Germany, is responsible for all your service-related queries for electric drive and controls.

Contact the **Service Helpdesk & Hotline** under:

Phone: **+49 9352 40 5060**
Fax: **+49 9352 18 4941**
E-mail: service.svc@boschrexroth.de
Internet: <http://www.boschrexroth.com>

Additional information on service, repair (e.g. delivery addresses) and training can be found on our internet sites.

Service worldwide Outside Germany, please contact your local service office first. For hotline numbers, refer to the sales office addresses on the internet.

Preparing information To be able to help you more quickly and efficiently, please have the following information ready:

- Detailed description of malfunction and circumstances resulting in the malfunction
- Type plate name of the affected products, in particular type codes and serial numbers
- Your contact data (phone and fax number as well as your email address)

Index

A			
Additional documentations.....	15	Reference documentations.....	15
Ambient conditions.....	7	S	
Appropriate use.....	6	Safety instructions.....	3
		Support	
C		See service hotline.....	21
Connection.....	18	T	
Connection diagram.....	18	Technical data.....	7
Connection points			
HCS01.....	19	U	
		UL ratings.....	7
D		Use	
Data		Appropriate.....	6
HCS01, dimensional drawings.....	11	Instructions.....	17
HCS01, dimensions.....	11	V	
Dimensional drawing		Voltage load capacity.....	7
HCS01.1E-W0003/5/6/8/9/13.....	11		
HCS01.1E-W0018/28.....	12	X	
HCS01.1E-W0054.....	13	X3.....	19
Dimensional drawings		X4.....	19
HCS01.....	11	X5.....	19
Dimensions.....	7	X6.....	19
HCS01.1E-W0003/5/6/8/9/13.....	11	X8.....	19
HCS01.1E-W0018/28.....	12	X9.....	19
HCS01.1E-W0054.....	13	X13.....	19
Distances.....	10	X22, X23.....	19
Documentation		X24, X25.....	19
Additional documentations.....	15	X26.....	19
Motors.....	15	X30.....	19
Overview.....	15	X31.....	19
Reference documentations.....	15	X32.....	19
		X37.....	19
H		X38.....	19
HCS01		X41.....	19
Dimensional drawings.....	11	X42, X43.....	19
Dimensions.....	11	X47.....	19
Technical data.....	7	X49.....	19
		X61.....	19
I		X77.....	19
Instructions for use.....	17		
M			
Motor			
Documentation.....	15		
O			
Operating conditions.....	7		
Overcurrent protection.....	17		
P			
Power consumption.....	7		
R			
Ratings.....	7		

Notes

Notes

Bosch Rexroth AG
Electric Drives and Controls
P.O. Box 13 57
97803 Lohr, Germany
Bgm.-Dr.-Nebel-Str. 2
97816 Lohr, Germany
Tel. +49 9352 18 0
Fax +49 9352 18 8400
www.boschrexroth.com/electrics



R911325518

DOK-INDRV*-HCS01*UL***-IB06-EN-P