

---

## REYQ\*\*\*XA(TJU,YDU,TCU) VRV Heat Recovery Outdoor Unit

REYQ120XATJU  
REYQ120XAYCU  
REYQ120XAYDU  
REYQ144XATJU  
REYQ144XAYCU  
REYQ144XAYDU  
REYQ168XATJU  
REYQ168XAYCU  
REYQ168XAYDU  
REYQ72XATJU  
REYQ72XAYCU  
REYQ72XAYDU  
REYQ96XATJU  
REYQ96XAYCU  
REYQ96XAYDU



This manual is to be used by qualified technicians only.

# Important Information

---

## Index

Functional Parts List .....	3
Illustration and Parts .....	4 - 51

*Views shown are for parts illustrations only, not servicing procedures*

### Text Codes:

AR - As Required

NA - Not Available

NS - Not Shown

00000000 - See Note

QTY - Quantity Example (QTY 3) (If Quantity not shown, Quantity = 1)

M - Model Example (M1) (If M Code not shown, then part is used on all Models)

### Expanded Model Nomenclature:

Example M1 - Model#1 M2 - Model#2 M3 - Model#3
---

Daikin Manufacturing Company, L.P. is not responsible for personal injury or property damage resulting from improper service. Review all service information before beginning repairs.

Warranty service must be performed by an authorized technician, using authorized factory parts. If service is required after the warranty expires, Daikin Manufacturing Company, L.P. also recommends contacting an authorized technician and using authorized factory parts.

Daikin Manufacturing Company, L.P. reserves the right to discontinue, or change at any time, specifications or designs without notice or without incurring obligations.

For assistance within the U.S.A. contact:

Homeowner Support  
Daikin North America, LLC  
19001 Kermier Road  
Waller, Texas 77484  
855-770-5678-Telephone  
713-863-2382-Facsimile

For assistance outside the U.S.A. contact:

International Division  
Daikin North America, LLC  
19001 Kermier Road  
Waller, Texas 77484  
713-861-2500-Telephone  
713-863-2382-Facsimile

# Functional Parts

**Part No:**            **Description:**

2311845	CHECK VALVE (M4, M5, M6, M7, M8, M9)
1086083	CHECK VALVE
2103479	CHECK VALVE (M1, M2, M3, M10, M11, M12, M13, M14, M15)
7009598	CRANK CASE HEATER (QTY 2)
2287663	CURRENT TRANSFORMER (M4, M7)
2117168	CURRENT TRANSFORMER (M1, M2, M3, M5, M6, M8, M9, M10, M11, M12, M13, M14, M15)
7009643	DC FAN MOTOR (M2, M5, M8, M11, M14)
4012442	FAN MOTOR (M3, M6, M9, M12, M15)
2219451	FAN MOTOR (M1, M4, M7, M10, M13)
1899948	FIN THERMISTOR (M4, M6, M7, M9)
7009608	HIGH PRESSURE SWITCH
7009639	LOW FREQUENCY TRANSFORMER (M2, M5, M8, M11, M14)
7009503	LOW FREQUENCY TRANSFORMER (M3, M6, M9, M12, M15)
2441568	PCB (M3, M6, M9, M12, M15)
1716788	PCB (ABC I/P)
7009554	PCB (CURRENT LIMITING) (M3, M12, M15)
7500012	PCB (FAN) (M3, M6, M9, M12, M15)
7500013	PCB (FAN) (M3, M6, M9, M12, M15)
7009637	PCB (FAN) (M2, M5, M8, M11, M14)
2387309	PCB (INV)(FAN) (M1, M10, M13)
2387361	PCB (INVERTER) (M4, M7)
2387417	PCB (INVERTER) (M6, M9)
7009636	PCB (INVERTER) (M2, M11, M14)
2441520	PCB (MAIN) (M1, M4, M7, M10, M13)
2441544	PCB (MAIN) (M2, M5, M8, M11, M14)
7009634	PCB (NOISE FILTER) (M2, M5, M8, M11, M14)
7500016	PCB (NOISE FILTER) (M3, M12, M15)
1996236	PCB (NOISE FILTER) (M1, M10, M13)
7009635	PCB (NOISE FILTER) (M2, M5, M8, M11, M14)
6026439	PCB (NOISE FILTER) (M6, M9)
7009551	PCB (NOISE FILTER) (M3, M12, M15)
7009556	PCB (REVERSE PHASE PROTECTION) (M3, M12, M15)
7500014	PCB (SUB)
2387260	PCB(INVERTER) (M3, M12, M15)
2299060	PCB. (NOISE FILTER) (M4, M7)
7009625	PRESSURE CONTROL VALVE (M1, M3, M5, M6, M8, M9, M10, M12, M13, M15)
7009681	PRINTED CIRCUIT ASSY. (INVERTER) (M5, M8)
7009663	SCROLL COMPRESSOR (M5, M8)
7009593	SCROLL COMPRESSOR (M2, M11, M14)
2387392	SCROLL COMPRESSOR ASSY. (M6, M9)
2441474	SCROLL COMPRESSOR ASSY. (M1, M10, M13)
2387323	SCROLL COMPRESSOR ASSY. (M4, M7)
2441551	SCROLL COMPRESSOR ASSY. (M3, M12, M15)
2103455	STOP VALVE
NA	THERMISTOR
1782095	THERMISTOR (AIR)
2093255	THERMISTOR (L1R) (M1, M10, M13)
2093262	THERMISTOR (L2R) (M1, M10, M13)

## Expanded Model Nomenclature

M1 - REYQ120XATJU
M2 - REYQ120XAYCU
M3 - REYQ120XAYDU
M4 - REYQ144XATJU
M5 - REYQ144XAYCU
M6 - REYQ144XAYDU
M7 - REYQ168XATJU
M8 - REYQ168XAYCU
M9 - REYQ168XAYDU
M10 - REYQ72XATJU
M11 - REYQ72XAYCU
M12 - REYQ72XAYDU
M13 - REYQ96XATJU
M14 - REYQ96XAYCU
M15 - REYQ96XAYDU

REYQ72XATJU / REYQ96XATJU / REYQ120XATJU

-TOP-

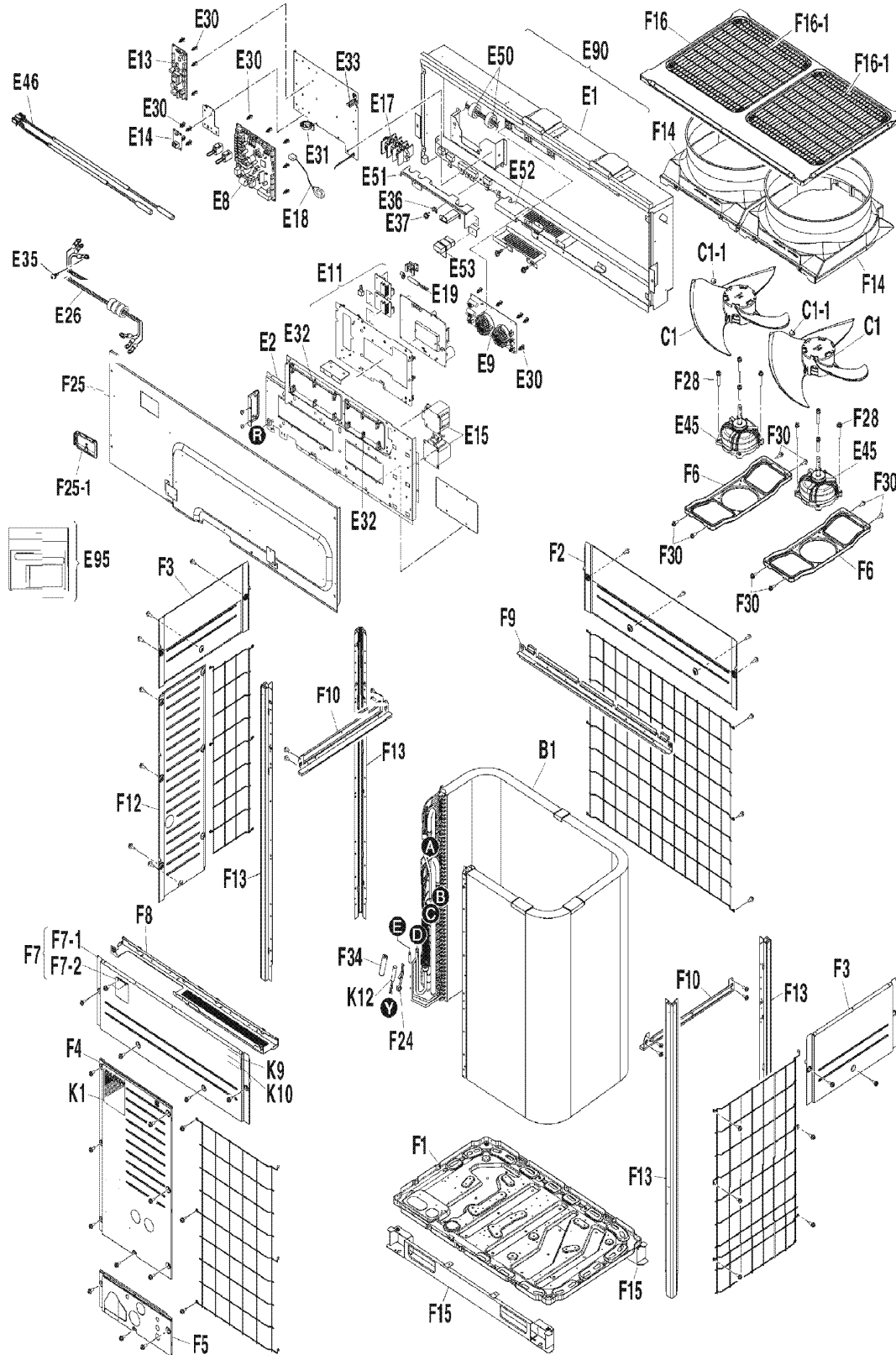

Picture Key	
Ref #	Picture #
1	B1
2	C1
3	C1-1
4	E1
5	E11
6	E13
7	E14
8	E15
9	E17
10	E18
11	E19
12	E2
13	E26
14	E30
15	E31
16	E32
17	E33
18	E35
19	E36
20	E37
21	E45
22	E46
23	E50
24	E51
25	E52
26	E53
27	E8
28	E9
29	E90
30	E95
31	F1
32	F10
33	F12
34	F13
35	F14
36	F15
37	F16
38	F16-1
39	F2
40	F24
41	F25
42	F25-1
43	F28
44	F3
45	F30
46	F34
47	F4
48	F5
49	F6
50	F7
51	F7-1
52	F7-2
53	F8
54	F9
55	K10
56	K9

Ref. Part No:	Part No:	Description:	Ref. Part No:	Part No:	Description:
<b>Image 1:</b>			<b>Image 1:</b>		
1	7009599	PLATE FINNED COIL HEAT EXCH. ASSY. (M1, M10, M13)	54	7009537	STAY (REAR) (M1, M10, M13)
2	7009517	PROPELLER FAN ASSY. (M1, M10, M13)	55	4023075	CAUTION LABEL (ROTATING) (M1, M10, M13)
3	057178J	HEX SOCKET SCREW (M1, M10, M13)	56	4010207	LABEL (WARNING) (M1, M10, M13)
4	NA	SWITCH BOX ASSY. (M1, M10, M13)	<b>Expanded Model Nomenclature</b>		
5	2387309	PCB (INV)(FAN) (M1, M10, M13)	<div style="border: 1px solid black; padding: 5px;"> M1 - REYQ120XATJU  M2 - REYQ120XAYCU  M3 - REYQ120XAYDU  M4 - REYQ144XATJU  M5 - REYQ144XAYCU  M6 - REYQ144XAYDU  M7 - REYQ168XATJU  M8 - REYQ168XAYCU  M9 - REYQ168XAYDU  M10 - REYQ72XATJU  M11 - REYQ72XAYCU  M12 - REYQ72XAYDU  M13 - REYQ96XATJU  M14 - REYQ96XAYCU  M15 - REYQ96XAYDU </div>		
6	7500014	PCB.(SUB) (M1, M10, M13)			
7	1716788	PCB (ABC I/P) (M1, M10, M13)			
8	2093091	REACTOR (M1, M10, M13)			
9	7009522	TERMINAL BLOCK (M1, M10, M13)			
10	2117168	CURRENT TRANSFORMER (M1, M10, M13)			
11	1782095	THERMISTOR (AIR) (M1, M10, M13)			
12	2279299	EL. COMPO. MOUNTING PLATE (INVERTER) (M1, M10, M13)			
13	2387316	WIRE HARNESS ASSY. (COMP.) (M1, M10, M13)			
14	380401J	LOCKING CARD SPACER (M1, M10, M13)			
15	2010250	WIRE CLIP (M1, M10, M13)			
16	027843J	WIRE CLIP (M1, M10, M13)			
17	0207661	LOCKING WIRE SADDLE (M1, M10, M13)			
18	NA	PAN HEAD MACHINE SCREW (M1, M10, M13)			
19	066578J	CUP WASHER (M1, M10, M13)			
20	NA	EARTH TERMINAL SCREW (M1, M10, M13)			
21	2219451	FAN MOTOR (M1, M10, M13)			
22	7009644	THERMISTOR ASSY. (M1, M10, M13)			
23	145927J	FERRITE CORE (M1, M10, M13)			
24	NA	EL. COMPO. MOUNTING PLATE ASSY. (M1, M10, M13)			
25	NA	SEALING MATERIAL (SWITCH BOX) (M1, M10,			
26	NA	SEALING MATERIAL ASSY. (M1, M10, M13)			
27	2441520	PCB (MAIN) (M1, M10, M13)			
28	1996236	PCB (NOISE FILTER) (M1, M10, M13)			
29	NA	ELECTRIC COMPONENT ASSY. (M1, M10, M13)			
30	NA	GREASE ASSY. (M1, M10, M13)			
31	7009530	BOTTOM FRAME (M1, M10, M13)			
32	7009478	STAY (RIGHT/ LEFT) (M1, M10, M13)			
33	7009480	SIDE PLATE (M1, M10, M13)			
34	7009481	SUPPORT (M1, M10, M13)			
35	7009588	BELL MOUTH (M1, M10, M13)			
36	7009538	BRACKET (M1, M10, M13)			
37	7009539	TOP PLATE ASSY. (M1, M10, M13)			
38	7500121	DISCHARGE GRILLE (M1, M10, M13)			
39	7009531	FRONT PLATE (UPPER) (M1, M10, M13)			
40	042396J	FITTING SPRING/ THERMISTOR (M1, M10, M13)			
41	NA	COVER/ SWITCH BOX ASSY. (M1, M10, M13)			
42	128777J	INSPECTION HOLE (M1, M10, M13)			
43	7009486	HEX HEAD TAPPING SCREW (M1, M10, M13)			
44	7009471	SIDE PLATE (UPPER) (M1, M10, M13)			
45	0493462	TAPPING SCREW (M1, M10, M13)			
46	144290J	HEAT INSULATION TUBE (M1, M10, M13)			
47	7009532	FRONT PLATE (M1, M10, M13)			
48	7009533	FRONT PLATE (BOTTOM) (M1, M10, M13)			
49	7009534	MOTOR MOUNTING PLATE (M1, M10, M13)			
50	2441537	FRONT PLATE ASSY. (M1, M10, M13)			
51	NA	FRONT PLATE (M1, M10, M13)			
52	NA	SERVICE PLATE ASSY. (M1, M10, M13)			
53	7009536	STAY ASSY. (FRONT) (M1, M10, M13)			

REYQ72XATJU / REYQ96XATJU / REYQ120XATJU

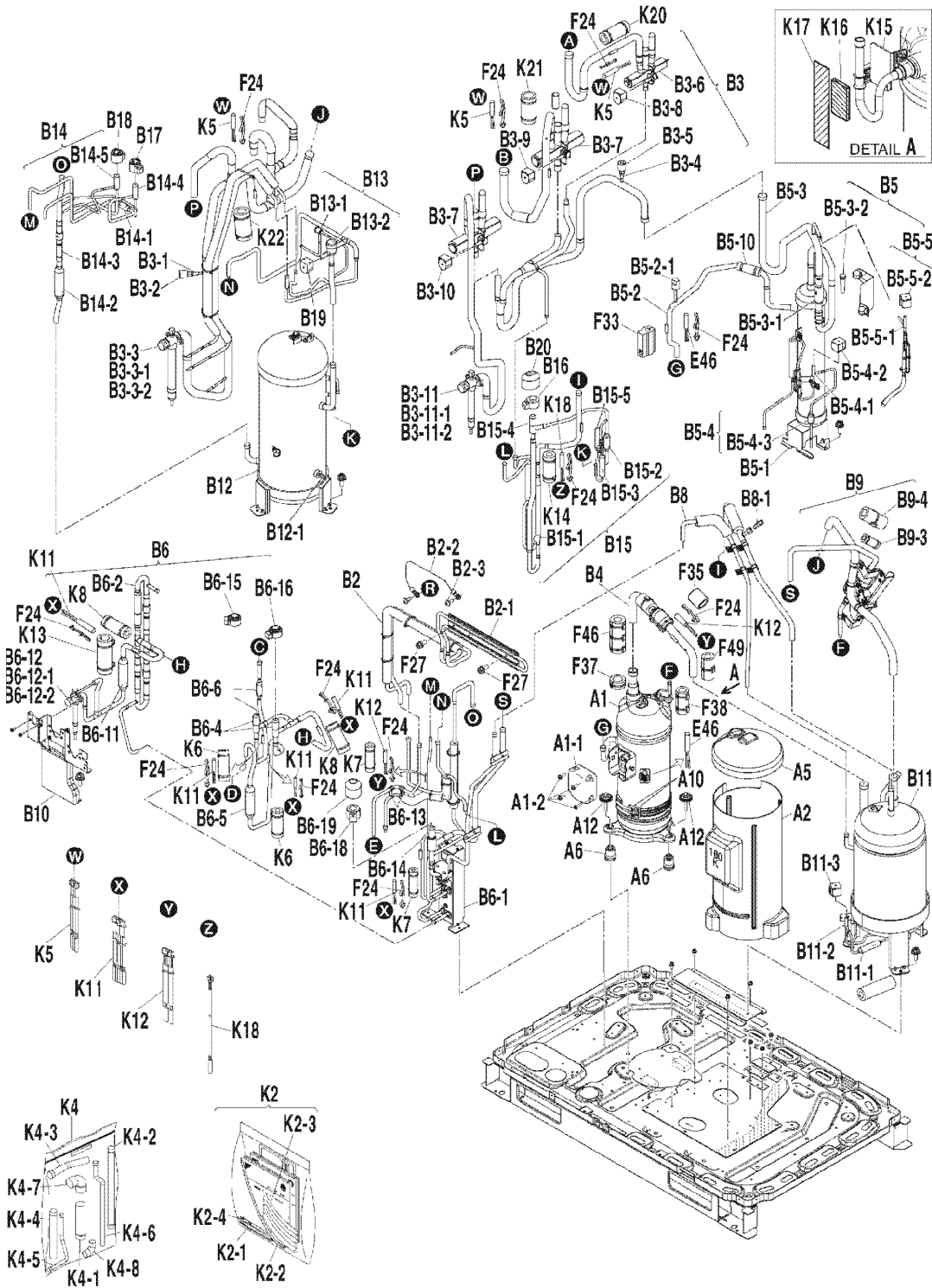

Picture Key			
Ref #	Picture #	Ref #	Picture #
1	A1	66	B5-4-1
2	A10	67	B5-4-2
3	A1-1	68	B5-4-3
4	A12	69	B5-5
5	A1-2	70	B5-5-1
6	A2	71	B5-5-2
7	A5	72	B6
8	A6	73	B6-1
9	B10	74	B6-11
10	B11	75	B6-12
11	B11-1	76	B6-12-1
12	B11-2	77	B6-12-2
13	B11-3	78	B6-13
14	B12	79	B6-14
15	B12-1	80	B6-15
16	B13	81	B6-16
17	B13-1	82	B6-18
18	B13-2	83	B6-19
19	B14	84	B6-2
20	B14-1	85	B6-4
21	B14-2	86	B6-5
22	B14-3	87	B6-6
23	B14-4	88	B8
24	B14-5	89	B8-1
25	B15	90	B9
26	B15-1	91	B9-3
27	B15-2	92	B9-4
28	B15-3	93	F27
29	B15-4	94	F33
30	B15-5	95	F35
31	B16	96	F37
32	B17	97	F38
33	B18	98	F46
34	B19	99	F49
35	B2	100	K1
36	B20	101	K11
37	B2-1	102	K12
38	B2-2	103	K13
39	B2-3	104	K14
40	B3	105	K15
41	B3-1	106	K16
42	B3-10	107	K17
43	B3-11	108	K18
44	B3-11-1	109	K2
45	B3-11-2	110	K20
46	B3-2	111	K21
47	B3-3	112	K2-1
48	B3-3-1	113	K22
49	B3-3-2	114	K2-2
50	B3-4	115	K2-3
51	B3-5	116	K2-4
52	B3-6	117	K4
53	B3-7	118	K4-1
54	B3-8	119	K4-2
55	B3-9	120	K4-3
56	B4	121	K4-4
57	B5	122	K4-5
58	B5-1	123	K4-6
59	B5-10	124	K4-7
60	B5-2	125	K4-8
61	B5-2-1	126	K5
62	B5-3	127	K6
63	B5-3-1	128	K7
64	B5-3-2	129	K8
65	B5-4		

Ref. Part No: No:	Description:	Ref. Part No: No:	Description:
<b>Image 1:</b>		<b>Image 1:</b>	
1	2441474	38	2103626
2	7009598	39	2103633
3	2441481	40	NA
4	2311775	41	1944437
5	NA	42	7500061
6	2278885	43	NA
7	2278892	44	2127879
8	2286848	45	2116831
9	7500035	46	2226992
10	7009621	47	NA
11	232005J	48	2127901
12	2165972	49	2116831
13	7009622	50	1944437
14	7009623	51	2227003
15	7009455	52	2119861
16	NA	53	6019596
17	7009625	54	7500059
18	147657J	55	7500060
19	NA	56	NA
20	2113337	57	NA
21	012000J	58	7009607
22	1086083	59	2311799
23	2233628	60	NA
24	2204606	61	7009608
25	NA	62	NA
26	7500077	63	2103479
27	2113344	64	2096331
28	232005J	65	NA
29	1996469	66	2165965
30	NA	67	7500071
31	2441506	68	4012537
32	7500040	69	NA
33	2441513	70	2165972
34	7500080	71	7500070
35	NA	72	NA
36	0650304	73	7009610
37	2387291	74	231501J
		75	NA
		76	2103455
		77	143584J
		78	1505111
		79	1801415

Ref. Part No:	Part No:	Description:	Ref. Part No:	Part No:	Description:
<b>Image 1:</b>			<b>Image 1:</b>		
80	7500031	COIL/ ELE EXP. VALVE (HEAT EXC. UPPER) (M1, M10, M13)	122	7500096	AUXILIARY PIPE (LIQUID SIDE FRONT) (M10, M13)
81	7500030	COIL/ ELE EXP. VALVE (HEAT EXC. LOWER) (M1, M10, M13)	123	7009578	AUXILIARY PIPE (LIQUID SIDE BOTTOM) (M1)
82	2441498	COIL/ ELE EXP. VALVE (INJECTION) (M1, M10, M13)	123	7500097	AUXILIARY PIPE (LIQUID SIDE BOTTOM) (M10, M13)
83	7009700	WATER PROOF CAP (M1, M10, M13)	124	1799257	L-TYPE JOINT (M1, M10, M13)
84	NA	LIQUID PIPE ASSY. (M1, M10, M13)	125	254105J	ELBOW JOINT (M1, M10, M13)
85	1996469	BODY/ ELECTRONIC EXP. VALVE (M1, M10, M13)	126	7500085	THERMISTOR ASSY. (SUCTION) (M1, M10, M13)
86	231501J	REFRIGERANT FILTER (M1, M10, M13)	127	144290J	HEAT INSULATION TUBE (M1, M10, M13)
87	2113344	FILTER (FOR REF.) (M1, M10, M13)	128	165763J	THERMAL INSULATION TUBE (M1, M10, M13)
88	NA	REFRIGERANT PIPE ASSY. (M1, M10, M13)	129	144291J	HEAT INSULATION TUBE (M1, M10, M13)
89	7009455	FUSIBLE PLUG ASSY. (M1, M10, M13)	<b>Expanded Model Nomenclature</b>		
90	7009618	SUCTION PIPE ASSY. (1) (M1, M10, M13)	<div style="border: 1px solid black; padding: 5px;"> M1 - REYQ120XATJU  M2 - REYQ120XAYCU  M3 - REYQ120XAYDU  M4 - REYQ144XATJU  M5 - REYQ144XAYCU  M6 - REYQ144XAYDU  M7 - REYQ168XATJU  M8 - REYQ168XAYCU  M9 - REYQ168XAYDU  M10 - REYQ72XATJU  M11 - REYQ72XAYCU  M12 - REYQ72XAYDU  M13 - REYQ96XATJU  M14 - REYQ96XAYCU  M15 - REYQ96XAYDU </div>		
91	7009620	WEIGHT (M1, M10, M13)			
92	2317139	WEIGHT (M1, M10, M13)			
93	4012540	HEX BOLT (M1, M10, M13)			
94	128153J	THERMAL INSULATION (M1, M10, M13)			
95	NA	THERMAL INSULATION TUBE (M1, M10, M13)			
96	6026549	WEIGHT (M1, M10, M13)			
97	7009680	WEIGHT ASSY. (M1, M10, M13)			
98	7009678	WEIGHT (M1, M10, M13)			
99	2317139	WEIGHT (M1, M10, M13)			
100	7009692	BRAND NAME LABEL (M1, M10, M13)			
101	NA	THERMISTOR ASSY. (M1, M10, M13)			
102	NA	THERMISTOR ASSY. (M1, M10, M13)			
103	7009703	HEAT INSULATION TUBE (M1, M10, M13)			
104	144291J	HEAT INSULATION TUBE (M1, M10, M13)			
105	NA	MOUNTING PLATE ASSY. (M1, M10, M13)			
106	NA	THERMAL INSULATION TAPE (M1, M10, M13)			
107	NA	TAPE (ALMINIUM) (M1, M10, M13)			
108	NA	THERMISTOR (M1, M10, M13)			
109	NA	ACCESSORIES ASSY. (M1, M10, M13)			
110	042408J	INSULATION TUBE/ REF. PIPING (M1, M10, M13)			
111	0424055	HEAT INSULATION COVER (M1, M10, M13)			
112	NA	TIE WRAP (M1, M10, M13)			
113	NA	THERMAL INSULATION TUBE (M1, M10, M13)			
114	NA	CLAMP/ LEAD WIRE (M1, M10, M13)			
115	1997424	ELECTRIC INSULATION (M1, M10, M13)			
116	056827J	TIE WRAP (M1, M10, M13)			
117	NA	ACCESSORIES ASSY. (M1, M10, M13)			
118	7009542	AUXILIARY PIPE (GAS SIDE FRONT) (M1)			
118	7500052	AUXILIARY PIPE (GAS SIDE FRONT) (M10)			
118	7500090	AUXILIARY PIPE (GAS SIDE FRONT) (M13)			
119	7009544	AUXILIARY PIPE (GAS SIDE BOTTOM) (M1)			
119	7500053	AUXILIARY PIPE (GAS SIDE BOTTOM) (M10)			
119	7500091	AUXILIARY PIPE (GAS SIDE BOTTOM) (M13)			
120	7500054	AUXILIARY PIPE (H AND L PRESSURE) (M10)			
120	7500093	AUXILIARY PIPE DISCHARGE (GAS SIDE F) (M1, M13)			
121	7500055	AUXILIARY PIPE (H AND L PRESSURE) (M10)			
121	7500095	AUXILIARY PIPE DISCHARGE (GAS SIDE LOWER) (M1, M13)			
122	7009576	AUXILIARY PIPE (LIQUID SIDE FRONT) (M1)			



REYQ72XATJU / REYQ96XATJU / REYQ120XATJU

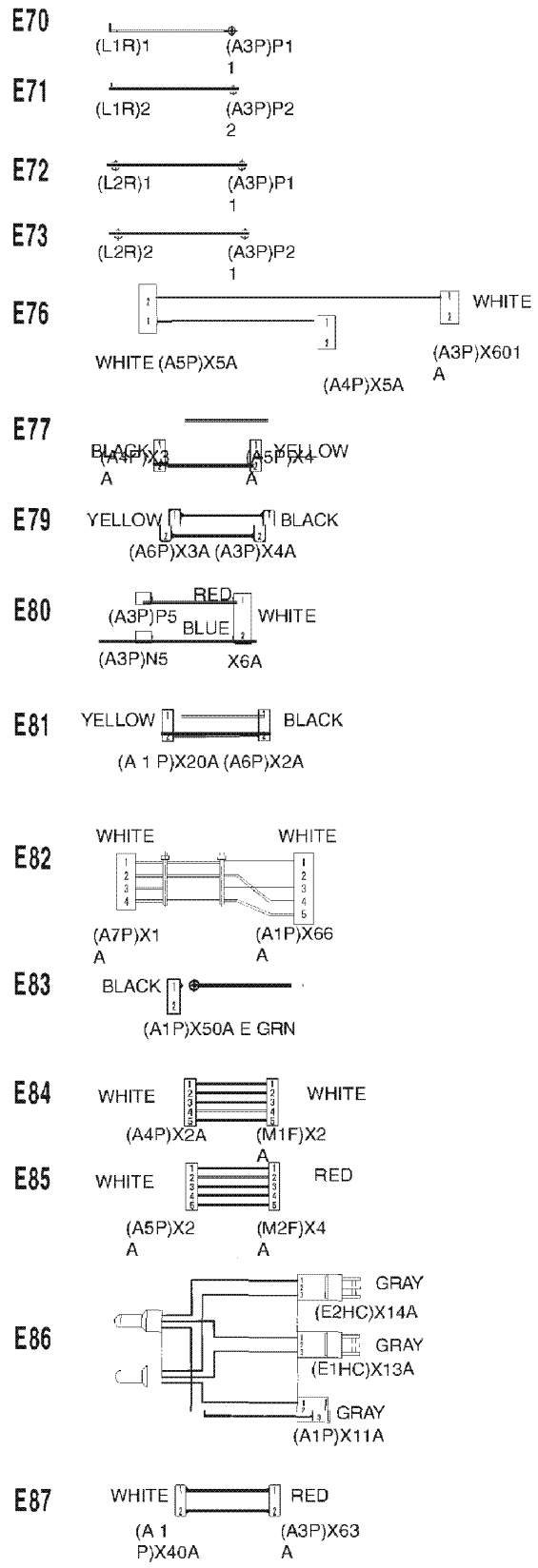
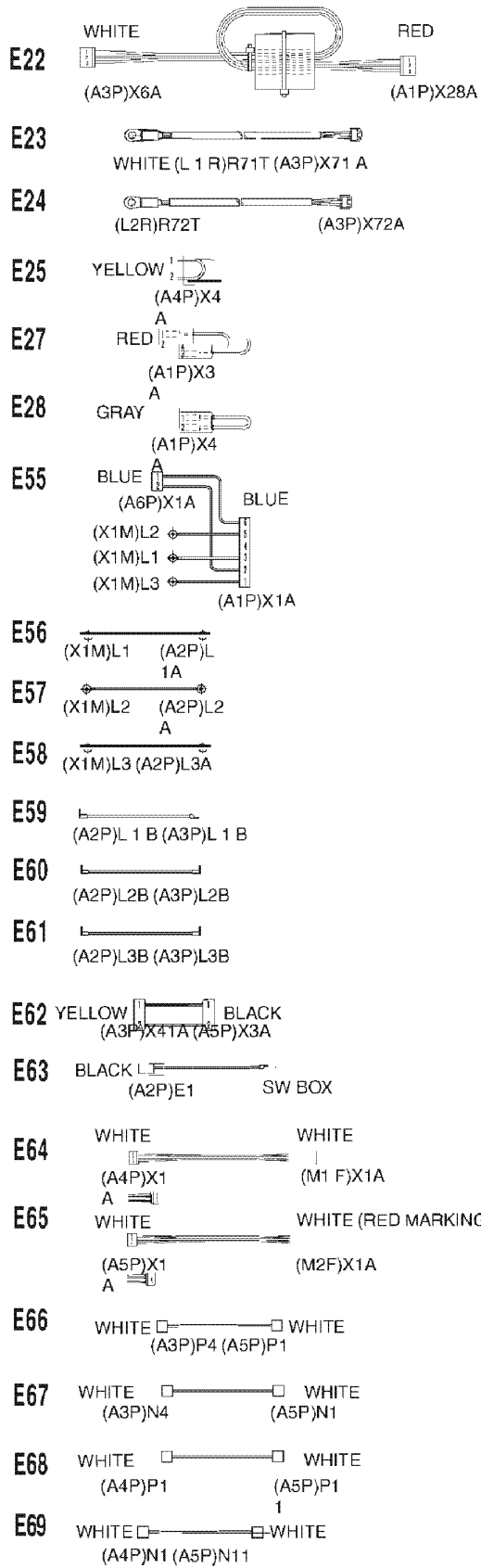

Picture Key	
Ref #	Picture #
1	E22
2	E23
3	E24
4	E25
5	E27
6	E28
7	E55
8	E56
9	E57
10	E58
11	E59
12	E60
13	E61
14	E62
15	E63
16	E64
17	E65
18	E66
19	E67
20	E68
21	E69
22	E70
23	E71
24	E72
25	E73
26	E76
27	E77
28	E79
29	E80
30	E81
31	E82
32	E83
33	E84
34	E85
35	E86
36	E87

Ref. Part No:	Part No:	Description:	Ref. Part No:	Part No:	Description:
---------------	----------	--------------	---------------	----------	--------------

**Image 1:**

1	2129820	WIRE HARNESS ASSY. (M1, M10, M13)
2	2093255	THERMISTOR (L1R) (M1, M10, M13)
3	2093262	THERMISTOR (L2R) (M1, M10, M13)
4	1933413	CONNECTOR/ SHORT CIRCUIT (M1, M10, M13)
5	135234J	CONNECTOR/ SHORT CIRCUIT (M1, M10, M13)
6	2233712	CONNECTOR (M1, M10, M13)
7	7900185	WIRE HARNESS (M1, M10, M13)
8	2167567	WIRE HARNESS (M1, M10, M13)
9	2167574	WIRE HARNESS (M1, M10, M13)
10	2167581	WIRE HARNESS (M1, M10, M13)
11	2167598	WIRE HARNESS (M1, M10, M13)
12	2167606	WIRE HARNESS (M1, M10, M13)
13	2167613	WIRE HARNESS (M1, M10, M13)
14	4014821	WIRE HARNESS (M1, M10, M13)
15	2093349	WIRE HARNESS (M1, M10, M13)
16	2299091	WIRE HARNESS ASSY. (M1, M10, M13)
17	2299109	WIRE HARNESS ASSY. (M1, M10, M13)
18	2093750	WIRE HARNESS (M1, M10, M13)
19	2093767	WIRE HARNESS (M1, M10, M13)
20	6019712	WIRE HARNESS (M1, M10, M13)
21	7009733	WIRE HARNESS (M1, M10, M13)
22	6025076	WIRE HARNESS (M1, M10, M13)
23	6025077	WIRE HARNESS (M1, M10, M13)
24	6025078	WIRE HARNESS (M1, M10, M13)
25	6025079	WIRE HARNESS (M1, M10, M13)
26	2093363	WIRE HARNESS ASSY. (M1, M10, M13)
27	6019724	WIRE HARNESS (M1, M10, M13)
28	4014819	WIRE HARNESS (M1, M10, M13)
29	2130008	WIRE HARNESS (M1, M10, M13)
30	7009734	WIRE HARNESS (M1, M10, M13)
31	7009735	WIRE HARNESS ASSY. (M1, M10, M13)
32	7009729	WIRE HARNESS (M1, M10, M13)
33	7009730	WIRE HARNESS (M1, M10, M13)
34	7009731	WIRE HARNESS (M1, M10, M13)
35	7009732	WIRE HARNESS ASSY. (M1, M10, M13)
36	7009736	WIRE HARNESS (M1, M10, M13)

**Expanded Model Nomenclature**

M1 - REYQ120XATJU
M2 - REYQ120XAYCU
M3 - REYQ120XAYDU
M4 - REYQ144XATJU
M5 - REYQ144XAYCU
M6 - REYQ144XAYDU
M7 - REYQ168XATJU
M8 - REYQ168XAYCU
M9 - REYQ168XAYDU
M10 - REYQ72XATJU
M11 - REYQ72XAYCU
M12 - REYQ72XAYDU
M13 - REYQ96XATJU
M14 - REYQ96XAYCU
M15 - REYQ96XAYDU

REYQ72XATJU / REYQ96XATJU / REYQ120XATJU

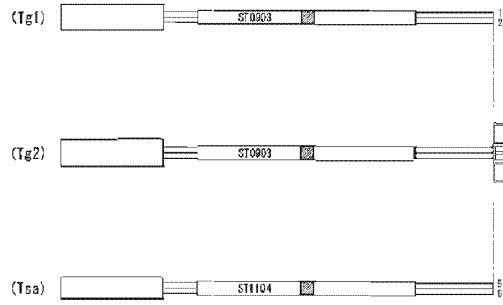

Picture Key	
Ref #	Picture #
1	K11
2	K12
3	K18
4	K5

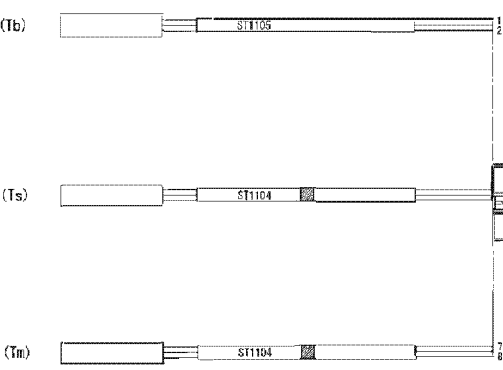
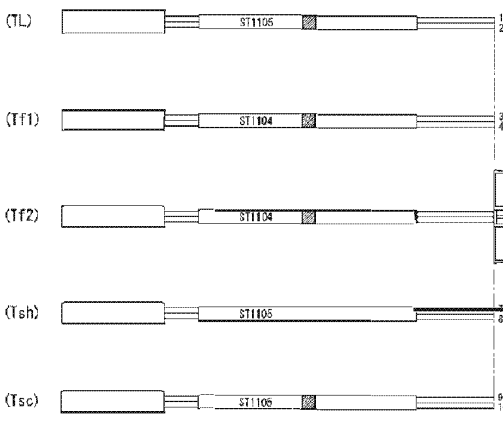

**Ref. Part  
No: No:**

**Description:**

**Ref. Part  
No: No:**

**Description:**

---

**Image 1:**

1	NA	THERMISTOR ASSY. (M1, M10, M13)
2	NA	THERMISTOR ASSY. (M1, M10, M13)
3	NA	THERMISTOR (M1, M10, M13)
4	7500085	THERMISTOR ASSY. (SUCTION) (M1, M10, M13)

**Expanded Model Nomenclature**

M1 - REYQ120XATJU
M2 - REYQ120XAYCU
M3 - REYQ120XAYDU
M4 - REYQ144XATJU
M5 - REYQ144XAYCU
M6 - REYQ144XAYDU
M7 - REYQ168XATJU
M8 - REYQ168XAYCU
M9 - REYQ168XAYDU
M10 - REYQ72XATJU
M11 - REYQ72XAYCU
M12 - REYQ72XAYDU
M13 - REYQ96XATJU
M14 - REYQ96XAYCU
M15 - REYQ96XAYDU

# REYQ144XATJU / REYQ168XATJU

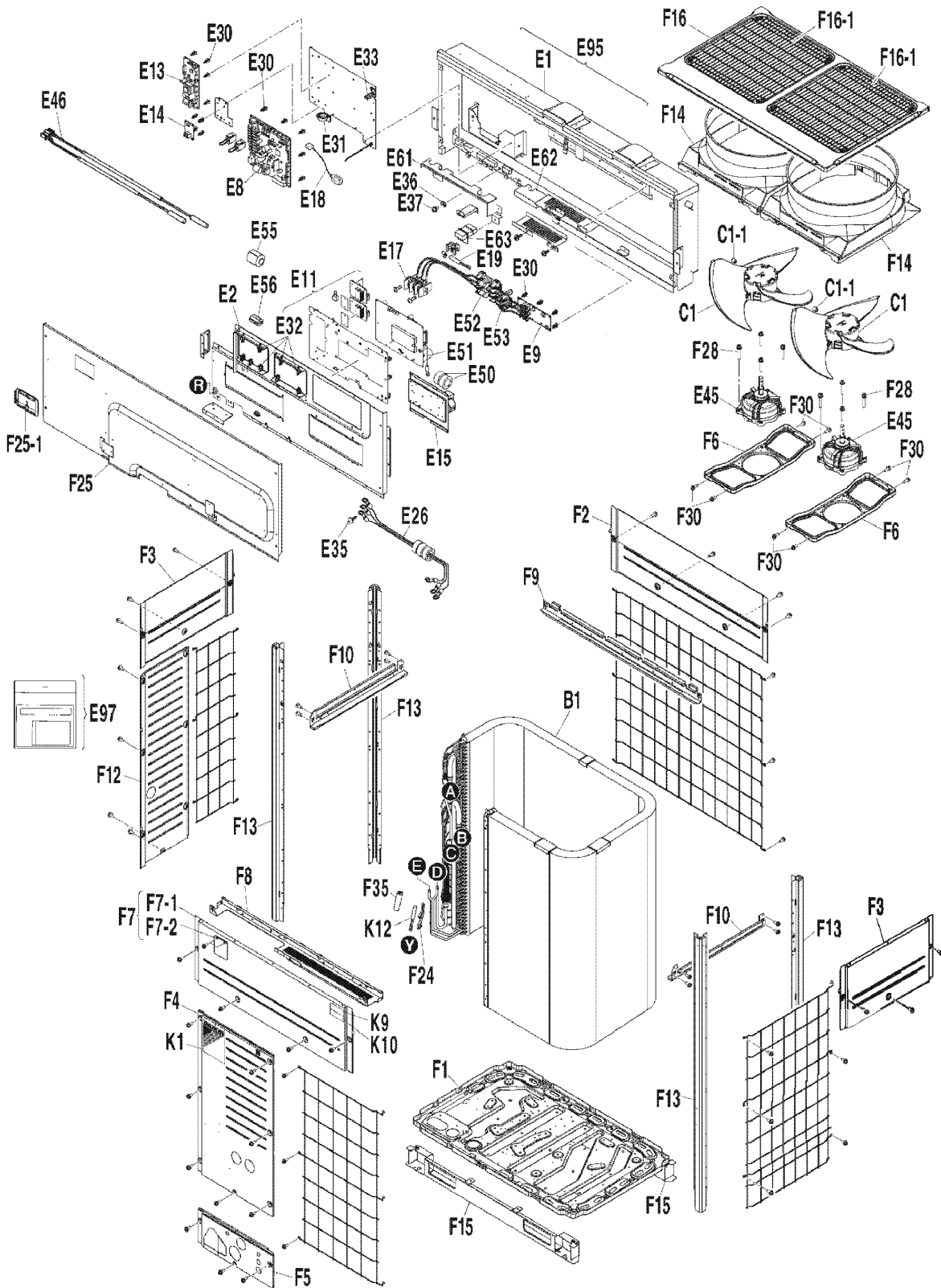

Picture Key	
Ref #	Picture #
1	B1
2	C1
3	C1-1
4	E1
5	E11
6	E13
7	E14
8	E15
9	E17
10	E18
11	E19
12	E2
13	E26
14	E30
15	E31
16	E32
17	E33
18	E35
19	E36
20	E37
21	E45
22	E46
23	E50
24	E51
25	E52
26	E53
27	E55
28	E56
29	E61
30	E62
31	E63
32	E8
33	E9
34	E95
35	E97
36	F1
37	F10
38	F12
39	F13
40	F14
41	F15
42	F16
43	F16-1
44	F2
45	F24
46	F25
47	F25-1
48	F28
49	F3
50	F30
51	F35
52	F4
53	F5
54	F6
55	F7
56	F7-1
57	F7-2
58	F8
59	F9
60	K1
61	K10
62	K9

Ref. Part No:	Part No:	Description:	Ref. Part No:	Part No:	Description:
<b>Image 1:</b>			<b>Image 1:</b>		
1	7009599	PLATE FINNED COIL HEAT EXCH. ASSY. (M4, M7)	56	NA	FRONT PLATE (M4, M7)
2	7009517	PROPELLER FAN ASSY. (M4, M7)	57	NA	SERVICE PLATE ASSY. (M4, M7)
3	057178J	HEX SOCKET SCREW (M4, M7)	58	7009536	STAY ASSY. (FRONT) (M4, M7)
4	NA	SWITCH BOX ASSY. (M4, M7)	59	7009537	STAY (REAR) (M4, M7)
5	2387361	PCB (INVERTER) (M4, M7)	60	7009692	BRAND NAME LABEL (M4, M7)
6	7500014	PCB (SUB) (M4, M7)	61	4023075	CAUTION LABEL (ROTATING) (M4, M7)
7	1716788	PCB(ABC I/P) (M4, M7)	62	4010207	LABEL (WARNING) (M4, M7)
8	2269937	REACTOR ASSY. (M4, M7)	<b>Expanded Model Nomenclature</b>		
9	7009522	TERMINAL BLOCK (M4, M7)	<div style="border: 1px solid black; padding: 5px;"> M1 - REYQ120XATJU  M2 - REYQ120XAYCU  M3 - REYQ120XAYDU  M4 - REYQ144XATJU  M5 - REYQ144XAYCU  M6 - REYQ144XAYDU  M7 - REYQ168XATJU  M8 - REYQ168XAYCU  M9 - REYQ168XAYDU  M10 - REYQ72XATJU  M11 - REYQ72XAYCU  M12 - REYQ72XAYDU  M13 - REYQ96XATJU  M14 - REYQ96XAYCU  M15 - REYQ96XAYDU </div>		
10	2287663	CURRENT TRANSFORMER (M4, M7)			
11	1782095	THERMISTOR (AIR) (M4, M7)			
12	2279491	EL. COMPO. MOUNTING PLATE (INVERTER) (M4, M7)			
13	2387378	WIRE HARNESS ASSY. (COMP.) (M4, M7)			
14	380401J	LOCKING CARD SPACER (M4, M7)			
15	2010250	WIRE CLIP (M4, M7)			
16	027843J	WIRE CLIP (M4, M7)			
17	0207661	LOCKING WIRE SADDLE (M4, M7)			
18	NA	PAN HEAD SCREW WITH WASHER (M4, M7)			
19	066578J	CUP WASHER (M4, M7)			
20	NA	EARTH TERMINAL SCREW (M4, M7)			
21	2219451	FAN MOTOR (M4, M7)			
22	7009683	THERMISTOR ASSY. (M4, M7)			
23	064527J	FERRITE CORE (M4, M7)			
24	1899948	FIN THERMISTOR (M4, M7)			
25	2279592	FUSE TERMINAL (M4, M7)			
26	2279600	COMMON MODE CHOKE COIL (M4, M7)			
27	2031550	FERRITE CORE (M4, M7)			
28	4012628	FERRITE CORE (M4, M7)			
29	NA	EL. COMPO. MOUNTING PLATE ASSY. (M4, M7)			
30	NA	SEALING MATERIAL (SWITCH BOX) (M4, M7)			
31	NA	SEALING MATERIAL ASSY. (M4, M7)			
32	2441520	PCB (MAIN) (M4, M7)			
33	2299060	PCB (NOISE FILTER) (M4, M7)			
34	NA	ELECTRIC COMPONENT ASSY. (M4, M7)			
35	NA	GREASE ASSY. (M4, M7)			
36	7009530	BOTTOM FRAME (M4, M7)			
37	7009478	STAY (RIGHT/ LEFT) (M4, M7)			
38	7009480	SIDE PLATE (M4, M7)			
39	7009481	SUPPORT (M4, M7)			
40	7009588	BELL MOUTH (M4, M7)			
41	7009538	BRACKET (M4, M7)			
42	7009539	TOP PLATE ASSY. (M4, M7)			
43	7500121	DISCHARGE GRILLE (M4, M7)			
44	7009531	FRONT PLATE (UPPER) (M4, M7)			
45	042396J	FITTING SPRING/ THERMISTOR (M4, M7)			
46	NA	COVER/ SWITCH BOX ASSY. (M4, M7)			
47	128777J	INSPECTION HOLE (M4, M7)			
48	7009486	HEX HEAD TAPPING SCREW (M4, M7)			
49	7009471	SIDE PLATE (UPPER) (M4, M7)			
50	0493462	TAPPING SCREW (M4, M7)			
51	144290J	HEAT INSULATION TUBE (M4, M7)			
52	7009532	FRONT PLATE (M4, M7)			
53	7009533	FRONT PLATE (BOTTOM) (M4, M7)			
54	7009534	MOTOR MOUNTING PLATE (M4, M7)			
55	2441537	FRONT PLATE ASSY. (M4, M7)			



Ref. Part No:	Part No:	Description:	Ref. Part No:	Part No:	Description:
<b>Image 1:</b>			<b>Image 1:</b>		
1	2387323	SCROLL COMPRESSOR ASSY. (M4, M7)	46	7500061	COIL/ FOUR WAY VALVE (HP/ LP GAS) (M4, M7)
2	7009598	CRANK CASE HEATER (M4, M7)	47	NA	STOP VALVE ASSY. (GAS) (M4, M7)
3	2441575	TERMINAL COVER (M4, M7)	48	2127879	STOP VALVE ASSY (M4, M7)
4	2311775	COMPRESSOR MOUNTING BOLT ASSY. (M4, M7)	49	2116831	VALVE CAP (M4, M7)
5	NA	GROUNDING TERMINAL (M4, M7)	50	2226992	LOW PRESSURE SENSOR (M4, M7)
6	2279686	COMPRESSOR SOUNDPROOF ASSY. (M4, M7)	51	NA	STOP VALVE ASSY. (GAS) (M4, M7)
7	2286855	RUBBER VIBRATION ISOLATOR (M4, M7)	52	2127918	STOP VALVE ASSY (M4, M7)
8	7500035	STOP VALVE MOUNTING PLATE (M4, M7)	53	2116831	VALVE CAP (M4, M7)
9	7009679	ACCUMULATOR ASSY. (M4, M7)	54	1944437	GAUGE JOINT WITH CHECK VALVE (M4, M7)
10	232005J	REFRIGERANT FILTER (M4, M7)	55	2227003	HIGH PRESSURE SENSOR (M4, M7)
11	2165972	BODY/ SOLENOID VALVE (HOT GAS BYPASS) (M4, M7)	56	2119861	BODY/ FOUR WAY VALVE (HEAT EXC. UPPER) (M4, M7)
12	7009622	COIL/ SOLENOID VALVE (HOT GAS BYPASS) (M4, M7)	57	6019596	BODY/ FOUR WAY VALVE (M4, M7)
13	2279484	WEIGHT (M4, M7)	58	7500059	COIL/ FOUR WAY VALVE (HEAT EXC. UPPER) (M4, M7)
14	7009680	WEIGHT ASSY. (M4, M7)	59	7500060	COIL/ FOUR WAY VALVE (HEAT EXC. LOWER) (M4, M7)
15	7009623	LIQUID RECEIVER ASSY. (M4, M7)	60	NA	SUCTION PIPE ASSY. (M4, M7)
16	7009455	FUSIBLE PLUG ASSY. (M4, M7)	61	2312879	WEIGHT (M4, M7)
17	NA	ELECTRONIC EXP. VALVE ASSY. (1) (M4, M7)	62	NA	DISCHARGE PIPE ASSY. (M4, M7)
18	7009625	PRESSURE CONTROL VALVE (M4, M7)	63	2397368	OIL SEPARATOR ASSY. (M4, M7)
19	147657J	BODY/ SOLENOID VALVE (LIQUID SHUT OFF) (M4, M7)	64	2009065	PLUMMET (M4, M7)
20	NA	ELECTRONIC EXP. VALVE ASSY. (2) (M4, M7)	65	NA	DISCHARGE PIPE ASSY. (1) (M4, M7)
21	2113337	FILTER (FOR REF.) (M4, M7)	66	7009608	HIGH PRESSURE SWITCH (M4, M7)
22	012000J	REFRIGERANT FILTER (M4, M7)	67	2282668	WEIGHT (M4, M7)
23	1086083	CHECK VALVE (M4, M7)	68	2317139	WEIGHT (M4, M7)
24	2233628	BODY/ ELE EXP. VALVE (REFRIGERANT COOLING) (M4, M7)	69	NA	DISCHARGE PIPE ASSY. (2) (M4, M7)
25	2204606	BODY/ ELE EXP. VALVE (SUBCOOL HEAT EXC.) (M4, M7)	70	2311845	CHECK VALVE (M4, M7)
26	NA	ELECTRONIC EXP. VALVE ASSY. (3) (M4, M7)	71	159971J	REFRIGERANT FILTER (M4, M7)
27	7500077	DOUBLE TUBE HEAT EXCH. ASSY. (M4, M7)	72	2279484	WEIGHT (M4, M7)
28	2113344	FILTER (FOR REF.) (M4, M7)	73	NA	DISCHARGE PIPE ASSY. (3) (M4, M7)
29	232005J	REFRIGERANT FILTER (M4, M7)	74	2165965	BODY/ SOLENOID VALVE (OS OIL RETURN 1) (M4, M7)
30	1996469	BODY/ ELE EXP. VALVE (RECEIVER GAS PURGE) (M4, M7)	75	7500071	COIL/ SOLENOID VALVE (OS OIL RETURN 1) (M4, M7)
31	NA	CAPILLARY TUBE (M4, M7)	76	4012537	FILTER (M4, M7)
32	2441506	COIL/ ELE EXP. VALVE (RECEIVER GAS PURGE) (M4, M7)	77	NA	DISCHARGE PIPE ASSY. (HOT GAS) (M4, M7)
33	7500040	COIL/ ELE EXP. VALVE (REFRIGERANT COOLING) (M4, M7)	78	2165972	BODY/ SOLENOID VALVE (HOT GAS BYPASS) (M4, M7)
34	2441513	COIL/ ELE EXP. VALVE (SUBCOOL HEAT EXC.) (M4, M7)	79	7500070	COIL/ SOLENOID VALVE (HOT GAS BYPASS) (M4, M7)
35	7500080	COIL/ SOLENOID VALVE (LIQUID SHUT OFF) (M4, M7)	80	NA	LIQUID PIPE ASSY. (M4, M7)
36	NA	REFRIGERANT PIPE ASSY. (M4, M7)	81	7009675	PLATE HEAT EXCHANGER ASSY. (M4, M7)
37	0650304	WATER PROOF CAP (M4, M7)	82	231501J	REFRIGERANT FILTER (M4, M7)
38	NA	REFRIGERANT PIPE ASSY. (M4, M7)	83	NA	STOP VALVE ASSY. (LIQUID) (M4, M7)
39	2387347	HEAT SINK ASSY. (M4, M7)	84	2103455	STOP VALVE (M4, M7)
40	2279484	WEIGHT (M4, M7)	85	143584J	CAP/ STOP VALVE (M4, M7)
41	7009678	WEIGHT (M4, M7)	86	1505111	PIPE CLAMP PLATE (M4, M7)
42	2103626	WIRE HARNESS (M4, M7)	87	1801415	BODY/ ELECTRONIC EXP. VALVE (INJECTION) (M4, M7)
43	2103633	HEX BOLT (M4, M7)	88	7500031	COIL/ ELE EXP. VALVE (HEAT EXC. UPPER) (M4, M7)
44	NA	REFRIGERANT PIPE ASSY. (M4, M7)	89	7500030	COIL/ ELE EXP. VALVE (HEAT EXC. LOWER) (M4, M7)
45	1944437	GAUGE JOINT WITH CHECK VALVE (M4, M7)	90	2441498	COIL/ ELE EXP. VALVE (INJECTION) (M4, M7)



**Ref. Part  
No: No:**

**Description:**

**Ref. Part  
No: No:**

**Description:**

**Image 1:**

91	7009700	WATER PROOF CAP (M4, M7)
92	NA	LIQUID PIPE ASSY. (M4, M7)
93	1996469	BODY/ ELECTRONIC EXP. VALVE (M4, M7)
94	231501J	REFRIGERANT FILTER (M4, M7)
95	2113344	FILTER (FOR REF.) (M4, M7)
96	NA	REFRIGERANT PIPE ASSY. (M4, M7)
97	7009455	FUSIBLE PLUG ASSY. (M4, M7)
98	2311799	WEIGHT (M4, M7)
99	4012540	HEX. BOLT (M4, M7)
100	128778J	THERMAL INSULATION (M4, M7)
101	7009684	WEIGHT (M4, M7)
102	7009680	WEIGHT ASSY. (M4, M7)
103	7009795	THERMAL INSULATION TUBE (M4, M7)
104	NA	THERMISTOR ASSY. (M4, M7)
105	NA	THERMISTOR ASSY. (M4, M7)
106	7009703	HEAT INSULATION TUBE (M4, M7)
107	144291J	HEAT INSULATION TUBE (M4, M7)
108	NA	THERMISTOR (M4, M7)
109	NA	ACCESSORIES ASSY. (M4, M7)
110	042408J	INSULATION TUBE/ REF. PIPING (M4, M7)
111	0424055	HEAT INSULATION COVER (M4, M7)
112	NA	TIE WRAP (M4, M7)
113	NA	THERMAL INSULATION TUBE (M4, M7)
114	NA	CLAMP/ LEAD WIRE (M4, M7)
115	1997424	ELECTRIC INSULATION (M4, M7)
116	056827J	TIE WRAP (M4, M7)
117	NA	ACCESSORIES ASSY. (M4, M7)
118	7500109	AUXILIARY PIPE (GAS SIDE FRONT) (M4, M7)
119	7500110	AUXILIARY PIPE (GAS SIDE BOTTOM) (M4, M7)
120	7500092	AUXILIARY PIPE DISCHARGE (GAS SIDE F) (M4, M7)
121	7500094	AUXILIARY PIPE DISCHARGE (GAS SIDE LOWER) (M4, M7)
122	7009576	AUXILIARY PIPE (LIQUID SIDE FRONT) (M4, M7)
123	7009578	AUXILIARY PIPE (LIQUID SIDE BOTTOM) (M4, M7)
124	1442816	ELBOW JOINT (M4, M7)
125	254105J	ELBOW JOINT (M4, M7)
126	7500085	THERMISTOR ASSY. (SUCTION) (M4, M7)
127	144290J	HEAT INSULATION TUBE (M4, M7)
128	165763J	THERMAL INSULATION TUBE (M4, M7)
129	144291J	HEAT INSULATION TUBE (M4, M7)

**Expanded Model Nomenclature**

M1 - REYQ120XATJU
M2 - REYQ120XAYCU
M3 - REYQ120XAYDU
M4 - REYQ144XATJU
M5 - REYQ144XAYCU
M6 - REYQ144XAYDU
M7 - REYQ168XATJU
M8 - REYQ168XAYCU
M9 - REYQ168XAYDU
M10 - REYQ72XATJU
M11 - REYQ72XAYCU
M12 - REYQ72XAYDU
M13 - REYQ96XATJU
M14 - REYQ96XAYCU
M15 - REYQ96XAYDU

REYQ144XATJU / REYQ168XATJU

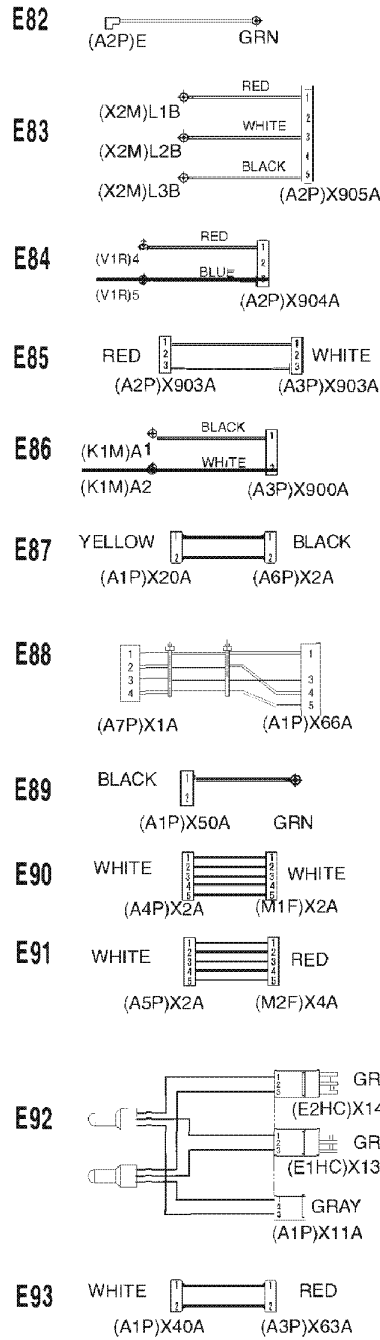
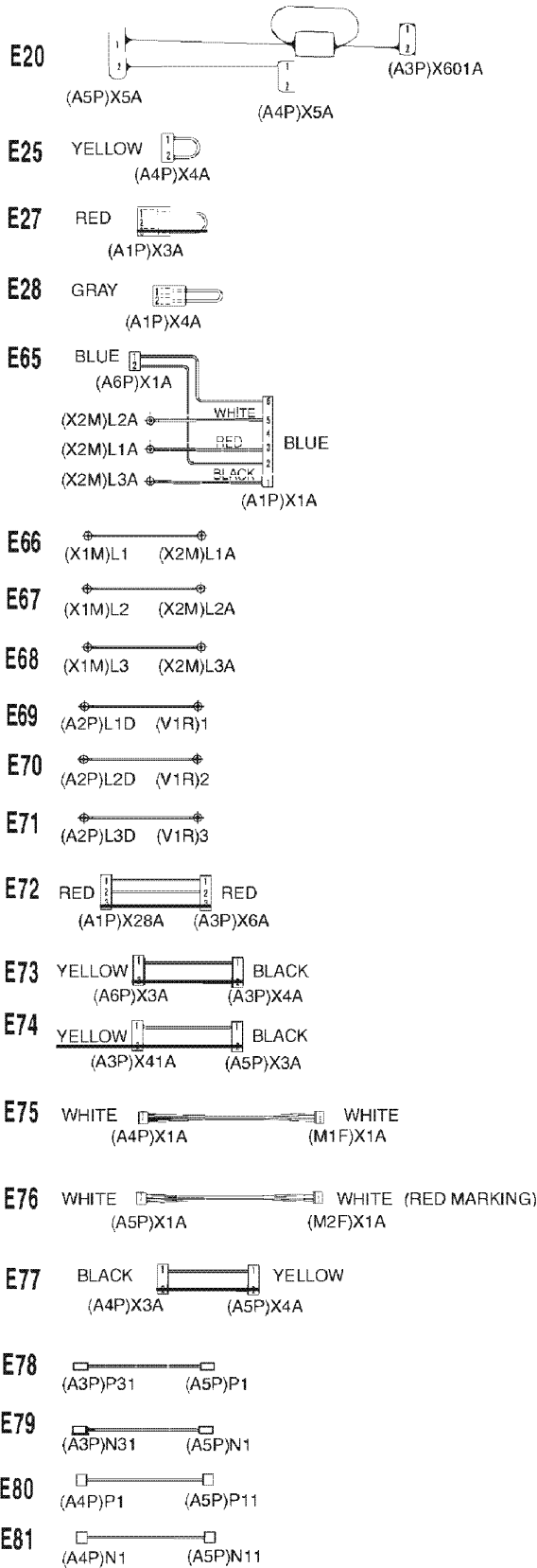

Picture Key	
Ref #	Picture #
1	E20
2	E25
3	E27
4	E28
5	E65
6	E66
7	E67
8	E68
9	E69
10	E70
11	E71
12	E72
13	E73
14	E74
15	E75
16	E76
17	E77
18	E78
19	E79
20	E80
21	E81
22	E82
23	E83
24	E84
25	E85
26	E86
27	E87
28	E88
29	E89
30	E90
31	E91
32	E92
33	E93

Ref. Part No:	Part No:	Description:	Ref. Part No:	Part No:	Description:
---------------	----------	--------------	---------------	----------	--------------

**Image 1:**

1	2270292	WIRE HARNESS ASSY. (M4, M7)
2	1933413	CONNECTOR/ SHORT CIRCUIT (M4, M7)
3	135234J	CONNECTOR/ SHORT CIRCUIT (M4, M7)
4	2233712	CONNECTOR (M4, M7)
5	7009776	WIRE HARNESS (M4, M7)
6	7009777	WIRE HARNESS (M4, M7)
7	7009778	WIRE HARNESS (M4, M7)
8	7009779	WIRE HARNESS (M4, M7)
9	7009780	WIRE HARNESS (M4, M7)
10	7009781	WIRE HARNESS (M4, M7)
11	7009782	WIRE HARNESS (M4, M7)
12	7009763	WIRE HARNESS (M4, M7)
13	4014819	WIRE HARNESS (M4, M7)
14	2093301	WIRE HARNESS (M4, M7)
15	2299091	WIRE HARNESS ASSY. (M4, M7)
16	2299109	WIRE HARNESS ASSY. (M4, M7)
17	6019724	WIRE HARNESS (M4, M7)
18	2093750	WIRE HARNESS (M4, M7)
19	7009783	WIRE HARNESS (M4, M7)
20	6019712	WIRE HARNESS (M4, M7)
21	7009733	WIRE HARNESS (M4, M7)
22	7009784	WIRE HARNESS (M4, M7)
23	7009785	WIRE HARNESS (M4, M7)
24	7009786	WIRE HARNESS (M4, M7)
25	7009787	WIRE HARNESS (M4, M7)
26	7009788	WIRE HARNESS (M4, M7)
27	7009734	WIRE HARNESS (M4, M7)
28	7009735	WIRE HARNESS ASSY. (M4, M7)
29	7009729	WIRE HARNESS (M4, M7)
30	7009730	WIRE HARNESS (M4, M7)
31	7009731	WIRE HARNESS (M4, M7)
32	7009732	WIRE HARNESS ASSY. (M4, M7)
33	7009736	WIRE HARNESS (M4, M7)

**Expanded Model Nomenclature**

- |                   |
|-------------------|
| M1 - REYQ120XATJU |
| M2 - REYQ120XAYCU |
| M3 - REYQ120XAYDU |
| M4 - REYQ144XATJU |
| M5 - REYQ144XAYCU |
| M6 - REYQ144XAYDU |
| M7 - REYQ168XATJU |
| M8 - REYQ168XAYCU |
| M9 - REYQ168XAYDU |
| M10 - REYQ72XATJU |
| M11 - REYQ72XAYCU |
| M12 - REYQ72XAYDU |
| M13 - REYQ96XATJU |
| M14 - REYQ96XAYCU |
| M15 - REYQ96XAYDU |

# REYQ144XATJU / REYQ168XATJU

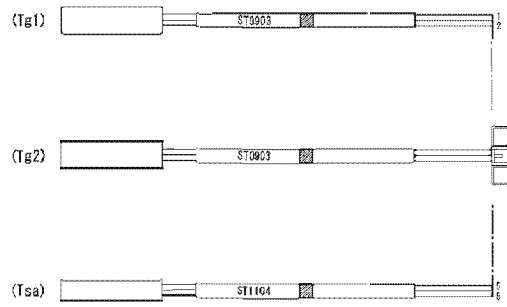

Picture Key	
Ref #	Picture #
1	K11
2	K12
3	K18
4	K5

**K5**  
R8T-R9T-R10T

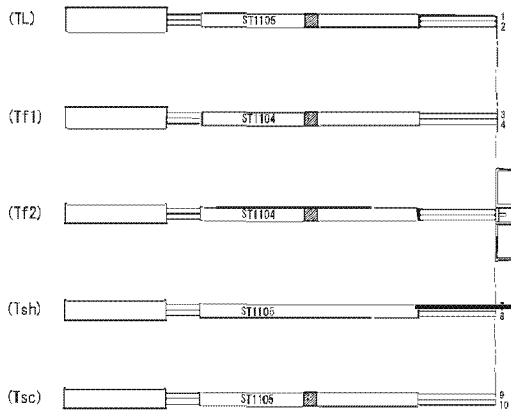

**K11**  
R3T-R4T-R5T-R6T-R7T

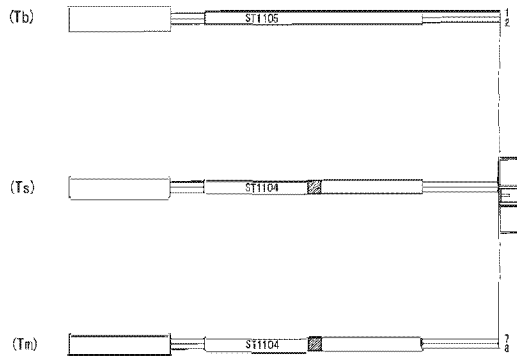

**K12**  
R11T-R12T-R13T

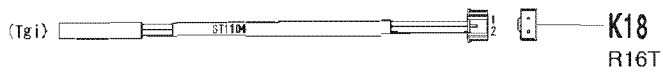

**K18**  
R16T

**Ref. Part  
No: No:**

**Description:**

**Ref. Part  
No: No:**

**Description:**

---

**Image 1:**

1	NA	THERMISTOR ASSY. (M4, M7)
2	NA	THERMISTOR ASSY. (M4, M7)
3	NA	THERMISTOR (M4, M7)
4	7500085	THERMISTOR ASSY. (SUCTION) (M4, M7)

**Expanded Model Nomenclature**

M1 - REYQ120XATJU
M2 - REYQ120XAYCU
M3 - REYQ120XAYDU
M4 - REYQ144XATJU
M5 - REYQ144XAYCU
M6 - REYQ144XAYDU
M7 - REYQ168XATJU
M8 - REYQ168XAYCU
M9 - REYQ168XAYDU
M10 - REYQ72XATJU
M11 - REYQ72XAYCU
M12 - REYQ72XAYDU
M13 - REYQ96XATJU
M14 - REYQ96XAYCU
M15 - REYQ96XAYDU

REYQ72XAYCU / REYQ96XAYCU / REYQ120XAYCU

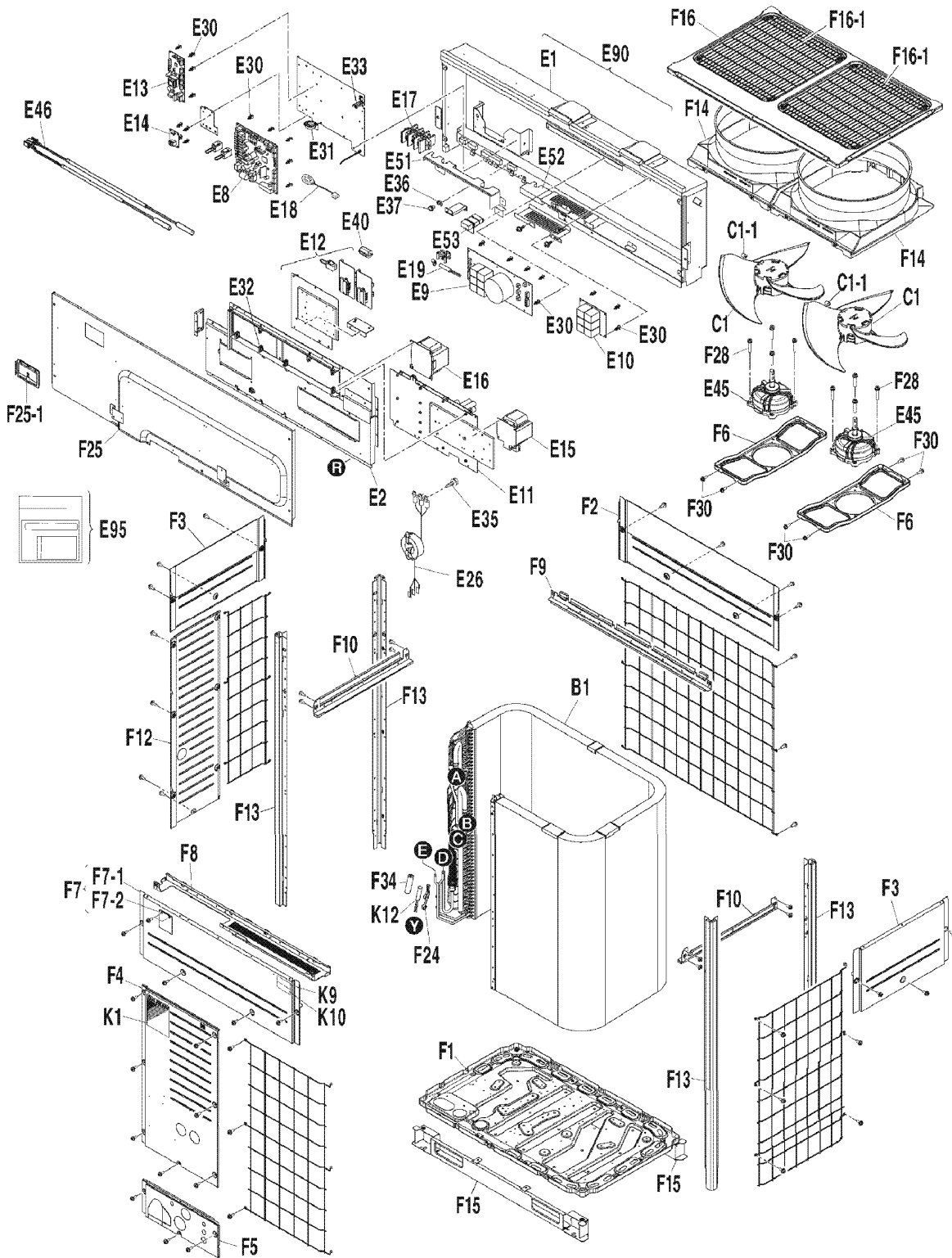

Picture Key	
Ref #	Picture #
1	B1
2	C1
3	C1-1
4	E1
5	E10
6	E11
7	E12
8	E13
9	E14
10	E15
11	E16
12	E17
13	E18
14	E19
15	E2
16	E26
17	E30
18	E31
19	E32
20	E33
21	E35
22	E36
23	E37
24	E40
25	E45
26	E46
27	E51
28	E52
29	E53
30	E8
31	E9
32	E90
33	E95
34	F1
35	F10
36	F12
37	F13
38	F14
39	F15
40	F16
41	F16-1
42	F2
43	F24
44	F25
45	F25-1
46	F28
47	F3
48	F30
49	F34
50	F4
51	F5
52	F6
53	F7
54	F7-1
55	F7-2
56	F8
57	F9
58	K1
59	K10
60	K9

Ref. Part No:	Part No:	Description:	Ref. Part No:	Part No:	Description:															
<b>Image 1:</b>			<b>Image 1:</b>																	
1	7009599	PLATE FINNED COIL HEAT EXCH. ASSY. (M2, M11, M14)	53	2441537	FRONT PLATE ASSY. (M2, M11, M14)															
2	7009517	PROPELLER FAN ASSY. (M2, M11, M14)	54	NA	FRONT PLATE (M2, M11, M14)															
3	057178J	HEX SOCKET SCREW (M2, M11, M14)	55	NA	SERVICE PLATE ASSY. (M2, M11, M14)															
4	NA	SWITCH BOX ASSY. (M2, M11, M14)	56	7009536	STAY ASSY. (FRONT) (M2, M11, M14)															
5	7009635	PCB (NOISE FILTER) (M2, M11, M14)	57	7009537	STAY (REAR) (M2, M11, M14)															
6	7009636	PCB. (INVERTER) (M2, M11, M14)	58	7009692	BRAND NAME LABEL (M2, M11, M14)															
7	7009637	PCB. (FAN) (M2, M11, M14)	59	4023075	CAUTION LABEL (ROTATING) (M2, M11, M14)															
8	7500014	PCB (SUB) (M2, M11, M14)	60	4010207	LABEL (WARNING) (M2, M11, M14)															
9	1716788	PCB. (ABC I/P) (M2, M11, M14)	<b>Expanded Model Nomenclature</b>																	
10	7009638	REACTOR (M2, M11, M14)	<table border="1"> <tr><td>M1 - REYQ120XATJU</td></tr> <tr><td>M2 - REYQ120XAYCU</td></tr> <tr><td>M3 - REYQ120XAYDU</td></tr> <tr><td>M4 - REYQ144XATJU</td></tr> <tr><td>M5 - REYQ144XAYCU</td></tr> <tr><td>M6 - REYQ144XAYDU</td></tr> <tr><td>M7 - REYQ168XATJU</td></tr> <tr><td>M8 - REYQ168XAYCU</td></tr> <tr><td>M9 - REYQ168XAYDU</td></tr> <tr><td>M10 - REYQ72XATJU</td></tr> <tr><td>M11 - REYQ72XAYCU</td></tr> <tr><td>M12 - REYQ72XAYDU</td></tr> <tr><td>M13 - REYQ96XATJU</td></tr> <tr><td>M14 - REYQ96XAYCU</td></tr> <tr><td>M15 - REYQ96XAYDU</td></tr> </table>			M1 - REYQ120XATJU	M2 - REYQ120XAYCU	M3 - REYQ120XAYDU	M4 - REYQ144XATJU	M5 - REYQ144XAYCU	M6 - REYQ144XAYDU	M7 - REYQ168XATJU	M8 - REYQ168XAYCU	M9 - REYQ168XAYDU	M10 - REYQ72XATJU	M11 - REYQ72XAYCU	M12 - REYQ72XAYDU	M13 - REYQ96XATJU	M14 - REYQ96XAYCU	M15 - REYQ96XAYDU
M1 - REYQ120XATJU																				
M2 - REYQ120XAYCU																				
M3 - REYQ120XAYDU																				
M4 - REYQ144XATJU																				
M5 - REYQ144XAYCU																				
M6 - REYQ144XAYDU																				
M7 - REYQ168XATJU																				
M8 - REYQ168XAYCU																				
M9 - REYQ168XAYDU																				
M10 - REYQ72XATJU																				
M11 - REYQ72XAYCU																				
M12 - REYQ72XAYDU																				
M13 - REYQ96XATJU																				
M14 - REYQ96XAYCU																				
M15 - REYQ96XAYDU																				
11	7009639	LOW FREQUENCY TRANSFORMER (M2, M11, M14)																		
12	7009522	TERMINAL BLOCK (M2, M11, M14)																		
13	2117168	CURRENT TRANSFORMER (M2, M11, M14)																		
14	1782095	THERMISTOR (AIR) (M2, M11, M14)																		
15	7009632	EL. COMPO. MOUNTING PLATE (INVERTER) (M2, M11, M14)																		
16	7009642	WIRE HARNESS ASSY. (COMP.) (M2, M11, M14)																		
17	380401J	LOCKING CARD SPACER (M2, M11, M14)																		
18	2010250	WIRE CLIP (M2, M11, M14)																		
19	027843J	WIRE CLIP (M2, M11, M14)																		
20	0207661	LOCKING WIRE SADDLE (M2, M11, M14)																		
21	NA	PAN HEAD MACHINE SCREW (M2, M11, M14)																		
22	066578J	CUP WASHER (M2, M11, M14)																		
23	NA	EARTH TERMINAL SCREW (M2, M11, M14)																		
24	4012628	FERRITE CORE (M2, M11, M14)																		
25	7009643	DC FAN MOTOR (M2, M11, M14)																		
26	7009644	THERMISTOR ASSY. (M2, M11, M14)																		
27	NA	EL. COMPO. MOUNTING PLATE ASSY. (M2, M11, M14)																		
28	NA	SEALING MATERIAL (SWITCH BOX) (M2, M11, M14)																		
29	NA	SEALING MATERIAL ASSY. (M2, M11, M14)																		
30	2441544	PCB(MAIN) (M2, M11, M14)																		
31	7009634	PCB (NOISE FILTER) (M2, M11, M14)																		
32	NA	ELECTRIC COMPONENT ASSY. (M2, M11, M14)																		
33	NA	GREASE ASSY. (M2, M11, M14)																		
34	7009530	BOTTOM FRAME (M2, M11, M14)																		
35	7009478	STAY (RIGHT/ LEFT) (M2, M11, M14)																		
36	7009480	SIDE PLATE (M2, M11, M14)																		
37	7009481	SUPPORT (M2, M11, M14)																		
38	7009588	BELL MOUTH (M2, M11, M14)																		
39	7009538	BRACKET (M2, M11, M14)																		
40	7009539	TOP PLATE ASSY. (M2, M11, M14)																		
41	7500121	DISCHARGE GRILLE (M2, M11, M14)																		
42	7009531	FRONT PLATE (UPPER) (M2, M11, M14)																		
43	042396J	FITTING SPRING/ THERMISTOR (M2, M11, M14)																		
44	NA	COVER/ SWITCH BOX ASSY. (M2, M11, M14)																		
45	128777J	INSPECTION HOLE (M2, M11, M14)																		
46	7009486	HEX HEAD TAPPING SCREW (M2, M11, M14)																		
47	7009471	SIDE PLATE (UPPER) (M2, M11, M14)																		
48	0493462	TAPPING SCREW (M2, M11, M14)																		
49	144290J	HEAT INSULATION TUBE (M2, M11, M14)																		
50	7009532	FRONT PLATE (M2, M11, M14)																		
51	7009533	FRONT PLATE (BOTTOM) (M2, M11, M14)																		
52	7009534	MOTOR MOUNTING PLATE (M2, M11, M14)																		





Ref. Part No: No:	Description:	Ref. Part No: No:	Description:
<b>Image 1:</b>		<b>Image 1:</b>	
1	7009593	38	2103626
2	7009598	39	2103633
3	2441481	40	NA
4	2311775	41	1944437
5	NA	42	7500061
6	2278885	43	NA
7	2278892	44	2127879
8	2286848	45	2116831
9	7500035	46	2226992
10	7009621	47	NA
11	232005J	48	2127901
12	2165972	49	2116831
13	7009622	50	1944437
14	7009623	51	2227003
15	7009455	52	2119861
16	NA	53	6019596
17	7009625	54	7500059
18	147657J	55	7500060
19	NA	56	NA
20	2113337	57	NA
21	012000J	58	7009607
22	1086083	59	2311799
23	2233628	60	NA
24	2204606	61	7009608
25	NA	62	NA
26	7500077	63	2103479
27	2113344	64	2096331
28	232005J	65	NA
29	1996469	66	2165965
30	NA	67	7500071
31	2441506	68	4012537
32	7500040	69	NA
33	2441513	70	2165972
34	7500080	71	7500070
35	NA	72	NA
36	0650304	73	7009610
37	7009601	74	231501J
		75	NA
		76	2103455
		77	143584J
		78	1505111
		79	1801415

Ref. Part No:	Part No:	Description:	Ref. Part No:	Part No:	Description:
<b>Image 1:</b>			<b>Image 1:</b>		
80	7500031	COIL/ ELE EXP. VALVE (HEAT EXC. UPPER) (M2, M11, M14)	122	7009578	AUXILIARY PIPE (LIQUID SIDE BOTTOM) (M2)
81	7500030	COIL/ ELE EXP. VALVE (HEAT EXC. LOWER) (M2, M11, M14)	122	7500097	AUXILIARY PIPE (LIQUID SIDE BOTTOM) (M11, M14)
82	2441498	COIL/ ELE EXP. VALVE (INJECTION) (M2, M11, M14)	123	1799257	L-TYPE JOINT (M2, M11, M14)
83	7009700	WATER PROOF CAP (M2, M11, M14)	124	254105J	ELBOW JOINT (M2, M11, M14)
84	NA	LIQUID PIPE ASSY. (M2, M11, M14)	125	144290J	HEAT INSULATION TUBE (M2, M11, M14)
85	1996469	BODY/ ELECTRONIC EXP. VALVE (M2, M11, M14)	125	7500085	THERMISTOR ASSY. (SUCTION) (M2, M11, M14)
86	231501J	REFRIGERANT FILTER (M2, M11, M14)	127	165763J	THERMAL INSULATION TUBE (M2, M11, M14)
87	2113344	FILTER (FOR REF.) (M2, M11, M14)	128	144291J	HEAT INSULATION TUBE (M2, M11, M14)
88	NA	REFRIGERANT PIPE ASSY. (M2, M11, M14)	<b>Expanded Model Nomenclature</b>		
89	7009455	FUSIBLE PLUG ASSY. (M2, M11, M14)	M1 - REYQ120XATJU		
90	7009618	SUCTION PIPE ASSY. (1) (M2, M11, M14)	M2 - REYQ120XAYCU		
91	7009620	WEIGHT (M2, M11, M14)	M3 - REYQ120XAYDU		
92	2317139	WEIGHT (M2, M11, M14)	M4 - REYQ144XATJU		
93	4012540	HEX BOLT (M2, M11, M14)	M5 - REYQ144XAYCU		
94	128153J	THERMAL INSULATION (M2, M11, M14)	M6 - REYQ144XAYDU		
95	NA	THERMAL INSULATION TUBE (M2, M11, M14)	M7 - REYQ168XATJU		
96	6026549	WEIGHT (M2, M11, M14)	M8 - REYQ168XAYCU		
97	7009680	WEIGHT ASSY. (M2, M11, M14)	M9 - REYQ168XAYDU		
98	7009678	WEIGHT (M2, M11, M14)	M10 - REYQ72XATJU		
99	2317139	WEIGHT (M2, M11, M14)	M11 - REYQ72XAYCU		
100	NA	THERMISTOR ASSY. (M2, M11, M14)	M12 - REYQ72XAYDU		
101	NA	THERMISTOR ASSY. (M2, M11, M14)	M13 - REYQ96XATJU		
102	7009703	HEAT INSULATION TUBE (M2, M11, M14)	M14 - REYQ96XAYCU		
103	144291J	HEAT INSULATION TUBE (M2, M11, M14)	M15 - REYQ96XAYDU		
104	NA	MOUNTING PLATE ASSY. (M2, M11, M14)			
105	NA	THERMAL INSULATION TAPE (M2, M11, M14)			
106	NA	TAPE (ALMINIUM) (M2, M11, M14)			
107	NA	THERMISTOR (M2, M11, M14)			
108	NA	ACCESSORIES ASSY. (M2, M11, M14)			
109	042408J	INSULATION TUBE/ REF. PIPING (M2, M11, M14)			
110	0424055	HEAT INSULATION COVER (M2, M11, M14)			
111	NA	TIE WRAP (M2, M11, M14)			
112	NA	THERMAL INSULATION TUBE (M2, M11, M14)			
113	NA	CLAMP/ LEAD WIRE (M2, M11, M14)			
114	1997424	ELECTRIC INSULATION (M2, M11, M14)			
115	056827J	TIE WRAP (M2, M11, M14)			
116	NA	ACCESSORIES ASSY. (M2, M11, M14)			
117	7009542	AUXILIARY PIPE (GAS SIDE FRONT) (M2)			
117	7500052	AUXILIARY PIPE (GAS SIDE FRONT) (M11)			
117	7500090	AUXILIARY PIPE (GAS SIDE FRONT) (M14)			
118	7009544	AUXILIARY PIPE (GAS SIDE BOTTOM) (M2)			
118	7500053	AUXILIARY PIPE (GAS SIDE BOTTOM) (M11)			
118	7500091	AUXILIARY PIPE (GAS SIDE BOTTOM) (M14)			
119	7500054	AUXILIARY PIPE (H AND L PRESSURE) (M11)			
119	7500093	AUXILIARY PIPE DISCHARGE (GAS SIDE F) (M2, M14)			
120	7500055	AUXILIARY PIPE (H AND L PRESSURE) (M11)			
120	7500095	AUXILIARY PIPE DISCHARGE (GAS SIDE LOWER) (M2, M14)			
121	7009576	AUXILIARY PIPE (LIQUID SIDE FRONT) (M2)			
121	7500096	AUXILIARY PIPE (LIQUID SIDE FRONT) (M11, M14)			

REYQ72XAYCU / REYQ96XAYCU / REYQ120XAYCU

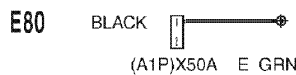
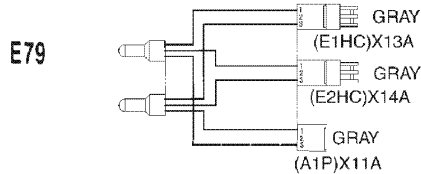
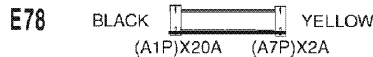
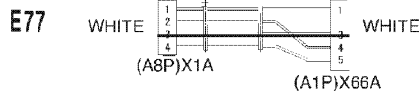
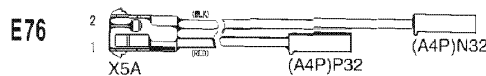
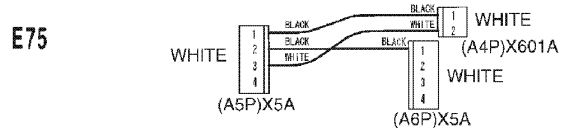
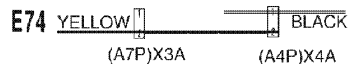
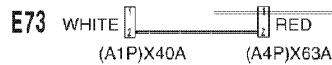
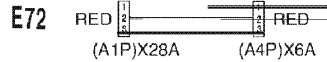
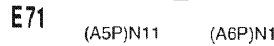
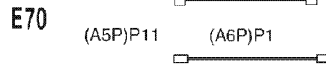
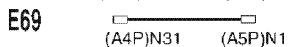
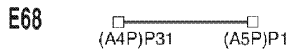
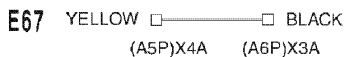
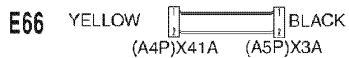
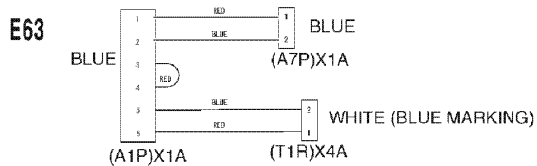
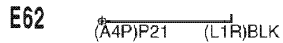
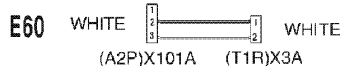
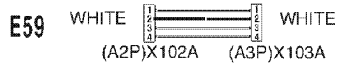
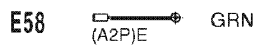
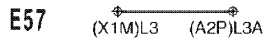
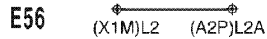
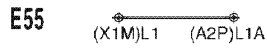
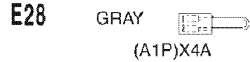
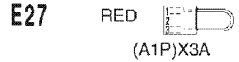
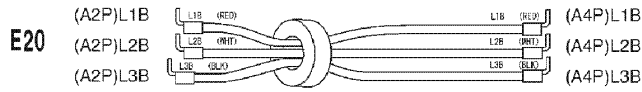

Picture Key

Ref #	Picture #
1	E20
2	E25
3	E27
4	E28
5	E55
6	E56
7	E57
8	E58
9	E59
10	E60
11	E61
12	E62
13	E63
14	E64
15	E65
16	E66
17	E67
18	E68
19	E69
20	E70
21	E71
22	E72
23	E73
24	E74
25	E75
26	E76
27	E77
28	E78
29	E79
30	E80

Ref. Part No:	Part No:	Description:	Ref. Part No:	Part No:	Description:
---------------	----------	--------------	---------------	----------	--------------

**Image 1:**

1	7009641	WIRE HARNESS ASSY. (M2, M11, M14)
2	1933413	CONNECTOR/ SHORT CIRCUIT (M2, M11, M14)
3	135234J	CONNECTOR/ SHORT CIRCUIT (M2, M11, M14)
4	2233712	CONNECTOR (M2, M11, M14)
5	7009737	WIRE HARNESS (M2, M11, M14)
6	7009738	WIRE HARNESS (M2, M11, M14)
7	7009739	WIRE HARNESS (M2, M11, M14)
8	7009740	WIRE HARNESS (M2, M11, M14)
9	7009741	WIRE HARNESS (M2, M11, M14)
10	7009742	WIRE HARNESS (M2, M11, M14)
11	7009743	WIRE HARNESS (M2, M11, M14)
12	7009744	WIRE HARNESS (M2, M11, M14)
13	7009745	WIRE HARNESS ASSY. (M2, M11, M14)
14	7009746	WIRE HARNESS ASSY. (M2, M11, M14)
15	7009747	WIRE HARNESS ASSY. (M2, M11, M14)
16	4014821	WIRE HARNESS (M2, M11, M14)
17	6019724	WIRE HARNESS (M2, M11, M14)
18	7009748	WIRE HARNESS (M2, M11, M14)
19	7009749	WIRE HARNESS (M2, M11, M14)
20	6019712	WIRE HARNESS (M2, M11, M14)
21	7009750	WIRE HARNESS (M2, M11, M14)
22	7009751	WIRE HARNESS (M2, M11, M14)
23	7009752	WIRE HARNESS (M2, M11, M14)
24	6019716	WIRE HARNESS (M2, M11, M14)
25	7009753	WIRE HARNESS ASSY. (M2, M11, M14)
26	7009754	WIRE HARNESS ASSY. (M2, M11, M14)
27	7009735	WIRE HARNESS ASSY. (M2, M11, M14)
28	7009734	WIRE HARNESS (M2, M11, M14)
29	7009732	WIRE HARNESS ASSY. (M2, M11, M14)
30	7009729	WIRE HARNESS (M2, M11, M14)

**Expanded Model Nomenclature**

- M1 - REYQ120XATJU
- M2 - REYQ120XAYCU
- M3 - REYQ120XAYDU
- M4 - REYQ144XATJU
- M5 - REYQ144XAYCU
- M6 - REYQ144XAYDU
- M7 - REYQ168XATJU
- M8 - REYQ168XAYCU
- M9 - REYQ168XAYDU
- M10 - REYQ72XATJU
- M11 - REYQ72XAYCU
- M12 - REYQ72XAYDU
- M13 - REYQ96XATJU
- M14 - REYQ96XAYCU
- M15 - REYQ96XAYDU

**REYQ72XAYCU / REYQ96XAYCU / REYQ120XAYCU**

Picture Key

Ref #	Picture #
1	K11
2	K12
3	K18
4	K5

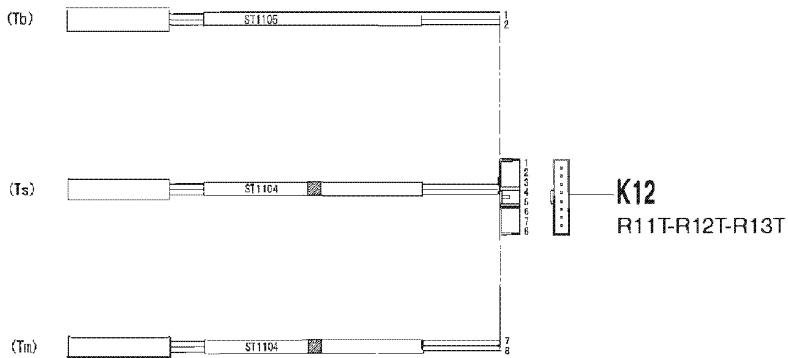
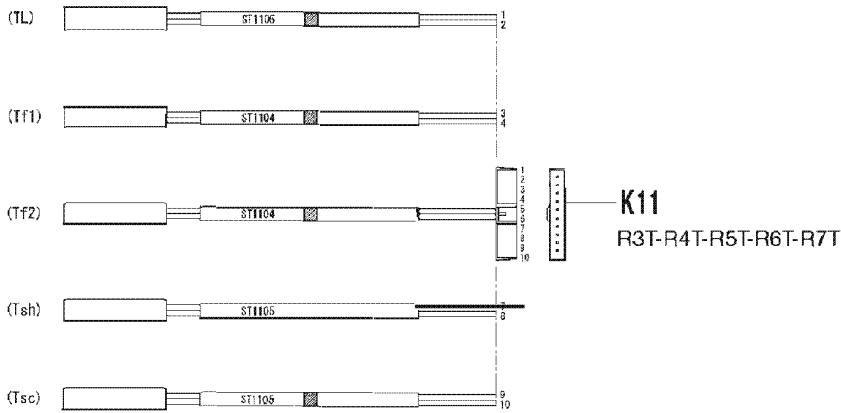
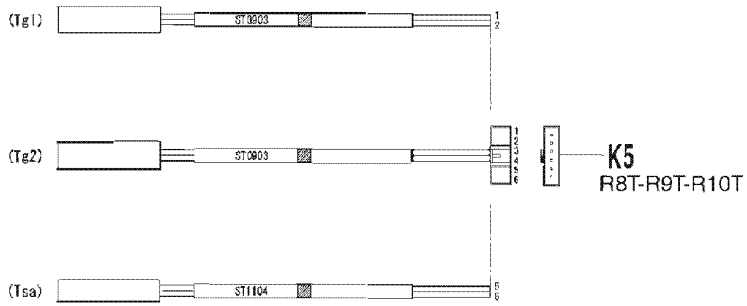

**Ref. Part  
No: No:**

**Description:**

**Ref. Part  
No: No:**

**Description:**

---

**Image 1:**

1	NA	THERMISTOR ASSY. (M2, M11, M14)
2	NA	THERMISTOR ASSY. (M2, M11, M14)
3	NA	THERMISTOR (M2, M11, M14)
4	7500085	THERMISTOR ASSY. (SUCTION) (M2, M11, M14)

**Expanded Model Nomenclature**

M1 - REYQ120XATJU
M2 - REYQ120XAYCU
M3 - REYQ120XAYDU
M4 - REYQ144XATJU
M5 - REYQ144XAYCU
M6 - REYQ144XAYDU
M7 - REYQ168XATJU
M8 - REYQ168XAYCU
M9 - REYQ168XAYDU
M10 - REYQ72XATJU
M11 - REYQ72XAYCU
M12 - REYQ72XAYDU
M13 - REYQ96XATJU
M14 - REYQ96XAYCU
M15 - REYQ96XAYDU

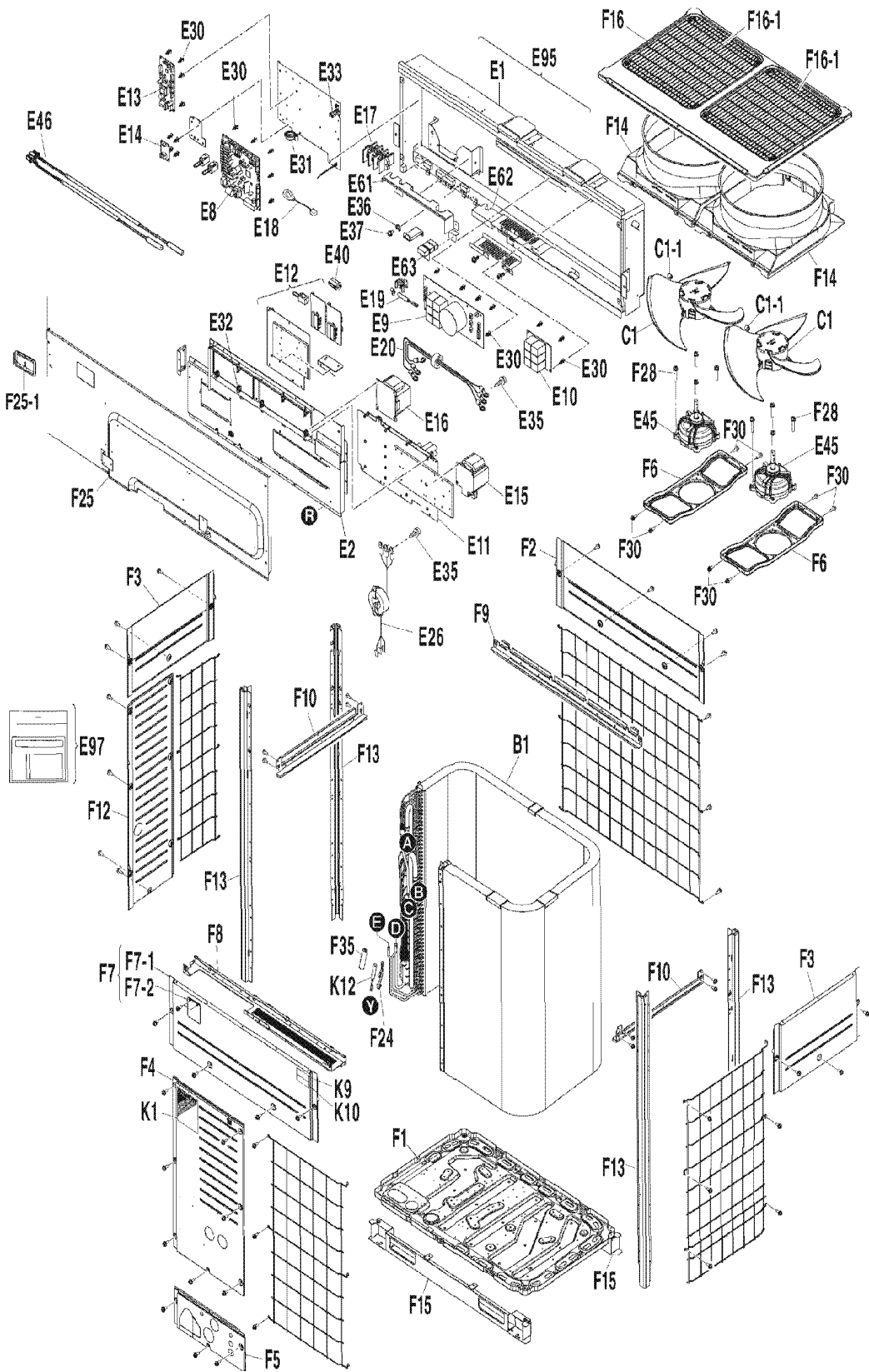

Picture Key	
Ref #	Picture #
1	B1
2	C1
3	C1-1
4	E1
5	E10
6	E11
7	E12
8	E13
9	E14
10	E15
11	E16
12	E17
13	E18
14	E19
15	E2
16	E31
17	E32
18	E33
19	E35
20	E36
21	E37
22	E40
23	E45
24	E46
25	E61
26	E62
27	E63
28	E8
29	E9
30	E95
31	E97
32	F1
33	F10
34	F12
35	F13
36	F14
37	F15
38	F16
39	F16-1
40	F2
41	F24
42	F25
43	F25-1
44	F28
45	F3
46	F30
47	F35
48	F4
49	F5
50	F6
51	F7
52	F7-1
53	F7-2
54	F8
55	F9
56	K1
57	K2
58	K2-1
59	K2-2
60	K2-3
61	K2-4
62	K4
63	K4-1
64	K4-2
65	K4-3
66	K4-4
67	K4-5
68	K4-6
69	K4-7
70	K4-8
71	K9

Ref. Part No: No:	Description:	Ref. Part No: No:	Description:															
<b>Image 1:</b>		<b>Image 1:</b>																
1	7009599	56	7009692															
	PLATE FINNED COIL HEAT EXCH. ASSY. (M5, M8)		BRAND NAME LABEL (M5, M8)															
2	7009517	57	NA															
	PROPELLER FAN ASSY. (M5, M8)		ACCESSORIES ASSY. (M5, M8)															
3	057178J	58	NA															
	HEX SOCKET SCREW (M5, M8)		TIE WRAP (M5, M8)															
4	NA	59	NA															
	SWITCH BOX ASSY. (M5, M8)		CLAMP/ LEAD WIRE (M5, M8)															
5	7009635	60	1997424															
	PCB (NOISE FILTER) (M5, M8)		ELECTRIC INSULATION (M5, M8)															
6	7009681	61	056827J															
	PRINTED CIRCUIT ASSY. (INVERTER) (M5, M8)		TIE WRAP (M5, M8)															
7	7009637	62	NA															
	PCB (FAN) (M5, M8)		ACCESSORIES ASSY. (M5, M8)															
8	7500014	63	7500109															
	PCB (SUB) (M5, M8)		AUXILIARY PIPE (GAS SIDE FRONT) (M5, M8)															
9	1716788	64	7500110															
	PCB (ABC I/P) (M5, M8)		AUXILIARY PIPE (GAS SIDE BOTTOM) (M5, M8)															
10	7009682	65	7500092															
	REACTOR (M5, M8)		AUXILIARY PIPE DISCHARGE (GAS SIDE F) (M5, M8)															
11	7009639																	
	LOW FREQUENCY TRANSFORMER (M5, M8)	66	7500094															
12	7009522		AUXILIARY PIPE DISCHARGE (GAS SIDE LOWER) (M5, M8)															
	TERMINAL BLOCK (M5, M8)	67	7009575															
13	2117168		AUXILIARY PIPE (LIQUID SIDE FRONT) (M8)															
	CURRENT TRANSFORMER (M5, M8)	67	7009576															
14	1782095		AUXILIARY PIPE (LIQUID SIDE FRONT) (M5)															
	THERMISTOR (AIR) (M5, M8)	68	7009577															
15	7009632		AUXILIARY PIPE (LIQUID SIDE BOTTOM) (M8)															
	EL. COMPO. MOUNTING PLATE (INVERTER) (M5, M8)	68	7009578															
			AUXILIARY PIPE (LIQUID SIDE BOTTOM) (M5)															
16	2010250	69	1442816															
	WIRE CLIP (M5, M8)		ELBOW JOINT (M5, M8)															
17	027843J	70	254105J															
	WIRE CLIP (M5, M8)		ELBOW JOINT (M5, M8)															
18	0207661	71	4010207															
	LOCKING WIRE SADDLE (M5, M8)		LABEL (WARNING) (M5, M8)															
19	NA																	
	PAN HEAD MACHINE SCREW (M5, M8)	<b>Expanded Model Nomenclature</b>																
20	066578J	<table border="1"> <tr><td>M1 - REYQ120XATJU</td></tr> <tr><td>M2 - REYQ120XAYCU</td></tr> <tr><td>M3 - REYQ120XAYDU</td></tr> <tr><td>M4 - REYQ144XATJU</td></tr> <tr><td>M5 - REYQ144XAYCU</td></tr> <tr><td>M6 - REYQ144XAYDU</td></tr> <tr><td>M7 - REYQ168XATJU</td></tr> <tr><td>M8 - REYQ168XAYCU</td></tr> <tr><td>M9 - REYQ168XAYDU</td></tr> <tr><td>M10 - REYQ72XATJU</td></tr> <tr><td>M11 - REYQ72XAYCU</td></tr> <tr><td>M12 - REYQ72XAYDU</td></tr> <tr><td>M13 - REYQ96XATJU</td></tr> <tr><td>M14 - REYQ96XAYCU</td></tr> <tr><td>M15 - REYQ96XAYDU</td></tr> </table>		M1 - REYQ120XATJU	M2 - REYQ120XAYCU	M3 - REYQ120XAYDU	M4 - REYQ144XATJU	M5 - REYQ144XAYCU	M6 - REYQ144XAYDU	M7 - REYQ168XATJU	M8 - REYQ168XAYCU	M9 - REYQ168XAYDU	M10 - REYQ72XATJU	M11 - REYQ72XAYCU	M12 - REYQ72XAYDU	M13 - REYQ96XATJU	M14 - REYQ96XAYCU	M15 - REYQ96XAYDU
M1 - REYQ120XATJU																		
M2 - REYQ120XAYCU																		
M3 - REYQ120XAYDU																		
M4 - REYQ144XATJU																		
M5 - REYQ144XAYCU																		
M6 - REYQ144XAYDU																		
M7 - REYQ168XATJU																		
M8 - REYQ168XAYCU																		
M9 - REYQ168XAYDU																		
M10 - REYQ72XATJU																		
M11 - REYQ72XAYCU																		
M12 - REYQ72XAYDU																		
M13 - REYQ96XATJU																		
M14 - REYQ96XAYCU																		
M15 - REYQ96XAYDU																		
21	NA		EARTH TERMINAL SCREW (M5, M8)															
22	4012628		FERRITE CORE (M5, M8)															
23	7009643		DC FAN MOTOR (M5, M8)															
24	7009683		THERMISTOR ASSY. (M5, M8)															
25	NA		EL. COMPO. MOUNTING PLATE ASSY. (M5, M8)															
26	NA		SEALING MATERIAL (SWITCH BOX) (M5, M8)															
27	NA		SEALING MATERIAL ASSY. (M5, M8)															
28	2441544		PCB (MAIN) (M5, M8)															
29	7009634		PCB (NOISE FILTER) (M5, M8)															
30	NA		ELECTRIC COMPONENT ASSY. (M5, M8)															
31	NA		GREASE ASSY. (M5, M8)															
32	7009530		BOTTOM FRAME (M5, M8)															
33	7009478		STAY (RIGHT/ LEFT) (M5, M8)															
34	7009480		SIDE PLATE (M5, M8)															
35	7009481		SUPPORT (M5, M8)															
36	7009588		BELL MOUTH (M5, M8)															
37	7009538		BRACKET (M5, M8)															
38	7009539		TOP PLATE ASSY. (M5, M8)															
39	7500121		DISCHARGE GRILLE (M5, M8)															
40	7009531		FRONT PLATE (UPPER) (M5, M8)															
41	042396J		FITTING SPRING/ THERMISTOR (M5, M8)															
42	NA		COVER/ SWITCH BOX ASSY. (M5, M8)															
43	128777J		INSPECTION HOLE (M5, M8)															
44	7009486		HEX HEAD TAPPING SCREW (M5, M8)															
45	7009471		SIDE PLATE (UPPER) (M5, M8)															
46	0493462		TAPPING SCREW (M5, M8)															
47	144290J		HEAT INSULATION TUBE (M5, M8)															
48	7009532		FRONT PLATE (M5, M8)															
49	7009533		FRONT PLATE (BOTTOM) (M5, M8)															
50	7009534		MOTOR MOUNTING PLATE (M5, M8)															
51	2441537		FRONT PLATE ASSY. (M5, M8)															
52	NA		FRONT PLATE (M5, M8)															
53	NA		SERVICE PLATE ASSY. (M5, M8)															
54	7009536		STAY ASSY. (FRONT) (M5, M8)															
55	7009537		STAY (REAR) (M5, M8)															





Ref. Part No:	Part No:	Description:	Ref. Part No:	Part No:	Description:
<b>Image 1:</b>			<b>Image 1:</b>		
1	7009663	SCROLL COMPRESSOR (M5, M8)	46	7500061	COIL/ FOUR WAY VALVE (HP/ LP GAS) (M5, M8)
2	7009598	CRANK CASE HEATER (M5, M8)	47	NA	STOP VALVE ASSY. (GAS) (M5, M8)
3	2441481	TERMINAL COVER (M5, M8)	48	2127879	STOP VALVE ASSY (M5, M8)
4	2311775	COMPRESSOR MOUNTING BOLT ASSY. (M5, M8)	49	2116831	VALVE CAP (M5, M8)
5	NA	GROUNDING TERMINAL (M5, M8)	50	2226992	LOW PRESSURE SENSOR (M5, M8)
6	2279686	COMPRESSOR SOUNDPROOF ASSY. (M5, M8)	51	NA	STOP VALVE ASSY. (GAS) (M5, M8)
7	2286855	RUBBER VIBRATION ISOLATOR (M5, M8)	52	2127918	STOP VALVE ASSY (M5, M8)
8	7500035	STOP VALVE MOUNTING PLATE (M5, M8)	53	2116831	VALVE CAP (M5, M8)
9	7009679	ACCUMULATOR ASSY. (M5, M8)	54	1944437	GAUGE JOINT WITH CHECK VALVE (M5, M8)
10	232005J	REFRIGERANT FILTER (M5, M8)	55	2227003	HIGH PRESSURE SENSOR (M5, M8)
11	2165972	BODY/ SOLENOID VALVE (HOT GAS BYPASS) (M5, M8)	56	2119861	BODY/ FOUR WAY VALVE (HEAT EXC. UPPER) (M5, M8)
12	7009622	COIL/ SOLENOID VALVE (HOT GAS BYPASS) (M5, M8)	57	6019596	BODY/ FOUR WAY VALVE (M5, M8)
13	2279484	WEIGHT (M5, M8)	58	7500059	COIL/ FOUR WAY VALVE (HEAT EXC. UPPER) (M5, M8)
14	7009680	WEIGHT ASSY. (M5, M8)	59	7500060	COIL/ FOUR WAY VALVE (HEAT EXC. LOWER) (M5, M8)
15	7009623	LIQUID RECEIVER ASSY. (M5, M8)	60	NA	SUCTION PIPE ASSY. (M5, M8)
16	7009455	FUSIBLE PLUG ASSY. (M5, M8)	61	2312879	WEIGHT (M5, M8)
17	NA	ELECTRONIC EXP. VALVE ASSY. (1) (M5, M8)	62	NA	DISCHARGE PIPE ASSY. (M5, M8)
18	7009625	PRESSURE CONTROL VALVE (M5, M8)	63	2397368	OIL SEPARATOR ASSY. (M5, M8)
19	147657J	BODY/ SOLENOID VALVE (LIQUID SHUT OFF) (M5, M8)	64	2009065	PLUMMET (M5, M8)
20	NA	ELECTRONIC EXP. VALVE ASSY. (2) (M5, M8)	65	NA	DISCHARGE PIPE ASSY. (1) (M5, M8)
21	2113337	FILTER (FOR REF.) (M5, M8)	66	7009608	HIGH PRESSURE SWITCH (M5, M8)
22	012000J	REFRIGERANT FILTER (M5, M8)	67	2282668	WEIGHT (M5, M8)
23	1086083	CHECK VALVE (M5, M8)	68	2317139	WEIGHT (M5, M8)
24	2233628	BODY/ ELE EXP. VALVE (REFRIGERANT COOLING) (M5, M8)	69	NA	DISCHARGE PIPE ASSY. (2) (M5, M8)
25	2204606	BODY/ ELE EXP. VALVE (SUBCOOL HEAT EXC.) (M5, M8)	70	2311845	CHECK VALVE (M5, M8)
26	NA	ELECTRONIC EXP. VALVE ASSY. (3) (M5, M8)	71	159971J	REFRIGERANT FILTER (M5, M8)
27	7500077	DOUBLE TUBE HEAT EXCH. ASSY. (M5, M8)	72	2279484	WEIGHT (M5, M8)
28	2113344	FILTER (FOR REF.) (M5, M8)	73	NA	DISCHARGE PIPE ASSY. (3) (M5, M8)
29	232005J	REFRIGERANT FILTER (M5, M8)	74	2165965	BODY/ SOLENOID VALVE (OS OIL RETURN 1) (M5, M8)
30	1996469	BODY/ ELE EXP. VALVE (RECEIVER GAS PURGE) (M5, M8)	75	7500071	COIL/ SOLENOID VALVE (OS OIL RETURN 1) (M5, M8)
31	NA	CAPILLARY TUBE (M5, M8)	76	4012537	FILTER (M5, M8)
32	2441506	COIL/ ELE EXP. VALVE (RECEIVER GAS PURGE) (M5, M8)	77	NA	DISCHARGE PIPE ASSY. (HOT GAS) (M5, M8)
33	7500040	COIL/ ELE EXP. VALVE (REFRIGERANT COOLING) (M5, M8)	78	2165972	BODY/ SOLENOID VALVE (HOT GAS BYPASS) (M5, M8)
34	2441513	COIL/ ELE EXP. VALVE (SUBCOOL HEAT EXC.) (M5, M8)	79	7500070	COIL/ SOLENOID VALVE (HOT GAS BYPASS) (M5, M8)
35	7500080	COIL/ SOLENOID VALVE (LIQUID SHUT OFF) (M5, M8)	80	NA	LIQUID PIPE ASSY. (M5, M8)
36	NA	REFRIGERANT PIPE ASSY. (M5, M8)	81	7009675	PLATE HEAT EXCHANGER ASSY. (M5, M8)
37	0650304	WATER PROOF CAP (M5, M8)	82	231501J	REFRIGERANT FILTER (M5, M8)
38	NA	REFRIGERANT PIPE ASSY. (M5, M8)	83	NA	STOP VALVE ASSY. (LIQUID) (M5, M8)
39	7009601	HEAT SINK ASSY. (M5, M8)	84	2103455	STOP VALVE (M5, M8)
40	2279484	WEIGHT (M5, M8)	85	143584J	CAP/ STOP VALVE (M5, M8)
41	7009678	WEIGHT (M5, M8)	86	1505111	PIPE CLAMP PLATE (M5, M8)
42	2103626	WIRE HARNESS (M5, M8)	87	1801415	BODY/ ELECTRONIC EXP. VALVE (INJECTION) (M5, M8)
43	2103633	HEX. BOLT (M5, M8)	88	7500031	COIL/ ELECTRONIC EXP. VALVE (HEAT EXC. UPPER) (M5, M8)
44	NA	REFRIGERANT PIPE ASSY. (M5, M8)	89	7500030	COIL/ ELECTRONIC EXP. VALVE (HEAT EXC. LOWER) (M5, M8)
45	1944437	GAUGE JOINT WITH CHECK VALVE (M5, M8)			

Ref. Part No:	Part No:	Description:	Ref. Part No:	Part No:	Description:
---------------	----------	--------------	---------------	----------	--------------

**Image 1:**

90	2441498	COIL/ ELECTRONIC EXP. VALVE (INJECTION) (M5, M8)
91	7009700	WATER PROOF CAP (M5, M8)
92	NA	LIQUID PIPE ASSY. (M5, M8)
93	1996469	BODY/ ELECTRONIC EXP. VALVE (M5, M8)
94	231501J	REFRIGERANT FILTER (M5, M8)
95	2113344	FILTER (FOR REF.) (M5, M8)
96	NA	REFRIGERANT PIPE ASSY. (M5, M8)
97	7009455	FUSIBLE PLUG ASSY. (M5, M8)
98	2311799	WEIGHT (M5, M8)
99	7009641	WIRE HARNESS ASSY. (M5, M8)
100	7009642	WIRE HARNESS ASSY. (COMP.) (M5, M8)
101	380401J	LOCKING CARD SPACER (M5, M8)
102	4012540	HEX BOLT (M5, M8)
103	128778J	THERMAL INSULATION (M5, M8)
104	7009684	WEIGHT (M5, M8)
105	7009680	WEIGHT ASSY. (M5, M8)
106	7009795	THERMAL INSULATION TUBE (M5, M8)
107	4023075	CAUTION LABEL (ROTATING) (M5, M8)
108	NA	THERMISTOR ASSY. (M5, M8)
109	NA	THERMISTOR ASSY. (M5, M8)
110	7009703	HEAT INSULATION TUBE (M5, M8)
111	144291J	HEAT INSULATION TUBE (M5, M8)
112	NA	THERMISTOR (M5, M8)
113	042408J	INSULATION TUBE/ REF. PIPING (M5, M8)
114	0424055	HEAT INSULATION COVER (M5, M8)
115	NA	THERMAL INSULATION TUBE (M5, M8)
116	7500085	THERMISTOR ASSY. (SUCTION) (M5, M8)
117	144290J	HEAT INSULATION TUBE (M5, M8)
118	165763J	THERMAL INSULATION TUBE (M5, M8)
119	144291J	HEAT INSULATION TUBE (M5, M8)

**Expanded Model Nomenclature**

- |                   |
|-------------------|
| M1 - REYQ120XATJU |
| M2 - REYQ120XAYCU |
| M3 - REYQ120XAYDU |
| M4 - REYQ144XATJU |
| M5 - REYQ144XAYCU |
| M6 - REYQ144XAYDU |
| M7 - REYQ168XATJU |
| M8 - REYQ168XAYCU |
| M9 - REYQ168XAYDU |
| M10 - REYQ72XATJU |
| M11 - REYQ72XAYCU |
| M12 - REYQ72XAYDU |
| M13 - REYQ96XATJU |
| M14 - REYQ96XAYCU |
| M15 - REYQ96XAYDU |

REYQ144XAYCU / REYQ168XAYCU

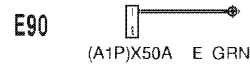
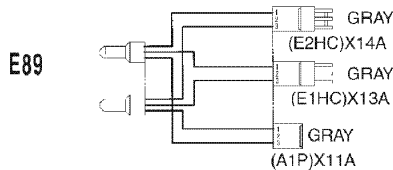
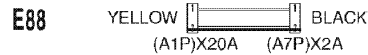
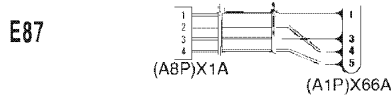
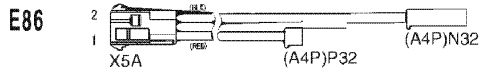
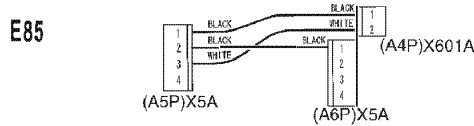
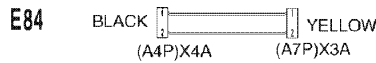
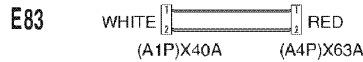
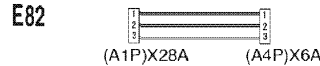
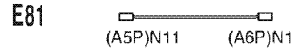
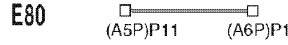
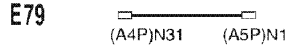
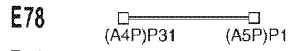
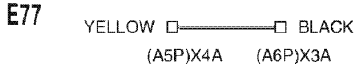
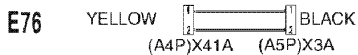
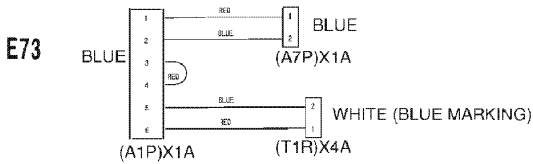
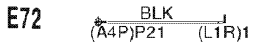
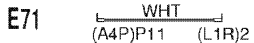
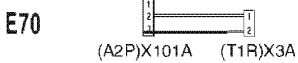
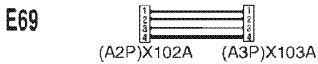
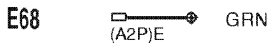
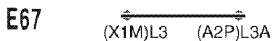
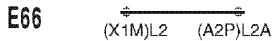
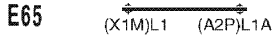
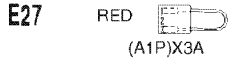
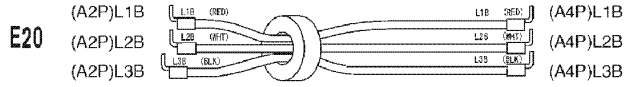

Picture Key

Ref #	Picture #
1	E20
2	E25
3	E27
4	E28
5	E65
6	E66
7	E67
8	E68
9	E69
10	E70
11	E71
12	E72
13	E73
14	E74
15	E75
16	E76
17	E77
18	E78
19	E79
20	E80
21	E81
22	E82
23	E83
24	E84
25	E85
26	E86
27	E87
28	E88
29	E89
30	E90

Ref. Part No:	Part No:	Description:	Ref. Part No:	Part No:	Description:
---------------	----------	--------------	---------------	----------	--------------

**Image 1:**

1	7009641	WIRE HARNESS ASSY. (M5, M8)
2	1933413	CONNECTOR/ SHORT CIRCUIT (M5, M8)
3	135234J	CONNECTOR/ SHORT CIRCUIT (M5, M8)
4	2233712	CONNECTOR (M5, M8)
5	7009737	WIRE HARNESS (M5, M8)
6	7009738	WIRE HARNESS (M5, M8)
7	7009739	WIRE HARNESS (M5, M8)
8	7009740	WIRE HARNESS (M5, M8)
9	7009741	WIRE HARNESS (M5, M8)
10	7009742	WIRE HARNESS (M5, M8)
11	7009743	WIRE HARNESS (M5, M8)
12	7009744	WIRE HARNESS (M5, M8)
13	7009745	WIRE HARNESS ASSY. (M5, M8)
14	7009746	WIRE HARNESS ASSY. (M5, M8)
15	7009747	WIRE HARNESS ASSY. (M5, M8)
16	4014821	WIRE HARNESS (M5, M8)
17	6019724	WIRE HARNESS (M5, M8)
18	7009748	WIRE HARNESS (M5, M8)
19	7009749	WIRE HARNESS (M5, M8)
20	6019712	WIRE HARNESS (M5, M8)
21	7009750	WIRE HARNESS (M5, M8)
22	7009751	WIRE HARNESS (M5, M8)
23	7009752	WIRE HARNESS (M5, M8)
24	6019716	WIRE HARNESS (M5, M8)
25	7009753	WIRE HARNESS ASSY. (M5, M8)
26	7009754	WIRE HARNESS ASSY. (M5, M8)
27	7009735	WIRE HARNESS ASSY. (M5, M8)
28	7009734	WIRE HARNESS (M5, M8)
29	7009732	WIRE HARNESS ASSY. (M5, M8)
30	7009729	WIRE HARNESS (M5, M8)

**Expanded Model Nomenclature**

- M1 - REYQ120XATJU
- M2 - REYQ120XAYCU
- M3 - REYQ120XAYDU
- M4 - REYQ144XATJU
- M5 - REYQ144XAYCU
- M6 - REYQ144XAYDU
- M7 - REYQ168XATJU
- M8 - REYQ168XAYCU
- M9 - REYQ168XAYDU
- M10 - REYQ72XATJU
- M11 - REYQ72XAYCU
- M12 - REYQ72XAYDU
- M13 - REYQ96XATJU
- M14 - REYQ96XAYCU
- M15 - REYQ96XAYDU

# REYQ144XAYCU / REYQ168XAYCU

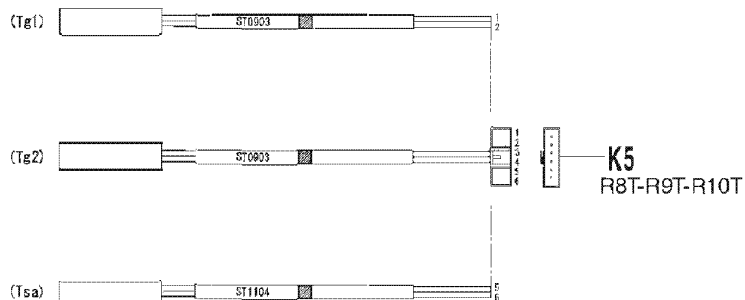

Picture Key	
Ref #	Picture #
1	K11
2	K12
3	K18
4	K5

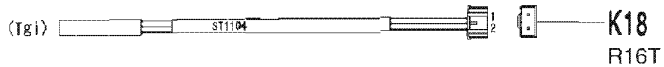
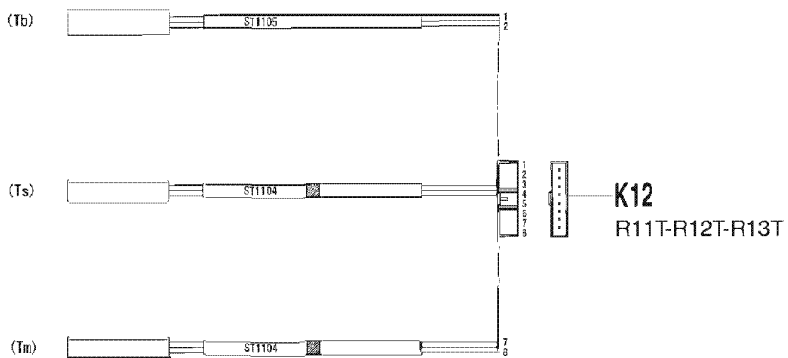
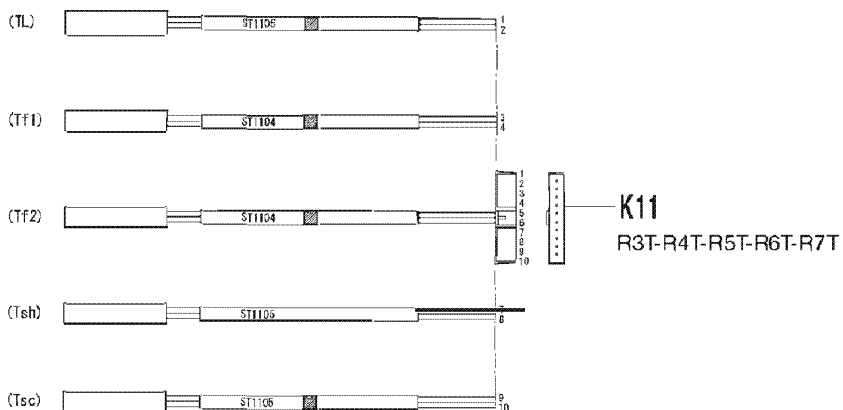

**Ref. Part  
No: No:**

**Description:**

**Ref. Part  
No: No:**

**Description:**

---

**Image 1:**

1	NA	THERMISTOR ASSY. (M5, M8)
2	NA	THERMISTOR ASSY. (M5, M8)
3	NA	THERMISTOR (M5, M8)
4	7500085	THERMISTOR ASSY. (SUCTION) (M5, M8)

**Expanded Model Nomenclature**

M1 - REYQ120XATJU
M2 - REYQ120XAYCU
M3 - REYQ120XAYDU
M4 - REYQ144XATJU
M5 - REYQ144XAYCU
M6 - REYQ144XAYDU
M7 - REYQ168XATJU
M8 - REYQ168XAYCU
M9 - REYQ168XAYDU
M10 - REYQ72XATJU
M11 - REYQ72XAYCU
M12 - REYQ72XAYDU
M13 - REYQ96XATJU
M14 - REYQ96XAYCU
M15 - REYQ96XAYDU

# REYQ72XAYDU / REYQ96XAYDU / REYQ120XAYDU

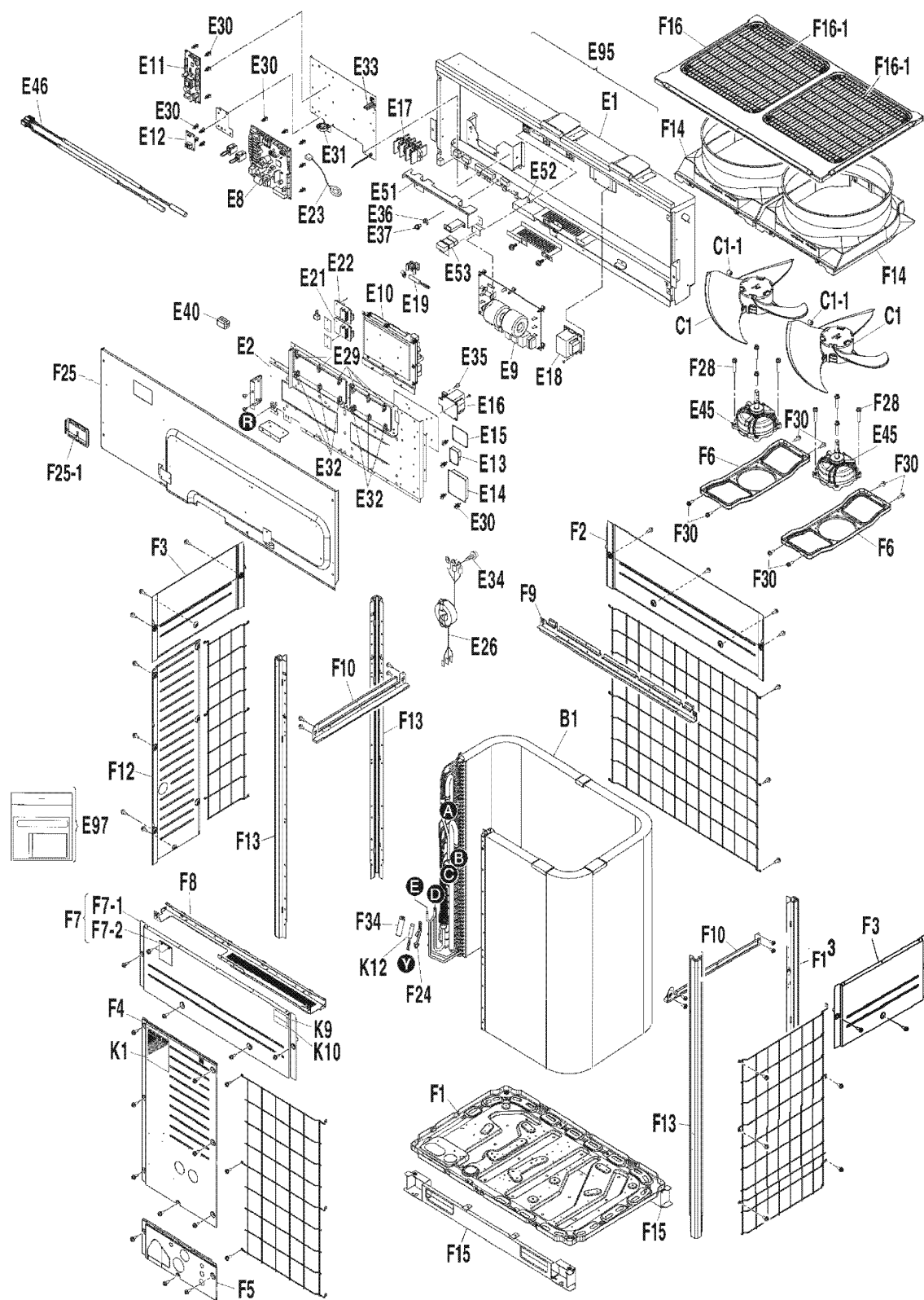

Picture Key	
Ref #	Picture #
1	B1
2	C1
3	C1-1
4	E1
5	E10
6	E11
7	E12
8	E13
9	E14
10	E15
11	E16
12	E17
13	E18
14	E19
15	E2
16	E21
17	E22
18	E23
19	E26
20	E29
21	E30
22	E31
23	E32
24	E33
25	E34
26	E35
27	E36
28	E37
29	E40
30	E45
31	E46
32	E51
33	E52
34	E53
35	E8
36	E9
37	E95
38	E97
39	F1
40	F10
41	F12
42	F13
43	F14
44	F15
45	F16
46	F16-1
47	F2
48	F24
49	F25
50	F25-1
51	F28
52	F3
53	F30
54	F33
55	F4
56	F5
57	F6
58	F7
59	F7-1
60	F7-2
61	F8
62	F9
63	K1
64	K10
65	K9



Ref. Part No:	Part No:	Description:	Ref. Part No:	Part No:	Description:
<b>Image 1:</b>			<b>Image 1:</b>		
1	7009599	PLATE FINNED COIL HEAT EXCH. ASSY. (M3, M12, M15)	52	7009471	SIDE PLATE (UPPER) (M3, M12, M15)
2	7009517	PROPELLER FAN ASSY. (M3, M12, M15)	53	0493462	TAPPING SCREW (M3, M12, M15)
3	057178J	HEX SOCKET SCREW (M3, M12, M15)	54	128153J	THERMAL INSULATION (M3, M12, M15)
4	NA	SWITCH BOX ASSY. (M3, M12, M15)	55	7009532	FRONT PLATE (M3, M12, M15)
5	2387260	PCB (INVERTER) (M3, M12, M15)	56	7009533	FRONT PLATE (BOTTOM) (M3, M12, M15)
6	7500014	PCB (SUB) (M3, M12, M15)	57	7009534	MOTOR MOUNTING PLATE (M3, M12, M15)
7	1716788	PCB (ABC I/P) (M3, M12, M15)	58	2441537	FRONT PLATE ASSY. (M3, M12, M15)
8	7009554	PCB (CURRENT LIMITING) (M3, M12, M15)	59	NA	FRONT PLATE (M3, M12, M15)
9	7500016	PCB (NOISE FILTER) (M3, M12, M15)	60	NA	SERVICE PLATE ASSY. (M3, M12, M15)
10	7009556	PCB (REVERSE PHASE PROTECTION) (M3, M12, M15)	61	7009536	STAY ASSY. (FRONT) (M3, M12, M15)
11	6025223	REACTOR (M3, M12, M15)	62	7009537	STAY (REAR) (M3, M12, M15)
12	7009522	TERMINAL BLOCK (M3, M12, M15)	63	7009692	BRAND NAME LABEL (M3, M12, M15)
13	7009503	LOW FREQUENCY TRANSFORMER (M3, M12, M15)	64	4023075	CAUTION LABEL (ROTATING) (M3, M12, M15)
14	1782095	THERMISTOR (AIR) (M3, M12, M15)	65	4010207	LABEL (WARNING) (M3, M12, M15)
15	7009524	EL. COMPO. MOUNTING PLATE (INVERTER) (M3, M12, M15)	<b>Expanded Model Nomenclature</b>		
16	7500013	PCB (FAN) (M3, M12, M15)	M1 - REYQ120XATJU		
17	7500012	PCB (FAN) (M3, M12, M15)	M2 - REYQ120XAYCU		
18	2117168	CURRENT TRANSFORMER (M3, M12, M15)	M3 - REYQ120XAYDU		
19	2387277	WIRE HARNESS ASSY. (COMP.) (M3, M12, M15)	M4 - REYQ144XATJU		
20	352004	WIRE CLIP (M3, M12, M15)	M5 - REYQ144XAYCU		
21	380401J	LOCKING CARD SPACER (M3, M12, M15)	M6 - REYQ144XAYDU		
22	2010250	WIRE CLIP (M3, M12, M15)	M7 - REYQ168XATJU		
23	027843J	WIRE CLIP (M3, M12, M15)	M8 - REYQ168XAYCU		
24	0207661	LOCKING WIRE SADDLE (M3, M12, M15)	M9 - REYQ168XAYDU		
25	NA	GROUNDING TERMINAL (M3, M12, M15)	M10 - REYQ72XATJU		
26	NA	PAN HEAD MACHINE SCREW (M3, M12, M15)	M11 - REYQ72XAYCU		
27	066578J	CUP WASHER (M3, M12, M15)	M12 - REYQ72XAYDU		
28	NA	EARTH TERMINAL SCREW (M3, M12, M15)	M13 - REYQ96XATJU		
29	4012628	FERRITE CORE (M3, M12, M15)	M14 - REYQ96XAYCU		
30	4012442	FAN MOTOR (M3, M12, M15)	M15 - REYQ96XAYDU		
31	7009644	THERMISTOR ASSY. (M3, M12, M15)			
32	NA	EL. COMPO. MOUNTING PLATE ASSY. (M3, M12, M15)			
33	NA	SEALING MATERIAL (SWITCH BOX) (M3, M12, M15)			
34	NA	SEALING MATERIAL ASSY. (M3, M12, M15)			
35	2441568	PCB (M3, M12, M15)			
36	7009551	PCB (NOISE FILTER) (M3, M12, M15)			
37	NA	ELECTRIC COMPONENT ASSY. (M3, M12, M15)			
38	NA	GREASE ASSY. (M3, M12, M15)			
39	7009530	BOTTOM FRAME (M3, M12, M15)			
40	7009478	STAY (RIGHT/ LEFT) (M3, M12, M15)			
41	7009480	SIDE PLATE (M3, M12, M15)			
42	7009481	SUPPORT (M3, M12, M15)			
43	7009588	BELL MOUTH (M3, M12, M15)			
44	7009538	BRACKET (M3, M12, M15)			
45	7009539	TOP PLATE ASSY. (M3, M12, M15)			
46	7500121	DISCHARGE GRILLE (M3, M12, M15)			
47	7009531	FRONT PLATE (UPPER) (M3, M12, M15)			
48	042396J	FITTING SPRING/ THERMISTOR (M3, M12, M15)			
49	NA	COVER/ SWITCH BOX ASSY. (M3, M12, M15)			
50	128777J	INSPECTION HOLE (M3, M12, M15)			
51	7009486	HEX HEAD TAPPING SCREW (M3, M12, M15)			

# REYQ72XAYDU / REYQ96XAYDU / REYQ120XAYDU

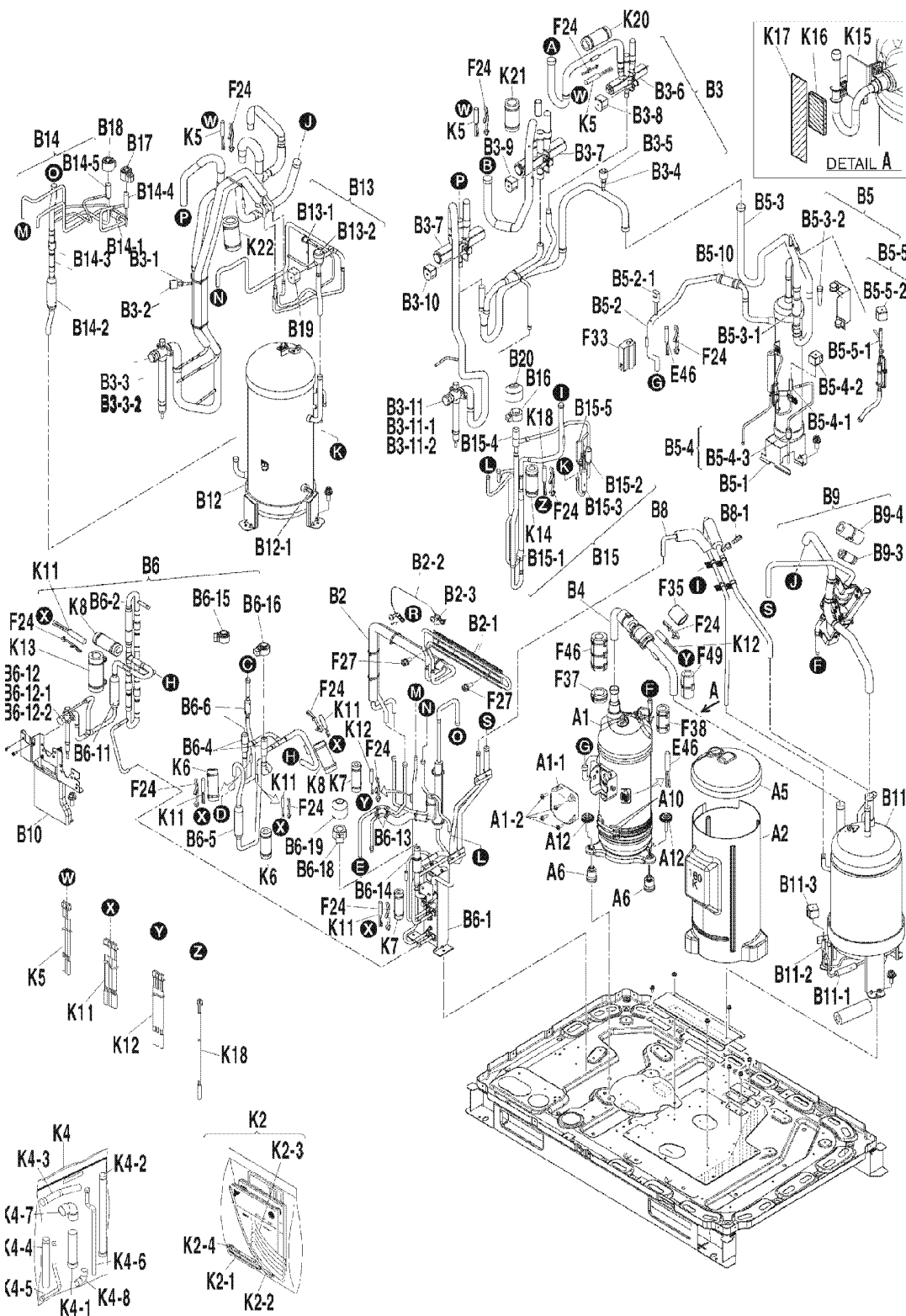

Picture Key

Ref #	Picture #	Ref #	Picture #
1	A1	64	B5-3-2
2	A10	65	B5-4
3	A1-1	66	B5-4-1
4	A12	67	B5-4-2
5	A1-2	68	B5-4-3
6	A2	69	B5-5
7	A5	70	B5-5-1
8	A6	71	B5-5-2
9	B10	72	B6
10	B11	73	B6-1
11	B11-1	74	B6-11
12	B11-2	75	B6-12
13	B11-3	76	B6-12-1
14	B12	77	B6-12-2
15	B12-1	78	B6-13
16	B13	79	B6-14
17	B13-1	80	B6-15
18	B13-2	81	B6-16
19	B14	82	B6-18
20	B14-1	83	B6-19
21	B14-2	84	B6-2
22	B14-3	85	B6-4
23	B14-4	86	B6-5
24	B14-5	87	B6-6
25	B15	88	B6-8
26	B15-1	89	B8-1
27	B15-2	90	B9
28	B15-3	91	B9-3
29	B15-4	92	B9-4
30	B15-5	93	F27
31	B16	94	F34
32	B17	95	F35
33	B18	96	F37
34	B19	97	F38
35	B2	98	F46
36	B20	99	F49
37	B2-1	100	K11
38	B2-2	101	K12
39	B2-3	102	K13
40	B3	103	K14
41	B3-1	104	K15
42	B3-10	105	K16
43	B3-11	106	K17
44	B3-11-1	107	K18
45	B3-11-2	108	K2
46	B3-2	109	K20
47	B3-3	110	K21
48	B3-3-1	111	K2-1
49	B3-3-2	112	K2-2
50	B3-4	113	K2-3
51	B3-5	114	K2-4
52	B3-6	115	K4
53	B3-7	116	K4-1
54	B3-8	117	K4-2
55	B3-9	118	K4-3
56	B4	119	K4-4
57	B5	120	K4-5
58	B5-1	121	K4-6
59	B5-10	122	K4-7
60	B5-2	123	K4-8
61	B5-2-1	124	K6
62	B5-3	125	K7
63	B5-3-1	126	K8

Ref. Part No: No:	Description:	Ref. Part No: No:	Description:
<b>Image 1:</b>		<b>Image 1:</b>	
1	2441551	38	2103626
2	7009598	39	2103633
3	2441481	40	NA
4	2311775	41	1944437
5	NA	42	7500061
6	2278885	43	NA
7	2278892	44	2127879
8	2286848	45	2116831
9	7500035	46	2226992
10	7009621	47	NA
11	232005J	48	2127901
12	2165972	49	2116831
13	7009622	50	1944437
14	7009623	51	2227003
15	7009455	52	2119861
16	NA	53	6019596
17	7009625	54	7500059
18	147657J	55	7500060
19	NA	56	NA
20	2113337	57	NA
21	012000J	58	7009607
22	1086083	59	2311799
23	2233628	60	NA
24	2204606	61	7009608
25	NA	62	NA
26	7500077	63	2103479
27	2113344	64	2096331
28	232005J	65	NA
29	1996469	66	2165965
30	NA	67	7500071
31	2441506	68	4012537
32	7500040	69	NA
33	2441513	70	2165972
34	7500080	71	7500070
35	NA	72	NA
36	0650304	73	7009610
37	7009508	74	231501J
		75	NA
		76	2103455
		77	143584J
		78	1505111
		79	1801415

Ref. Part No:	Part No:	Description:	Ref. Part No:	Part No:	Description:															
<b>Image 1:</b>			<b>Image 1:</b>																	
80	7500031	COIL/ ELE EXP. VALVE (HEAT EXC. UPPER) (M3, M12, M15)	122	7009578	AUXILIARY PIPE (LIQUID SIDE BOTTOM) (M3)															
81	7500030	COIL/ ELE EXP. VALVE (HEAT EXC. LOWER) (M3, M12, M15)	122	7500097	AUXILIARY PIPE (LIQUID SIDE BOTTOM) (M12, M15)															
82	2441498	COIL/ ELE EXP. VALVE (INJECTION) (M3, M12, M15)	123	1799257	L-TYPE JOINT (M3, M12, M15)															
83	7009700	WATER PROOF CAP (M3, M12, M15)	124	254105J	ELBOW JOINT (M3, M12, M15)															
84	NA	LIQUID PIPE ASSY. (M3, M12, M15)	125	7500085	THERMISTOR ASSY. (SUCTION) (M3, M12, M15)															
85	1996469	BODY/ ELECTRONIC EXP. VALVE (M3, M12, M15)	126	144290J	HEAT INSULATION TUBE (M3, M12, M15)															
86	231501J	REFRIGERANT FILTER (M3, M12, M15)	127	165763J	THERMAL INSULATION TUBE (M3, M12, M15)															
87	2113344	FILTER (FOR REF.) (M3, M12, M15)	128	144291J	HEAT INSULATION TUBE (M3, M12, M15)															
88	NA	REFRIGERANT PIPE ASSY. (M3, M12, M15)	<b>Expanded Model Nomenclature</b>																	
89	7009455	FUSIBLE PLUG ASSY. (M3, M12, M15)	<table border="1"> <tr><td>M1 - REYQ120XATJU</td></tr> <tr><td>M2 - REYQ120XAYCU</td></tr> <tr><td>M3 - REYQ120XAYDU</td></tr> <tr><td>M4 - REYQ144XATJU</td></tr> <tr><td>M5 - REYQ144XAYCU</td></tr> <tr><td>M6 - REYQ144XAYDU</td></tr> <tr><td>M7 - REYQ168XATJU</td></tr> <tr><td>M8 - REYQ168XAYCU</td></tr> <tr><td>M9 - REYQ168XAYDU</td></tr> <tr><td>M10 - REYQ72XATJU</td></tr> <tr><td>M11 - REYQ72XAYCU</td></tr> <tr><td>M12 - REYQ72XAYDU</td></tr> <tr><td>M13 - REYQ96XATJU</td></tr> <tr><td>M14 - REYQ96XAYCU</td></tr> <tr><td>M15 - REYQ96XAYDU</td></tr> </table>			M1 - REYQ120XATJU	M2 - REYQ120XAYCU	M3 - REYQ120XAYDU	M4 - REYQ144XATJU	M5 - REYQ144XAYCU	M6 - REYQ144XAYDU	M7 - REYQ168XATJU	M8 - REYQ168XAYCU	M9 - REYQ168XAYDU	M10 - REYQ72XATJU	M11 - REYQ72XAYCU	M12 - REYQ72XAYDU	M13 - REYQ96XATJU	M14 - REYQ96XAYCU	M15 - REYQ96XAYDU
M1 - REYQ120XATJU																				
M2 - REYQ120XAYCU																				
M3 - REYQ120XAYDU																				
M4 - REYQ144XATJU																				
M5 - REYQ144XAYCU																				
M6 - REYQ144XAYDU																				
M7 - REYQ168XATJU																				
M8 - REYQ168XAYCU																				
M9 - REYQ168XAYDU																				
M10 - REYQ72XATJU																				
M11 - REYQ72XAYCU																				
M12 - REYQ72XAYDU																				
M13 - REYQ96XATJU																				
M14 - REYQ96XAYCU																				
M15 - REYQ96XAYDU																				
90	7009618	SUCTION PIPE ASSY. (1) (M3, M12, M15)																		
91	7009620	WEIGHT (M3, M12, M15)																		
92	2317139	WEIGHT (M3, M12, M15)																		
93	4012540	HEX BOLT (M3, M12, M15)																		
94	144290J	HEAT INSULATION TUBE (M3, M12, M15)																		
95	NA	THERMAL INSULATION TUBE (M3, M12, M15)																		
96	6026549	WEIGHT (M3, M12, M15)																		
97	7009680	WEIGHT ASSY. (M3, M12, M15)																		
98	7009678	WEIGHT (M3, M12, M15)																		
99	2317139	WEIGHT (M3, M12, M15)																		
100	NA	THERMISTOR ASSY. (M3, M12, M15)																		
101	NA	THERMISTOR ASSY. (M3, M12, M15)																		
102	7009703	HEAT INSULATION TUBE (M3, M12, M15)																		
103	144291J	HEAT INSULATION TUBE (M3, M12, M15)																		
104	NA	MOUNTING PLATE ASSY. (M3, M12, M15)																		
105	NA	THERMAL INSULATION TAPE (M3, M12, M15)																		
106	NA	TAPE (ALMINIUM) (M3, M12, M15)																		
107	NA	THERMISTOR (M3, M12, M15)																		
108	NA	ACCESSORIES ASSY. (M3, M12, M15)																		
109	042408J	INSULATION TUBE/ REF. PIPING (M3, M12, M15)																		
110	0424055	HEAT INSULATION COVER (M3, M12, M15)																		
111	NA	TIE WRAP (M3, M12, M15)																		
112	NA	THERMAL INSULATION TUBE (M3, M12, M15)																		
113	NA	CLAMP/ LEAD WIRE (M3, M12, M15)																		
114	1997424	ELECTRIC INSULATION (M3, M12, M15)																		
115	056827J	TIE WRAP (M3, M12, M15)																		
116	NA	ACCESSORIES ASSY. (M3, M12, M15)																		
117	7009542	AUXILIARY PIPE (GAS SIDE FRONT) (M3)																		
117	7500052	AUXILIARY PIPE (GAS SIDE FRONT) (M12)																		
117	7500090	AUXILIARY PIPE (GAS SIDE FRONT) (M15)																		
118	7009544	AUXILIARY PIPE (GAS SIDE BOTTOM) (M3)																		
118	7500053	AUXILIARY PIPE (GAS SIDE BOTTOM) (M12)																		
118	7500091	AUXILIARY PIPE (GAS SIDE BOTTOM) (M15)																		
119	7500054	AUXILIARY PIPE (H AND L PRESSURE) (M12)																		
119	7500093	AUXILIARY PIPE DISCHARGE (GAS SIDE F) (M3, M15)																		
120	7500055	AUXILIARY PIPE (H AND L PRESSURE) (M12)																		
120	7500095	AUXILIARY PIPE DISCHARGE (GAS SIDE LOWER) (M3, M15)																		
121	7009576	AUXILIARY PIPE (LIQUID SIDE FRONT) (M3)																		
121	7500096	AUXILIARY PIPE (LIQUID SIDE FRONT) (M12, M15)																		

**REYQ72XAYDU / REYQ96XAYDU / REYQ120XAYDU**

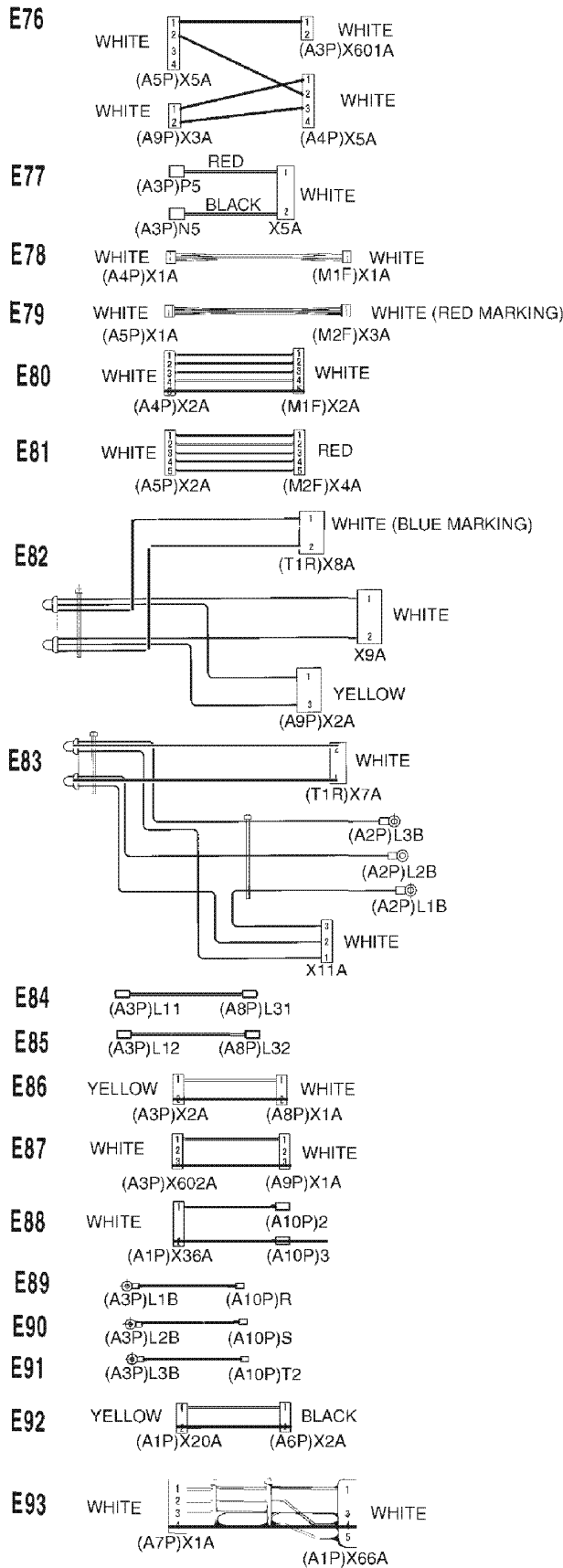
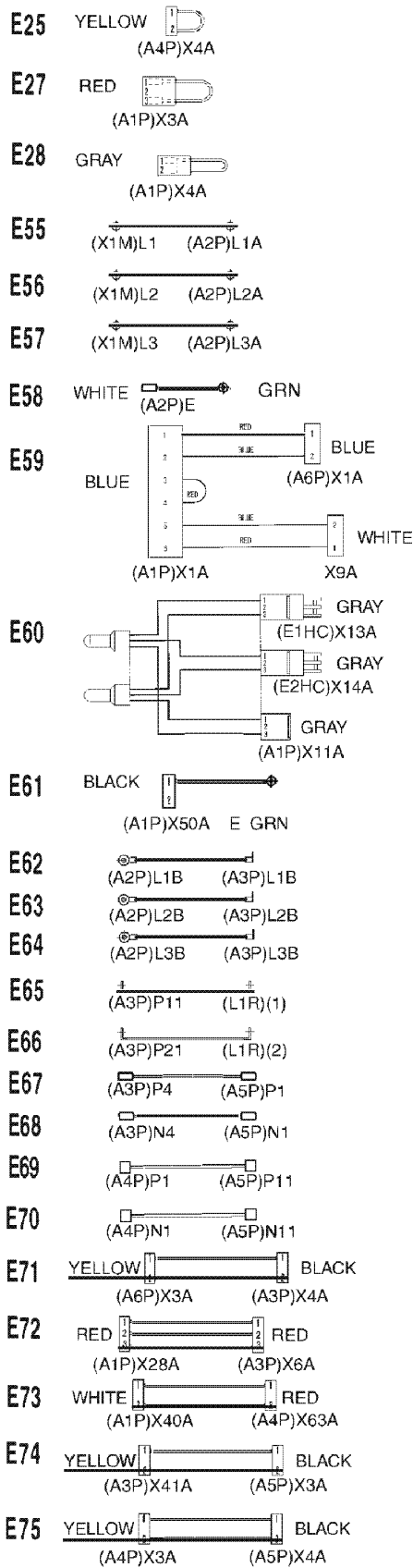

Picture Key	
Ref #	Picture #
1	E25
2	E27
3	E28
4	E55
5	E56
6	E57
7	E58
8	E59
9	E60
10	E61
11	E62
12	E63
13	E64
14	E65
15	E66
16	E67
17	E68
18	E69
19	E70
20	E71
21	E72
22	E73
23	E74
24	E75
25	E76
26	E77
27	E78
28	E79
29	E80
30	E81
31	E82
32	E83
33	E84
34	E85
35	E86
36	E87
37	E88
38	E89
39	E90
40	E91
41	E92
42	E93

**Ref. Part  
No: No:**

**Description:**

**Ref. Part  
No: No:**

**Description:**

**Image 1:**

1	1933413	CONNECTOR/ SHORT CIRCUIT (M3, M12, M15)
2	135234J	CONNECTOR/ SHORT CIRCUIT (M3, M12, M15)
3	2233712	CONNECTOR (M3, M12, M15)
4	7009737	WIRE HARNESS (M3, M12, M15)
5	7009738	WIRE HARNESS (M3, M12, M15)
6	7009739	WIRE HARNESS (M3, M12, M15)
7	4022373	WIRE HARNESS (M3, M12, M15)
8	7009755	WIRE HARNESS ASSY. (M3, M12, M15)
9	7009732	WIRE HARNESS ASSY. (M3, M12, M15)
10	7009729	WIRE HARNESS (M3, M12, M15)
11	7009756	WIRE HARNESS (M3, M12, M15)
12	7009757	WIRE HARNESS (M3, M12, M15)
13	7009758	WIRE HARNESS (M3, M12, M15)
14	7009759	WIRE HARNESS (M3, M12, M15)
15	7009760	WIRE HARNESS (M3, M12, M15)
16	7009761	WIRE HARNESS (M3, M12, M15)
17	7009762	WIRE HARNESS (M3, M12, M15)
18	6019712	WIRE HARNESS (M3, M12, M15)
19	4014825	WIRE HARNESS (M3, M12, M15)
20	6019716	WIRE HARNESS (M3, M12, M15)
21	7009763	WIRE HARNESS (M3, M12, M15)
22	4014816	WIRE HARNESS (M3, M12, M15)
23	4014821	WIRE HARNESS (M3, M12, M15)
24	6019724	WIRE HARNESS (M3, M12, M15)
25	7009764	WIRE HARNESS (M3, M12, M15)
26	7009765	WIRE HARNESS (M3, M12, M15)
27	2299091	WIRE HARNESS ASSY. (M3, M12, M15)
28	2299109	WIRE HARNESS ASSY. (M3, M12, M15)
29	7009730	WIRE HARNESS (M3, M12, M15)
30	7009731	WIRE HARNESS (M3, M12, M15)
31	7009766	WIRE HARNESS ASSY. (M3, M12, M15)
32	7009767	WIRE HARNESS ASSY. (M3, M12, M15)
33	7009768	WIRE HARNESS (M3, M12, M15)
34	7009769	WIRE HARNESS (M3, M12, M15)
35	7009770	WIRE HARNESS (M3, M12, M15)
36	7009771	WIRE HARNESS (M3, M12, M15)
37	7009772	WIRE HARNESS (M3, M12, M15)
38	7009773	WIRE HARNESS (M3, M12, M15)
39	7009774	WIRE HARNESS (M3, M12, M15)
40	7009775	WIRE HARNESS (M3, M12, M15)
41	7009734	WIRE HARNESS (M3, M12, M15)
42	7009735	WIRE HARNESS ASSY. (M3, M12, M15)

**Expanded Model Nomenclature**

M1 - REYQ120XATJU
M2 - REYQ120XAYCU
M3 - REYQ120XAYDU
M4 - REYQ144XATJU
M5 - REYQ144XAYCU
M6 - REYQ144XAYDU
M7 - REYQ168XATJU
M8 - REYQ168XAYCU
M9 - REYQ168XAYDU
M10 - REYQ72XATJU
M11 - REYQ72XAYCU
M12 - REYQ72XAYDU
M13 - REYQ96XATJU
M14 - REYQ96XAYCU
M15 - REYQ96XAYDU

# REYQ72XAYDU / REYQ96XAYDU / REYQ120XAYDU

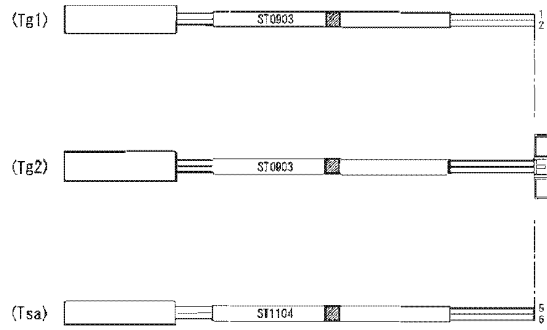

Picture Key

Ref #	Picture #
1	K11
2	K12
3	K18
4	K5

**K5**  
R8T-R9T-R10T

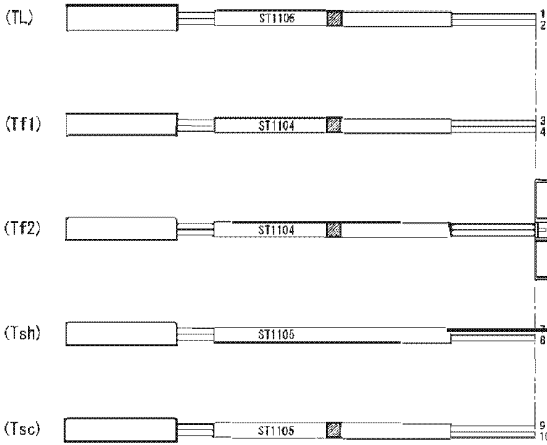

**K11**  
R3T-R4T-R5T-R6T-R7T

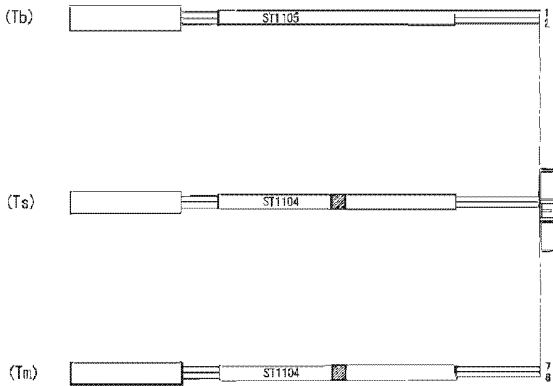

**K12**  
R11T-R12T-R13T

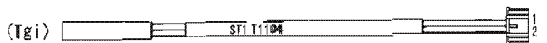

**K18**  
R16T

**Ref. Part  
No: No:**

**Description:**

**Ref. Part  
No: No:**

**Description:**

---

**Image 1:**

1	NA	THERMISTOR ASSY. (M3, M12, M15)
2	NA	THERMISTOR ASSY. (M3, M12, M15)
3	NA	THERMISTOR (M3, M12, M15)
4	7500085	THERMISTOR ASSY. (SUCTION) (M3, M12, M15)

**Expanded Model Nomenclature**

M1 - REYQ120XATJU
M2 - REYQ120XAYCU
M3 - REYQ120XAYDU
M4 - REYQ144XATJU
M5 - REYQ144XAYCU
M6 - REYQ144XAYDU
M7 - REYQ168XATJU
M8 - REYQ168XAYCU
M9 - REYQ168XAYDU
M10 - REYQ72XATJU
M11 - REYQ72XAYCU
M12 - REYQ72XAYDU
M13 - REYQ96XATJU
M14 - REYQ96XAYCU
M15 - REYQ96XAYDU





Ref. Part No:	Part No:	Description:	Ref. Part No:	Part No:	Description:															
<b>Image 1:</b>			<b>Image 1:</b>																	
1	7009599	PLATE FINNED COIL HEAT EXCH. ASSY. (M6, M9)	56	7009536	STAY ASSY. (FRONT) (M6, M9)															
2	7009517	PROPELLER FAN ASSY. (M6, M9)	57	7009537	STAY (REAR) (M6, M9)															
3	057178J	HEX SOCKET SCREW (M6, M9)	58	7009692	BRAND NAME LABEL (M6, M9)															
4	NA	SWITCH BOX ASSY. (M6, M9)	59	4023075	CAUTION LABEL (ROTATING) (M6, M9)															
5	2387417	PCB. (INVERTER) (M6, M9)	<b>Expanded Model Nomenclature</b>																	
6	7500013	PCB. (FAN) (M6, M9)	<table border="1"> <tr><td>M1 - REYQ120XATJU</td></tr> <tr><td>M2 - REYQ120XAYCU</td></tr> <tr><td>M3 - REYQ120XAYDU</td></tr> <tr><td>M4 - REYQ144XATJU</td></tr> <tr><td>M5 - REYQ144XAYCU</td></tr> <tr><td>M6 - REYQ144XAYDU</td></tr> <tr><td>M7 - REYQ168XATJU</td></tr> <tr><td>M8 - REYQ168XAYCU</td></tr> <tr><td>M9 - REYQ168XAYDU</td></tr> <tr><td>M10 - REYQ72XATJU</td></tr> <tr><td>M11 - REYQ72XAYCU</td></tr> <tr><td>M12 - REYQ72XAYDU</td></tr> <tr><td>M13 - REYQ96XATJU</td></tr> <tr><td>M14 - REYQ96XAYCU</td></tr> <tr><td>M15 - REYQ96XAYDU</td></tr> </table>			M1 - REYQ120XATJU	M2 - REYQ120XAYCU	M3 - REYQ120XAYDU	M4 - REYQ144XATJU	M5 - REYQ144XAYCU	M6 - REYQ144XAYDU	M7 - REYQ168XATJU	M8 - REYQ168XAYCU	M9 - REYQ168XAYDU	M10 - REYQ72XATJU	M11 - REYQ72XAYCU	M12 - REYQ72XAYDU	M13 - REYQ96XATJU	M14 - REYQ96XAYCU	M15 - REYQ96XAYDU
M1 - REYQ120XATJU																				
M2 - REYQ120XAYCU																				
M3 - REYQ120XAYDU																				
M4 - REYQ144XATJU																				
M5 - REYQ144XAYCU																				
M6 - REYQ144XAYDU																				
M7 - REYQ168XATJU																				
M8 - REYQ168XAYCU																				
M9 - REYQ168XAYDU																				
M10 - REYQ72XATJU																				
M11 - REYQ72XAYCU																				
M12 - REYQ72XAYDU																				
M13 - REYQ96XATJU																				
M14 - REYQ96XAYCU																				
M15 - REYQ96XAYDU																				
7	7500012	PCB. (FAN) (M6, M9)																		
8	7500014	PCB. (SUB) (M6, M9)																		
9	1716788	PCB. (ABC I/P) (M6, M9)																		
10	2353584	REACTOR ASSY. (M6, M9)																		
11	7009503	LOW FREQUENCY TRANSFORMER (M6, M9)																		
12	7009522	TERMINAL BLOCK (M6, M9)																		
13	2117168	CURRENT TRANSFORMER (M6, M9)																		
14	1782095	THERMISTOR (AIR) (M6, M9)																		
15	2279491	EL. COMPO. MOUNTING PLATE (INVERTER) (M6, M9)																		
16	2387448	WIRE HARNESS (COMP.) (M6, M9)																		
17	380401J	LOCKING CARD SPACER (M6, M9)																		
18	2010250	WIRE CLIP (M6, M9)																		
19	027843J	WIRE CLIP (M6, M9)																		
20	0207661	LOCKING WIRE SADDLE (M6, M9)																		
21	NA	PAN HEAD MACHINE SCREW (M6, M9)																		
22	066578J	CUP WASHER (M6, M9)																		
23	NA	EARTH TERMINAL SCREW (M6, M9)																		
24	4012442	FAN MOTOR (M6, M9)																		
25	7009683	THERMISTOR ASSY. (M6, M9)																		
26	1899948	FIN THERMISTOR (M6, M9)																		
27	NA	EL. COMPO. MOUNTING PLATE ASSY. (M6, M9)																		
28	NA	SEALING MATERIAL (SWITCH BOX) (M6, M9)																		
29	NA	SEALING MATERIAL ASSY. (M6, M9)																		
30	2441568	PCB (M6, M9)																		
31	6026439	PCB(NOISE FILTER) (M6, M9)																		
32	NA	ELECTRIC COMPONENT ASSY. (M6, M9)																		
33	NA	GREASE ASSY. (M6, M9)																		
34	7009530	BOTTOM FRAME (M6, M9)																		
35	7009478	STAY (RIGHT/ LEFT) (M6, M9)																		
36	7009480	SIDE PLATE (M6, M9)																		
37	7009481	SUPPORT (M6, M9)																		
38	7009588	BELL MOUTH (M6, M9)																		
39	7009538	BRACKET (M6, M9)																		
40	7009539	TOP PLATE ASSY. (M6, M9)																		
41	7500121	DISCHARGE GRILLE (M6, M9)																		
42	7009531	FRONT PLATE (UPPER) (M6, M9)																		
43	042396J	FITTING SPRING/ THERMISTOR (M6, M9)																		
44	NA	COVER/ SWITCH BOX ASSY. (M6, M9)																		
45	128777J	INSPECTION HOLE (M6, M9)																		
46	7009486	HEX HEAD TAPPING SCREW (M6, M9)																		
47	7009471	SIDE PLATE (UPPER) (M6, M9)																		
48	0493462	TAPPING SCREW (M6, M9)																		
49	144290J	HEAT INSULATION TUBE (M6, M9)																		
50	7009532	FRONT PLATE (M6, M9)																		
51	7009533	FRONT PLATE (BOTTOM) (M6, M9)																		
52	7009534	MOTOR MOUNTING PLATE (M6, M9)																		
53	2441537	FRONT PLATE ASSY. (M6, M9)																		
54	NA	FRONT PLATE (M6, M9)																		
55	NA	SERVICE PLATE ASSY. (M6, M9)																		



Ref. Part No: No:	Description:	Ref. Part No: No:	Description:
<b>Image 1:</b>		<b>Image 1:</b>	
1	2387392	46	7500061
2	7009598	47	NA
3	2441481	48	2127879
4	2311775	49	2116831
5	NA	50	2226992
6	2279686	51	NA
7	2286855	52	2127918
8	7500035	53	2116831
9	7009679	54	1944437
10	232005J	55	2227003
11	2165972	56	2119861
12	7009622	57	6019596
13	2279484	58	7500059
14	7009680	59	7500060
15	7009623	60	NA
16	7009455	61	2312879
17	NA	62	NA
18	7009625	63	2397368
19	147657J	64	2009065
20	NA	65	NA
21	2113337	66	7009608
22	012000J	67	2282668
23	1086083	68	2317139
24	2233628	69	NA
25	2204606	70	2311845
26	NA	71	159971J
27	7500077	72	2279484
28	2113344	73	NA
29	232005J	74	2165965
30	1996469	75	7500071
31	NA	76	4012537
32	2441506	77	NA
33	7500040	78	2165972
34	2441513	79	7500070
35	7500080	80	NA
36	NA	81	7009675
37	0650304	82	231501J
38	NA	83	NA
39	2387347	84	2103455
40	2279484	85	143584J
41	7009678	86	1505111
42	2103626	87	1801415
43	2103633	88	7500031
44	NA	89	7500030
45	1944437	90	2441498

**Ref. Part  
No: No:**

**Description:**

**Ref. Part  
No: No:**

**Description:**

**Image 1:**

91	7009700	WATER PROOF CAP (M6, M9)
92	NA	LIQUID PIPE ASSY. (M6, M9)
93	1996469	BODY/ ELECTRONIC EXP. VALVE (M6, M9)
94	231501J	REFRIGERANT FILTER (M6, M9)
95	2113344	FILTER (FOR REF.) (M6, M9)
96	NA	REFRIGERANT PIPE ASSY. (M6, M9)
97	7009455	FUSIBLE PLUG ASSY. (M6, M9)
98	2311799	WEIGHT (M6, M9)
99	4012540	HEX. BOLT (M6, M9)
100	128778J	THERMAL INSULATION (M6, M9)
101	7009684	WEIGHT (M6, M9)
102	7009680	WEIGHT ASSY. (M6, M9)
103	7009795	THERMAL INSULATION TUBE (M6, M9)
104	NA	THERMISTOR ASSY. (M6, M9)
105	NA	THERMISTOR ASSY. (M6, M9)
106	7009703	HEAT INSULATION TUBE (M6, M9)
107	144291J	HEAT INSULATION TUBE (M6, M9)
108	NA	THERMISTOR (M6, M9)
109	NA	ACCESSORIES ASSY. (M6, M9)
110	042408J	INSULATION TUBE/ REF. PIPING (M6, M9)
111	0424055	HEAT INSULATION COVER (M6, M9)
112	NA	TIE WRAP (M6, M9)
113	NA	THERMAL INSULATION TUBE (M6, M9)
114	NA	CLAMP/ LEAD WIRE (M6, M9)
115	1997424	ELECTRIC INSULATION (M6, M9)
116	056827J	TIE WRAP (M6, M9)
117	NA	ACCESSORIES ASSY. (M6, M9)
118	7500109	AUXILIARY PIPE (GAS SIDE FRONT) (M6, M9)
119	7500110	AUXILIARY PIPE (GAS SIDE BOTTOM) (M6, M9)
120	7500092	AUXILIARY PIPE DISCHARGE (GAS SIDE F) (M6, M9)
121	7500094	AUXILIARY PIPE DISCHARGE (GAS SIDE LOWER) (M6, M9)
122	7009575	AUXILIARY PIPE (LIQUID SIDE FRONT) (M9)
122	7009576	AUXILIARY PIPE (LIQUID SIDE FRONT) (M6)
123	7009577	AUXILIARY PIPE (LIQUID SIDE BOTTOM) (M9)
123	7009578	AUXILIARY PIPE (LIQUID SIDE BOTTOM) (M6)
124	1442816	ELBOW JOINT (M6, M9)
125	254105J	ELBOW JOINT (M6, M9)
126	7500085	THERMISTOR ASSY. (SUCTION) (M6, M9)
127	144290J	HEAT INSULATION TUBE (M6, M9)
128	165763J	THERMAL INSULATION TUBE (M6, M9)
129	144291J	HEAT INSULATION TUBE (M6, M9)
130	4010207	LABEL (WARNING) (M6, M9)

**Expanded Model Nomenclature**

M1 - REYQ120XATJU
M2 - REYQ120XAYCU
M3 - REYQ120XAYDU
M4 - REYQ144XATJU
M5 - REYQ144XAYCU
M6 - REYQ144XAYDU
M7 - REYQ168XATJU
M8 - REYQ168XAYCU
M9 - REYQ168XAYDU
M10 - REYQ72XATJU
M11 - REYQ72XAYCU
M12 - REYQ72XAYDU
M13 - REYQ96XATJU
M14 - REYQ96XAYCU
M15 - REYQ96XAYDU

# REYQ144XAYDU / REYQ168XAYDU

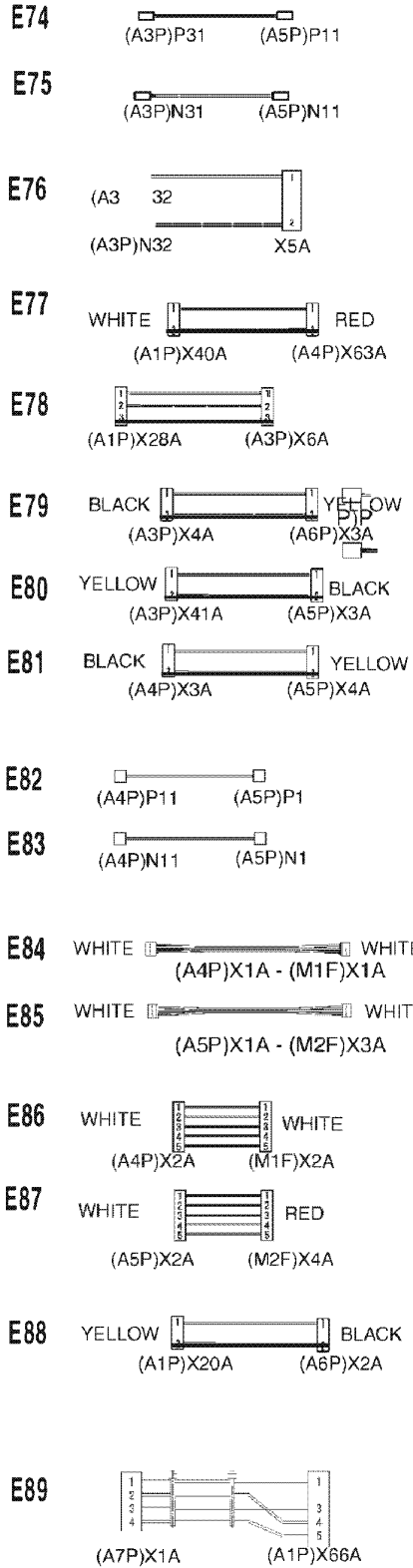
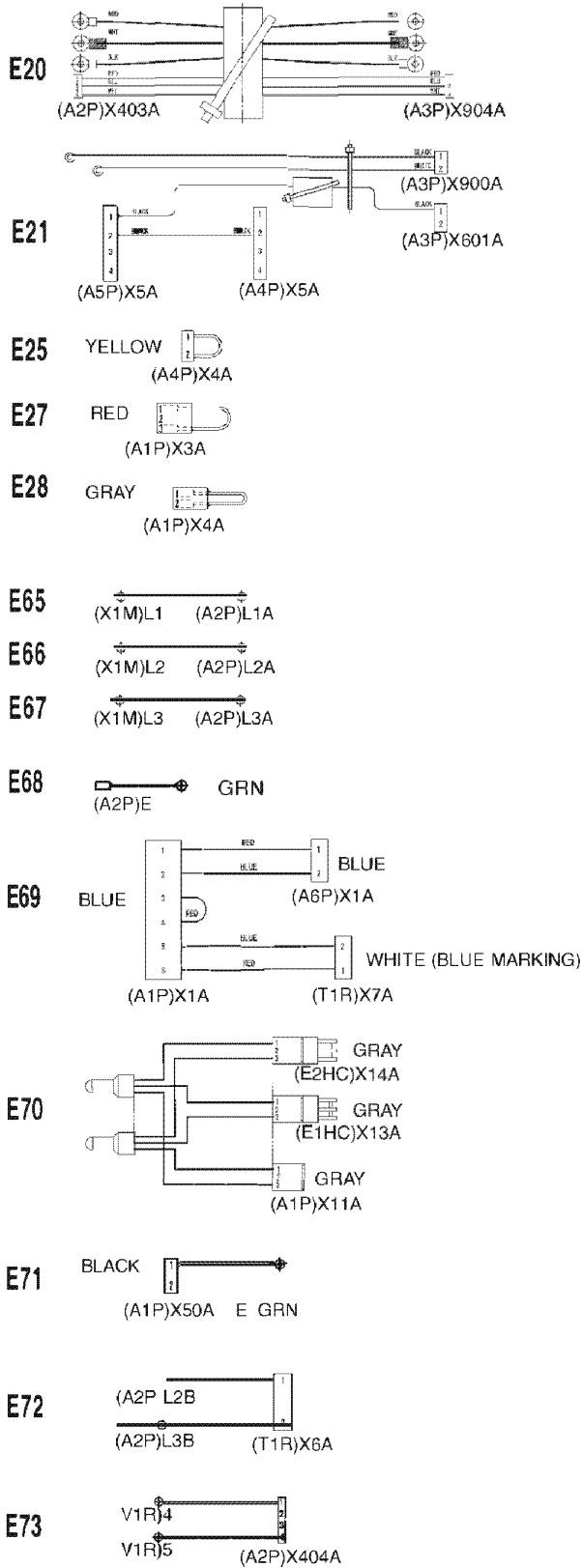

Picture Key	
Ref #	Picture #
1	E20
2	E21
3	E25
4	E27
5	E28
6	E65
7	E66
8	E67
9	E68
10	E69
11	E70
12	E71
13	E72
14	E73
15	E74
16	E75
17	E76
18	E77
19	E78
20	E79
21	E80
22	E81
23	E82
24	E83
25	E84
26	E85
27	E86
28	E87
29	E88
30	E89

Ref. Part No:	Part No:	Description:	Ref. Part No:	Part No:	Description:
---------------	----------	--------------	---------------	----------	--------------

**Image 1:**

1	2387424	WIRE HARNESS ASSY. (M6, M9)
2	2387431	WIRE HARNESS ASSY. (M6, M9)
3	1933413	CONNECTOR/ SHORT CIRCUIT (M6, M9)
4	135234J	CONNECTOR/ SHORT CIRCUIT (M6, M9)
5	2233712	CONNECTOR (M6, M9)
6	7009789	WIRE HARNESS (M6, M9)
7	7009790	WIRE HARNESS (M6, M9)
8	7009791	WIRE HARNESS (M6, M9)
9	7009792	WIRE HARNESS (M6, M9)
10	7009745	WIRE HARNESS ASSY. (M6, M9)
11	7009732	WIRE HARNESS ASSY. (M6, M9)
12	7009729	WIRE HARNESS (M6, M9)
13	7009793	WIRE HARNESS (M6, M9)
14	7009794	WIRE HARNESS (M6, M9)
15	2093750	WIRE HARNESS (M6, M9)
16	7009749	WIRE HARNESS (M6, M9)
17	7009765	WIRE HARNESS (M6, M9)
18	7009736	WIRE HARNESS (M6, M9)
19	7009763	WIRE HARNESS (M6, M9)
20	4014819	WIRE HARNESS (M6, M9)
21	2093301	WIRE HARNESS (M6, M9)
22	6019724	WIRE HARNESS (M6, M9)
23	6019712	WIRE HARNESS (M6, M9)
24	4014825	WIRE HARNESS (M6, M9)
25	2299091	WIRE HARNESS ASSY. (M6, M9)
26	2299109	WIRE HARNESS ASSY. (M6, M9)
27	7009730	WIRE HARNESS (M6, M9)
28	7009731	WIRE HARNESS (M6, M9)
29	7009734	WIRE HARNESS (M6, M9)
30	7009735	WIRE HARNESS ASSY. (M6, M9)

**Expanded Model Nomenclature**

- M1 - REYQ120XATJU
- M2 - REYQ120XAYCU
- M3 - REYQ120XAYDU
- M4 - REYQ144XATJU
- M5 - REYQ144XAYCU
- M6 - REYQ144XAYDU
- M7 - REYQ168XATJU
- M8 - REYQ168XAYCU
- M9 - REYQ168XAYDU
- M10 - REYQ72XATJU
- M11 - REYQ72XAYCU
- M12 - REYQ72XAYDU
- M13 - REYQ96XATJU
- M14 - REYQ96XAYCU
- M15 - REYQ96XAYDU

# REYQ144XAYDU / REYQ168XAYDU

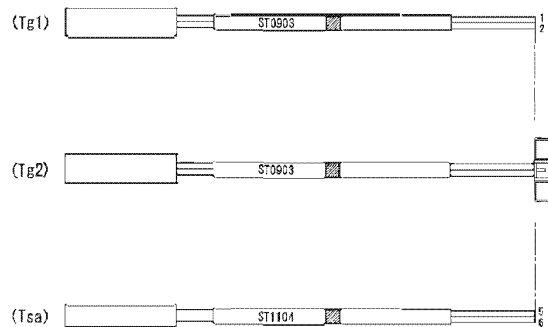

Picture Key

Ref #	Picture #
1	K11
2	K12
3	K18
4	K5

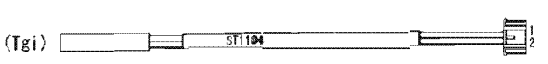
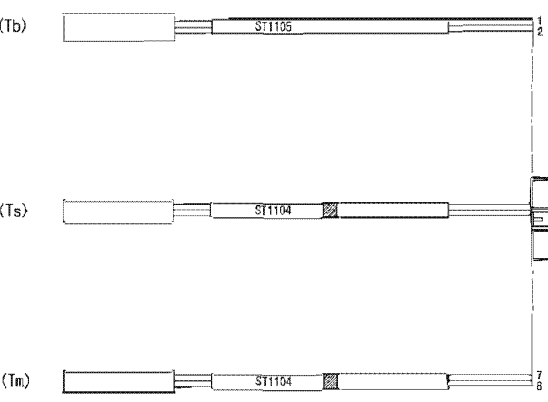
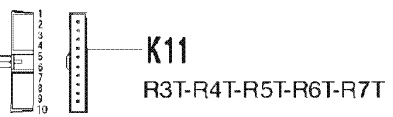
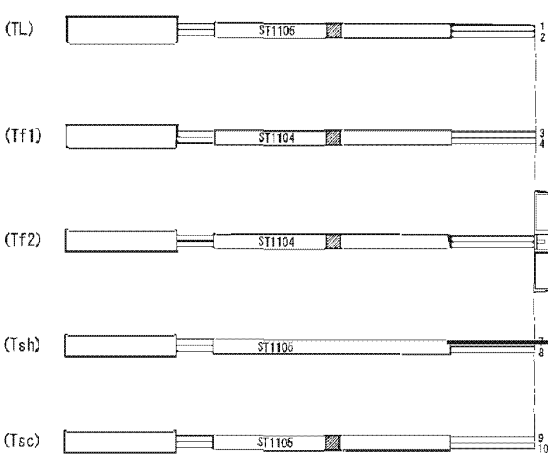



**Ref. Part  
No: No:**

**Description:**

**Ref. Part  
No: No:**

**Description:**

---

**Image 1:**

1	NA	THERMISTOR ASSY. (M6, M9)
2	NA	THERMISTOR ASSY. (M6, M9)
3	NA	THERMISTOR (M6, M9)
4	7500085	THERMISTOR ASSY. (SUCTION) (M6, M9)

**Expanded Model Nomenclature**

M1 - REYQ120XATJU
M2 - REYQ120XAYCU
M3 - REYQ120XAYDU
M4 - REYQ144XATJU
M5 - REYQ144XAYCU
M6 - REYQ144XAYDU
M7 - REYQ168XATJU
M8 - REYQ168XAYCU
M9 - REYQ168XAYDU
M10 - REYQ72XATJU
M11 - REYQ72XAYCU
M12 - REYQ72XAYDU
M13 - REYQ96XATJU
M14 - REYQ96XAYCU
M15 - REYQ96XAYDU