

Quickie Rhapsody Service Manual



Rhapsody



Quickie Rhapsody Service Manual Contents

Introduction.....	0.1		
VR2 Controller.....	0.2		
Plugs/Connectors.....	0.3		
Basic Tool List & Main Wiring Diagram.....	0.4		
Section 1			
Troubleshooting: No Power.....	1		
1.1 Circuit Breaker Reset.....	1		
1.2 Test Joystick.....	1		
1.3 Battery Test.....	1		
1.4 Not Charging.....	2		
1.5 Battery Connection Test.....	3		
1.6 Check Battery Wire Harness.....	4		
1.7 Battery Fuse.....	4		
1.9 Main Harness.....	4		
1.8 Circuit Breaker Test.....	4		
Section 2			
Understanding VR2 Controller Display.....	5		
2.1 The Maximum Speed Indicator Ripples.....	5		
2.2 The Maximum Speed Indicator Flashes.....	5		
2.3 Battery Gauge is Steady.....	5		
2.4 Battery Gauge Flashes Slowly.....	5		
2.5 Battery Gauge Steps Up.....	5		
2.6 Battery Gauge Blinks Once Every 2.5 Seconds.....	5		
2.7 Battery Gauge Flashes Rapidly.....	5		
Section 3			
Understanding VR2 Controller Diagnostics Codes.....	6		
3.1 One Bar - Low Battery Voltage).....	6		
3.2 Two Bars - Left Motor Disconnected.....	6		
3.3 Three Bars - Left Motor Wiring Trip).....	7		
3.4 Four Bars- Right Motor Disconnected.....	8		
3.5 Five Bars - Right Motor Wiring Trip.....	9		
3.6 Six Bars - Charger Connected.....	9		
3.7 Seven Bars - Possible Joystick Trip.....	9		
3.8 Eight Bars - Possible Control System Trip.....	9		
3.9 Nine Bars - Solenoid Brake Trip.....	10		
3.10 Ten Bars - High Battery Voltage.....	10		
3.11 Seven Bars + Speed Profile Indicator Communication Error.....	10		
Section 4			
Disassembly/Reassembly, and Adjustment....	11		
Step 1 - Seat removal.....	11		
Step 2 - Footrest adjustment and removal.....	12		
Step 3 - Shroud removal.....	12		
Step 4 - Battery removal.....	13		
Step 5 - Controller removal.....	13		
Step 6 - Motor removal.....	14		
Step 7 - Shock removal.....	15		
Step 8 - Caster removal.....	15		
Step 9 - On-Board Charger removal.....	16		
Step 10 - Suspension adjustment.....	16		

Introduction

Please read and follow instructions in this service manual before attempting to troubleshoot or repair this product for the first time. If there is anything in this Service Manual that is not clear, or if you require additional Technical assistance, contact Sunrise Medical at: (800) 333-4000 option 2, then option 1.

Safely troubleshooting and/or repair of this product depends on your diligence in following the instructions within this manual. Sunrise Medical is not responsible for injuries or damage resulting from a person's failure to exercise good judgement and/or common sense.



There are warning symbols used in this document to focus attention on any hazard that could effect the safety of the individual troubleshooting the chairs covered in this Service Manual.



This Service Manual is intended as a troubleshooting guide for the Quickie Rhapsody. Photographs and content may differ from the actual products in some cases due to changes in specifications and other factors.

This Service Manual is intended for use by persons with a basic working knowledge and the skills required in servicing and maintaining Power Wheelchairs. Persons without a General Working knowledge and expertise in the servicing of this product should not carry out troubleshooting procedures. This can result in problems with future servicing, and/or damage to the unit.

Parts and configuration or specifications of Products included in this Service Manual are subject to change without prior notice.

VR2 Controller



VR2 Controller Buttons

Battery Gauge

A series of ten LED's, which indicate charge level.



On/Off Key- Press to power on or off the power chair or Controller.

Horn Key- Activates a warning horn.



Speed/Profile indicator- A series of five LED's, which display speed and profile settings

Speed/ Profile Decrease. Used to decrease the Speed/ Profile setting.



Speed/ Profile Increase. Used to Increase the Speed/ Profile setting.

Plugs/Connectors

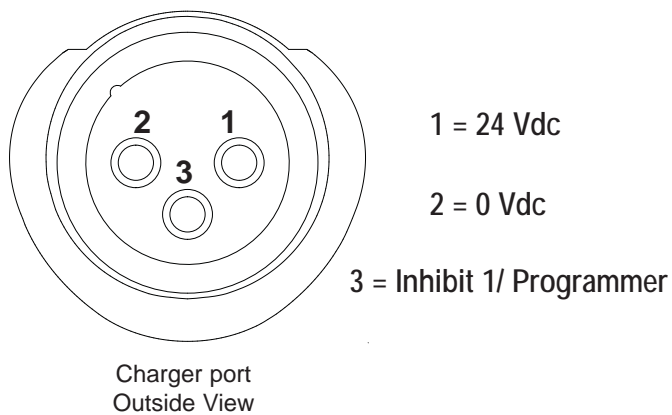
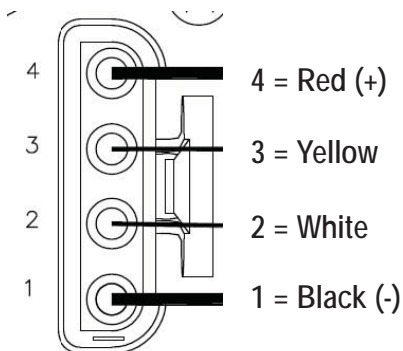
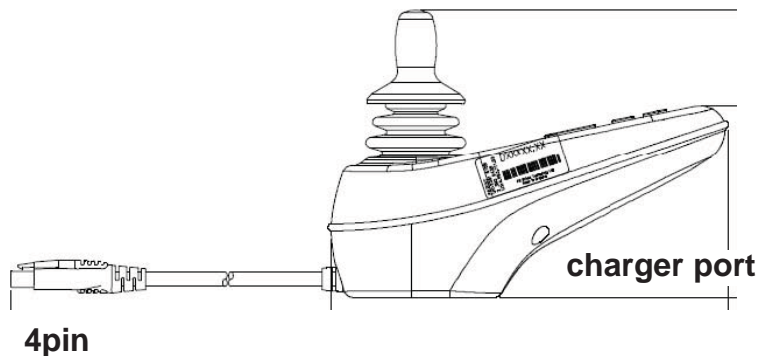

Motor Plug

MOTOR 1

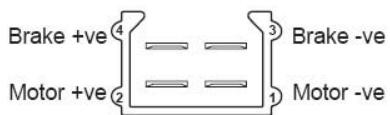

On-Board Charger

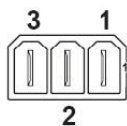

1 = 24 Vdc
2 = 0 Vdc
3 = INHIBIT 1/ PROGRAMMER

VR2 Controller

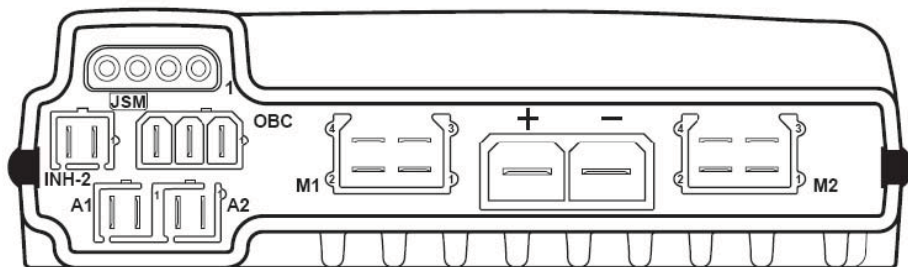

M1 = RIGHT SIDE MOTOR
M2 = LEFT SIDE MOTOR
JSM = JOYSTICK MODULE
INH-2 = INHIBIT 2
A1 = ACTUATOR 1
A2 = ACTUATOR 2
OBC = ON BOARD CHARGER
+ - = BATTERY

Basic Tool List & Main Wiring Diagram

Basic Tool List

The following list of tools should enable any task to be dealt with. Some will only occasionally be needed, but it is advisable to own or have access to them.

- 17mm Deep Socket wrench
- 13mm combination wrench
- Cutter for zip-tie
- Needle nose pliers
- 5mm Allen wrench
- 3/8 combination wrench
- Phillips screwdriver #2
- 18mm combination wrench
- Flat blade screwdriver
- 19mm socket wrench
- 5mm socket wrench

Wiring Diagram for VR2 Controller Package

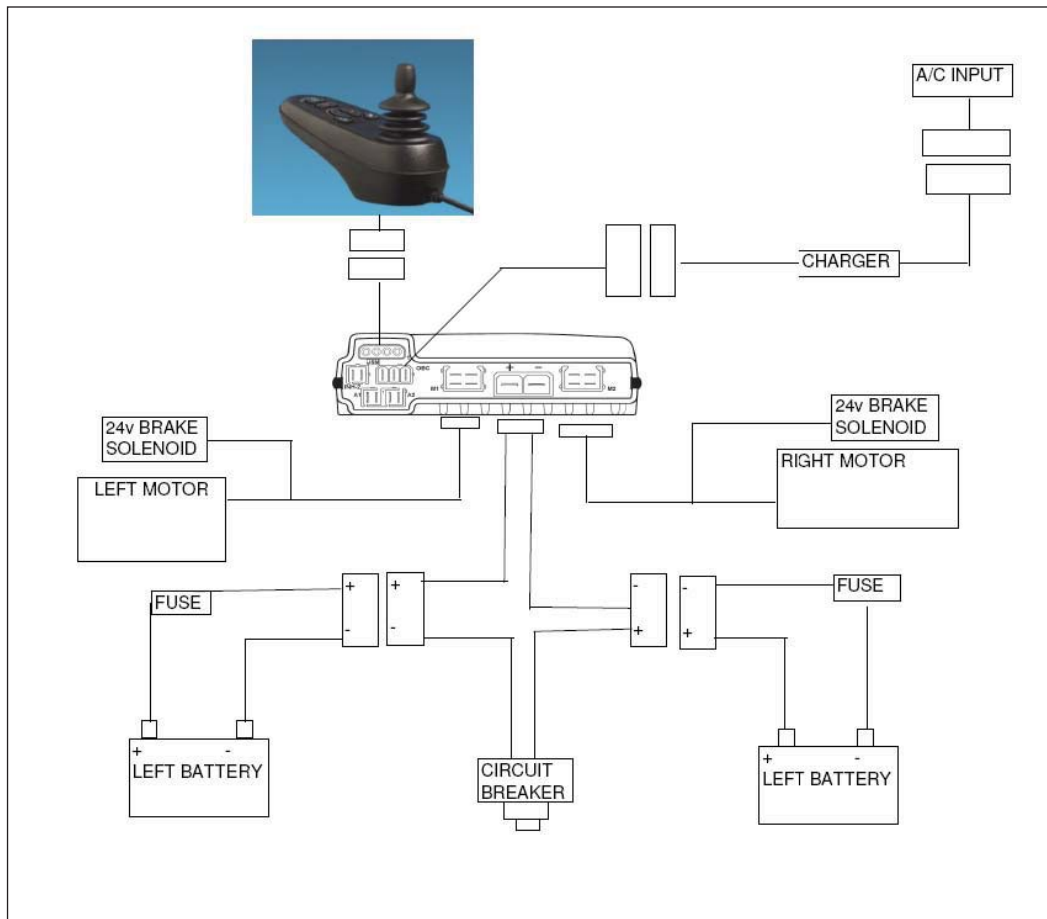

Section 1

Troubleshooting: No Power

1.1 Circuit Breaker Reset

If On/off button is pressed and no light or bar is shown, check for tripped circuit breaker (see figure A1.1.1) and make sure all connections are clean and tight (including the batteries). If the problem persists, then perform the following diagnostics.



1.2 Test Joystick

Check that the voltage is going to the controller, set the meter to dc volts and take a voltage reading from pin 1 (using the red lead) and pin 2 (using the black lead) to the charger port of the VR2 joystick (see figure A1.2.1) If the voltage meter reads approximately 24 volts, proceed to Battery Connection Test, if the meter reads less than 12 volts, proceed to the next step.

Note: Make sure the polarity is correct. If the reading is intermittent, there is a connection or Controller problem. If polarity is reversed proceed to step 1.6

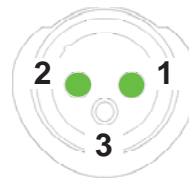
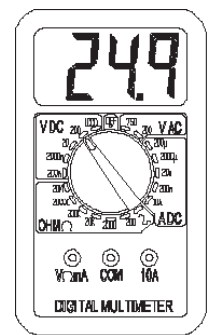

1.3 Battery Test

Check that the batteries are fully charged and in good condition. Remove the seat, and the battery cover, with controller connected and turned on, use the meter to check the voltage across the battery terminals (see figure A1.3.1). If the voltage meter reads between 12 -13.5 volts, then proceed to next step. If the voltage meter reads below 12volts,charge the batteries.

Note: To find a bad battery, use a battery load tester.

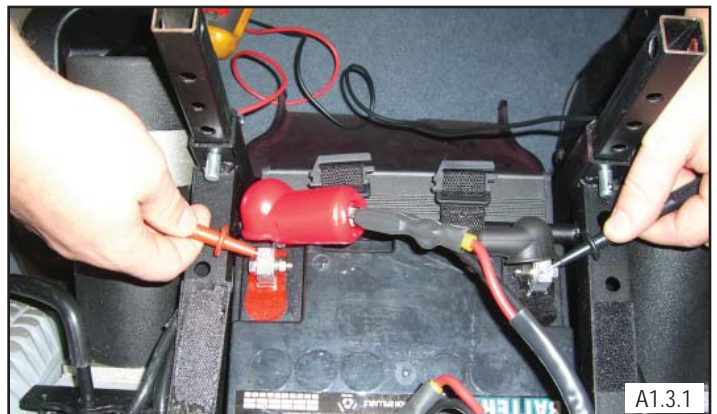

- *If the voltage meter reads below 12 volts, charge the batteries.*

Section 1

Troubleshooting: No Power (cont.)

1.4 Not Charging

If the chair is not charging through the rear charging port, check that the circuit breaker is not tripped. Insure the three pin charger is properly connected and in good condition. Measure the voltage across pin one and pin two (fig 1.4.1)

If the voltage meter reads approximately 24 volts, replace the charger, if the meter reads less than 12 volts, check the corresponding pins ont the controller (fig 1.4.2) if the meter reads less than 12 volts, proceed to the next step.



- *If all of the measurements read full voltage, then replace the controller.*

Troubleshooting: No Power (cont.)

1.5 Battery Connection Test

Check that the female VR2 Bus plug on the chair has voltage. Set the meter to dc volts and measure pins 4 (using the red lead of the meter) and 1 (using the black lead of the meter) as shown in (fig A1.5.1)

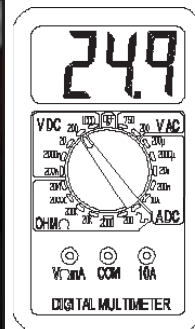

If the voltage meter reads full voltage, then replace the joystick module

If the voltage meter reads zero voltage measure the corresponding pins on the VR2 controller as shown in (figure 1.5.2).

If the voltage meter reads full voltage, then replace the jumper cable. If the voltage meter reads zero, then measure the Battery Connector as shown in (fig 1.5.3)

If the voltage meter reads full voltage, then replace the controller, or else proceed to the next step.

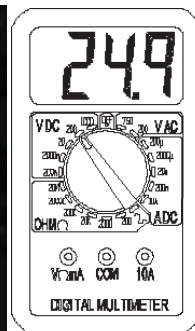
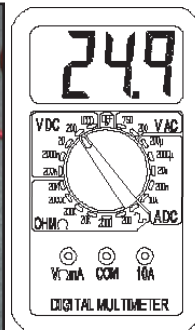

- *If all of the measurements read full voltage, then replace the controller.*

Section 1

Troubleshooting: No Power (cont.)

1.6 Check Battery Wire Harness

Check that the battery wire harness has the polarity correct. Set the meter to dc volts and measure the connector with the red lead on the + terminal and the black lead on the negative terminal as shown in (figure 1.6.1) If both the battery wire harness have full voltage and correct polarity, then proceed to circuit breaker test. If the voltage is absent proceed to battery fuse test. If the polarity is reversed correct battery wiring.

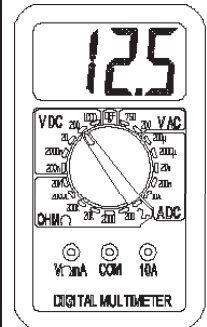

- *If polarity is reversed correct battery wiring.*

1.7 Battery Fuse

Check that the battery fuse is in good condition. With the batteries disconnected remove the fuse cap, inspect the fuse to see if the fuse is blown. To make sure the fuse is not blown, set the meter to ohms and measure the resistance across the fuse. see (figure A1.7.1). If the meter reads more than one ohm, change the wiring harness, or else proceed to the next step.

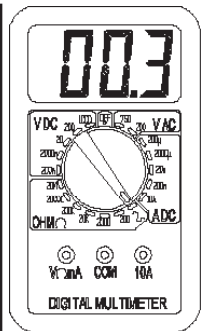

- *If the meter reads more than one ohm, change the Battery harness.*



1.8 Circuit Breaker Test



To check the circuit breaker set the meter to ohms and measure the resistance across the circuit breaker as shown in (figure A1.8.1). If the meter reads more than 1 ohm, then change the circuit breaker, otherwise proceed to next step.

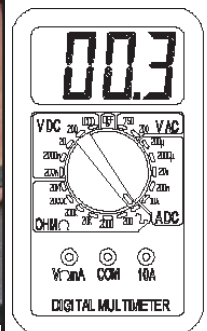

- *If the meter reads more than 1 ohm, then change the circuit breaker.*

1.9 Main Harness

If the above steps did not correct the problem, change the main harness.

- *If the previous steps did not correct the problem, change the main harness.*

Section 2

Understanding VR2 Controller Display

2.1 The Maximum Speed Indicator Ripples

Indicates that the wheelchair is locked. To unlock the wheelchair, deflect the joystick forwards until the control system chirps. Then deflect the joystick in reverse until the control system chirps. Release the joystick, there will be a long beep. The wheelchair is now unlocked. To lock the wheelchair, while the control system is switched on, depress and hold the on/off button. After 1 second, the control system will chirp. Now release the on/off button, deflect the joystick forwards until the control system chirps, and deflect the joystick in reverse until the control system chirps. Release the joystick, there will be a long beep. The wheelchair is now locked.

2.2 The Maximum Speed Indicator Flashes

This indicates that the chair is charging via on-board charger. The chair will be ready to drive as soon as the charger is unplugged.

2.3 Battery Gauge is Steady

This indicates that all is well.

2.4 Battery Gauge Flashes Slowly

The control system is functioning correctly, but you should charge the battery as soon as possible. At 21.5 V, the red light starts to blink. Each bar represents a .5V value. The controller requires 18V to start and a minimum of 16V to work once started

2.5 Battery Gauge Steps Up.

Indicates the wheelchair batteries are being charged with the offboard charger. You will not be able to drive the wheelchair until the charger is disconnected and you have reset the control system by switching off the power and then powering up again.

2.6 Battery Gauge Blinks Once Every 2.5 Seconds

The control system has "gone to sleep" because the wheelchair has not been driven for a period of time. The time period depends on the programming of the system. To re-start, reset the system by switching off the power and then powering up again.

2.7 Battery Gauge Flashes Rapidly

Make sure the Joystick is completely released. The control system safety circuits have been activated and the control system has been prevented from moving the wheelchair. This indicates a system trip, i.e. the VR2 has detected a problem somewhere in the wheelchair's electrical system. Please refer to Section 3 (VR2 Controller Diagnostics).

Section 3

Understanding VR2 Controller Diagnostics Codes

3.1 One Bar - Low Battery Voltage)

This code could indicate discharged batteries, failed batteries, or poor battery connections. Begin by recharging the batteries and then refer to Section 1 to check batteries and connections.

3.2 Two Bars - Left Motor Disconnected

Check that the batteries are fully charged and in good condition; and check all cables and connections. Check the connections to the left motor, look for a loose or damaged connector.

Otherwise, check the brushes on the left motor. Ensure that they are not excessively worn, (replace as required) as shown in (Figure A3.2.1).



Use the meter to check the resistance across the two bottom contacts (thicker wires) on the 4-pin motor connector as shown in (figure A3.2.2). If the meter reads between 0 to 1.5 ohms, then replace the controller. If none of the above corrects the problem, replace the left motor.

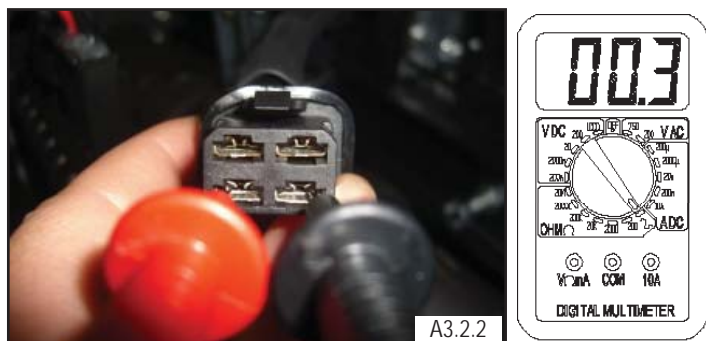

- *If the meter reads between 0 to 1.5 ohms, then replace the controller.*
- *If none of the above corrects the problem, replace the left motor.*

Section 3

Understanding VR2 Controller Diagnostics Codes (cont.)

3.4 Four Bars- Right Motor Disconnected

Check that the batteries are fully charged and in good condition; and check all cables and connections. Check the connections to the right motor, look for a loose or damaged connector.

Otherwise, check the brushes on the right motor. Ensure that they are not excessively worn, (replace as required) as shown in (Figure A3.4.1).



Use the meter to check the resistance across the two bottom contacts of the thicker wires on the 4-pin motor connector as shown in (figure A3.4.2). If the meter reads between 0 to 1.5 ohms, then replace the controller. If none of the above corrects the problem, replace the right motor.

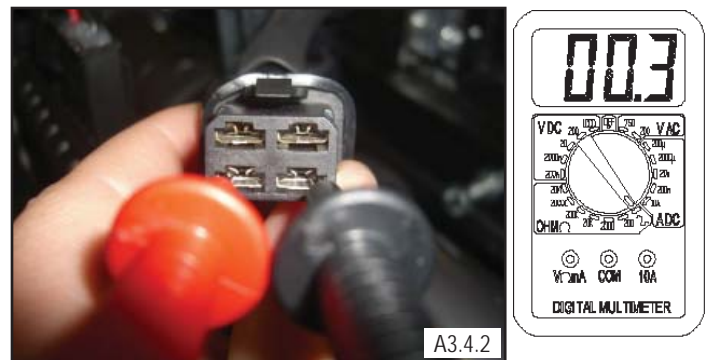

If the meter reads between 0 and 1.5 ohms, then replace the controller. If this does not correct the problem, then replace the right motor.

Section 3

Understanding VR2 Controller Diagnostics Codes (cont.)

3.5 Five Bars - Right Motor Wiring Trip

Check that the batteries are fully charged and in good condition; and check all cables and connections. Check the connections to the right motor, look for a loose or damaged connector.

If the reading is short (resistance is less than 10 K ohms) on any of the readings, proceed to check the 4-pin motor connector. Measure the resistance from the bottom contact of the red thick wire on the 4-pin right motor connector to each of the top contacts of the connectors see (figure A3.5.3). Measure the resistance from the bottom contact of the black thick wire on the 4-pin right motor connector to each the top contacts of the connector (below right). If all of the readings are open, then replace the controller. If any of the readings are short, then replace the right motor.

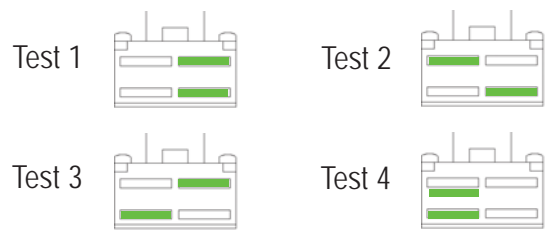
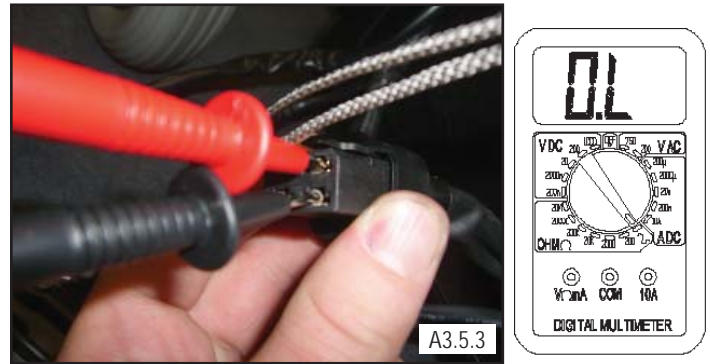

- *If all of the readings are open, then replace the controller.*
- *If any of the readings are short, then replace the right motor.*

3.6 Six Bars - Charger Connected

The Onboard Batteries are being charged with the off-board charger. You will not be able to drive the wheelchair until the charger is disconnected. You will have to reset the control system by switching off the power and the Powering up again. The On-Board charger has no indication that the chair is charging, and the chair will not move until complete. If the condition still exists after the charger has been disconnected and the chair has been switched off and powered up again, the Joy stick module may be defective.

3.7 Seven Bars - Possible Joystick Trip

A joystick trip is indicated. Make sure that the joystick is in the center position before switching on the control system. Check that the batteries are fully charged and in good condition, examine the joystick for damage. This fault can be caused by a joystick that fails to center itself due to being dirty, bent or broken. If this is the case, replace the joystick module.

- *If the joystick fails to center because it is bent or broken, replace the joystick module.*

3.8 Eight Bars - Possible Control System Trip

Controller Fault - A control system trip is indicated. Make sure that all connections are secure. Check that the batteries are fully charged and in good condition, and check all joystick connections and cables. If this does not correct the problem, then replace the controller.

Section 3

Understanding VR2 Controller Diagnostics Codes (cont.)

3.9 Nine Bars - Solenoid Brake Trip

The parking brakes have a bad connection. Check the parking break and motor connections. Make sure the control system connections are secure. Measure the two small contacts on the four-pin motor connector (fig 3.8.1). If both motor connectors read approximately 60 ohms, then replace the controller. Otherwise replace the motor that does not read approximately 60 ohms.

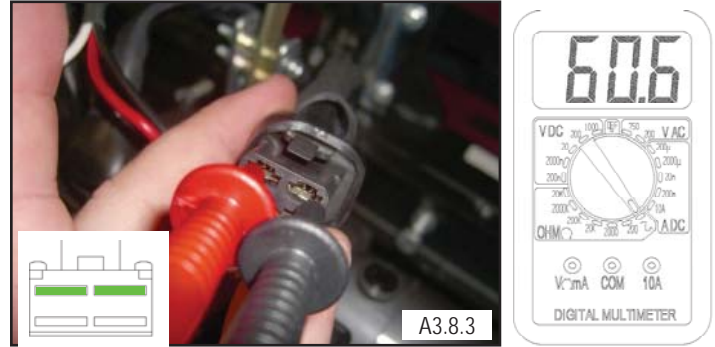

● *If both motor connectors read approximately 60 ohms, then replace the controller. Otherwise, replace the motor that does not read approximately 60 ohms.*

3.10 Ten Bars - High Battery Voltage

An excessive voltage has been applied to the control system. This is usually caused by a poor battery connection. Check the battery connections.

Battery Fault

Check that the batteries are fully charged, the correct voltage and in good condition. Take a voltage reading from pin 1 and pin 2 of the charger port of the VR2 controller, see (figure A3.9.1) If the meter reads more than 30 volts, then check the charger. Otherwise, replace your controller.

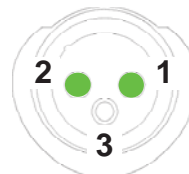

- *If the meter reads more than 30 volts replace the charger,*
- *If the Batteries, connections, and voltage level are correct replace the controller.*

3.11 Seven Bars + Speed Profile Indicator Communication Error

Inspect wiring between joystick module and controller. Replace the jumper or joystick module with damaged wiring. If the problem persists replace the controller.

Section 4

Disassembly/Reassembly, and Adjustment

Step 1 - Seat removal

Disassembly

1. Unplug joystick at the base of the chair. (figure s1.1).
Note: Remember to lay cables on the seat otherwise they may become tangled when taking off the seat.
2. Fold seat back down (figure s1.2).
3. Remove front hand screws (figure s1.3).
4. Loosen knobs on rear seat posts (figure s1.4).
5. Pull rear pins and tilt seat forward (figure s1.5).
6. Slide seat back while lifting and remove (figure s1.6).



Section 4

Disassembly/Reassembly, and Adjustment

Step 2 - Footrest adjustment and removal

To adjust footplate position

1. Remove the clevis pin (fig s2.1)
2. Slide footrest assembly in or out to desired position and reinsert clevis pin.



To remove footplate

1. Remove clevis pin (fig s2.1)
2. slide footrest assembly out of frame (fig s2.2).



Step 3 - Shroud removal

Top shroud:

1. Remove four wing bolts (fig s3.1) holding top shroud and remove.



Front shroud

1. Complete step 2 (Footrest removal)
2. Remove front shroud (fig s3.2) (attached with Velcro).



Section 4

Disassembly/Reassembly, and Adjustment (cont)

Step 4 - Battery removal

1. Remove seat (step 1)
2. Remove top shroud (step 3)
3. Disconnect battery harnesses (fig s4.1)
4. Carefully lift rear battery and remove (fig s4.2), then front battery.



Step 5 - Controller removal

1. Remove the footrest (step 2)
2. Remove front shroud (step 3)
3. Disconnect battery harnesses (fig s4.1)
4. Unplug all connectors from the controller.
5. Loosen and remove wing nuts
6. Remove controller from frame(fig s5.1)



Section 4

Disassembly/Reassembly, and Adjustment (cont)

Step 6 - Motor removal

1. Complete steps 1-4, removal of seat, footrest, shrouds and batteries.
2. Unplug the motor connector (fig s6.1) from the controller and remove any zip ties holding the cable harness to the frame.
3. Use a 17mm socket wrench to remove the drive wheel (fig s6.2)
4. Using two 13mm wrenches remove four bolts and nuts (s6.3) holding motor plate to the frame.
5. Remove the cotter pin (A) (fig s6.4) holding the cog release handle (B) to the cog release lever arm (C).
6. Use a 5mm hex key to remove the six socket head capscrews holding the motor gearbox housing to the motor plate (fig s6.5).

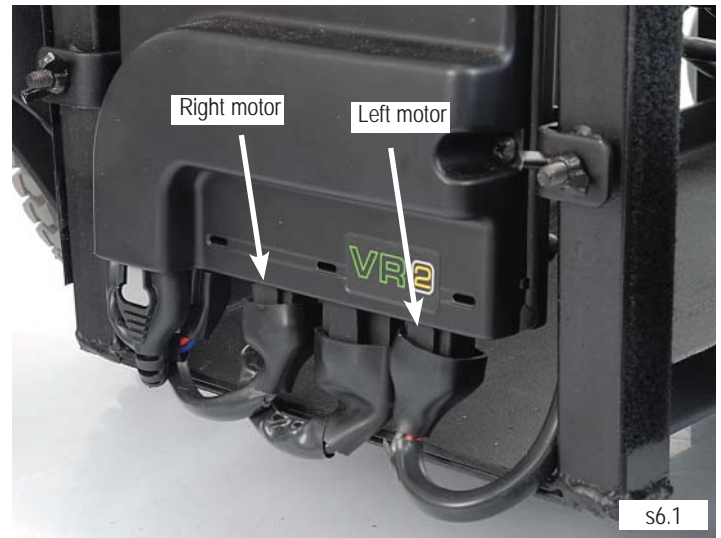

Warning-When motor plate is removed the gear box plate may come off

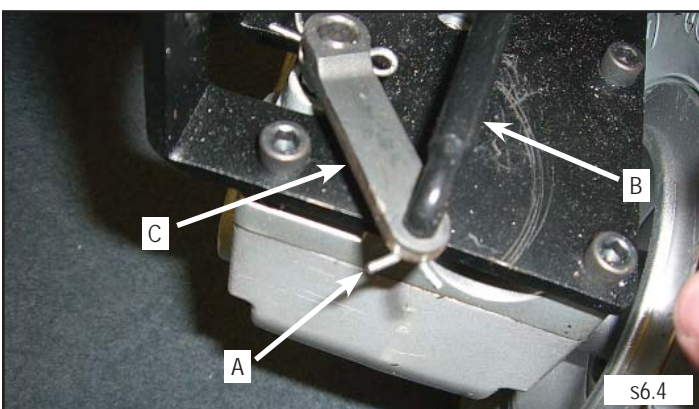

Section 4

Step 7 - Shock removal

Disassembly

1. Using a 13mm wrench, remove top shock bolt (A)
2. Mark the position of the suspension shock mount.
3. Use a 5mm hex key to remove the two socket head cap screws (B) holding the suspension shock mount (C).
4. Use two 19mm wrenches to remove the lower shock bolt (E) and nut(D).

Reassembly:

1. Insert the M12x1.75x100 hex bolt (D) through the front suspension arm (F) and the lower hole in the shock.
2. insert the suspension shock mount shaft into the top hole in the shock.
3. replace the two M6x17 socket head cap screws(B) and hand tighten
4. Slide the suspension shock mount (C) back to its original position and tighten the M6x17socket head cap screws (B)
5. Replace and tighten the top shock bolt (A)

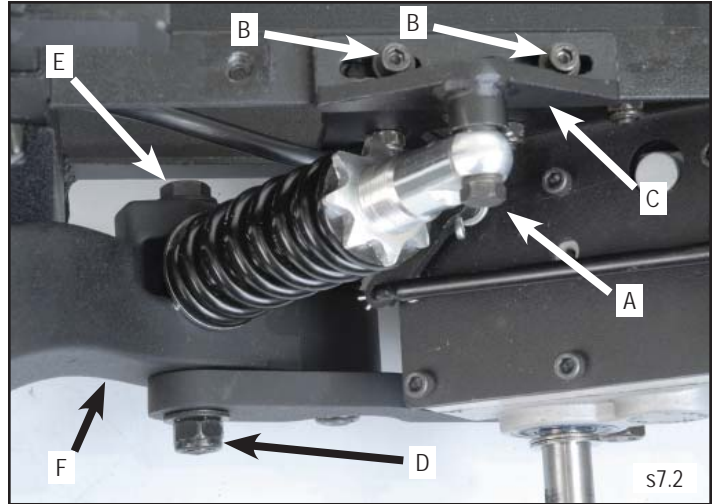

Step 8 - Caster removal

1. Remove caster cap (fig s8.1)
2. Use a 19mm socket wrench to remove the caster nut (fig s8.2)



Section 4

Disassembly/Reassembly, and Adjustment (cont)

Step 9 - On-Board Charger removal

1. Open rear cover (s9.1)



2. Remove 2 straps on charger straps and remove charger (s9.2)

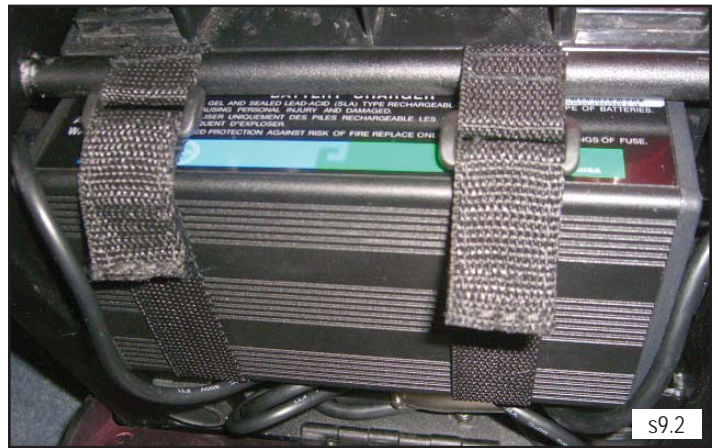

Step 10 - Suspension adjustment

Adjust nut down to stiffen the ride
Adjust nut up to soften the ride

