

# Ricoh TLS 401

Posted 12-8-'02

This camera manual library is for reference and historical purposes, all rights reserved.

This page is copyright by [mike@butkus.org](mailto:mike@butkus.org), M. Butkus, NJ.

This page may not be sold or distributed without the expressed permission of the producer  
I have no connection with Chinon Co., Japan

On-line camera manual library

This is the full text and images from the manual. This may take 3 full minutes for all images to appear.

If they do not all appear. Try clicking the browser "refresh" or "reload button" or right click on the image, choose "view image" then go back. It should now appear.

To print, try printing only 3 or 4 pages at a time.

**If you find this manual useful, how about a donation of \$3 to:**

**M. Butkus, 29 Lake Ave., High Bridge, NJ 08829-1701**

**and send your e-mail address so I can thank you.**

**Most other places would charge you \$7.50 for a electronic copy or**

**\$18.00 for a hard to read Xerox copy.**

**This will allow me to continue to buy new manuals and pay their shipping costs.**

**It'll make you feel better, won't it?**

**If you use Pay Pal, use the link below. Use the above address for a check, M.O. or cash.**



[Back to main camera manual page](#)

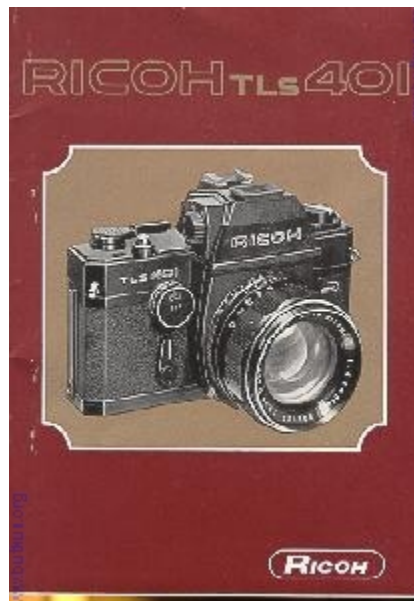

## **THE NEW RICOH TLS 401 HAS FEATURES YOU'LL LIKE.**

### **Exclusive 4-in-i range/view finder**

enables you to capture your subject either through the eye-level or waist-level eyepiece. And, you can switch the average light measuring to spot light measuring or vice versa as the occasion requires. The A (average) or S (spot) mark in the viewfinder indicates the measuring area you are aiming at.

### **Through-the-lens viewing**

ends accidental subject cropping. . .you see your exact picture in the viewfinder as you take it. . .

### **Through-the-lens focusing**

Micro-split image rangefinder plus focusing screen make extra-sharp pictures easier to take.

### **Through-the-lens system CdS exposure meter**

measures the light with a high degree of accuracy.

### **Single stroke film-advance lever**

also cocks shutter, counts exposures, and prevents double exposures.

### **Instant return mirror**

Automatically returns to viewing position the instant an exposure is made --no viewfinder "blackout" to delay picture taking.

### **High Speed AUTO RIKENON Lens**

lets you shoot in lighting situations where slower lenses would fail; produces slides and prints of Superior sharpness and color fidelity.

### **Automatic diaphragm**

lets you focus and compose with the lens at its widest opening --prevents viewfinder dimming when smaller lens openings are selected.

### **High speed focal plane shutter**

Full range of speeds from 1 second to 1/1000 second-plus bulb--lets you "freeze" swift action as well as take photos of excellent quality in even dimly-lit conditions. . .

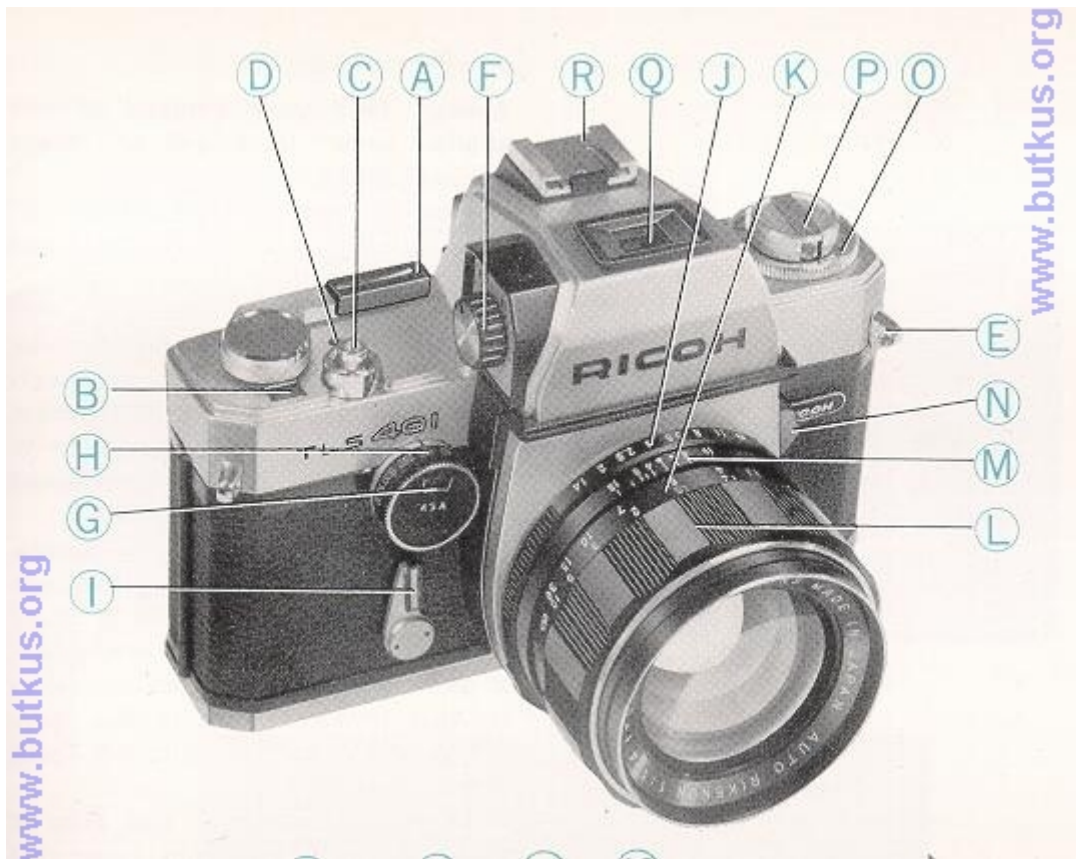

## KNOW YOUR CAMERA

- A) Film-wind Lever
- B) Film Counter
- C) Shutter Release Button
- D) Exposure Meter Signal for "Switch-on" and "Film-wound"
- E) Neck Strap Eyelet (2)
- F) Eye-level Waist-level Change-over Knob
- G) Film Speed Selector
- H) Shutter Speed Dial
- I) Self-timer Lever
- J) F-stop Ring
- K) Distance Scale
- L) Focusing Ring
- M) Depth of Field Scale
- N) Exposure Meter Switch
- O) Film Reference Dial
- P) Film Rewind Knob
- Q) Waist-level Eyepiece
- R) Accessory Shoe
- S) Eye-level Eyepiece

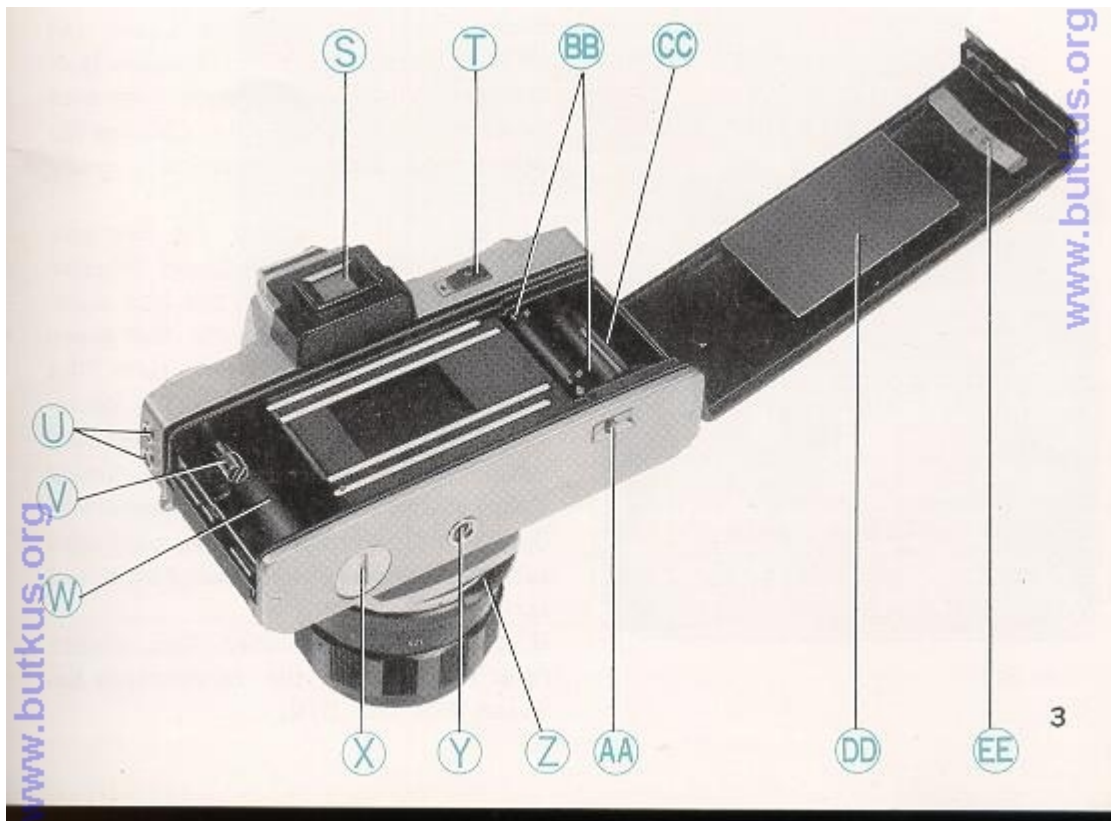

T) Average Spot Switch

U) Flash Socket (2)

V) Rewind Shaft

W) Film Chamber

X) Exposure Meter Battery Compartment Cover

Y) Tripod Socket...

Z) Preview Switch

AA) Rewind Button

BB) Sprocket Teeth (2)

CC) Take-up Spool

DD) Film Pressure Plate

EE) Cartridge Retaining Spring

## FILM LOADING

**Always load your camera in the shade, never in bright or direct sunlight.**

Use good quality standard 35mm (20 or 36-exposure) film, color or black and white.

Press Shutter Release Button (C)...Pull Film Rewind Knob (P) until camera back clicks open. Swing open camera back, place film cartridge into Film Chamber (W) and push Rewind Knob back to its original position...Be certain Rewind Shaft (V) engages film cartridge.

Pull tapered end of film across back of camera and insert into and through the left side of slit of Take-up Spool (CC). Rotate Take-up Spool in direction of arrow to take film slack...check to see that sprocket holes in film have engaged both sets of Sprocket Teeth (BB). (Fig. 1)...

Close the camera back and snap it shut. Advance Film-wind Lever A) twice, depressing Shutter Release Button (C) each time. Advance Film-wind Lever once more and Film Counter (B) will be automatically set to "1" ", ready for your first picture.

Set exposure meter for the film you are using, rotating Film Speed Selector (G), while pulling it, until the ASA number of your film is opposite the green indicator line. (Fig. 2) Also turn Film Reference Dial (O) and set the corresponding type of your film to the black indicator line. This will help to remind you of the type of the film you are using. Check the instruction sheet packaged with your film for the correct ASA speed for that film.

If you are using German film, please refer to Fig. 3 for the relationship between ASA and DIN.

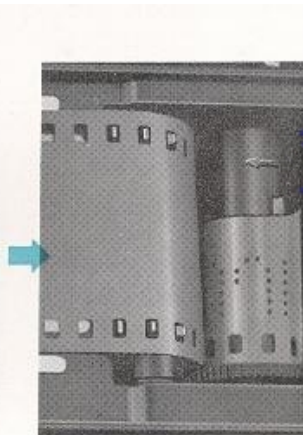
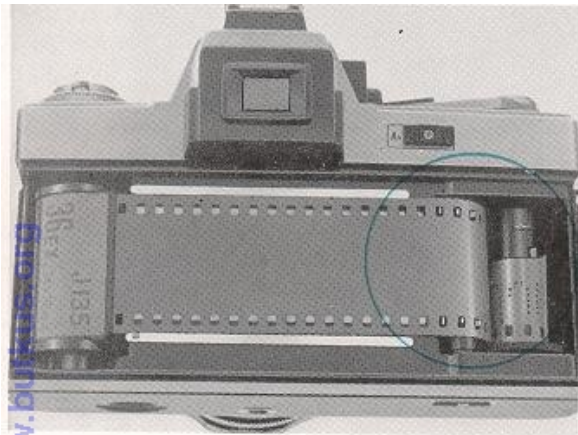
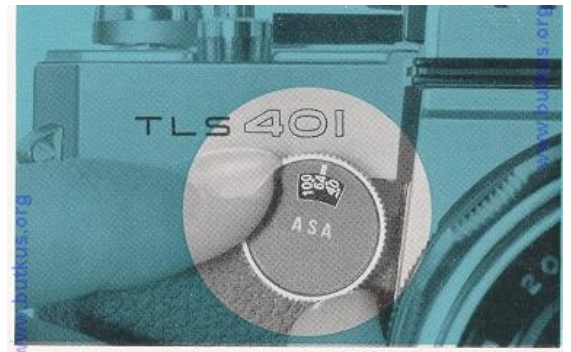

Fig. 1



ASA	10	12	15	20	25	32	40	50	64	80	100	120	160	200	250	320	400	500	640	800
DIN	11	12	13	14	15	16	17	18	19	20	21	22	23	24	25	26	27	28	29	30

Fig. 3.



## CORRECT EXPOSURE

Correct exposure is achieved by setting the lens f-stop) and shutter in correct combination for the film, subject, and lighting conditions. As your RICOH TLS 401 camera has a built-in through-the-lens system CdS exposure meter, you can adjust the exposure with a high degree of accuracy in the following manner:—

1. Unscrew Exposure Meter Battery Compartment Cover (X) with a coin and place a battery with plus (+) end up. (Fig. 4) The battery will last for a year or so. For replacement use Eveready EPX 625, Mallory RM 625R or equivalent.
2. Check that the correct ASA number is set on the Film Speed Selector (G).

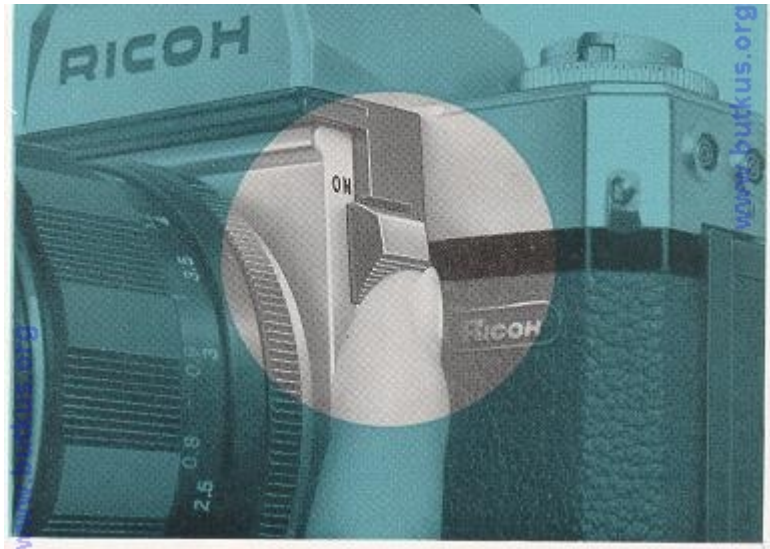
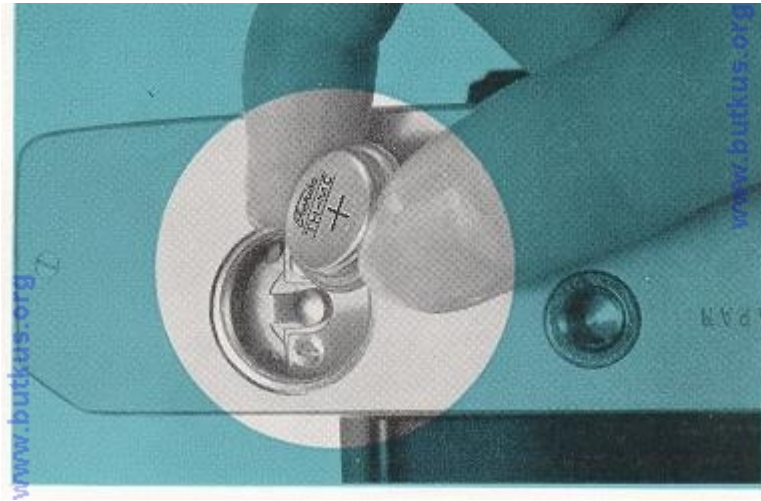

3. Turn "ON" the Exposure Meter Switch (N) pushing it upward. (Fig.5).

This Exposure Meter Switch is the main switch in the heart of the light sensing system. When you wind Film-wind Lever (A) another micro-switch is turned on automatically. If you press Shutter Release Button (C), the micro-switch is turned off automatically. When the main switch is left at ON position and the shutter is left unreleased, the Exposure Meter Battery is consumed. Always make sure that the main switch is at OFF position whenever the camera is not in use for a long period of time or make it a rule to always carry the camera with the shutter released. This little care will take a new lease of the Exposure Meter Battery. The second microswitch can be seen in a little window by winding the lever.---

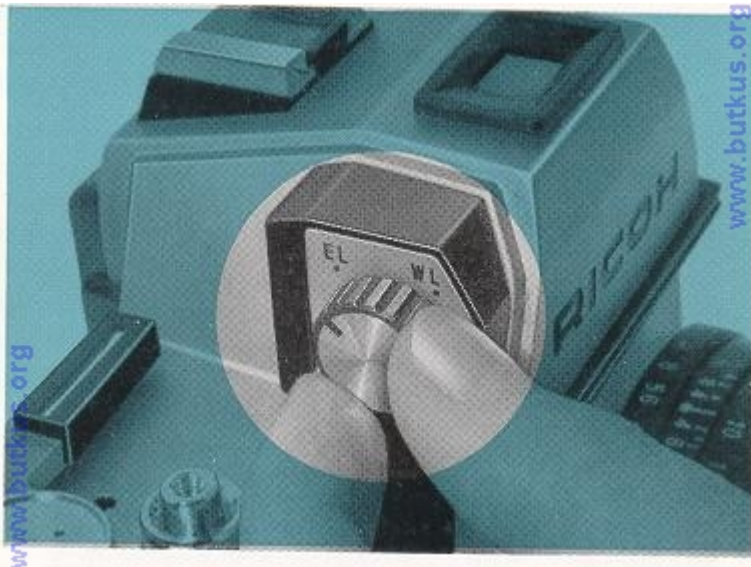

When lever is wound, i.e., switched on, green sign is in the window.

With the release of the shutter, i.e., switch off it turns to red.

4. Set either the shutter speed or lens opening according to your photographic needs. (Read "Setting the lens" and "Setting the shutter" carefully.)

5. Set Eye-level Waist level Change over Knob (F) at EL (Eye-level position) (Fig. 6) and while looking at your subject through the Eye-level Eyepiece (S), rotate either Shutter Speed Dial (H) or F-Stop Ring (J) until the exposure meter needle at the right side of the Viewfinder comes to the complete horizontal position... Now your subject is in correct exposure. If the exposure meter needle is above the horizontal position, this is over exposure.

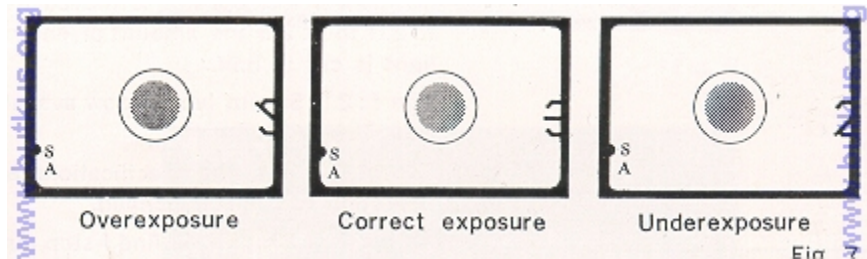

Change the shutter speed to faster speed or use smaller lens opening so that the correct exposure combination is made. If, on the contrary, the exposure meter needle is found under the horizontal position indicating underexposure, you must use a slower shutter speed or bigger lens opening. (Fig. 7)

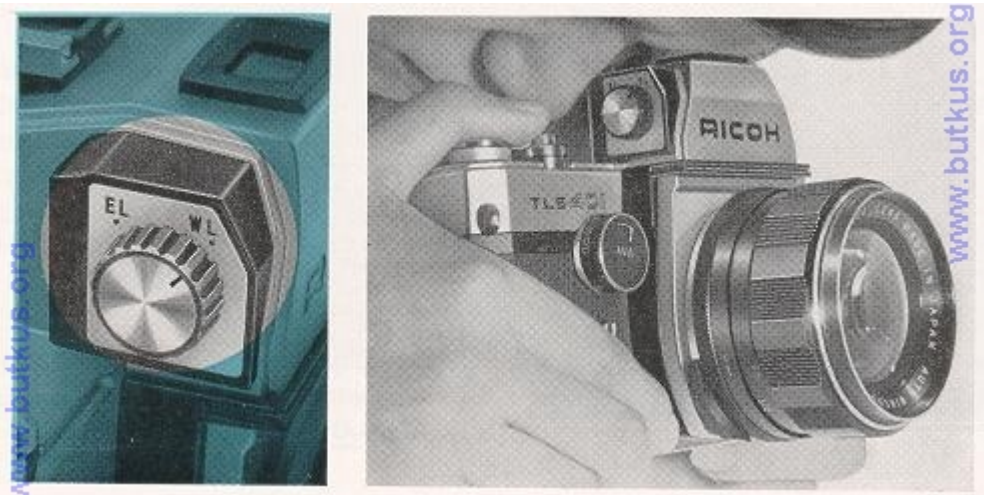

6. If you want to use Waist-level finder, set Eye-lever/ Waist-level Change-over Knob (F) at WL (Waist-level position) and look your subject through the Waist-level Eyepiece (Q) on the top of the camera. (Fig. 8) It is recommended that you utilize the rubber eye-cup packed with each camera, especially for Waist-level measuring, for clear and better viewing...

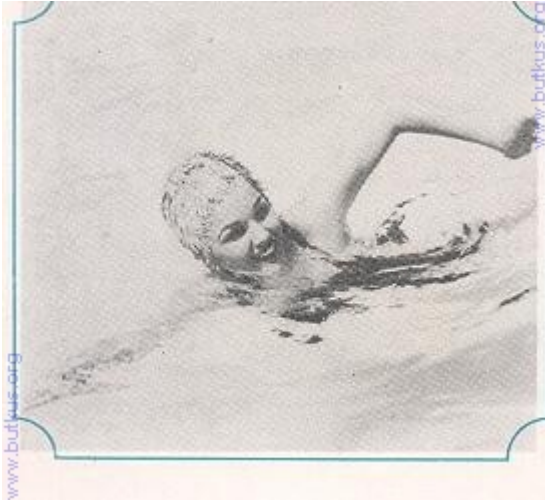

## SETTING THE LENS



Rotate F-Stop Ring (J) until the desired f-stop number is opposite the red mark. Click stops are provided to prevent accidental movement from setting made. The lens opening determines the amount of light entering the lens and striking and exposing the film...your camera has 8 settings ranging from f: 1.4 to f: 16 (or from f: 1.7 to f: 16). The smaller the f-stop number (f: 1.4, f:1.7 etc.) the wider the lens opening and the greater the amount of light entering the lens. (Fig. 9)



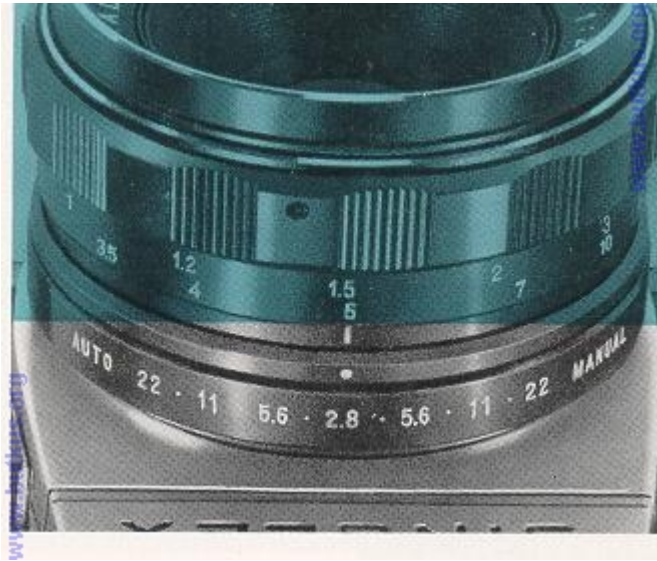

The larger the f-stop number (f:16, f :11 etc.) the smaller the amount of light entering the lens. As the lens opening is moved from f: 16 to f: 11 the amount of light entering is doubled; as the lens opening is moved from f: 2.0 to f: 2.8 the amount of entering light is cut in half.

The f:/2.8 55mm lens is now available with TLS 401 camera.

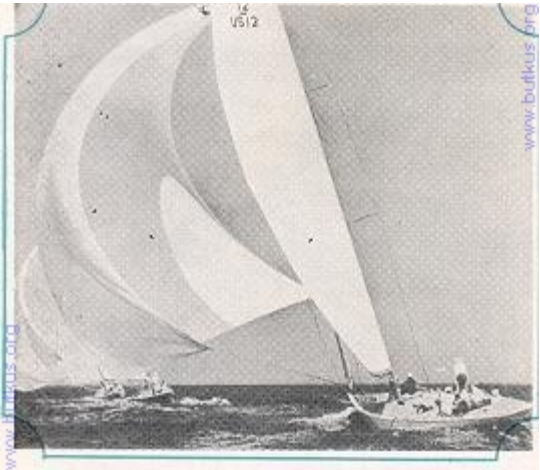

Except for lens, the specifications and operation remain unchanged. As per Fig. 10, you will find f-stop numbers on the f-stop ring on two sides, "AUTO" and "MANUAL". The "AUTO" is for automatic diaphragm control, while the "MANUAL". is for pre-setting diaphragm control. The latter device is necessary when you take special effect photograph using a Bellowscope or an Extension Ring, where automatic diaphragm control is not available.---

Three f-stop numbers are substituted by dots, which are (those bold)

**2.8 4.0 5.6 8.0** 11 16 22

## SETTING THE SHUTTER

Simply turn the Shutter Speed Dial H until the desired shutter speed number is set opposite the black indicator line. Be certain the Dial is set at a click stop. (Fig. 11

The shutter speed setting governs the amount of time the film is exposed to light. "60" (1/60-second) is recommended for subjects not in motion. Where motion exists, shutter speeds ranging from 1/125 to 1/1000 should be used...1, 1000 second speed will "freeze" fast action best for sharpest pictures of fast action -- keep camera at a 45° angle to subject.

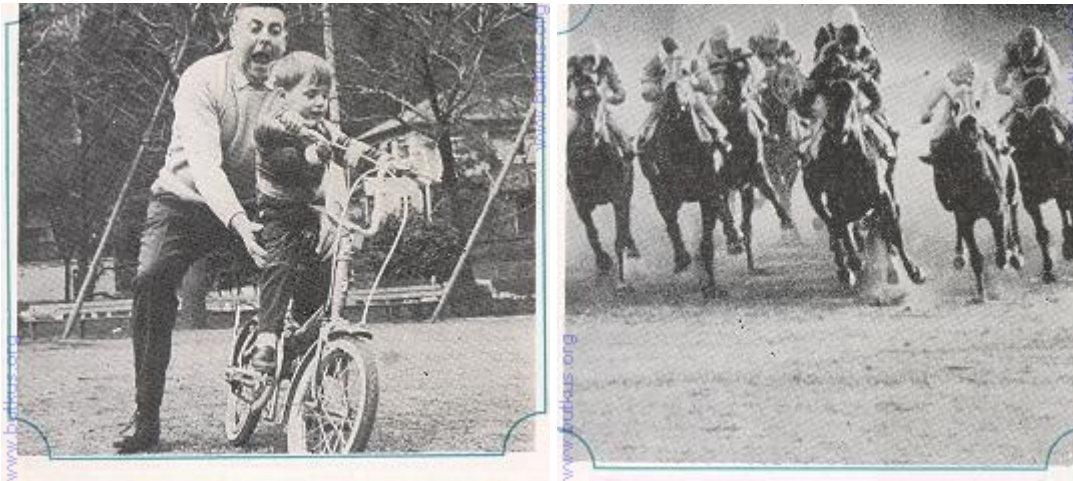

To achieve maximum depth of field (area of sharpness in front of and behind subject), or when shooting in poorly lit areas, speeds ranging from 1/30 to 1 second and "B" (bulb) are available. When using these slower speeds, use a tripod or other firm support to prevent movement of camera and blurred pictures. When set at "B" the shutter will remain open as long as the Shutter Release Button (C) is depressed. The "B" setting is used for long night exposures using street lights or electric signs as a light source, or under poor light conditions when flash cannot be used.

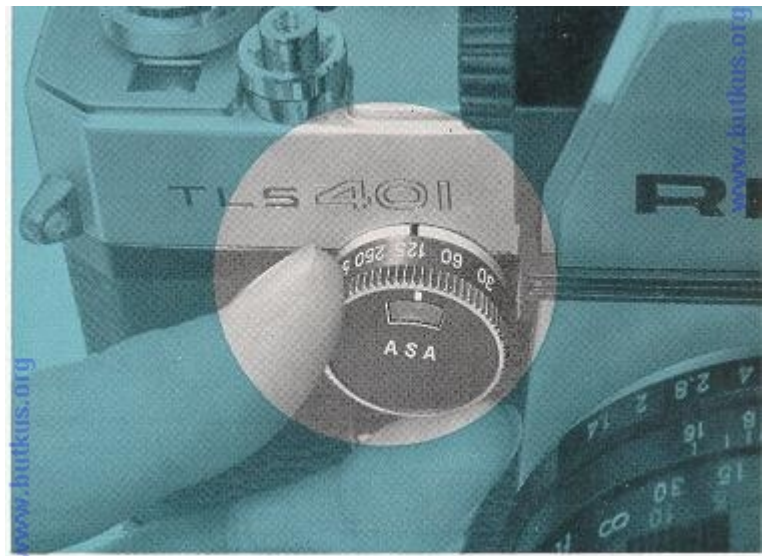

## AVERAGE AND SPOT LIGHT MEASURING

The Ricoh TLS 401 has an unique and exciting dual light measuring system. For general picture-taking set the Average:Spot Switch (T) at "Av" (Average) (Fig. 12) so that the built-in exposure meter measures the intensity of light on the entire scene. When you wish to take a specific subject in a vast scene or the back-lighted subject, set Average /Spot Switch (T) at "Sp" (Spot). Then, the measuring area of the exposure meter is narrowed down distinctly so as to measure the only central part of the finder. The most effective results could be achieved with a small lens opening in case of Spotlight measuring. "Av" (Average) or "Sp" (Spot) light measuring is also indicated in the viewfinder by a green needle. (Fig. 13).



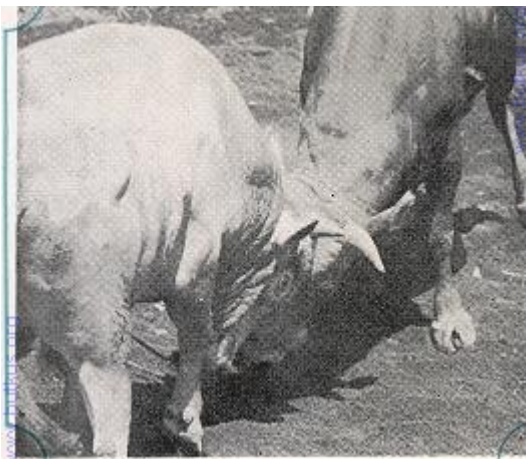
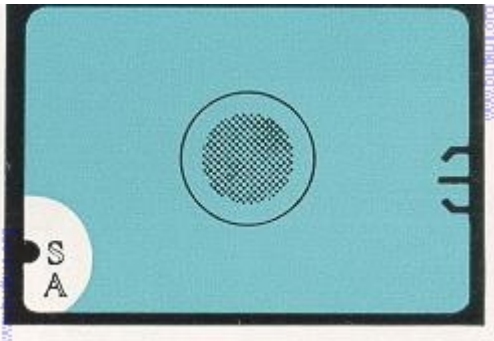
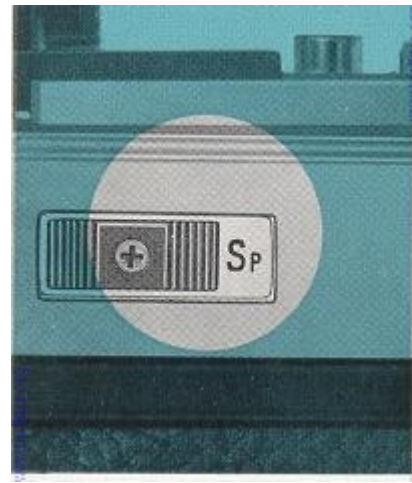
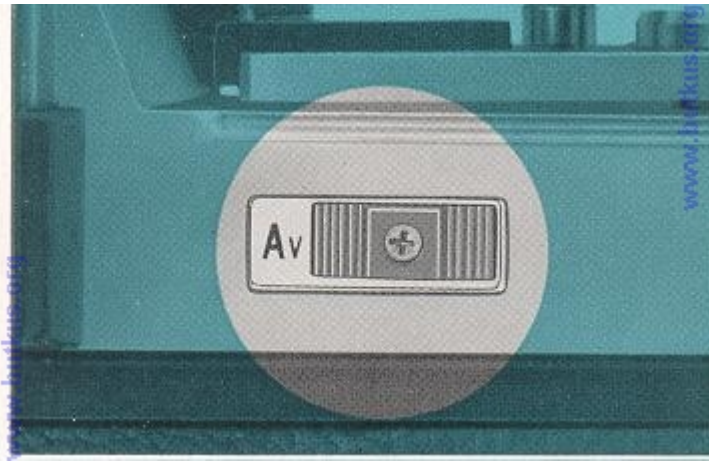

**Caution:** When using Spot-light measuring system, make sure that you measure the intensity of light within the round matt phase in the center of the viewfinder. (Fig. 14)

Combined with the Eye-level or Waist-level viewing system, you will be able to enjoy four ways of viewing and measuring, for example, Eye-level/Averaging light measuring, Eye-level/Spot light measuring, Waist-level Averaging light measuring and Waist-level/Spot light measuring.

## VIEWING AND FOCUSING

Look into Viewfinder Eyepiece (either EL or WL) to compose your picture and focus the lens. Rotate Focusing Ring (L) until subject becomes clear in the micro-split image (Fig. 15)

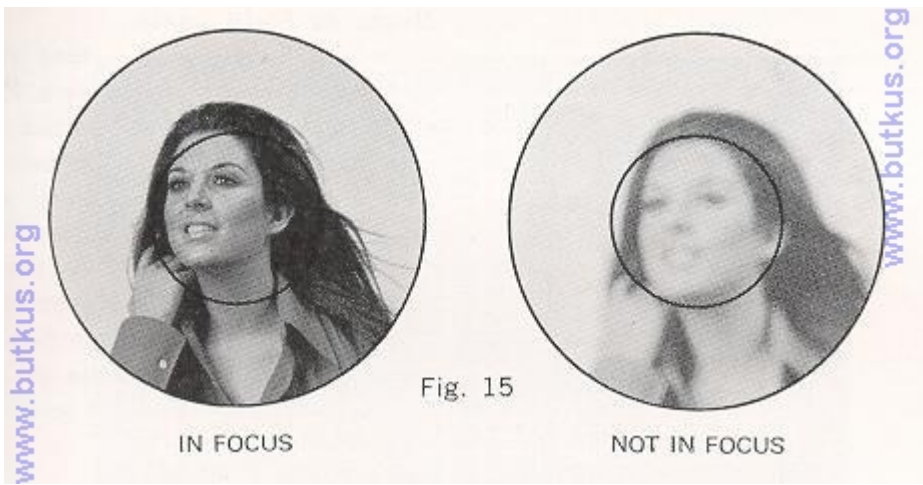

When your subject appears sharpest in the micro-split image, your picture is focused. To take the picture, hold the camera as steady as you can and press Shutter Release Button (C) slowly and smoothly (Fig. 16). Since you are viewing through the lens there is no parallax problem...what you are viewing in the viewfinder will appear in your picture. Even when you shoot close-ups is no danger of accidental cropping...

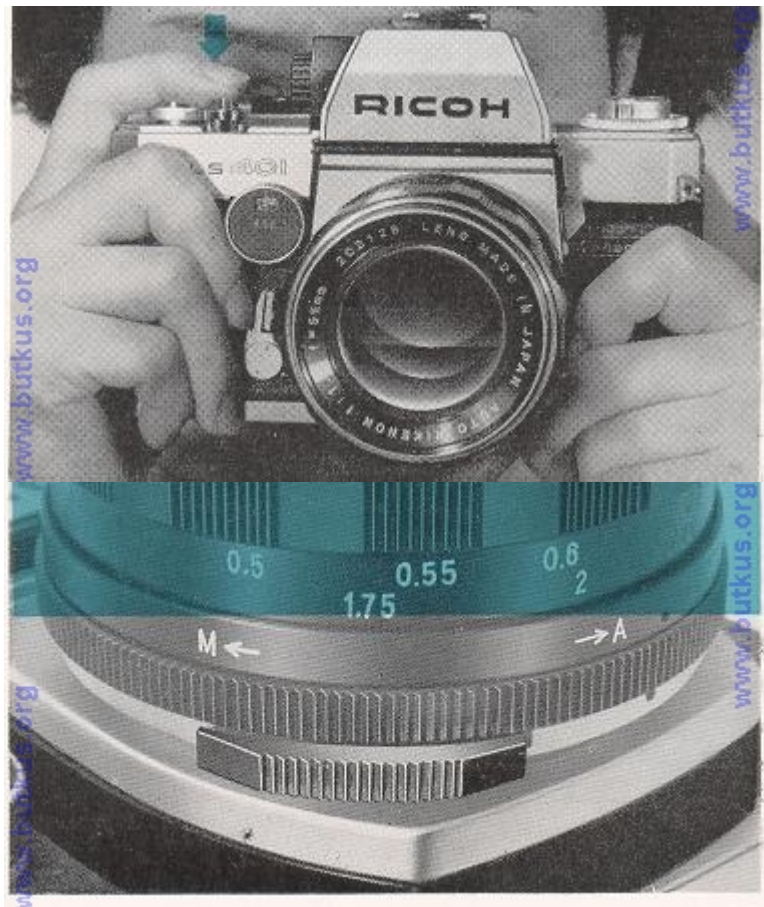



## DEPTH OF FIELD

A portion of the picture in front of and behind your subject will also be sharp. If you wish to know how much of an area will be sharp in your final picture, this can be predetermined in two ways:

### Depth of Field Previewer



Setting the Preview Switch (Z) at "M" Manual) ( Fig. 17) will set the lens at the corresponding opening you previously set on the F-Stop Ring. This will enable you to preview the area of sharpness in the picture before you take it. The preview Switch (Z) may be moved back to A (Automatic position before you press Shutter Release Button (C)... The lens will be reopened and remain open until you take your picture.

### Depth of Field Scale

After you have set the lens opening and have focused the camera, the area of sharpness in front of and behind your subject can also be determined on the Depth of Field Scale (M). Locate, on the depth of Field Scale, the two f-numbers corresponding to the f-stop you have set on the F-Stop Ring (J). The distance between these two f-numbers on the Distance Scale (K) will be the area of sharpness in your picture (Fig. 18).

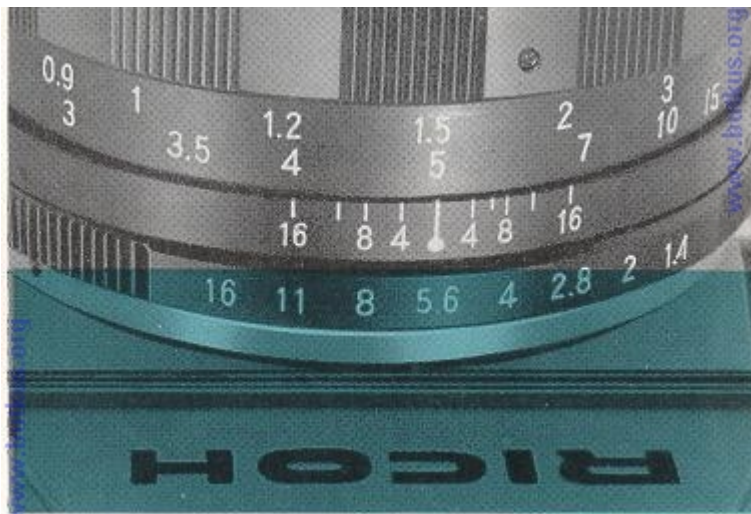

## THE SELF-TIMER



Merely move the self-timer Lever (I) away from the lens (Fig. 19) and press the Shutter Release Button. There will be an 8 second delay before the Self timer will automatically release the shutter and make the exposure for you. Camera should be placed on a tripod or other sturdy support.

## CHANGING THE LENS

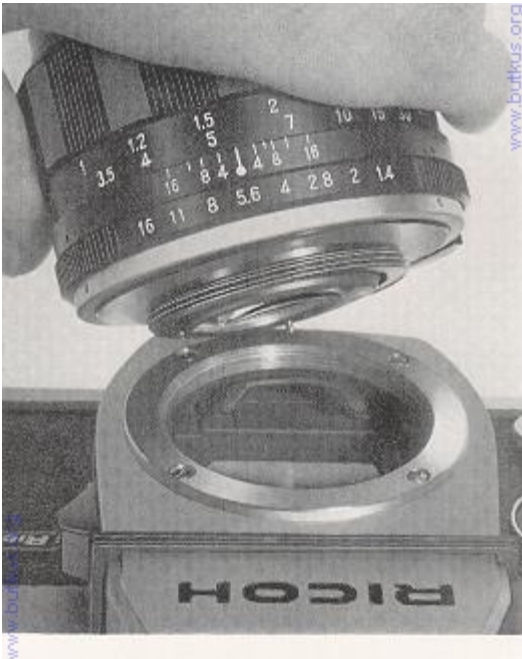

Your camera is equipped with an interchangeable standard lens which is the proper focal length for general-purpose picture taking. You may also use wide-angle lenses for wide angle pictures and telephoto lenses for telescopic picture. To remove the lens continuously turn the lens in a counterclockwise direction until it can be removed. (Fig. 20)

To insert regular lens or wide angle or telephoto lens, turn lens in a clockwise-direction until lens is secured in position.

## FLASH PICTURES

Your camera has synchronization designed to permit flash pictures with most types of flash bulbs and also electronic flash. The flash connecting cord from your flash gun or electronic flash is connected to one of the Flash Sockets (U).



### **Connect flash cord to Flash Socket**

"M" ...when using Flash Bulb No 5, 5B, 25, 25B, M5, M5B, M2, M2B, AG1, **AG1B, 6, 6B, 8.**

### **Connect flash cord to Flash Socket**

"X" ...when using an electronic flash or No. SM flash bulbs.

**Shutter speed from 130 to 1125 sec.** may be used with No. 5, 5B, M5, M5B flash bulbs.

**Shutter speed from 1/30 to 1 125 sec.** may be used with electronic flash, No, 6, 6B, 8 flash bulbs.

**Shutter speed from 1 30 to 160 sec.** may be used with No. M2, M2B, AG1, AG1B, SM flash bulbs.

## **UNLOADING FILM**

**Always unload your camera in the shade, never in bright light.**

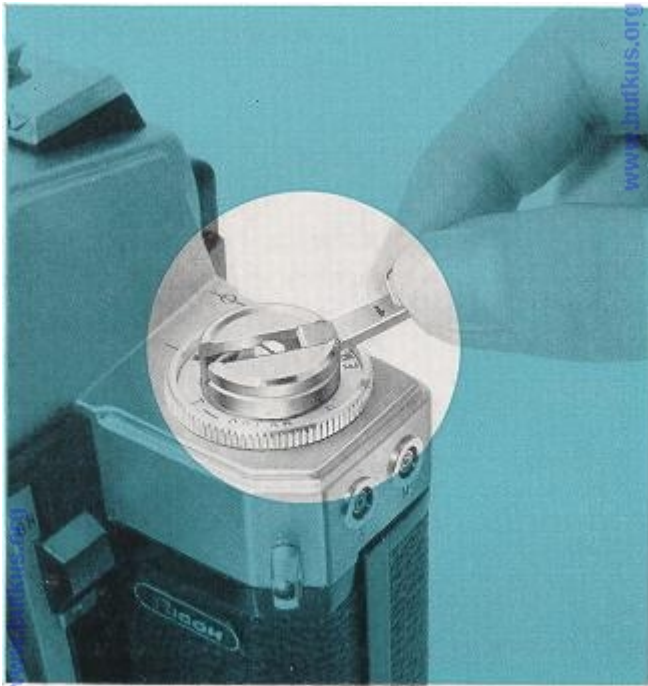

\*After the last picture on the roll has been taken, press Rewind Button (AA). Lift up crank on Film Rewind Knob (P).

(Fig. 21) Be sure not to pull out Film Rewind Knob (P). Turn crank in a clockwise direction until the entire roll has been rewound --tension on the crank will decrease noticeably.

\*Open the camera back by pulling up the Film Rewind Knob and remove the film cartridge.

\*Have film processed as soon as possible.

## TIPS FOR BETTER PICTURES



\* **Read the instruction booklet carefully.**

\* Before you go on a trip or photograph a special event, shoot a practice roll of film.

\* Keep fingers and neckstrap clear of the camera lens....

\* When you reach the end of the roll of film (check Exposure Counter), the film Wind Lever becomes harder to advance dont try to "just one more shot"; its time to rewind and re-load.

\* Protect your camera from dust, dirt, and rough handling Do not expose camera or film to excessively high temperatures.

\* In order to keep WL finder free from dust, usage of a cover, when not in use, is recommendable. (Fig. 22)



## ACCESSORIES FOR YOUR RICOH TLS 401 CAMERA

**Telephoto Lens.** Brings distant subjects closer. The following telephoto lenses are available for the Ricoh TLS 401.

Automatic diaphragm---135mm f 2.8

Preset diaphragm --200mm f4.5

300mm f 5.5

400 mm f 6.3

600mm f 8.0

Zoom 90--190mm f 5.8



**Wide Angle Lens.** Permits sweeping scenic shots outdoors, photos of large groups indoors.

Automatic diaphragm--35mm f 2.8

**Bellows Attachment.** Has focusing knob for maximum sharpness at extremely close distances.. .shoot many objects actual size and even larger, excellent for copying of photographs too.

**Extension Ring Set.** Photograph objects at extremely close distances. Rings can be used separately or in combination depending upon distance from object you desire to photograph.

**Microscope Attachment.** Allows camera to be attached to microscope for photographing objects utilizing microscope magnification.

**Lens Hood.** Ricoh slip-on lens hood prevents unnecessary light from reaching the lens, eliminates diffused reflection and limits incoming light only to that which is really needed.

**Filters.** Ricoh screw-in type Y2, UV and 85A filters are provided. These filters control the quantity and quality of the light that reaches the film through the lens.