

Rider's Manual

R 1200 GS



BMW Motorrad



The Ultimate Riding
Machine

Motorcycle data/dealership details

Motorcycle data

Model

Vehicle identification number

Colour code

Date of first registration

Registration number

Dealership details

Person to contact in Service department

Ms/Mr

Phone number

Dealership address/phone number (company stamp)

Details described or illustrated in this booklet may differ from the motorcycle's actual specification as purchased, the accessories fitted or the national-market specification. No claims will be entertained as a result of such discrepancies.

Dimensions, weights, fuel consumption and performance data are quoted to the customary tolerances.

The right to modify designs, equipment and accessories is reserved.

Errors and omissions excepted.

© 2008 BMW Motorrad

Not to be reproduced either wholly or in part without written permission from BMW Motorrad, After Sales.

Printed in Germany.

The most important data for a filling-station stop can be found in the following chart:

Fuel

Recommended fuel grade	95 ROZ/RON, Super unleaded 91 ROZ/RON, Regular unleaded (fuel grade, usable with power- and consumption-related restric- tions)
------------------------	---

Usable fuel capacity	approx. 20 l
----------------------	--------------

Reserve fuel	≥4 l
--------------	------

Tyre pressures

Tyre pressure, front	2.2 bar, one-up, tyre cold 2.5 bar, two-up and/or with lug- gage, tyre cold
----------------------	---

Tyre pressure, rear	2.5 bar, one-up, tyre cold 2.9 bar, two-up and/or with lug- gage, tyre cold
---------------------	---

BMW recommends 

Order No. 01 41 7 712 421
02.2008, 2nd edition



Welcome to BMW

We congratulate you on your choice of a motorcycle from BMW and welcome you to the community of BMW riders.

Familiarise yourself with your new motorcycle so that you can ride it safely and confidently in all traffic situations.

Please read this Rider's Manual carefully before starting to use your new BMW motorcycle. It contains important information on how to operate the controls and how to make the best possible use of all your BMW's technical features.

In addition, it contains information on maintenance and care to help you maintain your motorcycle's reliability and safety, as well as its value.

If you have questions concerning your motorcycle, your authorised

BMW Motorrad dealer will gladly provide advice and assistance.

We hope that you will enjoy riding your BMW and that all your journeys will be pleasant and safe.

BMW Motorrad.

Table of Contents

You can also consult the index at the end of this Rider's Manual if you want to find a particular topic or item of information.

1 General instructions 5

Overview	6
Abbreviations and symbols	6
Equipment	7
Technical data	7
Currency	7

2 General views 9

General view, left side	11
General view, right side	13
Underneath the seat	14
Handlebar fitting, left	15
Handlebar fitting, right	16
Instrument cluster	17
Headlight	18

3 Status indicators 19

Standard status indicators	20
Status indicators with on-board computer ^{OE}	21
Status indicators with tyre pressure monitoring (RDC) ^{OE}	22
Standard warnings	22
Warnings issued by the on-board computer ^{OE}	26
ABS warnings ^{OE}	29
ASC warnings ^{OE}	31
RDC warnings ^{OE}	34
Anti-theft alarm warnings ^{OE}	39

4 Operation 43

Ignition switch and steering lock	44
Electronic immobiliser (EWS)	45
Clock	46
Odometer and tripmeters	47
On-board computer ^{OE}	49

Tyre pressure monitoring RDC ^{OE}	52
Lights	53
Turn indicators	54
Hazard warning flashers	55
Emergency off switch (kill switch)	56
BMW Motorrad Integral ABS ^{OE}	56
Automatic Stability Control ASC ^{OE}	58
Seat height	59
Windscreen	60
Clutch	60
Brakes	61
Mirrors	61
Handlebars	62
Spring preload	63
Damping	64
Electronic Suspension Adjustment ESA ^{OE}	66
Tyres	68
Headlight	69
Front and rear seats	69

Helmet holder	71	7 Accessories	95	9 Care	139
5 Riding	73	General instructions	96	Care products	140
Safety instructions	74	Power socket	96	Washing motorcycle.....	140
Checklist	75	Auxiliary headlights ^{OA}	97	Cleaning easily damaged	
Starting.....	76	Luggage	97	components	140
Lowered suspension ^{OE}	78	Case ^{OA}	98	Paint care	142
Running in	79	Topcase ^{OA}	101	Protective wax coating	142
Riding off-road	80	Luggage carrier	104	Laying up motorcycle	142
Brakes	81	8 Maintenance	107	Restoring motorcycle to	
Parking your motorcycle	82	General instructions	108	use.....	142
Refuelling	84	Toolkit.....	108	10 Technical data	145
Securing motorcycle for		Engine oil	109	Troubleshooting chart.....	146
transportation	85	Brake system	111	Threaded fasteners	147
6 Engineering details.....	87	Brake pads.....	111	Engine	149
Brake system with BMW Mo-		Brake fluid.....	114	Fuel	150
torrad Integral ABS ^{OE}	88	Clutch	116	Engine oil	150
Electronic engine manage-		Tyres.....	117	Clutch	151
ment with BMW Motorrad		Rims	117	Transmission	152
ASC ^{OE}	90	Wheels	118	Rear-wheel drive	152
Tyre pressure monitoring		Front-wheel stand.....	124	Running gear.....	153
RDC ^{OE}	92	Bulbs	125	Brakes	155
Electronic Suspension Ad-		Air filter.....	132	Wheels and tyres.....	155
justment ESA ^{OE}	93	Jump starting	134	Electrics	156
		Battery	135	Frame	158
				Dimensions	158

Weights	159
Riding specifications	159
11 Service	161
BMW Motorrad service.....	162
BMW Motorrad service quality	162
BMW Motorrad Service Card: on-the-spot break- down assistance	162
BMW Motorrad service net- work.....	163
Maintenance work.....	163
Confirmation of mainten- ance work	164
Confirmation of service.....	169

General instructions

Overview	6
Abbreviations and symbols	6
Equipment	7
Technical data	7
Currency.....	7

Overview

Chapter 2 of this Rider's Manual will provide you with an initial overview of your motorcycle. All maintenance and repair work on the motorcycle is documented in Chapter 11. This record of the maintenance work you have had performed on your motorcycle is a precondition for generous treatment of goodwill claims.

When the time comes to sell your BMW, please remember to hand over this Rider's Manual; it is an important part of the motorcycle.

Abbreviations and symbols



Indicates warnings that you must comply with for reasons of your safety and the safety of others, and to protect your motorcycle against damage.



Specific instructions on how to operate, control, adjust or look after items of equipment on the motorcycle.



Indicates the end of an item of information.



Instruction.



Result of an activity.



Reference to a page with more detailed information.



Indicates the end of a passage relating to specific accessories or items of equipment.



Tightening torque.



Item of technical data.

OE

Optional extra
The motorcycles are assembled complete with all the BMW optional extras originally ordered.

OA

Optional accessory
You can obtain optional accessories through your authorised BMW Motorrad dealer; optional accessories have to be retrofitted to the motorcycle.

EWS

Electronic immobiliser (Elektronische Wegfahrsicherung).

DWA

Anti-theft alarm (Diebstahlwarnanlage)

ABS

Anti-lock brake system

ASC

Automatic Stability Control.

- ESA Electronic Suspension Adjustment
Electronic Suspension Adjustment.
- RDC Tyre pressure control
(ReifenDruck-Control)

Equipment

When you ordered your BMW motorcycle, you chose various items of custom equipment. This Rider's Manual describes optional extras (OE) offered by BMW and selected optional accessories (OA). This explains why the manual may also contain descriptions of equipment which you have not ordered. Please note, too, that your motorcycle might not be exactly as illustrated in this manual on account of country-specific differences. If your BMW was supplied with equipment not described in this Rider's Manual, you will

find these features described in separate manuals.

Technical data

All dimensions, weights and power ratings stated in the Rider's Manual are quoted to the standards and comply with the tolerance requirements of the Deutsche Institut für Normung e.V. (DIN). Versions for individual countries may differ.

Currency

The high safety and quality standards of BMW motorcycles are maintained by constant development work on designs, equipment and accessories. Because of this, your motorcycle may differ from the information supplied in the Rider's Manual. Nor can BMW Motorrad entirely rule out errors and omissions. We hope you will appreciate that no claims can be entertained on

the basis of the data, illustrations or descriptions in this manual.

General views

General view, left side.....	11
General view, right side	13
Underneath the seat	14
Handlebar fitting, left	15
Handlebar fitting, right	16
Instrument cluster	17
Headlight	18

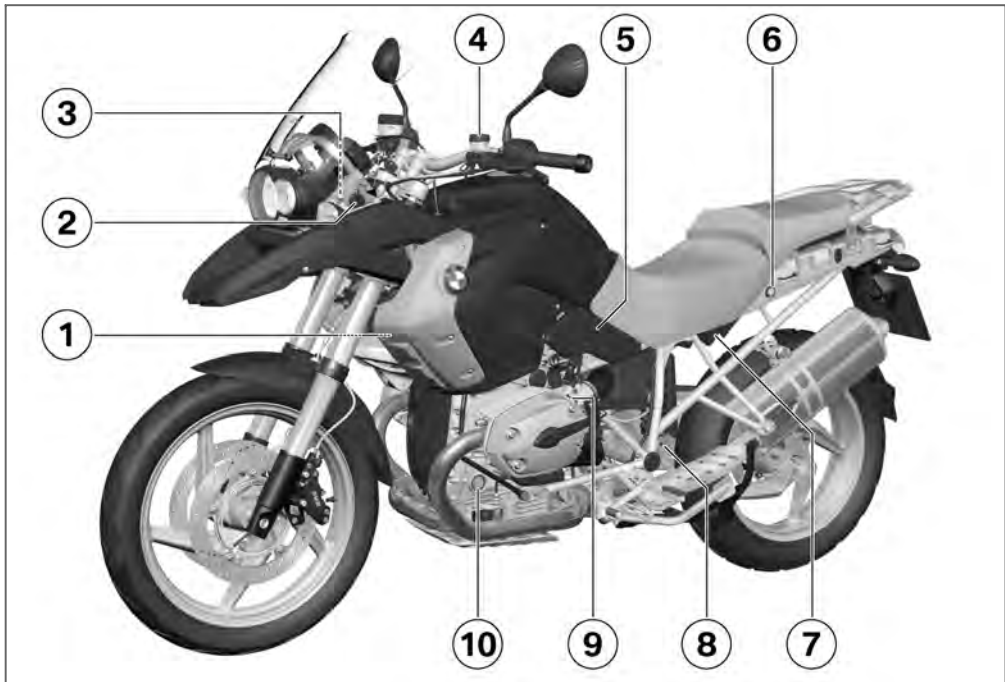

General view, left side

- 1 Adjuster, spring preload, front (➡ 63)
- 2 Adjustment of windscreen (➡ 60)
- 3 Adjuster for headlight beam throw (underneath the instrument panel) (➡ 69)
- 4 Clutch-fluid reservoir (➡ 116)
- 5 Type plate (on frame, behind side cover)
- 6 Seat lock (➡ 69)
- 7 Power socket (➡ 96)
- 8 Adjuster for damping characteristic, rear suspension (➡ 64)
- 9 Engine-oil filler neck (➡ 110)
- 10 Engine oil level indicator (➡ 109)

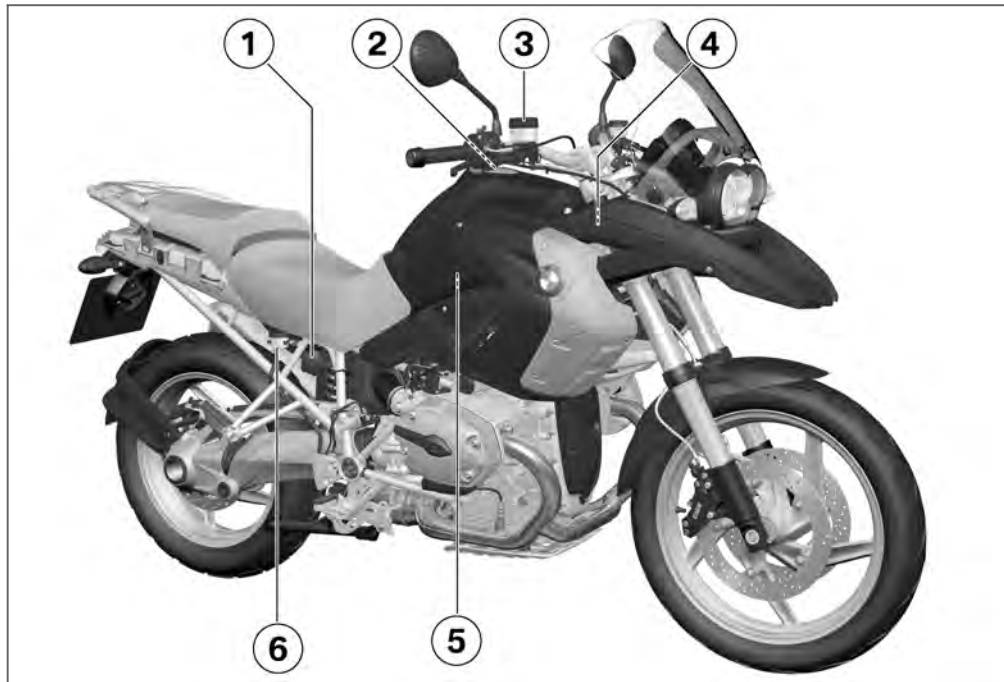

General view, right side

- 1 Adjuster for spring preload, rear (➡ 63)
- 2 Fuel filler neck (➡ 84)
- 3 Brake-fluid reservoir, front (➡ 114)
- 4 Vehicle Identification Number (VIN) (on steering-head bearing)
- 5 Air filter (behind right side panel) (➡ 132)
- 6 Brake-fluid reservoir, rear (➡ 115)

Underneath the seat

- 1 Rider's Manual
- 2 Battery (➔ 135)
- 3 Toolkit, Payload table (in tool tray), Tyre pressures table (in tool tray)
- 4 Helmet holder (➔ 71)

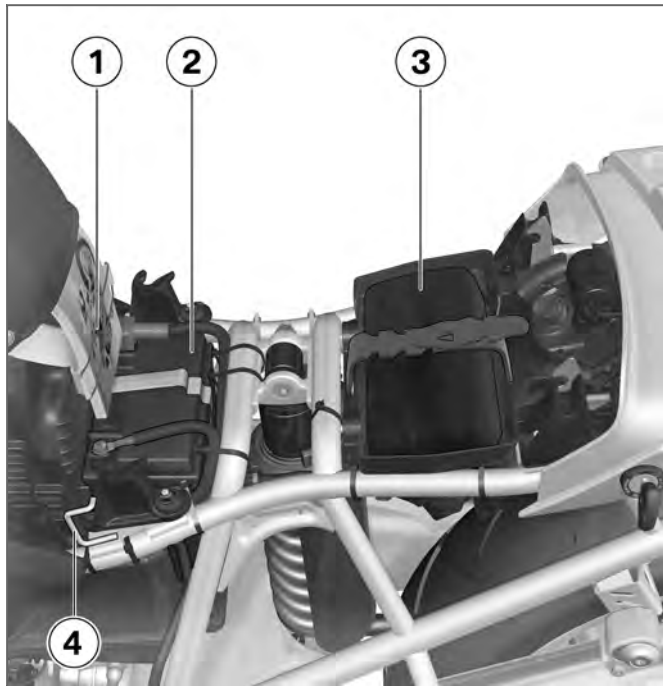



Handlebar fitting, left

- 1 Operating the odometer (➡ 47), Operating the on-board computer^{OE} (➡ 49)
- 2 Operating the ABS^{OE} (➡ 56), Operating ASC^{OE} (➡ 58)
- 3 Operating ESA^{OE} (➡ 66)
- 4 Horn
- 5 Flashing turn indicators, left (➡ 54), Hazard warning flashers (➡ 55)
- 6 Headlight flasher and high-beam headlight (➡ 53)

Handlebar fitting, right

- 1 Emergency off switch (kill switch) (➡ 56)
- 2 Starter button (➡ 76)
- 3 Grip heating
- 4 Flashing turn indicators, right (➡ 55), Hazard warning flashers (➡ 55)
- 5 Cancel button, flashing turn indicators (➡ 55), Pushbutton, cancel hazard warning flashers (➡ 56)

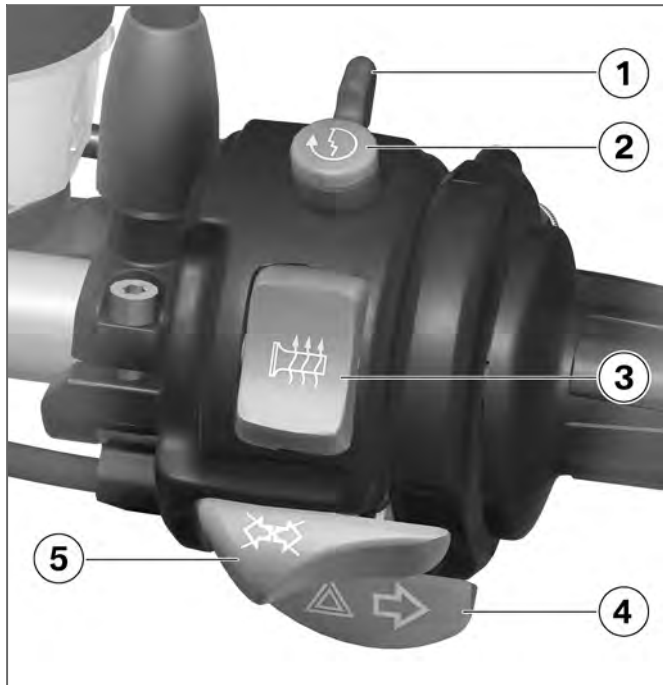

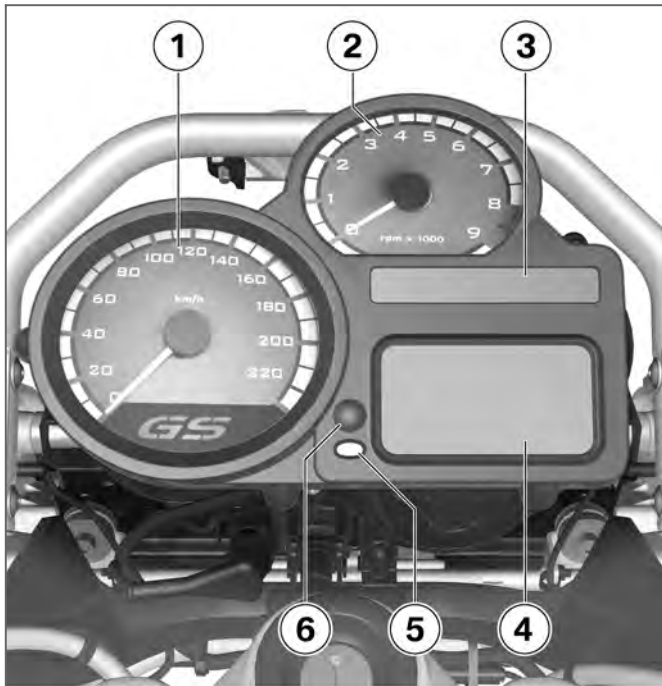

Instrument cluster

- 1 Speedometer
- 2 Rev. counter
- 3 Telltale lights (➡ 20)
- 4 Multifunction display (➡ 20)
- 5 Ambient-light brightness sensor (for adapting the brightness of the instrument lighting)
 - with anti-theft alarm (DWA)^{OE}
 - Anti-theft alarm telltale light (see the instructions for use for the anti-theft alarm)
- 6 Operating the odometer (➡ 47), Operation of the clock (➡ 46)

Headlight

- 1 Low-beam headlight
- 2 High-beam headlight
- 3 Side light

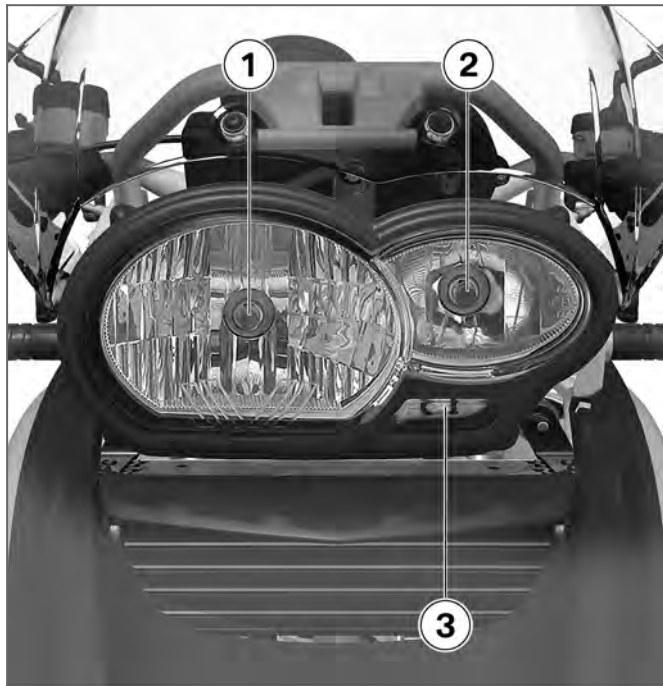

Status indicators

Standard status indicators	20
Status indicators with on-board computer ^{OE}	21
Status indicators with tyre pressure monitoring (RDC) ^{OE}	22
Standard warnings	22
Warnings issued by the on-board computer ^{OE}	26
ABS warnings ^{OE}	29
ASC warnings ^{OE}	31
RDC warnings ^{OE}	34
Anti-theft alarm warnings ^{OE}	39

Standard status indicators

Multifunction display

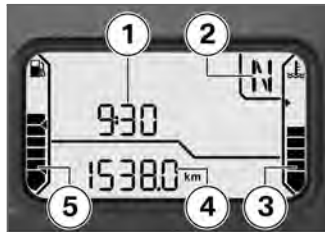

- 1 Clock (🕒 46)
- 2 Gear indicator (⚙️ 20)
- 3 Engine temperature (🌡️ 20)
- 4 Odometer and tripmeters (📏 47)
- 5 Fuel capacity (⛽ 20)

Telltale lights



- 1 Flashing turn indicators, left
- 2 High-beam headlight
- 3 Idle
- 4 Flashing turn indicators, right

Fuel capacity



The horizontal bars below the fuel-pump symbol indicate the remaining quantity of fuel.

When the fuel in the tank is topped up the gauge briefly shows the original level, before the reading is updated.

Gear indicator



The gear engaged or N for neutral appears on the display.



If no gear is engaged, the 'neutral' telltale light also lights up.

Engine temperature



The horizontal bars below the temperature symbol indicate the engine temperature.

Service-due indicator



If the next service is due in less than one month, the date for the

next service is shown briefly after the Pre-Ride Check completes. Month and year are both shown as two-digit numbers with a line as separator, so in this example the next service is due in March 2007.



If the motorcycle covers long distances in the course of the year, under certain circumstances it might be necessary to have it serviced at a date in advance of the forecast due date. If the countdown distance to the odometer reading at which a service will be due is less than 1000 km,

the distance is counted down in steps of 100 km and is shown briefly after the Pre-Ride Check completes.

If service is overdue, the due date or the odometer reading at which service was due is accompanied by the 'General' warning light showing yellow. The word "Service" remains permanently visible.

▶ If the service-due indicator appears more than a month in advance of the actual due date or if the word "Service" does not show permanently even though a service is overdue, the date stored in memory in the instrument panel is incorrect and must be set. This situation can occur if the battery was disconnected for a prolonged period of time.

If you want to have the date set consult a specialist workshop,

preferably an authorised BMW Motorrad dealer. ◀

Status indicators with on-board computer^{OE}



- 1 Status-indicator panel of the on-board computer^{OE} (►► 49)

Status indicators with tyre pressure monitoring (RDC)^{OE}



- 1** Tyre-pressure readout^{OE}
(→ 52)

▶ The figures shown in the tyre-pressure readings are temperature-compensated (see the section entitled "Engineering details").◀

Standard warnings Mode of presentation



Warnings are indicated by the 'General' warning light **1** showing in combination with a warning word, for example **2** or in combination with one of the warning symbols **3**. The 'General' warning light shows red or yellow, depending on the urgency of the warning.

If two or more warnings occur at the same time, all the appropriate warning lights and warning symbols appear, alternating with warning words as applicable.











The possible warnings are listed on the next page.

Warnings, overview

Telltale lights

Status indicators

Meaning

	Lights up yellow	EWS ! appears on the display	Electronic immobiliser active (➡ 24)
	Lights up yellow	FUEL ! appears on the display	Fuel down to reserve (➡ 24)
	Lights up yellow	 Appears on the display	Engine in emergency-operation mode (➡ 24)
	Flashes red	 Appears on the display	Insufficient engine oil pressure (➡ 25)
	Lights up red	 Appears on the display	Insufficient battery charge current (➡ 25)
	Lights up yellow	LAMP R ! appears on the display	Rear light bulb defective (➡ 25)
		LAMP F ! appears on the display	Front light bulb defective (➡ 26)
	Lights up yellow	LAMP S ! appears on the display	Bulbs defective (➡ 26)

Electronic immobiliser active

 General warning light shows yellow.

EWS ! appears on the display.
Possible cause:

The key being used is not authorised for starting, or communication between key and engine electronics is disrupted.

- Remove all other vehicle keys from the same ring as the ignition key.
- Use the reserve key.
- Have the defective key replaced, preferably by an authorised BMW Motorrad dealer.

Fuel down to reserve

 General warning light shows yellow.

FUEL ! appears on the display.

 Lack of fuel can result in the engine misfiring and cutting out unexpectedly. Misfiring can damage the catalytic converter; a hazardous situation can result if the engine cuts out unexpectedly.

Do not run the fuel tank dry.◀

Possible cause:

The fuel tank contains no more than the reserve quantity of fuel.

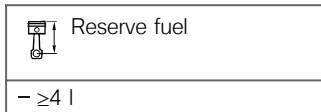

- Refuel (➔ 84)

Engine in emergency-operation mode

 General warning light shows yellow.

 Engine symbol appears on the display.

 The engine is running in emergency operating mode. Engine power might be reduced and this can cause hazardous situations, particularly if you attempt to overtake other road users.

Engine power level might be lower than normal: adapt your style of riding accordingly.◀

Possible cause:

The engine control unit has diagnosed a fault. In exceptional cases, the engine stops and refuses to start. Otherwise, the engine runs in emergency operating mode.

- You can continue to ride, but bear in mind that the usual engine power might not be available.
- Have the fault rectified as quickly as possible by a specialist workshop, preferably

an authorised BMW Motorrad dealer.

Insufficient engine oil pressure



General warning light flashes red.



Oil-can symbol appears on the display.

The oil pressure in the lube-oil system is too low. Stop immediately and switch off the engine.



The insufficient oil pressure warning does not fulfil the function of an oil gauge. The only way of checking whether the oil level is correct is to check the oil sight glass. ◀

Possible cause:

The engine-oil level is too low.

- Check the engine oil level (▢ 109)

If the oil level is too low:

- Top up the engine oil.

Possible cause:

The engine-oil pressure is insufficient.



Riding when engine-oil pressure is low can result in engine damage.

Do not continue your journey. ◀

- Have the fault rectified as quickly as possible by a specialist workshop, preferably an authorised BMW Motorrad dealer.

Insufficient battery charge current



General warning light lights up red.



Battery symbol appears on the display.



A discharged battery can render various systems unavailable, for example the lights,

the engine or the ABS. This can result in dangerous situations. If possible, do not continue your journey. ◀

Battery is not being charged. If you continue to ride the motorcycle the on-board electronics will drain the battery.

Possible cause:

Alternator or alternator drive belt defective

- Have the fault rectified as quickly as possible by a specialist workshop, preferably an authorised BMW Motorrad dealer.

Rear light bulb defective



General warning light shows yellow.

LAMP R ! appears on the display.

 A defective bulb places your safety at risk because it is easier for other users to oversee the motorcycle. Replace defective bulbs as soon as possible; always carry a complete set of spare bulbs if possible. ◀

Possible cause:

Rear light or brake light bulb defective.

- The LED rear light must be replaced. Consult a specialist workshop, preferably an authorised BMW Motorrad dealer.

Front light bulb defective

LAMPF ! appears on the display.

 A defective bulb places your safety at risk because it is easier for other users to oversee the motorcycle. Replace defective bulbs as soon as possible; always carry a

complete set of spare bulbs if possible. ◀

Possible cause:

Low-beam headlight, high-beam headlight, side-light or turn-indicator bulb defective.

- Replacing low-beam/high-beam headlight bulb (➡ 125)
- Replacing parking-light bulb (➡ 127)
- Replacing turn indicator bulbs, front and rear (➡ 128)

Bulbs defective

 General warning light shows yellow.

LAMPS ! appears on the display.

 A defective bulb places your safety at risk because it is easier for other users to oversee the motorcycle. Replace defective bulbs as soon as possible; always carry a

complete set of spare bulbs if possible. ◀

Possible cause:

A combination of the bulb defects described above has occurred.

- See the fault descriptions above.

Warnings issued by the on-board computer^{OE}

Mode of presentation



Warnings issued by the on-board computer appear in panel **1**.

The possible warnings are listed on the next page.

Warnings, overview**Telltale lights****Status indicators****Meaning**

Appears on the display

Engine-oil level too low (→ 29)

Check Oil appears on the display.



Appears on the display

Ice warning (→ 29)

Engine-oil level too low



Oil-level symbol appears on the display.

Check Oil appears on the display.

Possible cause:

The electronic oil-level sensor has registered an excessively low oil level. Check the engine-oil level at the oil-level indicator the next time you stop to refuel:

- Check the engine oil level (➡ 109)

If the oil level is too low:

- Top up the engine oil (➡ 110)

Possible cause:

The oil sensor might be defective if the "Check oil level" message appears even though a check at the oil sight glass reveals that the oil level is correct.

- Seek the advice of a specialist workshop, preferably an authorised BMW Motorrad dealer.

Ice warning



Ice-crystal symbol appears on the display.

Possible cause:

The air temperature measured at the motorcycle is lower than 3 °C.



The ice warning does not mean that there is no risk of black ice forming at measured temperatures above 3 °C.

Always take extra care and think well ahead when temperatures are low; remember that the danger of black ice is particularly high on bridges and where the road is in the shade.◀

- Ride carefully and think well ahead.

ABS warnings^{OE}

Mode of presentation



ABS warnings are indicated by ABS warning light **1**.

The way in which the ABS warning light indicates status can differ in some countries.



Possible national variant.

The detailed descriptions relating to BMW Motorrad Integral ABS start on page (➡ 88), and you will find an overview listing the possible warnings on the next page.

Warnings, overview**Telltale lights****Status indicators****Meaning**

Flashes

Self-diagnosis not completed (→ 31)



Lights up

ABS deactivated (→ 31)



Lights up

ABS fault (→ 31)

Self-diagnosis not completed



ABS warning light flashes.

Possible cause:

The ABS function is not available, because self-diagnosis did not complete. The motorcycle has to move forward a few metres for the wheel sensors to be tested.

- Pull away slowly. Bear in mind that the ABS function is not available until self-diagnosis has completed.

ABS deactivated



ABS warning light shows.

Possible cause:

The rider has switched off the ABS system.

– with BMW Motorrad Integral ABS II^{OE}

- Activate the ABS function (➡ 57)

ABS fault



ABS warning light shows.

Possible cause:

The ABS control unit has detected a fault. The ABS function is not available.

- You can continue to ride the motorcycle, but make due provision for the fact that the ABS function is not available. Bear in mind the more detailed information on situations that can lead to an ABS fault (➡ 89).
- Have the fault rectified as quickly as possible by a specialist workshop, preferably an authorised BMW Motorrad dealer.

ASC warnings^{OE}

Mode of presentation

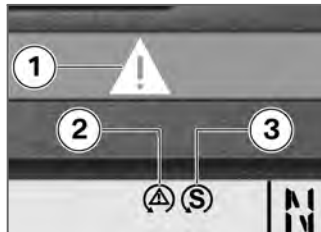

ASC warnings are indicated by ASC symbol **2** or off-road ASC symbol **3** in combination with 'General' warning light **1**.

The detailed descriptions relating to BMW Motorrad ASC start on page (➡ 90), and you will find an overview listing the possible warnings on the next page.

Warnings, overview

Telltale lights

Status indicators

Meaning

	Quick-flashes yellow		Appears on the display	ASC intervention (→ 33)
	Quick-flashes yellow		Appears on the display	Off-road ASC intervention (→ 33)
			Slow-flashes	Self-diagnosis not completed (→ 33)
			Slow-flashes	Self-diagnosis in off-road mode not completed (→ 33)
			Appears on the display	ASC deactivated (→ 33)
	Lights up yellow		Appears on the display	ASC fault (→ 34)

ASC intervention



General warning light quick-flashes yellow.



ASC symbol appears on the display.

The ASC has detected a degree of instability at the rear wheel and has intervened to reduce torque. The warning light flashes for longer than ASC intervention lasts. This affords the rider visual feedback on control intervention even after the critical situation has been dealt with.

Off-road ASC intervention



General warning light quick-flashes yellow.



Off-road ASC symbol appears on the display.

The off-road ASC has detected a degree of instability at the rear wheel and has intervened to reduce torque. The warning light

flashes for longer than ASC intervention lasts. This affords the rider visual feedback on control intervention even after the critical situation has been dealt with.

Self-diagnosis not completed



ASC symbol slow-flashes.

Possible cause:

Self-diagnosis did not complete, so the ASC function is not available. The engine must be running and the motorcycle must reach a speed of at least 5 km/h once in order for ASC self-diagnosis to complete.

- Pull away slowly. Bear in mind that the ASC function is not available until self-diagnosis has completed.

Self-diagnosis in off-road mode not completed



Off-road ASC symbol slow-flashes.

Possible cause:

Self-diagnosis did not complete, so the ASC function is not available. The engine must be running and the motorcycle must reach a speed of at least 5 km/h once in order for ASC self-diagnosis to complete.

- Pull away slowly. Bear in mind that the ASC function is not available until self-diagnosis has completed.

ASC deactivated



ASC symbol appears on the display.

Possible cause:

The rider has switched off the ASC system.

- with Automatic Stability Control^{OE}
- Activate the ASC function (➔ 59)

ASC fault

 General warning light shows yellow.

 ASC symbol appears on the display.

Possible cause:

The ASC control unit has detected a fault. The ASC function and the off-road ASC function are not available.

- You can continue to ride. Bear in mind that the ASC function is not available. Bear in mind the more detailed information on situations that can lead to an ASC fault (➔ 91).
- Have the fault rectified as quickly as possible by a specialist workshop, preferably

an authorised BMW Motorrad dealer.

RDC warnings^{OE}

Mode of presentation

The tyre-pressure readings are based on a reference tyre temperature of 20 °C (➔ 93).

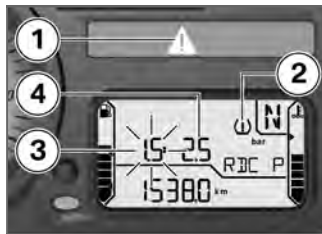

Warning symbol **2** indicates a critical tyre pressure, and the corresponding reading for the front tyre pressure **3** or the rear tyre pressure **4** flashes.

If the critical value is close to the limit of the permissible tolerance

range, 'General' warning light **1** shows yellow. If the tyre pressure registered by the sensor is outside the permissible tolerance range, the 'General' warning light flashes red.

The detailed descriptions relating to BMW Motorrad RDC start on page (➔ 92), and you will find an overview listing the possible warnings on the next page.

Warnings, overview

Telltale lights



Lights up yellow



Flashes red



Lights up yellow

Status indicators



Tyre symbol appears on the display.

The critical tyre pressure flashes.



Tyre symbol appears on the display.

The critical tyre pressure flashes.

"--" or "-- --" appears on the display



Tyre symbol appears on the display.

"--" or "-- --" appears on the display

Meaning

Tyre pressure close to limit of permitted tolerance (➡ 37)

Tyre pressure outside permitted tolerance (➡ 37)

Signal transmission disrupted (➡ 38)

Sensor defective or system error (➡ 38)

Telltale lights**Status indicators****Meaning**

Lights up yellow

RDC ! appears on
the displayBattery of tyre-pressure sensor weak
( 39)

Tyre pressure close to limit of permitted tolerance

 General warning light shows yellow.

 Tyre symbol appears on the display.

The critical tyre pressure flashes.
Possible cause:

Measured tyre pressure is close to the limit of permitted tolerance.

- Correct the tyre pressure as stated on the inside cover of the Rider's Manual.

 Before you adjust tyre pressure, read the information on temperature compensation and adjusting pressure in the section entitled "Engineering details".◀

Tyre pressure outside permitted tolerance

 General warning light flashes red.

 Tyre symbol appears on the display.

The critical tyre pressure flashes.
Possible cause:

Measured tyre pressure is outside permitted tolerance.

- Check the tyre for damage and to ascertain whether the motorcycle can be ridden with the tyre in its present condition.

If the motorcycle can be ridden with the tyre in its present condition:

 Incorrect tyre pressures impair the motorcycle's handling characteristics.

If tyre pressure is incorrect it is essential to adapt your style of riding accordingly.◀

- Correct the tyre pressure at the earliest possible opportunity.

 Before you adjust tyre pressure, read the information on temperature compensation and adjusting pressure in the section entitled "Engineering details".◀

- Have the tyre checked for damage by a specialist workshop, preferably an authorised BMW Motorrad dealer.

If you are unsure whether the motorcycle can be ridden with the tyre in its present condition:

- Do not continue your journey.
- Notify the breakdown service.
- Have the tyre checked for damage by a specialist workshop, preferably an authorised BMW Motorrad dealer.

Signal transmission disrupted

"--" or "-- --" appears on the display.

Possible cause:

The motorcycle has not yet accelerated past the threshold of approximately 30 km/h. The RDC sensors do not start transmitting signals until the motorcycle reaches a speed above this threshold for the first time ( 92).

- Increase speed above this threshold and observe the RDC readings. Assume that a permanent fault has not occurred unless the 'General' warning light comes on to accompany the symptoms. Under these circumstances:
- Have the fault rectified by a specialist workshop, preferably an authorised BMW Motorrad dealer.

Possible cause:

Wireless communication with the RDC sensors has been disrupted.

Possible causes include radio-communication systems operating in the vicinity and interfering with the link between the RDC control unit and the sensors.

- Move to another location and observe the RDC readings. Assume that a permanent fault has not occurred unless the 'General' warning light comes on to accompany the symptoms. Under these circumstances:
- Have the fault rectified by a specialist workshop, preferably an authorised BMW Motorrad dealer.

Sensor defective or system error



General warning light shows yellow.



Tyre symbol appears on the display.

"--" or "-- --" appears on the display.

Possible cause:

Motorcycle is fitted with wheels not equipped with RDC sensors.

- Fit wheels and tyres equipped with RDC sensors.

Possible cause:

One or two RDC sensors have failed.

- Have the fault rectified by a specialist workshop, preferably an authorised BMW Motorrad dealer.

Possible cause:

A system error has occurred.

- Have the fault rectified by a specialist workshop, preferably an authorised BMW Motorrad dealer.

Battery of tyre-pressure sensor weak



General warning light shows yellow.

RDC ! appears on the display.

 This error message appears only briefly after the pre-ride check completes. ◀

Possible cause:

The integral battery in the tyre-pressure sensor has lost a significant proportion of its original capacity. There is no assurance of how long the tyre pressure control system can remain operational.

- Seek the advice of a specialist workshop, preferably an authorised BMW Motorrad dealer.

Anti-theft alarm warnings^{OE}



Mode of presentation



Anti-theft alarm warnings **2** appear in combination with 'General' warning light **1** showing after the Pre-Ride Check and relate to the capacity of the internal battery that supplies power to the anti-theft alarm.

The possible warnings are listed on the next page.

Warnings, overview**Telltale lights****Status indicators****Meaning**

	DWA!O ! appears on the display	Anti-theft alarm battery weak ( 41)
 Lights up yellow	DWA ! appears on the display	Anti-theft alarm battery flat ( 41)

Anti-theft alarm battery weak

DWALO ! appears on the display.

 This error message appears only briefly after the pre-ride check completes. ◀

Possible cause:

The integral battery in the anti-theft alarm has lost a significant proportion of its original capacity. There is no assurance of how long the anti-theft alarm can remain operational if the motorcycle's battery is disconnected.

- Seek the advice of a specialist workshop, preferably an authorised BMW Motorrad dealer.

Anti-theft alarm battery flat



General warning light shows yellow.

DWA ! appears on the display.

 This error message appears only briefly after the pre-ride check completes. ◀

Possible cause:

The integral battery in the anti-theft alarm has lost its entire original capacity. There is no assurance that the anti-theft alarm will be operational if the motorcycle's battery is disconnected.

- Seek the advice of a specialist workshop, preferably an authorised BMW Motorrad dealer.



Operation

Ignition switch and steering lock	44	Windscreen	60
Electronic immobiliser (EWS)	45	Clutch	60
Clock	46	Brakes	61
Odometer and tripmeters	47	Mirrors	61
On-board computer ^{OE}	49	Handlebars	62
Tyre pressure monitoring RDC ^{OE}	52	Spring preload	63
Lights	53	Damping	64
Turn indicators	54	Electronic Suspension Adjustment ESA ^{OE}	66
Hazard warning flashers	55	Tyres	68
Emergency off switch (kill switch)	56	Headlight	69
BMW Motorrad Integral ABS ^{OE}	56	Front and rear seats	69
Automatic Stability Control ASC ^{OE}	58	Helmet holder	71
Seat height	59		

Ignition switch and steering lock

Keys

You receive one master key and one spare key. Please consult the information on the electronic immobiliser (EWS) if a key is lost or mislaid (►► 45).

Ignition switch and steering lock, tank filler cap lock and seat lock are all operated with the same key.

- with case^{OA}
- with topcase^{OA}

If you wish you can arrange to have the cases and the topcase fitted with locks that can be opened with this key as well. Consult a specialist workshop, preferably an authorised BMW Motorrad dealer.◁

Switching on ignition



- Turn the key to position **1**.
 - » Side lights and all function circuits switched on.
 - » Engine can be started.
 - » Pre-ride check is performed. (►► 77)
- with BMW Motorrad Integral ABS II^{OE}
 - » ABS self-diagnosis is performed. (►► 77)
- with Automatic Stability Control^{OE}
 - » ASC self-diagnosis is performed. (►► 78)

Switching off ignition



- Turn the key to position **2**.
 - » Lights switched off.
 - » Handlebars not locked.
 - » Key can be removed.
 - » Electrically powered accessories remain operational for a limited period of time.
 - » The battery can be recharged via the socket.

Locking handlebars



 If the motorcycle is on the side stand, the surface of the ground will determine whether it is better to turn the handlebars to the left or right. However, the motorcycle is more stable on a level surface with the handlebars turned to the left than with the handlebars turned to the right.

On level ground, always turn the handlebars to the left to set the steering lock. ◀

- Turn the handlebars to the full left or right lock position.

- Turn the key to position **3**, while moving the handlebars slightly.
 - » Ignition, lights and all function circuits switched off.
 - » Handlebars locked.
 - » Key can be removed.

Electronic immobiliser (EWS)

Protection against theft

The electronic immobiliser helps protect your BMW motorcycle from theft, and this enhanced security is at your disposal without any need for you to set parameters or activate additional systems. The engine of a motorcycle fitted with this electronic immobiliser can be started only with the keys that belong to the vehicle. You can also have your authorised BMW Motorrad dealer bar individual keys, for example if a particular key goes missing. The

engine cannot be started with a key that has been barred.

In-key electronics

The motorcycle's electronics exchange certain continuously changing signals with the electronics in the key; these signals are specific to your motorcycle and they are transmitted via the ring aerial in the ignition lock. The ignition is not enabled for starting until the key has been recognised as "authorised" for your motorcycle.

 A spare key attached to the same ring as the ignition key used to start the engine could "irritate" the electronics, in which case the enabling signal for starting is not issued. The EWS warning appears in the multifunction display. Always keep the spare key separately from the ignition key. ◀

Replacement and extra keys

You can obtain replacement/extra keys only through an authorised BMW Motorrad dealer. The keys are part of an integrated security system, so the dealer is under an obligation to check the legitimacy of all applications for replacement/extra keys. If you want to have a lost key barred, you have to bring with you all the other keys that belong to the motorcycle. A key that has been barred can subsequently be cleared and reactivated for use.

Clock

Setting clock

 Attempting to set the clock while riding the motorcycle can lead to accidents. Set the clock only when the motorcycle is stationary. ◀

- Switch on the ignition.
 - without on-board computer^{OE}
 - without tyre pressure monitoring (RDC)^{OE}



- Repeatedly press button **1** until the odometer reading appears on the display.



- Alternatively, repeatedly press button **2** until the total distance covered reading appears on the display. ◀

- with on-board computer^{OE} or
- with tyre pressure monitoring (RDC)^{OE}



- Repeatedly press button **2** until the clock appears on the display.

▶ In this case, the button in the instrument cluster operates only the tripmeters. ◀◀

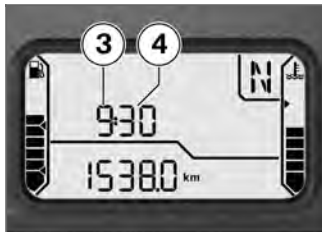

- Hold down the button.
 - » Hours reading **3** flashes.
- Press the button.
 - » The hours reading increments by one each time you press the button.
- Hold down the button.
 - » Minutes reading **4** flashes.
- Press the button.
 - » The minutes reading increments by one each time you press the button.
- Either press and hold down the button or wait without pressing a button.

» The clock is now set and the time appears on the display.

Odometer and tripmeters

Selecting readings

- Switch on the ignition.

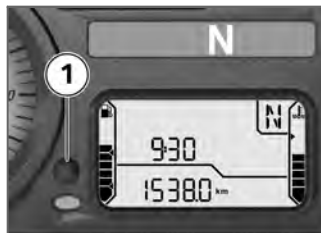

- Press button **1**.



The display starts with the current value and each time the button is pressed it moves one step through the following sequence:

- Total distance covered
- Tripmeter 1 (Trip I)
- Tripmeter 2 (Trip II)
- Residual range (once fuel level is down to reserve)

- without on-board computer^{OE}
- without tyre pressure monitoring (RDC)^{OE}



- If you prefer, you can use button **2** for this purpose.<

Resetting tripmeter

- Switch on the ignition.
- Select the desired tripmeter.

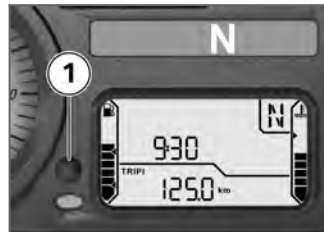

- Press and hold down button **1**.
» The tripmeter is reset to zero.

- without on-board computer^{OE}

- without tyre pressure monitoring (RDC)^{OE}



- If you prefer, you can use button **2** for this purpose.<

Residual range

- without on-board computer^{OE}

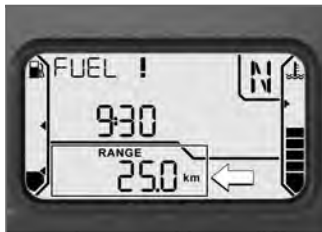

The residual-range readout indicates how far you can ride with the fuel remaining in the tank. This reading is not displayed until fuel level has dropped to reserve. This distance is calculated on the basis of fuel level and average consumption.

When refuelling after running on reserve, make sure that you top up the tank to a level above reserve, as otherwise the sensor will not be able to register the new level. If the sensor cannot register the new level neither

the fuel-level reading nor the residual-range readout can be updated.

▶ The calculated range is an approximate value. Consequently, BMW Motorrad recommends that you should not try to use the full residual range before refuelling.<

On-board computer^{OE}

Selecting readings

- Switch on the ignition.



- Press button **1**.



The display starts with the current value and each time the button is pressed it moves one step through the following sequence:

- Ambient temperature
- Average speed
- Average consumption
- Range
- Oil level
- Tyre pressures (OE)

Ambient temperature



When the motorcycle is at a standstill the heat of the engine can falsify ambient-temperature reading **1**. If the effect of the engine's heat becomes excessive, -- temporarily appears on the display.



If ambient temperature drops below 3 °C a warning appears, drawing your attention to the risk of black ice forming. The display automatically switches from any other mode to the temperature reading when

the temperature drops below this threshold for the first time.

Average speed



Average speed **1** is calculated on the basis of the time elapsed since the last reset. Times during which the engine was stopped are excluded from the calculation.

Resetting average speed

- Switch on the ignition.
- Select average speed.



- Press and hold down button **1**.
» Average speed is reset to zero.

Average consumption



Average consumption **1** is calculated by dividing the distance covered since the last reset by

the corresponding amount of fuel used.

Resetting average consumption

- Switch on the ignition.
- Select average consumption.



- Press and hold down button **1**.
» Average consumption is reset to zero.

Range



The description of the residual-range function (49) also covers range readout **1**. You can also view the range before the fuel level drops to reserve.

A special average-consumption figure is used to calculate range; this figure is not necessarily the same as the value you can call up for viewing on the display. When the motorcycle is propped on its side stand the slight angle of inclination means that the sensor cannot register the fuel level correctly. This is the reason why the range is calculated only

when the motorcycle is on the move.

 The calculated range is only an approximate reading. Consequently, BMW Motorrad recommends that you should not try to use the full range before refuelling.◀

Oil level



Oil-level indicator **1** gives you an indication of the engine oil level. You can call up this reading only when the motorcycle is at a standstill.

The preconditions for the oil level check are as follows:

- Engine at operating temperature.
- Engine idling for at least 10 seconds.
- Side stand retracted.
- Make sure the motorcycle is upright.

The readings mean:

OK: Oil level is correct.

CHECK: Check the oil level the next time you stop for fuel.



If you call up another reading on the on-board computer, this symbol remains visible until the sensor again registers a correct oil level.

---: Oil level cannot be measured (conditions as stated above not satisfied).

The most recently measured level is displayed for 5 seconds when you next switch on the ignition.

 The oil-level sensor might be defective if the "Check oil level" message appears even though the oil level in the oil sight glass is correct. In this case, consult your authorised BMW Motorrad dealer.◀

Tyre pressure monitoring RDC^{OE}

Viewing tyre-pressure readings

- Switch on the ignition.



- Repeatedly press button **1** until the tyre-pressure readings appear on the display.



The tyre pressures are shown, accompanied by the wording RDC P. The front tyre pressure is on the left; the reading

on the right is the rear tyre pressure. The tyre-pressure readings are based on a reference tyre temperature of 20 °C. --- appears directly after the ignition is switched on, because the sensors do not transmit tyre pressures until the motorcycle accelerates to 30 km/h.

Lights

Side light

The side lights switch on automatically when the ignition is switched on.

▶ The side lights place a strain on the battery. Do not switch the ignition on for longer than absolutely necessary. ◀

Low-beam headlight

The low-beam headlight switches on automatically when you start the engine.

▶ When the engine is not running you can switch on the lights by switching on the ignition and either switching on the high-beam headlight or operating the headlight flasher. ◀

High-beam headlight and headlight flasher



- Press the top section of full-beam headlight switch **1**.

- » High-beam headlight switched on.
- Move full-beam headlight switch **1** to the centre position.
- » High-beam headlight switched off.
- Press the bottom section of full-beam headlight switch **1**.
- » The high-beam headlight is switched on until you release the button (headlight flasher).

Switching on parking lights

- Switch off the ignition.



- Immediately after switching off the ignition, press and hold down button **1** for the left turn indicators.
- » Parking light switches on.

Switching off parking lights

- Switch the ignition on and then off again.
- » Parking lights switched off.

Turn indicators

Switching on left flashing turn indicators

- Switch on the ignition.

 The turn indicators are cancelled automatically after you have ridden for approximately 10 seconds, or covered a distance of about 200 m. ◀



- Press button **1** for the left-hand turn indicators.
- » Left-hand turn indicators switched on.
- » Telltale light for left-hand turn indicators flashes.

Switching on right flashing turn indicators

- Switch on the ignition.

▷ The turn indicators are cancelled automatically after you have ridden for approximately 10 seconds, or covered a distance of about 200 m. ◀



- Press button **2** for the right-hand turn indicators.
- » Right-hand turn indicators switched on.
- » Telltale light for right-hand turn indicators flashes.

Cancelling turn indicators



- Press cancel button **3**.
- » Flashing turn indicators switched off.
- » Turn indicator telltale lights are off.

Hazard warning flashers

Switching on hazard warning flashers

- Switch on the ignition.

▷ The hazard warning flashers place a strain on the battery. Do not use the hazard

warning flashers for longer than absolutely necessary. ◀

▷ If you press a turn-indicator or button with the ignition switched on, the turn-indicator function is activated instead of the hazard warning flashers, and remains active until you release the button. The hazard warning flashers recommence flashing as soon as the button is released. ◀



- Simultaneously press button **1** for left turn indicators and button **2** for right turn indicators.

- » The hazard warning flashers are switched on.
- » Left and right turn indicator telltale lights flash.
- Switch off the ignition.
- » The hazard warning flashers continue to operate.
- » Left and right turn indicator telltale lights are off.

Switching off hazard warning flashers



- Press cancel button **3**.
- » Hazard warning flashers switched off.

Emergency off switch (kill switch)



- 1** Emergency off switch (kill switch)

 Operating the kill switch when riding can cause the rear wheel to lock and thus cause a fall. Do not operate the kill switch when riding. ◀

The emergency off switch is a kill switch for switching off the engine quickly and easily.

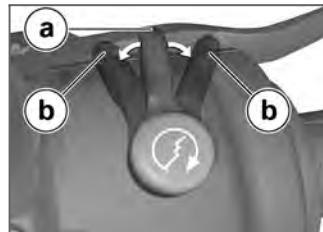

- a** Normal operating position (run)
b Engine switched off.

 You cannot start the engine unless the kill switch is in the run position. ◀

BMW Motorrad Integral ABS^{OE}

Deactivating ABS function

- Bring the motorcycle to a stop or, if the motorcycle is at a standstill, switch on the ignition.



- Press and hold down button **1** until the ABS warning light changes status.

 ABS warning light shows.

- with Automatic Stability Control^{OE}
- » Initially, the ASC symbol changes status. Press and hold down button **1** until the ABS warning light responds. Under these circumstances there is no change in the ASC setting.
- Release the ABS button within two seconds.



ABS warning light remains ON.

- » The ABS function is deactivated, but the integral function remains active.

Response with ABS deactivated

If you deactivate the ABS, the function is initially disabled for the front wheel only. If you subsequently apply the brakes by pulling only the handbrake lever, the Integral function ensures that the rear wheel is also braked and ABS control remains active for the rear wheel. ABS control for the rear wheel is not deactivated until you depress the footbrake lever.

Activating ABS function



- Press and hold down button **1** until the ABS warning light changes status.

 ABS warning light goes out; if self-diagnosis has not completed it starts flashing.

- Release the ABS button within two seconds.

 The ABS warning light remains off or continues to flash.

- » The ABS function is activated.
- You also have the option of switching the ignition off and then on again.

▶ If you switch the ignition off then on again and the ABS light comes back on, there is a fault in the ABS. ◀

Automatic Stability Control ASC^{OE}

Operation

The BMW Motorrad ASC system can be deactivated and activated and switched to an off-road mode (➡ 91) for riding on pebbly or gravely surfaces and on loose sand.

ASC is active when the ASC symbol does not show.

 This symbol appears on the display to indicate that ASC is active in off-road mode.

 This symbol appears on the display to indicate that ASC has been deactivated.

Sequence of operations:

- Switch from ASC to off-road ASC
- Deactivate ASC
- Activate ASC

Switching and deactivating ASC function

- Switch on the ignition.

▶ You have the option of deactivating the ASC function while the motorcycle is on the move. ◀



- Press and hold down ASC button **1** until the ASC symbol changes status.

 Off-road ASC symbol shows; if self-diagnosis has not completed the off-road ASC symbol flashes.

- Release the ASC button within two seconds.

 Off-road ASC symbol remains visible or continues to flash.

- » The off-road ASC function is activated.

- Press and hold down the ASC button until the ASC symbol again changes status.

 ASC symbol appears on the display.

- Release the ASC button within two seconds.

 ASC symbol continues to show.

- » The ASC function is deactivated.

Activating ASC function



- Press and hold down ASC button **1** until the ASC symbol changes status.

 ASC symbol no longer shows; if ASC self-diagnosis has not completed the ASC symbol flashes.

- Release the ASC button within two seconds.

 The ASC symbol remains off or continues to flash.

- » The ASC function is activated.
- You also have the option of switching the ignition off and then on again.

 An ASC fault has occurred if the ASC warning light shows when the motorcycle accelerates to a speed in excess of 10 km/h after the ignition was switched off and then on again. ◀

Seat height

Adjusting seat height

- Remove the front seat (➡ 70)

- Turn the front seat upside down.

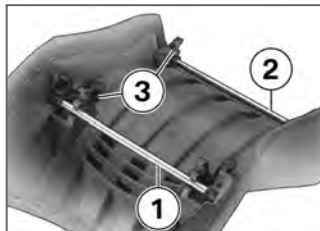

- Introduce seat rods **1** and **2** into holders **3**.

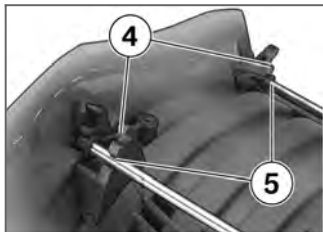

! The front seat can work loose and wobble if the two seat rods are not in the same position.

Always be sure to install both seat rods in the same position. ◀

- Introduce the seat rods in position **4**.
- » Seat set to high position.
- Introduce the seat rods in position **5**.
- » Seat set to low position.
- Install the front seat (▮ 70)

Windscreen

Adjusting windscreen

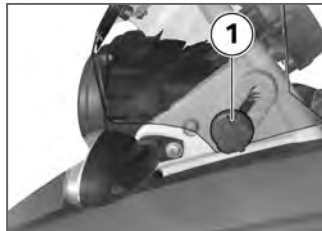

- Slacken clamping screws **1** on left and right.
- Pivot the windscreen forward or back to the desired position.
- Make sure that clamping screws **1** on left and right are symmetrically positioned.
- Tighten the clamping screws.

Clutch

Adjusting clutch lever

! If the position of the clutch fluid reservoir is changed, air can enter the clutch system. Do not twist the handlebar fitting or the handlebars. ◀

! Attempting to adjust the clutch lever while riding the motorcycle can lead to accidents. Do not attempt to adjust the clutch lever unless the motorcycle is at a standstill. ◀

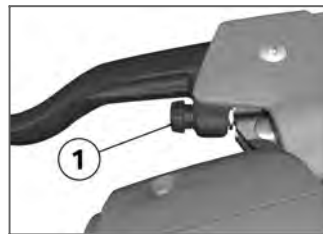

- Turn adjusting screw **1** clockwise.

▶ The adjusting screw is easier to turn if you push the clutch lever forward.◀

- » Span between handlebar grip and clutch lever increases.
- Turn adjusting screw **1** counter-clockwise.
- » Span between handlebar grip and clutch lever decreases.

Brakes

Adjusting handbrake lever

⚠ Changing the position of the brake-fluid reservoir can allow air to penetrate the brake system.

Do not twist the handlebar fitting or the handlebars.◀

⚠ Attempting to adjust the brake lever while riding the motorcycle can lead to accidents. Do not attempt to adjust the brake lever unless the motorcycle is at a standstill.◀

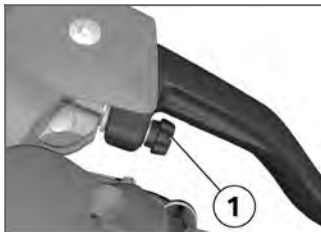

- Turn adjusting screw **1** clockwise.

▶ The adjusting screw is easier to turn if you push the handbrake lever forward.◀

- » Span between handlebar grip and handbrake lever increases.
- Turn adjusting screw **1** counter-clockwise.
- » Span between handlebar grip and handbrake lever decreases.

Mirrors

Adjusting mirrors



- Turn the mirror to the correct position.

Adjusting mirror arm



- Push protective cap **1** up over the threaded fastener on the mirror arm.
- Slacken nut **2**.
- Turn the mirror arm to the appropriate position.
- Tighten the nut to the specified tightening torque, while holding the mirror arm to ensure that it does not move out of position.



Mirror to adapter

– 22 Nm

- Push the protective cap over the threaded fastener.

Handlebars

Adjusting handlebars

You can turn the handlebar clamping blocks 180° to increase or decrease handlebar reach.



Short-reach position, handlebars toward rider.



Long-reach position, handlebars away from rider.

In order to ensure that the handlebars are set correctly, this adjustment should be carried out by a specialist workshop, preferably an authorised BMW Motorrad dealer.

Spring preload

Adjustment for front suspension

It is essential to set spring preload of the front suspension to suit the terrain. Increase spring preload for riding in rough terrain and reduce if the terrain is level.

Adjusting spring preload for front wheel

 Your motorcycle's handling will suffer if you do not match the spring-preload and damping-characteristic settings. Adjust the damping characteristic to suit spring preload. ◀

- Make sure the ground is level and firm and place the motorcycle on its stand.

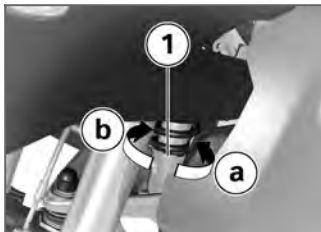

- If you want to reduce spring preload, turn spring retainer **1** in direction **a**.
- If you want to increase spring preload, turn the spring retainer in direction **b**.

 Spring preload at front wheel

– without Electronic Suspension Adjustment (ESA)^{OE}

– Spring preload at setting 2 (On-road riding)

– Spring preload at setting 3 (For riding on gravel tracks and similar and with load)

 Spring preload at front wheel

– Spring preload at setting 5 (For riding off-road) ◀

Adjustment for rear suspension

It is essential to set spring preload of the rear suspension to suit the load carried by the motorcycle. Increase spring preload when the motorcycle is heavily loaded and reduce spring preload accordingly when the motorcycle is lightly loaded.

Adjusting spring preload for rear wheel

- Make sure the ground is level and firm and place the motorcycle on its stand.

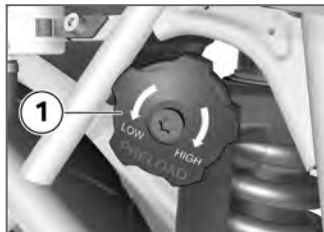

⚠ Your motorcycle's handling will suffer if you do not match the spring-preload and damping-characteristic settings. Adjust the damping characteristic to suit spring preload. ◀

⚠ Adjusting spring preload while the motorcycle is being ridden can lead to accidents. Do not attempt to adjust spring preload unless the motorcycle is at a standstill. ◀

- If you want to increase spring preload, turn knob **1** in the direction indicated by the HIGH arrow.

- If you want to reduce spring preload, turn knob **1** in the direction indicated by the LOW arrow.



Basic setting of spring preload, rear

- without Electronic Suspension Adjustment (ESA)^{OE}
- Turn the adjusting knob as far as it will go counter-clockwise in the direction indicated by the LOW arrow (L) and then turn it 10 clicks clockwise (For riding one-up) ◀



- You can ascertain the current setting by counting the number of slots that are visible (five when the adjuster is at the LOW stop).

Damping Setting

Damping must be adapted to suit the surface on which the motorcycle is ridden and to suit spring preload.

- An uneven surface requires softer damping than a smooth surface.

- An increase in spring preload requires firmer damping, a reduction in spring preload requires softer damping.

Adjusting damping for rear wheel

- Make sure the ground is level and firm and place the motorcycle on its stand.

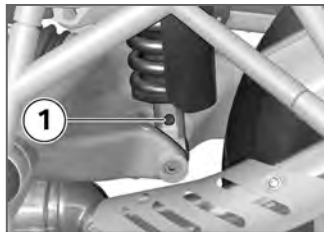

⚠ There is a risk of injury by burns if you adjust the damping characteristic while the silencer is hot.

Use a screwdriver extension and wear protective gloves. ◀

- Adjust the damping characteristic, using the tool from the on-board toolkit to turn adjusting screw **1**.

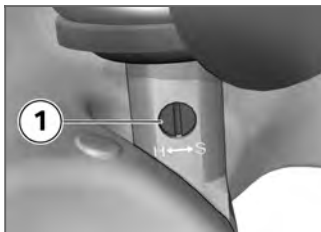

- If you want a harder damping characteristic, use a screwdriver to turn adjusting screw **1** in the direction indicated by the H arrow.
- If you want a softer damping characteristic, use a screwdriver to turn adjusting screw **1** in the direction indicated by the S arrow.

 Basic setting of rear-suspension damping characteristic

- without Electronic Suspension Adjustment (ESA)^{OE}

- Turn the adjusting screw as far as it will go in the direction indicated by the H arrow and then turn it back one and a half turns in the direction indicated by the S arrow (Full load of fuel, with rider 85 kg)◀

- with lowered suspension^{OE}

- Turn the adjusting screw as far as it will go in the direction indicated by the H arrow and then turn it back three quarters of a turn in the direction indicated by the S arrow (Full load of fuel, with rider 85 kg)◀

Electronic Suspension Adjustment ESA OE

Possible adjustments

Electronic Suspension Adjustment ESA provides a convenient way of adapting the motorcycle to the load it carries and the surface over which you intend riding. You can adapt the suspension settings for on-road or off-road riding.

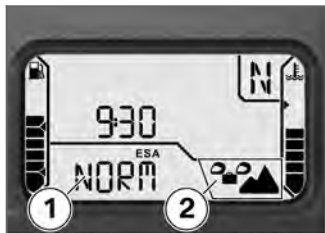

The damping characteristic is shown in panel **1** of the multi-function display, and spring preload in panel **2**. The odometer

readings are not shown while the ESA readout is active.

In order for you to adapt the motorcycle's handling to suit load and the surface on which you will be riding, three spring-preload stages can be combined with any of three damping characteristics for road riding, and in offroad mode you have a choice of two spring-preload stages that can be combined with any of three damping-characteristic settings. The detailed description of the ESA Electronic Suspension Adjustment system starts on page (93).

Calling up settings

- Switch on the ignition.



- Press button **1**.
 - » The current setting is displayed.
 - » The reading remains visible for a few seconds before disappearing automatically.

Adjusting suspension damping

- Switch on the ignition.

▶ You can adjust the damping characteristic while the motorcycle is on the move.◀



- Press button **1**.
- » The current setting is displayed.
- Press button **1** once at each step.

If you have selected a spring preload setting for road riding, the display starts at the current status and cycles through the following sequence:

- COMF: Comfortable damping characteristic
- NORM: Normal damping characteristic

– SPORT: Sporty damping characteristic
 If you have selected a spring preload setting for off-road riding, the display starts at the current status and cycles through the following sequence:

- SOFT: Soft damping characteristic
- NORM: Normal damping characteristic
- HARD: Hard damping characteristic
- » The setting shown on the display is automatically accepted as the damping characteristic if you allow a certain length of time to pass without pressing button **1**.

Adjusting spring preload

- Start the engine.

 You cannot adjust spring preload while the motorcycle is on the move. ◀

- Wait until adjustment completes (reading stops flashing) before pulling away.
- If the temperature is very low, take the weight off the motorcycle before increasing spring preload; if applicable, have your passenger dismount.



- Press button **1**.
- » The current setting is displayed.
- Press and hold down button **1** until the reading changes.

The display field starts at the current status and cycles through the following sequence:



One-up



One-up with luggage



Two-up (with luggage)

The possible settings for off-road riding then appear on the display. The damping-characteristic settings you can select also changes accordingly.



Predominantly smooth terrain



Uneven terrain

- » The settings shown on the display are automatically accepted as the spring preload and, if applicable, the damping characteristic if you allow a certain length of time to pass without

pressing button **1**. The reading flashes while spring preload adjustment is in progress.

Tyres

Checking tyre pressure



Incorrect tyre pressures impair the motorcycle's handling characteristics and increase the rate of tyre wear.

Always check that the tyre pressures are correct. ◀



At high road speeds, tyre valves installed perpendicular to the wheel rim have a tendency to open as a result of centrifugal force.

In order to avoid a sudden loss of tyre pressure, fit a valve cap with rubber sealing ring to the rear tyre and make sure that the cap is screwed on firmly. ◀

- Make sure the ground is level and firm and place the motorcycle on its stand.

- Check tyre pressures against the data below.



Tyre pressure, front

– 2.2 bar (one-up, tyre cold)

– 2.5 bar (two-up and/or with luggage, tyre cold)



Tyre pressure, rear

– 2.5 bar (one-up, tyre cold)

– 2.9 bar (two-up and/or with luggage, tyre cold)

If tyre pressure is too low:

- Correct tyre pressure.

Headlight

Adjusting headlight for driving on left/driving on right

If the motorcycle is ridden in a country where the opposite rule of the road applies, its asymmetric low-beam headlight will tend to dazzle oncoming traffic. Have the headlight set accordingly by a specialist workshop, preferably an authorised BMW Motorrad dealer.

Headlight beam throw and spring preload

Headlight beam throw is generally kept constant when spring preload is adjusted to suit load. Spring preload adjustment might not suffice only if the motorcycle is very heavily loaded. Under these circumstances, headlight beam throw has to be adjusted

to suit the weight carried by the motorcycle.

▶ Consult a specialist workshop, preferably an authorised BMW Motorrad dealer, if you are unsure whether the headlight basic setting is correct.◀

Headlight beam-throw adjustment



1 Headlight beam-throw adjustment

Spring preload adjustment might not suffice if the motorcycle is very heavily loaded. Moving the

pivot lever adjusts headlight beam throw so as not to dazzle oncoming traffic.



- a** Neutral position
- b** Position for heavy load

Front and rear seats

Removing rear seat

- Make sure the ground is level and firm and place the motorcycle on its stand.

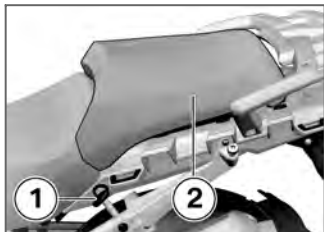

- Turn key **1** clockwise in the seat lock, while pressing down the front part of rear seat **2**.
- Lift the rear seat at the front and remove the seat.

Removing front seat

- Remove the rear seat (➡ 69)

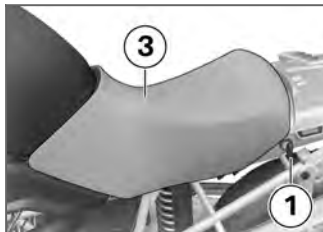

- Turn key **1** counter-clockwise in the seat lock, while pressing down the rear part of front seat **3**.
- Lift the front seat at the rear and remove the seat.

Installing front seat



- Engage the front seat in front mounts **4** on left and right and lower it onto the motorcycle.

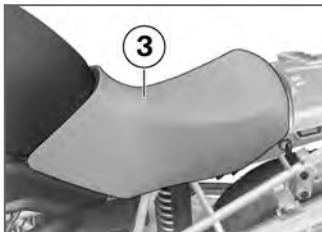

! If too much pressure is applied in the forward direction, there is a danger that the motorcycle will be pushed off its stand.

Always make sure that the motorcycle is stable and firmly supported. ◀

- Applying pressure to the rear of the seat, push front seat **3** slightly forward and then press the seat firmly down.
- » The front seat engages with an audible click.
- Install the rear seat (➡ 71)

Installing rear seat

- Install the front seat (➡ 70)

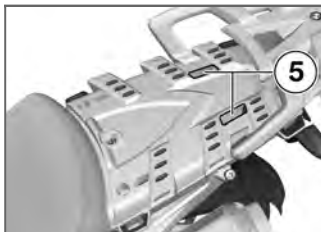

- Engage the rear seat in rear mounts **5**.

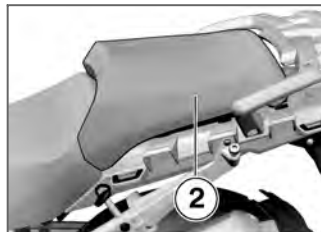

- Push down firmly on rear seat **2**, applying pressure to the front of the seat.
- » The rear seat engages with an audible click.

Helmet holder

Securing helmet to motorcycle

- Remove the front seat (➡ 70)



The helmet catch can scratch the panelling.

Make sure the lock is out of the way when you hook the helmet into position. ◀

- Attach the helmet to helmet holder **1** by means of the chin strap.
- Install the front seat (▶▶▶ 70)

Riding

Safety instructions	74
Checklist.....	75
Starting	76
Lowered suspension ^{OE}	78
Running in	79
Riding off-road.....	80
Brakes	81
Parking your motorcycle	82
Refuelling	84
Securing motorcycle for transportation	85

Safety instructions

Rider's equipment

Do not ride without the correct clothing. Always wear:

- Helmet
- Motorcycling jacket and trousers
- Gloves
- Boots

This applies even to short journeys, and to every season of the year. Your authorised BMW Motorrad dealer will be glad to advise you on the correct clothing for every purpose.

Speed

If you ride at high speed, always bear in mind that various boundary conditions can adversely affect the handling of your motorcycle:

- Settings of the spring-strut and shock-absorber system
- Imbalanced load
- Loose clothing
- Insufficient tyre pressure
- Poor tyre tread
- Etc.

Correct loading



Overloading and imbalanced loads can adversely affect the motorcycle's handling. Do not exceed the permissible gross weight and be sure to comply with the instructions on loading. ◀

Alcohol and drugs



Even small amounts of alcohol or drugs will adversely affect your perception and your ability to assess situations and make decisions, and slow down your reflexes. Medication can exacerbate these effects.

Do not ride your motorcycle after consuming alcohol, drugs and/or medication. ◀

Risk of poisoning

Exhaust fumes contain carbon monoxide, which is colourless and odourless but highly toxic.



Inhaling the exhaust fumes therefore represents a health hazard and can even cause loss of consciousness with fatal consequences.

Do not inhale exhaust fumes. Do not run the engine in an enclosed space. ◀

High voltage



Touching live parts of the ignition system with the engine running can cause electric shock.

Do not touch parts of the ignition system when the engine is running. ◀

Catalytic converter

If misfiring causes unburned fuel to enter the catalytic converter, there is a danger of overheating and damage.

For this reason, observe the following points:

- Do not run the fuel tank dry.
- Do not attempt to start or run the engine with a spark-plug cap disconnected.
- Stop the engine immediately if it misfires.
- Use only unleaded fuel.
- Comply with all specified maintenance intervals.

 Unburned fuel will destroy the catalytic converter.

Note the points listed for protection of the catalytic converter. ◀

Risk of fire

Temperatures at the exhaust are high.

 Flammable materials (e.g. hay, leaves, grass, clothing and luggage, etc.) could ignite if allowed to come into contact with the hot exhaust pipe.

Do not permit flammable materials to come into contact with the hot exhaust system. ◀

 Cooling would be inadequate if the engine were allowed to idle for a lengthy period with the motorcycle at a standstill: overheating would result. In extreme cases, the motorcycle could catch fire.

Do not allow the engine to idle unnecessarily. Ride away immediately after starting the engine. ◀

Tampering with the engine control unit

 Tampering with the engine control unit can damage the motorcycle and cause accidents.

Do not tamper with the engine control unit. ◀

 Tampering with the engine control unit can result in mechanical loads that the motorcycle's components are not designed to withstand. Damage caused in this way is not covered by the warranty.

Do not tamper with the engine control unit. ◀

Checklist

Use the following checklist to check important functions, settings and wear limits before you ride off.

- Brakes
- Brake-fluid levels, front and rear
- Clutch
- Clutch fluid level
- Damping-characteristic setting and spring preload
- Tyre-tread depth and tyre pressures
- Cases correctly installed and luggage secured

At regular intervals:

- Engine oil level (every refuelling stop)
- Brake-pad wear (every third refuelling stop)

Starting

Side stand

You cannot start the motorcycle with the side stand extended and a gear engaged. The engine will switch itself off if you start it with the gearbox in neutral and then

engage a gear before retracting the side stand.

Gearbox

You can start the engine when the gearbox is in neutral or if you pull the clutch with a gear engaged. Do not pull the clutch until after you have switched on the ignition, as otherwise the engine will refuse to start.

Starting engine

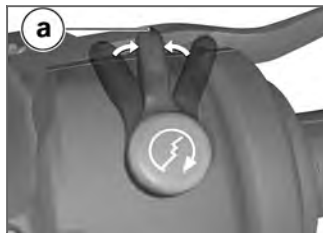

- Kill switch in run position **a**.
- Switch on the ignition.

- » Pre-ride check is performed. (➡ 77)
- with BMW Motorrad Integral ABS II^{OE}
- » ABS self-diagnosis is performed. (➡ 77)
- with Automatic Stability Control^{OE}
- » ASC self-diagnosis is performed. (➡ 78)

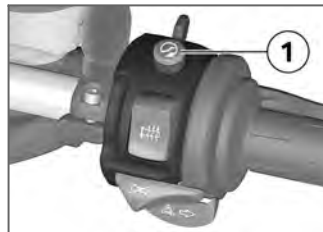

- Press starter button **1**.

▶ If ambient temperatures are very low, you might find it necessary to open the throttle slightly when starting the engine.

At ambient temperatures below 0 °C, disengage the clutch after switching on the ignition.◀

▷ The start attempt is automatically interrupted if battery voltage is too low. Recharge the battery before you start the engine, or use jump leads and a donor battery to start.◀

- » The engine starts.
- » Consult the troubleshooting chart below if the engine refuses to start. (➡ 146)

Pre-ride check

The instrument panel runs a test of the 'General' warning light when the ignition is switched on: this is the "Pre-Ride-Check" The test is aborted if you start the engine before it completes.

Phase 1



General warning light lights up red.

- CHECK ! appears on the display.

Phase 2



General warning light shows yellow.

- CHECK ! appears on the display.

If the 'General' warning light does not show:



Some malfunctions cannot be indicated if the 'General' warning light cannot be displayed.

Check that the 'General' warning light comes on, and that it shows red and yellow.◀

- Have the fault rectified as quickly as possible by a specialist workshop, preferably

an authorised BMW Motorrad dealer.

ABS self-diagnosis^{OE}

BMW Motorrad Integral ABS performs self-diagnosis to ensure its operability. Self-diagnosis is performed automatically when you switch on the ignition. The motorcycle has to move forward at a speed above 5 km/h for the wheel sensors to be tested.

Phase 1

- » Test of the diagnosis-compatible system components with the motorcycle at a standstill.
- ABS warning light flashes.



Possible national variant of the ABS warning light.

Phase 2

- » Test of the wheel sensors as the motorcycle pulls away from rest.



ABS warning light flashes.



Possible national variant of the ABS warning light.

ABS self-diagnosis completed

- » The ABS warning light goes out.

If an indicator showing an ABS fault appears when ABS self-diagnosis completes:

- You can continue to ride. Bear in mind that neither the ABS function nor the integral braking function is available.
- Have the fault rectified as quickly as possible by a specialist workshop, preferably an authorised BMW Motorrad dealer.

ASC self-diagnosis^{OE}

BMW Motorrad ASC performs self-diagnosis to ensure its operability. Self-diagnosis is performed automatically when you switch on the ignition. The engine must be running and the motorcycle must reach a speed of at least 5 km/h in order for ASC self-diagnosis to complete.

Phase 1

- » Test of the diagnosis-compatible system components with the motorcycle at a standstill.



ASC symbol slow-flashes.

Phase 2

- » Test of the diagnosis-compatible system components while the motorcycle is on the move.



ASC symbol slow-flashes.

ASC self-diagnosis completed

- » The ASC symbol no longer shows.

If an indicator showing an ASC fault appears when ASC self-diagnosis completes:

- You can continue to ride. Bear in mind that the ASC function is not available.
- Have the fault rectified as quickly as possible by a specialist workshop, preferably an authorised BMW Motorrad dealer.

Lowered suspension^{OE}

A motorcycle with lowered suspension has less ground clearance and cannot corner at angles of heel as extreme as those achievable by a counterpart motorcycle with standard-height suspension.

 Risk of accident by unexpectedly early contact with the ground.

Bear in mind that lowered suspension limits the motorcycle's angle of heel and ground clearance. ◀

Test your motorcycle's angle of heel in situations that do not involve risk. When riding over kerbs and similar obstacles, bear in mind that your motorcycle's ground clearance is limited.

Lowering the motorcycle's suspension shortens suspension travel (see the section entitled "Technical Data"). Ride comfort might be restricted as a result. Be sure to adjust spring preload accordingly, particularly for riding two-up.

Running in

The first 1000 km

- While running in the motorcycle, vary the throttle opening and engine-speed range frequently.
- Try to do most of your riding during this initial period on twisting, fairly hilly roads, avoiding high-speed main roads and highways if possible.

 Exceeding the specified engine speeds while running in will lead to increased engine wear.

Keep to the specified engine speeds for running in. ◀

- Do not exceed the rpm limits recommended for running in.



Running-in speed

– <4000 min⁻¹

- No full-load acceleration.

- Avoid low engine speeds at full load.
- Do not omit the first inspection after 500 - 1200 km.

Brake pads

New brake pads must "bed down" and therefore do not achieve their optimum friction levels during the first 500 km. You can compensate for this initial reduction in braking efficiency by exerting greater pressure on the levers.

 New brake pads can extend stopping distance by a significant margin. Apply the brakes in good time. ◀

Tyres

New tyres have a smooth surface. This must be roughened by riding in a restrained manner at various heel angles until the tyres are run in. This running in pro-

cedure is essential if the tyres are to achieve maximum grip.

 Tyres do not have their full grip when new and there is a risk of accidents at extreme angles of heel. Avoid extreme angles of heel.◀

Riding off-road

Tyre pressure

 Tyre pressures reduced for off-road riding impair the motorcycle's handling characteristics on surfaced roads and can lead to accidents. Always check that the tyre pressures are correct.◀

Wheel rims for riding off-road

BMW Motorrad recommends checking the rims for damage after off-riding.

 This motorcycle is a touring Enduro machine, which means it can also be used for light off-riding on unsurfaced tracks. Severe off-riding could, however, result in damage to the standard cast-aluminium wheels. Use the cross-spoked wheels available as optional extras for severe off-riding.◀

Dirt or mud on brakes

 When riding on loose surfaces or muddy roads, the brakes may fail to take effect immediately because of dirt or moisture on the discs or brake pads.

Apply the brakes in good time until the brakes have been cleaned.◀

 The brake pads will wear more rapidly if you ride frequently on unsurfaced tracks or poor roads.

Check the thickness of the brake

pads more frequently and replace the brake pads in good time.◀

Spring preload and shock-absorber settings

 The off-road settings for spring preload and shock absorber damping characteristic will impair the motorcycle's handling characteristics on surfaced roads.

If you have been off-riding, remember to correct spring preload and shock-absorber damping characteristics before you return to surfaced roads.◀

Deactivatable ABS^{OE}

You can deactivate the ABS function of the BMW Motorrad Integral ABS for off-riding (➔ 56). The integral braking function remains active.

Brakes

How can stopping distance be minimised?

Each time the brakes are applied, a load distribution shift takes place with the load shifting forward from the rear to the front wheel. The sharper the motorcycle decelerates, the more load is shifted to the front wheel. The higher the wheel load, the more braking force can be transmitted without the wheel locking.

To optimise stopping distance, apply the front brakes rapidly and keep on increasing the force you apply to the brake lever. This makes the best possible use of the dynamic increase in load at the front wheel. Remember to pull the clutch at the same time. In the "panic braking situations" that are trained so frequently braking force is applied as rapidly as possible and with the

rider's full force exerted on the brake levers; under these circumstances the dynamic shift in load distribution cannot keep pace with the increase in deceleration and the tyres cannot transmit the full braking force to the surface of the road. Under these circumstances the front wheel can lock up.

– with BMW Motorrad Integral ABS II^{OE}

ABS has to intervene to keep the front wheel from locking; this increases stopping distance.<

Descending mountain passes

 There is a danger of the brakes fading if you use only the rear brakes when descending mountain passes. Under extreme conditions, the brakes could overheat and suffer severe damage.

Use both front and rear brakes, and make use of the engine's braking effect as well.<

Wet brakes

 After the motorcycle has been washed, ridden through water or ridden in the rain, the brake discs and pads might be wet and the brakes might not take effect immediately.

Apply the brakes in good time until the brakes have dried out.<

Salt on brakes

 The brakes may fail to take effect immediately if the motorcycle was ridden on salt-covered roads and the brakes were not applied for some time. Apply the brakes in good time until the salt layer on the brake discs and brake pads has been removed.<

Oil or grease on brakes

 Oil and grease on the brake discs and pads considerably diminish braking efficiency. Especially after repair and maintenance work, make sure that the brake discs and brake pads are free of oil and grease. ◀

Dirt or mud on brakes

 When riding on loose surfaces or muddy roads, the brakes may fail to take effect immediately because of dirt or moisture on the discs or brake pads. Apply the brakes in good time until the brakes have been cleaned. ◀

 The brake pads will wear more rapidly if you ride frequently on unsurfaced tracks or poor roads. Check the thickness of the brake

pads more frequently and replace the brake pads in good time. ◀

Parking your motorcycle

Placing motorcycle on side stand

 If the ground is soft or uneven, there is no guarantee that the motorcycle will rest firmly on the stand. Always check that the ground under the stand is level and firm. ◀

- Switch off the engine.
- Pull the handbrake lever.
- Hold the motorcycle upright and balanced.
- Use your left foot to extend the side stand fully.

 The side stand is designed to support only the weight of the motorcycle. Do not lean or sit on the

motorcycle with the side stand extended. ◀

- Slowly lean the motorcycle to the side until its weight is taken by the stand and dismount to the left.

 If the motorcycle is on the side stand, the surface of the ground will determine whether it is better to turn the handlebars to the left or right. However, the motorcycle is more stable on a level surface with the handlebars turned to the left than with the handlebars turned to the right.

On level ground, always turn the handlebars to the left to set the steering lock. ◀

- Turn the handlebars to full left or right lock.
- Check that the motorcycle is standing firmly.

 On a gradient, the motorcycle should always face uphill; select 1st gear.◀

- Lock the steering lock.

Removing motorcycle from side stand

- Unlock the steering lock.
- From the left, grip the handlebars with both hands.
- Pull the handbrake lever.
- Swing your right leg over the seat and lift the motorcycle to the upright position.
- Hold the motorcycle upright and balanced.

 An extended side stand can catch on the ground when the motorcycle is moving and lead to a fall.

Retract the side stand before moving the motorcycle.◀

- Sit on the motorcycle and use your left foot to retract the side stand.

Placing motorcycle on centre stand

 If the ground is soft or uneven, there is no guarantee that the motorcycle will rest firmly on the stand.

Always check that the ground under the stand is level and firm.◀

- Switch off the engine.
- Dismount and keep your left hand on the left handlebar grip.
- Grip the rear frame with your right hand.
- Use your right foot on the pin of the centre stand to press the stand down until its curved feet touch the ground.
- Place your full body weight on the centre stand and at the same time pull the motorcycle to the rear.

 Excessive movements could cause the centre stand to retract, and the motorcycle would topple in consequence.

Do not lean or sit on the motorcycle with the centre stand extended.◀

- Check that the motorcycle is standing firmly.
- Lock the steering lock.

Removing motorcycle from centre stand

- Unlock the steering lock.
- Place your left hand on the left handlebar grip.
- Grip the rear frame with your right hand.
- Push the motorcycle forward off the centre stand.
- Check that the centre stand has fully retracted.

Refuelling

⚠ Fuel is highly flammable. A naked flame close to the fuel tank can cause a fire or explosion.

Do not smoke. Never bring a naked flame near the fuel tank.◀

⚠ Fuel expands when hot. Fuel escaping from an overfilled tank could make its way onto the rear tyre. This could cause a fall.

Do not fill the tank past the bottom edge of the filler neck.◀

⚠ Fuel attacks plastics, which become dull or unsightly. Wipe off plastic parts immediately if they come into contact with fuel.◀

⚠ Fuel can attack the material of the windscreen and the side slipstream deflectors, which become dull or unsightly.

Wipe off the windscreen and slip-

stream deflectors immediately if they come into contact with fuel.◀

⚠ Leaded fuel will destroy the catalytic converter.

Use only unleaded fuel.◀

- Make sure the ground is level and firm and place the motorcycle on its stand.

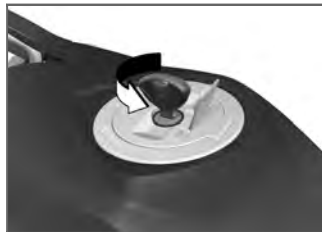

- Open the protective cap.
- Open the fuel tank cap with the ignition key by turning it counter-clockwise.



- Refuel with fuel of the grade stated below; do not fill the tank past the bottom edge of the filler neck.



Recommended fuel grade

– 95 ROZ/RON (Super unleaded)

– 91 ROZ/RON (Regular unleaded (fuel grade, usable with power- and consumption-related restrictions))



Usable fuel capacity

– approx. 20 l



Reserve fuel

– ≥ 4 l

- Press the fuel tank cap down firmly to close.
- Remove the key and close the protective cap.

Securing motorcycle for transportation

- Make sure that all components that might come into contact with straps used to secure the motorcycle are adequately protected against scratching. Use adhesive tape or soft cloths, for example, for this purpose.



The motorcycle can topple and fall on its side.

Make sure that the motorcycle cannot topple sideways. ◀

- Push the motorcycle onto the transportation flat and hold it in position: do not place it on the side stand or centre stand.



Risk of damaging components.

Take care not to trap components such as brake lines or wires. ◀

- At the front, secure the straps to the handlebars on both sides.
- Pass the straps through the leading link and tighten the straps.



- At the rear, secure the straps to the rear footrests on both sides and tighten the straps.
- Tighten all the straps uniformly; the motorcycle's suspension should be compressed as tightly as possible front and rear.

Engineering details

Brake system with BMW Motorrad Integral ABS ^{OE}	88
Electronic engine management with BMW Motorrad ASC ^{OE}	90
Tyre pressure monitoring RDC ^{OE}	92
Electronic Suspension Adjustment ESA ^{OE}	93

Brake system with BMW Motorrad Integral ABS^{OE}

Partially integral brakes

Your motorcycle is equipped with partially integral brakes. Both front and rear brakes are applied when you pull the handbrake lever. The footbrake lever acts only on the rear brake.

While the brakes are slowing the motorcycle, the BMW Motorrad Integral ABS adapts braking-force distribution between front and rear brakes to suit the load on the motorcycle.

 The integral braking function makes it very difficult to spin the rear wheel by opening the throttle with the front brake applied to keep the motorcycle stationary (burn-out). Attempted burn-outs can result in damage to the rear brake and the clutch. Do not attempt burn-outs. ◀

How does ABS work?

The amount of braking force that can be transferred to the road depends on factors that include the coefficient of friction of the road surface. Loose stones, ice and snow or a wet road all have much lower coefficients of friction than a clean, dry asphalt surface. The lower the coefficient of friction, the longer the braking distance.

If the rider increases braking pressure to the extent that braking force exceeds the maximum transferrable limit, the wheels start to lock and the motorcycle loses its directional stability; a fall is imminent. Before this situation can occur, ABS intervenes and adapts braking pressure to the maximum transferrable braking force, so the wheels continue to turn and directional stability is maintained irrespective of the condition of the road surface.

What are the effects of surface irregularities?

Humps and surface irregularities can cause the wheels to lose contact temporarily with the road surface; if this happens the braking force that can be transmitted to the road can drop to zero. If the brakes are applied under these circumstances the ABS has to reduce braking force to ensure that directional stability is maintained when the wheels regain contact with the road surface. At this instant the BMW Motorrad Integral ABS must assume an extremely low coefficient of friction, so that the wheels will continue to rotate under all imaginable circumstances, because this is the precondition for ensuring directional stability. As soon as it registers the actual circumstances, the system reacts instantly and adjusts brak-

ing force accordingly to achieve optimum braking.

What feedback does the rider receive from the BMW Motorrad Integral ABS?

If the ABS system has to reduce braking force on account of the circumstances described above, vibration is perceptible through the handbrake lever.

When the handbrake lever is pulled, brake pressure is also built up at the rear wheel by the integral function. If the brake pedal is depressed after the handbrake lever is pulled, the brake pressure built up beforehand is perceptible as counter-pressure sooner than is the case when the brake pedal is depressed either before or at the same time as the brake lever is pulled.

Rear wheel lift

Under very severe and sudden deceleration, however, under certain circumstances it is possible that the BMW Motorrad Integral ABS will be unable to prevent the rear wheel from lifting clear of the ground. If this happens the outcome can be a highside situation in which the motorcycle can flip over.



Severe braking can cause the rear wheel to lift off the ground.

When you brake, bear in mind that ABS control cannot be relied on in all circumstances to prevent the rear wheel from lifting clear of the ground. ◀

What is the design baseline for BMW Motorrad Integral ABS?

Within the limits imposed by physics, the BMW Motorrad Integral ABS ensures directional stability on any surface. The system is not optimised for special requirements that apply under extreme competitive situations off-road or on the track.

Special situations

The speeds of the front and rear wheels are compared as one means of detecting a wheel's incipient tendency to lock. If the system registers implausible values for a lengthy period the ABS function is deactivated for safety reasons and an ABS fault message is issued. Self-diagnosis has to complete before fault messages can be issued. In addition to problems with the BMW Motorrad Integral ABS,

exceptional riding conditions can lead to a fault message being issued.

Exceptional riding conditions:

- Heating up with the motorcycle on the centre stand or an auxiliary stand, engine idling or with a gear engaged.
- Rear wheel locked by the engine brake for a lengthy period, for example while descending on a loose or slippery surface.

If a fault message is issued on account of exceptional riding conditions as outlined above, you can reactivate the ABS function by switching the ignition off and on again.

What significance devolves on regular maintenance?



Invariably, a technical system cannot perform beyond the abilities dictated by its level of maintenance.

In order to ensure that the BMW Motorrad ABS is always maintained in optimum condition, it is essential for you to comply strictly with the specified inspection intervals. ◀

Reserves for safety

The potentially shorter braking distances which BMW Motorrad Integral ABS permits must not be used as an excuse for careless riding. ABS is primarily a means of ensuring a safety margin in genuine emergencies.

Take care when cornering. When you apply the brakes on a corner, the motorcycle's weight and

momentum take over and even BMW Motorrad Integral ABS is unable to counteract their effects.

Electronic engine management with BMW Motorrad ASC^{OE}

How does ASC work?

The BMW Motorrad ASC compares the speed of rotation of the front wheel and the rear wheel. The differential is used to compute slip as a measure of the reserves of stability available at the rear wheel. If slip exceeds a certain limit the electronic engine management system intervenes, adapting engine torque accordingly.

What is the design baseline for BMW Motorrad ASC?

BMW Motorrad ASC is designed as an assistant system for the rider and for use on public roads. The extent to which the rider affects ASC control can be considerable (weight shifts when cornering, items of luggage loose on the motorcycle), especially when style of riding takes rider and machine close to the limits imposed by physics.

The off-road mode can be activated for off-roading. This mode delays ASC intervention slightly in order to permit controlled drifting.

The system is not optimised for special requirements that apply under extreme competitive situations off-road or on the track. You have the option of deactivating the BMW Motorrad ASC system for these circumstances.



Even ASC is constrained by the laws of physics. Invariably, the rider bears responsibility for assessing road and traffic conditions and adopting his or her style of riding accordingly. Do not take risks that would negate the additional safety offered by this system. ◀

Special situations

In accordance with the laws of physics, the ability to accelerate is restricted more and more as the angle of heel increases. Consequently, there can be a perceptible lag in acceleration out of very tight bends.

The speeds of the front and rear wheels are compared as one means of detecting a wheel's incipient tendency to spin. If the system registers implausible values for a lengthy period the ASC function is deactivated for safety

reasons and an ASC fault message is issued. Self-diagnosis has to complete before fault messages can be issued. The BMW Motorrad ASC can shut down automatically under the exceptional riding conditions outlined below.

Exceptional riding conditions:

- Riding for a lengthy period with the front wheel lifted off the ground (wheelie).
- Rear wheel rotating with the motorcycle held stationary by applying the front brake (burn-out).
- Heating up with the motorcycle on the centre stand or an auxiliary stand, engine idling or with a gear engaged.

Accelerating the motorcycle to a speed in excess of 10 km/h after switching the ignition off

and then on again reactivates the ASC.

Slip can be increased by very-heavy-duty massive-bar tyres, with the result that ASC intervention occurs before optimum forward acceleration is achieved. Under these circumstances, BMW Motorrad ASC should be deactivated.

If the front wheel lifts clear of the ground under severe acceleration, the ASC reduces engine torque until the front wheel regains contact with the ground. Under these circumstances, BMW Motorrad recommends rolling the throttle slightly closed so as to restore stability with the least possible delay.

When riding on a slippery surface, never snap the throttle twistgrip fully closed without pulling the clutch at the same time. Engine braking torque can cause the rear wheel to lock, with a corresponding loss of stability. The BMW Motorrad ASC is unable to control a situation of this nature.

Tyre pressure monitoring RDC^{OE}

Function

A sensor integrated into each tyre measures the air temperature and the air pressure inside the tyre and transmits this information to the control unit. Each sensor has a centrifugal-force tripswitch that does not enable transmission of the measured values until the motorcycle has accelerated to above approximately 30 km/h for the first time.

The display shows -- for each tyre until the tyre-pressure signal is received for the first time. The sensors continue to transmit the measured-value signals for approximately 15 minutes after the motorcycle comes to a stop. The control unit can administer four sensors, so two different sets of wheels with RDC sensors can be alternated on the motorcycle. An error message is issued if wheels without sensors are fitted to a motorcycle equipped with an RDC control unit.

Tyre-pressure ranges

The RDC control unit differentiates between three tyre-pressure ranges, all of which are parameterised for the motorcycle:

- Tyre pressure within permitted tolerance.
- Tyre pressure close to limit of permitted tolerance.

- Tyre pressure outside permitted tolerance.

A warning is also issued if tyre pressure drops sharply but stays within the permitted tolerance.

Temperature compensation

Tyre pressure is a temperature-sensitive variable: pressure increases as tyre temperature rises and decreases as tyre temperature drops. Tyre temperature depends on ambient temperature, on the style of riding and the duration of the ride.

The tyre-pressure readings shown by the multifunction display are temperature-compensated; the reference tyre temperature for these readings is always 20 °C. The air lines available to the public in petrol stations and motorway service areas have gauges that do not compensate for temperature; the

reading shown by a gauge of this nature is the temperature-dependent tyre pressure. In most instances, therefore, these gauge readings will not tally with the pressures shown by the multifunction display.

Pressure adaptation

Compare the RDC readings on the multifunction display with the value in the table on the inside cover of the Rider's Manual. Then use the air line to compensate for the difference between the RDC reading and the value in the table.

Example: According to the Rider's Manual, tyre pressure should be 2.5 bar, but the reading in the multifunction display is 2.3 bar, so pressure is low by 0.2 bar. The gauge on the air line shows 2.4 bar. You must now increase tyre pressure by the 0.2 bar difference between the value in the

table and the RDC reading; when the air-line gauge shows 2.6 bar, the tyre is inflated to the correct pressure.

Electronic Suspension Adjustment ESA^{OE}

Adjuster, spring preload

In order to ensure rapid adjustment at ambient temperatures below 0 °C, BMW Motorrad recommends adjusting the suspension to the setting for two-up riding and allowing adjustment to complete before your passenger mounts the motorcycle.

The ESA indicator continues to flash until adjustment completes. Do not attempt to move the motorcycle until adjustment has completed.

Off-road settings

The Enduro ESA developed specially for the R 1200 GS incorporates the road-riding modes from other BMW models, plus special off-roading modes enabled by electro-hydraulic basic spring adjustment of the front spring strut. This convenient system of adjusting the suspension to suit very widely differing surfaces enhances the motorcycle's touring and off-roading capabilities.



In this mode, the spring preload of the front spring strut is increased to about 50 %. The rear spring base setting adjusts to the same position. This setting is suitable for off-roading in terrain in which large bumps or holes in the ground are unlikely to be encountered.



This setting brings spring preload of both front and rear spring struts up to maximum. It can be used, for example, in terrain where the likelihood of having to negotiate bumps and holes in the ground necessitates maximum protection against the suspension bottoming out. Ground clearance in this mode is more than in the "one-up" road-riding mode.

Not every ESA setting is suitable for every surface. Try out the various combinations of spring preload and damping until you find the settings that are best suited to your style of riding and the surface.

Accessories

General instructions.....	96
Power socket	96
Auxiliary headlights ^{OA}	97
Luggage	97
Case ^{OA}	98
Topcase ^{OA}	101
Luggage carrier	104

General instructions

BMW Motorrad recommends the use of parts and accessories for your motorcycle that are approved by BMW for this purpose. Genuine BMW parts and accessories and other products which BMW has approved can be obtained from your authorised BMW Motorrad dealer, together with expert advice on their installation and use.

These parts and products have been tested by BMW for safety, function and suitability. BMW accepts product liability for them. Conversely, BMW is unable to accept any liability whatsoever for parts and accessories which it has not approved.

Also bear in mind the information on the effect of wheel size on suspension-control systems (► 118).



BMW Motorrad cannot assess each non-BMW product to determine whether it can be used on or in connection with BMW motorcycles without constituting a safety hazard. Country-specific official authorisation does not suffice as assurance. Tests conducted by these instances cannot make provision for all operating conditions experienced by BMW motorcycles and, consequently, they are not sufficient in some circumstances.

Use only parts and accessories approved by BMW for your motorcycle. ◀

Whenever you are planning modifications, comply with all the legal requirements. Make sure that the motorcycle does not infringe national road-vehicle construction and use regulations.

Power socket Ratings



The supply to socket **1** is cut off automatically if battery voltage is low or the load exceeds the maximum rating.

Operating electrical accessories

You can start using electrical accessories only when the ignition is switched on. The accessory remains operational if the ignition is subsequently switched off. In order to ensure that the drain on the on-board power supply sys-

tem is minimised, the supply to the power socket is cut off approximately 15 minutes after the ignition is switched off, and it is also temporarily interrupted during the start procedure.

Cable routing

The cables from the power socket to the auxiliary device must be routed in such a way that they:

- do not impede the rider
- do not restrict or obstruct the steering angle and handling characteristics
- cannot be trapped

 Incorrectly routed cables can impede the rider. Route the cables as described above. ◀

Auxiliary headlights^{OA}



- Press the left half of switch **1**.
 - » Auxiliary headlights switched on.
- Press the right half of switch **1**.
 - » Auxiliary headlights switched off.

Luggage

Correct loading

 Overloading and imbalanced loads can adversely affect the motorcycle's handling. Do not exceed the permissible gross weight and be sure to

comply with the instructions on loading. ◀

- Set spring preload, damping characteristic and tyre pressures to suit total weight.
 - with case^{OA}
- Ensure that the case volumes on the left and right are equal.
- Make sure that the weight is uniformly distributed between right and left.
- Pack heavy items at the bottom and toward the inboard side.
- Note the maximum permissible payload of the cases and the speed limit for riding with cases on the motorcycle.

 Payload of cases
- ≤10 kg



Maximum permissible speed for riding with cases fitted to the motorcycle

– ≤ 180 km/h \triangleleft

– with topcase ^{OA}

- Note the maximum permissible payload of the topcase and the speed limit for riding with a topcase on the motorcycle.



Payload of topcase

– ≤ 5 kg



Maximum permissible speed for riding with topcase fitted to the motorcycle

– ≤ 180 km/h \triangleleft

– with tank rucksack ^{OA}

- Note the maximum permissible payload of the tank rucksack and the speed limit for riding

with a tank rucksack on the motorcycle.



Payload of tank rucksack

– ≤ 5 kg



Maximum permissible speed for riding with the tank rucksack fitted to the motorcycle

– ≤ 130 km/h \triangleleft

Case ^{OA}

Opening cases

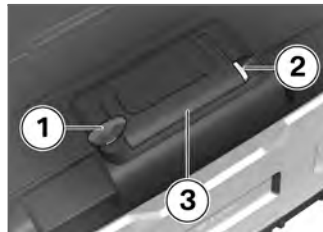

- Turn key **1** in the case lock to right angles with the forward direction of travel.
- Hold down latch **2** and pull up carry handle **3**.



- Press the ribbed part of rocker button **4**.
- Hold the rocker button down and open the lid of the case.

Closing cases

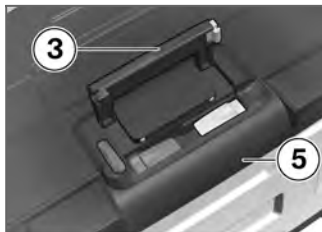

- Turn the lock with the key until it is at right angles to the forward direction of travel.
- Close case lid **5**.
 - » The lid engages with an audible click.

 Closing the carry handle while the case lock is in line with the forward direction of travel can result in damage to the locking tongue.

Make sure that the case lock is at right angles to the forward direction of travel when you close the carry handle.◀

- Push carry handle **3** down.
 - » The handle engages with an audible click.
- Turn the key in the case lock in line with the forward direction of travel and remove the key from the lock.

Adjusting case volume

- Open the case.
- Remove all its contents from the case.



- To change the volume of the case, engage pivot lever **1** at the top or bottom limit position, as applicable.

- » Pivot lever at top limit position: minimum volume.
- » Pivot lever at bottom limit position: maximum volume.

Removing cases

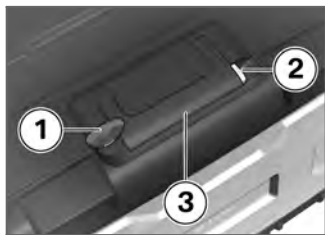

- Turn key **1** in the case lock to right angles with the forward direction of travel.
- Hold down latch **2** and pull up carry handle **3**.



- Open locking lever **4**.

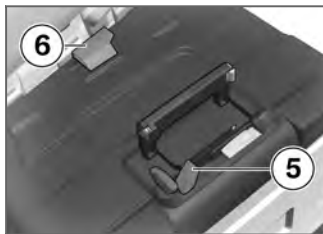

- Pull red release lever **5** up.
 - » Latching flap **6** pops up.
- Fully open the latching flap.

- Take a firm grip of the handle and lift the case out of the holder.

Installing cases

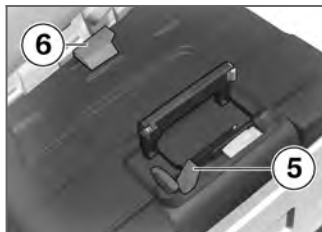

- Pull red release lever **5** up.
 - » Latching flap **6** pops up.
- Fully open the latching flap.
- Hold the case straight and lower it into the top holder.
- Push the red release lever down, while pressing on the latching flap.
 - » The latching flap engages.



- Close locking lever **4**.
- Close the carry handle.
- Turn the lock with the key until it is in line with the forward direction of travel and remove the key.

Topcase^{OA}

Topcase and off-roading

If you intend off-roading, it is advisable either to remove the topcase or secure it with the Enduro attachment kit available from your authorised BMW Motorrad dealer.

Opening topcase

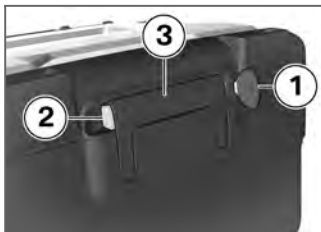

- Turn key **1** in the topcase lock until it is at right angles to the road surface.
- Hold down latch **2** and pull out carry handle **3**.



- Press the ribbed part of rocker button **4**.
- Hold the rocker button down and open the lid of the topcase.

Closing topcase



- Turn the key in the topcase lock until it is at right angles to the road surface.
- Close topcase lid **5**.
- » The lid engages with an audible click.



Closing the carry handle while the topcase lock is vertical can result in damage to the locking tongue. Make sure that the topcase lock is horizontal when you close the carry handle. ◀

- Push carry handle **3** up.

- » The handle engages with an audible click.
- Turn the key in the topcase lock until it is parallel with the road surface and remove the key.

Removing topcase

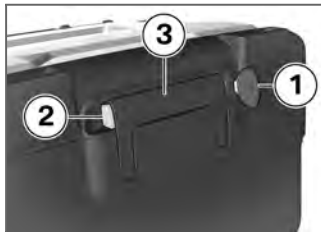

- Turn key **1** in the topcase lock until it is at right angles to the road surface.
- Hold down latch **2** and pull out carry handle **3**.



- Pull red lever **4**.
- » Latching flap **5** is unlocked.
- Fully open latching flap **5** with your hand.
- Take a firm grip of the handle and remove the topcase.

Installing topcase

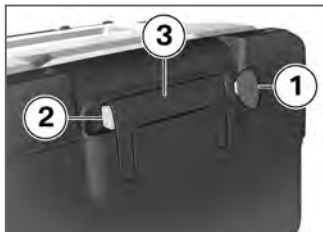

- Turn key **1** in the topcase lock until it is at right angles to the road surface.
- Hold down latch **2** and pull out carry handle **3**.



- Pull red lever **4**.
» Latching flap **5** is unlocked.
- Fully open latching flap **5** with your hand.

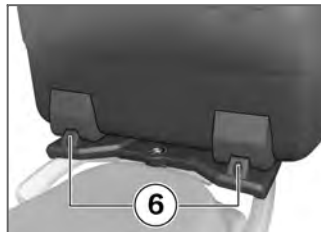

- Engage the topcase in front holders **6** of the topcase carrier plate.



- Push the rear of the topcase onto the topcase carrier plate and engage latching flap **5**.

- Push red lever **4** in.
- » Latching flap **5** is secured.
- Check that the topcase is secure.
- Close the carry handle and lock the topcase.

Adjusting topcase volume



- Open the topcase.
- Remove all its contents from the topcase.
- To adjust the volume of the topcase, engage pivot lever **1** at the front or rear limit position, as applicable.

- » Pivot lever at rear limit position: minimum volume.
- » Pivot lever at front limit position: maximum volume.

Luggage carrier Extra-large luggage platform

By removing the luggage carrier with the rear seat removed and cases (OA) installed, you have a large, flat luggage platform to which you can secure bulky items of luggage in various ways. When loading, make sure that the total weight of the objects in and on the cases does not exceed the permissible maximum for the cases.

Removing luggage carrier

- Make sure the ground is level and firm and place the motorcycle on its stand.
- Remove the rear seat (➡ 69)

– with case^{OA}

- Remove the cases (➡ 100)

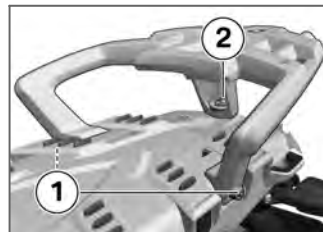

- Remove screws **1** on left and right.
- Remove screw **2**.
- Remove the sleeves and washers.
- Remove the luggage carrier.

Installing luggage carrier

- Make sure the ground is level and firm and place the motorcycle on its stand.

– with case^{OA}

- Remove the cases (➡ 100)

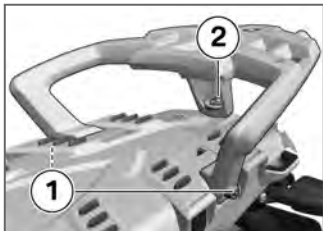

- Place the luggage rack in position.
- Install screw **2** with the sleeve and the washer.
- Install screws **1** on left and right, complete with their sleeves and washers.
- Install the rear seat (➡ 71)

Maintenance

General instructions.....	108
Toolkit	108
Engine oil	109
Brake system	111
Brake pads	111
Brake fluid	114
Clutch	116
Tyres	117
Rims.....	117
Wheels	118
Front-wheel stand	124
Bulbs	125
Air filter	132
Jump starting.....	134
Battery.....	135

General instructions

The Maintenance chapter describes straightforward procedures for checking and replacing certain wear parts.

Special tightening torques are listed as applicable. The tightening torques for the threaded fasteners on your motorcycle are listed in the section entitled "Technical data".

You will find information on more extensive maintenance and repair work in the Repair Manual on DVD for your motorcycle, which is available from your authorised BMW Motorrad dealer.

Some of the work calls for special tools and a thorough knowledge of motorcycle technology. If you are in doubt consult a specialist workshop, preferably your authorised BMW Motorrad dealer.

Toolkit

Toolkit

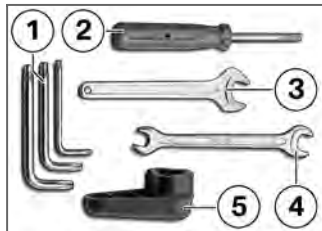

- 1** Torx wrenches T15, T25, T30
- 2** Reversible-blade screwdriver with star-head and plain tips
- 3** Open-ended spanner
Width across flats 14
- 4** Open-ended spanner
Width across flats 8/10
- 5** Tool for oil cap
For opening the oil filler cap

Toolkit for adjusting suspension without ESA

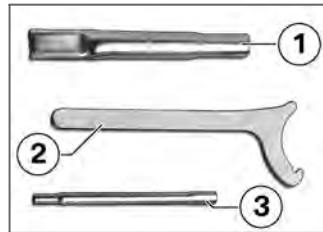

- 1** Extension for hook wrench
- 2** Hook wrench
For adjusting spring preload
- 3** Extension for screwdriver blade

On-board toolkit service kit^{OA}

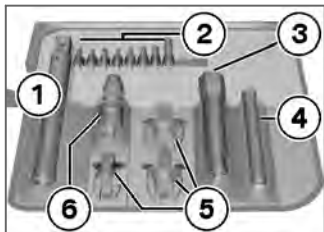

- 1 Extending tool holder holds all tools by means of adapters, and for removing the spark plug
- 2 1/4" bits
Bits of various sizes
- 3 3/8" adapter for socket-head screws, w/f 22 for removing the quick-release axle from the front wheel
- 4 Electric torch

- 5 Socket
Open-ended spanners of various sizes
- 6 Adapter
To accommodate the 1/4" bits and the 9x12 mm and the 3/8" universal-joint adapter

Engine oil

Checking engine oil level

 The engine can seize if the oil level is low, and this can lead to accidents.

Always make sure that the oil level is correct. ◀

 The oil level varies with the temperature of the oil. The higher the temperature, the higher the level of oil in the sump. Checking the oil level with the engine cold or after no more than a short ride will lead to misinterpretation; this in turn, means that

the engine will be operated with the incorrect quantity of oil. In order to ensure that the engine oil level is read correctly, check the oil level only after a lengthy trip. ◀

- Check that the engine is at operating temperature, make sure the ground is level and firm and place the motorcycle on its centre stand.
- Wait five minutes after switching off the engine at operating temperature.



- Check the oil level in oil-level indicator **1**.

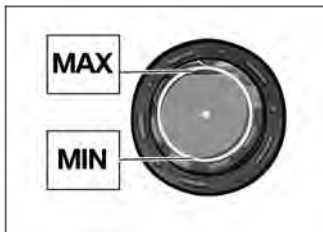

Engine oil level

– max 0.5 l (Difference between MIN and MAX)

If the oil level is below the MIN mark:

- Top up the engine oil (110)

If the oil level is above the MAX mark:

- Have the oil level corrected by a specialist workshop, preferably an authorised BMW Motorrad dealer.

Topping up engine oil

- Make sure the ground is level and firm and place the motorcycle on its stand.

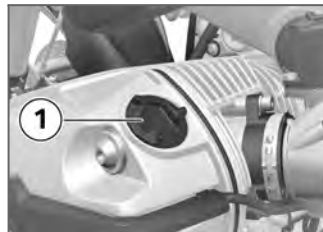

- Wipe the area around the filler neck clean.
- Use the tool from the toolkit to remove cap **1** from the engine-oil filler neck.



Damage to the engine can result if it is operated without enough oil, but the same also applies if the oil level is too high.

Always make sure that the oil level is correct. ◀

- Top up the engine oil to the specified level.



Engine oil, quantity for topping up

– max 0.5 l (Difference between MIN and MAX)

- Check the engine oil level (➡ 109)
- Install the cap of the oil filler neck.

Brake system

Dependability of the brake system

A fully functional brake system is a basic requirement for the road safety of your motorcycle.

Do not ride the motorcycle if you have any doubts about the dependability of the brake system. Under these circumstances have the brake system checked by a specialist workshop, preferably an authorised BMW Motorrad dealer.



Incorrect working practices endanger the reliability of the brakes.

Have all work on the brake system performed by a specialist workshop, preferably an authorised BMW Motorrad dealer. ◀

Checking operation of brakes

- Pull the handbrake lever.
 - » The pressure point must be clearly perceptible.
- Press the footbrake lever.
 - » The pressure point must be clearly perceptible.

If pressure points are not clearly perceptible:

- Have the brakes checked by a specialist workshop, preferably an authorised BMW Motorrad dealer.

Brake pads

Checking front brake pad thickness



Brake pads worn past the minimum permissible thickness can cause a reduction in braking efficiency and under certain circumstances they can cause damage to the brake system.

In order to ensure the dependability of the brake system, do not permit the brake pads to wear past the minimum permissible thickness. ◀

- Make sure the ground is level and firm and place the motorcycle on its stand.



- Visually inspect the left and right brake pads to ascertain their thickness. Viewing direction: Between wheel and fork tube toward brake caliper **1**.

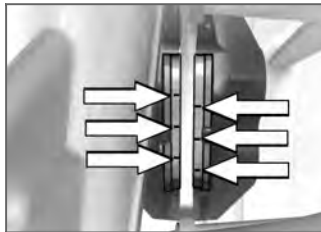

Brake-pad wear limit,
front

- min 1.0 mm (Friction pad only, without backing plate. The wear indicators (grooves) must be clearly visible.)

If the wear indicating mark is no longer clearly visible:

- Have the brake pads replaced by a specialist workshop, preferably an authorised BMW Motorrad dealer.

Checking rear brake pad thickness



Brake pads worn past the minimum permissible thickness can cause a reduction in braking efficiency and under certain circumstances they can cause damage to the brake system.

In order to ensure the dependability of the brake system, do not permit the brake pads to wear past the minimum permissible thickness. ◀

- Make sure the ground is level and firm and place the motorcycle on its stand.

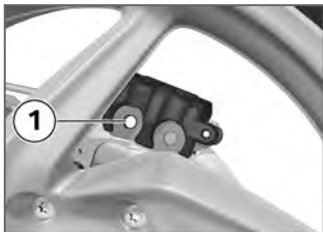

- Visually inspect brake pads **1** from the left to ascertain their thickness.

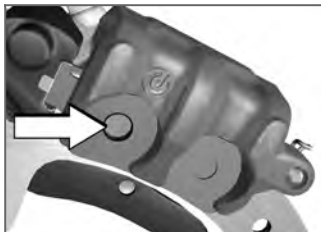

Brake-pad wear limit, rear

- 1.0 mm (Friction pad only, without backing plate. Make sure that the brake disc is not visible through the bore in the inboard brake block.)

If the brake disc is visible:

- Have the brake pads replaced by a specialist workshop, preferably an authorised BMW Motorrad dealer.

Brake-pad wear

The rear brake has a brake-pad wear indicator.

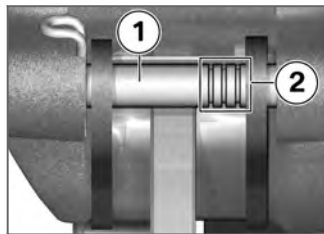

Shaft **1** with three marker rings **2** is between the brake pads.

How to interpret the marks:

- Three rings visible: brake-pad thickness is at least 75 %
- Two rings visible: brake-pad thickness is at least 50 %
- One ring visible: brake-pad thickness is at least 25 %
- No rings visible: brake pads worn to wear limit; check as described above

Brake fluid

Checking brake-fluid level, front brakes

 A low fluid level in the brake reservoir can allow air to penetrate the brake system. This significantly reduces braking efficiency.

Check the brake-fluid level at regular intervals. ◀

- Make sure the ground is level and firm and place the motorcycle on its centre stand.
- Move the handlebars to the straight-ahead position.



- Check the brake fluid level in front reservoir **1**.

 The brake fluid level in the brake fluid reservoir drops as the brake pads wear. ◀



Brake fluid level, front

– DOT4 brake fluid

– It is impermissible for the brake fluid level to drop below the MIN mark. (Brake-fluid reservoir horizontal, motorcycle upright)

If the brake fluid level drops below the permitted level:

- Have the defect rectified as quickly as possible by a specialist workshop, preferably an authorised BMW Motorrad dealer.

Checking brake-fluid level, rear brakes



A low fluid level in the brake reservoir can allow air to penetrate the brake system. This significantly reduces braking efficiency.

Check the brake-fluid level at regular intervals. ◀

- Make sure the ground is level and firm and place the motorcycle on its centre stand.



- Check the brake fluid level in reservoir **1**.



Wear of the brake pads causes the brake fluid level in the reservoir to sink. ◀



Brake fluid level, rear

– DOT4 brake fluid

– It is impermissible for the brake fluid level to drop below the MIN mark. (Brake-fluid reservoir horizontal, motorcycle upright)

If the brake fluid level drops below the permitted level:

- Have the defect rectified as quickly as possible by a specialist workshop, preferably an authorised BMW Motorrad dealer.

Clutch

Checking clutch operation

- Pull the clutch lever.
 - » The pressure point must be clearly perceptible.
- If the pressure point is not clearly perceptible:

- Have the clutch checked by a specialist workshop, preferably an authorised BMW Motorrad dealer.

Checking clutch fluid level

- Make sure the ground is level and firm and place the motorcycle on its centre stand.
- Move the handlebars to the straight-ahead position.



- Check the clutch fluid level in reservoir **1**.
- ▶ Wear of the clutch causes the fluid level in the clutch fluid reservoir to rise.◀



Clutch-fluid level (visual inspection)

- It is impermissible for the clutch fluid level to drop. (Motorcycle upright and handlebars in straight-ahead position)

If the fluid level drops:



Unsuitable hydraulic fluids could cause damage to the clutch system.

Do not attempt to top up the system with fluids of any kind.◀

- Have the defect rectified as quickly as possible by a spe-

cialist workshop, preferably an authorised BMW Motorrad dealer.

Tyres

Checking tyre tread depth



Your motorcycle's handling and grip can be impaired even before the tyres wear to the minimum tyre tread depth permitted by law.

Have the tyres changed in good time before they wear to the minimum permissible tread depth.◀

- Make sure the ground is level and firm and place the motorcycle on its stand.
- Measure the tyre tread depth in the main tread grooves with wear marks.



Tyres have wear indicators integrated into the main tread grooves. The tyre is worn out when the tyre tread has worn

down to the level of the marks. The locations of the marks are indicated on the edge of the tyre, e.g. by the letters TI, TWI or by an arrow.◀

If the tyre tread is worn to minimum:

- Replace tyre or tyres, as applicable.

Top speed



The motorcycle's top speed might be higher than the maximum speed permitted for the tyres. Excessive speeds can damage the tyres and this could cause accidents.

Comply with the tyre-specific speed restrictions.◀

Always bear the maximum permissible top speed of the tyres in mind when riding a motorcycle fitted with massive-bar tyres.

Affix a label stating the maximum permissible speed in the rider's field of vision.

Rims

Checking rims

- Make sure the ground is level and firm and place the motorcycle on its stand.
- Visually inspect the rims for defects.
- Have damaged rims checked and, if necessary, replaced by a specialist workshop, preferably an authorised BMW Motorrad dealer.

Checking spokes^{OE}

- Make sure the ground is level and firm and place the motorcycle on its stand.
- Draw the handle of a screwdriver or a similar instrument across the spokes and listen

to the notes of the individual spokes.

If the notes vary:

- Have the spokes checked by a specialist workshop, preferably an authorised BMW Motorrad dealer.

Wheels

Tyre recommendation

For each size of tyre BMW Motorrad tests and classifies as roadworthy certain makes. BMW Motorrad cannot assess the suitability or provide any guarantee of road safety for other tyres. BMW Motorrad recommends using only tyres tested by BMW Motorrad.

You can obtain detailed information from your authorised BMW Motorrad dealer or on the Internet at www.bmw-motorrad.com.

Effect of wheel size on suspension-control systems

Wheel size is very important as a parameter for the suspension-control systems ABS and ASC. In particular, the diameter and the width of a motorcycle's wheels are programmed into the control unit and are fundamental to all calculations. Any change in these influencing variables, caused for example by a switch to wheels other than those installed ex-works, can have serious effects on the performance of the control systems.

The sensor rings are essential for correct road-speed calculation, and they too must match the motorcycle's control systems and consequently cannot be changed.

If you decide that you would like to fit non-standard wheels to your motorcycle, it is very import-

ant to consult a specialist workshop beforehand, preferably an authorised BMW Motorrad dealer. In some cases, the data programmed into the control units can be changed to suit the new wheel sizes.

RDC label^{OE}



 Incorrect tyre-removal procedures can result in damage to the RDC sensors. Be sure to notify the authorised BMW Motorrad dealer or specialist workshop that the wheel is fitted with an RDC sensor. ◀

If the motorcycle is equipped with RDC, each wheel rim bears an adhesive label indicating the position of the RDC sensor. When changing the tyre, take care not to damage the RDC sensor. Be sure to draw the attention of the authorised BMW Motorrad dealer or specialist workshop to the fact that the wheel is fitted with an RDC sensor.

Remove the front wheel

- Make sure the ground is level and firm and place the motorcycle on its centre stand.

– with BMW Motorrad Integral ABS II^{OE}



- Open the two retaining clips holding the ABS sensor cable to the brake line.◀
- Mask off the parts of the wheel rim that could be scratched in the process of removing the brake calipers.

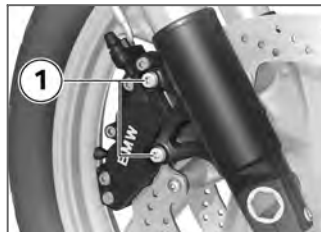

! Once the calipers have been removed, there is a risk of the brake pads being pressed together to the extent that they cannot be slipped back over the brake disc on reassembly. Do not operate the handbrake lever when the brake calipers have been removed.◀

- Remove securing screws **1** of the brake calipers on left and right.

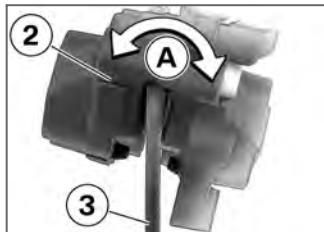

- Force the brake pads slightly apart by rocking brake calipers **2** back and forth **A** against brake discs **3**.
- Carefully pull the brake calipers back and out until clear of the brake discs.

– with BMW Motorrad Integral ABS II^{OE}



- Remove screw **1** and remove the ABS sensor from its bore.<
- Raise front of motorcycle until the front wheel can turn freely. BMW Motorrad recommends the BMW Motorrad front-wheel stand for lifting the motorcycle.
- Install the front-wheel stand (➔ 124)



- Release axle clamping screw **2**.
- Remove quick-release axle **3**, while supporting the wheel.
- Roll the front wheel forward to remove.

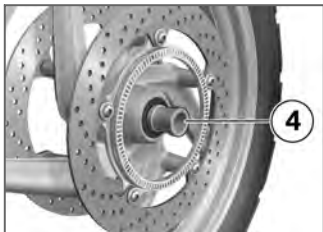

- Remove spacing bushing **4** from the left-hand side of the front-wheel hub.

Installing front wheel

 Possible malfunctions when ABS and ASC systems intervene if non-standard wheels are installed.

See the information on the effect of wheel size on the ABS and ASC systems at the start of this chapter. ◀

 Threaded fasteners not tightened to the specified

torque can work loose or their threads can suffer damage. Always have the security of the fasteners checked by a specialist workshop, preferably an authorised BMW Motorrad dealer. ◀

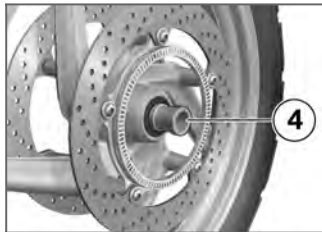

- Slip spacing bushing **4** into the wheel hub on the left-hand side.

 The front wheel must be installed right way round to rotate in the correct direction.

Note the direction-of-rotation arrows on the tyre or the wheel rim. ◀

- Roll the front wheel into position between the front forks.



- Raise the front wheel, insert quick-release axle **3** and tighten to specified torque.



Quick-release axle in axle holder

– 50 Nm

- Tighten axle clamping screw **2** to the specified torque.



Clamp screw of quick-release axle

– 19 Nm

– with BMW Motorrad Integral ABS II^{OE}



- Insert the ABS sensor into its bore and install screw **1**.◀
- Remove the front-wheel stand.
- Ease the brake calipers on to the brake discs.

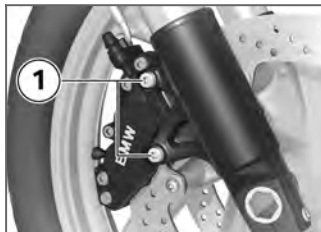

- Install securing screws **1** on left and right and tighten to specified tightening torque.



Brake caliper to slider tube

– 30 Nm

- Remove the adhesive tape from the wheel rim.



Braking efficiency is impaired if the brake pads are not correctly bedded against the discs.

Before riding off, always check that the brakes bite as soon as

the brake lever is pulled or the brake pedal depressed.◀

- Operate the brake several times until the brake pads are bedded.

– with BMW Motorrad Integral ABS II^{OE}



- Close the retaining clips holding the ABS sensor cable to the brake line.



The cable of the ABS sensor could chafe through if it comes into contact with the brake disc.

Make sure that the ABS sensor cable is routed correctly.◀

- Make sure that the ABS sensor cable is routed as shown here.◀

Removing rear wheel

- Make sure the ground is level and firm and place the motorcycle on its centre stand.
- Engage first gear.

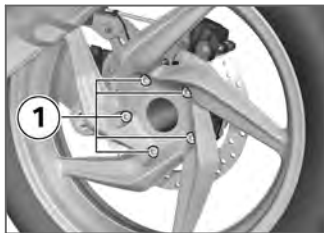

! Parts of the exhaust system can be hot.

Do not touch hot parts of the exhaust system.◀

- Remove studs **1** from the rear wheel, while supporting the wheel.
- Roll the rear wheel out toward the rear.

Installing rear wheel

! Possible malfunctions when ABS and ASC systems intervene if non-standard wheels are installed.

See the information on the effect of wheel size on the ABS and ASC systems at the start of this chapter.◀

! Threaded fasteners not tightened to the specified torque can work loose or their threads can suffer damage. Always have the security of the fasteners checked by a specialist workshop, preferably an authorised BMW Motorrad dealer.◀

- Seat the rear wheel on the rear-wheel adapter.

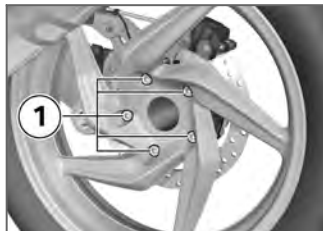

! The wheel studs for the cross-spoked wheel (optional extra) and the cast aluminium wheel differ in length. Mixing up sets of studs or using the wrong studs would mean that the rear wheel would not be correctly secured and this, in turn, could result in an accident. Use only wheel studs with the same, approved length code. Do not oil or grease wheel studs.◀

- Install wheel studs **1** and tighten to specified torque.

 Rear wheel to wheel carrier
– Tightening sequence: Tighten in diagonally opposite sequence
– 60 Nm
– with cross-spoked wheels ^{OE}
– Tightening sequence: Tighten in diagonally opposite sequence
– 60 Nm<

Front-wheel stand

Installing front-wheel stand

 The BMW Motorrad front wheel stand is not designed to support motorcycles not fitted with a centre stand or without other auxiliary stands. A motorcycle resting only on the front

wheel stand and the rear wheel can topple.

Place the motorcycle on its centre stand or another auxiliary stand before lifting the front wheel with the BMW Motorrad front-wheel stand. ◀

- Make sure the ground is level and firm and place the motorcycle on its centre stand.
- Use basic stand with tool number (0 402 241) in combination with front-wheel adapter (0 402 242).

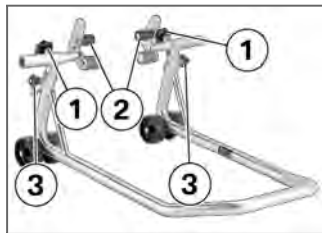

- Slacken adjusting screws **1**.

- Push the two adapters **2** apart until the front forks fit between them.
- Use locating pins **3** to set the front-wheel stand to the desired height.
- Centre the front-wheel stand relative to the front wheel and push it against the front axle.

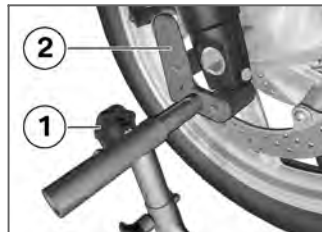

- Align the two adapters **2** so that the front forks are securely seated.
- Tighten adjusting screws **1**.



! If the motorcycle is on the centre stand and is raised too far, the centre stand will lift clear of the ground and the motorcycle could topple to one side. When raising the motorcycle, make sure that the centre stand remains on the ground. ◀

- Apply uniform pressure to push the front-wheel stand down and raise the motorcycle.

Bulbs

General instructions

A warning appears in the multi-function display if a bulb is defective. If the brake or rear light fails, the symbol is accompanied by the 'General' warning light, which lights up yellow.

! A defective bulb places your safety at risk because it is easier for other users to oversee the motorcycle. Replace defective bulbs as soon as possible; always carry a complete set of spare bulbs if possible. ◀

! The bulb is pressurised and can cause injury if damaged. Wear protective goggles and gloves when changing bulbs. ◀

▶ The types of bulb fitted to your motorcycle are listed

in the section entitled "Technical data". ◀

▶ Do not touch the glass of new bulbs with your fingers. Use a clean, dry cloth to hold the bulbs when handling them. Dirt deposits, in particular oil and grease, interfere with heat radiation from the bulb. This leads to overheating and shortens the bulb's operating life. ◀

Replacing low-beam/high-beam headlight bulb

▶ The plug and the spring clip might face in a direction other than that shown here. ◀

! If it is not standing firmly, the motorcycle could topple in the course of the operations described below. Always make sure that the motorcycle is stable and firmly supported. ◀

- Make sure the ground is level and firm and place the motorcycle on its stand.
- Switch off the ignition.
- Turn the handlebars to the full-lock position.

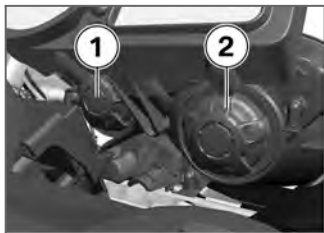

- Turn cover **1** for high-beam headlight counter-clockwise and remove it.
- Turn cover **2** for low-beam headlight counter-clockwise and remove it.



- Disconnect plug **3**.

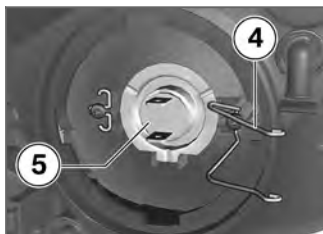

- Release spring clips **4** at top and bottom and swing them aside.
- Remove bulb **5**.

- Replace the defective bulb.



Bulb for low-beam headlight

– H7 / 12 V / 55 W



Bulb for high-beam headlight

– H7 / 12 V / 55 W

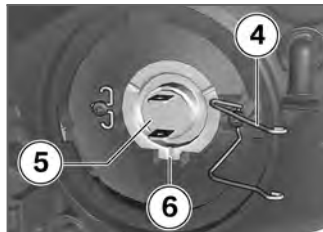

- Install bulb **5**, making sure that tab **6** is correctly positioned.

▶ The bulb might face in a direction other than that shown here. ◀

- Engage spring clip **4** in the catch.



- Install plug **3**.

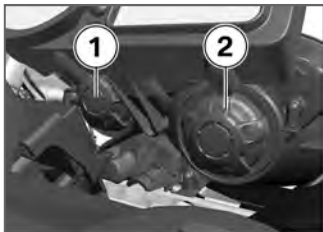

- Turn cover **1** for high-beam headlight clockwise to install.

Make sure that the wording TOP is at the top.

- Turn cover **2** for low-beam headlight clockwise to install. Make sure that the wording TOP is at the top.

Replacing parking-light bulb

! If it is not standing firmly, the motorcycle could topple in the course of the operations described below.

Always make sure that the motorcycle is stable and firmly supported. ◀

- Make sure the ground is level and firm and place the motorcycle on its stand.
- Switch off the ignition.
- Turn the handlebars all the way to right



- Pull bulb carrier **1** out of the headlight housing.



- Pull the bulb out of the bulb socket.

- Replace the defective bulb.



Bulb for parking light

– W5W / 12 V / 5 W



- Install the bulb in the bulb socket.



- Install bulb carrier **1** in the headlight housing.

Replacing turn indicator bulbs, front and rear



If it is not standing firmly, the motorcycle could topple in the course of the operations described below.

Always make sure that the motorcycle is stable and firmly supported. ◀

- Make sure the ground is level and firm and place the motorcycle on its stand.



- Remove screw **1**.

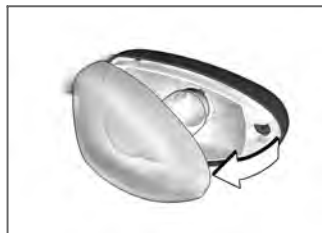

- Pull the glass out of the reflector housing at the threaded-fastener side.

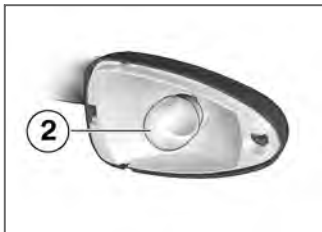

- Turn bulb **2** counter-clockwise and remove it from the bulb housing.
- Replace the defective bulb.



Bulbs for flashing turn indicators, front

– RY10W / 12 V / 10 W



Bulbs for flashing turn indicators, rear

– RY10W / 12 V / 10 W

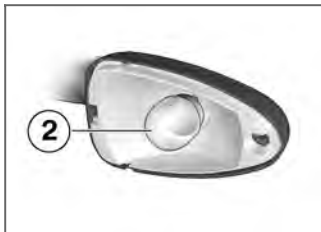

- Turn bulb **2** clockwise to install it in the bulb housing.

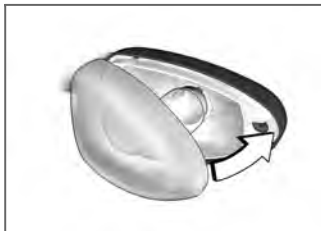

- Working from the inboard side, insert the glass into the bulb housing and close the housing.



- Install screw **1**.

Replacing auxiliary-headlight bulbs^{OA}

 If it is not standing firmly, the motorcycle could topple in the course of the operations described below.

Always make sure that the motorcycle is stable and firmly supported. ◀

- Make sure the ground is level and firm and place the motorcycle on its stand.



- Disconnect plug **1**.
- Remove screw **2**.
- Remove the headlight housing.

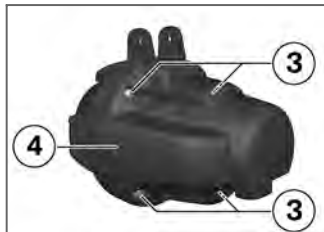

- Remove four screws **3**.
- Remove bulb cover **4**.



- Turn bulb **5** counter-clockwise to remove.
- Replace the defective bulb.

	Bulb for auxiliary headlight
- with auxiliary headlights ^{OA}	
- H11 / 12 V / 55 W<	



- Insert bulb **5** into its socket and turn it clockwise to install.

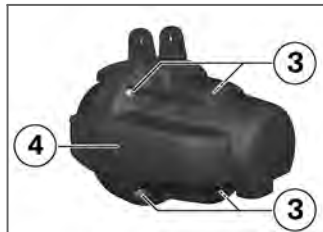

- Hold bulb cover **4** in position.
- Install four screws **3**.



- Hold the headlight in position and install screw **2**.
- Connect plug **1**.
- Adjust the headlight so that it does not dazzle oncoming traffic.

Replacing fuses for auxiliary headlights^{OA}

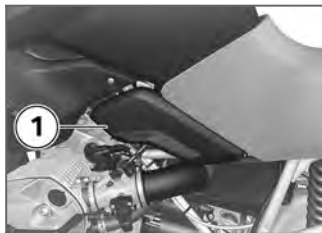

- Pull off side cover **1**.

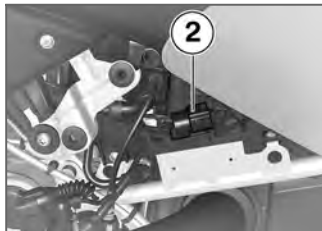

- Disconnect plug **2**.



- To do so, squeeze retaining clips **3** together on left and right and disconnect the plug.

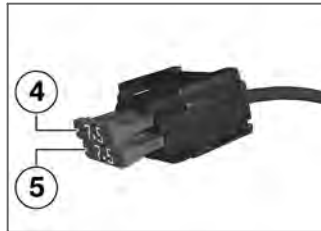

- Replace fuse **4** for right headlight or fuse **5** for left headlight, as applicable.



Fuse plug for auxiliary headlight

– with auxiliary headlights^{OA}

– 7.5 A<

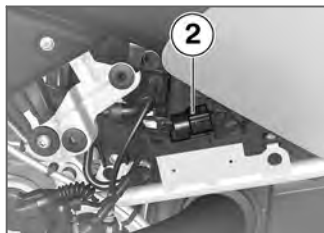

- Connect plug **2**.

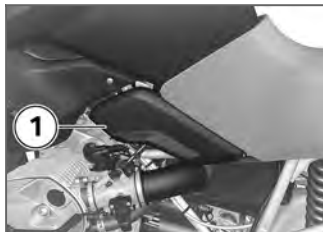

- Install side cover **1**.

Air filter

Remove the air filter

- Make sure the ground is level and firm and place the motor-cycle on its stand.
- Remove the front seat (➔ 70)



- Pull off side cover **1**.

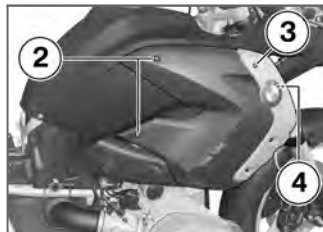

- Remove two screws **2** and screw **3**.
- Pull the side panel at **4** out of the retainer and remove.



- Remove two screws **5** and work the fuel-tank cover down to remove.



- Push out both retainers **1** by pressing at rear.
- Pull the intake air pipe out of holder **2** and remove.



- Pull out air filter **3** at the bottom.

Installing air filter

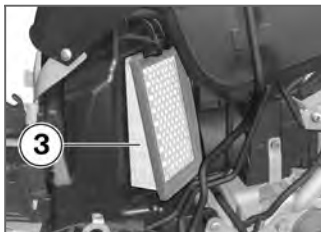

- Insert air filter **3** into the air filter housing at the top.

- Push the air filter into the air filter housing at the bottom, making sure that the vanes are not bent.



- Position the air intake pipe on the air filter housing and push it into holder **2**.
- Push retainers **1** into the holders until they engage with an audible click.



- Check that the throttle-valve cable is seated in guide **4** of the intake and that the throttle valve is seated against the stop.



- Hold the fuel-tank cover in position and install two screws **5**.

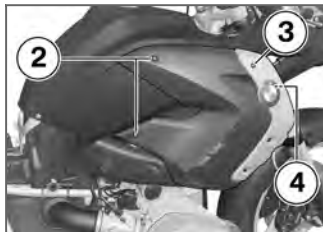

- Press the side panel at **4** into the retainer.
- Install two screws **2** and screw **3**.



- Push side cover **1** into the two mounts.
- Install the front seat (➡ 70)

Jump starting

⚠ The wires leading to the power socket do not have a load-capacity rating adequate for jump-starting the engine. Excessively high current can lead to a cable fire or damage to the vehicle electronics.

Do not use the on-board socket to jump-start the engine of the motorcycle. ◀

⚠ Touching live parts of the ignition system with the engine running can cause electric shock.

Do not touch parts of the ignition system when the engine is running. ◀

⚠ A short-circuit can result if the crocodile clips of the jump leads are accidentally brought into contact with the motorcycle.

Use only jump leads fitted with

fully insulated crocodile clips at both ends. ◀



Jump-starting with a donor-battery voltage higher than 12 V can damage the vehicle electronics.

Make sure that the battery of the donor vehicle has a voltage rating of 12 V. ◀



If it is not standing firmly, the motorcycle could topple in the course of the operations described below.

Always make sure that the motorcycle is stable and firmly supported. ◀

- Make sure the ground is level and firm and place the motorcycle on its stand.
- Remove the front seat (➡ 70)
- When jump-starting the engine, do not disconnect the battery from the on-board electrical system.

- Remove the protective cap from the battery's positive terminal.
- Begin by connecting one end of the red jump lead to the positive terminal of the discharged battery and the other end to the positive terminal of the donor battery.
- Then connect one end of the black jump lead to the negative terminal of the donor battery, and the other end to the negative terminal of the discharged battery.

▶ | The spring-strut screw can be used as an alternative to the battery's negative terminal. ◀

- Run the engine of the donor vehicle during jump-starting.
- Start the engine of the vehicle with the discharged battery in the usual way; if the engine does not start, wait a few minutes before repeating the

attempt in order to protect the starter motor and the donor battery.

- Allow both engines to idle for a few minutes before disconnecting the jump leads.
- Disconnect the jump lead from the negative terminals first, then disconnect the second lead from the positive terminals.
- Remember to reinstall the protective cap on the battery's positive terminal.

▶ Do not use proprietary start-assist sprays or other products to start the engine. ◀

- Install the front seat (➡ 70)

Battery

Maintenance instructions

Correct upkeep, recharging and storage will prolong the life of the battery and are essential if

warranty claims are to be considered.

Compliance with the points below is important in order to maximise battery life:

- Keep the surface of the battery clean and dry
- Do not open the battery
- Do not top up with water
- Be sure to read and comply with the instructions for charging the battery on the following pages
- Do not turn the battery upside down

 If the battery is not disconnected, the on-board electronics (e.g. clock, etc.) gradually drain the battery. This can cause the battery to run flat. If this happens, warranty claims will not be accepted.

If the motorcycle is to be out of use for more than four weeks, disconnect the battery or con-

nect a suitable trickle charger to the battery. ◀

 BMW Motorrad has developed a float charger specially designed for compatibility with the electronics of your motorcycle. Using this charger, you can keep the battery charged during long periods of disuse, without having to disconnect the battery from the motorcycle's on-board systems. You can obtain additional information from your authorised BMW Motorrad dealer. ◀

Charging battery when connected

 Charging the connected battery directly at the battery terminals can damage the vehicle electronics.

Always disconnect the battery from the on-board circuits before recharging it with a charger

connected directly to the battery posts. ◀

 If you switch on the ignition and the multifunction display and telltale lights fail to light up, the battery is completely flat. Attempting to charge a completely flat battery via the on-board socket can cause damage to the motorcycle's electronics. If a battery has discharged to the extent that it is completely flat, it has to be disconnected from the on-board circuits and charged with the charger connected directly to the battery posts. ◀

 Only chargers suitable for this mode of charging can be used to recharge the battery via the on-board socket. Unsuitable chargers could cause damage to the motorcycle's on-board electrics. Use BMW chargers with the part numbers 71 60 7 688 864

(220 V) or, as applicable, 71 60 7 688 865 (110 V). If you are in doubt, disconnect the battery from the on-board systems and connect the charger directly to the battery.◀

- Charge via the power socket, with the battery connected to the motorcycle's on-board electrical system.

▷ The motorcycle's on-board electronics know when the battery is fully charged. The on-board socket is switched off when this happens.◀

- Comply with the operating instructions of the charger.

▷ If you are unable to charge the battery through the on-board socket, you may be using a charger that is not compatible with your motorcycle's electronics. If this happens, disconnect the battery from the on-board

systems and connect the charger directly to the battery.◀

Charging battery when disconnected

- Charge the battery using a suitable charger.
- Comply with the operating instructions of the charger.
- Once the battery is fully charged, disconnect the charger's terminal clips from the battery terminals.

▷ The battery has to be recharged at regular intervals in the course of a lengthy period of disuse. See the instructions for caring for your battery. Always fully recharge the battery before restoring it to use◀

Removing battery

 If it is not standing firmly, the motorcycle could topple in the course of the operations described below.

Always make sure that the motorcycle is stable and firmly supported.◀

- Make sure the ground is level and firm and place the motorcycle on its stand.
- Switch off the ignition.
- Remove the front seat (➔ 70)
- Remove the rider's manual, if applicable.

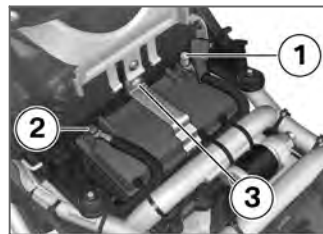

 Disconnection in the wrong sequence increases the risk of short-circuits. Always proceed in the correct sequence.◀

- Disconnect negative battery lead **2** first.
- Then pull back the protective cap and disconnect positive lead **1**.
- Remove screw **3**, disengage the retaining strap at the bottom and remove.
- Lift the battery up and out; work it slightly back and forth if it is difficult to remove.

Installing battery

- Place the battery in the battery compartment, positive terminal on the right in the forward direction of travel.

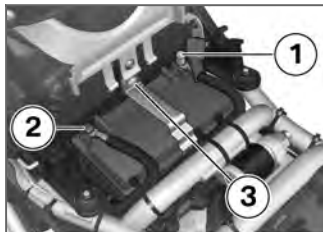

- Engage the retainer at the bottom, push it over the battery and install screw **3**.
- !** Installation in the wrong sequence increases the risk of short-circuits. Always proceed in the correct sequence. Never install the battery without the protective cap.◀
- Connect battery positive lead **1** first.
 - Fit the protective cap to the positive terminal of the battery.
 - Then connect battery negative lead **2**.

▶ If the battery was disconnected from the motorcycle for a prolonged period of time it will be necessary to enter the current date in the instrument panel, in order to ensure that the service-due indicator functions correctly.

If you want to have the date set consult a specialist workshop, preferably an authorised BMW Motorrad dealer.◀

- Insert the rider's manual, if applicable.
- Install the front seat (➡ 70)
- Set the clock (➡ 46)

Care

Care products	140
Washing motorcycle	140
Cleaning easily damaged components.....	140
Paint care.....	142
Protective wax coating	142
Laying up motorcycle	142
Restoring motorcycle to use	142

Care products

BMW Motorrad recommends that you use the cleaning and care products you can obtain from your authorised BMW Motorrad dealer. The substances in BMW CareProducts have been tested in laboratories and in practice; they provide optimised care and protection for the materials used in your vehicle.

 The use of unsuitable cleaning and care products can damage vehicle components. Do not use solvents such as cellulose thinners, cold cleaners, fuel or the like, and do not use cleaning products that contain alcohol.◀

Washing motorcycle

BMW Motorrad recommends that you use BMW insect remover to soften and wash off insects and stubborn dirt on

painted parts prior to washing the motorcycle.

To prevent stains, do not wash the motorcycle immediately after it has been exposed to strong sunlight and do not wash it in the sun.

Make sure that the motorcycle is washed frequently, especially during the winter months.

To remove road salt, clean the motorcycle with cold water immediately after every trip.

 After the motorcycle has been washed, ridden through water or ridden in the rain, the brake discs and pads might be wet and the brakes might not take effect immediately.

Apply the brakes in good time until the brakes have dried out.◀

 Warm water intensifies the effect of salt.

Use only cold water to wash off road salt.◀

 The high pressure of steam cleaners can damage seals, the hydraulic brake system, the electrical system, and the seat. Do not use a steam jet or high-pressure cleaning equipment.◀

Cleaning easily damaged components

Stainless-steel covers

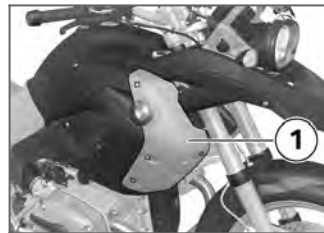

Use only proprietary motorcycle cleaning products or stainless-steel cleaning products to clean

left and right stainless-steel covers **1**.

 If the stainless-steel covers are cleaned using unsuitable cleaning agents, the surfaces can be damaged.

Do not use scouring agents such as a stainless-steel polish to clean the stainless-steel covers.

Even fly-remover pads or cleaning pads with hard surfaces can produce scratches. ◀

Plastics

Clean plastic parts with water and BMW plastic care emulsion. This includes in particular:

- Windscreen and slipstream deflectors
- Headlight lens made of plastic
- Glass cover of the instrument cluster
- Black, unpainted parts

 If plastic parts are cleaned using unsuitable cleaning agents, the surfaces can be damaged.

Do not use cleaning agents that contain alcohol, solvents or abrasives to clean plastic parts.

Even fly-remover pads or cleaning pads with hard surfaces can produce scratches. ◀

 Soften stubborn dirt and insects by covering the affected areas with a wet cloth. ◀

Windscreen

Clean off dirt and insects with a soft sponge and plenty of water.

 Fuel and chemical solvents attack the material of the windscreen; the windscreen becomes opaque or dull.

Do not use cleaning agents. ◀

Chrome

Use plenty of water and BMW shampoo to clean chrome, particularly if it has been exposed to road salt. Use chrome polish for additional treatment.

Radiator

Clean the radiator regularly to prevent overheating of the engine due to inadequate cooling. For example, use a garden hose with low water pressure.

 Cooling fins can be bent easily.

Take care not to bend the fins when cleaning the radiator. ◀

Rubber

Treat rubber components with water or BMW rubber-care products.

 Using silicone sprays for the care of rubber seals can cause damage.

Do not use silicone sprays or other care products that contain silicon.◀

Paint care

Washing the motorcycle regularly will help counteract the long-term effects of substances that damage the paint, especially if your motorcycle is ridden in areas with high air pollution or natural sources of dirt, for example tree resin or pollen.

Remove particularly aggressive substances immediately, however, as otherwise the paint can be affected or become discoloured. Substances of this nature include spilt fuel, oil, grease, brake fluid and bird droppings. We recommend BMW vehicle polish or BMW paint cleaner for this purpose.

Marks on the paintwork are particularly easy to see after the motorcycle has been washed.

Remove stains of this kind immediately, using cleaning-grade benzene or petroleum spirit on a clean cloth or ball of cotton wool. BMW Motorrad recommends BMW tar remover for removing specks of tar. Remember to wax the parts treated in this way.

Protective wax coating

BMW Motorrad recommends applying only BMW car wax or products containing carnauba wax or synthetic wax.

It is time to rewax the paintwork when water "puddles" on the surface, instead of forming beads.

Laying up motorcycle

- Clean the motorcycle.
- Remove the battery.
- Spray the brake and clutch lever pivots and the main and

side stand pivots with a suitable lubricant.

- Coat bright metal and chrome-plated parts with an acid-free grease (e.g. Vaseline).
- Stand the motorcycle in a dry room in such a way that there is no load on either wheel. Authorised BMW Motorrad dealers can provide suitable auxiliary stands.

▶ Before laying the vehicle up out of use, have the engine oil and the oil filter element changed by a specialist workshop, preferably an authorised BMW Motorrad dealer. Combine work for laying up/restoring to use with a BMW service or inspection.◀

Restoring motorcycle to use

- Remove the protective wax coating.

- Clean the motorcycle.
- Install a charged battery.
- Before starting: work through the checklist.

Technical data

Troubleshooting chart	146
Threaded fasteners	147
Engine	149
Fuel.....	150
Engine oil	150
Clutch	151
Transmission	152
Rear-wheel drive	152
Running gear	153
Brakes	155
Wheels and tyres	155
Electrics	156
Frame	158
Dimensions	158
Weights.....	159

Riding specifications	159
-----------------------------	-----

Troubleshooting chart

Possible cause	Remedy
Emergency off switch (kill switch)	Kill switch in operating position
Side stand	Retract the side stand. (➡ 76)
Gear engaged and clutch not disengaged	Select neutral or pull clutch lever (➡ 76)
Clutch pulled before ignition was switched on	Switch on the ignition, then pull the clutch lever
No fuel in tank	Refuel (➡ 84)
Battery flat	Charge the battery when connected (➡ 136)

Threaded fasteners

Front wheel	Value	Valid
Brake caliper to slider tube		
M8 x 32 - 10.9	30 Nm	
Clamp screw of quick-release axle		
M8 x 35	19 Nm	
Quick-release axle in axle holder		
M24 x 1.5	50 Nm	
Rear wheel	Value	Valid
Rear wheel to wheel carrier		
M10 x 40 x 1.25	Tighten in diagonally opposite sequence	
	60 Nm	
M10 x 53 x 1.25	Tighten in diagonally opposite sequence	- with cross-spoked wheels ^{OE}
	60 Nm	

Mirror arm	Value	Valid
Mirror to adapter		
M10 x 1.25 - 4.8	22 Nm	
Mirror adapter to clamping block		
M10 x 14 - 4.8	25 Nm	

Engine

Engine design	Four-stroke opposed twin, air-cooled with oil-cooled exhaust ports, installed longitudinally, two overhead camshafts, electronic engine management
Displacement	1170 cm ³
Cylinder bore	101 mm
Piston stroke	73 mm
Compression ratio	12.0 : 1
Nominal output	77 kW, Over: 7500 min ⁻¹
Torque	116 Nm, Over: 5750 min ⁻¹
Maximum engine speed	max 8000 min ⁻¹
Idle speed	1150 ⁺¹⁵⁰ ₋₅₀ min ⁻¹

Fuel

Recommended fuel grade	95 ROZ/RON, Super unleaded 91 ROZ/RON, Regular unleaded (fuel grade, usable with power- and consumption-related restrictions)
Usable fuel capacity	approx. 20 l
Reserve fuel	≥4 l

Engine oil

Engine oil, capacity	max 4.0 l, with filter change
Lubricant	Engine oil, 20W-50
Engine oil, quantity for topping up	max 0.5 l, Difference between MIN and MAX
Oil grades	Engine oils of API classification SF or better. Engine oils of ACEA classification A2 or better. BMW Motorrad recommends not using synthetic oils for the first 10,000 km. Please do not hesitate to contact your authorised BMW Motorrad dealer if you have any questions relating the choice of a suitable engine oil for your motorcycle.

Permissible viscosity classes

SAE 5 W- ≥ 30	-20...20 °C, Operation at low temperatures
SAE 10 W-40	-10...30 °C, Operation at moderate temperatures
SAE 15 W- ≥ 40	≥ 0 °C
SAE 20 W- ≥ 40	≥ 0 °C
SAE 5 W- ≥ 50	≥ -20 °C, High-grade and synthetic oils, operation in all temperature ranges
SAE 10 W- ≥ 50	≥ -20 °C, High-grade and synthetic oils, operation in all temperature ranges

Clutch

Clutch type	Single-plate dry clutch
-------------	-------------------------

Transmission

Gearbox type	Helical 6-speed gearbox with integral reaction damper, claw-action shift by sliding sleeves
Gearbox transmission ratios	1,737, Primary transmission ratio 2.375 (38:16 teeth), 1st gear 1.696 (39:23 teeth), 2nd gear 1.296 (35:27 teeth), 3rd gear 1.065 (33:31 teeth), 4th gear 0.939 (31:33 teeth), 5th gear 0.848 (28:33 teeth), 6th gear

Rear-wheel drive

Type of final drive	Shaft drive with bevel gears
Type of rear suspension	BMW EVO Paralever; cast light-alloy single swinging arm with two joints and torque reaction link
Number of teeth on rear-wheel drive (gear ratio)	32:11, Stamped into underside of final-drive housing

Running gear

Front wheel

Type of front suspension	BMW Telelever, with anti-dive top fork bridge, leading link pivot-mounted on engine and telescopic forks, central spring strut supported by leading link and main frame
Spring strut, front, type	Central spring strut with coil spring and twin-tube gas-filled shock absorber; spring preload mechanically adjustable
– with Electronic Suspension Adjustment (ESA) ^{OE}	Central spring strut with single-tube gas-filled shock absorber, electrically adjustable rebound damping and electro-hydraulically adjustable spring preload
Spring travel, front	190 mm, At wheel
– with lowered suspension ^{OE}	158 mm, At wheel

Rear wheel	
Type of rear suspension	BMW EVO Paralever; cast light-alloy single swinging arm with two joints and torque reaction link
Type of rear suspension	Central spring strut with single-tube, gas-filled shock absorber, steplessly adjustable rebound-stage damping, progressive compression-stage damping and hydraulically adjustable spring preload
– with Electronic Suspension Adjustment (ESA) ^{OE}	Central spring strut with single-tube gas-filled shock absorber, electrically adjustable rebound damping and electro-hydraulically adjustable spring preload
Spring travel at rear wheel	200 mm
– with lowered suspension ^{OE}	171 mm

Brakes

Type of front brake	Hydraulically operated twin disc brake with 4-piston fixed calipers and floating brake discs
Brake-pad material, front	Sintered metal
Type of rear brake	Hydraulically operated disc brake with 2-piston floating caliper and fixed disc
Brake-pad material, rear	Sintered metal

Wheels and tyres

Recommended tyre sets	You can obtain an up-to-date list of approved tyres from your authorised BMW Motorrad dealer or on the Internet at " www.bmw-motorrad.com ".
-----------------------	--

Front wheel

Front wheel, type	Cast wheel with 5 double spokes, MT H2
– with cross-spoked wheels ^{OE}	Cross-spoked wheel with 40 spokes, MT H2
Front wheel rim size	2.50" x 19"
Tyre designation, front	110/80 - 19

Rear wheel

Rear wheel type	Cast wheel with 5 double spokes, MT H2
– with cross-spoked wheels ^{OE}	Cross-spoked wheel with 40 spokes, MT H2
Rear wheel rim size	4.00" x 17"
Tyre designation, rear	150/70 - 17

Tyre pressures

Tyre pressure, front	2.2 bar, one-up, tyre cold 2.5 bar, two-up and/or with luggage, tyre cold
Tyre pressure, rear	2.5 bar, one-up, tyre cold 2.9 bar, two-up and/or with luggage, tyre cold

Electrics

Electrical rating of on-board socket	5 A
– with extra socket ^{OA}	max 5 A, Total for all sockets
Fuses	Electronic fuses protect the circuits. If an electronic fuse trips and de-energises a circuit, the circuit is active as soon as the ignition is switched on after the fault has been rectified.

Battery

Battery, manufacturer and designation	EXT 14 BS
Battery type	AGM (Absorptive Glass Mat) battery
Battery rated voltage	12 V
Battery rated capacity	14 Ah

Spark plugs

Spark plugs, manufacturer and designation	NGK DCPR 8 EKC
Electrode gap of spark plug	0.8±0.1 mm, When new max 1 mm, Wear limit
Secondary spark plugs, manufacturer and designation	NGK DCPR 8 EKC
Electrode gap of secondary spark plug	0.8±0.1 mm, When new max 1 mm, Wear limit

Lighting

Bulb for high-beam headlight	H7 / 12 V / 55 W
Bulb for low-beam headlight	H7 / 12 V / 55 W
Bulb for parking light	W5W / 12 V / 5 W
Bulb for tail light/brake light	LED / 12 V
Bulbs for flashing turn indicators, front	RY10W / 12 V / 10 W
Bulbs for flashing turn indicators, rear	RY10W / 12 V / 10 W

Frame

Frame type	Tubular steel front frame with tubular steel rear frame, load-bearing drive unit
Type plate location	On left side behind side cover
VIN location	Front frame top centre

Dimensions

Length of motorcycle	2210 mm, Across luggage carrier
Height of motorcycle	1450 mm, To top of windscreen when lowered, at DIN unladen weight
– with lowered suspension ^{OE}	1420 mm, To top of windscreen when lowered, at DIN unladen weight
Width of motorcycle	940 mm, Across mirrors
Front-seat height	855...875 mm, At unladen weight
– with low front seat ^{OE}	820 mm
– with lowered suspension ^{OE}	790 mm
Rider's inside-leg arc, heel to heel	
– without low front seat ^{OE}	1840...1940 mm
– with lowered suspension ^{OE}	1760 mm

Weights

Unladen weight	229 kg, DIN unladen weight, ready for road 90 % load of fuel, without optional extras
Permissible gross weight	440 kg
Maximum payload	211 kg

Riding specifications

Top speed	>200 km/h
-----------	-----------

Service

BMW Motorrad service	162
BMW Motorrad service quality	162
BMW Motorrad Service Card: on-the-spot breakdown assistance	162
BMW Motorrad service network ...	163
Maintenance work	163
Confirmation of maintenance work	164
Confirmation of service	169

BMW Motorrad service

Advanced technology requires specially adapted methods of maintenance and repair.



If maintenance and repair work is performed inexpertly, it could result in consequential damage and thus constitute a safety risk.

BMW Motorrad recommends you to have all the associated work on your motorcycle carried out by a specialist workshop, preferably an authorised BMW Motorrad dealer. ◀

Your authorised BMW Motorrad dealer can provide information on BMW services and the work undertaken as part of each service. Have all maintenance and repair work carried out confirmed in the "Service" chapter in this manual. Authorised BMW Motorrad dealers are supplied with the latest technical information and have

the necessary technical know-how. BMW Motorrad recommends that you contact your authorised BMW Motorrad dealer if you have questions regarding your motorcycle.

BMW Motorrad service quality

Along with its reputation for engineering quality and high reliability, BMW Motorrad is a byword for excellent quality of service.

To ensure that your BMW is always in optimum condition, BMW Motorrad recommends that you have the maintenance work required for your motorcycle carried out regularly, preferably by your authorised BMW Motorrad dealer. For generous treatment of claims submitted after the warranty period has expired, evidence of regular maintenance is essential.

Certain signs of wear, moreover, may otherwise not be noticed until it is too late to put them right at moderate cost. Your authorised BMW Motorrad dealer's mechanics know every detail of your motorcycle and can take remedial action if necessary before minor faults develop into serious problems. By having the necessary repairs done properly and in good time, you save time and money in the long run.

BMW Motorrad Service Card: on-the-spot breakdown assistance

In the event of a breakdown, the BMW Motorrad Service Card issued with each new BMW motorcycle enables you to access an extensive range of services such as breakdown assistance, motorcycle transportation etc. (details can differ from country to country). In the event of a break-

down, contact the Mobile Service organisation of BMW Motorrad. The specialists will provide the necessary advice and assistance. You will find important country-specific contact addresses and the after-sales service organisation phone numbers in the "Service Kontakt / Service Contact" brochures, along with information on Mobile Service and the dealership network.

BMW Motorrad service network

BMW Motorrad has an extensive after-sales service network in place to look after you and your motorcycle in more than 100 countries. In Germany alone, you have the best possible access to approximately 200 authorised BMW Motorrad dealers.

All information concerning the international dealership network can be found in the brochure

"Service Contact Europe" or "Service Contact Africa, America, Asia, Australia, Oceania".

Maintenance work

BMW Pre-delivery Check

Your authorised BMW Motorrad dealer conducts the BMW pre-delivery check before handing over the motorcycle to you.

BMW Running-in Check

The BMW running-in check has to be performed when the motorcycle has covered between 500 km and 1,200 km

BMW Service

The BMW Service is carried out once a year; the extent of servicing can vary, depending on the age of the motorcycle and the distance it has covered. Your authorised BMW Motorrad dealer confirms that the service work has been carried out and enters

the date when the next service will be due.

Riders who cover long distances in a year might have to bring in their motorcycles for service before the next scheduled date. It is to allow for these cases that a maximum odometer reading is entered as well in the confirmation of service. Servicing has to be brought forward if this odometer reading is reached before the next scheduled date for the service.

The service-due indicator in the multifunction display reminds you about one month or 1000 km in advance when the time for a service is approaching, on the basis of the programmed values.

Confirmation of maintenance work

BMW Pre-delivery Check

Completed

on _____

Stamp, signature

BMW Running-in Check

Completed

on _____

Odometer reading _____

Next service
at the latest

on _____

or, if logged beforehand,

Odometer reading _____

Stamp, signature

BMW Service

Completed

on _____

Odometer reading _____

Next service
at the latest

on _____

or, if logged beforehand,

Odometer reading _____

Stamp, signature**BMW Service**

Completed

on _____

Odometer reading _____

Next service
at the latest

on _____

or, if logged beforehand,

Odometer reading _____

Stamp, signature**BMW Service**

Completed

on _____

Odometer reading _____

Next service
at the latest

on _____

or, if logged beforehand,

Odometer reading _____

Stamp, signature

BMW Service

Completed

on _____

Odometer reading _____

Next service

at the latest

on _____

or, if logged beforehand,

Odometer reading _____

Stamp, signature**BMW Service**

Completed

on _____

Odometer reading _____

Next service

at the latest

on _____

or, if logged beforehand,

Odometer reading _____

Stamp, signature**BMW Service**

Completed

on _____

Odometer reading _____

Next service

at the latest

on _____

or, if logged beforehand,

Odometer reading _____

Stamp, signature

BMW Service

Completed

on _____

Odometer reading _____

Next service
at the latest

on _____

or, if logged beforehand,

Odometer reading _____

Stamp, signature**BMW Service**

Completed

on _____

Odometer reading _____

Next service
at the latest

on _____

or, if logged beforehand,

Odometer reading _____

Stamp, signature**BMW Service**

Completed

on _____

Odometer reading _____

Next service
at the latest

on _____

or, if logged beforehand,

Odometer reading _____

Stamp, signature

BMW Service

Completed

on _____

Odometer reading _____

Next service

at the latest

on _____

or, if logged beforehand,

Odometer reading _____

Stamp, signature**BMW Service**

Completed

on _____

Odometer reading _____

Next service

at the latest

on _____

or, if logged beforehand,

Odometer reading _____

Stamp, signature**BMW Service**

Completed

on _____

Odometer reading _____

Next service

at the latest

on _____

or, if logged beforehand,

Odometer reading _____

Stamp, signature

Confirmation of service

The table is intended as a record of maintenance, warranty and repair work, the installation of optional accessories and, if appropriate, special campaign (recall) work.

Item	Odometer reading	Date

A

Abbreviations and symbols, 6

ABS

Control, 15

Engineering details, 88

Operation, 56

Self-diagnosis, 77

Warnings, 29

Accessories

General instructions, 96

Air filter

Installation, 133

Position on the motorcycle, 13

Removal, 132

Anti-theft alarm

Telltale light, 17

Warnings, 39

ASC

Control, 15

Engineering details, 90

Operation, 58

Self-diagnosis, 78

Warnings, 31

B

Battery

Charging battery when
connected, 136

Charging battery when
disconnected, 137

Installation, 138

Maintenance instructions, 135

Removal, 137

Stowage, 14

Warning, charge current, 25

BMW Motorrad service, 162

BMW Motorrad Service

Card, 162

Brake fluid

Checking fluid levels, 114

Reservoir, front, 13

Reservoir, rear, 13

Brake pads

Checking brake-pad
thickness, 111

Running in, 79

Brakes

Adjusting brake lever, 61

Checking operation, 111

Safety instructions, 81

Technical data, 155

Bulbs

General instructions, 125

Overview, headlights, 18

Replacing auxiliary-headlight
bulbs, 129

Replacing fuses for auxiliary
headlights, 131

Replacing high-beam headlight
bulb, 125

Replacing low-beam headlight
bulb, 125

Replacing parking-light
bulb, 127

Replacing turn indicator
bulbs, 128

Technical data, 157

Warning, bulb failure, 25, 26

C

- Case
 - Operation, 98
- Checklist, 75
- Clock, 20
 - Adjusting, 46
- Clutch
 - Adjusting clutch lever, 60
 - Checking fluid level, 116
 - Checking operation, 116
 - Fluid reservoir, 11
 - Technical data, 151
- Confirmation of maintenance work, 164
- Currency, 7

D

- Damping
 - Adjuster, rear, 11
 - Adjusting, 64
- Dimensions
 - Technical data, 158

E

- Electrics
 - Technical data, 156
- Emergency off switch (kill switch), 16, 56
- Engine
 - Control, 16
 - Starting, 76
 - Technical data, 149
 - Temperature gauge, 20
 - Warning, engine electronics, 24
- Engine oil
 - Checking fill level, 109
 - Fill-level indicator, 11
 - Filler neck, 11
 - Technical data, 150
 - Topping up, 110
 - Warning, engine oil level, 29
 - Warning, engine oil pressure, 25
- Equipment, 7
- ESA
 - Control, 15
 - Engineering details, 93
 - Operation, 66

F

- Frame
 - Technical data, 158
- Front-wheel stand
 - Installing, 124
- Fuel
 - Fill-level indicator, 20
 - Filler neck, 13
 - Refuelling, 84
 - Technical data, 150
 - Warning, fuel down to reserve, 24
- Fuses, 156
 - Replacing fuses for auxiliary headlights, 131

G

- Gear indicator, 20
- General views
 - Headlight, 18
 - Left handlebar fitting, 15
 - Left side of motorcycle, 11
 - Multifunction display, 20
 - Right handlebar fitting, 16
 - Right side of motorcycle, 13
 - Underneath the seat, 14

Grip heating
Control, 16

H

Handlebar fittings
General view, left side, 15
General view, right side, 16

Handlebars
Adjusting, 62

Hazard warning flashers
Control, 15, 16
Operation, 55

Headlight
Beam throw, 69
Driving on right/driving on left, 69
Headlight beam-throw adjustment, 11
Overview, 18

Headlight flasher, 15
Helmet holder, 14, 71

High-beam headlight
Control, 15
Switching on, 53
Telltale light, 20
Horn, 15

I

Idle
Telltale light, 20

Ignition
Switching off, 44
Switching on, 44

Immobiliser, 45
Warning, 24

Instrument cluster
Ambient-light brightness sensor, 17
Overview, 17

J

Jump starting, 134

K

Keys, 44, 46

L

Laying up, 142

Lights

Auxiliary headlights, 97
Headlight flasher, 53
Switch on the high-beam headlight, 53
Switching on parking lights, 54
Switching on the low-beam headlight, 53
Switching on the side lights, 53

Low-beam headlight
Switching on, 53

Lowered suspension
Restrictions, 78

Luggage
Instructions for loading and securing objects, 97

Luggage carrier
Installation, 104
Removal, 104

M

Maintenance
General instructions, 108
Maintenance intervals, 163

- Mirrors
 - Adjusting, 61
- Motorcycle
 - Laying up, 142
 - Parking, 82
 - Restoring to use, 142
- Multifunction display, 17
 - Overview, 20
- O**
- Odometer and tripmeters, 20
 - Control, 15
 - Operation, 47
- Off-roading, 80
- On-board computer
 - Ambient temperature, 50
 - Average consumption, 51
 - Average speed, 50
 - Control, 15
 - Oil level, 52
 - Operation, 49
 - Range, 51
 - Status indicators, 21
 - Warnings, 26
- P**
- Parking, 82
- Parking light
 - Switching on, 54
- Power socket, 11, 96
- Pre-ride check, 77
- R**
- Rear-wheel drive
 - Technical data, 152
- Refuelling, 84
- Reserve volume
 - Warning, 24
- Residual range, 49
- Restoring to use, 142
- Rev. counter, 17
- Rider's Manual
 - Stowage, 14
- Running gear
 - Technical data, 153
- Running in, 79
- S**
- Safety instructions
 - Brakes, 81
 - General, 74
- Seat
 - Adjusting seat height, 59
 - Installation, 69
 - Lock, 11
 - Removal, 69
- Service, 162
- Service Card, 162
- Service-due indicator, 20
- Side light
 - Switching on, 53
- Spark plugs
 - Technical data, 157
- Speedometer, 17
- Spring preload
 - Adjuster, front, 11
 - Adjuster, rear, 13
 - Adjusting, 63
- Starting, 76
- Status indicators
 - See also warnings, 20
 - Standard status indicators, 20
 - Warnings, 22
 - With on-board computer, 21
 - With RDC, 22
- Steering lock, 45

T

Technical data

- Brakes, 155
 - Bulbs, 157
 - Clutch, 151
 - Dimensions, 158
 - Electrics, 156
 - Engine, 149
 - Engine oil, 150
 - Frame, 158
 - Fuel, 150
 - Rear-wheel drive, 152
 - Running gear, 153
 - Spark plugs, 157
 - Standards, 7
 - Transmission, 152
 - Weights, 159
 - Wheels and tyres, 155
- ### Telltale lights, 17
- Overview, 20
- ### Toolkit
- Contents, 108
 - Stowage, 14

Topcase

- Operation, 101

Torques, 147

Transmission

- Technical data, 152

Transportation

- Lashing, 85

Troubleshooting chart, 146

Turn indicators

- Control, left, 15
- Control, right, 16
- Operation, 54
- Telltale light, 20

Type plate, 11

Tyre pressure monitoring RDC

- Adhesive label for rim, 118
- Engineering details, 92
- Operation, 52
- Status indicators, 22
- Warnings, 34

Tyres

- Checking inflation pressure, 68
- Checking tread depth, 117
- Pressures, 4, 156
- Recommendation, 118

Running in, 79

Table of tyre pressures, 14

Technical data, 155

Top speed, 117

V

Vehicle identification number, 13

W

Warnings, 22

- With ABS, 29
- With anti-theft alarm, 39
- With ASC, 31
- With on-board computer, 26
- With RDC, 34

Warnings, overview, 23, 28, 30, 32, 35, 40

Weights

- Payload table, 14
- Technical data, 159

Wheels

- Change of size, 118
- Checking rims, 117
- Installing front wheel, 121
- Installing rear wheel, 123

- Remove the front wheel, 119
- Removing rear wheel, 123
- Technical data, 155
- Windscreen
 - Adjuster, 11
 - Adjusting, 60