

River Debris: Causes, Impacts, and Mitigation Techniques



Ryan N. Tyler

Prepared for Ocean Renewable Power Company

By the Alaska Center for Energy and Power, April 13, 2011



Abstract

Perhaps the greatest obstacle that confronts the implementation of commercial-scale hydrokinetic devices in rivers is debris. Until recently, this problem has been largely avoided by installing devices in areas where debris is not a factor. This practice significantly limits the possible locations for deployment, however, so new techniques must be developed. Although there is little precedent for large hydrokinetic devices and the issue of debris, there are examples of efforts to protect other engineered riverine structures. In addition to presenting these examples, we discuss the mechanisms for how debris enters the flow and is transported downstream, as this information can provide important insight in the development of debris mitigation strategies.

Acknowledgments

The author would like to thank all those who offered support, advice, and knowledge. In particular, Professor Jerome Johnson of the Alaska Center for Energy and Power for his continued guidance and for his help contacting experts in the field. Gratitude is also extended to Jack Schmid for his help compiling evidence of debris and his photographic expertise.

Recognition and gratitude goes to BP for their financial support of my research position. In addition, the funding from the Denali Commission through an ORPC-funded project was instrumental, as was the support from the Alaska Energy Authority's Renewable Energy Fund for the Nenana Construction Project.

Table of Contents

Abstract.....	ii
Acknowledgments.....	iii
1. Introduction.....	1
2. River Debris Characterization	2
2.1 Causes and Types of Debris	2
2.2 Debris Transport	3
2.3 Impact Forces of Debris on Engineered Structures	5
2.4 Debris Accumulation	6
3. Existing Debris Mitigation Techniques.....	6
3.1 Upstream Debris Diversion Techniques.....	6
3.1.1 Treibholzfange debris detention / debris basins	7
3.1.2 Debris booms	7
3.1.3 Debris fins	7
3.1.4 River training structures.....	8
3.2 Near-Field Deflectors and Sweepers.....	8
3.2.1 Debris sweepers.....	8
3.2.2 Debris deflectors	9
3.3 Trash Racks.....	11
3.4 Techniques Currently Used with Hydrokinetic Devices	13
3.4.1 Device placement.....	13
3.4.2 Furling	14
3.4.3 Debris booms	14
3.4.4 Trash racks	15
3.4.5 Blade design	16
3.4.6 Manual debris removal	16
4. Conclusions and Recommendations.....	16
5. Appendices.....	19
Appendix A: Maximum impact forces of large woody debris on engineered structures	19
Appendix B: Estimation of the head loss through a trash rack of bars with various geometry	21
Appendix C: Determination of the natural and forcing frequencies associated with trash racks (from Lewin, 1995).....	23
Appendix D: Details of trash racks that failed during operation (from Syamalarao, 1989)	25
Appendix E: Assessment of potential for debris production and transportation (from Lagasse et al., 2010)	26
6. Bibliography	28

1. Introduction

Anytime an engineered structure is placed in a river environment, the possibility exists that it will encounter debris. The impact of this debris on a structure is an important aspect of the design. Both the force of the initial impact and the possibility of debris accumulation must be considered in determining the effect of debris on a structure. Historically, debris accumulation on bridge piers and hydroelectric dams has been among the chief concerns associated with river debris. As the amount of debris builds on an object, the force it exerts on the object can result in catastrophic failure and reduce the flow, resulting in the buildup of a backwater and greatly reducing the efficiency of energy conversion. Additionally, as floating debris accumulates on a structure, it will begin to push downwards, forcing the flow to the riverbed, greatly increasing scour (Saunders & Oppenheimer, 1993). In hydrokinetic devices, the effects of debris accumulation are even more profound, since a reduction in flow speed reduces the kinetic energy of the flow by the cube of the velocity reduction. The forces associated with debris accumulation can rapidly lead to catastrophic or near-catastrophic failure in hydrokinetic devices.

In the summer of 2010, a surface-mounted 5 kW Encurrent Turbine from New Energy became nearly submerged in the Yukon River (Ruby, Alaska) after only a few days of debris accumulation (Figure 1). Although the device recovered from that particular debris incident, the Yukon River Inter-tribal Watershed Council, which is responsible for the device, recently discontinued the testing of the turbine partially due to continual debris issues and the danger to workers of associated uncontrolled debris.



Figure 1: Debris accumulation on the 5 kW Encurrent Turbine barge in Ruby, Alaska (Johnson & Pride, 2010)

Further up the Yukon River, during summer 2010, Alaska Power and Telephone (AP&T) installed a second Encurrent Turbine in Eagle, Alaska. During initial deployment, the 25 kW device was consistently challenged by debris. While the device avoided catastrophic events, the turbine blades suffered from debris impact, the efficiency was hindered because of accumulation, and the power connection to the shore was continually compromised by submerged debris snares. As they prepare for their second water season, AP&T has identified the issue of debris as the most important problem that confronts their turbine (Beste, 2011).

On the Mackenzie River in Fort Simpson, Northwest Territories, another barge-mounted Encurrent Turbine was installed in June 2010 by the Northwest Territories Power Corporation. As with the two

turbines in Alaska, debris on the Mackenzie proved to be a formidable challenge. The turbine was protected by a debris boom, which was generally successful in deflecting surface debris. Despite the protection from surface debris, the turbine was struck by a log in late June (Thompson, 2010). The damage suffered during the collision resulted in nearly two months of repairs and redesigns (Thompson, 2010). As the Northwest Territories Power Corporation contemplates the future of the project, debris will continue to be one of the main considerations (Thompson, 2010).

Many studies have been made on impact mitigation of debris on traditional structures, such as bridge abutments and hydroelectric dams, although quantifiable assessment of the efficacy of the studies has not been thoroughly documented. In hydrokinetic applications, attempts to solve the debris problem are mostly theoretical. Mitigation strategies currently practiced primarily exist in use with small hydrokinetic devices, typically in remote areas.

In order to develop approaches for larger commercial-scale hydrokinetic devices, it is important to understand what type of debris a device is likely to encounter, the way the debris flows down a river, and the current debris-mitigation strategies in place both for small hydrokinetic applications and for traditional structures, such as bridge piers and hydroelectric dams.

2. River Debris Characterization

2.1 Causes and Types of Debris

Debris transport, including the type of debris, the mechanisms by which the debris enters the flow, and the manner in which it moves with the flow, all depend greatly on the characteristics of the river and the environment through which it flows. Although debris type exists in a continuum, it is often helpful to consider three main classifications for woody debris (Bradley et al., 2005). The first is small debris, which includes small branches, leaves, and refuse. Because of its small size, this debris can be transported into the flow by a variety of ways. In addition to the mechanics by which larger debris enters the flow, small debris can enter through wind events and seasonal changes, resulting in loss of foliage (Bradley et al., 2005). Medium debris consists mostly of larger branches and can enter the flow through a smaller tributary or runoff stream, because of bank erosion or the breakdown of larger debris, and through flood events (Bradley et al., 2005). Large debris, consisting of very large branches and entire trees, can enter the flow in many of the same ways as medium debris, but with a few restrictions. Smaller tributaries often do not have the flow rate or the width to transport large debris, so the debris does not often enter the main flow via runoff. Large debris most commonly enters the flow either during a flood event or because of bank erosion (Figure 2) (Bradley et al., 2005). Not surprisingly, the magnitude of a flood event and the concentration of debris within the floodplain also greatly affect the amount of debris that enters the flow. Any time there are long periods between flood events, debris problems can be anticipated, and the first major flood event of the year typically carries the greatest amount of debris into a river (Chang & Shen, 1979). A suggested flowchart for assessing debris-production potential (Lagasse et al., 2010) is shown in Appendix E.



Figure 2: Large debris entering the flow due to bank erosion (photo courtesy of Jack Schmid, Alaska Center for Energy and Power, 2010)

2.2 Debris Transport

Although the manner in which debris is transported in a river greatly depends on the flow characteristics and type of debris, some generalizations can be made. While medium and large debris can become entangled, it has been observed that floating debris rarely travels in large masses; this may be a result of river turbulence breaking apart the tangled debris (Chang & Shen, 1979). Despite this trend, entangled debris is possible especially during high water in areas with heavy debris loads. Debris events containing large amounts of entangled debris can have significant consequences to engineered structures (Figure 3). Chang and Shen (1979) observed that in straight sections of the river, floating debris tends to follow the thalweg at the rising stage of a flood event, but tends to gravitate outward toward the banks while the water level is falling (Chang & Shen, 1979). When the water is neither falling nor rising due to a flood event, secondary flow currents tend to converge at the surface, resulting in the majority of floating debris concentrating along one path, which typically relates closely to the thalweg (Lagasse et al., 2010). Large debris is further restricted in how it is transported based on the size and flow of the river. As the length of the debris approaches the width of the river, the likelihood that it will be transported downstream greatly diminishes (Bradley et al., 2005). In addition, as the sinuosity of the river increases and the radius of the curves decreases, the likelihood that debris transport will occur diminishes (Lagasse et al., 2010). The exception occurs in rivers that have high sinuosity and migrating banks, as those conditions often result in an increased amount of debris entering the flow as the banks erode (Lagasse et al., 2010). A suggested flowchart for assessing the potential for debris transport (Lagasse et al., 2010) is shown in Appendix E.



Figure 3: Large entangled debris event impacting (upper left) and carrying off (upper right and lower left) a fish wheel on the Tanana River near Nenana, Alaska, and depositing it against a bridge pier (lower right) (courtesy of Stephen Lord)

In addition to the vast majority of debris, which floats on the surface, it is possible to have debris exist throughout the water column (Figure 4). Although submerged debris has not been extensively studied, it has been observed that the potential for subsurface debris greatly increases in areas where bank erosion is a major cause of debris entering the flow (Chang & Shen, 1979). When bank erosion contributes to debris load in the river, it is likely that large woody debris will include an intact root ball, which can pull the debris below the surface (Chang & Shen, 1979). This effect can be seen in **Error! eference source not found.**, which shows a tree floating vertically with its root ball scraping along the riverbed.

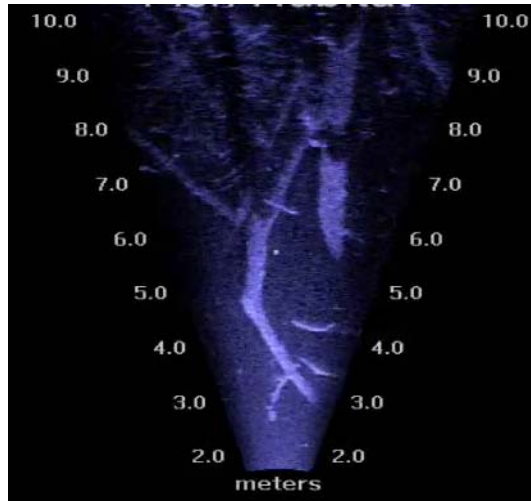

Figure 4: Submerged debris in the Red River, Manitoba Canada, as seen from a Didson camera (Red River woody debris and predator avoidance. Red River, Manitoba, 2007)



Figure 5: Vertically floating tree with its root ball scraping along the bed of the Yukon River. The effect can be seen by the different freeboard projections of the upper portion of the tree (photo Courtesy of Jack Schmid, Alaska Center for Energy and Power, 2010)

2.3 Impact Forces of Debris on Engineered Structures

Difficulties in predicting the presence of debris in a river are further compounded when attempting to anticipate the impact force with which the debris will strike an engineered structure. The orientation of debris is a direct result of the collision geometry and the forces involved with an impact. In their study of impact forces of woody debris on floodplain structures, Haehnel and Daly found that maximum impact force results when the log is oriented parallel to the flow and strikes the device with its end (Haehnel & Daly, 2002). Oblique impacts with small impact angles carry the least force, and force increases gradually as the angle increases, with a jump in impact force when the log becomes perpendicular to the structure (Haehnel & Daly, 2002). In their laboratory-scale tests, Haehnel and Daly found that even when logs were lined up with a structure downstream, they missed the structure entirely 40% of the time, and fewer than 15% of the impacts resulted in maximum force. Haehnel and Daly's study resulted in the formation of expressions for estimating the maximum impact force of collisions between large woody debris and engineered structures. Appendix A includes a more detailed overview of their findings

2.4 Debris Accumulation

Although the potential for debris accumulation is most closely related to the amount of debris in the flow, there are some design considerations for mitigating debris accumulation. In instances where there are multiple structures, such as bridge piers or possibly an array of hydrokinetic turbines, in the flow, the distance between structures plays an important role. If gaps between piers are less than the maximum debris length, then span accumulation is likely to occur (Figure 4). If accumulation on individual structures occurs, then span accumulation may even be possible if the gaps between structures are greater than the maximum debris length (Lagasse et al., 2010). Debris accumulation on an individual structure depends greatly on the geometry of the structure. Apertures in the structure greatly increase the likelihood for debris accumulation (Lagasse et al., 2010). In addition, the alignment of the structure in the flow can affect the probability of accumulation; those structures with skewed alignment compared with the flow, have a greater likelihood of collecting debris (Lagasse et al., 2010).



Figure 4: Debris accumulation on bridge piers and the resulting failure (Lagasse et al., 2010)

3. Existing Debris Mitigation Techniques

Efforts to reduce the effects of debris on engineered structures have resulted in a variety of techniques. Although few techniques for debris protection have been developed specifically for hydrokinetic devices in river environments, many of the strategies could have consequences for hydrokinetic devices. These techniques often include either diverting or capturing debris well upstream of the device or attempting to trap debris at the device.

3.1 Upstream Debris Diversion Techniques

In areas that experience heavy debris loads, it is often necessary to protect engineered structures by diverting, trapping, or otherwise influencing the flow of debris upstream of the device.

3.1.1 Treibholzfange debris detention / debris basins

The first method for preventing debris from impacting a device is to incorporate a debris-detention system upstream of the device. The Treibholzfange debris-detention device consists of circular posts driven into the riverbed upstream of the device. The geometry of the posts, along with the distance between the posts, determines the size of debris that can be captured, as well as the manner in which it is detained. In physical model tests at the Hydraulics Laboratory at the Technical University of Munich, LainBach and Arzbach determined that the best configuration for retaining debris while allowing sediment and water to flow through is to have the posts set a distance apart that is equal to (or less than) the minimum length of the debris intended for capture, and to orient the posts in a downstream pointing “V” (Wallerstein & Thorne, 1995). Alternatively, when the posts were placed in a straight line across the flow, it was found that the debris was often pushed over the barrier. Because debris was trapped across the entire width of the flow (rather than being funneled into one area), the backwater effects were considerably greater than with the downstream “V” configuration (Wallerstein & Thorne, 1995). When the posts were placed in a straight line angled across the width of the river (Lainbach and Arzbach oriented the posts in a 30° angle to the bank), or when the posts were placed in an upstream pointing “V,” it was determined that the backwater effects were still greater than the downstream “V” (Wallerstein & Thorne, 1995). Note that while the upstream “V” or the angled posts may not be better than the downstream “V” from a hydrodynamic standpoint, they have the significant advantage of directing debris toward the banks, which should make the ultimate removal of debris far easier than with the downstream “V.”

3.1.2 Debris booms

Unlike Treibholzfange debris-detention devices, which involve the permanent implantation of posts into the riverbed in order to capture, or deflect, debris throughout the river’s water column, debris booms generally consist of a floating deflector designed to direct surface debris. Generally made of timbers, these devices require the inclusion of guides or anchors to hold them in place (Bradley et al., 2005). Once in place, debris booms have proven successful in deflecting surface debris, and they have the significant advantage of not requiring the installation of permanent structures into the riverbed (aside from possibly the anchoring system). Debris booms, however, do not offer a solution for debris traveling below the surface, which can be a problem in areas that experience large woody debris, especially if the root balls remain intact. Additionally, debris booms are subject to accumulation, particularly if they are held in place with anchor lines. Despite these potential problems, debris booms have had many applications in traditional hydroelectric generation, and they have been used to protect some surface-mounted hydrokinetic devices.

3.1.3 Debris fins

While debris booms and debris-detention devices are designed to prevent debris from traveling downstream or to direct debris away from an engineered structure, debris fins (Figure 5) allow debris to continue traveling in the flow in a directed manner. Debris fins have been used extensively in bridge construction; they consist of fins extruding upstream from a bridge abutment. When a piece of debris hits the fin, it is oriented parallel to the flow, which allows it to more easily flow past the support

without getting caught (Bradley et al., 2005). Alternatively, single posts imbedded in the riverbed upstream of a structure occasionally replace the fin (Bradley et al., 2005). In addition to greatly reducing the likelihood of both impact and entanglement, aligning the debris with the flow reduces the force of the impact involved with any collision. As discussed in their study, Haehnel and Daly found that though maximum impact force occurs when the debris impact is end-on, even when lined up with a structure, maximum impact rarely occurs, while minimum impact force, which occurs in an oblique collision, is far more likely (Haehnel & Daly, 2002).



Figure 5: Concrete debris fin extending upstream from bridge pier (left) and debris deflecting posts (right) (Lagasse et al., 2010)

3.1.4 River training structures

While most debris-mitigation strategies involve reducing the impact of debris without affecting the flow, attempts to capture debris by altering the river's flow have been made. River training structures are similar to a weir or jetty. They extend from the bank to create an artificial eddy, which catches debris in its vortex (Bradley et al., 2005). Often these weirs are placed in areas where debris tends to travel near the river's edge, for example, along the outer bank of a river bend.

3.2 Near-Field Deflectors and Sweepers

3.2.1 Debris sweepers

Rather than attempting to control debris upstream of the structure, sweepers and deflectors are intended to buffer the structure itself from impact and to steer debris around the structure. Sweepers, created by Debris Free Inc. (US Patent #6406221), are vertically aligned polyurethane cylinders that are attached to the upstream side of a structure and which rise and fall with the water's surface (Bradley et al., 2005). Sweepers, shown in Figure 6, are free to rotate on their vertical axis. Because sweepers rotate freely, they shed debris, greatly reducing the likelihood of accumulation.



Figure 6: Debris sweepers attached directly to a bridge pier (left) and pole mounted (right) (Lagasse et al., 2010)

Debris sweepers have been installed in a number of locations, but their efficacy varies widely. In their 2007 spring conference, state representatives to the American Association of State Highway and Transportation Officials expressed disparate opinions on the merits of debris sweepers (AASHTO, 2007). Although one representative (Mike Fazio from Utah) reported that the devices have proved effective, others voiced a number of concerns about the devices (AASHTO, 2007). Included in their observations were device failures due to clogging, being crushed by large debris, and being dislodged from their mounts (AASHTO, 2007). Also expressed were concerns about how debris sweepers would handle icy conditions (AASHTO, 2007). A possible factor that may contribute to clogging failure of the sweeper devices is current speed; it has been observed that sweepers are not generally effective when flow speeds are low (Lyn et al., 2007)..

3.2.2 Debris deflectors

Debris deflectors (Figure 7) are similar to a localized version of the Treibholzfang posts. Deflectors are placed immediately upstream of the structure in order to direct debris around the structure. Deflector designs and material vary greatly; however, they usually consist of either wood or metal oriented in a pair of vertical grids that come together in a “V” shape, with the apex pointing upstream (Bradley et al., 2005). Unlike sweepers and booms, these devices have the advantage of being able to protect the structure from debris throughout the water column, and they do not require a river-wide structure as with the Treibholzfang posts. Deflectors do have the potential to catch debris, so while most debris is deflected, accumulation can be a problem.



Figure 7: Debris deflector placed upstream of culvert opening (Lagasse et al., 2010)

Because of the potential for debris to accumulate on traditional deflectors, the use of lunate-shaped hydrofoil deflectors has been proposed (Lagasse et al., 2010). Hydrofoil deflectors would be tethered or pole mounted to the riverbed upstream of the structure and would reside at a given depth below the surface (Saunders & Oppenheimer, 1993). Vortices form on the leading edge, and because the hydrofoil is inclined at a downward angle, when debris is shed, it travels upwards (Saunders & Oppenheimer, 1993). Because of the hydrofoil's design, the vortices rotate such that the water closest to the surface pushes outwards (Saunders & Oppenheimer, 1993). These vortices would propagate to the surface in front of the abutment, deflecting debris around it (Lagasse et al., 2010). In their laboratory tests, Saunders and Oppenheimer (1993) showed that their hydrofoil successfully prevented debris from accumulating on the pier; they hypothesized that if they had designed their device so that it could oscillate the varying vortices would greatly increase the device's ability to dislodge debris (Saunders & Oppenheimer, 1993). Because the hydrofoil is both submerged and solid, it is far less likely to accumulate debris than traditional debris deflectors are. However, despite successful trials in a laboratory setting, hydrofoil deflectors remain untested in the field. Figure 8 shows a schematic of Saunders and Oppenheimer's original hydrofoil design (US Patent #5839853).

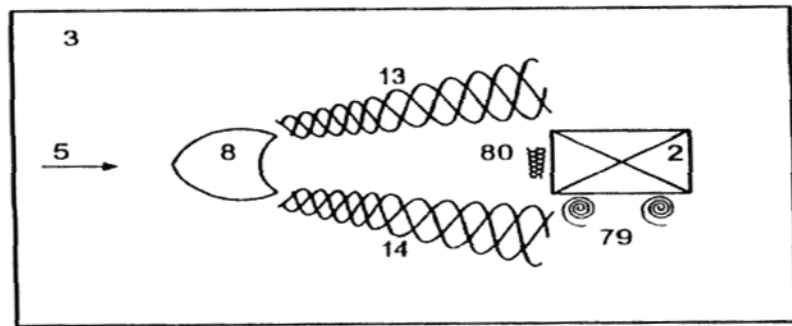

FIG 30A

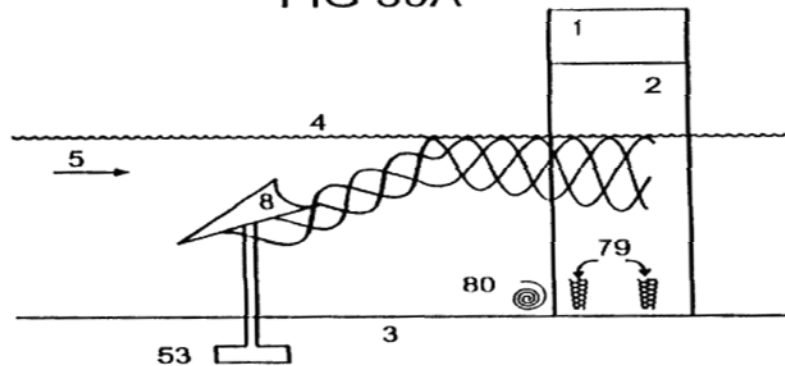

FIG 30

Figure 8: Schematic of debris-deflecting hydrofoil from Saunders and Oppenheimer's original patent (Oppenheimer & Saunders, 1995)

3.3 Trash Racks

The most common technique for dealing with debris in traditional hydroelectric facilities is to use a trash rack to keep debris from entering the penstock. In some cases, these racks are similar in design to the debris deflectors used to protect bridge abutments. In these cases, the racks are designed to deflect debris from the penstock intake. This type of debris diversion is used in many run-of-the-river hydroelectric facilities.

Traditional trash racks, designed to protect hydroelectric dams, consist of slightly inclined vertical bars that stretch nearly the entire height of the dam, typically from the bottom of the intake to above the water surface (Bradley et al., 2005). These vertical bars are spaced according to the minimum debris size that needs to be kept from entering the penstock, and they are generally made of either mild carbon steel, although wrought iron, alloy steel, and stainless steel are also used in some areas (Bradley et al., 2005). The bars are often attached to the dam via horizontal supports, which can be manufactured such that removal for maintenance is possible. Trash racks are faced with the two major challenges of accumulating debris and head loss due to the accumulation of debris and to the racks themselves. In addition, structural fatigue of the racks is a serious design consideration.

Unlike debris deflectors, which are designed to shed debris, trash racks for traditional hydroelectric dams (Figure 9) span the width of the flow, so debris accumulation is a constant issue. Debris accumulation is initially dealt with by the slope of the rack's incline. Ranging from 15° to 45° for low-pressure systems, the slope of the rack pushes debris toward the surface and away from intake structures (Bradley et al., 2005). Regardless of the slope, debris accumulates on the rack affecting its efficacy and challenging its structural integrity. Because of this, debris-removal systems are critical for trash racks. Debris is usually removed from a rack by raking, which can be done by hand or with mechanized rakes. Mechanical rakes have become the standard for large hydroelectric facilities; they operate by lowering the rake into the water and pulling it up the rack face. Once at the top of the rack, debris is deposited into a collection receptacle (Bradley et al., 2005). The rakes can be guided or unguided. As the name suggests, guided rakes operate on guides attached directly to the dam. Guided rakes have the advantage of operating effectively both on dams where the rack does not stretch the entire height of the dam and in areas where strong transverse currents exist (Bradley et al., 2005). Guided rakes tend to be more expensive, however, and there is risk that the guides will clog with debris (Bradley et al., 2005). Unguided rakes have wheels that allow them to travel along the rack face; they rely on water pressure and the inclination of the rack to stay against the rack face (Bradley et al., 2005). Unlike guided rakes, unguided rakes have the ability to travel over debris without getting stuck, so they are often preferred in areas where large debris accumulation is anticipated. Unguided rakes, though, are not well suited to areas subject to large transverse currents or to areas where the racks do not extend the height of the dam (Bradley et al., 2005).



Figure 9: Trash rack and mechanical debris rake (Hydro Component Systems, 2007)

While debris accumulation reduces flow through the rack and thus reduces the head, the problem of head reduction is present even when debris is not. Because of this, debris racks are often designed to balance the size of the debris they are meant to capture with the amount of head loss that is acceptable for their application. Along with the spacing between the bars, the geometry of the bars has a large

impact on the head loss associated with the rack. Despite this, most hydroelectric dams avoid streamline bars because of their higher cost, relying instead on rectangular bars. One representation of the predicted head loss through a trash rack, based on bar geometry and spacing, is found in Appendix B.

The largest cause for trash rack failure has come not from the force of a collision, but rather from material fatigue due to the vibrations associated with vortex shedding (Bradley et al., 2005). Because of this, rack designs must balance the ability to capture debris while minimizing head loss, with reduction in vibrations. Vibrational forces are a result of resonance between the natural frequency of the rack and the forcing frequency due to vortex shedding (Lewin, 1995). An approach for determining the natural and forcing frequencies is given in Appendix C. Because the force of these vibrations increases with the speed of the flow, vibrations are likely to be a greater concern for hydrokinetic applications than they are for hydroelectric dams. In dam applications, vibrational concerns have been mitigated by including lateral stabilizers made of butyl rubber in rack designs (Bradley et al., 2005). In one study, the addition of rubber stabilizers reduced the magnitude of vibrational force from 2.15 g to 0.1 g (Bradley et al., 2005). In addition, the geometry of the bars affects the potential for vibrations. In order to minimize vibrational effects, the bars should be as close to square as possible; square bars, however, result in significant head loss, so this too must be balanced (Bradley et al., 2005). Examples of trash rack geometries and their failures are found in Appendix D.

3.4 Techniques Currently Used with Hydrokinetic Devices

While the impact of debris on traditional hydroelectric dams and engineered structures such as bridges has been documented and studied, the impact of debris on hydrokinetic devices has been largely ignored or is at best anecdotal. The majority of commercial-scale devices that are operational have been placed in areas where debris is not a major issue. Worldwide, the majority of commercial-scale hydrokinetic turbines have been placed in tidal estuaries to capture the kinetic energy in tidal, rather than river, currents. While debris is a potential issue in these areas, it is far less of a concern than in rivers. In rivers, the first FERC-licensed and commercially operational hydrokinetic power plant in the U.S., Hydro Green Energy's turbine in Hastings, Minnesota, was placed at the outflow of an existing hydroelectric dam, partially to avoid any worries about debris (Hydro Green Energy, LLC, 2010). In those sites where debris is a hazard, such as the two pilot-scale projects in Alaska using New Energy hydrokinetic turbines, the problem remains unresolved, as discussed in the introduction to this report (Johnson & Pride, 2010). Because of this, information regarding existing debris countermeasures for hydrokinetic devices is scarce and virtually non-existent at the commercial scale. However, there are a number of small-scale hydrokinetic projects, mostly existing in rural areas of the developing world, that have taken measures to reduce the impact of debris on their operations.

3.4.1 Device placement

The first method, employed to mitigate the effects of debris, is in the placement of the device. The first aspect of device placement is depth. Because the majority of debris floats on the surface, it is important to estimate the depth under which the debris flows. Placement of devices at a deep enough level was found to be the greatest common factor cited by manufacturers in how their devices avoid debris.

Even manufacturers that utilize surface-mounted turbines, such as New Energy and Thropton Energy, both of which develop small-scale turbines for use in remote areas of the developing world, refer to placing their turbines far enough below the surface mount to minimize collisions between the turbine and debris (Sexon, 2010).

In addition to placing turbines deep enough to avoid surface debris, the location of the turbine within a river section can have a profound effect on the debris the device will encounter. As discussed, the majority of debris travels in the thalweg, so this may be a location to avoid. Unfortunately, this tactic usually has the deleterious effect of avoiding the area of the river that contains peak currents. A similar tactic, used by Thropton Energy, is to place devices downstream of the inner edge of a river curve. Because debris tends to flow toward the outer bank as it rounds a curve, it is often possible to find a location downstream of the inner edge where much of the water's velocity has recovered; however, the majority of debris is still located closer to the outer bank (Sexon, 2010). Thropton Energy credits the placement of their devices as the biggest reason why they are able to avoid major debris issues, although they acknowledge that their devices are often not placed in the optimal flow location (Sexon, 2010).

3.4.2 Furling

In locations that encounter varying water levels and the potential for high debris loads, furling is occasionally used as way to avoid major debris events (Anyi & Kirke, 2010). Furling allows the device to be lifted out of the water in the event that debris is present in the flow (Hands On: The Earth Report, 2004) (Figure 12). This is an extremely effective tactic, but at present, it is only used in areas where the devices are small enough to be removed easily from the water and where there is a human operator present to detect debris. It may be possible to automate this process for larger devices, perhaps placing the device on a track with a detector so that it can move side-to-side as debris is detected, although no such technique is currently being pursued (Daly, 2010).



Figure 10: Furling of micro-hydrokinetic battery-charging device (Hands On: The Earth Report, 2004)

3.4.3 Debris booms

While furling is effective, it can result in the device routinely exiting the flow in order to avoid debris, and it requires constant human supervision. Rather than removing the turbine from the path of debris,

debris booms and trash racks are used to prevent debris from reaching the device. Debris booms are often comprised of floating wood logs in an upstream pointing “V” and are located upstream of the device; and they are often held in place by a mooring line (Yukon River Inter-Tribal Watershed Council , 2008). Similar to debris deflectors used in bridges, debris booms are designed to deflect surface debris around a device (Figure 11). These devices have been used with some success for surface-mounted turbines; however, like their bridge counterparts, they suffer from the potential for debris accumulation, especially on the mooring line (Figure 1).



Figure 11: Debris boom on 5 kW Encurrent Turbine in Ruby, Alaska (Yukon River Inter-Tribal Watershed Council , 2008)

In preparation for the second deployment season of their 25 kW Encurrent Turbine, AP&T sees refinement of the debris boom as one of the best ways to combat debris (Beste, 2011). The company is planning to build a more robust boom, which extends into the water to help protect the turbine from debris traveling just below the surface (Beste, 2011).

3.4.4 Trash racks

In order to prevent debris throughout the water column from impacting the device, upstream trash racks may be used. While trash racks for hydrokinetic devices share many similarities with those used in dams, there are important distinctions that make their use in hydrokinetics more difficult. The first major issue is debris accumulation. When debris accumulates on the trash rack of a hydroelectric dam, it is removed by a trash rake, which requires a large amount of power and infrastructure to operate. Smaller hydrokinetic devices do not have that luxury. As debris accumulates, it greatly reduces the flow, which is the second major issue with the implementation of trash racks for hydrokinetic devices. The placement of a trash rack occurs far enough upstream that flow can recover its velocity before reaching the turbine. If a trash rack is placed too far upstream, however, debris will also recover in the turbine’s path. These effects were encountered in the University of South Australia’s attempts to implement a turbine in Borneo. During this implementation, debris was found to be a major issue in the jungle environment (Anyi & Kirke, 2010). Attempts to block debris with upstream screens have resulted in significant clogging and blocking of flow (Kirke, 2010). Continued difficulties with clogging have resulted in abandonment of the trash rack as a viable option for debris mitigation (Kirke, 2010).

3.4.5 Blade design

Because of the difficulties associated with blocking or deflecting debris upstream of a device, many manufacturers hope that the design of their blades will effectively shed debris (Anyi et al., 2010). Although quantitative evidence does not exist for the effectiveness of swept blades in their ability to shed debris, companies such as Verdant Power credit their blade designs as being one of the major reasons the company has been able to avoid catastrophic debris problems (Taylor, 2010). Taking swept blades a step further, folding blades are being considered as a way to reduce the impact of debris on a turbine's blades. One such system is currently being designed by the University of South Australia for implementation in Borneo (Kirke, 2010). The effectiveness of folding blades has not yet been tested.

3.4.6 Manual debris removal

While seemingly obvious, one of the most effective and often overlooked techniques for handling debris is direct human observation and removal. In each of their turbines, Thropton Energy enlists the use of a local individual to monitor the device for debris and remove debris as it begins to accumulate (Sexon, 2010). While the company credits a number of debris mitigation techniques, the continued success of their turbines ultimately depends on the monitor's ability to keep it free of debris (Sexon, 2010). Debris removal by individuals may lend itself more to small turbines, such as those installed by Thropton Energy; however, this technique is also being pursued by those responsible for larger turbines. During the first summer of their device's deployment, AP&T often had to remove debris by hand. Despite the size of the barge on which their turbine was mounted, this removal often required the use of an additional vessel (Beste, 2011). The coordination of a second boat in order to extract debris from the anchored turbine was difficult due to water speed and turbulence in the area, often required additional personnel, and significantly increased the risk to those removing the debris (Beste, 2011). Because of this, AP&T is making improvements to their barge so that the two local employees assigned to the project will be able to remove debris safely without the use of additional boats or personnel (Beste, 2011).

4. Conclusions and Recommendations

It is clear that debris in the flow can have a significant deleterious impact on engineered structures. Debris accumulation on bridge piers can lead to increased scour, backwater buildup, and increased structural stress, which has caused bridge failures. In conventional hydroelectric facilities, debris buildup has led to substantial head loss, leading to drastic reductions in efficiency. For hydrokinetic turbines, the effects are potentially more profound. During the summer of 2010, three of the first commercial-scale hydrokinetic devices to enter the rivers of North America experienced periods of discontinuous power production, and had to be entirely removed from the flow because of debris.

Because of the potentially catastrophic consequences of both debris accumulation and debris impact, the development of successful mitigation strategies is critical to the success of hydrokinetic devices. Unfortunately, no methods are in place that both protect the device and prevent head loss due to debris accumulation. It is no coincidence that most of the earliest implementations of commercial-scale

hydrokinetic devices have occurred in rivers or tidal zones where debris is not a major factor. When small-scale devices have been placed in rivers where debris is present, they have often been placed in an area of the flow where debris is less likely to be transported. Despite these best efforts, determining where debris will flow is at best based on probabilities, and while generalizations about flow patterns are often made, exceptions are numerous. In addition, by placing devices in regions that may not contain as much debris, small-scale devices encounter reduced flow conditions. While a reduction in power-generation capability due to device placement in slower currents may be tolerated in small-scale applications, it is unlikely to be acceptable in commercial-scale projects. In the few instances where devices have been installed in debris-heavy flows, countermeasures have been limited in their success. Because of the lack of preceding examples in hydrokinetic devices, it will be important to draw from lessons learned in trying to protect bridge piers and hydroelectric dams.

In both dams and bridge supports, debris racks and debris deflectors have been used to effectively prevent debris from entering penstocks and colliding with piers. The most glaring issue associated with these devices is debris accumulation. In conventional hydroelectric facilities, amassing debris is most commonly managed by removing it with mechanical debris rakes. It seems unlikely that this technique could be easily transferred to smaller hydrokinetic devices that may be submerged in the middle of a river. In addition to the challenge of building and maintaining a raking system for a hydrokinetic device, many mechanical rakes have been shown to have difficulty operating when there are transverse or turbulent conditions. Despite decades of attempts to prevent the buildup of debris on bridge piers, solutions to the debris problems are still evolving. Some of most recent developments, such as debris sweepers, have shown promise, even while results are mixed. Despite the varied levels of satisfaction with debris sweepers, the inclusion of sweeper-like devices may help increase the chances that debris is shed.

It seems likely that, regardless of the device, some amount of debris will accumulate. What small-scale hydroelectric turbines have relied on for years, and what AP&T discovered in 2010, is the human element that is necessary to dealing with accumulating debris. Even hydroelectric dams that keep their debris racks clean using mechanical debris rakes often use divers to inspect the racks to be sure they are clear of debris (Wallerstein & Thorne, 1995). The ability for a debris device to be inspected and potentially cleaned of debris by hand is likely to be an important aspect of a design.

Even without the accumulation of debris, a protective device upstream of a turbine can have a substantial effect on flow rate through the turbine. The head loss through a deflector or other protective device is an important design consideration. Because the efficiency of hydrokinetic devices is more susceptible to small changes in flow speed than hydroelectric dams, it will be more important to consider head loss when deciding on bar geometry and bar spacing for a deflector. Because a more streamlined bar geometry is likely to be necessary, the vibrational effects caused by vortex shedding will also be an important factor.

The need to develop effective strategies for combating river debris has been well realized and may be the most important obstacle that faces commercial-scale hydrokinetic turbines. What is not understood is how best to prevent debris impact and accumulation, without losing flow velocity. Even in fields

where debris deflection and containment have been practiced for decades, no solution has been found. While lessons can be learned from those areas, the development of successful debris-mitigation strategies for hydrokinetic devices is only going to occur through the design, implementation, and refinement of those approaches.

5. Appendices

Appendix A: Maximum impact forces of large woody debris on engineered structures

In their study of impact forces of large woody debris on engineered structures, Haehnel and Daly (2002) investigated three strategies for estimating the impact force. Although they concluded that the three methods were theoretically equivalent, practically, they are not the same. Below is an account of some of their findings.

A.1 Contact Stiffness Approach

This approach used an expression for the maximum impact force adopted from the equation for impact force of vessels on a pier:

$$F_v(kips) = 8.15u\sqrt{DWT}$$

where DWT is the dead-weight tonnage (long tons) of the vessel.

This approach to estimating maximum force uses the effective contact stiffness of the collision of an object at a given speed. Haehnel and Daly found that

$$F_{i,max} = 1550u\sqrt{m}$$

where u is the log velocity and m is the fluid added mass of the log. This approach provides closely coordinated estimates for the maximum force; however, it tends to over-predict impact forces under 10 kN.

A.2 Impulse Momentum Approach

This approach equates the impulse acting on the debris with the change in momentum of the debris, and it is governed by the equation:

$$I = \int F(t)dt = t_i\bar{F}_i = \int d(u_1m_1)$$

where I is the total change in the momentum of debris during the impact, F is the force acting on the debris, and \bar{F}_i is the time-averaged force. By using the assumption that the impact force goes to zero through the period of the collision, the time-averaged force becomes:

$$\bar{F}_i = \frac{u_1m_1}{t_i} = \frac{u_1w_1}{gt_i}$$

where w is the weight of the debris and t_i is the impact duration, which FEMA and the U.S. Army Corps of Engineers suggests a value of 1 s. Through their study, the equation of for the maximum force was found to be:

$$F_{i,max} = 90.9um$$

This equation was found to be limited to logs with masses in the range of 200–330 kg. As a result of assuming a constant impact time, this equation was found to under-predict the forces for the reduced-scale logs used in the tests.

A.3 Work Energy Approach

By assuming that the velocity of the debris goes to zero during collision, this approach equates the work done on the structure with the kinetic energy of the debris element.

$$W = \int F(x)dx = \int d\left(\frac{1}{2}mu^2\right)$$

The force of the impact is a function of the distance, x , over which the collision occurs. Taking S , the stopping distance, to be the distance traveled by the debris as its velocity goes to zero throughout the collision, the maximum force becomes:

$$F_{i,max} = \frac{mu_o^2}{S} = \frac{wu_o^2}{gS} = \frac{2}{S}KE$$

Using this equation as a basis, the maximum impact force was found to be approximated by:

$$F_{i,max} = 125mu^2 + 8000$$

This equation only applies to debris with kinetic energy greater than 50 J, and it was found to over-predict the impact forces as a result of assuming a constant stopping distance for various debris velocities and weights.

A.4 Comparison of the Approaches

In the comparison of each approach with their scaled-laboratory tests, Haehnel and Daly found the contact stiffness approach to be the most accurate over the entire domain. This was primarily a result of the difficulties in measuring the impact time and impact distance needed in the impulse momentum and work energy approaches.

Appendix B: Estimation of the head loss through a trash rack of bars with various geometry

B.1 Equation for the Head Loss Through a Trash Rack

The following equation was developed by Kirschmer, discussed by Zowski (1960), and appeared in Wallerstein and Thorne's (1995) discussion of debris mitigation for hydroelectric dams in Europe.

$$h_l = k \left(\frac{t}{b} \right)^{1/3} \frac{V_o^2}{2g} \sin (\alpha)$$

where

h_l = loss of head through racks, ft

t = thickness of bars, in.

V_o = velocity of approach, ft per sec

g = acceleration due to gravity ft per sec squared

α = angle of bar inclination to horizontal, degrees

K = factor depending on bar shape (estimated values shown below)

B.2 K-factor Values Developed by Zowski

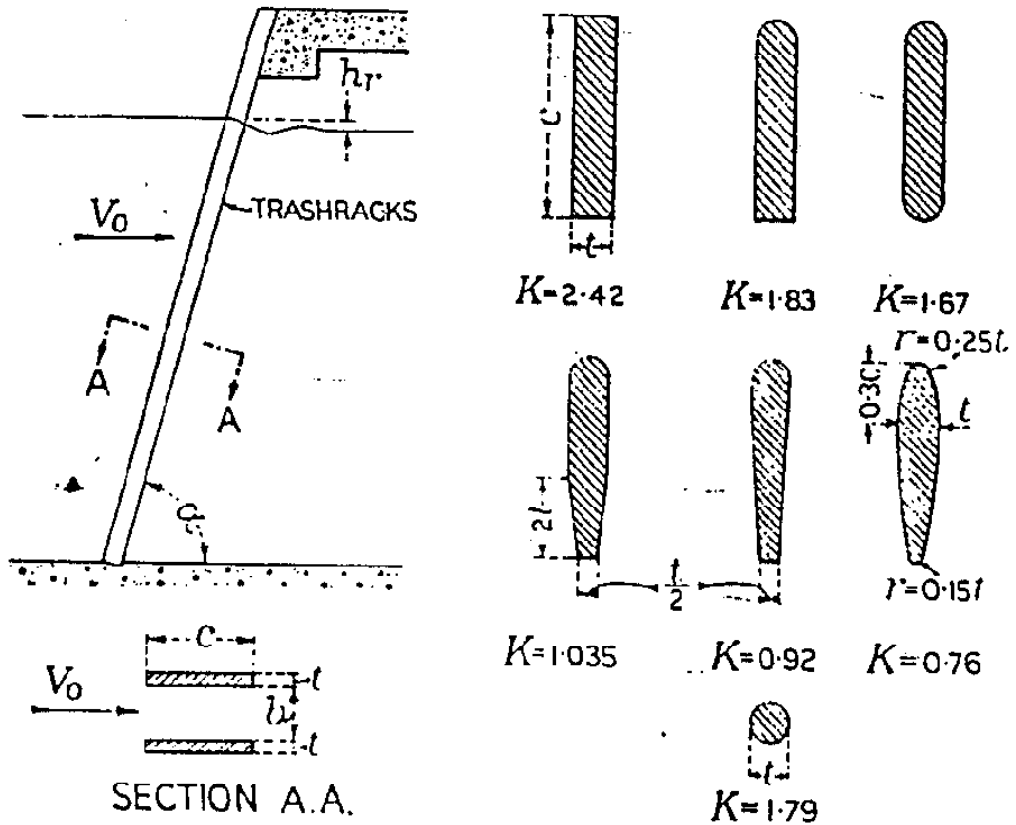

Comparison between the theoretical head loss using Kirschmer and Zowski's development and laboratory tests have found that for a clean rack, the theory underestimated the head loss by a factor of 1.75 to 2 (Bradley et al., 2005). This factor, which is greatly increased when the rack begins to become clogged with debris, was found to be as high as 4 with 50% clogging (Bradley et al., 2005).

Appendix C: Determination of the natural and forcing frequencies associated with trash racks (from Lewin, 1995).

C.1 The Natural Frequency

$$f_n = \frac{\alpha}{2\pi} \sqrt{\frac{EIg}{(m + m_w)L^3}}$$

- where
- f_n = natural frequency
 - E = Young's modulus
 - I = moment of inertia of screen bar
 - m = mass of screen bar
 - m_w = added mass of water; this is the mass of water vibrating with the bar
 - L = length of bar between supports
 - g = gravitational constant
 - α = a coefficient depending on how the bars are fixed to the supports. Typically, bars are welded to the supporting structure, resulting in α values between 16 and 20 for bars between 60 and 70 mm deep with thickness to depth ratios of 5:1.

m_w can be approximated by:

$$m_w = \frac{m}{8} \times \frac{b}{d}$$

- where
- b = the effective spacing between bars
 - d = the thickness of the bar

It has been suggested that the value of b be limited to 0.55 times the bar depth for a bar with a depth to thickness ratio of 10, and 1.0 times bar depth for a depth to thickness ratio of 5.

C.2 The Forcing Frequency Due to Vortex Shedding

$$f_f = \frac{SV}{d}$$

















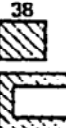

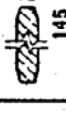

- where
- f_f = forcing frequency
 - S = Strouhal number. This depends on spacing between the bars and the shape of the bars. The limit to the Strouhal number is usually taken to

occur when the bar-spacing-to-bar-thickness ratio is 5 or greater. For a fully rounded bar, this limit leads to $S \approx 0.265$, while a bar with square corners will have a limit of $S \approx 0.155$.

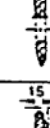
$V =$ approach velocity

$d =$ thickness of screen bar

Appendix D: Details of trash racks that failed during operation (from Syamalarao, 1989)

No.	Power Station (Ref.)	Trashrack form L, B, α° (mm)	Vertical bars		Horizontal bars		Comments
			Shape	Dimensions (mm)	Shape	Dimensions (mm)	
1a	Ybbs-Persenbeug-Bugl 1	$L = 16\ 000$ $B = 12\ 200$ $\alpha = 72^\circ$		$d = 20$ $b = 150$ $s = 150$ $L_2 = 4000$		$d' = 35 \phi$ $s' = 965$	Failure of bolts after one year
1b	Aschach Bugl 2	$L = 21\ 000$ $B = 14\ 200$ $\alpha = 72^\circ$		$d = 17-25$ $b = 200$ $s = 175$ $L_1, L_2, L_3 = 5250$		$d' = 30 \phi$ $s' = 1050$	Horizontal bars cracked or broken after two years
1c	Wallsee-Mittelkirchen Bugl 1	$L = 15\ 800$ $B = 12\ 260$ $\alpha = 72^\circ$		$d = 17-25$ $b = 200$ $s = 175$ $L_1, L_2, L_3 = 5250$		$d' = 35 \phi$ $s' = 965$	Details are not available
2	Corps of Engineers Neilson 4	$L = 20\ 665$ $B = n/a$ $\alpha = 83^\circ$		$d = 19$ $b = 76$ $s = 152$		$d' = 38$ $b' = 38$ $s' = 1320$ $d' \approx 75$ $b' \approx 100$ $s' \approx 1320$	Failure of rack through breaking of vertical bars
3	Hiwassee dam Schol 6	$L = 6100$ $B = 57.44$		$d = 15.9$ $b = 76.2$ $s = 152.4$ $L_1, L_2, L_3 = 762$		$d' = 31.8$ $b' = 300$ $s' = 762$	Failure of anchor bolts
4	La Plate Vanbellingen 7	$L = 4400$ $B = 908$ $\alpha < 90^\circ$		$d = 18$ $b = 180$ $s = 178$		$d' = 15$ $b' = 145$ $s' = 652$	Rack members disconnected, bolts failed after one year
5a	Waldbeck II -original Liess 3	$L = 8950$ $B = 5000$ $\alpha = 72^\circ$		$d = 10$ $b = 70$ $s = 40$ $L_1, L_3 = 2915$ $L_2 = 2950$		$d' = 20 \phi$ $s' = 625$	Bars broken or torn
5b	Waldbeck II -redesigned Liess 3	$L = 8950$ $B = 5000$ $\alpha = 72^\circ$		$d = 15$ $b = 110$ $s = 139$ $L_1, L_3 = 2915$ $L_2 = 2950$		$d' = 20 \phi$ $s' = 625$	No report of damage since 1983
6a	Albbruck-Dogern (1934) Schlageter 5	$L = 13\ 000$ $B = 79\ 000$ $\alpha = 78^\circ$		$d = 16-12$ $b = 120$ $s = 166$ $L_1, L_2, L_3 = 3250$		$d' = 35 \phi$ $s' = 1490$ $- 1758$	Bars broken or missing
6b	Albbruck-Dogern redesigned (1954)	$L = 13\ 000$ $B = 79\ 000$ $\alpha = 78^\circ$		$d = 15-8$ $b = 120$ $s = 166$		$d' = 35 \phi$ $s' = 993$ $- 1557$	Bars broken or missing
6c	Albbruck-Dogern redesigned (1969)	$L = 13\ 000$ $B = 79\ 000$ $\alpha = 78^\circ$		$d = 18$ $b = 150$ $s = 166$		$d' = 45 \phi$ $s' = 820$ $- 1000$	Inspection in 1976 showed damage. Special clamps for horizontal bars were fixed.

E.1 Flowchart for Evaluating Debris Production Potential

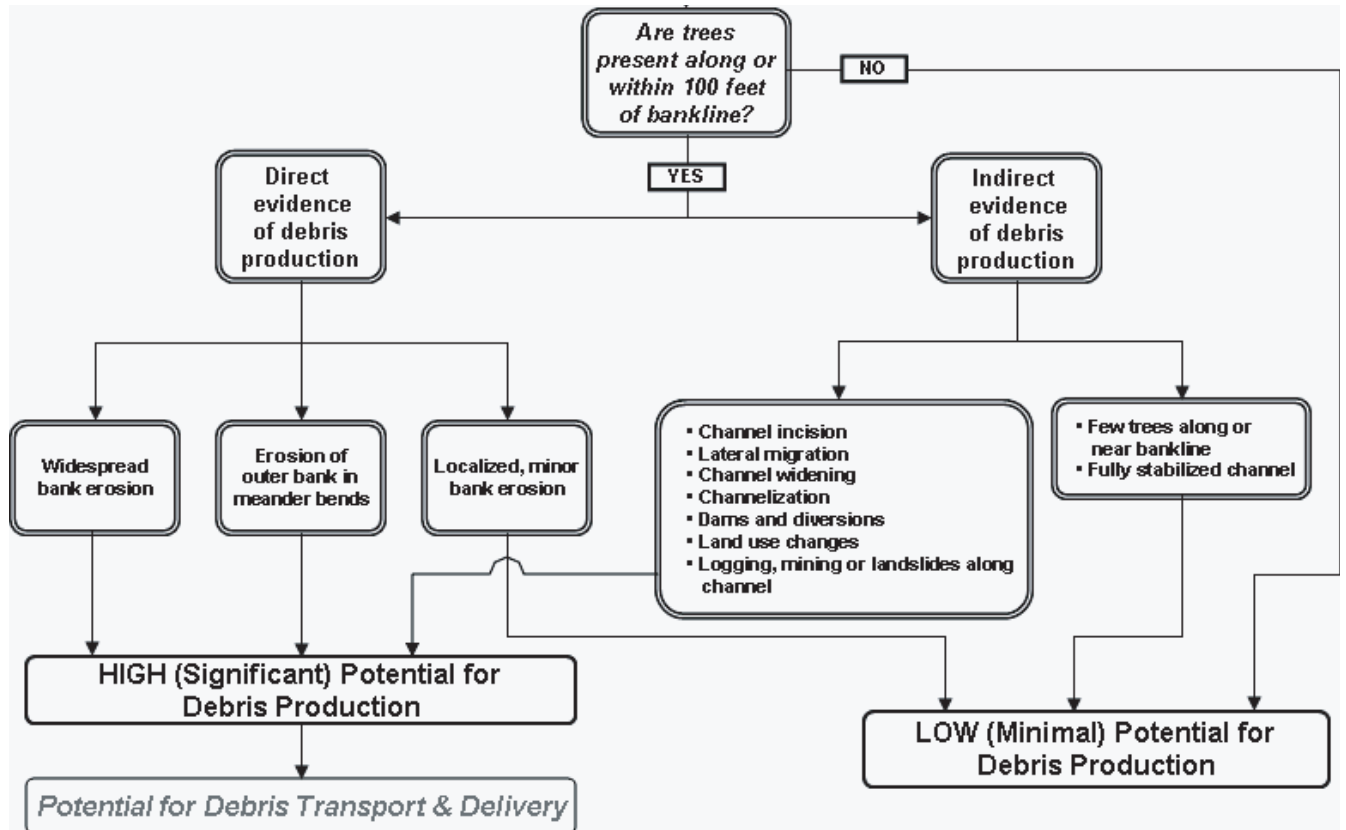

E.2 Flowchart for Evaluating Debris Transport Potential

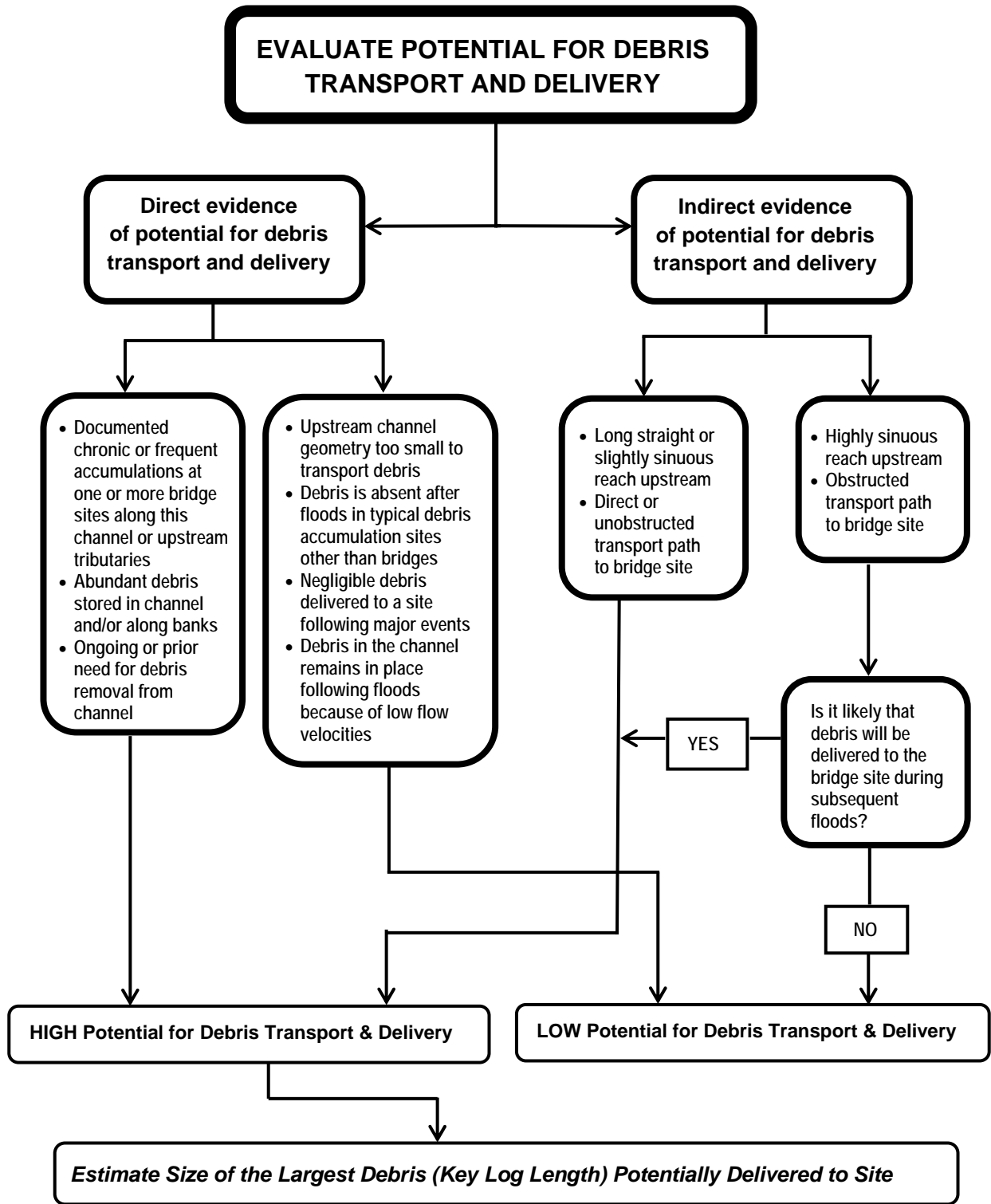

6. Bibliography

- AASHTO. (2007). AASHTO Technical Committee on Hydrology and Hydraulics Spring 2007 Meeting Minutes. (pp. 14-15). Amelia Island, FL: American Association of State Highway and Transportation Officials.
- Anyi, M., & Kirke, B. (2010, February 22). Evaluation of small axial flow hydrokinetic turbines for remote communities. *Energy for Sustainable Development* .
- Anyi, M., Kirke, B., & Ali, S. (2010). Remote community electrification in Sarawak, Malaysia. *Renewable Energy* , v35 n7: 1609-1613.
- Beste, B. (2011, January 12). Alaska Power and Telephone Representative. (R. Tyler, Interviewer)
- Bradley, J., Richards, D., & Bahner, C. (2005). *Debris Control Structures - Evaluation and Countermeasures*. Salem, OR: U.S. Department of Transportation: Federal Highway Administration.
- Chang, F. F., & Shen, H. W. (1979). *Debris problems in the river environment*. Federal Highway Administration.
- Daly, S. (2010, December 28). Research Hydraulic Engineer at the US Army Cold Regions Research and Engineering Laboratory. (R. Tyler, Interviewer)
- Haehnel, R. B., & Daly, S. F. (2002). *Maximum Impact Force of Woody Debris on Floodplain Structures*. Hanover, NH: Army Corps of Engineers Engineer Research and Development Center.
- Hands On: The Earth Report. (2004). *The River Runs Through It (Report 2 of 5)*. www.TVE.org.
- Hydro Component Systems. (2007). *Hydro Component Systems Trash Raker Photos*. Retrieved January 15, 2011, from Hydro Component Systems:
http://www.hydrocomponentsystems.com/photo_gallery/trash_raker/
- Hydro Green Energy, LLC. (2010). *Hydro Green Energy*. Retrieved January 9, 2011, from www.hgenenergy.com
- Johnson, J. B., & Pride, D. J. (2010). *River, Tidal, and Ocean Current Hydrokinetic Energy Technologies: Status and Future Opportunities in Alaska*. Fairbanks, AK: Alaska Center for Energy and Power.
- Kirke, B. (2010, November 7). Adjunct Senior Research Fellow, Univeristy of South Australia. (R. Tyler, Interviewer)
- Lagasse, P. C. (2010). *Effects of Debris on Bridge Pier Scour (NCHRP Report 653)*. Washington, D.C.: National Cooperative Highway Research Program.
- Lewin, J. (1995). *Hydraulic gates and valves in free surface flow and submerged outlets*. New York, NY: Thomas Telford.

Lyn, D. A., Cooper, T. J., Condon, C. A., & Gan, L. (2007). *Factors in Debris Accumulation at Bridge Piers*. West Lafayette, IN: Purdue e-Pubs.

Oppenheimer, M. L., & Saunders, S. (1995). *Patent No. 5,839,853*. United States of America.

Red River woody debris and predator avoidance. Red River, Manitoba. (2007, October 5). Retrieved January 22, 2011, from YouTube: <http://www.youtube.com/watch?v=Sd6z8zNM5hQ&feature=related>

Saunders, S., & Oppenheimer, M. L. (1993). A method of managing floating debris. *Hydraulic Engineering '93: Proceedings of the 1993 Conference* (pp. 1373-1378). New York, NY: The American Society of Civil Engineers.

Sxon, B. (2010, November 11). Thropton Energy Representative. (R. Tyler, Interviewer)

Syamalarao, B. (1989). *A review of trashrack failures and related investigations*. Water & Dam Construction.

Taylor, T. (2010, November 13). Verdant Power, Inc. Representative. (R. Tyler, Interviewer)

Thompson, R. (2010, December 16). Lessons Learned from Turbine Project. *Northern News Service: Deh Cho Drum*, pp. 3-4.

Wallerstein, N., & Thorne, C. (1995). *Debris Control at Hydraulic Structures in Selected Areas of Europe*. Nottingham, England: University of Nottingham, Department of Geography.

Yukon River Inter-Tribal Watershed Council . (2008). *YRITWC - Energy*. Retrieved January 9, 2011, from YRITWC Website: <http://www.yritwc.org/Departments/Energy.aspx>

Zowski, T. (1960, September and October). Trashrack and raking equipment. *Water Power*.