



Rocky Mountain Ham Radio

Teach...learn...operate...support. Be a part of our team.

RMHAM University

Antennas by Doug Sharp, K2AD

January 25, 2020

Willem says ...

Our next RMHAM University is by Doug K2AD and Chris AE5IT on "How Feedlines and Antennas Work." This talk covers how RF energy travels from the transmitter along the feed line to the antenna, reflections, **SWR and radiation, as well as how the antenna radiates, dipoles, long wires and co-linears.** If you ever wanted to SEE how your transmitted signal travels along the feed line and radiates, this talk is a real treat.

Doug says ...

OK, I can do that. But I'm going to "borrow" a lot of the material. But I will put references at the bottom of each slide so you can look see the original articles.



Rocky Mountain Ham Radio

Teach...learn...operate...support. Be a part of our team.

First some theory

Gut Feel Rules

Antenna Gain

- Gain is good as long as it is in the right direction.
 - Gain indicates the ability of an antenna to "focus" or direct radio frequency energy. Newton said, "Energy cannot be created nor destroyed." An antenna follows this same rule it cannot create RF energy, only focus or direct that energy.
 - Antenna gain is measured in decibels (dB) and referenced to a "standard reference antenna", usually an isotropic or a dipole.
 - An isotropic is an imaginary antenna that radiates equally well in all directions. It is defined to have 0 dB gain (0 dBi).
 - The half wave dipole is the most common reference antenna since it can be built! It is defined as having 0 dBd of gain, or 2.3 dBi of gain.
- Antenna ranges are used to measure antenna gain, and results can vary greatly. The National Institute of Standards and Technology (NIST, formerly NBS) have a published standard that is becoming widely accepted.
 - When shopping for antennas in the magazines make sure you are comparing apples to apples!
 - As gain increases, the beamwidth of the antenna decreases. And vice versa.
 - Antenna gain is proportional to antenna size or aperture. If you double the size of an antenna you can obtain up to 3 dB gain.
 - Antenna gain can be obtained by stacking antennas. If you double the number of antennas you can achieve up to 3 dB of gain.

More “stolen” material from WB2 Kiss My Yagi

Yagi Antenna Design

- Use a good cookbook design or design rules.
- HF - W2PV, K8CC, NBS, Handbook, Antenna book.
- VHF - DL6WU, K1FO, NBS, W1JR.
- Construction will change design. W2PV book is excellent bible.
- Element Mounting - boom connection or not. Thru or top mount.
- Must be stable over time from weathering.
- More elements do not mean more gain. Boomlength is important.
- Elements should be tapered at HF to reduce windloading.
- VHF elements usually one size material.
- Build to last!

Antenna Stacking

- Antennas can be stacked to obtain more gain.
- Up to 3 dB gain can be achieved.
- Stacking distance must be correct otherwise gain and pattern will degrade.
- Make sure the antennas are in phase!
- Use power splitters or odd multiple 1/4 wave cables.

From an old presentation to the Lynchburg Amateur Radio Club, October 8, 1993 by WB2KMY / now K2AD

Isotropic Radiators

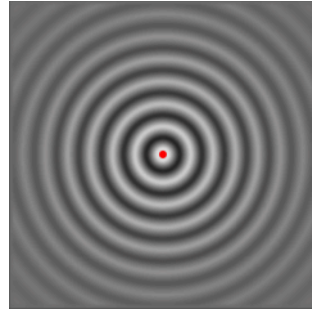

From Wikipedia

- An **isotropic radiator** is a theoretical [point source](#) of [electromagnetic](#) or [sound waves](#) which radiates the same intensity of radiation in all directions. It has no preferred direction of radiation. It radiates uniformly in all directions over a sphere centred on the source. Isotropic radiators are used as reference radiators with which other sources are compared, for example in determining the [gain](#) of [antennas](#)
- You can't actually build it
- Antenna gain often referenced with respect to an isotropic (dBi)

Half Wave Dipole and Inverted Vee

A great article on the RSGB web site ...

- Easy to build
- Easy to install
- Good performance
- Reference for many antenna gain measurements (reference dBd)
- Has 2.1 dB gain over an isotropic

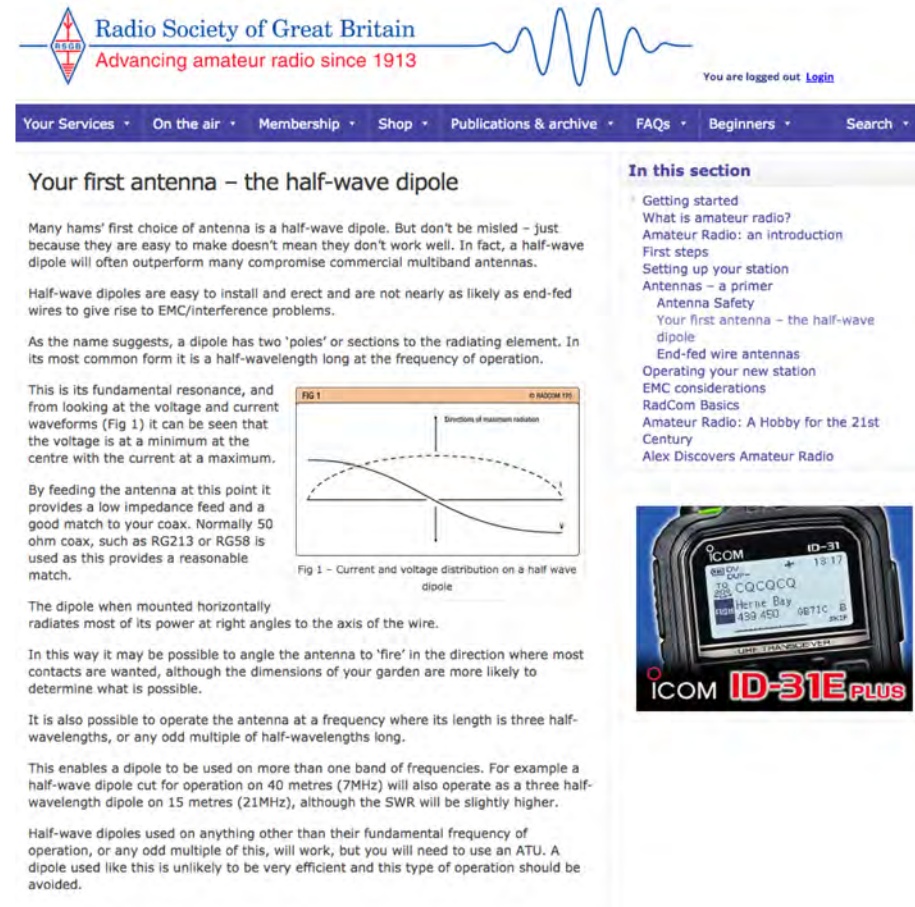

The screenshot shows the RSGB website header with the logo and navigation menu. The main article title is "Your first antenna – the half-wave dipole". The text explains that a half-wave dipole is a common choice for amateurs due to its ease of construction and performance. It describes the current and voltage distribution on the antenna, showing a diagram (Fig 1) where current is at a maximum at the center and voltage is at a minimum. The article also discusses radiation patterns, impedance matching, and the possibility of using the antenna on multiple frequency bands.

Radio Society of Great Britain
Advancing amateur radio since 1913

You are logged out [Login](#)

Your Services ▾ On the air ▾ Membership ▾ Shop ▾ Publications & archive ▾ FAQs ▾ Beginners ▾ Search ▾

Your first antenna – the half-wave dipole

Many hams' first choice of antenna is a half-wave dipole. But don't be misled – just because they are easy to make doesn't mean they don't work well. In fact, a half-wave dipole will often outperform many compromise commercial multiband antennas.

Half-wave dipoles are easy to install and erect and are not nearly as likely as end-fed wires to give rise to EMC/interference problems.

As the name suggests, a dipole has two 'poles' or sections to the radiating element. In its most common form it is a half-wavelength long at the frequency of operation.

This is its fundamental resonance, and from looking at the voltage and current waveforms (Fig 1) it can be seen that the voltage is at a minimum at the centre with the current at a maximum.

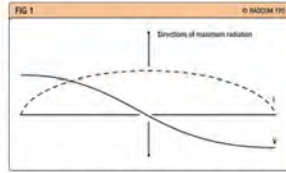

By feeding the antenna at this point it provides a low impedance feed and a good match to your coax. Normally 50 ohm coax, such as RG213 or RGS8 is used as this provides a reasonable match.

The dipole when mounted horizontally radiates most of its power at right angles to the axis of the wire.

In this way it may be possible to angle the antenna to 'fire' in the direction where most contacts are wanted, although the dimensions of your garden are more likely to determine what is possible.

It is also possible to operate the antenna at a frequency where its length is three half-wavelengths, or any odd multiple of half-wavelengths long.

This enables a dipole to be used on more than one band of frequencies. For example a half-wave dipole cut for operation on 40 metres (7MHz) will also operate as a three half-wavelength dipole on 15 metres (21MHz), although the SWR will be slightly higher.

Half-wave dipoles used on anything other than their fundamental frequency of operation, or any odd multiple of this, will work, but you will need to use an ATU. A dipole used like this is unlikely to be very efficient and this type of operation should be avoided.

In this section

- Getting started
- What is amateur radio?
- Amateur Radio: an introduction
- First steps
- Setting up your station
- Antennas – a primer
- Antenna Safety
- Your first antenna – the half-wave dipole
- End-fed wire antennas
- Operating your new station
- EMC considerations
- RadCom Basics
- Amateur Radio: A Hobby for the 21st Century
- Alex Discovers Amateur Radio



<https://rsgb.org/main/get-started-in-amateur-radio/antennas/your-first-antenna-the-half-wave-dipole/>

Half Wave Dipole

Your first antenna – the half-wave dipole

Many hams' first choice of antenna is a half-wave dipole. But don't be misled – just because they are easy to make doesn't mean they don't work well. In fact, a half-wave dipole will often outperform many compromise commercial multiband antennas.

Half-wave dipoles are easy to install and erect and are not nearly as likely as end-fed wires to give rise to EMC/interference problems.

As the name suggests, a dipole has two 'poles' or sections to the radiating element. In its most common form it is a half-wavelength long at the frequency of operation.

This is its fundamental resonance, and from looking at the voltage and current waveforms (Fig 1) it can be seen that the voltage is at a minimum at the centre with the current at a maximum.

By feeding the antenna at this point it provides a low impedance feed and a good match to your coax. Normally 50 ohm coax, such as RG213 or RG58 is used as this provides a reasonable match.

The dipole when mounted horizontally radiates most of its power at right angles to the axis of the wire.

In this way it may be possible to angle the antenna to 'fire' in the direction where most contacts are wanted, although the dimensions of your garden are more likely to determine what is possible.

It is also possible to operate the antenna at a frequency where its length is three half-wavelengths, or any odd multiple of half-wavelengths long.

This enables a dipole to be used on more than one band of frequencies. For example a half-wave dipole cut for operation on 40 metres (7MHz) will also operate as a three half-wavelength dipole on 15 metres (21MHz), although the SWR will be slightly higher.

Half-wave dipoles used on anything other than their fundamental frequency of operation, or any odd multiple of this, will work, but you will need to use an ATU. A dipole used like this is unlikely to be very efficient and this type of operation should be avoided.

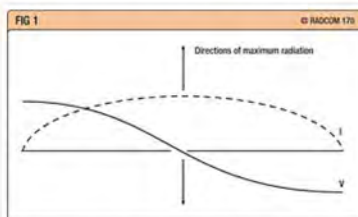

Fig 1 – Current and voltage distribution on a half wave dipole

Dipole construction

A dipole is quite easy to construct. The length of a half-wave dipole might be thought to be the same as a half-wavelength of the signal in free space, but this is not quite the case. A number of effects, including the velocity factor of the wire, the length / diameter of the wire used for the radiating element and capacitive end effects, mean that the actual length required is a little shorter.

Without the end effect the length of a dipole could be calculated from the formula length (metres) equals $150 / f$, where f is the frequency in MHz. With the foreshortening effects the length can be approximated from the formula: Length (metres) = $143 / f$ (MHz)

The lengths calculated from this should only be considered as an approximate value – it is best to cut the wire slightly longer than this and then twist the end of the wire back on itself to give the best match.

For a transmitting station one of the easiest ways is to monitor the reflected power on a voltage standing wave ratio, or VSWR, meter.

If operation is tried at different points on the band (taking care not to cause interference) it will be noted that the VSWR is higher at some points than others.

A plot can be made and should look something like Fig 2. The length of the antenna should be adjusted to give the lowest overall level in the areas of interest of the band. For example if operation is envisaged in the SSB section in the middle of the band, the minimum can be adjusted so that it occurs in this section, whilst still maintaining an acceptable level in other sections of the band. If the minimum VSWR point occurs too low in frequency, the length of the antenna can be shortened.

If it occurs too high in frequency it means the antenna is too short and needs to be lengthened somehow. Putting wire back is not nearly as easy as taking some wire off!

Antenna analysers can also be used and these can give a better indication of the operation of an antenna.

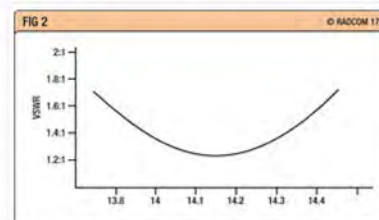
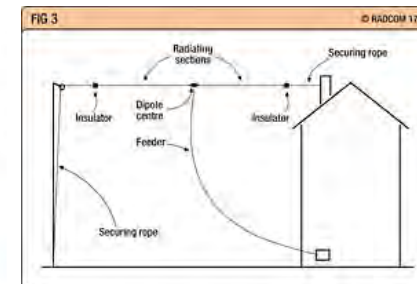

Fig 2: Typical VSWR plot for a half-wave dipole



Inverted Vee and Baluns

Inverted-V dipoles

The maximum radiation from a dipole takes place in the centre. Accordingly, this is the most important area of the antenna to keep as high as possible.

Coupled with the fact that in many situations it is only possible to have one high mast or high point on the antenna, this often makes an inverted-V dipole (Fig 5) an ideal choice.

The antenna is basically an ordinary dipole, but rather than keeping it horizontal, a single mast or anchor point is used in the centre and the two halves of the dipole are angled downwards away from the central mast.

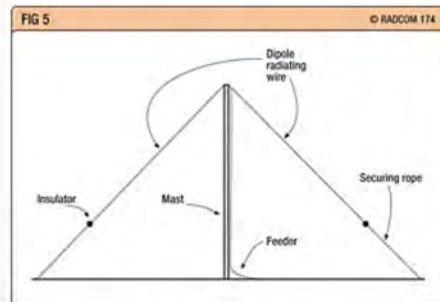

Fig 5: An inverted-V dipole

Although it does alter the radiation pattern, making it almost omni-directional, its basic operation remains the same. In view of its convenience and operational advantages this type of antenna is widely used and is a favourite with many operators.

The main point to note when erecting a dipole is that the lower ends of the antenna should be kept out of reach of people.

The ends of the antenna will have a high voltage when used for transmitting and the installation should be such that it is not possible to touch them. Also, if the ends come down too low you could get ground losses – keep them at least three metres high if possible.

The securing ropes should also be installed so that people cannot trip or stumble over them. A suitably-located tree or bush may help overcome this problem.

Baluns

Question: Do I need one?

Answer: They are useful but not absolutely necessary

Question: They come in 1:1 and 4:1 – Which one do I need?

Answer: What is the feed impedance of your antenna?

Question: What should I use?

Answer: I suggest either the W2AU or MFJ product available at our local HRO store



<https://rsgb.org/main/get-started-in-amateur-radio/antennas/your-first-antenna-the-half-wave-dipole/>

Dipole Variants

Other variants [edit]

There are numerous modifications to the shape of a dipole antenna which are useful in one way or another but result in similar radiation characteristics (low gain). This is not to mention the many [directional antennas](#) which include one or more dipole elements in their design as [driven elements](#), many of which are linked to in the information box at the bottom of this page.

- The *bow-tie antenna* is a dipole with flaring, triangular shaped arms. The shape gives it a much wider bandwidth than an ordinary dipole. It is widely used in UHF [television antennas](#).
- The *cage dipole* is a similar modification in which the bandwidth is increased by using fat cylindrical dipole elements made of a "cage" of wires (see photo). These are used in a few broadband array antennas in the [medium wave](#) and [shortwave](#) bands for applications such as [over-the-horizon radar](#) and [radio telescopes](#).
- A *halo antenna* is a half-wave dipole bent into a circle.^[a] With a horizontal circle, this produces horizontally polarized radiation in a nearly omnidirectional pattern with reduced power wasted toward the sky compared to a bare horizontal dipole.
- A *turnstile antenna* comprises two dipoles crossed at a right angle and feed system which introduces a quarter-wave phase difference between the currents along the two. With that geometry, the two dipoles do not interact electrically but their fields add in the far-field producing a net radiation pattern which is rather close to [isotropic](#), with horizontal polarization in the plane of the elements and [circular](#) or elliptical polarization at other angles. Turnstile antennas can be stacked and fed in phase to realize an omnidirectional broadside array or phased for an end-fire array with circular polarization.
- The *batwing antenna* is a [turnstile antenna](#) with its linear elements widened as in a bow-tie antenna, again for the purpose of widening its resonant frequency and thus usable over a larger bandwidth, without re-tuning. When stacked to form an array the radiation is omnidirectional, horizontally polarized, and with increased gain at low elevations, making it ideal for television broadcasting.
- A 'V' (or "Vee") antenna is a dipole with a bend in the middle so its arms are at an angle instead of co-linear.
- A *Quadrant antenna* is a 'V' antenna with an unusual overall length of a *full* wavelength, with two half-wave horizontal elements meeting at a right angle where it is fed.^[18] Quadrant antennas produce mostly [horizontal polarization](#) at low to intermediate elevation angles and have nearly [omnidirectional](#) radiation patterns.^[19] One implementation uses "cage" elements (see above); the thickness of the resulting elements lowers the high driving point impedance of a full-wave dipole to a value that accommodates a reasonable match to open wire lines and increases the bandwidth (in terms of SWR) to a full octave. They are used for HF band [transmissions](#).
- The *G5RV Antenna* is a dipole antenna fed indirectly, through a carefully chosen length of 300Ω or 450Ω [twin lead](#), which acts as an impedance [matching network](#) to connect (through a [balun](#)) to a standard 50Ω coaxial transmission line.
- The *sloper antenna* is a slanted vertical dipole antenna attached to the top of a single tower. The element can be center-fed or can be end-fed as an unbalanced monopole antenna from a transmission line at the top of the tower, in which case the monopole's "ground" connection can better be viewed as a second element comprising the tower and/or transmission line shield.
- The *inverted "V" antenna* is likewise supported using a single tower but is a balanced antenna with two symmetric elements angled toward the ground. It is thus a half-wave dipole with a bend in the middle. Like the *sloper*, this has the practical advantage of elevating the antenna but requiring only a *single* tower.
- The *AS-2259 Antenna* is an inverted-'V' dipole antenna used for local communications via [Near Vertical Incidence Skywave](#) (NVIS).



Cage dipole antennas in the Ukrainian UTR-2 radio telescope. The 8 m by 1.8 m diameter galvanized steel wire dipoles have a bandwidth of 8–33 MHz.

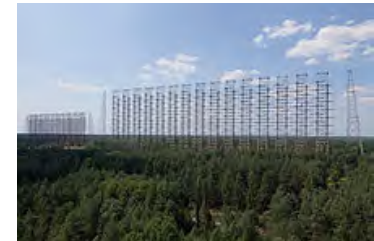

Many many cage dipoles used on the DUGA-2 RADAR in Russia

Folded Dipole

- Can be used on HF or VHF
- Common driven element for VHF / UHF Yagi antennas

Folded Dipoles

A variation of the dipole is an antenna called a folded dipole. It radiates like a dipole but sort of looks like a **squashed** quad.

Having a folded dipole does **not** mean that you have an antenna that is folded in half and so you obtain an antenna that now takes up half the space of a regular dipole. No, the antenna is still approximately the same length as a regular dipole. It *is* however, an antenna that has a wire folded back over itself, hence its name. Below is a picture of a folded dipole.

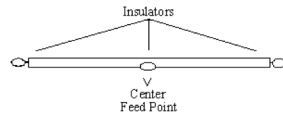

The starting formula for the folded dipole calculation is the same as a dipole, $468 / \text{Frequency (in MHz)}$. Let's try an example: Design a folded dipole for the 40 meter band. The frequency that is chosen might be 7.15 MHz. Plugging this in to the formula ($468 / 7.15$) gives a folded dipole with a length of 65.45 feet. When I modeled a dipole on the computer at 30 feet, I came up with a length of 65.47 feet. When I added a second wire to make the folded dipole shown above, I designed the antenna with 1 inch spacing between the two wires. Note that this adds 1 more inch to each of the two antenna wires over that of a single wire dipole. This plus the fact that we are actually turning up the ends of the antenna, means that the horizontal length actually need to be a little shorter to be once again at resonance. The total length came to 64.38 feet, 1.09 feet shorter than the straight dipole. If you use a greater spacing, say 1 foot between the wires the length is 63.1 feet, 2.37 feet shorter. So be sure to shorten the antenna a bit or you'll find yourself operating lower down the band than you expected.

The feed point impedance is also modified by the second wire. Let's say the original dipole was 72 ohms. The step-up for a two wire folded dipole is 4 times which means $4 * 72 = \sim 288$ ohms. (The computer shows 281 ohms on my example, but remember, we reduced the length slightly also.) This step up continues if you add more and more wires. A three wire antenna would provide a step-up of 9, and a four wire antenna provides a step-up of 16.

We can see why this step-up occurs by looking at the power formula $P = (I^2) * R$, this can be rewritten as $R = P / (I^2)$. If the power to a regular dipole antenna was 100 watts and the current was 1.2 amps, we'd solve for R as $R = 100 / (1.2^2)$, which is the same as $R = 100 / 1.44$, which is 69.44 ohms. In the folded dipole the wires are in parallel, the current must be divided between the two wires. The current in each is half and the total power has not changed, so now the formula is $R = 100 / (.6^2)$, which is the same as $R = 100 / .36$, which of course is 277.77 ohms, 4 times the normal dipole antenna.

So now you ask, why would anyone want an antenna with a feed point impedance of 277 ohms, my coax cable is 50 ohms! Well let's say you wanted to feed the antenna, not with 50 ohm cable but with 300 ohm twin lead? Ah ha, now we have a decent match and a feed line that can also handle a higher SWR with low loss. You'd probably use a tuner (ATU) in the shack to match the 50 ohm radio to the 300 ohm feed line. You could also use the antenna on other bands with the tuner and have an efficient antenna system.

What are the drawbacks to the antenna? Well for one, the currents on each wire will begin to cancel each other out on even multiples of the *cut* frequency, so a 40 meter folded dipole should not be used on 14 MHz. On other bands even though the signal may cancel broad side to the antenna, you'll find that there is actually gain! This occurs about 45 degrees off broad side to the antenna. And this might make for interesting contacts.



Folded Dipole from Telewave



SINCLAIR
A DIVISION OF ROBERT INTERNATIONAL, INC.

Folded Dipole used as a Driven Element on a Sinclair Yagi

<https://www.qsl.net/w4sat/fdipole.htm>

Quarter Wave Ground Plane

Ahh, the good old quarter wave ground plane! This calculator can be used to design a Quarter Wave Ground Plane antenna, with radials. The radiating element is a quarter wave ($\lambda/4$) and the radials are 12% longer. There are usually four radials, three being a minimum, but you could use up to six. This is a true unbalanced antenna, with a feed impedance of around 50Ω and therefore a great match to 50Ω unbalanced feedline. The velocity factor is set to 95% which should be fine for most people. You could cut a little on the large side and trim the antenna for best match at your desired frequency if you have the equipment.

These antennas can easily be built for UHF or above by using a chassis mount N-Type (or SO-239) connector, some solid wire and solder. For VHF and below, as the elements get bigger, some more structured design is needed.

A quarter wave monopole mounted against a perfect ground will have an impedance of around 36Ω but by bending the radials down at an angle of 45° , we increase this to around 50Ω whilst at the same time lowering the radiation angle more towards the horizon. (42° is the theoretical perfect angle for 50Ω feed, but who's measuring!)

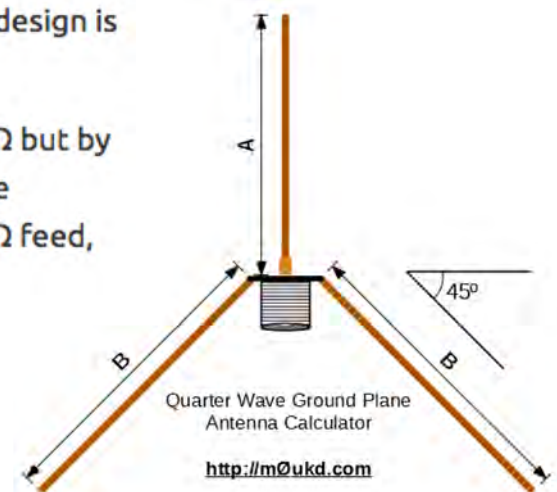

More info: <https://m0ukd.com/calculators/quarter-wave-ground-plane-antenna-calculator/>

J-pole antenna

- Inexpensive
- Easy / Simple to build
 - Copper pipe
 - Twin lead
 - Wire and spacers
- It has some gain
- Signal mostly at the horizon

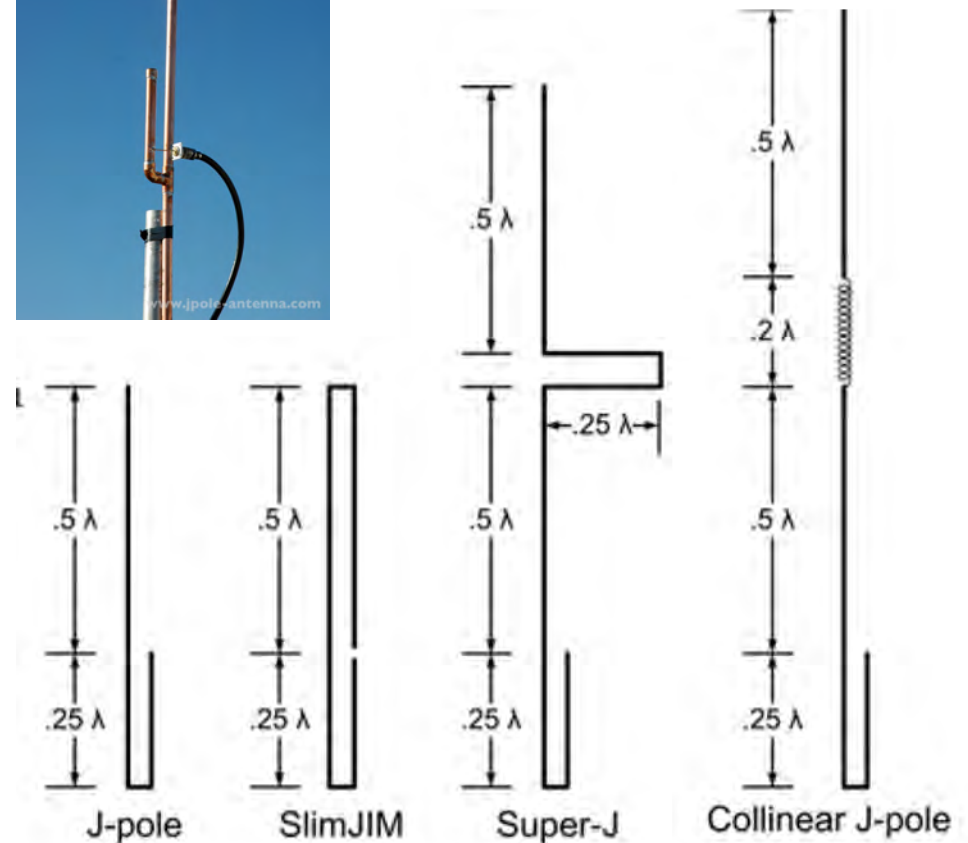
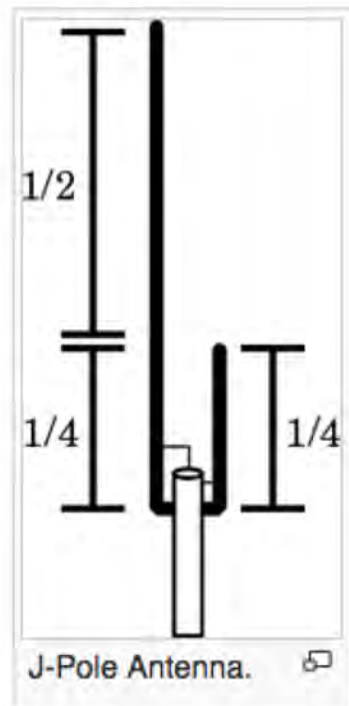

More info: https://en.wikipedia.org/wiki/J-pole_antenna

Coaxial collinear

- Think of it as a phase corrected radiating surface
- Build out of metal tubing or coaxial cable
- A longer antenna has more gain ... with some limitations
- Commercial versions
 - LMR Fiberglass Omnis
 - Super Stationmaster
- Is this a complete design? →
 - No

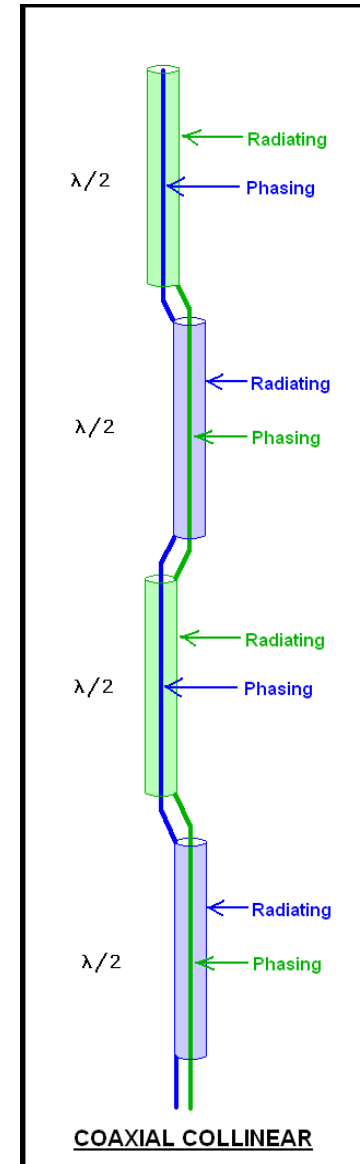

Coaxial collinear

- De-couple at the feed
- A number of $\frac{1}{2}$ wave sections to radiate
- A $\frac{1}{4}$ wave section at the top

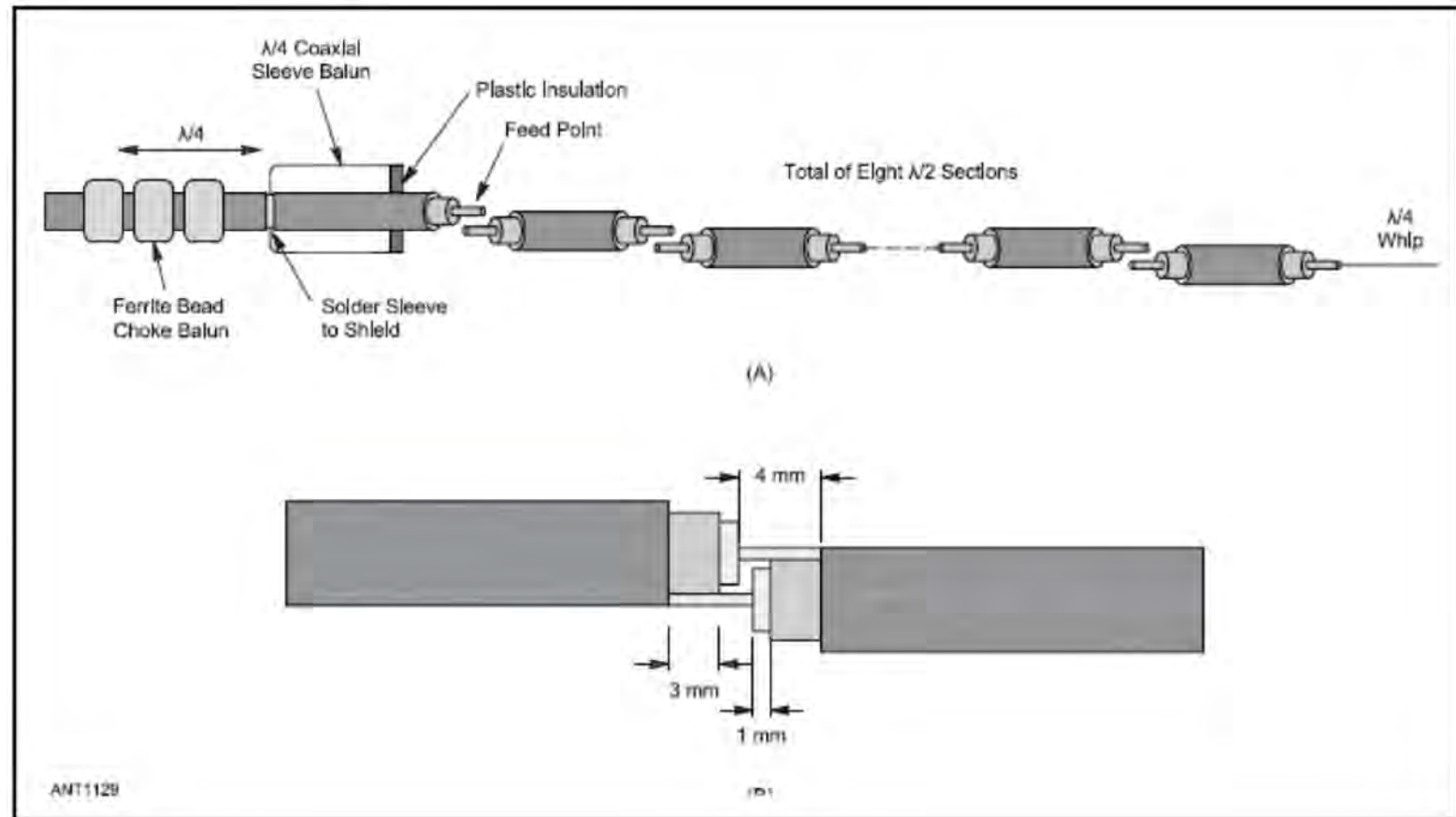

Coaxial collinear – K2AD Recipe

- A** • A $\frac{1}{4}$ wave section at the top with $\frac{1}{4}$ wave whip
- B** • A number of $\frac{1}{2}$ wave sections to radiate
 - Solder – The bigger the blob, the better the job
- C** • A $\frac{1}{4}$ wave section at the bottom
- D** • De-couple at the feed with quarter wave stub
- E** • Any length feedline to your radio

Note: Compensate coaxial sections for the cable velocity factor!

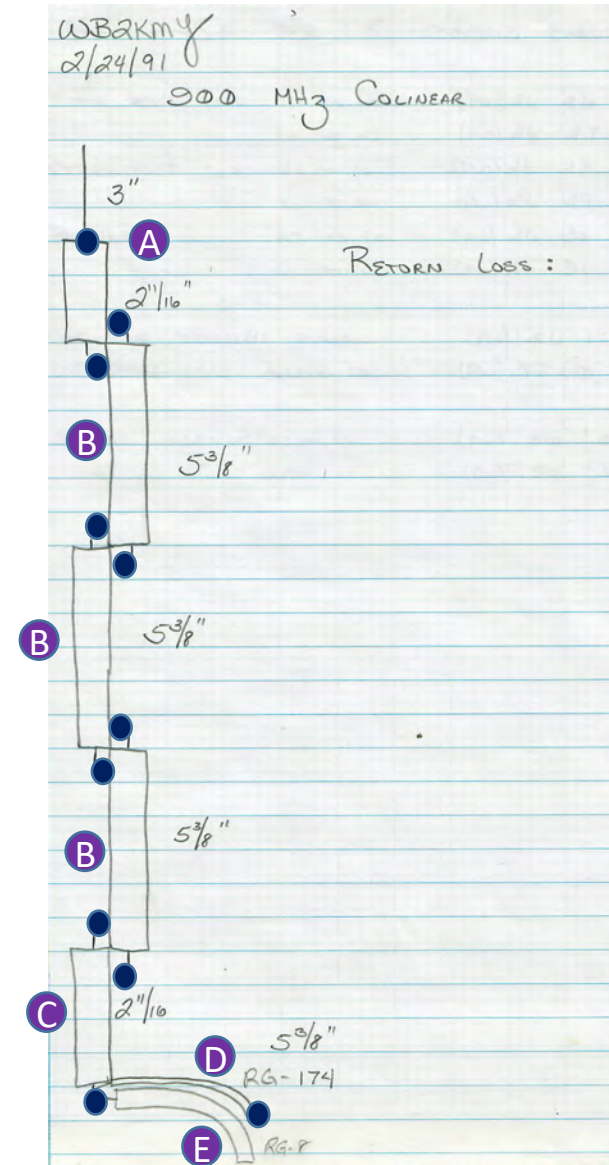

Antenna Uptilt and Downtilt

- What happens if I use an antenna above or below the design frequency?
- Do I only have to worry about VSWR or Return Loss?
- The answer is YES!

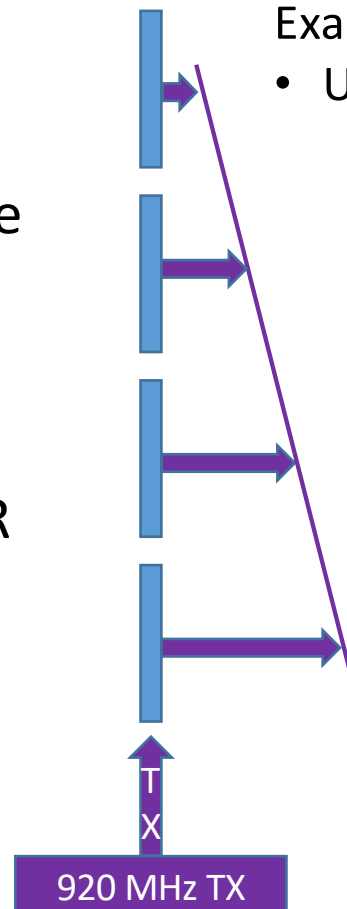

Example:

- Using an 800 MHz antenna at 920 MHz

- Up in frequency →
- Section too long →
- Too much delay →
- Signal there late →
- Signal radiated late →

Result

- Increase in frequency causes up-tilt
- Decrease in frequency causes down-tilt

The folded Dipole and Antenna Uptilt and Downtilt



Example 1:

Let's take an off-the-shelf commercial VHF/UHF Repeater Antenna

- Folded Dipole elements
- Equal length coaxial cables to each element (A,B,C,D)

Result = Maximum radiation at the horizon

Example 2:

Let's take the same antenna as shown in Example 1

- Folded Dipole elements
- But we will vary the length of the phasing lines to the dipoles (Less cable to A&B, more cable to C&D)

Result = Downtilt with maximum radiation below the horizon

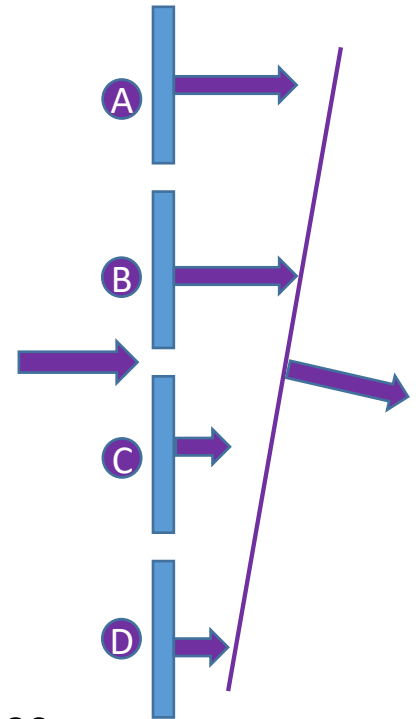

Test and Measurement Equipment

From the December 2018 RMHAM University by Bob Witte, KONR

Why do we need electronic measurements?

- **Bob's First Law of Electronic Measurement**
With electricity, most of the time we cannot observe what is going on without measuring instruments.
- **Bob's Second Law of Electronic Measurement**
When we can observe electricity directly, it is often a bad thing.



Bob Witte KØN

It's not just good ... it's good enough!

How do I know if it works?

- Antenna analyzer
- simple VSWR meter

And, the impedance and reactance are perfect!

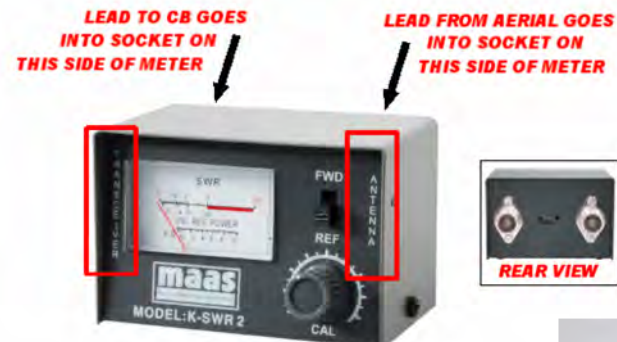

- Return Loss Meter



VSWR to Return Loss

VSWR TO RETURN LOSS AND RETURN LOSS TO VSWR

RETURN LOSS (DB)	VSWR	VOLTAGE REFLECTION COEFFICIENT
1	17.391	0.891
2	8.724	0.794
3	5.848	0.708
4	4.419	0.631
5	3.570	0.562
6	3.010	0.501
7	2.615	0.447
8	2.323	0.398
9	2.100	0.355
10	1.925	0.316
11	1.785	0.282
12	1.671	0.251
13	1.577	0.224
14	1.499	0.200
15	1.433	0.178
16	1.377	0.158
17	1.329	0.141
18	1.288	0.126
19	1.253	0.112
20	1.222	0.100
21	1.196	0.089
22	1.173	0.079
23	1.152	0.071
24	1.135	0.063
25	1.119	0.056
26	1.105	0.050
27	1.094	0.045
28	1.083	0.040
29	1.074	0.035
30	1.065	0.032

$$SWR = \frac{1 + \sqrt{P_r/P_f}}{1 - \sqrt{P_r/P_f}}$$

$$RL(\text{dB}) = 10 \log_{10} \frac{P_i}{P_r}$$

Measuring Gain of an Antenna

Antenna Range - It's not that complicated. You just need some calibrated test equipment.

- Transmitting location
- Receiving location
- Free space in-between
- First measure a reference antenna
- Now measure the test antenna
- Turn the test antenna
- Measure gain while turning

And there you have it fish bulb

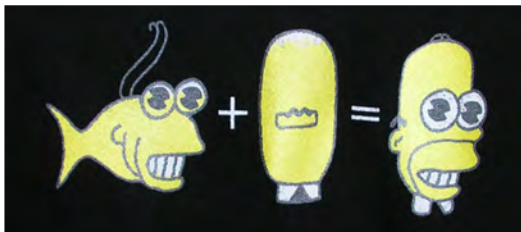

Marc Thorson, WBØTEM, has run our VHF/UHF antenna range for many years now. He maintains a family of reference antennas. These are erected in the same field as the "antenna under test". Detectors are measured on an HP-416A Ratiometer. On the right is Marc's source trailer with the 6m antenna currently transmitting. Above, you can see Kent, KA2KQM, and Bruce, W9FZ, assisting on the range. In the photos below, you can see Dave, KBØPE, and Ron, KOØZ measuring a 6m beam.

Part of the antenna range at the Central States VHF Conference

Stacking yagis

- Phasing Lines
- Power splitters
- Stacking Distance



Polarization	Stacking	H Plane	E Plane
Vertical	Vertical	46	21
Vertical	Horizontal	23	41
Horizontal	Vertical	41	23
Horizontal	Horizontal	21	46

using Phasing Lines

Quarter Wave power splitter

50-Ohm Four-Port Power Divider

50 Ohm 50 Ohm 50 Ohm

50 Ohm 50 Ohm

11" 32 dia. (8.73mm)

Solder Access Hole 5/8" dia. (15.875mm)

5/8" (15.875mm)

"A" "B"

http://home.teleport.com/~oldaker/power_dividers.htm

Half Wave Power Splitter

Stacking yagis – Using Phasing Lines

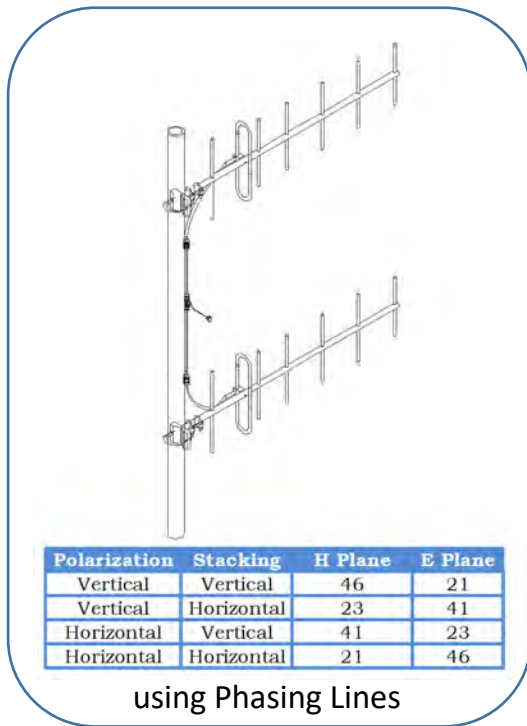

To phase just use a $\frac{1}{4}$ wavelength of 75 ohm feedline

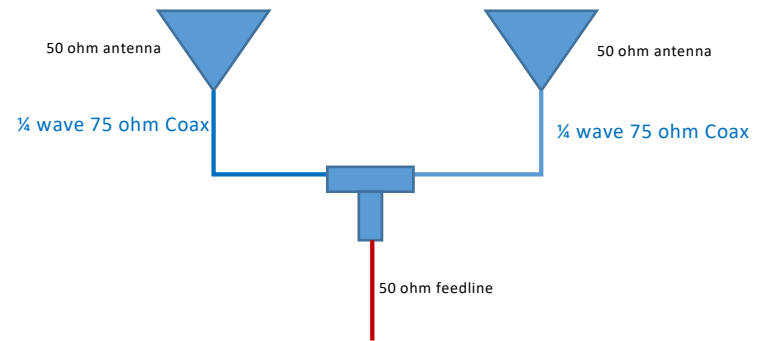

What if my antennas are more than a $\frac{1}{4}$ wavelength apart?

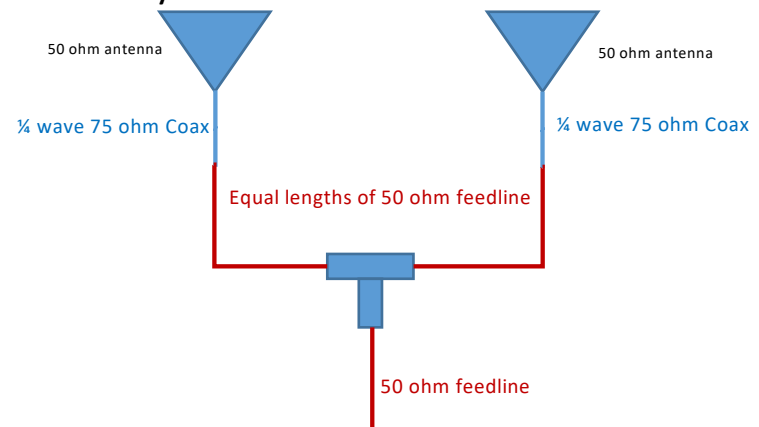

Stacking yagis – Power Splitters

- Use either a $\frac{1}{4}$ wave or $\frac{1}{2}$ wave power splitter
- Equal length 50 ohm phasing lines

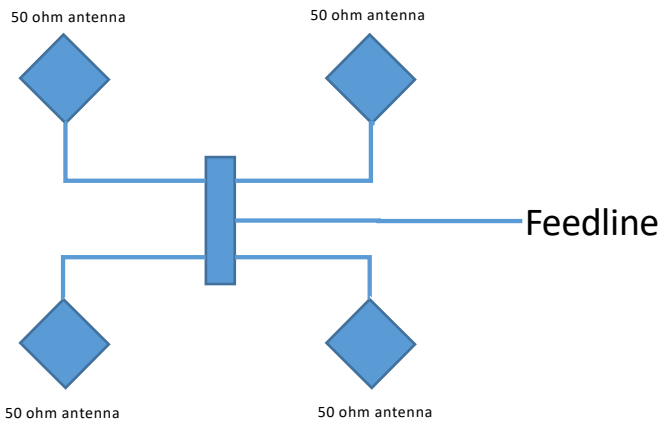

All coaxial lines are 50 ohms

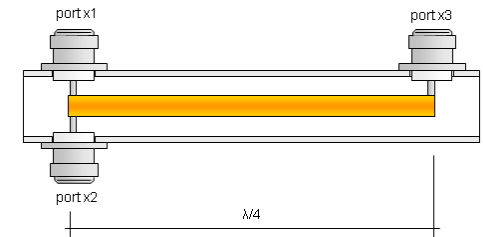

Quarter Wave power splitter

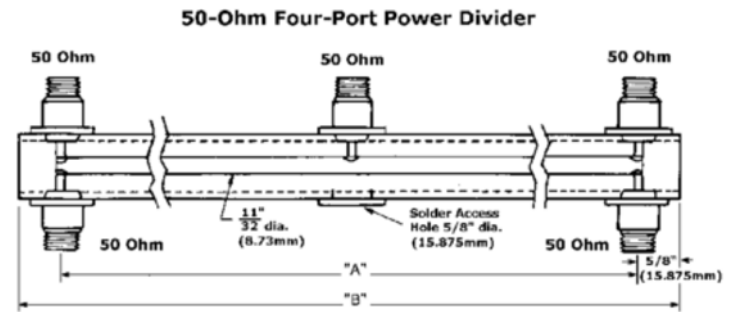

Half Wave Power Splitter

VHF yagis

More material than we can talk about in this session. So let's touch the top of the clouds ...

- Easy to build
- Element mounting and lengths
- Optimization
- Does boom length equal gain / performance
- Is more elements better?
- “best” designs



VHF Yagi driven elements

Still more material than we can talk about in this session. Let's look at the most popular

- How to match?
- What is important?
- Stacks of yagis
- Driven Elements
 - Beta match
 - Delta Match
 - T-match
 - Balun match

T Match

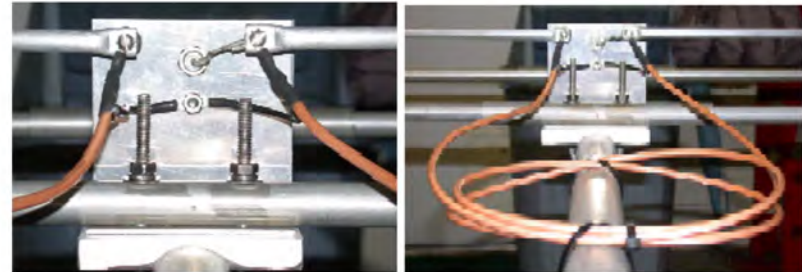

Beta Match



Gamma Match

2 Meter Gamma Match

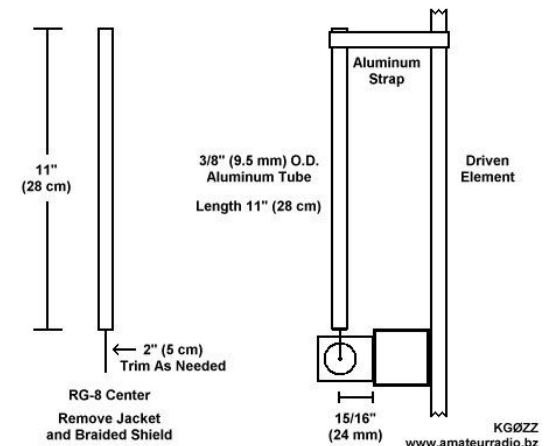

VHF Yagis – T Match

- Great article from Directive Systems
- Used on many of my homebrew antenna projects
- But don't forget the coaxial balun

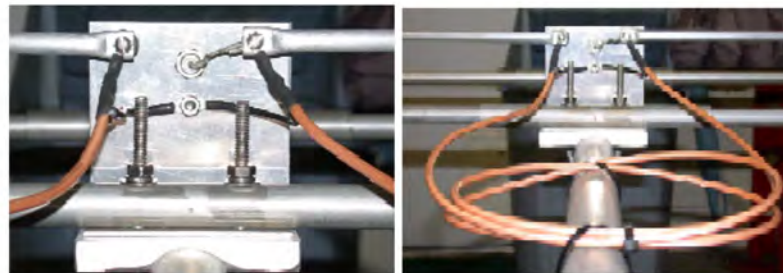
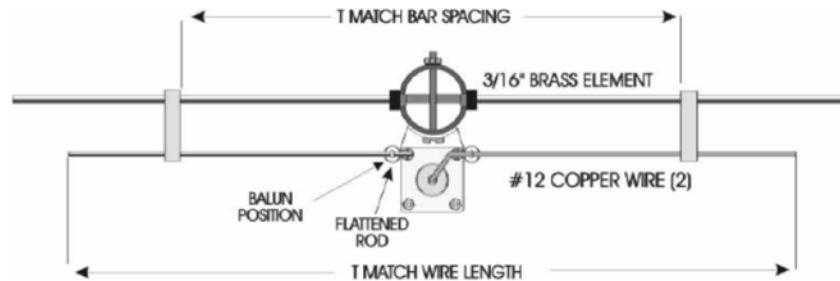



Directive Systems & Engineering
 2702 Rodgers Terrace
 Haymarket, VA 20169-1628
 www.directive-systems.com
 703-754-3876

K1JX DESIGNED 5-ELEMENT 50-MHZ YAGI, DSEJX5-50

INTRODUCTION

The Directive Systems DSEJX5-50 is a 5 element Yagi-Uda antenna design by Clark Green, K1JX. The design provides optimum performance for a .625 λ boom-length antenna, while addressing construction details of importance to the first-time as well as experienced builder. Design issues such as selecting the grade of aluminum used for boom and element material to assure harsh-environment survivability, use of stainless-steel boom hardware and element-assembly hardware, and use of commonly available hand tools to aid in ease of construction, have been considered in producing an antenna kit which is complete, satisfying to build, and gives the builder one of the finest 6-meter antennas available.

ELECTRICAL SPECIFICATIONS

Calculated gain:	10.1 dBi
E-plane 3 dB beam width:	55 degrees
H-plane 3 dB beam width:	73 degrees
SWR 1.5:1 Bandwidth:	1 MHz
Sidelobe attenuation:	-24.7 dB
1st E-plane:	-18.3 dB
SWR 50:1 MHz:	Less Than 1.5:1 typical
Stacking distance for optimum gain-to-noise ratio:	144"
E-plane:	144"
H-plane:	144"
F/B ratio:	25.5 dB
Impedance:	50 ohms nominal
Maximum Power:	1500 Watts

MECHANICAL SPECIFICATIONS

Length:	12 ft
Tuning radius:	3 ft
Boom sections/elements:	6063-T832 aluminum
Element sections:	1.375" x .058" wall with .058" insert
T-match arms:	5/8" x 1/2" x .058" wall
All stainless steel hardware:	3/8" x .058" wall
Surface area:	~ 2 ft ²
Wind survival:	90+ mph
Maximum mast size:	2.0" OD – larger on Special orders
Coax connector:	Weatherproof N-type
Assembled weight:	13 lbs

DSEJX5-50 Rev 11/18

More info: <https://directive-systems.com/50-mhz/dsejx5-50/>

Log periodic antennas

- Different from yagis?
- Broadband
- How much gain?

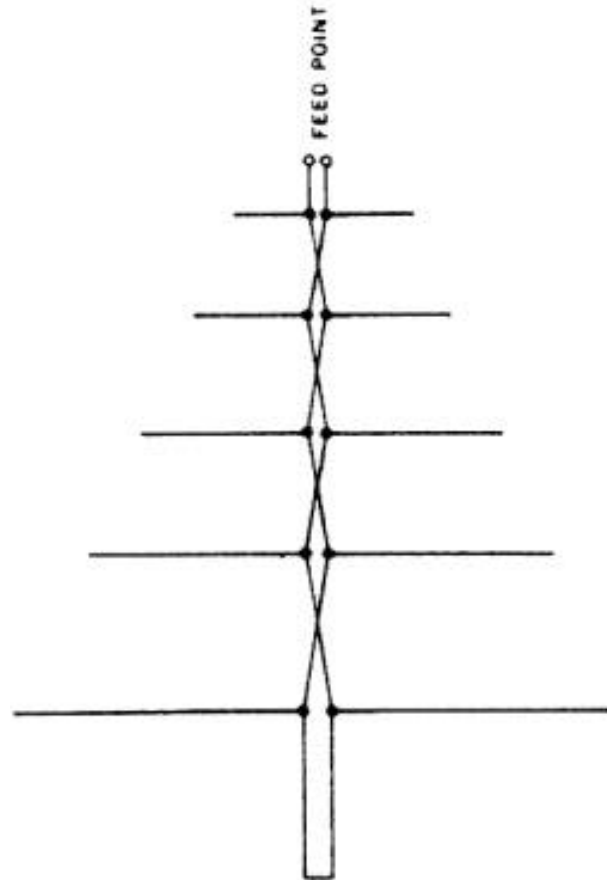

HF Yagis – Are they different?

- A simple yagi you can build
- How high to place it?
- Vertical vs Horizontal
- Stacking – not as common
- Are more elements better?
 - Example: Cushcraft 5-element 6meter converted to 4-element

Loops (vertical and horizontal)

- Vertical loop
- Horizontal loop
- Used on 6 meters effectively
- 2 meter halo
- 40 meter loop that I used as a novice



Rocky Mountain Ham Radio

Teach...learn...operate...support. Be a part of our team.

Now the practical

WA5VJB.COM

- Kent has a lot of great info on his web site
- Presents “VHF 101” each year at Central States VHF Conference

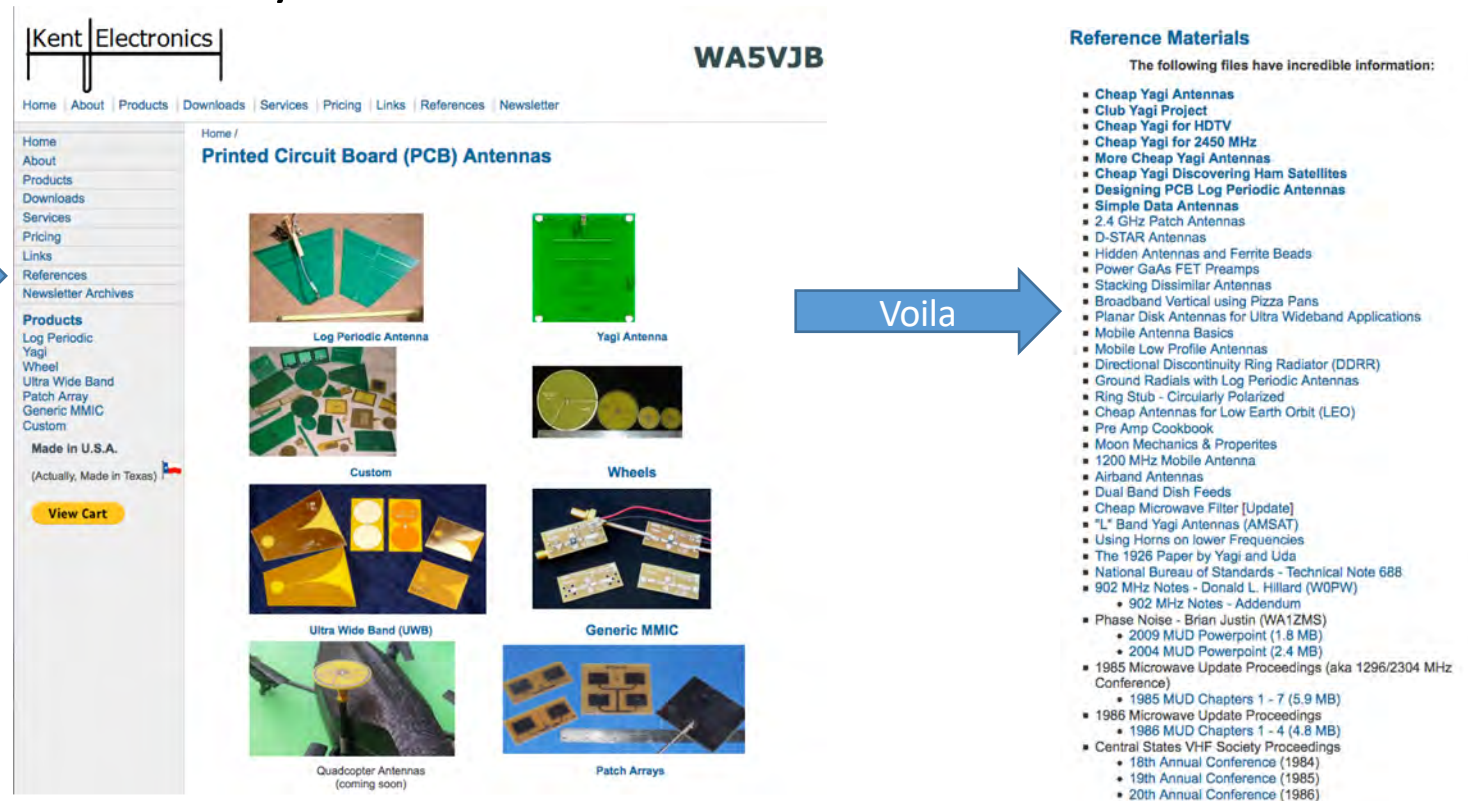

The screenshot shows the website for Kent Electronics, WA5VJB. The main navigation menu includes Home, About, Products, Downloads, Services, Pricing, Links, References, and Newsletter. The left sidebar contains a 'Products' menu with items like Log Periodic, Yagi, Wheel, Ultra Wide Band, Patch Array, Generic MMIC, and Custom. A 'View Cart' button is also present. The main content area is titled 'Printed Circuit Board (PCB) Antennas' and features a grid of images with labels: Log Periodic Antenna, Yagi Antenna, Custom, Wheels, Ultra Wide Band (UWB), Generic MMIC, Quadcopter Antennas (coming soon), and Patch Arrays. A blue arrow points from the 'References' link in the top navigation to a detailed list of 'Reference Materials' on the right. A second blue arrow labeled 'Voila' points from the 'Reference Materials' list to the right.

Reference Materials

The following files have incredible information:

- Cheap Yagi Antennas
- Club Yagi Project
- Cheap Yagi for HDTV
- Cheap Yagi for 2450 MHz
- More Cheap Yagi Antennas
- Cheap Yagi Discovering Ham Satellites
- Designing PCB Log Periodic Antennas
- Simple Data Antennas
- 2.4 GHz Patch Antennas
- D-STAR Antennas
- Hidden Antennas and Ferrite Beads
- Power GaAs FET Preamps
- Stacking Dissimilar Antennas
- Broadband Vertical using Pizza Pans
- Planar Disk Antennas for Ultra Wideband Applications
- Mobile Antenna Basics
- Mobile Low Profile Antennas
- Directional Discontinuity Ring Radiator (DDRR)
- Ground Radials with Log Periodic Antennas
- Ring Stub - Circularly Polarized
- Cheap Antennas for Low Earth Orbit (LEO)
- Pre Amp Cookbook
- Moon Mechanics & Properites
- 1200 MHz Mobile Antenna
- Airband Antennas
- Dual Band Dish Feeds
- Cheap Microwave Filter [Update]
- "L" Band Yagi Antennas (AMSAT)
- Using Horns on lower Frequencies
- The 1926 Paper by Yagi and Uda
- National Bureau of Standards - Technical Note 688
- 902 MHz Notes - Donald L. Hillard (W0PW)
 - 902 MHz Notes - Addendum
- Phase Noise - Brian Justin (WA1ZMS)
 - 2009 MUD Powerpoint (1.8 MB)
 - 2004 MUD Powerpoint (2.4 MB)
- 1985 Microwave Update Proceedings (aka 1296/2304 MHz Conference)
 - 1985 MUD Chapters 1 - 7 (5.9 MB)
- 1986 Microwave Update Proceedings
 - 1986 MUD Chapters 1 - 4 (4.8 MB)
- Central States VHF Society Proceedings
 - 18th Annual Conference (1984)
 - 19th Annual Conference (1985)
 - 20th Annual Conference (1986)

Check out the references tab

Voila

WA5VJB.COM – Cheap Yagi Antenna

- You can build this!
- You can build this antenna on a budget
- As Kent says, “If you are planning to build an EME array, don’t use these antennas.”
- But use them for a good home station yagi or rover station.

Controlled Impedance "Cheap" Antennas

Kent Britain WA5VJB

If you're planning to build an EME array, don't use these antennas. But if you want to put together a VHF Rover with less than \$500 in the antennas, read on.

The simplified feed uses the structure of the antenna itself for impedance matching. So the design started with the feed and the elements were built around it. Typically a high gain antenna is designed in the computer, then you try to come up with a driven element matching arrangement for some weird impedance. In this design, compromises for the feed impedance, asymmetrical feed, simple measurements, wide bandwidth, the ability to grow with the same spacing, and trade offs for a very clean pattern cost about 1/2 dB of gain. But you can build these antennas for about \$5!!!!

The antennas were designed with YagiMax, tweaked in NEC, and the driven elements experimentally determined on the antenna range.

The boom is 3/4" square, or 1/2 X 3/4" wood. The elements have been made from Silicon Bronze welding rod, Aluminum rod, Hobby tubing, and solid ground wire. You really want to solder to the Driven Element. Silicon Bronze Welding rod, Hobby tubing, and #10 or #12 solid copper wire have been used to make the driven element. A drop of "Super Glue", Epoxy, or RTV is used to hold the elements in place.

144 MHz

Driven Element: All versions

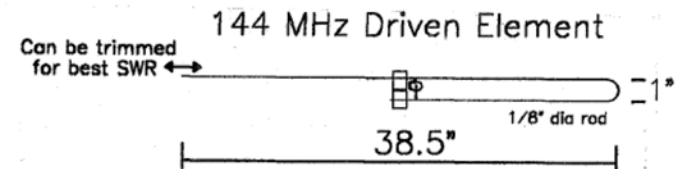

LEO antennas / Satellite antennas

- You can build this!
- It's lightweight
- You can aim it at a satellite or ISS by hand
- Not a lot of gain, but enough

Cheap Antennas for the AMSAT LEO's
Kent Britain -- WA5VJB



Cheap LEO Antenna

HF Yagi Example – KLM 20M-5

- KLM is a classic antenna
- KLM no longer in business. Some founders created M2 Designs
- 9.7 dBd gain on 20 meters
- 13.9 – 14.4 MHz bandwidth
- Big antenna at 42 foot boom

20M-5

I. SPECIFICATIONS AND PERFORMANCE CHARACTERISTICS

Your new KLM antenna is a unique professional design especially engineered for broad-band operation without sacrifice of gain, VSWR, and front-to-back ratio.

These characteristics are achieved through the use of two driven elements, similar to a two-element log periodic design, coupled with a single reflector and three directors.

All elements are insulated from the boom. This feature means that even with slight unbalances due to proximity of the beam to other energy absorbers, no currents flow in the boom to distort radiation patterns, as is the case where elements are forced to be at the same center potential by connection to the boom.

The injection-molded high-strength lexan insulators are also designed with a slight upward tilt to compensate for normal element sag, to absorb vibrational forces and reduce strain on the elements, and to securely hold the elements horizontally as well as vertically.

Specifications:

- F/B Ratio: 35 dB typical
- Gain: 9.7 dBd + 0.2 dB
- Bandwidth: 13.9-14.4 MHz
- Feed Impedance: 200 ohms balanced; 50 ohms with KLM 3-60 4:1 Balun (optional)
- Wind Area: 9.25 sq. ft. (.859 sq meters)
- Turning Radius: 28 feet (8.55 meters)
- Boom Length: 42 feet
- Weight: 65 pounds (29.47 Kg)
- Mast Size: 2"O.D. standard - other sizes available on order
- Element Length: 37.33 feet (11.4 meters) maximum
- Elements: five

Electrically, you will find that this beam design has a low and fairly uniform VSWR across the entire 20-meter amateur band. Outside the band, the VSWR rises rapidly so that in effect the beam acts somewhat like a bandpass filter. There is, accordingly, less noise than with ordinary beams having a less-sharp impedance characteristic.

You will also find that the KLM 20M-5 beam has no side lobes in the forward direction and only two tiny ones to the rear, dropping to a near-perfect (30-35 dB front-to-back) null in the back direction. Mounted in the clear, this beam shows better discrimination against QRM than most parasitic arrays.

P.O. Box 816, Morgan Hill, California 95037 • (408) 779-7363

HF Yagi Example – KLM 20M-5

- Note the driven elements
- Log periodic feed for lower SWR over an increased bandwidth
- Uses a 4:1 balun
- But is the antenna pattern unchanged over same bandwidth?

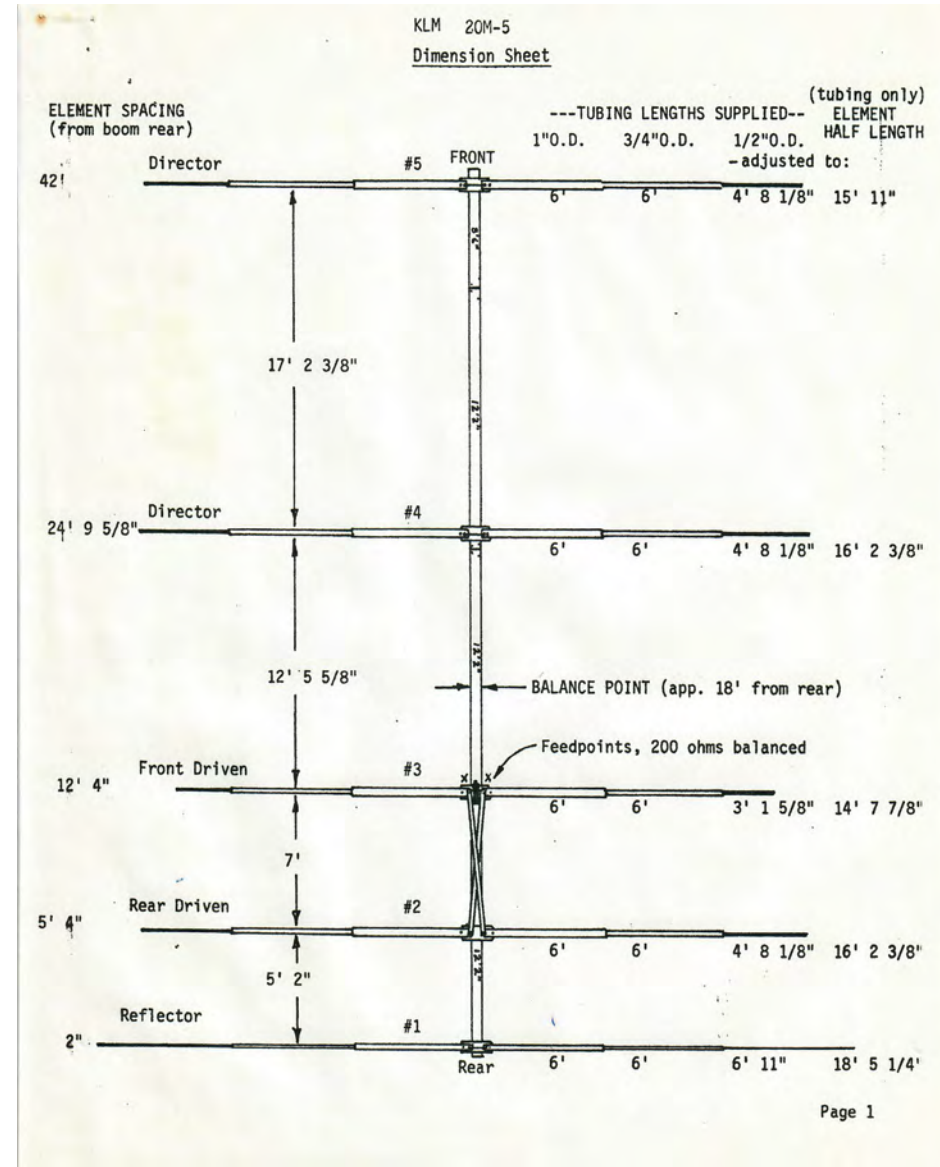

W2PV (sk) 4 Element 20 Meter Yagi

- Initial design by Dr. Jim Lawson, W2PV (sk)
- Elements corrected for
 - 3" dia boom
 - Metal plates directly connected to boom
 - (not thru boom element mounting)
- Feed is basic gamma match
- A** • "Gamma Box" has air variable capacitor inside
- B** • End of gamma arm has shorting bar with set-screws
- C** • Nylon support for mechanical purposes
- Extremely clean radiation pattern
- Antenna was installed in 1990 and still in the air today!

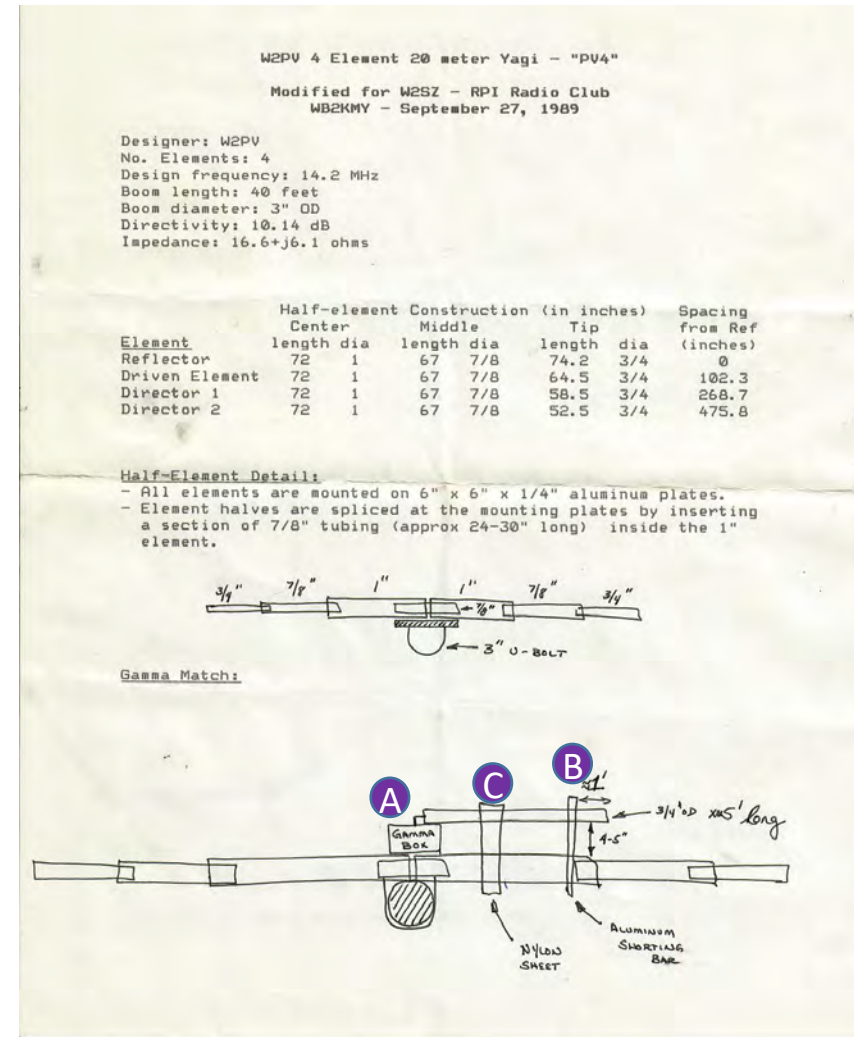

Yagi Example – Cushcraft A50-5S

- Cushcraft now a MFJ Company
- Based upon old NBS (now NIST) design rules
- Has some gain on 50 MHz
- But limited directivity
- Low bandwidth
- Can be converted to 4-element design

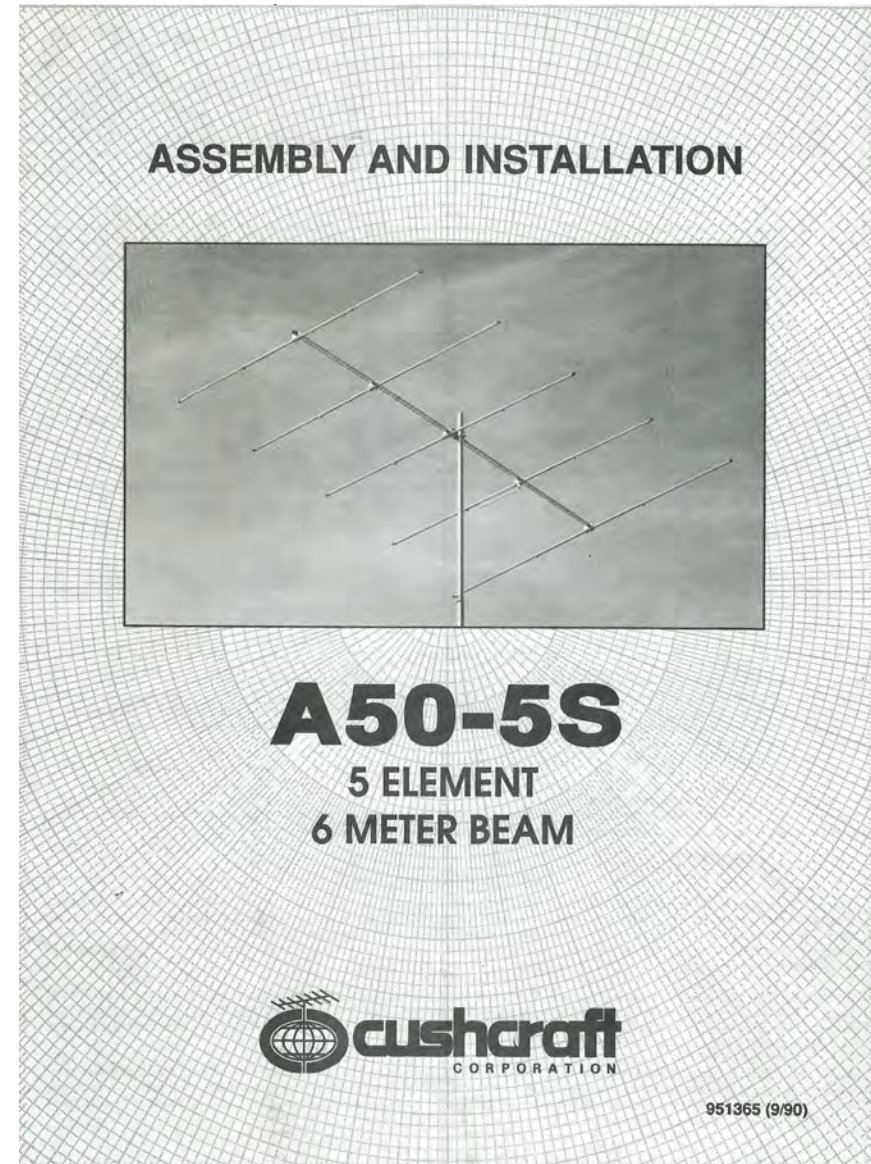

Yagi Example – Cushcraft A50-5S

- Traditional Gamma Match design
- Equal spaced elements (characteristic of NBS design rules)
- Great Field Day or Rover operation antenna

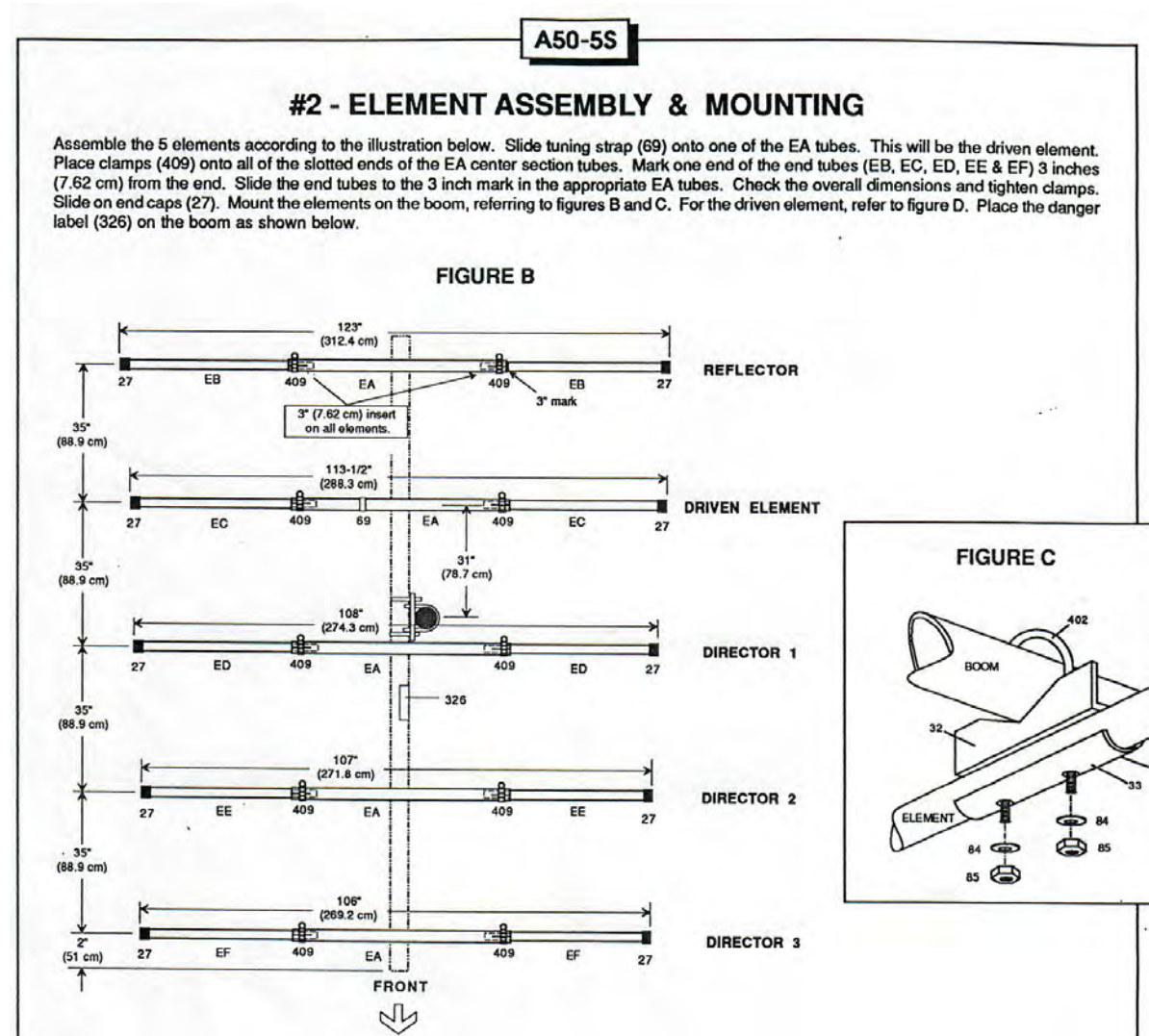

Yagi Example – Cushcraft A144-3

- Simple low-cost antenna
- Based upon old NBS (now NIST) design rules
- Gamma Match driven element

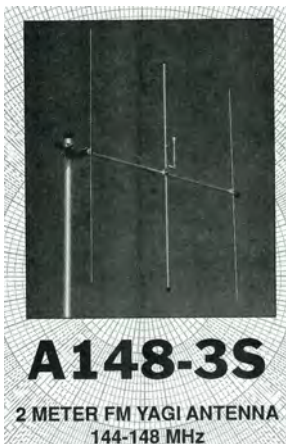

A148-3S

#2 - ELEMENT ASSEMBLY

Assemble the driven element tube (EB) and connector bracket (CB) to the boom at the position shown in figure D using the hardware shown in figure B. Note that the connector points toward the back of the boom. Assemble the Reddi-Match components RR, PT, RT and 251. Set them aside for the moment. Slide the tuning strap (125) onto the driven element (EB) as shown. Slide the Reddi-Match assembly through the tuning strap and secure the rod (RR) to the connector. Use washer (41) and nut (11). Next, slide the poly tube (PT) to the flattened end of the rod. Set the dimensions shown in figure B and tighten the hardware.

Sort the elements by size using table A. The cutting tolerance on these elements is $\pm 1/16''$ (.16 cm). Attach each element to the boom per figure C referring to figure D for proper location.

TABLE A (ELEMENTS)

KEY	ELEMENT NO.	LENGTH	
		INCHES	CM
EA	1	41	104.1
EB	2	38	96.5
EC	3	36	91.4

KEY	P/N	DISPLAY	DESC	SIZE	QTY
11	010011		SS	8-32	6

MGEF 144 MHz Super Yagi by WA2AAU and K2AD (ex WB2KMY)

- We needed an antenna to replace our existing 8x KLM 12-element array



- We decided to deploy 4x longer boom antennas with similar overall gain

- We would no longer need a 50' tall rotating tower



- EME would be possible with an azimuth-elevation rotator

WB2KMY
Douglas A. Sharp
24 Walnut Hill Rd.
Poughkeepsie, N.Y. 12603

**THE MOUNT GREYLOCK EXPEDITIONARY FORCE
TWO-METER SUPERYAGI**

Based on DL6WU Design Rules

GOALS:

1. Replace the deteriorating KLM 12-Element yagis with something "better" to make more points for the contest effort.
2. Make the antenna array easier and therefore faster to put up. This may best be done by putting up 4 very long yagis rather than the current 8 antennas. In that way, the prop-pitch might be avoided and raising the guys from 40 to 50 feet can be eliminated
3. Be able to do moonbounce with the new antenna (at least marginally). With 4 very long yagis, moonbounce is possible, especially if we make very low loss phasing lines and install a tower mounted front end. There will be quite a bit less phasing line loss than with the arrangement of 8 antennas we now use. Elevation rotation will also be much easier than with 8 antennas.

GAIN

If our 14-foot-long KLMs are working well, they might each give:

1. 11.5 dBd for a 14-foot long yagi according to DL6WU
2. 10.8 dBd according to K1FO evaluation relative to others
3. 12.1 dBd for the best 15' antenna evaluated by K1FO

In going from 8 to 4 antennas, we will loose about 2.5 dB of stacking gain. To get that back, we need 2.5 dB more from each individual yagi or about 13.3 to 14.6 dBd. According to DL6WU, we need the following lengths the gain mentioned:

GAIN	LENGTH (WAVELENGTHS)	LENGTH (FEET)
13.3 dB	3.5	23.9
14.6 dB	4.8	32.8

*R27 WA2AAU
2/15/85*

MGEF 144 MHz Super Yagi by WA2AAU and K2AD (ex WB2KMY)

- Homebrew design
- Based upon DL6WU design rules
- Varied Boom size
 - 2" OD center sections
 - 1" OD end sections
- Element lengths were corrected for mounting method and boom diameter
- Extremely clean radiation pattern

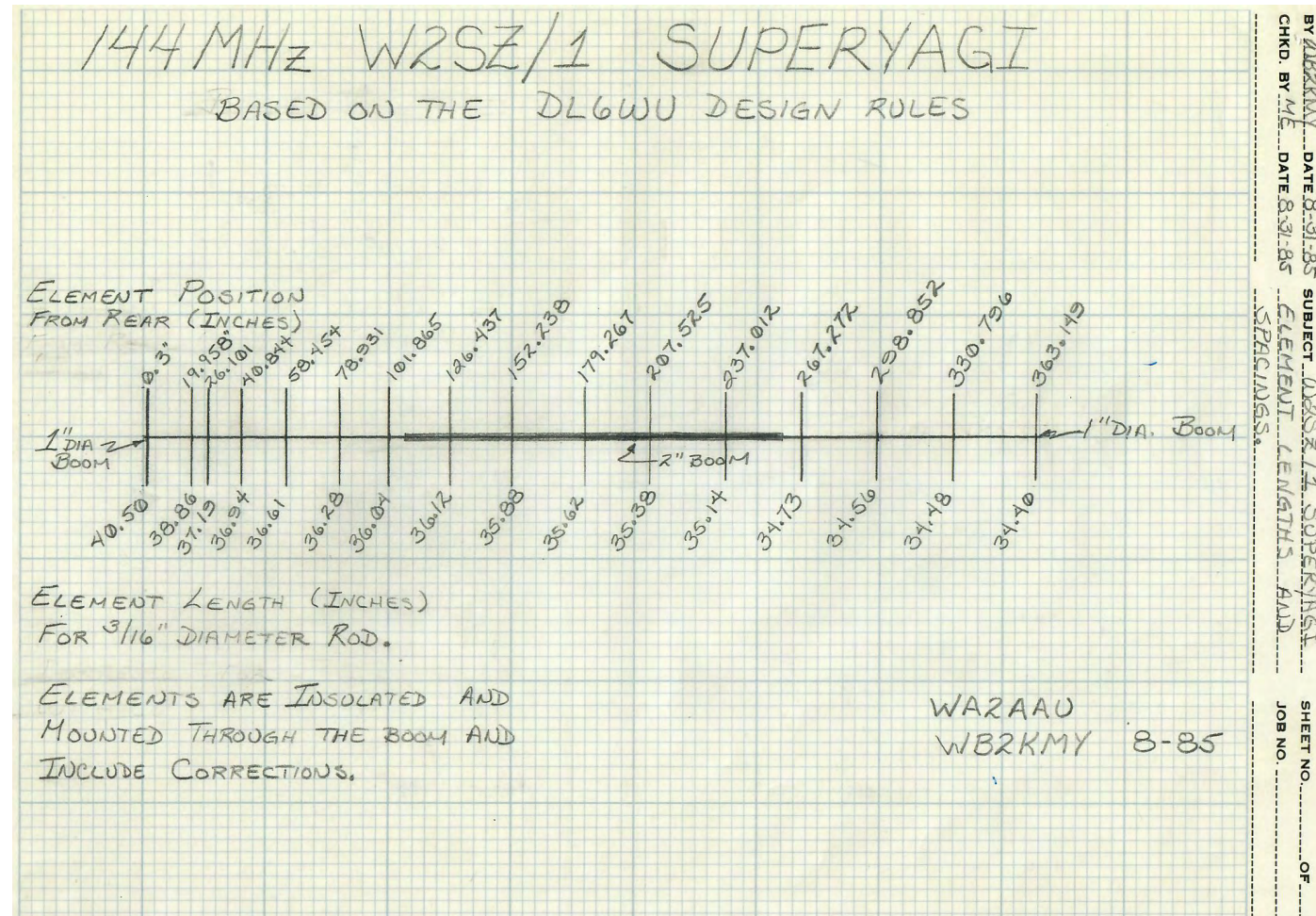

MGEF 144 MHz Super Yagi by WA2AAU and K2AD (ex WB2KMY)

- We needed a driven element (DE)
- Doug started experimenting with
 - T-Match
 - Gamma Match
- I just could not find a matching network that worked.
- Final DE was a folded dipole with half wave matching balun
- It worked, but was not rugged
- Minor mechanical re-design to survive setup and take-down at many VHF contests

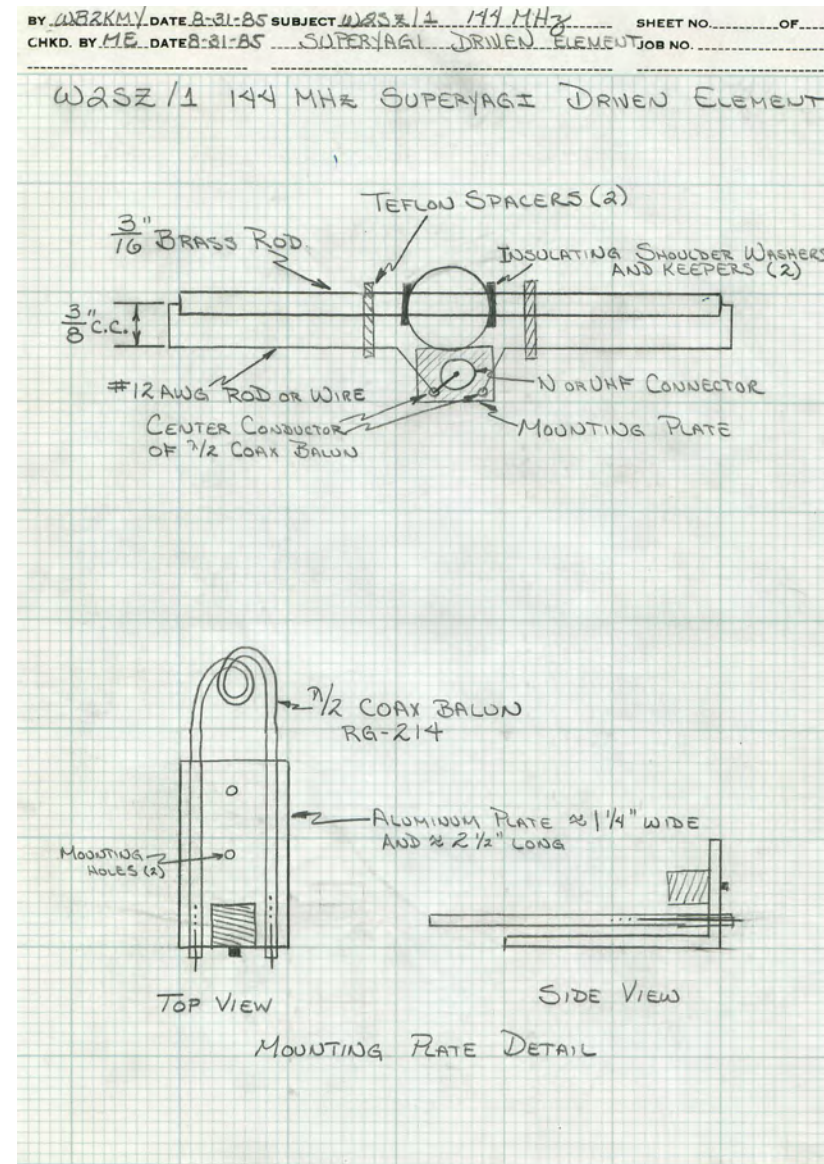

MGEF 144 MHz Super Yagi by WA2AAU and K2AD (ex WB2KMY)

- Here was the result of the new Driven Element
- Incredible match and bandwidth
- And when this antenna was placed on the antenna range ... the pattern was incredible
- Maybe too clean and focused

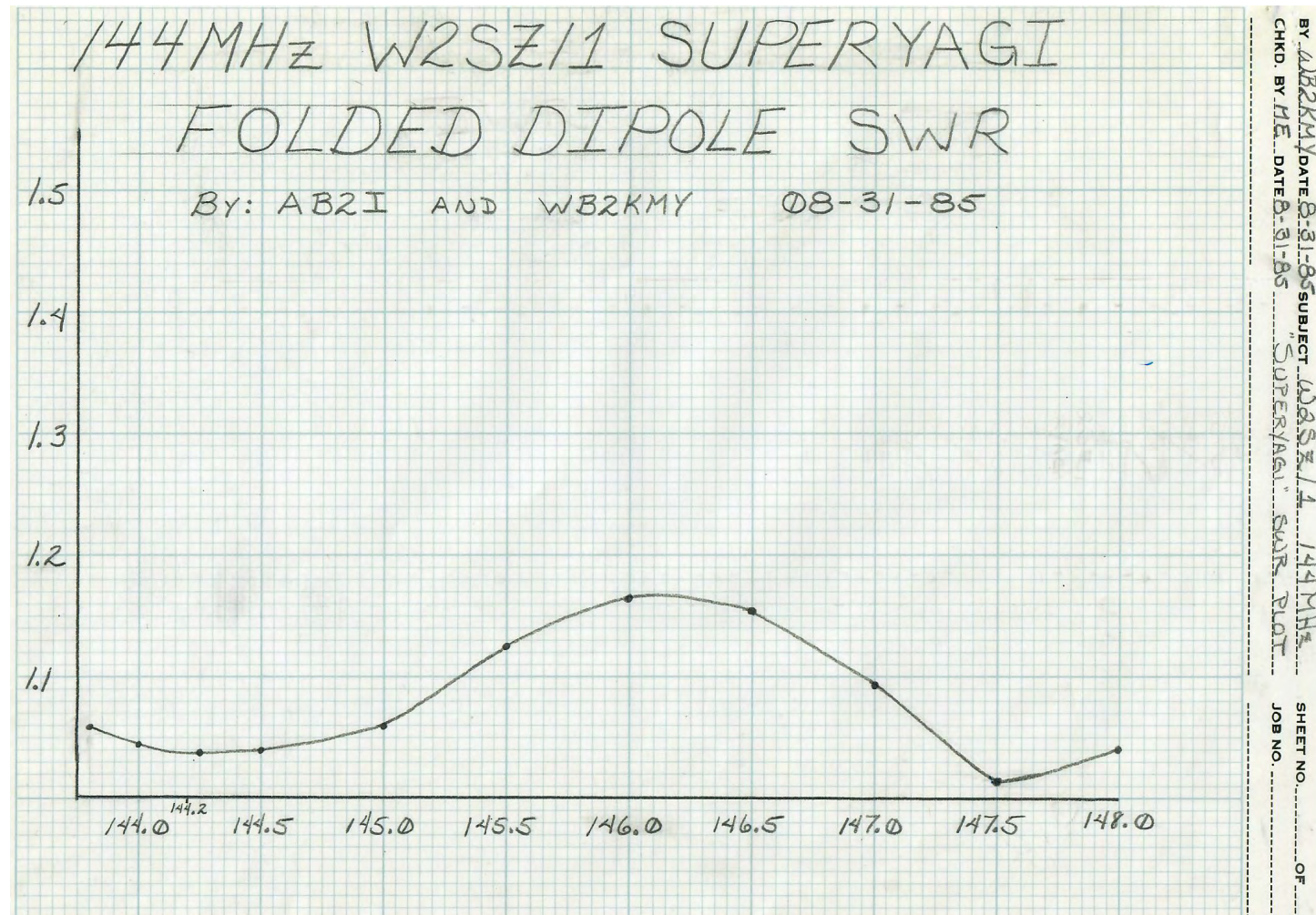

Larsen Yagi – 440 MHz

- No longer manufactured
- Welded elements to boom
- Basic gamma match
- Acceptable performance despite elements not welded on boom in centers **A**
- Reasonable price point

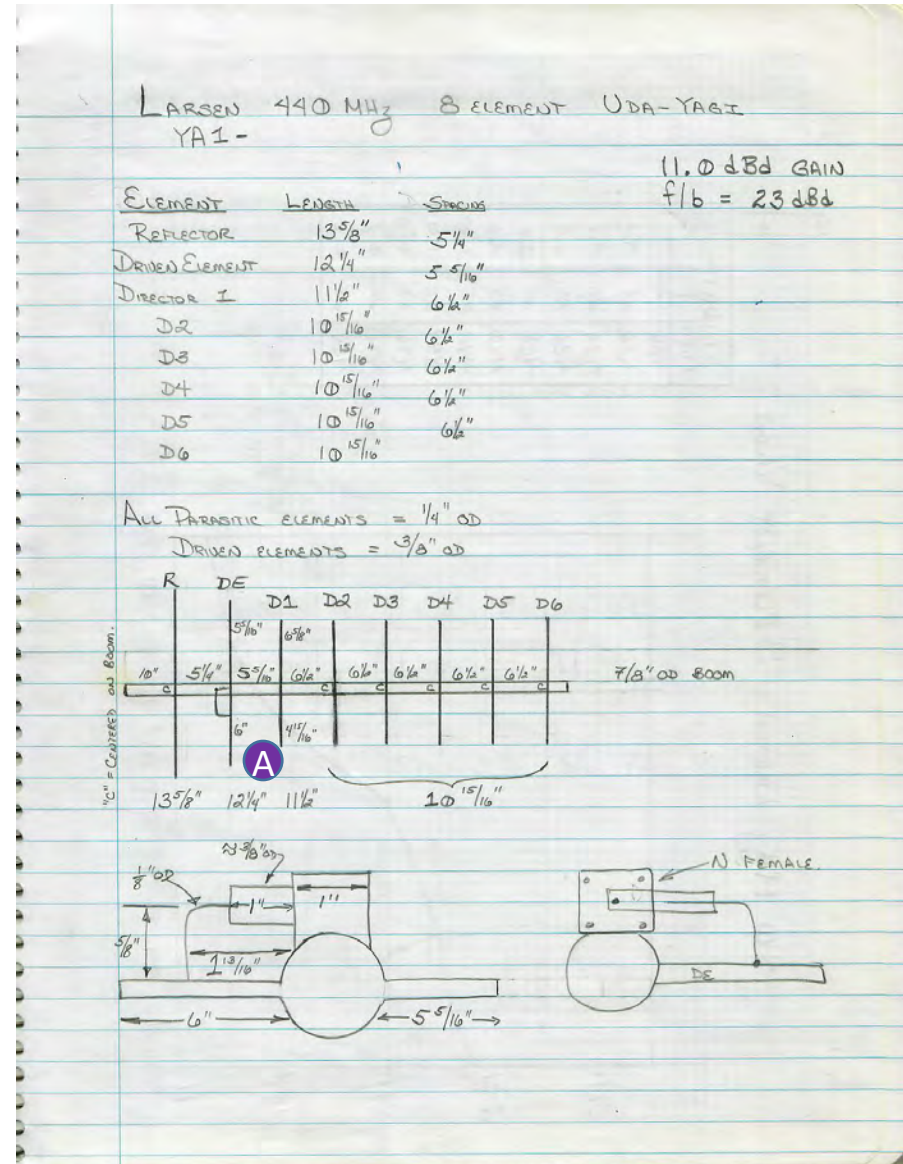
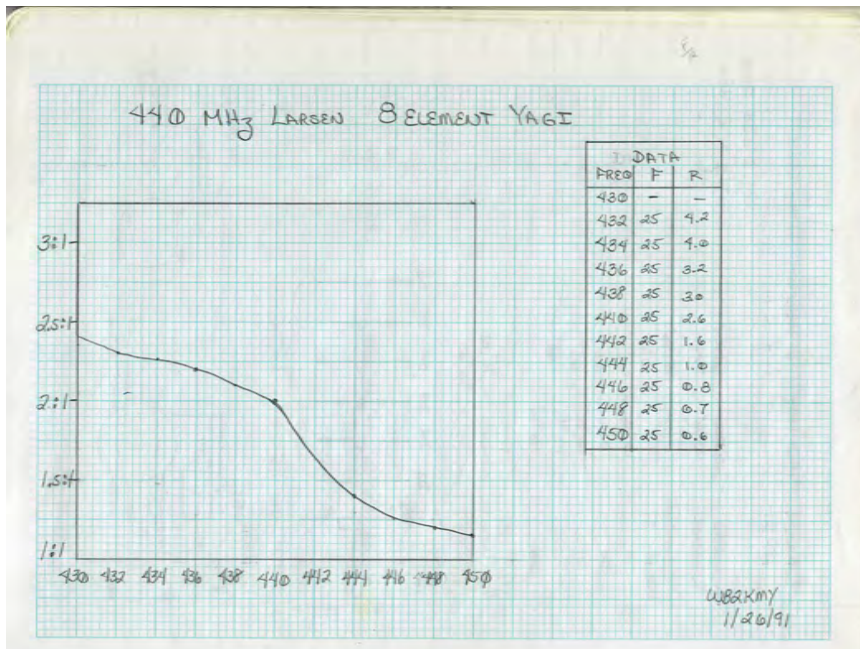

Larsen Yagi – 920 MHz

- No longer manufactured
- Welded elements to boom
- Basic “let’s split the coax and try to match this thing” feed
- Had an acceptable match or SWR
- Found directivity or pattern was “poor”
- Reasonable price point but did not work well

Bottom Line – You get what you pay for. Test your antennas!

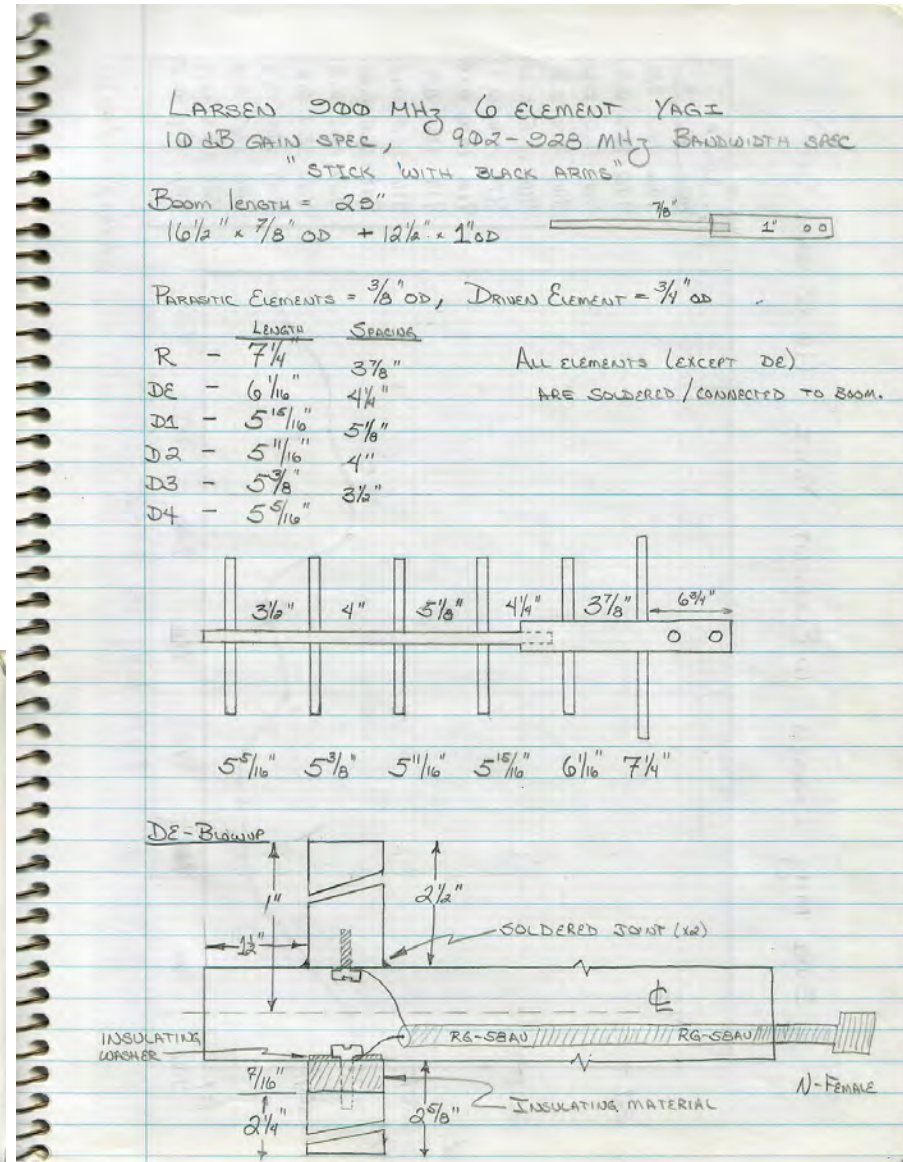
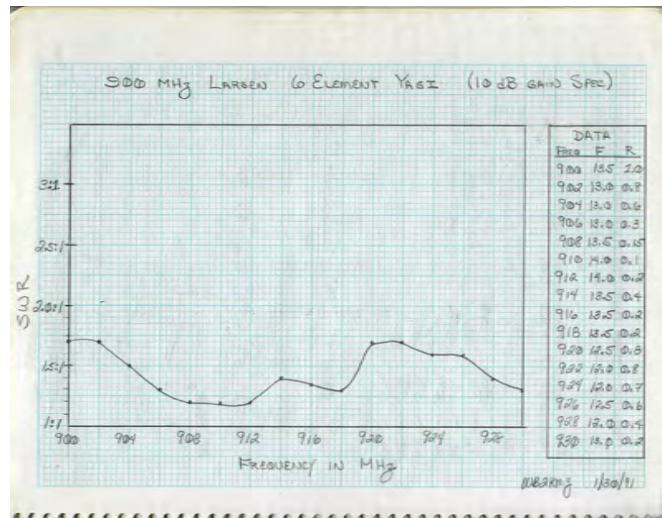

Phasing Yagis at RMHAM VHF Contest NOSZ

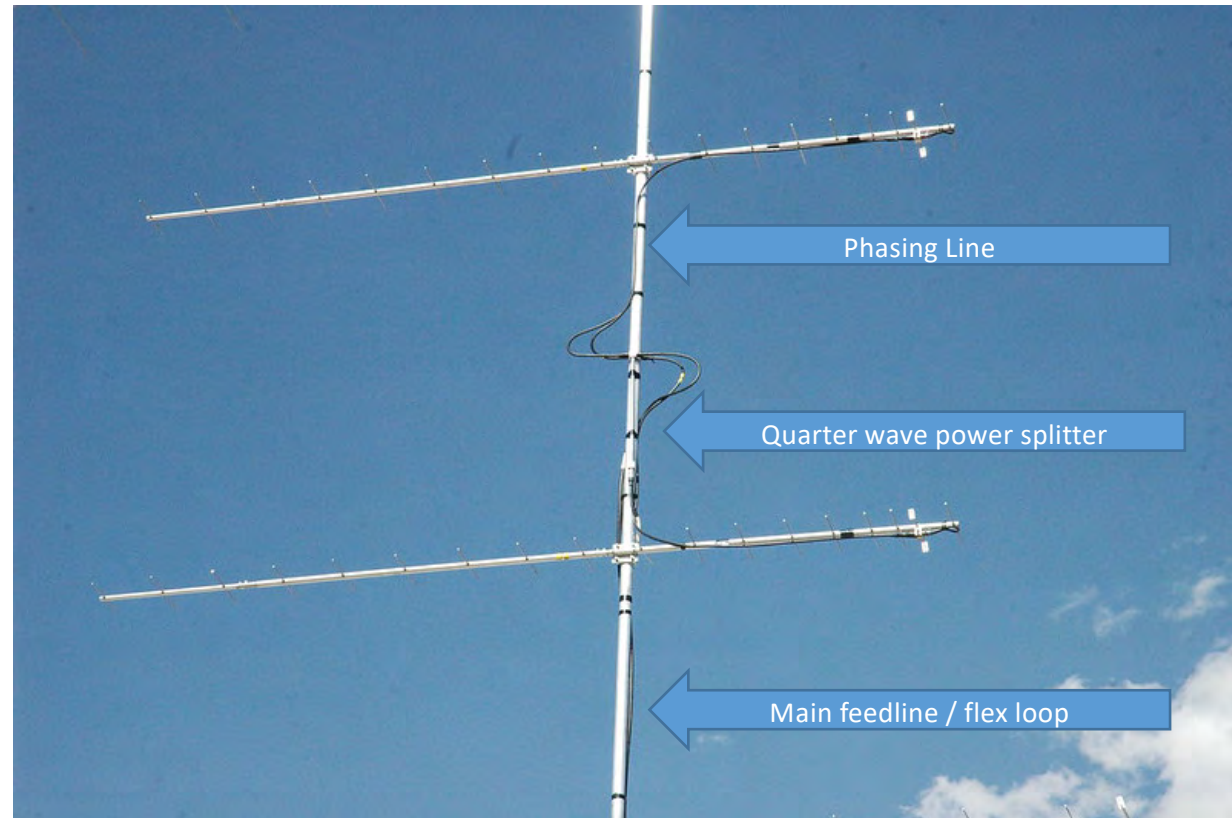

50 MHz Antenna Stacks



2x 6-ele yagis on 50 MHz at W2SZ/1

- Great antenna
- Easy to erect



2x 5-ele yagis at RMHAM
N0SZ (one of two stacks)



4x 6-ele yagis on 50 MHz at W2SZ/1

- If two is good ... four is better

If one antenna is good, two are great, four or eight is “no better”



8 yagis on 222 MHz

- Great antenna
- Challenging to erect
- I'm getting too old for this



222 MHz Deployment Example

4 yagis on 222 MHz

- Optimized design
- Same gain as 8-stack
- Easier to erect



8 yagis on 144 MHz

- Great antenna
- Major effort to erect for temp operation

144 MHz Deployment Example

What's better than 8 yagis?

That's easy –
16 yagis

An old photo of Dick K2RIW and his
monster 432 MHz array

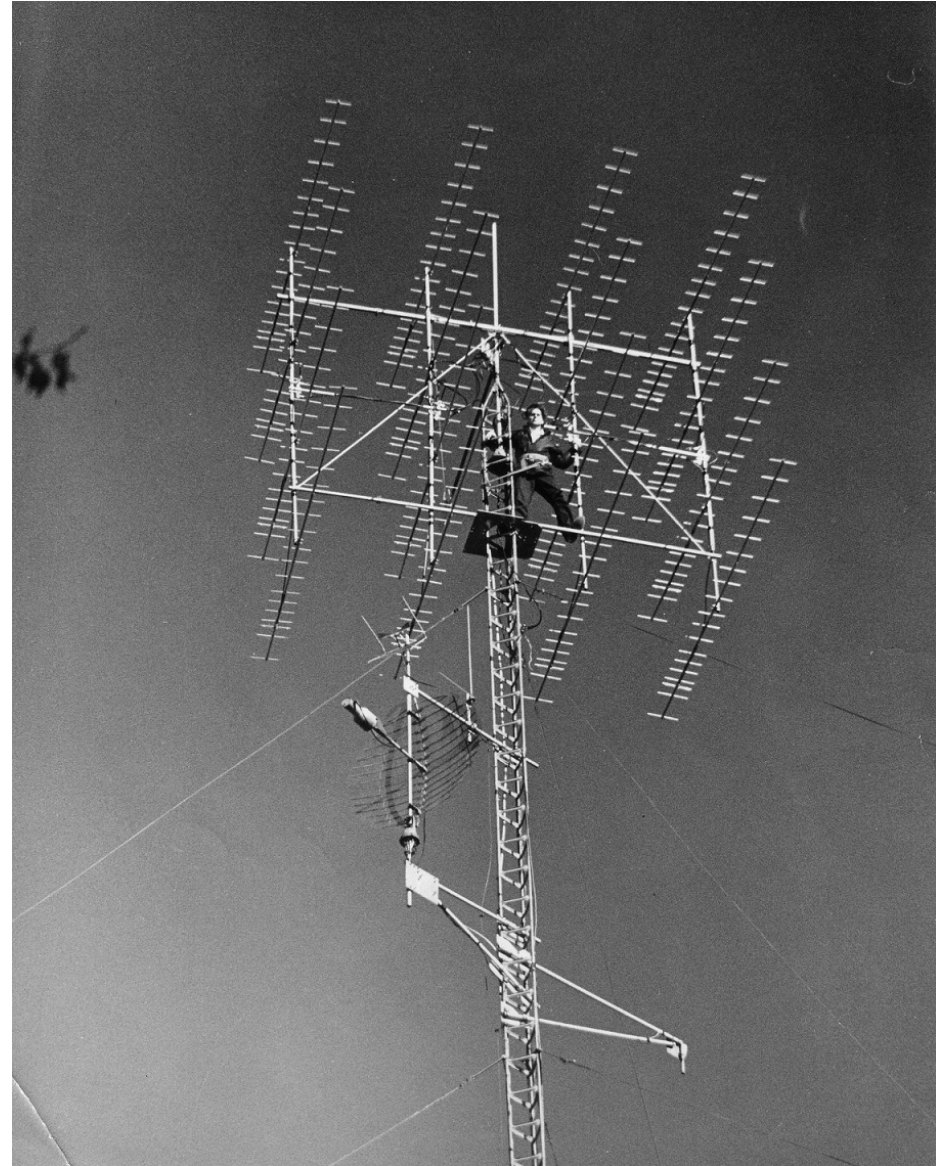

One of the largest EME antennas I have ever seen

Dave - W5UN

Sky Moon Ranch, TX

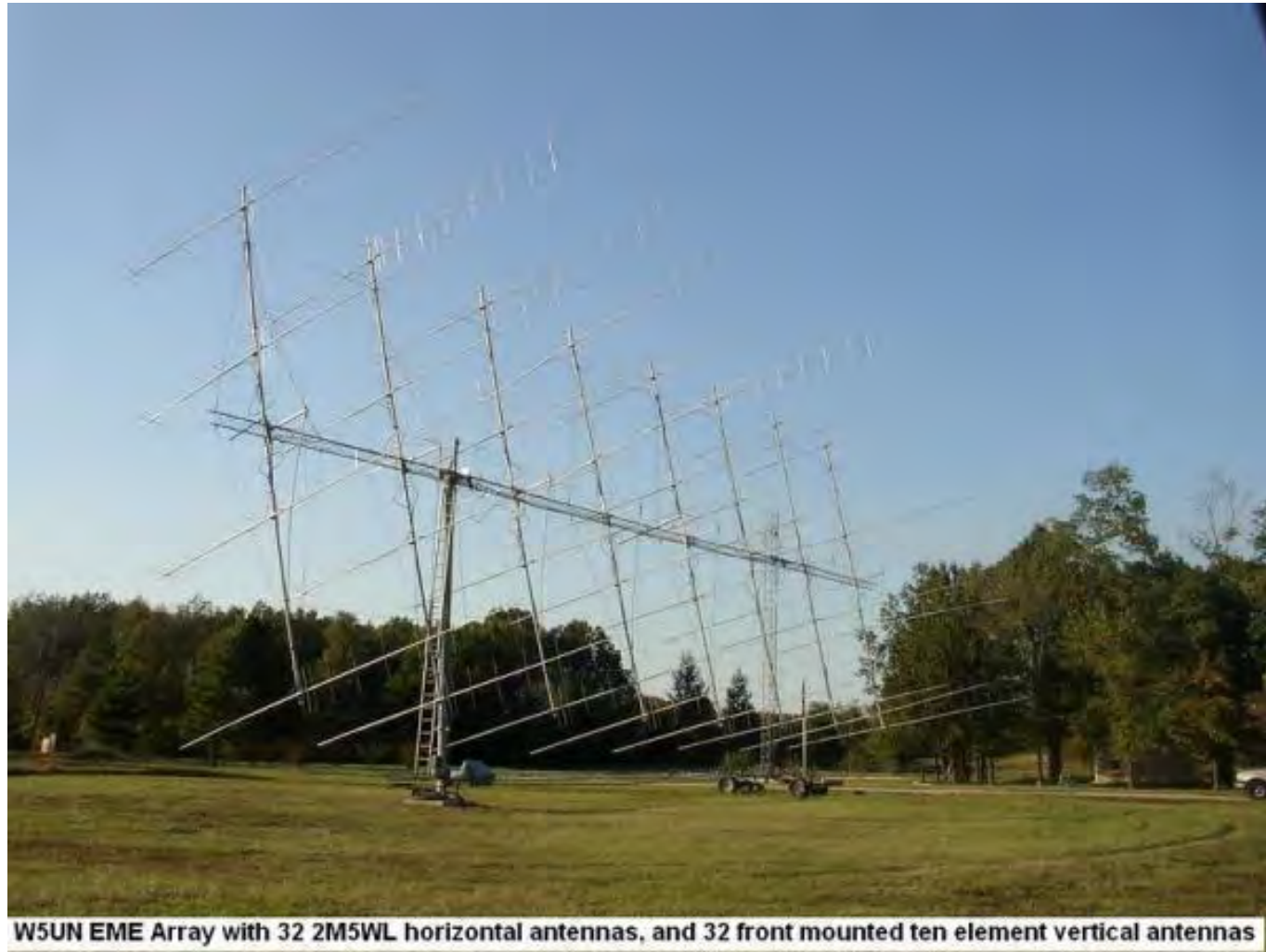

W5UN EME Array with 32 2M5WL horizontal antennas, and 32 front mounted ten element vertical antennas



Rocky Mountain Ham Radio

Teach...learn...operate...support. Be a part of our team.

Are we done yet?

Questions?

The Final Exam

Instructions: Read each question thoroughly. Answer all questions.

Time Limit --- Four Hours. Begin Immediately.

HISTORY: Describe the history of the Papacy from its origins to the present day, concentrate specifically but not exclusively, on the social, political, economic, religious, and philosophical impact on Europe, Asia, America, and Africa. Be brief, concise, and specific.

LITERATURE: Compose an epic poem based upon the events of your own life in which you see and footnote allusions from T.S. Eliot, Keats, Chaucer, Dante, Norse mythology, and the Marx brothers. Critique your poem with a full discussion of its merits.

MUSIC: Write a piano concerto. Orchestrate it and perform it with flute and drum. You will find a piano under your seat.

LOGIC: Using accepted methodology prove all four of the following: That the universe is infinite, that truth is beauty, that there is not a little person who turns off the light in the refrigerator when you close the door, that you are the person taking this exam. Now disprove all of the above. Be specific; show all work.

PHILOSOPHY: Sketch the development of human thought; estimate its significance. Compare with the development of any other kind of thought.

MEDICINE: You have been provided a razor blade, a piece of gauze, and a bottle of scotch. Remove your own appendix. Do not suture until your work has been inspected. You have fifteen minutes.

BIOLOGY: Create life. Estimate the difference in subsequent human culture if this form of life had developed five hundred years earlier, with special attention to the probable effects on the English Parliamentary system. Prove your thesis.

PSYCHOLOGY: Employing principles from the major schools of psychoanalytic thought, successfully subject yourself to analysis. Make appropriate personality changes, bill yourself and fill out all medical insurance forms. Now do the same to the person seated to your immediate left.

SOCIOLOGY: Estimate the sociological problems that might accompany the end of the world. Show how boy meets girl theory developed. Construct and experiment to test your theory.

ECONOMICS: Develop a realistic plan for refinancing the national debt. Trace the possible effects of your plan in the following areas: Cubism, the Donatist controversy, the wave theory of light. Outline a method from all points of view. Point out deficiencies in your argument as demonstrated in your answer to the last question.

COMPUTER SCIENCE: Define a computer. Define Science. How do they relate? Why? Create a generalized algorithm to optimize all computer decisions. Assuming an 1130 CPU supporting 50 terminals, each terminal to activate your algorithm, design the communications to interface and all necessary control programs.

PUBLIC SPEAKING: 2,500 riot crazed students are storming the classroom. Calm them. You may use any ancient language except Latin or Greek.

PHYSICS: Explain the nature of matter. Include in your answer an evaluation of the impact of the development of mathematics on science.

AGRICULTURAL SCIENCE: Outline the steps involved in breeding your own super high yield strain of wheat. Describe its chemical and physical properties and estimate its impact on the world food supplies. Construct a model for dealing with world wide surpluses. Write your Nobel Prize acceptance speech.

COMPREHENSION: Three minute time test. Read everything before doing anything. Put your name in the upper right hand corner of this page. Circle the word name in sentence three. Sign your name under the title of this paper, after the title write "yes, yes, yes." Put an "X" in the lower left hand corner of this paper. Draw a triangle under the X you just drew. On the back of this paper multiply 703x668. Loudly call out your name when you get to this point. If you think you have followed the directions carefully to this point call out, "I have!" Punch three small holes in the top of this paper. If you are the first person to get this far call out, "I am the first person to this point, I am leading in following directions." On the reverse side of this paper add 8950 and 9850. Put a circle around your answer, and a square around your circle. Now that you have finished reading carefully, do only sentence number two.

POLITICAL SCIENCE: There is a red telephone on the desk behind you. Start World War III. Report at length on its socio-political effects, if any.

MATHEMATICS: Give today's date -- in metric.

CHEMISTRY: Transform lead into gold. You will find a tripod and three logs under your seat. Show all work including Feynman diagrams and quantum functions for all steps. You have fifteen minutes.

EXTRA CREDIT:
Define the universe. Give two examples.