

Rockwell Automation Library of Process Objects: Basic Analog Input (P_AIn)

Version 3.5

IMPORTANT

This manual applies to the Rockwell Automation Library of Process Objects version 3.5 or earlier.
For Rockwell Automation Library of Process Objects version 5.0, see

- [PROCES-RM200](#)

For Rockwell Automation Library of Process Objects version 4.0 or later, use the following manuals:

- [PROCES-RM013](#) contains logic instructions
- [PROCES-RM014](#) contains display elements



Important User Information

Read this document and the documents listed in the additional resources section about installation, configuration, and operation of this equipment before you install, configure, operate, or maintain this product. Users are required to familiarize themselves with installation and wiring instructions in addition to requirements of all applicable codes, laws, and standards.

Activities including installation, adjustments, putting into service, use, assembly, disassembly, and maintenance are required to be carried out by suitably trained personnel in accordance with applicable code of practice.

If this equipment is used in a manner not specified by the manufacturer, the protection provided by the equipment may be impaired.

In no event will Rockwell Automation, Inc. be responsible or liable for indirect or consequential damages resulting from the use or application of this equipment.

The examples and diagrams in this manual are included solely for illustrative purposes. Because of the many variables and requirements associated with any particular installation, Rockwell Automation, Inc. cannot assume responsibility or liability for actual use based on the examples and diagrams.

No patent liability is assumed by Rockwell Automation, Inc. with respect to use of information, circuits, equipment, or software described in this manual.

Reproduction of the contents of this manual, in whole or in part, without written permission of Rockwell Automation, Inc., is prohibited.

Throughout this manual, when necessary, we use notes to make you aware of safety considerations.



WARNING: Identifies information about practices or circumstances that can cause an explosion in a hazardous environment, which may lead to personal injury or death, property damage, or economic loss.



ATTENTION: Identifies information about practices or circumstances that can lead to personal injury or death, property damage, or economic loss. Attentions help you identify a hazard, avoid a hazard, and recognize the consequence.

IMPORTANT

Identifies information that is critical for successful application and understanding of the product.

Labels may also be on or inside the equipment to provide specific precautions.



SHOCK HAZARD: Labels may be on or inside the equipment, for example, a drive or motor, to alert people that dangerous voltage may be present.



BURN HAZARD: Labels may be on or inside the equipment, for example, a drive or motor, to alert people that surfaces may reach dangerous temperatures.



ARC FLASH HAZARD: Labels may be on or inside the equipment, for example, a motor control center, to alert people to potential Arc Flash. Arc Flash will cause severe injury or death. Wear proper Personal Protective Equipment (PPE). Follow ALL Regulatory requirements for safe work practices and for Personal Protective Equipment (PPE).

Preface	Software Compatibility and Content Revisions.....	5
	Additional Resources.....	6
Basic Analog Input (P_Aln)	Guidelines.....	8
	Functional Description.....	9
	Required Files.....	10
	Controller File.....	10
	Visualization Files.....	10
	Controller Code.....	12
	Input Structure for Basic Analog Input.....	12
	Output Structure for Basic Analog Input.....	16
	Local Configuration Tags for Basic Analog Input.....	20
	Operations.....	20
	Modes.....	20
	Alarms.....	21
	Simulation.....	21
	Execution.....	22
	Programming Example.....	23
	Display Elements.....	24
	Status/Quality Indicators.....	26
	Threshold Indicators.....	26
	Mode Indicators.....	27
	Alarm Indicators.....	28
	Maintenance Bypass Indicator.....	28
	Using Display Element.....	29
	Quick Display.....	30
	Faceplate.....	31
	Operator Tab.....	32
	Maintenance Tab.....	35
	Engineering Tab.....	37
	Trends Tab.....	41
	Alarms Tab.....	42
	Basic Analog Input Faceplate Help.....	44

Notes:

This manual contains new and updated information. Changes throughout this revision are marked by change bars, as shown to the right of this paragraph.

Software Compatibility and Content Revisions

Table 1 - Summary of Changes

Topic	Page
Changed version from 3_1 to 3_5	10
Split visualization files table by type and reordered to align with installation requirements	10
Input parameters: changed Inp_SrcQ to Inp_PVSrcQ	12
Updated Alarm descriptions	20
Updated Status/Quality Indicator descriptions.	26

For the latest compatible software information and to download the Rockwell Automation® Library of Process Objects, see the Product Compatibility and Download Center at <http://www.rockwellautomation.com/rockwellautomation/support/pcdc.page>.

For general library considerations, see Rockwell Automation Library of Process Objects, publication [PROCES-RM002](#).

Additional Resources

These documents contain additional information concerning related products from Rockwell Automation.

Resource	Description
PlantPAx® Distributed Control System Selection Guide, publication PROCES-SG001	Provides information to assist with equipment procurement for your PlantPAx system.
PlantPAx Distributed Control System Reference Manual, publication PROCES-RM001	Provides characterized recommendations for implementing your PlantPAx system.
Rockwell Automation Library of Process Objects, publication PROCES-RM002	Provides general considerations for the PlantPAx system library of process objects.
FactoryTalk® View Machine Edition User Manual, publication VIEWME-UM004	Provides details on how to use this software package for creating an automation application.
FactoryTalk View Site Edition User Manual, publication VIEWSE-UM006	Provides details on how to use this software package for developing and running human-machine interface (HMI) applications.
Logix5000™ Controllers Add-On Instructions Programming Manual, publication 1756-PM010	Provides information for designing, configuring, and programming Add-On Instructions.
Rockwell Automation Library of Process Objects: Common Alarm Block (P_Alarm) Reference Manual, publication SYSLIB-RM002	Details how to monitor an input condition to raise an alarm.
Rockwell Automation Library of Process Objects: Standard Modes (P_Mode) Reference Manual, publication SYSLIB-RM005	Explains how to select the Mode (owner) of an instruction or control strategy. The Mode instruction is usually embedded within other instructions to extend their functionality.
Rockwell Automation Library of Process Objects: Advanced Analog Input (P_AlnAdv) Reference Manual, publication SYSLIB-RM018	Provides details of the P_AlnAdv object that can be used instead of P_Aln if additional features are desired.
Rockwell Automation Library of Process Objects: Condition Gate Delay (P_Gate) Reference Manual, publication SYSLIB-RM041	Provides details of the P_Gate instruction for processing status and alarm conditions, including gate delay, on-delay, and off-delay timing.
Rockwell Automation Library of Process Objects: Analog Input Channel (P_AIChan) Reference Manual, publication SYSLIB-RM042	Details how to monitor one input analog instruction and provide one configurable alarm.

You can view or download publications at <http://www.rockwellautomation.com/literature/>. To order paper copies of technical documentation, contact your local Allen-Bradley distributor or Rockwell Automation sales representative.

Basic Analog Input (P_AIn)

The P_AIn (Basic Analog Input) Add-On Instruction monitors one analog value, typically from a channel of an analog input module, and provides alarms when the analog value exceeds user-specified thresholds (high and low). The Analog Input instruction also provides capabilities for linear scaling of an analog input value from raw (input) units to engineering (output) units, and entry of a substitute Process Variable, providing handling of an out-of-range or faulted input.

To keep the instruction memory and execution footprint small, certain capabilities, used less frequently, are reserved for the Advanced Analog Input Add-On Instruction. Refer to the Rockwell Automation Library of Process Objects: Advanced Analog Input (P_AInAdv) Reference Manual, publication [SYSLIB-RM018](#), for more information.

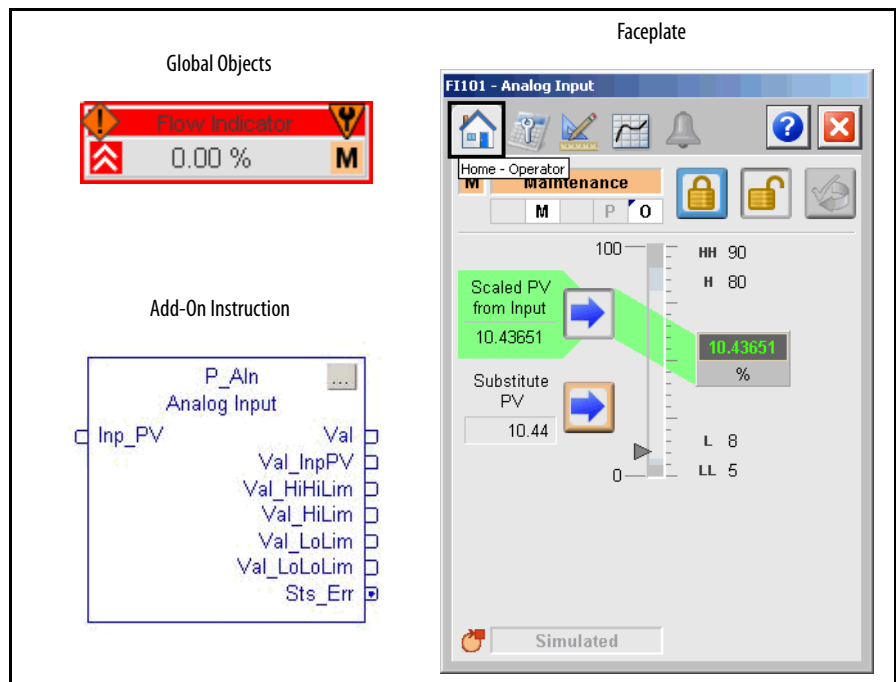

Guidelines

Use this instruction in these situations:

- You want to display a temperature, flow, pressure, level, or other signal from a single field instrument on your HMI.
- You need any of these scaling, alarming, or HMI features for a single Analog Input, or any analog (quantity) value:
 - Linear scaling from raw to engineering units
 - High, Low, High-High, Low-Low, and Out of Range alarms (with deadband, on-delay and off-delay per alarm)
 - Indicator graphic object with label and engineering units
 - Faceplate with mode selection, status threshold entry, and Maintenance capability for substitute PV

Do **not** use this instruction in these situations:

- The analog input signal is handled by another instruction. For example, the Speed Feedback for a variable speed drive is completely handled by the P_VSD instruction. It is not necessary to use the P_AIn Add-On Instruction first. Wire or map the input directly to P_VSD.
- You need to display only a number on a screen and do not need any of the scaling or alarming features. Use a numeric display field instead.
- You need advanced capabilities, such as square root extraction (for example, orifice flow meters), rate-of-change alarming or limiting, or alarming for deviation from a reference value. Use the P_AInAdv instruction instead.
- You have dual sensors for one process variable, such as dual pH meters, and need to select one or the other sensor (or their average). Use the P_AInDual instruction instead.
- You have more than two sensors for one process variable and need to use the average or median sensor value. Use the P_AInMulti instruction instead.

Functional Description

The primary functions of scaling to engineering units and providing input alarms are depicted in the following figure.

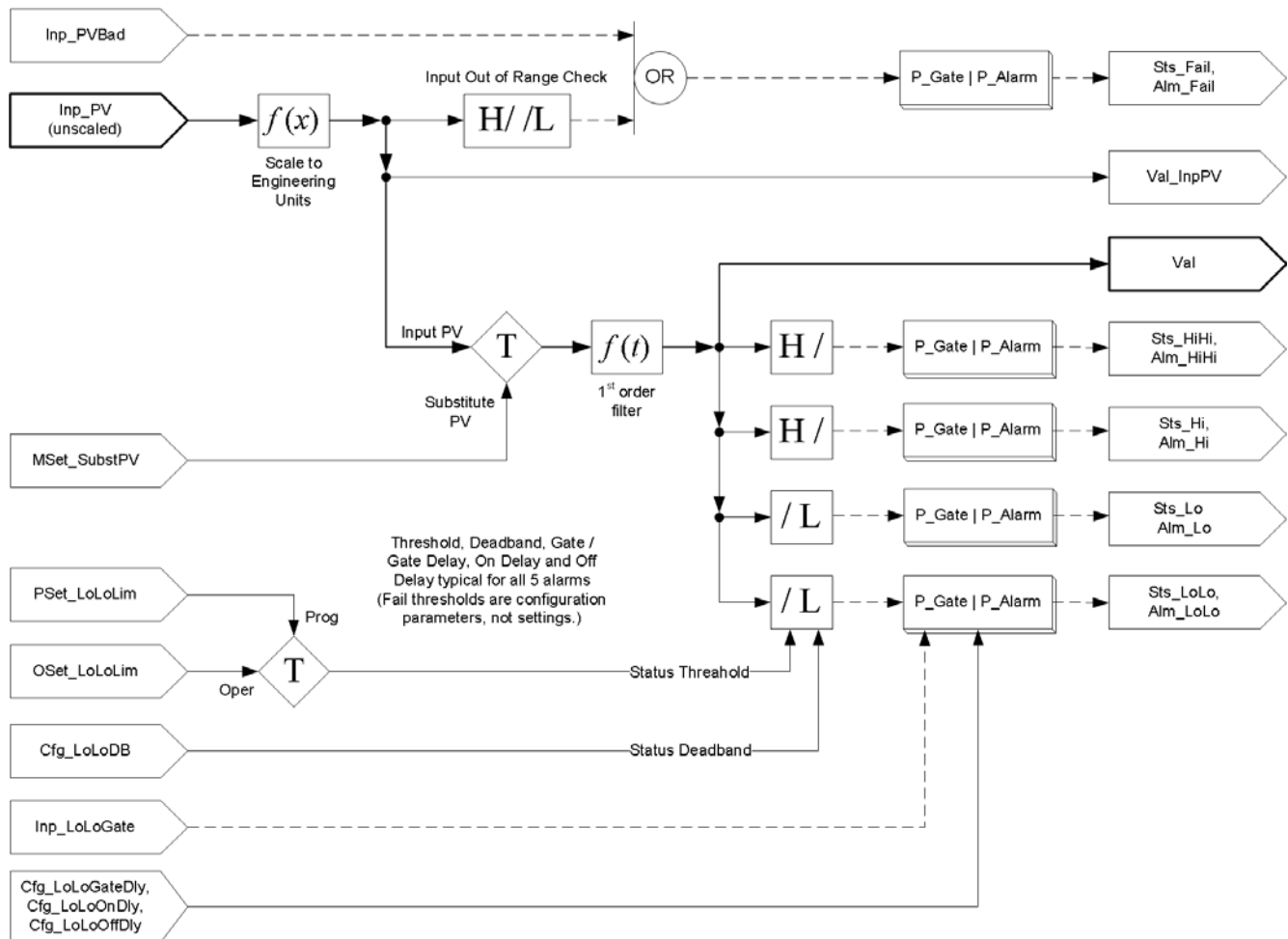

The Basic Analog Input instruction provides the following capabilities:

- Scales an analog input from raw to engineering units and optionally filters the signal.
- Provides High-High, High, Low and Low-Low status and alarms with configurable delay times and deadbands.
- Provides Program and Operator settings for status thresholds.
- Provides input failure checking for out-of-range High and out-of-range Low, plus PV quality and alarm on failure.
- Provides Maintenance selection of the substitute PV function to allow manual override of the input signal (PV).
- Monitors input quality and communications status. Provides value and indication of source and quality for the input signal and the final PV value.
- Uses a standard mode model (P_Mode instruction) to provide mode (ownership) selection. See the [Modes](#) section for more information.

Required Files

Add-On Instructions are reusable code objects that contain encapsulated logic that can streamline implementing your system. This lets you create your own instruction set for programming logic as a supplement to the instruction set provided natively in the ControlLogix® firmware. An Add-On Instruction is defined once in each controller project, and can be instantiated multiple times in your application code as needed.

Controller File

The P_AIn_3_5-00_AOIL5X Add-On Instruction must be imported into the controller project to be used in the controller configuration. The service release number (boldfaced) can change as service revisions are created.

Visualization Files

<http://www.rockwellautomation.com/global/support/pcdc.page> This Add-On Instruction has associated visualization files that provide a common user interface. These files can be downloaded from the Product Compatibility and Download Center at <http://www.rockwellautomation.com/rockwellautomation/support/pcdc.page>.

IMPORTANT The visualization file dependencies require Process Library content imports to occur in a specific order as reflected in the following tables:

- Images
- Global Objects
- Standard Displays
- HMI Tags
- Macros

Images are external graphic files that can be used in displays. They must be imported for FactoryTalk View to make use of them.

When PNG files are imported, they are renamed by FactoryTalk View with a .bmp file extension, but retain a .png format.

Table 2 - Visualization Files: Images (.png)

FactoryTalk View SE Software	FactoryTalk View ME Software	Description
All .png files in the images folder	All .png files in the images folder	These are the common icons used in the global objects and standard displays for all Process Objects.

The Global Object files (.ggfx file type) in the following table are Process Library display elements that are created once and referenced multiple times on multiple displays in an application. When changes are made to a Global Object, all instances in the application are automatically updated.

Table 3 - Visualization Files: Global Objects (.ggfx)

FactoryTalk View SE Software	FactoryTalk View ME Software	Description
(RA-BAS) Common Faceplate Objects	(RA-BAS-ME) Common Faceplate Objects	Global objects used on process object faceplates.
(RA-BAS) P_AIn Graphics Library	(RA-BAS-ME) P_AIn Graphics Library	Analog Input global object device symbols used to build process graphics.
(RA-BAS) Process Alarm Objects	(RA-BAS-ME) Process Alarm Objects	Global objects used for managing alarms on process object faceplates.
(RA-BAS) Process Faceplate Analog Objects	(RA-BAS-ME) Process Faceplate Analog Objects	Analog global objects used on process object faceplates.
(RA-BAS) Process Help Objects	(RA-BAS-ME) Process Help Objects	Global objects used for all process objects help displays.
(RA-BAS) Process Mode Objects	(RA-BAS-ME) Process Mode Objects	Global objects used for managing modes on process object faceplates.

The Standard Display files (.gfx file type) in the following table are the Process Library displays that you see at runtime.

Table 4 - Visualization Files: Standard Displays (.gfx)

FactoryTalk View SE Software	FactoryTalk View ME Software	Description
(RA-BAS) Common-AnalogEdit	N/A	Faceplate used for analog input data entry. The FactoryTalk View ME faceplates use the native analog input data entry so no file is required.
(RA-BAS) P_AIn-Faceplate	(RA-BAS-ME) P_AIn-Faceplate	The faceplate that is used for the object.
(RA-BAS) P_AIn-Quick	(RA-BAS-ME) P_AIn-Quick	The Quick display that is used for the object.
(RA-BAS) P_Alarm-Faceplate	(RA-BAS-ME) P_Alarm-Faceplate	The faceplate that is used for the object
(RA-BAS) P_Alarm-Help	(RA-BAS-ME) P_Alarm-Help	Alarm Help information that is accessed from the P_Alarm faceplate.
(RA-BAS) P_Gate-Faceplate	(RA-BAS-ME) P_Gate-Faceplate	The gate faceplate display used for the object.
(RA-BAS) P_Mode-Config	(RA-BAS-ME) P_Mode-Config	The Configuration Display used to configure the P_Mode object.
(RA-BAS) P_Mode-Help	(RA-BAS-ME) P_Mode-Help	Mode Help information that is accessed from the Help faceplate.
(RA-BAS) Process AnalogIn Family-Help	(RA-BAS-ME) Process AnalogIn Family-Help	The Help display for AnalogIn objects
(RA-BAS) P_AIChan-Faceplate	(RA-BAS-ME) P_AIChan-Faceplate	Optional The Channel faceplate used for the object. Use this file if your Analog Input has an associated P_AIChan object and you enable navigation to its faceplate from the Analog Input faceplate.
(RA-BAS) P_AIChan-Help	(RA-BAS-ME) P_AIChan-Help	Optional Channel Help information that is accessed from the P_AIChan Help faceplate. Use this file if you use the Analog Input Channel faceplate.

HMI Tags are created in a FactoryTalk View ME application to support tab switching on Process Library faceplates. The HMI tags may be imported via the comma-separated values file (.csv file type) in the following table.

Table 5 - Visualization Files: HMI Tags (.csv)

FactoryTalk View SE Software	FactoryTalk View ME Software	Description
N/A	FTVME_PlantPAXLib_Tags_3_5_XX.csv where XX = the service release number.	These tags must be imported into the FactoryTalk View ME project to support switching tabs on any Process Object faceplate.

Controller Code

This section describes the parameter references for this Add-On Instruction.

Input Structure for Basic Analog Input

Input parameters include the following:

- Input data elements (Inp_) are typically used to connect field inputs from I/O modules or signals from other objects.
- Configuration data elements (Cfg_) are used to set configurable capabilities and features of the instruction.
- Commands (PCmd_, OCmd_, MCmd_) are used by program logic, operators, and maintenance personnel to request instruction actions.
- Settings (PSet_, OSet_, MSet_) are used by program logic, operators, and maintenance personnel to establish runtime setpoints, thresholds, and so forth. A Setting (without a leading P, O, or M) establishes runtime settings regardless of role or mode.

Table 7 - P_Aln Input Parameters

Input Parameter	Data Type	Alias For	Default	Description
EnableIn	BOOL		1	<p>Ladder Diagram: If the rung-in condition is true, the instruction's Logic routine executes. If the rung-in condition is false, the instruction's EnableInFalse routine executes.</p> <p>Function Block Diagram: If true, or not connected, the instruction's Logic routine executes. If the parameter is exposed as a pin and wired, and the pin is false, the instruction's EnableInFalse routine executes.</p> <p>Structured Text: No effect. The instruction's Logic routine executes.</p>
Inp_PV	REAL		0.0	Input Signal (Process Variable) from sensor.
Inp_PVSrcq	SINT		0	Input Source and Quality (from Channel object, if available) (enumeration)
Inp_PVBad	BOOL		0	Bad Signal Quality/Communication Status for Inputs (1 = Bad, 0 = OK). If PV is read from an analog input, then this is normally read from the analog input channel fault status.
Inp_PVUncertain	BOOL		0	Uncertain Quality for Input (1 = Uncertain, 0 = OK). This is optional status for the input that can be used to drive the status of the output (Sts_PVUncertain).
Inp_Sim	BOOL		0	1 = Use simulated PV (Set_SimPV) 0 = Use Input (Inp_PV)
Inp_HiHiGate	BOOL	HiHiGate.Inp_Gate	1	<p>These parameters are the gate inputs used for status detection. When set to 1, the corresponding analog input threshold monitoring is enabled. When enabled, the threshold detection on-delay and off-delay timers are applied after the gate delay timer. When set to 0, detection is disabled and the corresponding status output is forced off.</p> <p>If the status is used as an alarm, this input provides a method for suppression-by-design alarm management.</p>
Inp_HiGate		HiGate.Inp_Gate		
Inp_LoGate		LoGate.Inp_Gate		
Inp_LoLoGate		LoLoGate.Inp_Gate		
Inp_FailGate		FailGate.Inp_Gate		
Inp_Reset	BOOL		0	Input parameter used to programatically reset alarms. When set to 1, all alarms requiring reset are reset.
Cfg_NoSubstPV	BOOL		0	This parameter provides the ability to disable the maintenance substitution feature. When this parameter is 0, the Substitute PV function is allowed. When this parameter is 1, the Substitute PV Maintenance function is disallowed.

Table 7 - P_Aln Input Parameters

Input Parameter	Data Type	Alias For	Default	Description
Cfg_SetTrack	BOOL		1	This parameter is used to set up bumpless behavior of setting parameters when switching modes: <ul style="list-style-type: none"> When this parameter is 1, in Program mode the operator settings track the program settings, in Operator mode the program settings track the operator settings, and the simulation inputs match the output values (transitions are bumpless). When this parameter is 0, the operator settings and program settings are not modified by this instruction. In this case, when the mode is changed, the effective value of the setting can change depending on the program-set and operator-set values.
Cfg_HasChanObj	BOOL		0	1 = Tells HMI a channel object (for example, P_AlnChan) is used for Inp_PV and navigation to the channel object's faceplate is enabled. IMPORTANT: The name of the Channel object in the controller must be this object's name with the suffix '_Chan'. For example, if your P_Aln object has the name 'Aln123', then its Channel object must be named 'Aln123_Chan'.
Cfg_PCmdClear	BOOL	Mode.Cfg_PCmdClear	1	When this parameter is 1, program commands are cleared once they are acted upon. When set to 0, program commands remain set until cleared by the application program logic.
Cfg_ProgDefault	BOOL	Mode.Cfg_ProgDefault	0	This parameter defines the default mode. When this parameter is 1, the mode defaults to Program if no mode is being requested. When this parameter is 0, the mode defaults to Operator if no mode is being requested. IMPORTANT: Changing this parameter online can cause unintended mode changes.
Cfg_HasHiHiAlm	BOOL	HiHi.Cfg_Exists	0	These parameters determine whether the corresponding alarm exists and is checked or if the alarm does not exist and is not used. When these parameters are 1, the corresponding alarm exists.
Cfg_HasHiAlm		Hi.Cfg_Exists		
Cfg_HasLoAlm		Lo.Cfg_Exists		
Cfg_HasLoLoAlm		LoLo.Cfg_Exists		
Cfg_HasFailAlm		Fail.Cfg_Exists		
Cfg_HiHiResetReqd	BOOL	HiHi.Cfg_ResetReqd	0	These parameters determine whether a reset is required to clear the alarm status. When these parameters are 1, the alarm is latched ON when the alarm occurs. After the alarm condition returns to normal, a reset is required to clear the alarm status (for example, OCmd_Reset, Inp_Reset, or Hi.OCmd_Reset is required to clear Alm_Hi alarm after the alarm is set and the value returns to normal). When these parameters are 0, no reset is required and the alarm status is cleared when the alarm condition returns to normal. IMPORTANT: If the reset clears the alarm, it also acknowledges the alarm.
Cfg_HiResetReqd		Hi.Cfg_ResetReqd		
Cfg_LoResetReqd		Lo.Cfg_ResetReqd		
Cfg_LoLoResetReqd		LoLo.Cfg_ResetReqd		
Cfg_FailResetReqd		Fail.Cfg_ResetReqd		
Cfg_HiHiAckReqd	BOOL	HiHi.Cfg_AckReqd	1	These parameters determine whether an acknowledgement is required for an alarm. When these parameters are 1, the acknowledge (ack) bit is cleared when the alarm occurs. An acknowledge command (for example, PCmd_FailAck or Fail.OCmd_Ack) is required to acknowledge the alarm. When set to 0, the Acknowledge bit is set when an alarm occurs indicating an acknowledged alarm and no acknowledge command is required.
Cfg_HiAckReqd		Hi.Cfg_AckReqd		
Cfg_LoAckReqd		Lo.Cfg_AckReqd		
Cfg_LoLoAckReqd		LoLo.Cfg_AckReqd		
Cfg_FailAckReqd		Fail.Cfg_AckReqd		
Cfg_HiHiSeverity	INT	HiHi.Cfg_Severity	750	These parameters determine the severity of each alarm. This drives the color and symbol that are used to indicate alarm status on the faceplate and global object. The following are valid values: 1...250 = Low 251...500 = Medium 501...750 = High 751...1000 = Urgent IMPORTANT: For FactoryTalk View Site Edition (SE) software, version 7.0, these severity parameters drive only the indication on the global object and faceplate. The Alarms and Events definition of severity drives the color and symbol that is used on the alarm banner and alarm summary as well as the value returned by FactoryTalk Alarms and Events display commands.
Cfg_HiSeverity		Hi.Cfg_Severity	500	
Cfg_LoSeverity		Lo.Cfg_Severity	500	
Cfg_LoLoSeverity		LoLo.Cfg_Severity	750	
Cfg_FailSeverity		Fail.Cfg_Severity	1000	
Cfg_InpRawMin	REAL		0.0	Input (unscaled) minimum for scaling.
Cfg_InpRawMax	REAL		100.0	Input (unscaled) maximum for scaling.
Cfg_PVEUMin	REAL		0.0	PV (Output) minimum for scaling to engineering units.

Table 7 - P_Aln Input Parameters

Input Parameter	Data Type	Alias For	Default	Description
Cfg_PVEUMax	REAL		100.0	PV (Output) maximum for scaling to engineering units. TIP: The P_Aln instruction supports reverse scaling; either the raw (Input) or engineering (Scaled) range can be reversed (maximum less than minimum).
Cfg_FiltTC	REAL		0.0	PV first-order filter time constant in seconds. A value of 0.0 means the PV is unfiltered.
Cfg_HiHiDB			1.0	These parameters set the deadband (hysteresis) that is applied to each alarm limit. This is used to prevent a noisy signal from generating spurious alarms. EXAMPLE: If the High Alarm is enabled (Cfg_HasHiAlm = 1), the High Alarm Limit (Val_HiLim) is 90 and the High Alarm Deadband (Cfg_HiDB) is 5, the high alarm is generated when the output (Val) rises above 90 and is cleared once the output (Val) falls below 85 (90 minus 5).
Cfg_HiDB			1.0	
Cfg_LoDB			1.0	
Cfg_LoLoDB			1.0	
Cfg_FailDB			0.416667	
Cfg_HiHiGateDly	DINT	HiHiGate.Cfg_GateDly	0	
Cfg_HiGateDly		HiGate.Cfg_GateDly		
Cfg_LoGateDly		LoGate.Cfg_GateDly		
Cfg_LoLoGateDly		LoLoGate.Cfg_GateDly		
Cfg_FailGateDly		FailGate.Cfg_GateDly		
Cfg_HiHiOnDly	DINT	HiHiGate.Cfg_OnDly	0	These parameters determine the minimum time (in seconds) the PV must remain beyond the status threshold for the status to be set. On-delay times are used to avoid unnecessary alarms when an output (Val) briefly overshoots its threshold (for example, Val_HiHiLim).
Cfg_HiOnDly		HiGate.Cfg_OnDly		
Cfg_LoOnDly		LoGate.Cfg_OnDly		
Cfg_LoLoOnDly		LoLoGate.Cfg_OnDly		
Cfg_FailOnDly		FailGate.Cfg_OnDly		
Cfg_HiHiOffDly	DINT	HiHiGate.Cfg_OffDly	0	These parameters determine the amount of time (in seconds) the output must stay within each status threshold to clear the status. Off-delay times are used to reduce chattering alarms. EXAMPLE: If Cfg_HiOffDly is 5 seconds, the output (Val) must be below the status limit (Val_HiHiLim) minus deadband (Cfg_HiHiDB) for 5 seconds before the status is returned to normal.
Cfg_HiOffDly		HiGate.Cfg_OffDly		
Cfg_LoOffDly		LoGate.Cfg_OffDly		
Cfg_LoLoOffDly		LoLoGate.Cfg_OffDly		
Cfg_FailOffDly		FailGate.Cfg_OffDly		
Cfg_FailHiLim	REAL		103.9583	Out-of-Range (fail) High threshold (in engineering units).
Cfg_FailLoLim	REAL		-2.08333	Out-of-Range (fail) Low threshold (in engineering units).
PSet_HiHiLim	REAL		1.5E+038	Program-entered High-High status threshold (in engineering units).
PSet_HiLim	REAL		1.5E+038	Program-entered High status threshold (in engineering units).
PSet_LoLim	REAL		-1.5E+038	Program-entered Low status threshold (in engineering units).
PSet_LoLoLim	REAL		-1.5E+038	Program-entered Low-Low status threshold (in engineering units).
PSet_Owner	DINT		0	Program Owner request ID (non-zero) or Release (0).
MSet_SubstPV	REAL		0.0	Maintenance-entered Substitute PV (in engineering units).
OSet_HiHiLim	REAL		1.50E+038	Operator-entered High-High status threshold (in engineering units).
OSet_HiLim	REAL		1.50E+038	Operator-entered High status threshold (in engineering units).
OSet_LoLim	REAL		-1.50E+038	Operator-entered Low status threshold (in engineering units).
OSet_LoLoLim	REAL		-1.50E+038	Operator-entered Low-Low status threshold (in engineering units).
Set_SimPV	REAL		0.0	PV used in simulation (Inp_Sim = 1) (in engineering units).
PCmd_ClearCapt	BOOL		0	<ul style="list-style-type: none"> Set PCmd_ClearCapt to 1 to clear the captured minimum/maximum PV excursion values The parameter is reset Automatically

Table 7 - P_Aln Input Parameters

Input Parameter	Data Type	Alias For	Default	Description
PCmd_Acq	BOOL	Mode.PCmd_Acq	0	When Cfg_PCmdClear is 1: <ul style="list-style-type: none"> Set PCmd_Acq to 1 to Acquire Set PCmd_Rel to 1 to Release These parameters reset automatically When Cfg_PCmdClear is 0: <ul style="list-style-type: none"> Set PCmd_Acq to 1 to Acquire Set PCmd_Acq to 0 to Release PCmd_Rel is not used These parameters do not reset automatically
PCmd_Rel		Mode.PCmd_Rel		
PCmd_Lock	BOOL	Mode.PCmd_Lock	0	When Cfg_PCmdClear is 1: <ul style="list-style-type: none"> Set PCmd_Lock to 1 to Lock Set PCmd_Unlock to 1 to Unlock These parameters reset automatically When Cfg_PCmdClear is 0: <ul style="list-style-type: none"> Set PCmd_Lock to 1 to Lock Set PCmd_Lock to 0 to Unlock PCmd_Unlock is not used These parameters do not reset automatically
PCmd_Unlock		Mode.PCmd_Unlock		
PCmd_Reset	BOOL		0	<ul style="list-style-type: none"> Set PCmd_Reset to 1 to reset all alarms requiring reset This parameter is always reset automatically
PCmd_HiHiAck	BOOL	HiHi.PCmd_Ack	0	<ul style="list-style-type: none"> Set PCmd_<Alarm>Ack to 1 to Acknowledge alarm The parameter is reset automatically
PCmd_HiAck		Hi.PCmd_Ack		
PCmd_LoAck		Lo.PCmd_Ack		
PCmd_LoLoAck		LoLo.PCmd_Ack		
PCmd_FailAck		Fail.PCmd_Ack		
PCmd_HiHiSuppress	BOOL	HiHi.PCmd_Suppress	0	When Cfg_PCmdClear is 1: <ul style="list-style-type: none"> Set PCmd_<Alarm>Suppress to 1 to suppress alarm Set PCmd_<Alarm>Unsuppress to 1 to unsuppress alarm These parameters reset automatically When Cfg_PCmdClear is 0: <ul style="list-style-type: none"> Set PCmd_<Alarm>Suppress to 1 to suppress alarm Set PCmd_<Alarm>Suppress to 0 to unsuppress alarm PCmd_<Alarm>Unsuppress is not used These Parameters do not reset automatically
PCmd_HiSuppress		Hi.PCmd_Suppress		
PCmd_LoSuppress		Lo.PCmd_Suppress		
PCmd_LoLoSuppress		LoLo.PCmd_Suppress		
PCmd_FailSuppress		Fail.PCmd_Suppress		
PCmd_HiHiUnsuppress		HiHi.PCmd_Unsuppress		
PCmd_HiUnsuppress		Hi.PCmd_Unsuppress		
PCmd_LoUnsuppress		Lo.PCmd_Unsuppress		
PCmd_LoLoUnsuppress		LoLo.PCmd_Unsuppress		
PCmd_FailUnsuppress		Fail.PCmd_Unsuppress		
PCmd_HiHiUnshelve	BOOL	HiHi.PCmd_Unshelve	0	<ul style="list-style-type: none"> Set PCmd_<Alarm>Unshelve to 1 to Unshelve alarm The parameter is reset automatically
PCmd_HiUnshelve		Hi.PCmd_Unshelve		
PCmd_LoUnshelve		Lo.PCmd_Unshelve		
PCmd_LoLoUnshelve		LoLo.PCmd_Unshelve		
PCmd_FailUnshelve		Fail.PCmd_Unshelve		
MCmd_SubstPV	BOOL		0	Maintenance command to select substitute PV (in engineering units).
MCmd_InpPV	BOOL		0	Maintenance command to use Input PV (normal).
OCmd_ClearCapt	BOOL		0	Operator command to clear the captured minimum/maximum PV excursion values.
MCmd_Acq	BOOL	Mode.MCmd_Acq	0	Maintenance command to acquire ownership (Operator/Program/Override to Maintenance)
MCmd_Rel	BOOL	Mode.MCmd_Rel	0	Maintenance command to release ownership (Maintenance to Operator/Program/Override)
OCmd_AcqLock	BOOL	Mode.OCmd_AcqLock	0	Operator command to acquire and lock mode in Operator.

Table 7 - P_Aln Input Parameters

Input Parameter	Data Type	Alias For	Default	Description
OCmd_Unlock	BOOL	Mode.OCmd_UnlockRel	0	Operator command to unlock Operator mode.
OCmd_Reset	BOOL		0	Operator command to reset all alarms requiring reset.
OCmd_ResetAckAll	BOOL		0	Operator command to reset and acknowledge all alarms.

Output Structure for Basic Analog Input

Output parameters include the following:

- Value data elements (Val_) are numeric outputs of the instruction for use by the HMI. Values also can be used by other application logic or software packages.
- Source and Quality data elements (SrcQ_) are outputs of the instruction used by the HMI to indicate PV source and quality.
- Status data elements (Sts_) are bit outputs of the instruction for use by the HMI. Status bits also can be used by other application logic.
- Error data elements (Err_) are outputs of the instruction that indicate a particular configuration error. If any Err_bit is set, then the Sts_Err configuration error summary status is set and the Invalid Configuration indicator is displayed on the HMI.
- Alarm data elements (Alm_) are outputs of the instruction that indicate a particular alarm has occurred.
- Acknowledge data elements (Ack_) are outputs of the instruction that indicate the corresponding alarm has been acknowledged.
- Ready data elements (Rdy_) are bit outputs of the instruction used by the HMI to enable or disable Command buttons and Setting entry fields.

Table 8 - P_Aln Output Parameters

Parameter	Data Type	Alias For	Description
EnableOut	BOOL		Enable Output: The EnableOut signal is not manipulated by this instruction. Its output state always reflects EnableIn Input state.
Val	REAL		Analog value (after substitute PV, if used).
Val_InpPV	REAL		Analog Input value (actual, before substitute PV selection).
Val_PVMinCapt	REAL		Captured PV minimum (excursion) since last cleared.
Val_PVMaxCapt	REAL		Captured PV maximum (excursion) since last cleared.
Val_PVEUMin	REAL		Minimum of scaled range = Min (Cfg_PVEUMin, Cfg_PVEUMax).
Val_PVEUMax	REAL		Maximum of scaled range = Max (Cfg_PVEUMin, Cfg_PVEUMax).

Table 8 - P_Aln Output Parameters

Parameter	Data Type	Alias For	Description
SrcQ_IO	SINT		I/O signal source and quality.
SrcQ			Final PV source and quality. GOOD 0 = I/O live and confirmed good quality 1 = I/O live and assumed good quality 2 = No feedback configured, assumed good quality TEST 8 = Device simulated 9 = Device loopback simulation 10 = Manually entered value UNCERTAIN 16 = Live input, off-specification 17 = Value substituted at device/bus 18 = Value substituted by maintenance (Has and not Use) 19 = Shed, using last good value 20 = Shed, using replacement value BAD 32 = Signal failure (out-of-range, NaN, invalid combination) 33 = I/O channel fault 34 = I/O module fault 35 = Bad I/O configuration (for example, scaling parameters)
Val_Fault	SINT		Device fault status: 0 = None 20 = Low 21 = High 24 = Low-Low 25 = High-High 32 = Fail 34 = Configuration Error
Val_Mode	SINT	Mode.Val	The current mode is shown with status bits and also as an enumeration 'Val_Mode' as follows: 0 = No mode 2 = Maintenance 4 = Program (locked) 5 = Operator (locked) 6 = Program (unlocked, Operator is default) 7 = Operator (unlocked, Program is default) 8 = Program (unlocked, Program is default) 9 = Operator (unlocked, Operator is default)
Val_Owner	DINT		Current Object Owner ID (0 = not owned).
Val_Notify	SINT		Current alarm level and acknowledgement (enumeration): 0 = No alarm 1 = Alarm cleared: a reset or acknowledge is required 2 = Low (acknowledged) 3 = Low (unacknowledged) 4 = Medium (acknowledged) 5 = Medium (unacknowledged) 6 = High (acknowledged) 7 = High (unacknowledged) 8 = Urgent (acknowledged) 9 = Urgent (unacknowledged)
Val_HiHiLim	REAL		Current High-High status threshold.
Val_HiLim	REAL		Current High status threshold.
Val_LoLim	REAL		Current Low status threshold.
Val_LoLoLim	REAL		Current Low-Low status threshold.
Sts_SubstPV	BOOL		1 = Using substitute PV (Input being overridden).
Sts_InpPV	BOOL		1 = Using input PV (normal).

Table 8 - P_Aln Output Parameters

Parameter	Data Type	Alias For	Description
Sts_PVBad	BOOL		1 = PV bad quality or Out of Range.
Sts_PVUncertain	BOOL		1 = PV value is uncertain (quality).
Sts_MaintByp	BOOL		1 = A Maintenance bypass is Active, display icon.
Sts_Almlnh	BOOL		1 = An alarm is shelved, disabled or suppressed, display icon.
Sts_Err	BOOL		1 = Error in configuration (see detail Err_bits for reason), display icon.
Err_Raw	BOOL		1 = Error in configuration: raw input scaling minimum = maximum.
Err_EU	BOOL		1 = Error in configuration: scaled engineering units minimum = maximum.
Err_Timer	BOOL		1 = Error in configuration: On-delay, Off-delay time invalid (use 0...2,147,483 seconds).
Err_Filt	BOOL		1 = Error in configuration: PV filter time constant parameter.
Err_DB	BOOL		1 = Error in configuration: a status deadband is < 0.0.
Err_Alarm	BOOL		1 = Error in configuration: alarm minimum on time or severity.
Sts_Maint	BOOL	Mode.Sts_Maint	1 = Mode is Maintenance (supersedes Program, Operator).
Sts_Prog	BOOL	Mode.Sts_Prog	1 = Mode is Program.
Sts_Oper	BOOL	Mode.Sts_Oper	1 = Mode is Operator.
Sts_ProgOperLock	BOOL	Mode.Sts_ProgOperLock	1 = Program or Operator has requested mode lock.
Sts_NoMode	BOOL	Mode.Sts_NoMode	1 = No mode (disabled because EnableIn is false).
Sts_MAcq_Rcvd	BOOL	Mode.Sts_MAcqRcvd	1 = Maintenance Acquire command received this scan.
Sts_HiHiCmp	BOOL	HiHiGate.Inp	PV High-High, High, Low, Low-Low, or Fail comparison result 1 = High-High, High, Low, Low-Low, or Fail
Sts_HiCmp		HiGate.Inp	
Sts_LoCmp		LoGate.Inp	
Sts_LoLoCmp		LoLoGate.Inp	
Sts_FailCmp		FailGate.Inp	
Sts_HiHiGate	BOOL	HiHiGate.Sts_Gate	PV High-High, High, Low, Low-Low, or Fail gate delay status 1 = Done.
Sts_HiGate		HiGate.Sts_Gate	
Sts_LoGate		LoGate.Sts_Gate	
Sts_LoLoGate		LoLoGate.Sts_Gate	
Sts_FailGate		FailGate.Sts_Gate	
Sts_HiHi	BOOL	HiHi.Inp	1 = Analog Input is above High or High-High limit.
Sts_Hi		Hi.Inp	
Sts_Lo		Lo.Inp	1 = Analog Input is below Low or Low-Low limit.
Sts_LoLo		LoLo.Inp	
Sts_Fail		Fail.Inp	1 = Analog Input is Out of Range or PV Bad.
Alm_HiHi	BOOL	HiHi.Alm	1 = Analog Input is in High-High, High, Low, Low-Low, or Fail (PV bad or out of range) alarm.
Alm_Hi		Hi.Alm	
Alm_Lo		Lo.Alm	
Alm_LoLo		LoLo.Alm	
Alm_Fail		Fail.Alm	

Table 8 - P_Aln Output Parameters

Parameter	Data Type	Alias For	Description
Ack_HiHi	BOOL	HiHi.Ack	1 = High-High, High, Low, Low-Low, or Analog Input failure alarm has been acknowledged.
Ack_Hi		Hi.Ack	
Ack_Lo		Lo.Ack	
Ack_LoLo		LoLo.Ack	
Ack_Fail		Fail.Ack	
Sts_HiHiDisabled	BOOL	HiHi.Disabled	1 = High-High, High, Low, Low-Low, or Fail alarm is disabled (by Maintenance).
Sts_HiDisabled		Hi.Disabled	
Sts_LoDisabled		Lo.Disabled	
Sts_LoLoDisabled		LoLo.Disabled	
Sts_FailDisabled		Fail.Disabled	
Sts_HiHiSuppressed	BOOL	HiHi.Suppressed	1 = High-High, High, Low, Low-Low, or Fail alarm is suppressed (by Program).
Sts_HiSuppressed		Hi.Suppressed	
Sts_LoSuppressed		Lo.Suppressed	
Sts_LoLoSuppressed		LoLo.Suppressed	
Sts_FailSuppressed		Fail.Suppressed	
Sts_HiHiShelved	BOOL	HiHi.Shelved	1 = High-High, High, Low, Low-Low, or Fail alarm is shelved (by Operator).
Sts_HiShelved		Hi.Shelved	
Sts_LoShelved		Lo.Shelved	
Sts_LoLoShelved		LoLo.Shelved	
Sts_FailShelved		Fail.Shelved	
Rdy_SubstPV	BOOL		1 = Ready for MCmd_SubstPV.
Rdy_InpPV	BOOL		1 = Ready for MCmd_InpPV.
Rdy_Reset	BOOL		1 = At least one alarm requires reset.
Rdy_ResetAckAll	BOOL		1 = At least one alarm requires reset or acknowledgement.
Rdy_OSet	BOOL		1 = Ready to receive OSets (enables data entry fields).
P_Aln	BOOL		Unique parameter name for auto-discovery.

Local Configuration Tags for Basic Analog Input

Configuration parameters that are array, string, or structure data types cannot be configured as parameters for Add-On Instructions. Configuration parameters of these types appear as local tags to the Add-On Instruction. Local tags can be configured through the HMI faceplates or in Studio 5000 Logix Designer® application by opening the instruction logic of the Add-On Instruction instance and then opening the Data Monitor on a local tag. These parameters cannot be modified by using controller logic or Logix Designer application export/import functionality.

Table 9 - P_Aln Local Configuration Tags

Tag Name	Data Type	Default	Description
Cfg_Desc	STRING_40	'Analog Input'	Description for display on HMI. This string is shown in the title bar of the faceplate.
Cfg_EU	STRING_8	'%'	Engineering units for display on HMI.
Cfg_Label	STRING_20	'Analog Input'	Label for graphic symbol displayed on HMI. This string appears on the graphic symbol.
Cfg_Tag	STRING_20	'P_Aln'	Tag name for display on the HMI. This string is shown in the title bar of the faceplate.

Operations

This section describes the primary operations for Add-On Instructions.

Modes

This instruction uses the following standard modes, which are implemented by using an embedded P_Mode Add-On Instruction.

Mode	Description
Operator	The Operator owns control of the device. Operator commands (OCmd_) and Operator settings (OSet_) from the HMI are accepted.
Program	Program logic owns control of the device. Program commands (PCmd_) and Program settings (PSet_) are accepted.
Maintenance	Maintenance owns control of the device and supersedes Operator, Program, and Override control. Operator commands and settings from the HMI are accepted. Bypassable interlocks and permissives are bypassed, and device timeout checks are not processed.
No Mode	The device is disabled and has no owner because the EnableIn input is false. The main instruction Logic routine is not being scanned. See Execution section for more information on EnableInFalse processing.

The following standard modes are not used:

- Hand mode
- Override (Ovr) mode

See Rockwell Automation Library of Process Objects: Common Mode Block (P_Mode) Reference Manual, publication [SYSLIB-RM005](#), for more information.

Alarms

This instruction uses the following alarms, which are implemented by using embedded P_Alarm and P_Gate Add-On Instructions.

Alarm Name	P_Alarm Name	P_Gate Name	Description
Fail	Fail	FailGate	Raised when any of the following is true: <ul style="list-style-type: none"> The PV quality is bad The Inp_PVBad input is true The PV is outside the configured failure limits The PV is infinite or not a number (floating-point exception) The raw or engineering unit range configuration is invalid
High PV	Hi	HiGate	Raised when the PV is above the High threshold. The threshold is set by the operator or by program logic. Deadband, gating, and timing are set in configuration.
High-High PV	HiHi	HiHiGate	Raised when the PV is above the High-High threshold. The threshold is set by the operator or by program logic. Deadband, gating, and timing are set in configuration.
Low PV	Lo	LoGate	Raised when the PV is below the Low threshold. The threshold is set by the operator or by program logic. Deadband, gating, and timing are set in configuration.
Low-Low PV	LoLo	LoLoGate	Raised when the PV is below the Low-Low threshold. The threshold is set by the operator or by program logic. Deadband, gating, and timing are set in configuration.

Parameters of the P_Alarm object can be accessed by using the following convention: [P_Alarm Name].[P_Alarm Parameter].

For more information, see the following Rockwell Automation Library of Process Objects publications:

- Common Alarm Block (P_Alarm) Reference Manual, publication [SYSLIB-RM002](#)
- Condition Gate Delay (P_Gate) Reference Manual, publication [SYSLIB-RM041](#)

Simulation

Simulation in P_Aln disables the normal input (Inp_PV) and provides an input on the Operator faceplate for you to enter your own input value.

You must set the Inp_Sim parameter in the controller to '1' to enable simulation. The

Simulation icon  is displayed at the bottom left of the Operator faceplate indicating the device is in simulation.

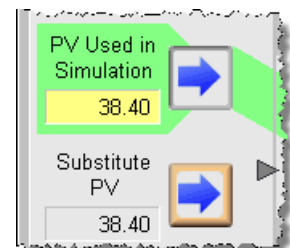

When you have finished in simulation, set the Inp_Sim parameter in the controller to '0' to return to normal operation.

Execution

The following table explains the handling of instruction execution conditions.

Condition	Description
EnableIn False (false rung)	The P_Aln Instruction shows a status of bad quality (Sts_PVBad) and an indication on the HMI. All alarms are cleared. The mode is reported as No Mode. However, calculation of the scaled Val_InpPV is executed to indicate to the operator the actual input value, even though the primary PV (Val) is not updated (holds last value).
Powerup (prescan, first scan)	Any commands received before first scan are discarded. Embedded P_Alarm and P_Mode instructions are handled in accordance with their standard power-up procedures. Refer to the Reference Manual for the P_Alarm and P_Mode Instruction for more information.
Postscan (SFC transition)	No SFC postscan logic is provided.

Refer to the Logix5000 Controllers Add-On Instructions Programming Manual, publication [1756-PM010](#), for more information.

Programming Example

This example uses the P_Aln instruction to read a temperature sensor that is also used elsewhere in logic to control the heating element of a chamber.

The Inp_PV parameter must be connected to the value coming from the temperature transmitter. The fault status for the associated I/O channel in the I/O module must be connected to the bad status input, Inp_PVBad.

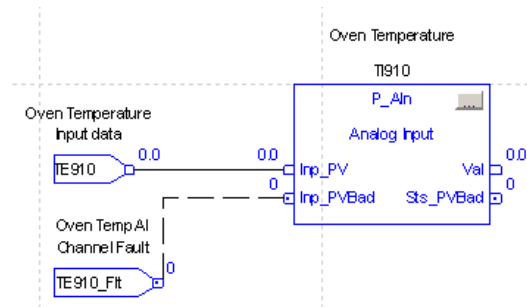

The output parameters Val and Sts_PVBad can then be connected to the PV and PVFault parameters of a PIDE instruction for control.

To implement this example, the following configuration input parameters need to be set. Those not listed can be left at their default. There is no alarming used in this example.

- Cfg_InpRawMin, Cfg_EUMin: 0 (engineering low range of temperature)
- Cfg_InpRawMax, Cfg_EUMax: 300 (engineering high range of temperature)

In addition, the following strings are configured to drive the display and faceplate:

- Cfg_Desc: Oven Temperature
- Cfg_EU: Deg C
- Cfg_Label: Oven Temp
- Cfg_Tag: TI910

The strings listed above are local tags that can be configured through the HMI faceplates or in Logix Designer application by opening the Instruction Logic of the Add-On Instruction instance and then opening the Data Monitor on a local tag.

Display Elements

A display element (global object) is created once and can be referenced multiple times on multiple displays in an application. When changes are made to the original (base) object, the instantiated copies (reference objects) are automatically updated. Use of global objects, in conjunction with tag structures in the ControlLogix system, aid consistency and save engineering time.

Table 10 - P_Aln Display Elements Description

Display Element Name	Display Element	Description
GO_P_Aln		Standard analog input global object.
GO_P_Aln_Trend		Analog input with a trend of the Primary Value and limits (high-high, high, low, and low-low).
GO_P_Aln_TrendWCapture		The object is the same as GO_P_Aln_Trend except it displays a capture of the Primary Value.
GO_P_Aln_Indicator		Primary Value indicated by a moving triangle. The graphic display includes limits displayed with filled bars.
GO_P_Aln_IndicatorWCapture		This object is the same as the GO_P_Aln_Indicator plus a light gray minimum/maximum capture area.

Table 10 - P_AIn Display Elements Description

Display Element Name	Display Element	Description
GO_P_AInX		Primary Value displayed as a bar graph. The graphic display includes limits displayed as lines on the graph.



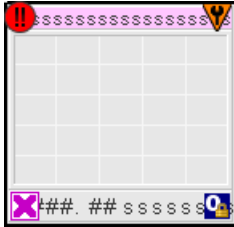
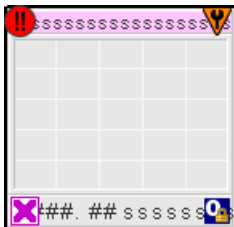
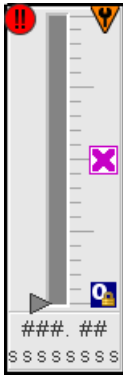
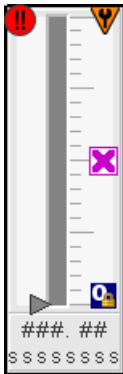
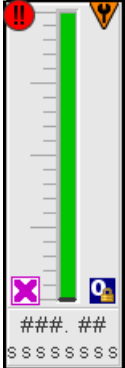
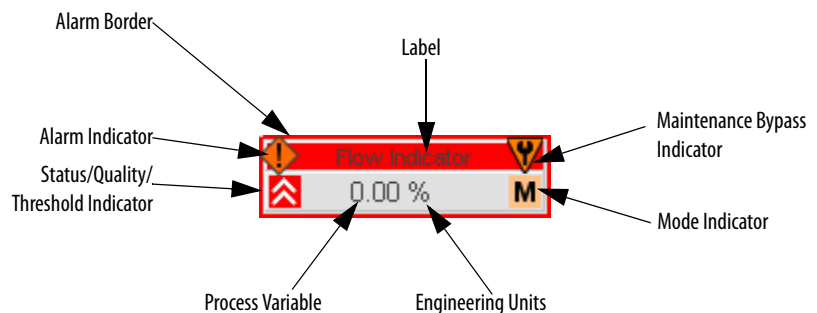

Common attributes of the P_AIn global objects include the following:

- Current value of the PV with engineering units
- Status/threshold/quality indicator
- Maintenance bypass indicator
- Engineering units
- Label
- Mode indicator
- Color changing alarm border that blinks on unacknowledged alarm
- Alarm indicator that changes color with the severity of an alarm



Status/Quality Indicators

One of these symbols appears on the graphic symbol when the described condition is true.

Graphic Symbol	Description
	Invalid configuration.
	Data quality bad/failure.
	Data Quality degraded: uncertain, test, simulation, substitution, or out of specification.
	The input or device has been disabled.
No symbol displayed	I/O communication and quality good, configuration valid.



TIP When the Invalid Configuration indicator appears, you can find what configuration setting is invalid by following the indicators. Click the graphic symbol to open the faceplate. The Invalid Configuration indicator appears next to the appropriate tab at the top of the faceplate to guide you in finding the configuration error. Once you navigate to the tab, the misconfigured item is flagged with this indicator or appears in a magenta box.



For the Analog Input Instruction, the Invalid Configuration indicator appears under the following conditions:

- The Input Raw Minimum and Raw Maximum scaling parameters are set to the same value.
- The Scaled Engineering Units Minimum and Engineering Units Maximum scaling parameters are set to the same value.
- The first-order filter time constant is set to a negative value.
- A Deadband is set to a negative value.
- An Alarm On-delay, Off-delay, or Minimum On Time is set to a value less than zero or greater than 2,147,483 seconds.
- Alarm Severity is set to a value less than 1 or greater than 1000.

Threshold Indicators







These indicators show that the PV has exceeded a threshold.

Graphic Symbol	Description
	High-High threshold exceeded
	High threshold exceeded

Graphic Symbol	Description
	Low threshold exceeded
	Low-Low threshold exceeded

Mode Indicators

One of these symbols appears on the right side of the graphic symbol to indicate the mode of the object instruction.







Graphic Symbol	Description
Transparent	Operator mode (if the default mode is Operator and the current mode is Operator, the mode indicator is transparent).
	Operator mode (if the default mode is Program).
	Operator mode locked.
Transparent	Program mode (if the default mode is Program and the current mode is Program, the mode indicator is transparent).
	Program mode (if the default mode is Operator).
	Program mode locked.
	Maintenance mode.
	No mode.

When the object is in the default mode, the mode indicator is transparent.

See Rockwell Automation Library of Process Objects: Common Mode Block (P_Mode) Reference Manual, publication [SYSLIB-RM005](#), for more information.

Alarm Indicators

One of these symbols appears on the left of the label to indicate the described alarm condition. The alarm border and label background blink if Acknowledgement of an alarm condition is required. Once the alarm is acknowledged, the alarm border and label background remain the color that corresponds to the severity of the alarm.

Symbol	Border and Label Background	Description
	No change in color	Alarm Inhibit: an alarm is suppressed by the Program, disabled by Maintenance, or shelved by the Operator.
	White	Return to normal (no alarm condition), but a previous alarm has not been acknowledged.
	Blue	Low severity alarm.
	Yellow	Medium severity alarm.
	Red	High severity alarm.
	Magenta	Urgent severity alarm.
No symbol	No change in color	No alarm or alarm inhibit condition, and all alarms are acknowledged.

See Rockwell Automation Library of Process Objects: Common Alarm Block (P_Alarm) Reference Manual, publication [SYSLIB-RM002](#), for more information.

Maintenance Bypass Indicator

This symbol appears to the right of the label to indicate that a maintenance bypass has been activated.

Graphic Symbol	Description
	A maintenance bypass is active.
No symbol displayed	No maintenance bypass is active.

TIP

When the Maintenance Bypass indicator appears, you can find what condition was bypassed by following the indicators. Click the graphic symbol to open the faceplate. The Maintenance Bypass indicator appears next to the appropriate tab at the top of the faceplate to guide you in finding the bypass. Once you navigate to the tab, the bypassed item is flagged with this indicator.

For the Analog Input Instruction, the Maintenance Bypass Indicator appears when the Substitute PV function has been enabled. The 'live' Process Variable is being superseded by a Maintenance-entered value.

Using Display Element

The global objects for P_AIn can be found in the global object file (RA-BAS) P_AIn Graphics Library.ggfx. Follow these steps to use a global object.

1. Copy the global object from the global object file and paste it in the display file.

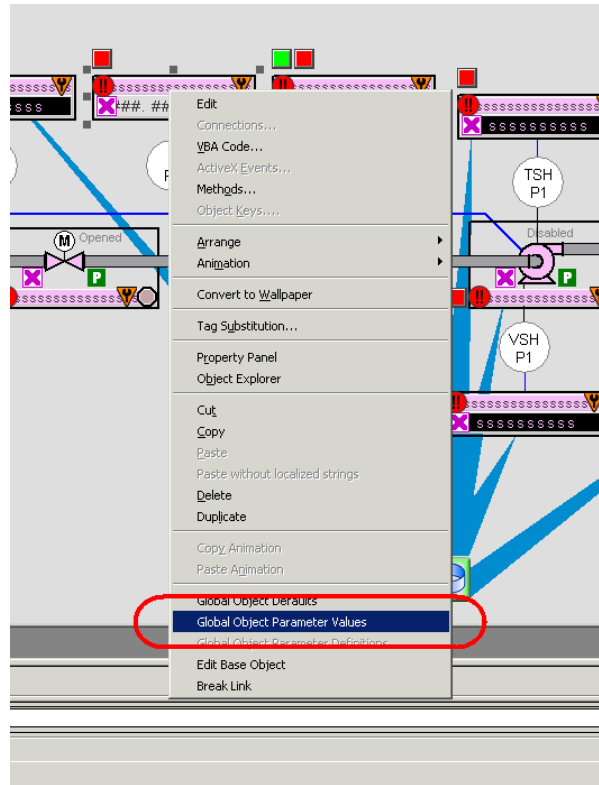

2. In the display, right-click the global object and choose Global Object Parameter Values.

The Global Object Parameter Values dialog box appears.

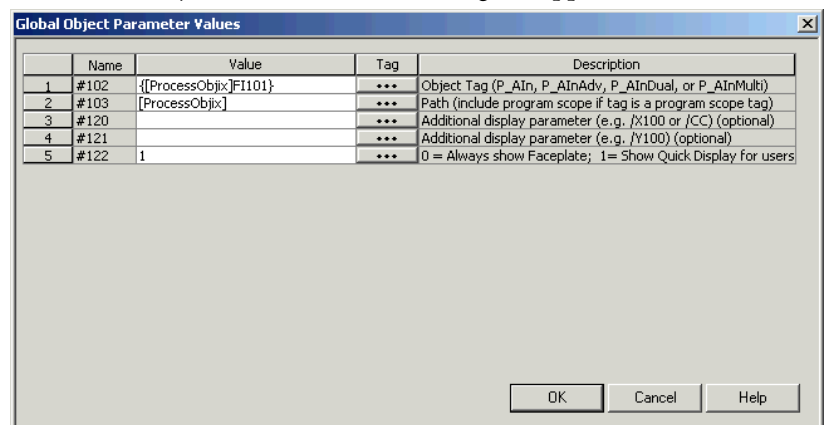

The global object parameters are as follows.

Parameter	Required	Description
#102	Y	Object tag to point to the name of the associated object Add-On Instruction in the controller.
#103	Y	Path used for display navigation features to other objects. Include program scope if tag is a program scope tag.
#120	N	Additional parameter to pass to the display command to open the faceplate. Typically used to define position for the faceplate.
#121	N	Additional parameter to pass to the display command to open the faceplate. If defining X and Y coordinate, separate parameters so that X is defined by #120 and Y is defined by #121. This lets these same parameters to be used in subsequent display commands originating from the faceplate.
#122	Y	These are the options for the global object display: 0 = Always show faceplate 1 = Show Quick Display for users without Maintenance access (Code C) 2 = Always show Quick Display

- In the Value column, type the tag or value as specified in the Description column.

TIP Click the ellipsis (...) to browse and select a tag.
Values for items marked '(optional)' can be left blank.

- Click OK.

Quick Display

The Quick Display screen provides means for operators to perform simple interactions with the P_AIn instruction instance. From the Quick Display, you can navigate to the faceplate for full access for operation, maintenance, and configuration.

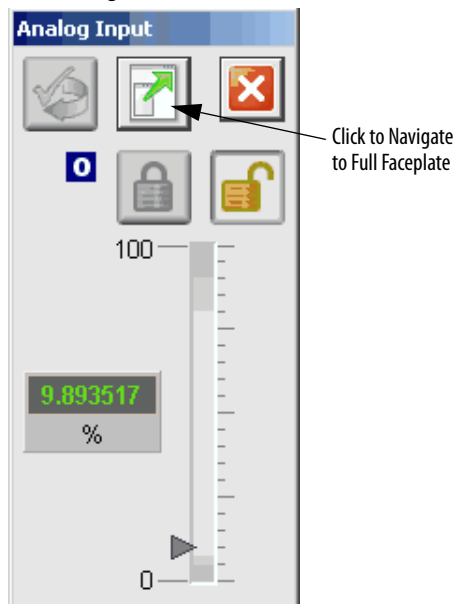

Faceplate

The P_AIn faceplate consists of five tabs and each tab consists of one or more pages.

Each faceplate contains the value of local configuration tags Cfg_Tag and Cfg_Desc in the title bar.

Tag - Description

The Operator tab is displayed when the faceplate is initially opened. Click the appropriate icon at the top of the faceplate to access a specific tab.

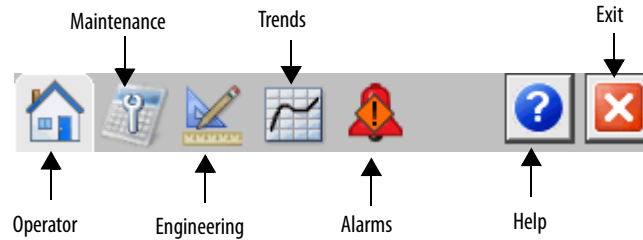

The faceplate provides the means for operators, maintenance workers, engineers, and others to interact with the P_AIn instruction instance, including viewing its status and values and manipulating it through its commands and settings. When a given input is restricted via FactoryTalk View security, the required user security code letter is shown in the tables that follow.

Operator Tab

The Faceplate initially opens to the Operator ('Home') tab. From here, an operator can monitor the device status and manually operate the device when it is in Operator mode.

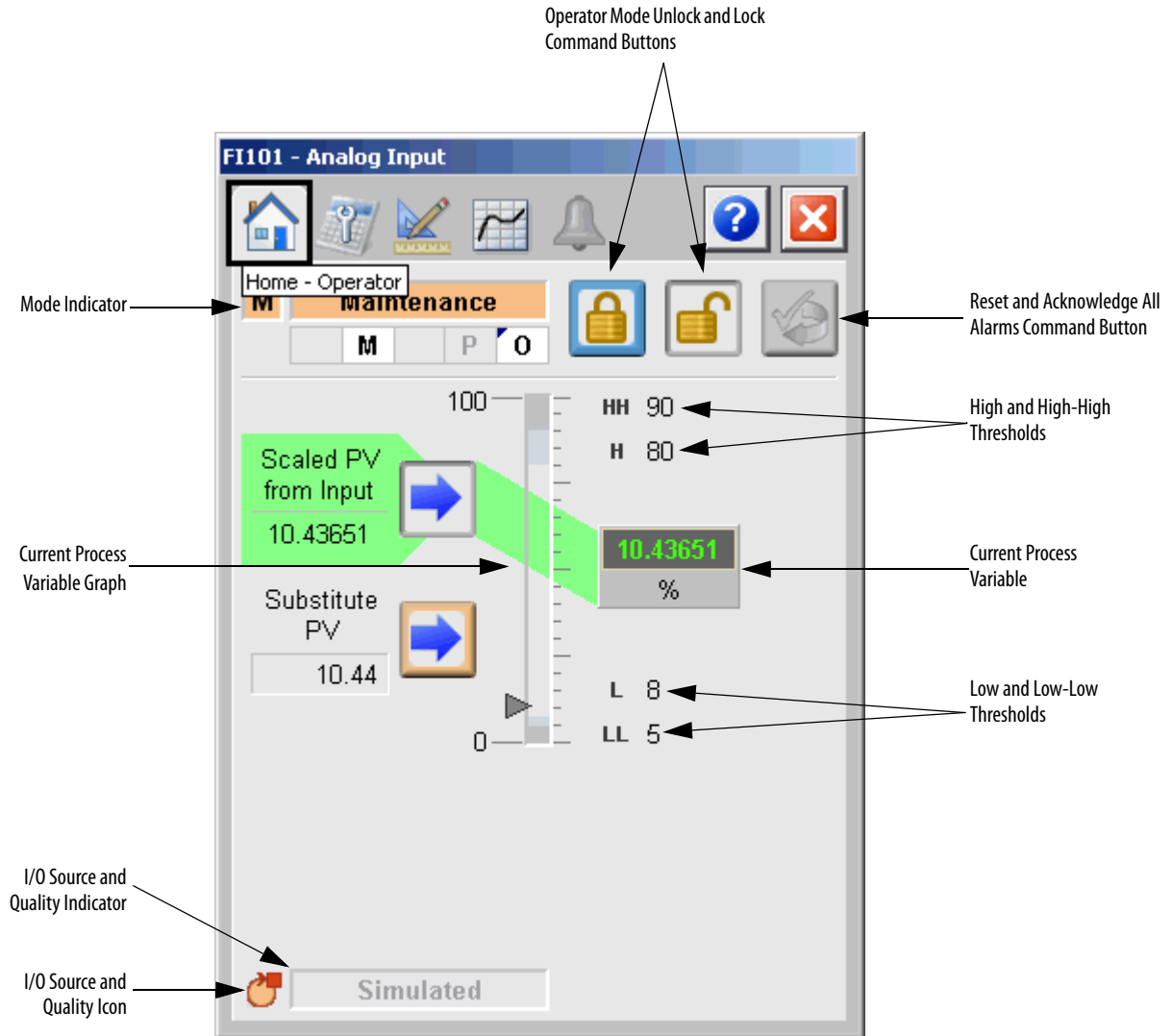







The Operator tab shows the following information:

- Current mode (Program, Operator, or Maintenance).
- Requested modes indicator (This appears only if the Operator or Program mode has been superseded by another mode.)
- Current Process Variable.
- Bar graph for the current Process Variable. High-High and Low-Low ranges are shown in dark gray and these ranges turn red if the threshold is exceeded. High and Low ranges are shown in medium gray, and these ranges turn yellow if the threshold is exceeded.
- Scaled High and Low Range Values (Top and Bottom labels on the bar graph). If high range or low range values are exceeded, then the appropriate icon appears next to the values to the left of the bar graph.

- High-High (HH) and Low-Low (LL) thresholds are displayed with a label background that turns red when exceeded.
- High (H) and Low (L) thresholds are displayed with a label background that turns yellow when exceeded.
- Input Source and Quality indicator (See 'SrcQ' in the Output parameters table on [page 17](#) for details).







The following table shows the functions included on the Operator tab.

Table 11 - Operator Tab Description

Function	Action	Security
	Click to lock in Operator mode. Function locks the mode in Operator mode, preventing the program from taking control.	Manual Device Operation (Code B)
	Click to unlock Operator mode. Function unlocks Operator mode, allowing the program to take control.	
	Click to request Program mode.	
	Click to request Operator mode.	
	Click to reset and acknowledge all alarms.	Acknowledge Alarms (Code F)
	Click to select normal input for the PV. This button is visible only in Maintenance mode, and only if Engineering has enabled the substitute PV function.	Equipment Maintenance (Code C)
	Click to select substitute PV instead of normal input. This button is visible only in Maintenance mode, and only if Engineering has enabled the substitute PV function.	
Substitute PV data entry	Enter the substitute PV value. This entry is available only when the substitute PV function is enabled.	
PV Used in simulation data entry (not shown on faceplate image)	Type the simulation PV value. This entry is available only when input simulation is enabled. (See Simulation on page 21 for more information.)	Normal Operation of Devices (Code A)

The following table shows the alarm status symbols used on the Operator tab.

Table 12 - Operator Tab Alarm Status

Graphic Symbol	Alarm Status
	In Alarm (Active Alarm)
	In Alarm and Acknowledged
	Out of Alarm but not Acknowledged
	Alarm Suppressed (by Program)
	Alarm Disabled (by Maintenance)
	Alarm Shelved (by Operator)

Alarm indicators appear on the Operator tab when the corresponding alarm occurs.

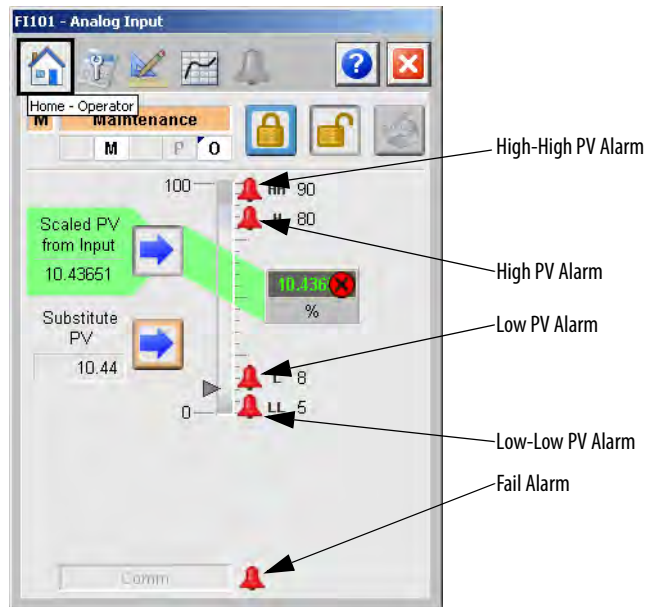

Maintenance Tab

Maintenance personnel use the information and controls on the Maintenance tab to make adjustments to device parameters, troubleshoot and temporarily work around device problems, and disable the device for routine maintenance.

The Maintenance tab shows the following information:

- The current mode (Program, Operator, or Maintenance).
- Requested modes indicator highlights all of the modes that have been requested. The leftmost highlighted mode is the active mode.

Mode Indicator

Requested Modes Indicator

Maintenance Mode Acquire and Release Command Buttons

Threshold Names

Status Thresholds and Deadbands



	Threshold (%)	Deadband (%)
PV Bad (Failure)	103.96	0.42
PV High-High	-2.08	1.00
PV High	1.50E38	1.00
PV Low	1.50E38	1.00
PV Low-Low	-1.50E38	1.00

Bumpless Program/Operator Transition

IMPORTANT Click a threshold name to open the P_Gate faceplate. From the P_Gate faceplate, you can configure and perform additional operations for each alarm, including Gate Delay, Status On-delay, Status Off-delay, and Threshold Name.

The following table shows the functions on the Maintenance tab.

Table 13 - Maintenance Tab Description

Function	Action	Security	Configuration Parameters
	Click to acquire Maintenance mode.	Equipment Maintenance (Code C)	None
	Click to release Maintenance mode.		
Raw Input	Click raw input to open the associated upstream channel object faceplate. 'Enable navigation to the input channel object' must be checked. (See Engineering Tab Page 1 on page 38.)	None	
Threshold	Type the threshold (trip point) for analog input alarms.	Disable Alarms Bypass Permissives and Interlocks (Code H)	<ul style="list-style-type: none"> • Cfg_FailHiLim • Cfg_FailLoLim
Deadband	Type the deadband (hysteresis) that applies to each alarm limit. This is used to prevent a noisy signal from generating numerous spurious alarms. Example: If the High alarm limit is 90.0 and the High alarm deadband is 5, once the signal rises above 90.0 and generates a High alarm, the signal must fall below 85.0 (90.0-5.0) for the alarm to clear.		<ul style="list-style-type: none"> • Cfg_HiHiDB • Cfg_HiDB • Cfg_LoDB • Cfg_LoLoDB • Cfg_FailDB
Threshold Name	Click a threshold name to open the associated P_Gate faceplate.	None	None
Bumpless Program/Operator Transition	Check so that when this parameter is the following: <ul style="list-style-type: none"> • On, the operator settings track the program settings when mode is Program, and program settings track the operator settings when the mode is Operator. Transition between modes is bumpless. • Off, the operator settings and program settings are not modified by this instruction and retain their values regardless of mode. When the mode is changed, the value of a limit can change, such as from the Program-set value to the Operator-set value. 	Equipment Maintenance (Code C)	Cfg_SetTrack

Refer to the Rockwell Automation Library of Process Objects: Condition Gate Delay (P_Gate) Reference Manual, publication [SYSLIB-RM041](#), for more information.

Refer to the Rockwell Automation Library of Process Objects: Analog Input Channel (P_AIChan) Reference Manual, publication [SYSLIB-RM042](#), for more information.

Engineering Tab

The Engineering tab provides access to device configuration parameters and ranges, options for device and I/O setup, displayed text, and faceplate-to-faceplate navigation settings, for initial system commissioning or later system changes.

The Engineering tab is divided into two pages.

Engineering Tab Page 1

On page 1 of the Engineering tab, you can configure the description, label, tag, and PV units for the device.

FI101 - Analog Input

Engineering

Mode Configuration Button (OPM...)

Configure Device Description, Label, and Tag Text

Label: Analog Input
Tag: P_Aln

Raw Input Scaling

	Input	ƒ(x)	Scaled
Maximum	100.00		100.00
Minimum	0.00		0.00

Configure Input and Scaled Ranges

Units: %

Units

- Enable navigation to the input channel object
- Allow selection of Substitute PV
- Clear Program Commands upon receipt

The following table lists the functions on page 1 of the Engineering tab.

Table 14 - Engineering Tab Page 1 Description

Function	Action	Security	Configuration Parameters
	Click to open the Mode Configuration display.	None	See Mode Configuration display on page 40
Description	Type the device description to show on the faceplate title bar.	Engineering Configuration (Code E)	Cfg_Desc
Label	Type the label to show on the graphic symbol.		Cfg_Label
Tag	Type the tag name to show on the faceplate and Tooltip. IMPORTANT: Pausing the mouse over this field displays a tool tip with the configured Logix tag/path.		Cfg_Tag
Input Scaling: Maximum Input	These parameters must be set to the range of the signal connected to the Inp_PV Input. The raw minimum default is 0.0 and the raw maximum default is 100.0. Example: If your input card provides a signal from 4.0...20.0mA, set Cfg_InpRawMin to 4.0 and Cfg_InpRawMax to 20.0. The raw minimum/maximum and engineering units minimum/maximum are used for scaling to engineering units.		<ul style="list-style-type: none"> • Cfg_InpRawMax • Cfg_InpRawMin
Raw Input Scaling: Minimum Input (Raw)			
Input Scaling: Maximum Scaled	These parameters must be set to match the PV range represented by the input signal connected to Inp_PV. The PV engineering units minimum default is 0.0 and the PV engineering units maximum is 100.0. Example: If your input card provides a signal from 4...20 mA that represents -50...250 °C, set Cfg_PVEUMIN to -50.0 and Cfg_PVEU maximum to 250.0. The raw minimum/maximum and PV engineering units minimum/maximum are used for scaling to engineering units.		<ul style="list-style-type: none"> • Cfg_PVEUMax • Cfg_PVEUMin
Input Scaling: Minimum Scaled (EU)			
Units	Type engineering units for display on the HMI. Percent (%) is the default.	Cfg_EU	

Table 14 - Engineering Tab Page 1 Description

Function	Action	Security	Configuration Parameters
Enable navigation to input channel object	Check to enable navigation to an upstream channel object (for example, P_AlChan). IMPORTANT: The name of the Channel object in the controller must be this object's name with the suffix '_Chan'. For example, if your P_Aln object has the name 'Aln123', then its Channel object must be named 'Aln123_Chan'.	Engineering Configuration (Code E)	Cfg_HasChanObj
Allow Selection of Substitute PV	Check to allow the Substitute PV Maintenance function. Clear this checkbox to disallow the Substitute PV Maintenance function (default).		Cfg_NoSubstPV
Clear Program Commands on Receipt	Check to clear Program commands on receipt.		Cfg_PCmdClear

TIP The P_Aln instruction supports reverse scaling; either the raw (Input) or engineering (Scaled) range can be reversed (maximum less than minimum).

Mode Configuration Display

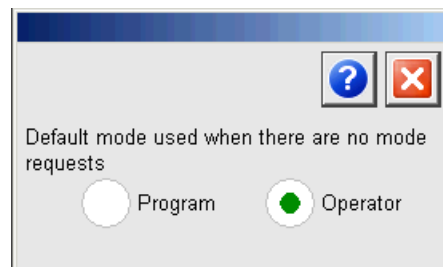

This display lets you select the default mode for the object by selecting the appropriate mode.

IMPORTANT If no mode is being requested, changing the default mode changes the mode of the instruction.

You must have FactoryTalk View security code E to select the default mode on this display.

Engineering Tab Page 2

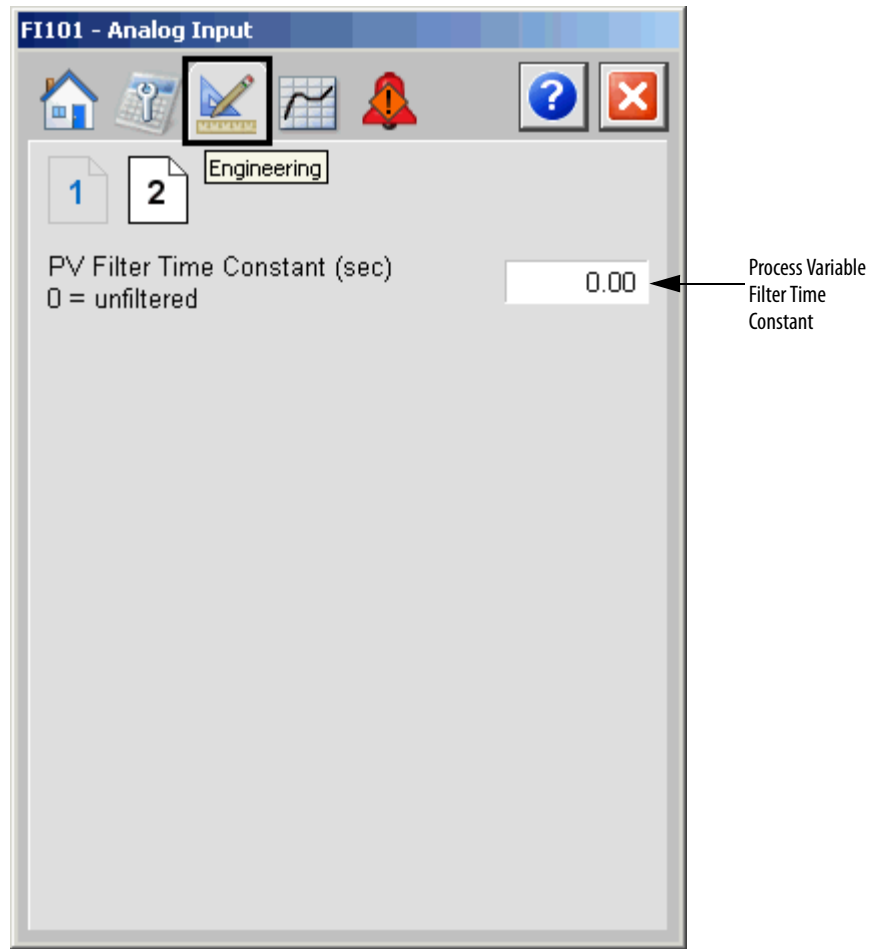

The following table lists the functions on page 2 of the Engineering tab.

Table 15 - Engineering Tab Page 2 Description

Function	Action	Security	Configuration Parameters
PV Filter Time (seconds) 0 = unfiltered	Type the PV filter time constant. If the time constant is 0, the PV is unfiltered.	Engineering Configuration (Code E)	Cfg_FiltTC

Trends Tab

The Trends tab shows trend charts of key device data over time. These faceplate trends provide a quick view of current device performance to supplement, but not replace, dedicated historical or live trend displays.

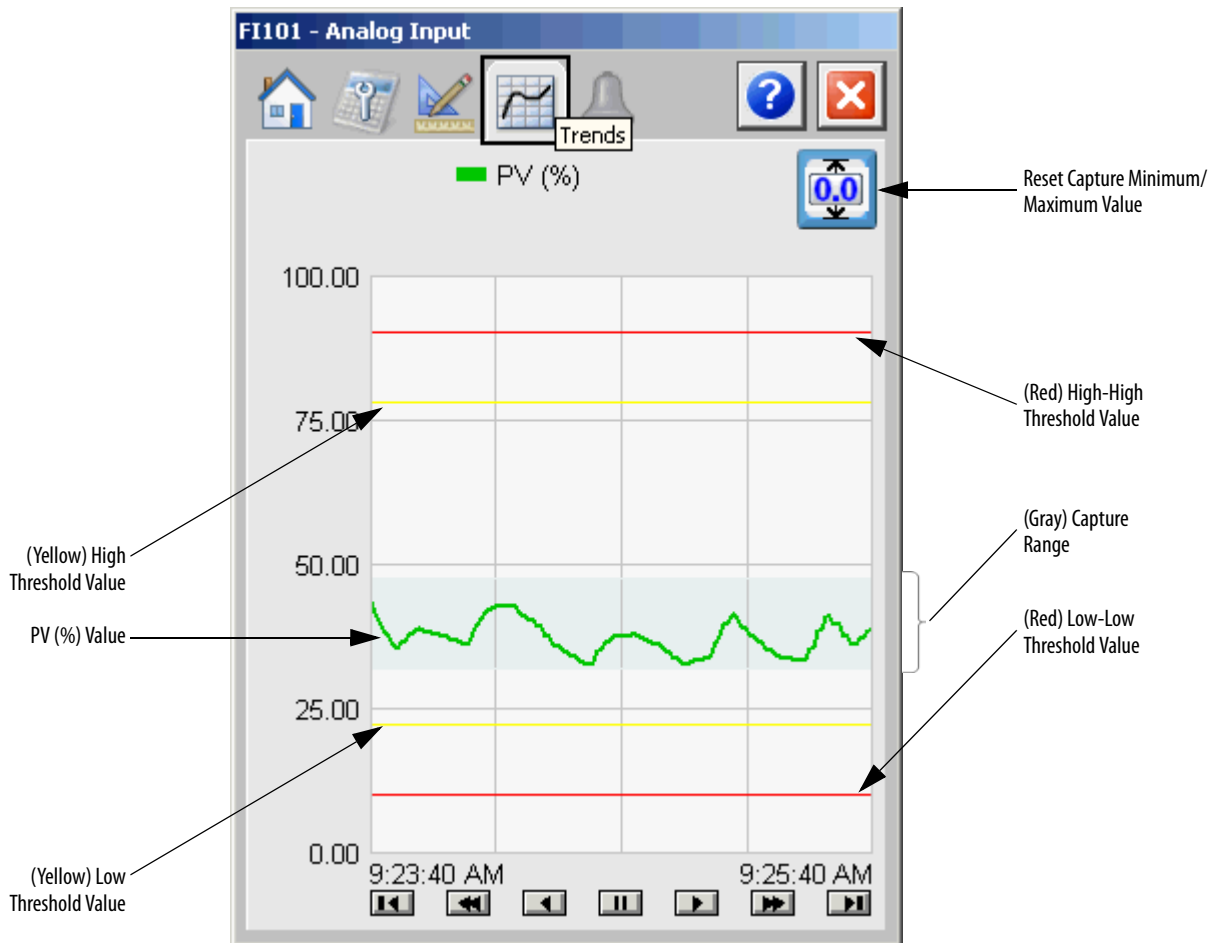

The following table lists the functions on the Trends tab.

Button	Action	Security Required
	Reset capture minimum/maximum values	Normal Operation of Devices (Code A)

Alarms Tab

The Alarms tab displays each configured alarm for the P_AIn instruction. The icon on the tab for the alarms page changes color based on the current active alarms. A blinking alarm icon indicates that one or more alarms must be acknowledged or the device must be reset.

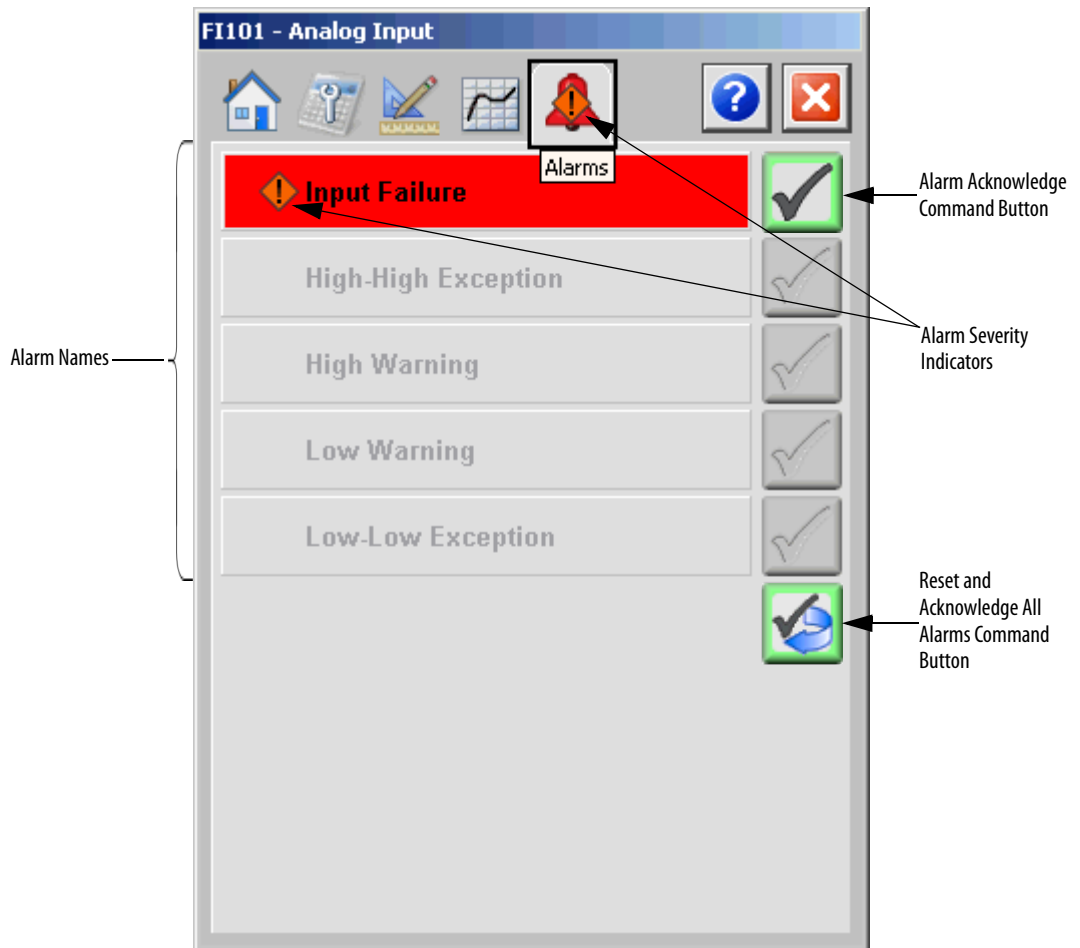

Click an alarm name to open the P_Alarm faceplate for that alarm. From the P_Alarm faceplate, you can configure and perform additional operations on the alarm.



If an alarm is active, the panel behind the alarm changes color to match the severity of the alarm. The color of the bell icon at the top of the faceplate shows the severity of the highest active alarm, and the icon blinks if any alarm is unacknowledged or requires reset.

Table 16 - Alarm Severity Colors

Color	Definition
Magenta	Urgent
Red	High
Yellow	Medium
Blue	Low
White (bell icon)	Alarm has cleared but is unacknowledged
Background (Light Gray)	No alarm

The following table shows the functions on the Alarms tab.

Table 17 - Alarms Tab Description

Function	Action	Security
Alarm Name	Click an alarm name to open the associated P_Alarm faceplate.	None
	Click to acknowledge the alarm.	Acknowledge Alarms (Code F)
	Click to reset and acknowledge all alarms.	

When the Reset and Acknowledge All Alarms button is enabled, the panel behind the alarm blinks, indicating the alarm requires acknowledgement or reset. The Alarm Acknowledge button is enabled if the alarm requires acknowledgment. Click the button with the check mark to acknowledge the alarm.

See Rockwell Automation Library of Process Objects: Common Alarm Block (P_Alarm) Reference Manual, publication [SYSLIB-RM002](#), for more information.

Basic Analog Input Faceplate Help

The Faceplate Help is divided into two pages.

Faceplate Help Page 1

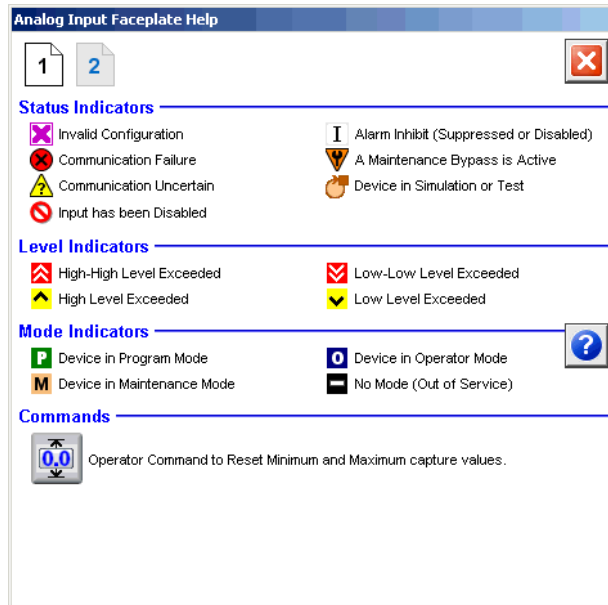

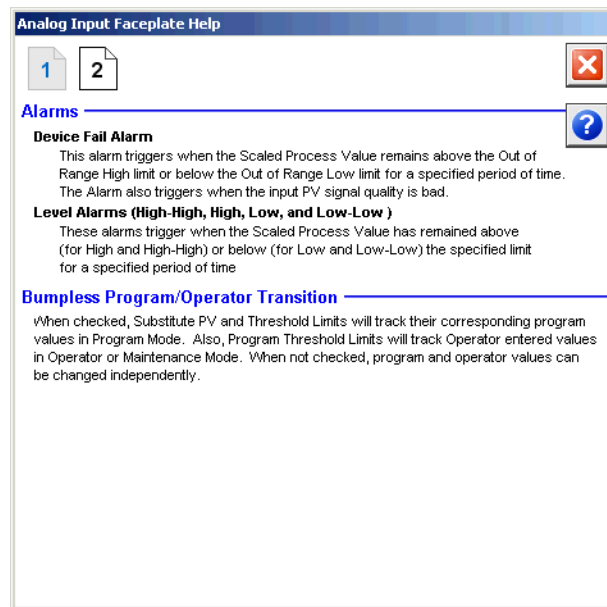
Faceplate Help Page 2

Analog Input Faceplate Help

1 2

Alarms

Device Fail Alarm
This alarm triggers when the Scaled Process Value remains above the Out of Range High limit or below the Out of Range Low limit for a specified period of time. The Alarm also triggers when the input PV signal quality is bad.

Level Alarms (High-High, High, Low, and Low-Low)
These alarms trigger when the Scaled Process Value has remained above (for High and High-High) or below (for Low and Low-Low) the specified limit for a specified period of time.

Bumpless Program/Operator Transition
When checked, Substitute PV and Threshold Limits will track their corresponding program values in Program Mode. Also, Program Threshold Limits will track Operator entered values in Operator or Maintenance Mode. When not checked, program and operator values can be changed independently.

Notes:

Rockwell Automation Support

Rockwell Automation provides technical information on the Web to assist you in using its products.

At <http://www.rockwellautomation.com/support> you can find technical and application notes, sample code, and links to software service packs. You can also visit our Support Center at <https://rockwellautomation.custhelp.com/> for software updates, support chats and forums, technical information, FAQs, and to sign up for product notification updates.

In addition, we offer multiple support programs for installation, configuration, and troubleshooting. For more information, contact your local distributor or Rockwell Automation representative, or visit <http://www.rockwellautomation.com/services/online-phone>.

Installation Assistance

If you experience a problem within the first 24 hours of installation, review the information that is contained in this manual. You can contact Customer Support for initial help in getting your product up and running.

United States or Canada	1.440.646.3434
Outside United States or Canada	Use the Worldwide Locator at http://www.rockwellautomation.com/rockwellautomation/support/overview.page , or contact your local Rockwell Automation representative.

New Product Satisfaction Return

Rockwell Automation tests all of its products to help ensure that they are fully operational when shipped from the manufacturing facility. However, if your product is not functioning and needs to be returned, follow these procedures.

United States	Contact your distributor. You must provide a Customer Support case number (call the phone number above to obtain one) to your distributor to complete the return process.
Outside United States	Please contact your local Rockwell Automation representative for the return procedure.

Documentation Feedback

Your comments will help us serve your documentation needs better. If you have any suggestions on how to improve this document, complete this form, publication [RA-DU002](#), available at <http://www.rockwellautomation.com/literature/>.

Rockwell Automation maintains current product environmental information on its website at <http://www.rockwellautomation.com/rockwellautomation/about-us/sustainability-ethics/product-environmental-compliance.page>.

Rockwell Otomasyon Ticaret A.Ş., Kar Plaza İş Merkezi E Blok Kat:6 34752 İçerenköy, İstanbul, Tel: +90 (216) 5698400

www.rockwellautomation.com

Power, Control and Information Solutions Headquarters

Americas: Rockwell Automation, 1201 South Second Street, Milwaukee, WI 53204-2496 USA, Tel: (1) 414.382.2000, Fax: (1) 414.382.4444
Europe/Middle East/Africa: Rockwell Automation NV, Pegasus Park, De Kleetlaan 12a, 1831 Diegem, Belgium, Tel: (32) 2 663 0600, Fax: (32) 2 663 0640
Asia Pacific: Rockwell Automation, Level 14, Core F, Cyberport 3, 100 Cyberport Road, Hong Kong, Tel: (852) 2887 4788, Fax: (852) 2508 1846

Publication SYSLIB-RM001F-EN-E - January 2016

Supersedes Publication SYSLIB-RM001E-EN-E - August 2014

Copyright © 2016 Rockwell Automation, Inc. All rights reserved. Printed in the U.S.A.