

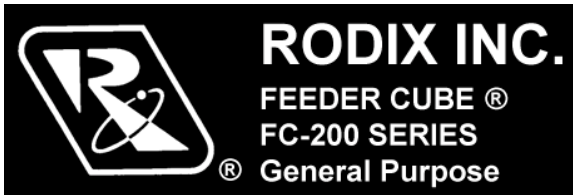

# **RODIX INCORPORATED**

2316 23<sup>rd</sup> Ave., ROCKFORD IL 61104  
TOLL FREE (800) 562-1868, FAX (815) 316-4701  
E-mail [custserve@rodix.com](mailto:custserve@rodix.com)  
[www.rodix.com](http://www.rodix.com)

**FEEDER CUBE®**  
**FC-200-3 PARTS SENSING**  
**GENERAL PURPOSE MODEL**  
**IMPORTANT: APPLICATION NOTE**



## ADJUSTMENTS & SET UP UNITS A, B & C

### ELECTRICAL CONNECTIONS:

Make the electrical connections prior to plugging the control in and turning it on. Once connections are made to the feeder control, any desired software settings changes can be made with the cover closed.

#### 1. PART SENSOR

(Photo-sensor or Proximity Switch)

Connect a three wire, current-sinking (NPN) or current-sourcing (PNP) sensor as shown on the enclosed wiring diagram. The sensor must be able to operate on 12VDC and switch 3mA. The default setting is a universal sensor input.

#### 2. RUN JUMPER INPUT

A Run Jumper is factory installed as shown on the enclosed wiring diagram.

If the Feeder Cube® is to be controlled by a relay contact, switch or other device, replace the factory-installed jumper with the controlling "Run Contact" at terminals 8 and 9 of TB2 (small terminal strip). The contact must be able to switch 12VDC and 1.0 mA. The control will then run only when the contact is closed and the part sensor is calling for parts.

In the High/Low parts sensing mode, a second parts sensor can be connected to the run contact input in place of the run jumper. The parts sensor should be a PNP type and have the same logic (L.O. or D.O.).

#### 3. AUXILLERY OUTPUT

The Feeder Bowl/Hopper Interlock feature (TB2-2 & 3) can be connected to a Rodix FC-40, FC-90 or FC-200 Series control when control of a bulk material hopper is needed. The interlock will prevent the hopper from operating anytime the bowl is turned OFF or in "STAND BY" mode. The Interlock output is capable of 12 VDC at 50 mA. The Aux output is capable of switching 100 mA at 12 or 24VDC if an external power supply is used. For further information download (or request from RODIX) the FC-200 Series Advanced Features Application Note. The Interlock output can be used to drive a solid state relay that can operate auxiliary equipment such as an air valve. Two FC-200

Series controls can be interlocked. Download the FC-200-2 Application Note for wiring information.

A 0.6 Watt 12VDC solenoid can be driven by the Aux output. Note: a diode must be placed across the solenoid in reverse polarity to adsorb the energy when the solenoid is de-energized. Failure to do so voids the warranty. See the wiring diagram for proper connections.

#### 4. LINE VOLTAGE CONNECTIONS

The 120VAC models can operate from a power line providing from 108 to 132VAC. The plug can be connected to a standard North American outlet. The outlet should be properly grounded. The 240VAC models can operate from 200 to 265VAC. The control should be grounded properly.

#### 5. INTERNAL POWER SUPPLY

At the rated line voltage, the line isolated power supply is capable of providing a combined total current of 65 mA at 12 VDC (35 mA when using a 200VAC line on 240VAC models). The total current includes the parts sensor, CFR sensor and any auxiliary output accessories that are connected to the Bowl/Hopper Interlock terminals.

#### 6. OUTPUT CONNECTIONS

The 120VAC models in a general purpose enclosure provide a standard North American outlet for connection to the feeder.

#### 7. EXTERNAL SPEED CONTROL CONNECTIONS

The following methods of remote power level control can be utilized when desired:

- A. The Constant Feed Rate (CFR) feature: Attach a CFR sensor to terminals TB2-12 (blue) and to TB2-9 (brown).
  - B. 4-20mA or 0-20mA signal can be connected by bringing the positive signal wire to TB2-12 and ground to TB2-11.
  - C. 0-5VDC Analog input signal can be connected to connector H1. This can be selected to ignore any connections to the CFR/4-20mA input. Control cable 123-145 sold separately.
- Section 13 explains how to enable these features.



**Model - FC-200-3  
P/N 121-000-2002**



**Listed, File No. E183233**

**Input: 120 VAC, 50/60 HZ.**

**Triple Unit Fuse Sizes:**

**Main 15 Amps Maximum**

**Unit A = 10 AMPS**

**Unit B = 15 AMPS**

**Unit C = 5 AMPS**

**Output: 0-120 VAC**

**80% Duty Cycle at Rated AMPS**

© 2009 RODIX INC.

## **CONTROL ADJUSTMENTS:**

**DISPLAY MESSAGES:** The normal operating display shows the status of the control with regard to input signals and control settings. See the "Menu Layout" page for message details.

**SOFTWARE ADJUSTMENTS:** Once the electrical connections have been made, the control settings can be adjusted as desired through the control's menu.

**NAVIGATING THE CONTROL MENU:** The control uses four programming keys to program the control. The fifth key, "1/0" is for on/off operation.

- A. The **ENTER** key allows entry to the menu and access to adjust each setting. Pushing the enter key once allows entry to program or the security code if the security feature has been enabled. Once inside the menu, the enter key selects a menu item or a parameter to adjust.
- B. The **BACK** key moves the current menu location up one level higher than it was before. It is also used to get back to the normal operating display.
- C. The **Arrow Down** key allows the user to step down through the program menu or to decrease a setting.
- D. The **Arrow Up** key allows the user to step up through the program menu or to increase a setting.
- E. The **1/0** key allows the user to temporarily stop or restart the control's operation.

See the "Menu Layout" page for the menu structure. When in the menu mode and no keys are pressed for 1 minute, the display reverts to the normal operating display.

### **8. PARTS SENSOR SET UP**

The "Function Settings" menu controls the parts sensor operation.

- A. The "NORMAL" setting works with most NPN and PNP sensors. If the sensor input does not seem to switch, set the sensor type to NPN or PNP to match the sensor type. The sensor input switching can be monitored on the LCD; S=0 or 1.
- B. The control comes preset to work with inverted sensor logic. Set control for the type of sensor logic being used: "Normal" for through beam optics or "Inverted" for proximity or retro-reflective optics.

### **9. RUN MODE SETTINGS**

The "Function Settings" menu controls the feed logic.

- A. The control comes preset for normal on/off sensor operation.
- B. The "Constant On" feature can be used to keep the bowl running while the Aux output switches a device (air valve) to blow the unneeded parts back into the

bowl.

- C. The "2-Speed" feature allows the bowl to slowly trickle parts on low speed and to feed parts at full speed when parts are needed. The RUN input requires a PNP sensor.
- D. The "high/low" function keeps the parts level between the high and low parts sensors on the track. The second sensor (PNP) gets installed in place of the run jumper.
- E. The control comes preset to disable the "empty bowl timer." The timer may be enabled so the bowl will stop feeding when the parts sensor has seen no parts. The timer is adjustable from 5 to 240 seconds. The time adjustment for the empty bowl timer can be adjusted under the "Timer Settings" menu. The auxiliary output can be set up to turn on a signaling device. See the section that describes the auxiliary output for more details.

### **10. AUXILIARY OUTPUT SET UP**

The "Function Settings" menu controls the auxiliary output (Aux Out) operation.

- A. The control comes preset for the auxiliary output to turn on and off with the output of the feeder.
- B. The auxiliary output signal can be inverted from the output of the feeder. Set the "Aux Out" parameter to "Invert" to activate it.
- C. The auxiliary output signal can be set as an alarm to indicate when the bowl out-of-parts timer has stopped the feeding of the bowl. Set the "Aux Out" parameter to "Alarm" to activate it.
- D. The auxiliary output signal can be set to invert the alarm when the bowl out-of-parts timer has stopped the feeding of the bowl. Set the Aux Out parameter to "Inv Al" to activate it.
- E. The auxiliary output signal can be set so that a customer supplied air solenoid is activated 1 second before feeding begins and continue for 4 seconds after feeding ends. This feature is helpful for parts orientation. Set the "Aux Out" parameter to "Air Jet" to activate this feature.

### **11. PULSE MODE OPERATION**

The "Power Settings" menu controls the pulse mode settings. The pulse mode can be set for 120, 60, 60-reverse, 40 or 30 pulses. The correct pulse setting depends on what the feeder was tuned to operate at.

- A. The control comes preset at 120 pulses per second.
- B. 60 pulses per second can be selected from the pulse settings menu.
- C. 60 reverse indicates the current flows in the opposite direction through the feeder coil(s). This

can be helpful for two different applications. When a changing the amplitude on one feeder changes the amplitude of the other feeder, reversing the 60 pulse output sometimes can solve a mechanical interaction between two feeders on the same machine table. Secondly, the apparent power from the utility can be reduced if the power can be balanced when some feeders are set to 60 pulse and some are set to 60 reverse pulse. To activate it, set the pulse mode to "60 Rev."

- D. 40 or 30 Pulse can be selected in the pulse mode menu. For useful vibration, the feeder has to have the proper amount of springs.

### **12. SOFT-START**

The start-up of the control output can be adjusted to ramp up to the desired output level instead of starting abruptly. Soft-start keeps parts from falling off the tooling, reduces spring shock and hammering when the control turns ON. The soft start setting can be found under "Power" menu. The soft start can be set from 0.0 to 10.0 seconds.

### **13. EXTERNAL SPEED CONTROL**

The feeder control's power level can be controlled by an external signal from a PLC or other source. Selections are made under the "Power Settings" menu. See section 7 for connection details.

- A. The Constant Feed Rate (CFR) feature comes preset in the control. Attach a CFR sensor to terminals TB2-12 (blue) and to TB2-9 (brown). Turn the power switch on, and the control should display "CFR" in the status line showing that it is connected. Set the power setting to the desired feed rate. The control uses information from the CFR sensor to maintain a consistent level of vibration.
- B. A 4-20mA or 0-20mA signal from a PLC can be used to remotely vary the output of the control instead of the keypad. The "Ext Sig" setting must be set to enable it. After the feature is selected, it will automatically turn ON whenever a signal is applied to the control (terminals 11 & 12 of TB2). At 0mA the keypad may be used. The 0-20/4-20mA input is transformer isolated from the power line.
- C. 0-5VDC Analog input signal may be applied to control the feeder amplitude.

## **14. LINE VOLTAGE COMPENSATION**

Fluctuations in the line voltage can cause a feeder bowl to vary its feed rate. The line voltage compensation feature adjusts the control's output to help compensate for fluctuations in the supply voltage. If it becomes necessary to disable this feature, the LV Comp setting can be changed to "Disable". It is found under "Power Settings" menu.

## **15. LIMITING THE MAXIMUM OUTPUT OF CONTROL**

The maximum power (Max Pwr) setting can be lowered to keep the operators from setting a higher than desired feeder vibration. The maximum power setting can be found under the "Power Settings" menu. It can be adjusted from 100.0% down to 40.0%.

## **16. POWER SETTING**

The output power is controlled by the UP and DOWN arrow keys. The power setting can be adjusted unless the security feature lock has been selected. Once the proper security code has been entered, the power may be adjusted under the "Power Settings" menu. Note: the power setting may not be adjusted above the maximum power setting or below the minimum power setting level. The max and min power settings automatically change the power setting to keep it in the correct range.

## **17. SETTING THE MINIMUM OUTPUT OF CONTROL**

The minimum power (Min Pwr) output level can be adjusted to the desired low level of vibration. The minimum power setting can be found under the "Power" menu. It can be adjusted up from 0.0% to 60.0%. Note: the software does not allow the minimum level to be within 6.4 counts of the maximum level.

## **18. SETTING THE TIME DELAYS**

The ON and OFF sensor time delays are set independently for a period of 0-25 seconds. The time delay settings can be adjusted to provide the best individual response for the feeder. The time delays can be found under the "Timer Settings" menu.

## **19. DIAGNOSTICS**

- A. The first menu item under the "Diagnose Info" menu shows the software revision level.
- B. The next item under the software revision level shows certain software registers that may be helpful to Rodix staff while troubleshooting over the phone.

## **20. SECURITY SETTINGS**

The "Security Settings" menu controls access to the control settings. When enabled, a security code number may be chosen from 00 to 255. The preset code is 00.

- A. The "Unlock" setting allows menu access for all control adjustments and features.
  - B. The amplitude only (Amp Adj) adjustment allows operators to adjust the amplitude through the normal operating display. All other settings can only be adjusted after entering the security code.
  - C. The "Lock" setting locks the control from any adjustment without the use of the security code.
- If the security code has been forgotten, press the enter key to bring up the security code. Next, push and hold the back key until the menu appears. This sequence bypasses the security code.

## **21. DEFAULT MEMORY**

Occasionally it is helpful to get back to a known setting. Once a feed system has been set up properly, it can be saved into the "user default" memory. If an operator makes wrong adjustments, the "Restore User" feature can restore the control to a known good set up. The restore factory defaults selection will put the original factory settings into memory.

## **22. LANGUAGE**

The programming menus can be displayed in English, French, German (Deutz), and Spanish (Espanol).

## **23. INSTALLING THE CFR SENSOR**

Note: Failure to adequately prepare the feeder's surface properly may result in a Constant Feed Rate (CFR) sensor that will not bond to the feeder. The sensor will not be mounted until step C-6.

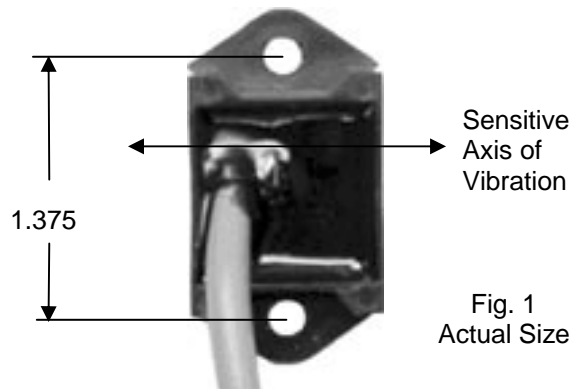

Fig. 1  
Actual Size

**A. ORIENT THE SENSOR** so that its sensitive axis is in the same direction as the vibration of the feeder. The double-ended arrow in figure 1 shows the sensor's sensitive axis. Align the sensitive axis of the sensor in the same direction as the vibration (see figure 2). The sensor must be oriented correctly for proper operation.

**B. CHOOSE A LOCATION** for mounting the sensor on the feeder that is smooth and that will allow the adhesive on the sensor to bond. Avoid mounting the sensor over ridges and bumps which can reduce the ability of the adhesive to stick to the feeder. The correct location will also have enough space for the sensor's cable to hang straight down without touching anything else.

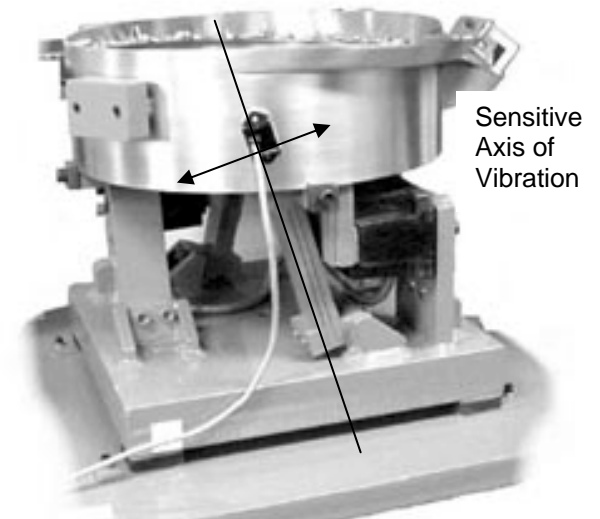

Fig. 2 The arrow shows the direction of vibration which is at a right angle to the spring pack.

**C. SURFACE PREPARATION** of the feeder is crucial for proper bonding between the sensor and the feeder. Please follow these steps completely.

- 1) The feeder should be kept between 70°-100°F (21-38°C) for ideal tape application.
- 2) Clean a 3.5" (10cm) circular area with a solvent like isopropyl alcohol that will not leave a residue. As a rule of thumb, the area can be considered clean when after cleaning the area with a solvent-saturated, white paper-towel, the towel is as clean as it was before wiping.

- 3) Using a good amount of pressure, polish the cleaned, circular area of the feeder using a scratch pad or steel wool. Repeat step 2, and then go to step 4.
- 4) Wipe the cleaned surface with an alcohol wipe or with a 50/50 isopropyl alcohol/water combination.
- 5) Dry the surface thoroughly using a low lint cloth or a clean paper towel.
- 6) Remove the vibration sensor from its protective packaging. Remove the liner from the adhesive backing. Avoid touching the tape. Align the sensor as shown in figures 1 and 2. Apply the vibration sensor to the prepared area of the feeder. Press the sensor very firmly onto the feeder surface for at least 10 seconds.
- 7) Allow the vibration sensor at least 20 minutes to cure before operation. Note it takes 72 hours for the adhesive to fully cure at 70°F (21°C).

Alternatively, #8 or M4 screws can be used to mount the sensor to the feeder. The hole centers are 1.375" (3.49cm) apart.

**D. ROUTE THE SENSOR CABLE** to protect it from strain due to vibration. The cable that attaches to the sensor will not break from normal vibration; however, some care should be used when routing the sensor cable from the sensor to the control. The cable should hang straight down from the sensor without touching the feeder bowl or anything else. Then, the sensor cable should curve towards the power control with a bend radius larger than 3" (8cm).

Use a cable tie and an adhesive-backed mount to attach the sensor cable to the side of the drive base. See Figure 2. Clean the mounting area before applying the adhesive-backed mount.

**E. CONNECT THE SENSOR** to the control. The sensor's brown wire connects to +12VDC at TB2-9. The blue wire connects to the signal input at TB2-12.

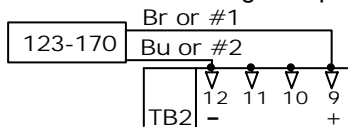

F. Section 13 explains how to enable the CFR feature.

## **WARNING:**

**Fuses should be replaced with Bussman ABC or Littelfuse 3AB "Fast Acting" type or equivalent of manufacturer's original value.**

**Mounting this control on a vibrating surface will void the warranty.**

## **WARRANTY**

**Rodix Control Products are Warranted to be free from defects in material and workmanship under normal use for a period of two years from date of shipment.** For the full description of the warranty, terms, and software license, please contact the factory.

For assistance installing or operating your Rodix Feeder Cube® please call the factory or visit our web site. Technical help is available to answer your questions and fax any needed information. To return a control for IN or OUT of warranty service, please ship it prepaid to:

**Rodix Inc., ATTN: Repair Department**

If under warranty, Rodix will repair or replace your control at no charge; If out of warranty, we will repair it and you will be billed for the repair charges (Time and Material) plus the return freight. Quotes for repairs are available upon request. A brief note describing the symptoms helps our technicians address the issue.

Feeder Cube® is a registered TM of Rodix Inc.

Banner® is a registered Trademark of Banner Engineering Corp, 9714 10th Ave, Minneapolis, MN 55441

## **DIMENSIONS**

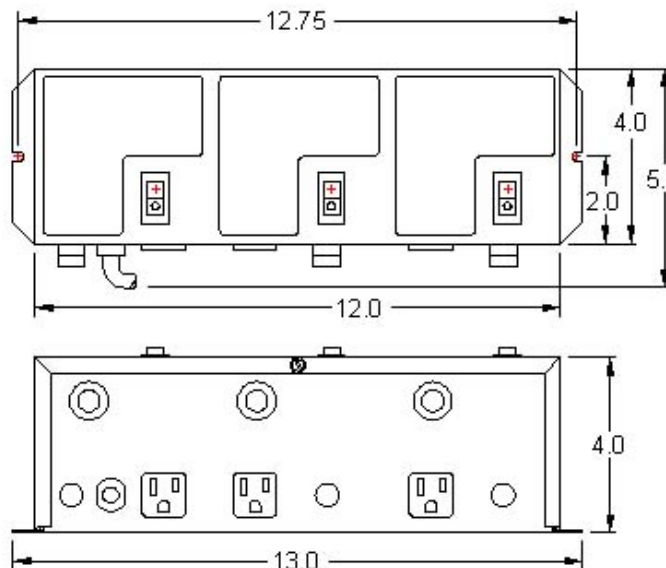

## **Rodix Inc.**

2316 23<sup>rd</sup> Ave., Rockford, IL 61104  
Toll free 800-562-1868, fax 815-316-4701  
custserve@rodix.com

**www.rodix.com**

FC-200-3.doc 10/22/2009 Page 4

**RUN JUMPER INPUT**

**A) LOW CURRENT SWITCH**

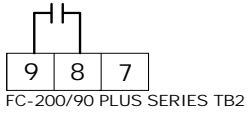

**B) FEEDER BOWL/HOPPER INTERLOCK**

FC-200/90 PLUS SERIES TB2, OUTPUT

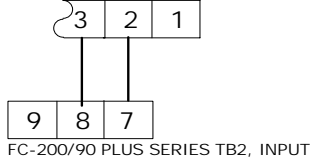

**C) LOW VOLTAGE INPUT SWITCHING**

(DC Voltage from PLC)

5-30 VDC INPUT VOLTAGE OFF/ON CONTROL

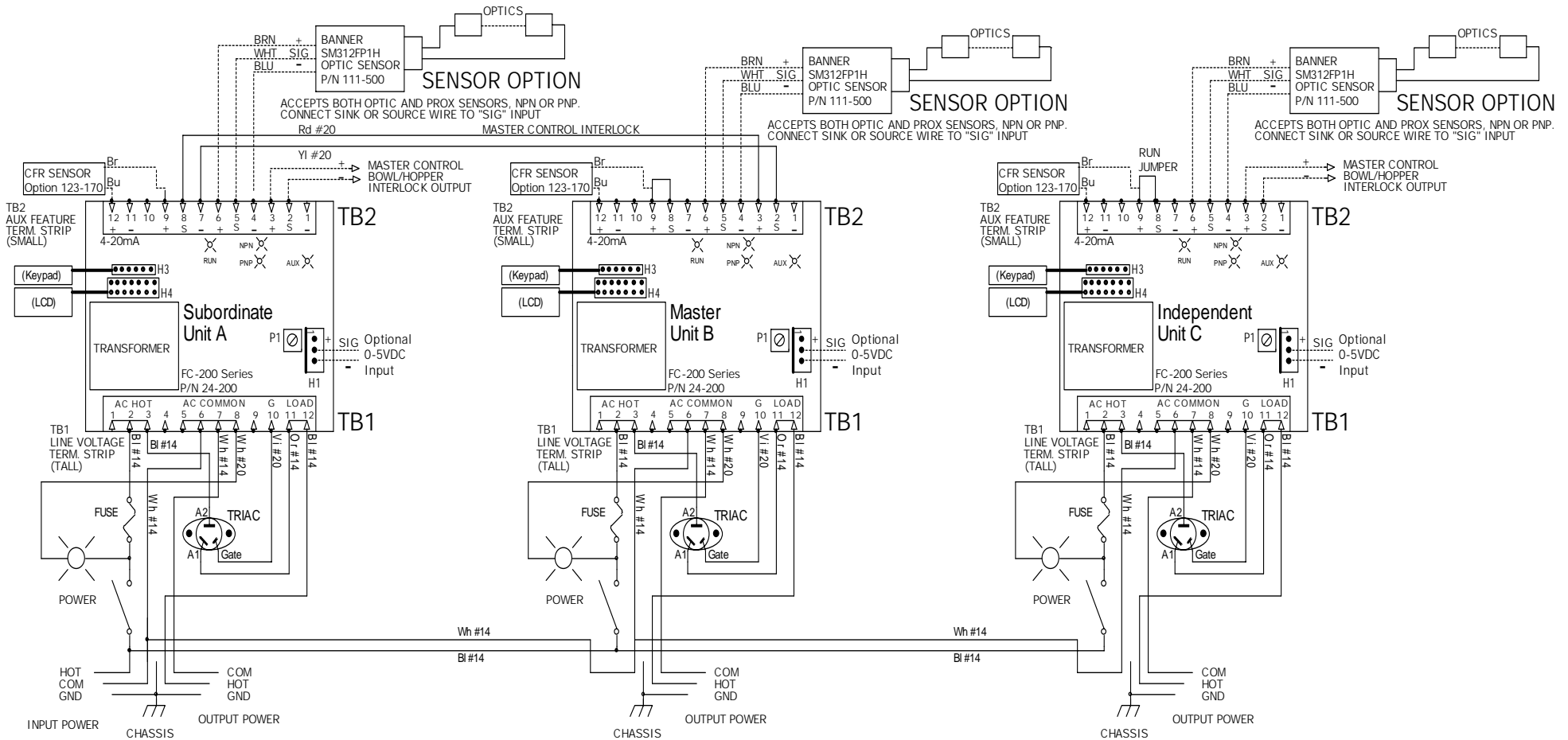
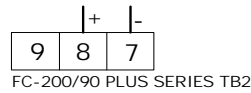

MODEL	INPUT VAC	AMPS	OUTPUT	MAIN
FC-200-3	120 VAC	10/15/5	0-120	15A

**RODIX, INC.**  
 2316 23<sup>rd</sup> Ave., Rockford, IL 61104  
 Toll Free (800) 562-1868, FAX (815) 316-4701  
 Email [custserve@rodix.com](mailto:custserve@rodix.com)  
[www.rodix.com](http://www.rodix.com)

# FC-200 Series Menu Layout

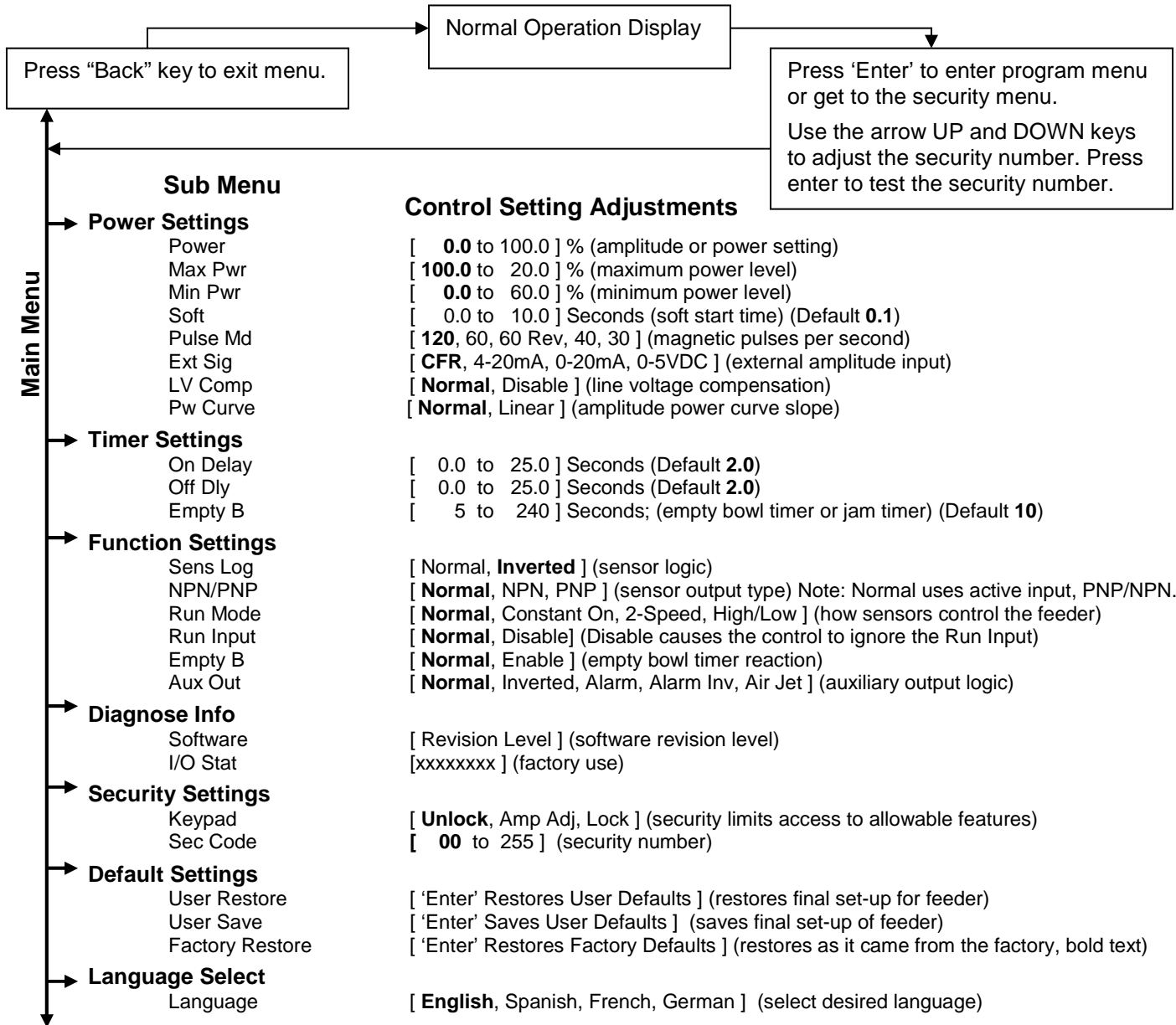

## Normal Display Message Priority

The normal operating display shows the status of the control with regard to input signals and control settings. They are listed from highest to lowest in priority. The highest priority message takes precedence over all other messages.

- OFF** The 1/0 button has been pushed to disable control operation.
- Stop** The run jumper has not been not made.
- Full** The parts sensor logic is telling the control to stay off.
- Empt** Empty bowl timer has timed out because parts did not pass by the parts sensor for a certain time.
- Ext.** An external signal is in control of the speed input.
- Low** Low Speed used when 2 speed has been selected and the sensor is not made.
- 0Spd** The output is off because the output is set to 0.0%.
- CFR** The CFR function is operating, and the feeder is running normally.
- Run** The feeder is running normally.

## Sensor Status Messages

- S=1** The parts sensor indicates parts are needed.
- S=0** The parts sensor indicates parts are not needed.
- =** The Flashing equal sign indicates the parts sensor is timing prior to changing the output state.

## Power Setting Messages

- Mn** Mn indicates the power setting is at the minimum amplitude.
- Mx** Mx indicates the power setting is at the maximum amplitude.

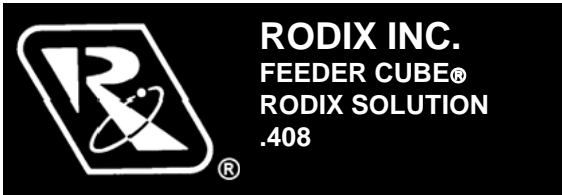

## RODIX SOLUTION

### Good wiring practices for avoiding electrical noise problems.

Rodix controls have been designed with a high degree of immunity to electrical noise; however, depending on the control installation, electrical noise can cause problems. These problems occur in less than 1% of the product installations. Most electrical noise problems can be avoided by following some simple guidelines. Good wiring practices need to be used to prevent electrical noise from interfering with your control's operation. Another name for electrical noise is Electro-Magnetic Interference (EMI).

#### Symptoms of Electrical Noise

The symptoms of electrical noise would appear as follows: a brief pause or a brief "bump" in the vibratory feeder's output that the control automatically recovers from. In rare cases the control will either stop operating or run continuously at full power in 120 pulse mode until the power switch is slowly cycled OFF and ON.

#### Sources of Electrical Noise

Electrical noise is generated by devices like relay coils, solenoid valves, contactors, servo motors, and variable

frequency inverter drives. The electrical noise is then transferred to another device by one of three ways. The noise could be conducted through the power wires, or capacitively coupled from wire to adjacent wire, or it is transmitted from the wires of a noise source.

#### Solutions for Electrical Noise

1. Use shielded wires for all I/O (Input / Output) signals. The I/O signals may include: 4-20mA input, Run input, Sensor input, 0-5VDC input, Interlock input or AUX output. The shield "drain" wire should be tied to the chassis in the Rodix control. The drain wire should be kept shorter than 2". Please see the enclosed picture.

#### Example of a "drain" wire termination

2. Never run I/O signal wires in the same conduit or raceway as AC power lines such as wires to motors, solenoids, heaters, welders and Rodix controls, etc.

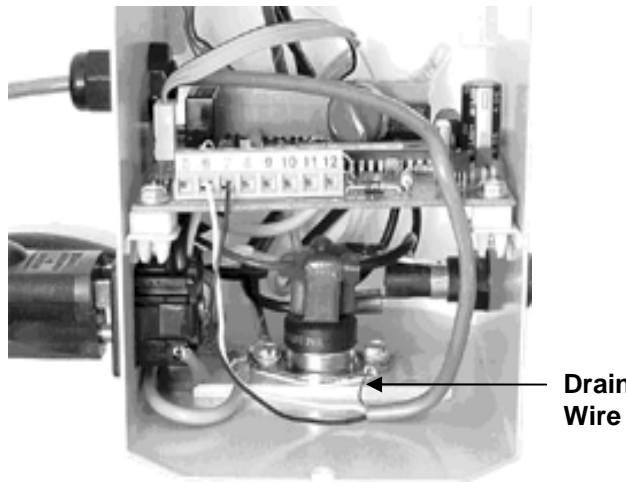

3. I/O wires within an enclosure should be routed as far away as possible from relays, solenoids, transformers, power wiring and other noisy equipment. Keep the I/O signal wires separate from the control's input and output power wiring. Secure the wires in place.

4. Whenever relays or solenoid valves are used, install a Snubber on them to reduce electrical noise. Use a diode on a DC coil. Use a RC Snubber on an AC coil.

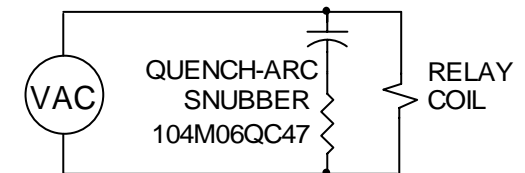
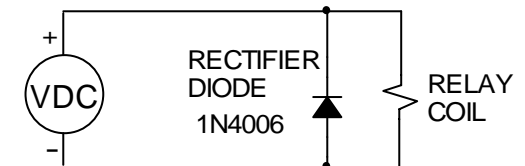

5. In extremely high EMI environments, Power Line Filters and ferrite beads can be effective. Install ferrite beads on I/O signal wires as close as possible to the circuit board terminal strip. Loop the wire through the bead several times or use several beads on each wire for additional protection.

### RODIX, INC.

2316 23<sup>rd</sup> Avenue, Rockford, IL 61104  
 Toll Free (800) 562-1868, FAX (815) 316-4701  
 E-mail [custserve@rodix.com](mailto:custserve@rodix.com)  
[www.rodix.com](http://www.rodix.com)