



# ROTAREX Group

Since 1922



## HISTORY



### From the production of carbon dioxide to the manufacturing of valves

- 1922 : Fondation of CEODEUX S.A. in Lintgen by August Theodore SCHMITZ for the manufacturing of Carbon Dioxide for the Luxembourgian market.
- 1930 - 1950 : First developments and fabrication of valves for industrial gases and fire suppression.
- 1947 : Edgard Schmitz takes over the management of CEODEUX S.A.
- 1950 - 1970 : Development of the first valves for cylinders and carburation valves for Butane-Propane.
- 1970 - 1980 : Jean-Claude Schmitz enters the management of the company and starts an ambitious expansion plan. Creation of a specialized R&D department. Sales start on a European level.
- 1980 - 1990 : ROTAREX goes global. Creation of ROTAREX S.A., regrouping all the companies of the group including the historic Ceodeux. Business units are created in order to better serve the customers needs. Expansion of the sales network throughout Europe and opening of the first office in the USA, Pittsburgh PA.
- 1990 - 2000 : Futher increase of the R&D and production capabilities on a global scale Establishment of numerous sales offices throughout the world: Tokyo, Singapore, Seoul, Moscow, Sao Paulo
- 2000 - till today : Creation of ROTAREX Automotive. Rotarex enters the Hydrogen age with numerous Industrial and Automotive partners. Opening of a manufacturing plant and office in Shanghai China. Opening of a logostics center in Campinas Brasil. Establishment of a distributors network on a global scale.

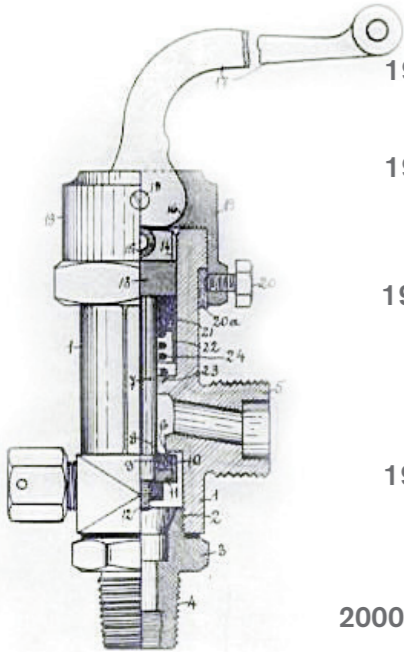

### Rotarex,

With over 85 years of experience, we can proudly say that we are able to offer products with the quality, innovation and service that our customers all over the world are looking for.

Our strength is our integrated production process as well as a state of the art R&D center combined with our global presence where we fulfill our customer need.

We engineer "made to order" products and provide our customers with ever more innovative and qualitative solutions.

I would like to take this opportunity to sincerely thank all our customers for their long term loyalty.

Chairman  
J-C Schmitz

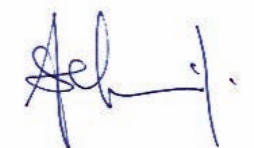



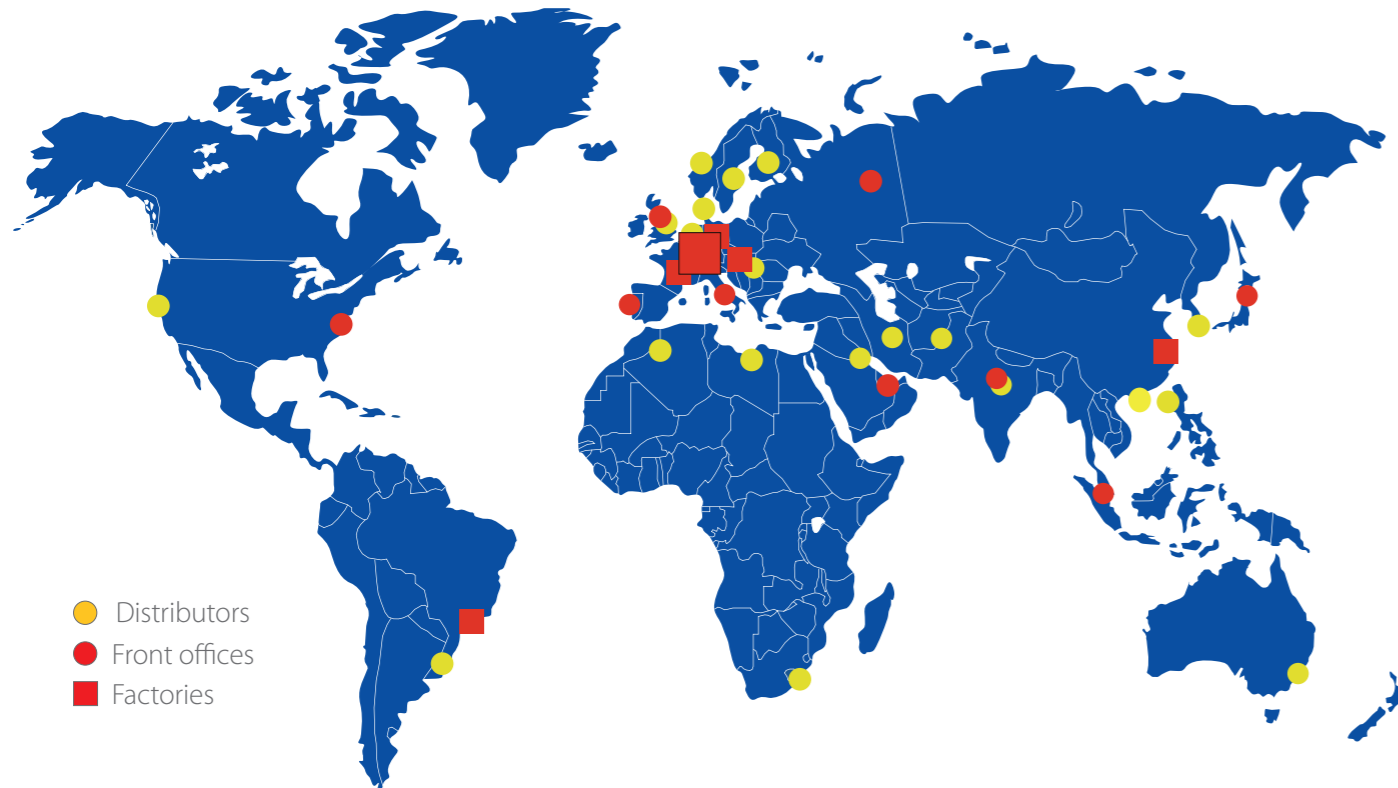



## Research, development & Innovation

ROTAREX is proud of its continuous investment over the past 30 years in new technologies, product and valve design, as well as machining. Today the company works with stainless steel, aluminium, brass, hasteloy, and more recently also plastic.

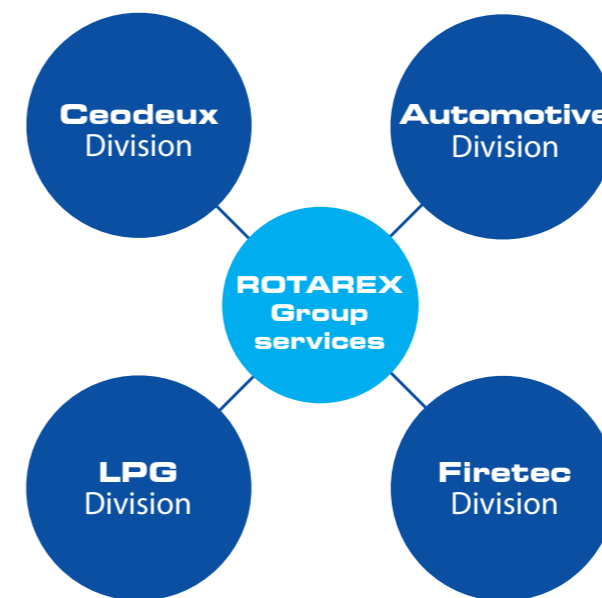

## ROTAREX Group COMPANY STRUCTURE



## ROTAREX today

has the know-how and experience to custom design, develop and manufacture high pressure valves and regulator suited to your needs. Rotarex offers all peripheral services and accesories, from source to process.

## ROTAREX Worldwide

- Semiconductor, photovoltaic & flat panel
- Industrial gases
- Oil & Gas
- Automotive
- Healthcare & medical
- Fire protection
- Transportation & storage
- Cryogenics & refrigeration
- Laboratories
- Welding
- Aerospace
- Leisure industry
- Food & beverage
- Domestic use
- Diving

### Rotarex in numbers

- 1500** People worldwide
- 10** Factories
- 17** Offices
- 22** Distributors
- 4** R & D Labs

Orbital welding, electro polishing and assembly in a clean room are many aspects of the know-how ROTAREX possesses in a multitude of fields. All these methods are developed and finalized in the research and development center of Luxembourg.



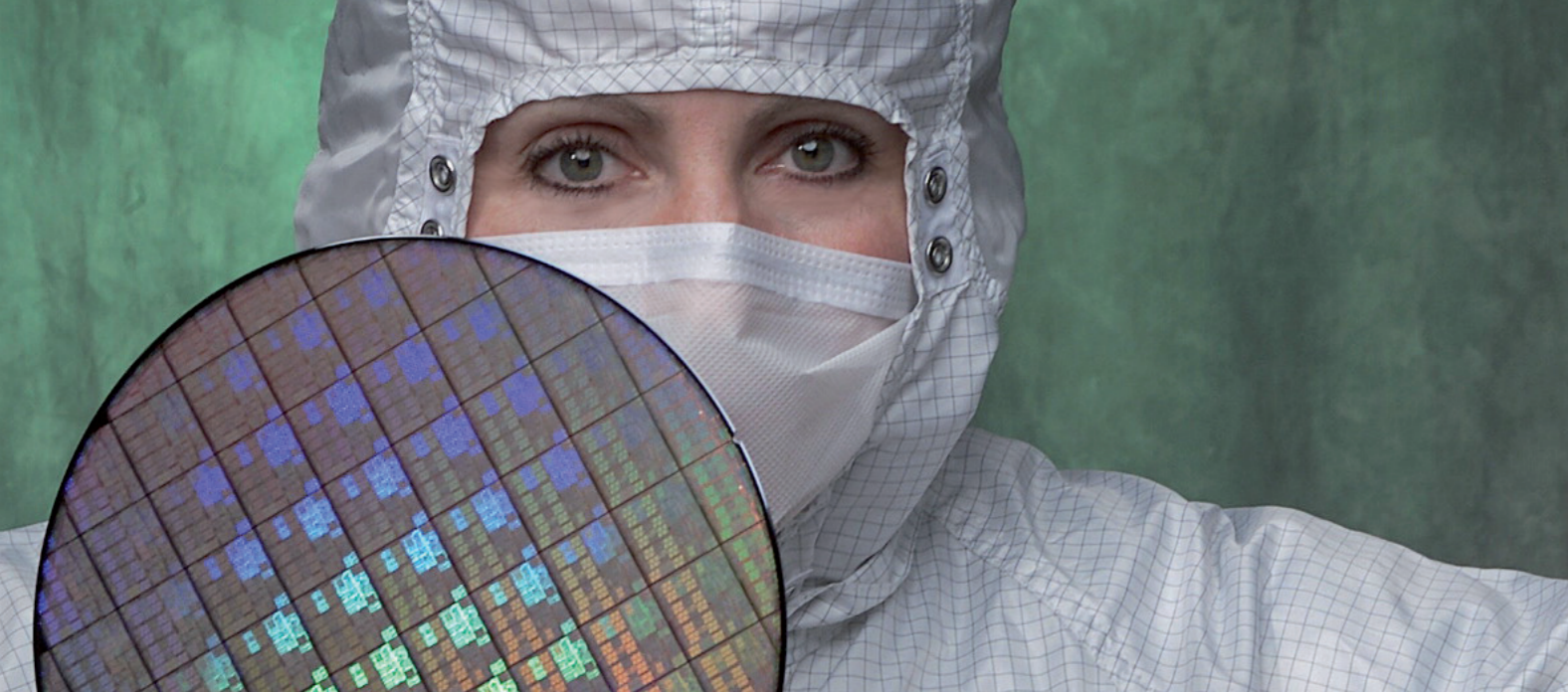

**CEODEUX  
Puretec**

Puretec offers Ultra high purity (UHP) cylinder valves for reactive, corrosive and toxic gases. Puretec is the leader in semiconductor and UHP applications.

**D 131**  
**Description:** High pressure, air operated valves for bundles, packed needle stem design, for corrosive high purity gases



**D 160**  
**Description:** High pressure cylinder valves, 2-piece sturdy stem design with self adjusting, spring loaded gland packing, for corrosive technical gases



**D 200**  
**Description:** High pressure cylinder valves, diaphragm seal type, for high purity gases



**D 300**  
**Description:** High pressure cylinder valves, tied diaphragm seal type, for ultra high purity gases



**D 330**  
**Description:** High flow tube trailer or ton container valves, tied diaphragm seal type, for ultra high purity corrosive gases



**D 335**  
**Description:** High flow cylinder valves, tied diaphragm seal type, for ultra high purity corrosive gases



**D 339**  
**Description:** High pressure, high flow cylinder valves, tied diaphragm seal type, for NF3 and oxidizing gases



**D 340**  
**Description:** High flow cylinder valves, dual port, tied diaphragm seal type, for ultra high purity gases



**D 350**  
**Description:** High pressure, air operated cylinder valves, tied diaphragm seal type, for ultra high purity gases



**D 385**  
**Description:** High flow cylinder valves, tied diaphragm seal type, pneumatic actuated, for ultra high purity corrosive gases



**D 388**  
**Description:** High flow cylinder valves, tied diaphragm seal type with knife edge seat, Vespel seat disc, pneumatic actuated, for ultra high purity Silane and Diborane applications



**C045**  
**Description:** 200bar CO2 valve, typically with Ø8mm seat orifice w/wo safety (190/250bar)



**C1xx/C2xx**  
**Description:** 200/300bar diverse gas valve, typically with Ø4mm seat orifice w/wo safety (190/250bar)



**C97x**  
**Description:** Small cone valve 200/300bar diverse gas w/wo safety (190/250bar)



**C400**  
**Description:** 30bar Acetylene C2H2 yoke or thread outlet round or oval hand wheel w/wo safety



**C3xx**  
**Description:** 200/300bar breathing valve brass or aluminum w/wo manometer w/wo unintentional operation hand wheel w/wo filter or tubes



**RPV valves C5xx**  
**Description:** 200/300bar for O2, CO2 or diverse gas inline and offline versions w/wo safety also as Y-valve and for bundle applications



**C80x Integrated front view**  
**Description:** 200/300bar Integrated valves for C2H2, Ar and O2 integrated 1-stage regulator (flow or pressure) front view manometer protection caps available up to 150kg



**C8xx VIPR - top view**  
**Description:** 200/300bar Integrated valves for C2H2, Ar and O2 1 stage regulator (flow or pressure) top view manometer protection caps for 40/60/150kg



**Y-Valve C041/C046**  
**Description:** 200/300bar CO2 valve 1 big or 2 small hand wheels hand wheel in black/red/blue/aluminum vapor/liquid phase extraction



**Bundle valve**  
**Description:** C14x for O2 or diverse gases 300bar 10mm seat orifice line or angle version



**Turn parts**  
**Description:** Custom made 100's of threads available



**CEODEUX  
Indutec**

Indutec offers cylinder valves for industrial gases. Valves and accessories are available for all standard and specialty gases up to purity 4.5, 200 or 300 bar O-ring type for cylinders and bundles.





## CEODEUX Meditec

Meditec offers valves, fittings, regulators and accessories for all medical gases. Meditec products have a application in hospitals, home care and emergency applications.

**M706**

**Description:**  
Medical integrated valve for oxygen with flowmeter



**Switchover board**

**Description:**  
Automatic, semi-automatic and manual Switchover boards for continuous supply of medical gases.



**M706**

**Description:**  
Medical integrated valve for oxygen with flowmeter, medical connector and guard



**Regulator**

**Description:**  
M730:pressure regulator with preset flow settings for 200 bar oxygen cylinder valve



**Pin Index**

**Description:**  
M966: Pin Index valve for oxygen and medical gases



**Small cone M972 / M978**

**Description:**  
M972: small cone valve for 200bar medical oxygen  
M978: with RPV in line



**Pin Index**

**Description:**  
M650: Pin Index valve for oxygen and medical gases with RPV. M661 (new): Pin Index valve for oxygen and medical gases with non-active RPV 3 bar min



**Pin Index Regulator**

**Description:**  
M730: pressure regulator with preset flow settings for 200 bar oxygen cylinder valve pin index type



**Medical quick couplings**

**Description:**  
Medical connectors for Scandinavia, France, Germany, USA (DISS) and many more.



**M100**

**Description:**  
Cylinder valve for medical oxygen.



**RPV**

**Description:**  
200/300 bar cylinder valve for medical oxygen with RPV inline and offset.



**F110/F111 Serie (ref.F6...)**

**Description:**  
Double O-ring brass cylinder valve for refrigerants  
Max. pressure: 46bar  
Optional : Safety relief valve (F111) Dip tube, Filter, Cap nut, Refill Protection Device



**F230 Serie (F230)**

**Description:**  
Dual phase brass cylinder valve for refrigerants with safety relief valve Max. pressure: 46bar  
Optional : Dip tube, Filter, Cap nut



**F105/F106 Serie (ref.F4...)**

**Description:**  
Diaphragm brass cylinder valve for refrigerants  
Max. pressure: 46bar  
Optional : Safety relief valve (F106),Dip tube, Filter, Cap nut, Refill Protection Device



**F211 Serie (F211)**

**Description:**  
Dual phase diaphragm brass cylinder valve for refrigerants with safety relief valve (or cart.)  
Max. pressure: 46bar  
Optional : Dip tube, Filter, Cap nut, Refill protection Device



**F112/F113 Serie (ref.F5...)**

**Description:**  
Brass container valve for refrigerants.  
Max. pressure: 46bar  
Optional : Safety relief valve (F113) Dip tube, Filter, Cap nut, Refill Protection Device



**F120 Serie (ref.F7...)**

**Description:**  
Package sealed Steel cylinder valve for ammonia (zinc plated)  
Max. pressure: 33bar (70bar)  
Optional : Dip tube, Filter, Cap nut,Refill Protection Device



**EMV 40LPI Serie (indirect)**

**Description:**  
Brass solenoid shut-off valve for refrigerants, water, compressed air. Max. pressure: 40bar. Tightness: PTFE & EPDM. Optional modules : Manual operation, Filter, Check valve, Sight glass, Also in stainless steel



**EMV 30LPD Serie (direct)**

**Description:**  
Brass solenoid shut-off valve for refrigerants, water, compressed air...  
Max. pressure: 30bar (25)  
Tightness: EPDM, FPM, CR  
Optional : FPM or CR sealing, Stainless steel core



**F101 Ethylene oxyde / F101 Propylene**

**Description:**  
Diaphragm brass cylinder valve for ethylene oxyde or propylene with Safety relief cartridge  
Max. pressure: 46bar  
Optional : Dip tube, Filter, Cap nut,



**F102 Methyl bromide (ref.F4...)**

**Description:**  
Diaphragm brass cylinder valve for methyl bromide with Pressuring valve  
Max. pressure: 46bar  
Optional : Dip tube, Filter, Cap nut,



**F106 Glue (ref.F1009...)**

**Description:**  
Diaphragm brass cylinder valve for adhesives with Safety relief cartridge  
Max. pressure: 46bar  
Optional : Dip tube, Filter, Cap nut,



## CEODEUX Refrigerant

CEODEUX Refrigerant offers a comprehensive range of cylinder and container valves for refrigerants and special applications. CEODEUX Refrigerant has a unique concept of modular solenoid valves for refrigerants, water and compressed air.





## ROTAREX Equipment

ROTAREX Equipment offers a wide range of valves, regulators and fittings. It meets the requirements of every gas piping network and installation, offering a global gas component solution, from source to point of use.

ROTAREX Equipment includes the following product ranges: SELFA, SMT, SAGANA and MEROBEL.

**SELFA:** UHP diaphragm valves and pressure regulators, bellows valves for high flow and cryogenic applications.

**GAZEL:** UHP fittings

**SMT:** Pressure regulators, switch over boards, points of use and modules.

**SAGANA:** Valves, fittings & components for instrumentation.

**MEROBEL:** Large scale pipeline valves and regulators.

**SELFA**



**Description:**  
UHP tied diaphragm valves manual and air operated  
**1/4" - 1/2"**

**SELFA**



**Description:**  
UHP Diaphragm valves manual and air operated  
**1/2" - 3/4" - 1"**

**SELFA**



**Description:**  
UHP diaphragm valve for high cycling applications manual and air operated  
**1/4" - 1/2"**

**SELFA**



**Description:**  
UHP Veeblock diaphragm valve blocks  
**1/4" or 3/8"**

**SELFA**



**Description:**  
KD/KY Highflow bellows valve for UHP bulk gas  
**1/2" - 4"**

**SELFA**



**Description:**  
Bellows valves for standard or high pressure applications manual and air operated  
**1/4" - 3"**

**SELFA**



**Description:**  
HP non tied diaphragm pressure regulator for point of use and gas cabinets applications

**SELFA**



**Description:**  
UHP tied diaphragm pressure regulator for gas cabinets and point of use  
**1/4" - 3/8"**

**SAGANA**



**Description:**  
Tube fittings  
1/16" - 2"  
3mm - 50mm  
Stainless steel or brass

**SAGANA**



**Description:**  
Thread fitting  
1/16" - 2"  
Stainless steel 316L or Brass

**SAGANA**



**Description:**  
Check valve

**SAGANA**



**Description:**  
Filter

**SAGANA**



**Description:**  
Quick connect couplings

**SAGANA**



**Description:**  
Hose, stainless steel braid with PTFE or SS316L inner tube.

**SAGANA**



**Description:**  
Needle valve  
Metering valve  
brass & stainless steel

**SAGANA**



**Description:**  
Ball valve

**SMT**



**Description:**  
Automatic, semi-automatic and manual Switchover boards

**SMT**



**Description:**  
Single stage pressure regulator stainless steel 316L or Brass

**SMT**



**Description:**  
Double stage pressure regulator stainless steel 316L or Brass

**SMT**



**Description:**  
MSL 40 Compact Point of use

**GAZEL**



**Description:**  
UHP metal face seal fitting

**GAZEL**



**Description:**  
UHP Micro fittings for orbital welding

**SELFA**



**Description:**  
MTA cylinder connectors GCA, DISS, BS, AFNOR, DIN, JIS, Uni...

**SELFA**



**Description:**  
Supra Cryogenic bellows valve manual and air operated down to -270°C

**MEROBEL**



**Description:**  
Pipeline gate valves

**MEROBEL**



**Description:**  
DET 170 pressure regulator





## ROTAREX Hydrogen Line

Valves, regulators and fittings. ROTAREX is already present in many fields of application with a large range of hydrogen compatible and certified products.

**Sirius evo**

**Description:**  
Patented 1-stage bellows pressure regulator with solenoid shutoff valve, filter and sensor



**D 335**

**Description:**  
High flow cylinder valves, tied diaphragm seal type, for ultra high purity gases



**Safety valve for H2**

**Description:**  
Safety valve for Hydrogen



**SAGANA**

**Description:**  
Ball valves



**SELFA**

**Description:**  
Bellows valves for standard or high pressure applications manual and air operated 1/4" - 3"



**SELFA**

**Description:**  
HP non tied diaphragm pressure regulator for point of use and gas cabinets applications



**SELFA**

**Description:**  
MTA cylinder connectors GCA, DISS, BS, AFNOR, DIN, JIS, Uni



**Bundle valve C14x**

**Description:**  
300bar 10mm seat orifice line or angle version



**RPV valves C5xx**

**Description:**  
200/300bar inline and offline versions w/w safety also as Y-valve and for bundle applications



**MEROBEL**

**Description:**  
Pipeline gate valves



**Solenoid MAV for H2**

**Description:**  
Solenoid valve for low pressure Hydrogen



**SMT**

**Description:**  
CEN Automatic, semi-automatic and manual Switchover boards



**SMT**

**Description:**  
Module MOD 16



**SMT**

**Description:**  
Double stage pressure regulator stainless steel 316L or Brass



**SMT**

**Description:**  
Single stage pressure regulator stainless steel 316L or Brass



**SMT**

**Description:**  
Compact Point of use



**SMT**

**Description:**  
Mono SL20 Point of use



**SMT**

**Description:**  
Double stage pressure regulator stainless steel 316L or Brass



**INDUTEC**

**Description:**  
200/300bar Integrated valves with 1-stage regulator (flow or pressure) front view manometer



**SAGANA**

**Description:**  
Tube fittings 1/16" - 2" 3mm - 50mm Stainless steel or brass



**SAGANA**

**Description:**  
Hose, stainless steel braid with PTFE or SS316L inner tube.



**SMT**

**Description:**  
Pigtail



## ROTAREX Laser Line

ROTAREX offers products for the use in Laser applications, ranging from simple single stage regulators to precision double stage regulators and switchover boards for constant gas supply.





## ROTAREX Firetec

Firetec specializes in fire extinguishing valves, components and complete systems. Many decades of experience and continuous research and innovation make Firetec products high-tech market leading systems. Firetec is also growing into the beverage market with water carbonization solutions and components.

**B0482**  
**Description:**  
valve for fixed installations  
Ø33mm for chemical gases



**B0701**  
**Description:**  
FireDeTec ILP  
(Indirect Low Pressure)  
valve with solenoid actuator  
for automatic & autonomous  
fire extinguishing systems



**B0439**  
**Description:**  
Solenoid valve for fixed  
installations with inert  
gas 200 bar



**B0481**  
**Description:**  
valve for fixed installations  
Ø49mm for chemical gases



**B0480**  
**Description:**  
valve for fixed installations  
for CO2, inert gases. 200  
and 300 bar



**B0840**  
**Description:**  
Constant discharge pres-  
sure regulator for 300 bar  
Inert gas.  
Connects to B0480 2 valve



**B0702**  
**Description:**  
FireDeTec IHP (Indirect High  
Pressure) valve for automatic  
& Autonomous CO2 fire ex-  
tinguishing systems



**B0480 DIMES**  
**Description:**  
valve for fixed CO2  
installations with integrated  
Digital MEasuring System  
"DIMES" electronic con-  
tents control



**Extinguisher system**  
**Description:**  
Compact autonomous extin-  
guisher kit for vehicles such  
as buses trains, trucks etc.



**B0330**  
**Description:**  
All plastic squeeze grip  
valve for cartridge operated  
fire extinguishers 4-12kg  
powder or water



**B0111**  
**Description:**  
Brass squeeze grip valve for  
constant pressure CO2 fire  
extinguishers



**CNG Conversion Kit**  
**Description:**  
Complete conversion  
for CNG retro-fitting  
with all parts included.



**LPG Conversion Kit**  
**Description:**  
Complete conversion  
for LPG retro-fitting  
with all parts included.

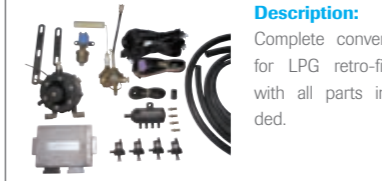

**C350 evo**  
**Description:**  
Solenoid cylinder valve for  
CNG. With manual shutoff  
valve, safeties, limiters and  
check valve



**Polyvalve LPG**  
**Description:**  
All-in-one valve for LPG with  
solenoid service valve, 80%  
fillstop filling port, safety  
valve, gauge and shutoff



**C354 Linevalve**  
**Description:**  
High pressure CNG  
solenoid line valve



**Y841**  
**Description:**  
Vented handwheel operated  
cylinder valve for CNG.  
With integrated safeties



**Sirius evo**  
**Description:**  
Patented 1-stage bellows  
pressure regulator for CNG  
with solenoid shutoff valve,  
filter and sensor



**C350 vented**  
**Description:**  
Vented solenoid cylinder  
valve for CNG.  
With manual shutoff valve  
and safeties.



**Liquid H2 cryo valve**  
**Description:**  
Pneumatic intank service  
valve for cryogenic Liquid  
Hydrogen

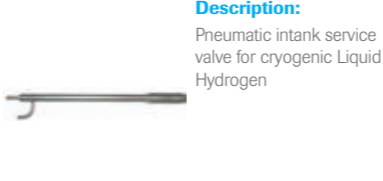

**Solenoid MAV for H2**  
**Description:**  
Solenoid valve for low  
pressure Hydrogen



**LPG connectors**  
**Description:**  
LPG filling ports and  
adapters for all countries



## ROTAREX Automotive

ROTAREX Automotive is specialized in all automotive alternative fuel applications such as Natural Gas, and Hydrogen. ROTAREX offers LPG fuel systems for cars and fork lifters. Complete CNG conversion Kits are available or components for direct installation as well as retrofitting.





## ROTAREX LPG / SRG

LPGtec, SRG and CMT form the LPG division which specializes in all types of LPG products, for the consumer market as well as for Industrial markets.

### SRG 59x/54x

**Description:**  
Clipon regulators for home or industrial use. Available for jumbo, compact and many other connection types and configurations



### SRG 41x/42x

**Description:**  
Clipon valves for home or industrial use. Available for jumbo, compact and many other types and configurations



### A300

**Description:**  
Handwheel valve with/without integrated pressure relief device for LPG cylinders



### A150 Solenoid valve

**Description:**  
Service valve electromagnetically operated with flow limiting device



### Tank regulators

**Description:**  
First, second and twinstage regulators for stationary (bulk) applications



### Tank equipment

**Description:**  
The tankequipment lines include all necessary valves used on stationary (bulk) tanks



### MLD

**Description:**  
The Minimum Level Detector for use in forklifts. LPG level indication to avoid running out of fuel



### SRG 487

**Description:**  
Liquid Level Gauges for stationary (bulk) and transportable (automotive and forklift) applications



### A100

**Description:**  
Filler valve with overfill protection for forklifts



### A301 Indicator valve

**Description:**  
Cylinder valve with integrated level gauge with/without overfill protection device. For LPG cylinders



### Indicator regulator

**Description:**  
Clipon LPG regulator with integrated Level gauge



### Plastic



**Description:**  
Plastic injection moulding

### Plastic



**Description:**  
Development of plastic parts for all fields of application

### Plastic



**Description:**  
Development and construction of moulds

### Plastic



**Description:**  
Injection moulding of medical parts

### Turning



**Description:**  
Turning of axles out of brass, stainless steel, aluminum and many other materials

### Machining



**Description:**  
Complex machining of Brass, stainless steel, steel, aluminum and many other materials

### Turning



**Description:**  
Turning and milling of parts out of brass, stainless steel, aluminum and many other materials

### Stamping



**Description:**  
Stamping of complex mechanical parts

### Tooling



**Description:**  
Development and manufacturing of highest quality tools for all metals and applications

### Tooling



**Description:**  
Development and manufacturing of all kinds of tooling

### Tooling



**Description:**  
Development and manufacturing of specialty tooling

## ROTAREX Subcontracting

ROTAREX offers many subcontracting services, such as forging, machining, turning or all kinds of parts made of brass, stainless steel, aluminium and others. Ludec and Axitec are specialized in turn parts, where as Lumecc takes care of machining. Plastic Injection moulding is also a part of ROTAREX services and is done in Eifel-Spritzguss.





**NORTH AMERICA**  
 CEODEUX INC - ROTAREX INC  
 221 Westec Drive  
 Westmoreland Technology Park I  
 Mt. Pleasant  
 USA Pennsylvania 15666  
 Tel. 724-696-33 45  
 Fax 724-696-33 52  
 e-mail: info@rotarex-inc.rotarex.com

**WORLDWIDE HEADQUARTERS**  
**EUROPE**  
 LUXEMBOURG  
 24, route de Diekirch, B.P. 19  
 L-7505 Lintgen  
 Tel. +352 32 78 32 - 1  
 Fax +352 32 78 32 - 854  
 e-mail: info@rotarex.com

**SOUTH AMERICA**  
 ROTAREX BRASIL Ltda  
 391, Av. Eng° Ronaldo A. Guedes Pereira  
 Distrito Industrial - Mogi Guaçu City  
 Zip Code: 13845-970 - Sao Paulo  
 Brazil  
 Tel. +55 19 38312232  
 Fax +55 19 38312235  
 e-mail: info@brasil.rotarex.com

**UNITED ARAB EMIRATES**  
 ROTAREX MIDDLE EAST  
 P.O. Box: 36615 - Abu Dhabi U.A.E.  
 Tel. +971 2 4453756  
 Fax +971 2 4453756  
 e-mail: info@middle-east.rotarex.com

**ASIA**  
 ROTAREX STAR  
 60 YuanZhong Road  
 Shanghai Nanhui Industrial Zone  
 CHINA - 201300, Shanghai  
 Tel. 86-21 5800 4000  
 Fax 86-21 5800 3226  
 e-mail: info@star.rotarex.com

**GERMANY**  
 SRG Schulz & Rackow Gasttechnik GmbH  
 2 Vor dem Langen Loh, Postfach 12 60  
 D-35075, Gladenbach / Germany  
 Tel. +49 6462 93 92 0 / fax +49 6462 93 92 91  
 e-mail : info@srg.rotarex.com

**FRANCE**  
 CEODEUX S.A - ROTAREX  
 168 Av Charles de Gaulle  
 92522 Neuilly sur Seine / France  
 Tel. +33 1 70 37 53 88 / fax +33 1 70 37 53 89  
 e-mail : info@france.rotarex.com

**CZECH REPUBLIC**  
 ROTAREX Praha s.r.o.  
 2085 Plzenska ulice  
 CZ-347 01, Tachov / Czech Republic  
 Tel. +420 374 733 610 / fax +420 374 733 612  
 e-mail : info@praha.rotarex.com

**RUSSIA**  
 Galitzine Consulting Ltd  
 8 Vnutrenny proezd  
 113149, Moscow / Russia  
 Tel. +7 495 225 96 72 / fax +7 495 225 96 73  
 e-mail : petrov@galitzineconsulting.ru

**JAPAN**  
 ROTAREX Japan Ltd  
 Rm201, Inoue Bldg. 7-15-10 Nishishinjuku  
 160-0023, Shinjuku-ku, Tokyo / Japan  
 Tel. +81 3 5348-5167 / fax +81 3 5348 5168  
 e-mail : nishioka.miwa@rotarex-japan.co.jp

**SINGAPORE**  
 ROTAREX Fareast Pte Ltd  
 Blk115A Commonwealth Drive #05-22,  
 Tanglin Halt Industrial Estate  
 149596, Singapore / Singapore  
 Tel. +65 6 472 37 27 / fax +65 6 472 45 28  
 e-mail : info@fareast.rotarex.com

**THE NETHERLANDS**  
 CMT BV  
 50 Hakselseweg  
 NL-6713 KW, Ede / Netherlands  
 Tel. +31 318 61 91 38 / fax +31 318 65 00 36  
 e-mail : info@cmtbv.nl

**FRANCE**  
 SMT S.A.S.  
 5 rue de la Labergement  
 F-21110, Genlis (Dijon) / France  
 Tel. +33 3 80 47 61 00 / fax +33 3 80 31 34 45  
 e-mail : info@smt.rotarex.com

**ITALY**  
 ROTAREX Italia Srl  
 46 Via Giacomo Matteotti  
 I-25080, Cliverghe di Mazzano (Bs) / Italy  
 Tel. +39 030 2120550 / fax +39 030 2122362  
 e-mail : info@italia.rotarex.com

**PORTUGAL**  
 Office was transferred to SRG  
 Tel. +49 6462 93 92 0 / fax +49 6462 93 92 91  
 e-mail : info@srg.rotarex.com



