

Rotary shaft seals

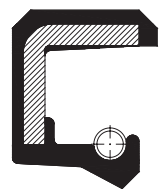

Description of standard seal types	6
Additional types	7
Technical data	9
Installation and operation	10
Housing bore	12
Lubrication	13
Temperature	14
Pressure	15
Production and Quality assurance	16
Radiaseal®	18
Splitring®	20
Dina seals	21
C64D type	22
Storage and handling / Interchange table	23

Description of standard shaft seal types (in accordance with DIN 3760)



A Rubber covered O.D., metal insert, sealing lip with garter spring

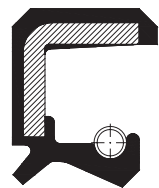

AS Rubber covered O.D., metal insert, sealing lip with garter spring and additional dust lip

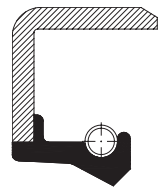

B Outer metal case, sealing lip with garter spring

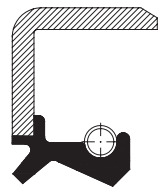

BS Outer metal case, sealing lip with garter spring and additional dust lip

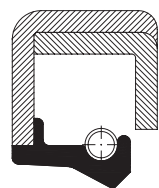



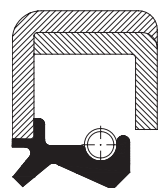















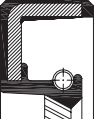

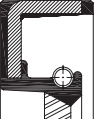
C Outer metal case with reinforcing metal inner ring, sealing lip with garter spring



CS Outer metal case with reinforcing metal inner ring, sealing lip with garter spring and additional dust lip

Additional types

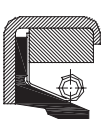
- | | | | | | |
|--|----------------|---|---|---------------------------|---|
|  | AS - P | Reinforced sealing lip for overpressure, with or without additional dust lip |  | B - O | Outer metal case, sealing lip without garter spring |
|  | AS - PX | Reinforced sealing lip and special metal insert for overpressure, with additional dust lip |  | C - O | Outer metal case with reinforcing metal inner ring, without garter spring |
|  | A - DUO | Twin sealing lips with two garter springs |  | C - TE | Inner metal case and sealing lip on O.D.; type B-TE available as well |
|  | A - O | Sealing lip without garter spring |  | C-DUO | Outer metal case with reinforcing cap, twin sealing lips with two garter springs |
|  | A - FL | Different spring groove for a better spring retention, waved O.D. |  | COMBI SEAL | Combination of a shaft seal and an additional lip in polyurethane against soiling, all in one housing |
|  | A - LD | Sealing lip with hydrodynamic ribs, left rotation |  | CASSETTE SEAL | Integrated sealing system: oil seal, wear sleeve and dust protection in one unit |
|  | A - RD | Sealing lip with hydrodynamic ribs, right rotation |  | RADIASEAL | Rotary shaft seal with fabric reinforced outer diameter |
|  | A - WD | Sealing lip with bi-directional hydrodynamic ribs |  | SPLITRING | Rotary shaft seal only rubber, split |
|  | ASX7 | Waved rubber covered O.D., metal insert, sealing lip with garter spring, with or without dust lip |  | DINA Seal Metal OD | Rotary shaft seal for needle bearing applications, without spring |
|  | A - EC | End covers |  | DINA Seal Waved OD | Rotary shaft seal for needle bearing applications, without spring |
|  | A - TE | Rubber covered I.D. and sealing lip on O.D. |  | C64D | Rotary shaft seal for heavy industry |



Additional types

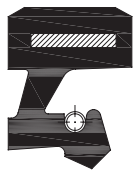

AX-7M

This seal is designed for use in presence of pressure, up to max 0.6 [MPa]. A metallic band is inserted in the back of the seal. It is assembled in open housings and does not need a retaining flange. This profile is flexible and easy to assemble, ensuring stability in the housing



AX-3M

This seal does not need the retaining flange. The rubber seal has a flexible metal band in its shoulder, which makes it resistant, elastic and easy to install. This seal can be assembled in open housings and has a better resistance to possible misalignments. The spring is more protected than in standard seals

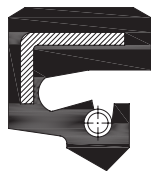

AX-3ML

Same profile as the AX-3M, but with a rigid metal insert inside the shoulder, instead of the flexible metal band



C59D

Interchangeable with Garlock[®] 59 seal, it is mostly used in steel mill plants or wherever a strong seal is necessary. This profile has a flexible rubber sealing lip and a metallic cage back with a finger-spring. The seal withstands a pressure of max 0.1 [MPa]

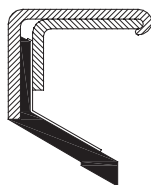

C63D

Interchangeable with Garlock[®] 63 seal, it is mostly used in hot steel mill plants. This profile has a flexible rubber sealing lip and a metallic cage back with a finger-spring



AX-GL

Originally designed to withstand large misalignments of some millimeters in static conditions, this seal can also be used for dynamic sealing with limited radial speed. The profile has a metallic cage inside its shoulder, with a spring that ensures the constant load operation



Technical data

Description of rotary shaft seal

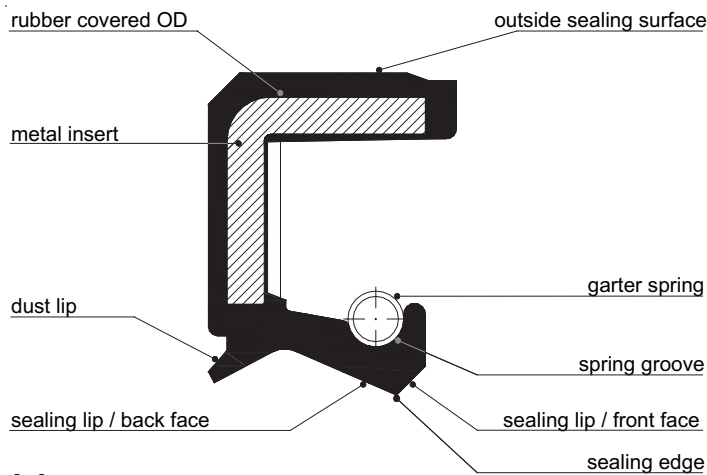

Working principle

The area between the sealing edge and the shaft is the most important. The sealing effect is achieved by preloading the sealing lip, making its internal diameter slightly smaller than the shaft diameter. The garter spring ensures constant mechanical pressure and maintains the radial force to the shaft, flattening the sealing edge to a defined width. Sealing is provided by the surface tension of the hydrodynamic oil film between the seal flattened area and the shaft. Oil thickness must be between 1 and 3 [µm] to avoid leakage. The meniscus acts as an interface between the outside air and the fluid. Any break in the meniscus will result in leakage. This can occur if the shaft contains scratches along the seal path.

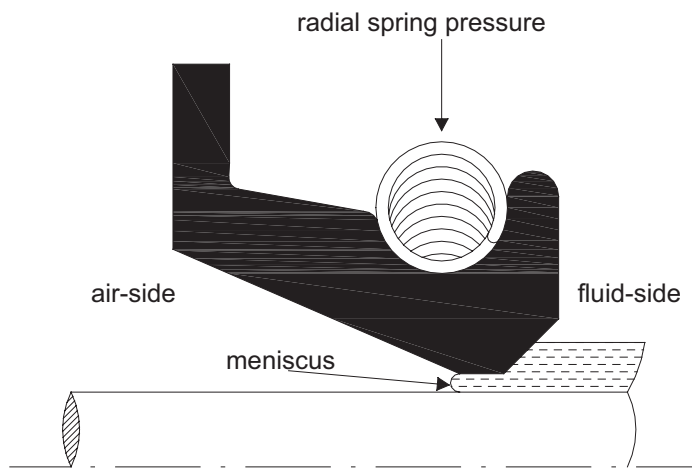

Metal case

The metal insert or case is used to give strength and rigidity to the seal. Normally it is made of cold rolled steel in accordance with DIN 1624.

To avoid rust or chemical attack, stainless steel can be used:

- Chrome Nickel AISI 304 (1.4301);
- Chrome Nickel Molybdenum AISI 316 (1.4401).

Garter spring

The garter spring maintains the radial force exerted by the sealing lip around the shaft surface. Normally produced in spring steel wire SAE 1074 (DIN 17223) or stainless steel wire Chrome Nickel AISI 302/304 (1.4300/1.4301).

For special applications also stainless steel springs in AISI 316 (1.4401) are available. All our standard shaft seals produced in FPM compound are fitted with stainless steel springs in AISI 302/304 (1.4300/1.4301).



Installation and operation

Shaft

The shaft surface finish is of primary importance for efficient sealing and for achieving a useful lifetime. Basically the hardness should increase with increasing peripheral speed. According to DIN 3760 minimum hardness required is 45 HRC. At a peripheral speed of 4 [m/s] the hardness should be 55 HRC and at 10 [m/s] 60 HRC. Recommended hardness depth: 0.3 [mm] if shafts are not fully hardened.

Lubrication is also very important.

Surface finish as specified by DIN 3760 must be Ra 0.2 to 0.8 [μm], Rz 1 to 5 [μm], with R_{MAX} 6.3 [μm]. Rougher surfaces generate higher friction, hence higher temperatures. Machining defects and scratches on the shaft must be avoided.

Even very small defects could be sufficient to increase the film thickness, eventually rupturing the meniscus and causing leakage. It is also important to avoid spiral grinding or marks, because they can cause a pumping effect and leakage.

Recommended machining tolerance is ISO h11 according to DIN 3760 (see table below).

Shaft diameter [mm]		Tolerance [mm]
from	to	h11
6	10	0 -0,090
10	18	0 -0,110
18	30	0 -0,130
30	50	0 -0,160
50	80	0 -0,190
80	120	0 -0,220
120	180	0 -0,250
180	250	0 -0,290
250	315	0 -0,320
315	400	0 -0,360

Installation and operation

The best working condition is achieved when the shaft is perfectly rotating centered and concentric to the axis of the rotary shaft seal. Obviously this is not possible and inevitably some shaft run-out is always present. Therefore the sealing lip must compensate for it. The higher the rotation speed is, the smaller the permissible shaft run-out can be. This can be compensated by the sealing lip, because the inertia of the sealing lip prevents it from following the shaft movements. It is therefore advisable to install the seal immediately adjacent to the bearing where the shaft's oscillation is at its minimum.

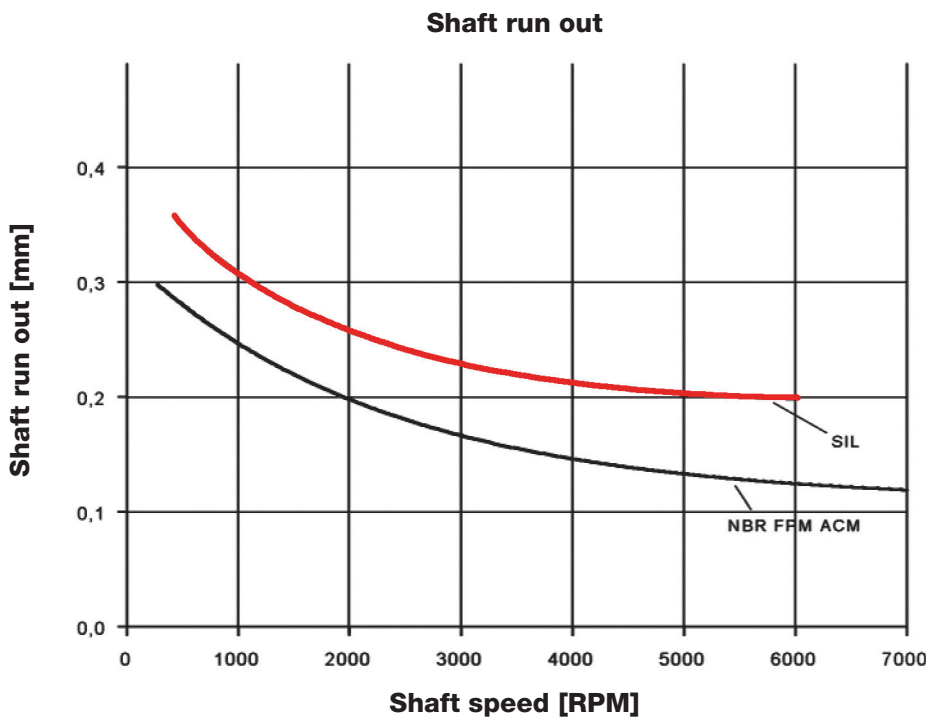

Eccentricity between shaft and housing bore centers must be avoided as much as possible so as to reduce unilateral load (wear) of the sealing lip.

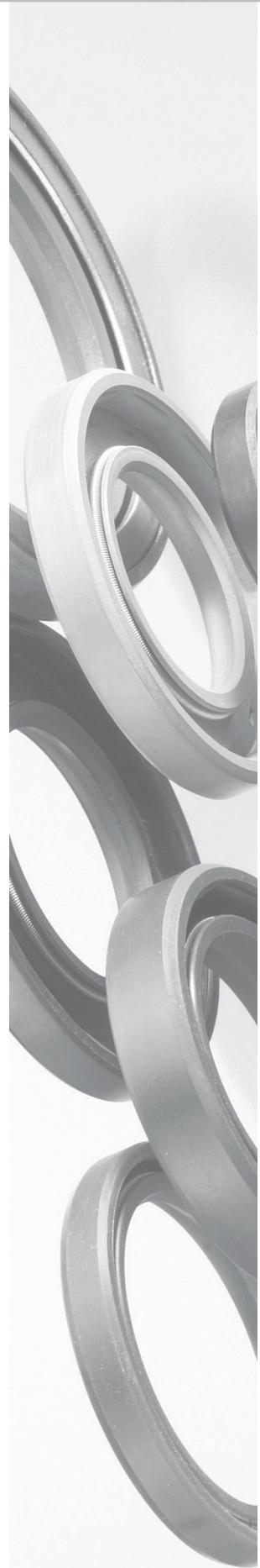
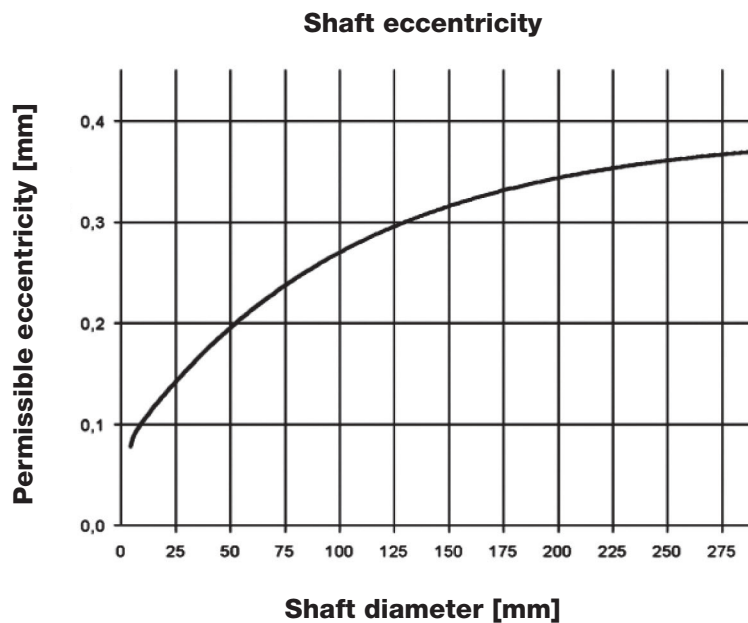

Housing bore

A good press fit of the shaft seal into the housing bore is vital. The result is a stable installation.

Recommended machining tolerances of the housing bore diameter for rotary shaft seals are ISO H8 according to DIN 3760 (see table below).

Housing bore [mm]		Tolerance
from	to	H8
10	18	+0,027 0
18	30	+0,033 0
30	50	+0,039 0
50	80	+0,046 0
80	120	+0,054 0

Housing bore [mm]		Tolerance
from	to	H8
120	180	+0,063 0
180	250	+0,072 0
250	315	+0,084 0
315	400	+0,089 0
400	500	+0,097 0

The maximum surface roughness of the housing according to DIN 3760 is Ra 1.6 to 6.3 [µm], Rz 10 to 20 [µm], with R_{MAX} 25 [µm].

We recommend the use of a shoulder or a spacer ring against which the seal can be installed. Should this not be possible the installer has to pay special attention that the seal is installed perpendicularly to the shaft axis.

To ease installation the entrance of the groove should have a chamfer inclined by 10° - 20° and a depth according to the ring thickness (see figure below). Also the mounting end of the shaft should have a chamfer inclined by 15° - 30°, with rounded and polished edge.

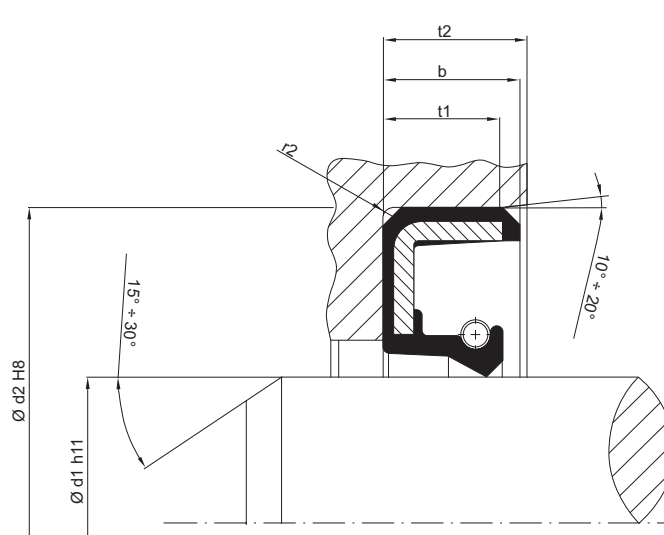

b [mm]	t1 [mm] (0.85*b)	t2 [mm] (b+0.3)	r2 [mm]
	min.	min.	max.
7	5,95	7,3	0,5
8	6,8	8,3	
10	8,5	10,3	
12	10,2	12,3	0,7
15	12,75	15,3	
20	17	20,3	

Lubrication

Lubrication is essential for good functioning and lifetime of the seal. The sealing lip does not actually run on the shaft directly, but on an oil film called meniscus. The thickness of the meniscus is usually between 1 - 3 [µm], but is influenced by many factors such as oil viscosity, shaft surface finish, seal radial load and other mechanical parameters.

The first few hours of operation are called the «bedding-in» time. This is necessary not only for the meniscus to form, but also for the sealing edge to flatten. During this time limited leakage is possible.

Adequate lubrication strongly reduces friction between sealing lip and shaft and also acts as a coolant to the generated heat. The lower the temperature can be kept, the longer the life expectancy of the seal will be. Should the fluid have poor lubricating capability (water and aqueous solutions), dust lip-type (AS, BS or CS) rotary lip seals must be used. In such a case make sure to fill the space between the two lips with grease. The friction heat also depends on the peripheral speed of the shaft.

Sealing lip frictional heat

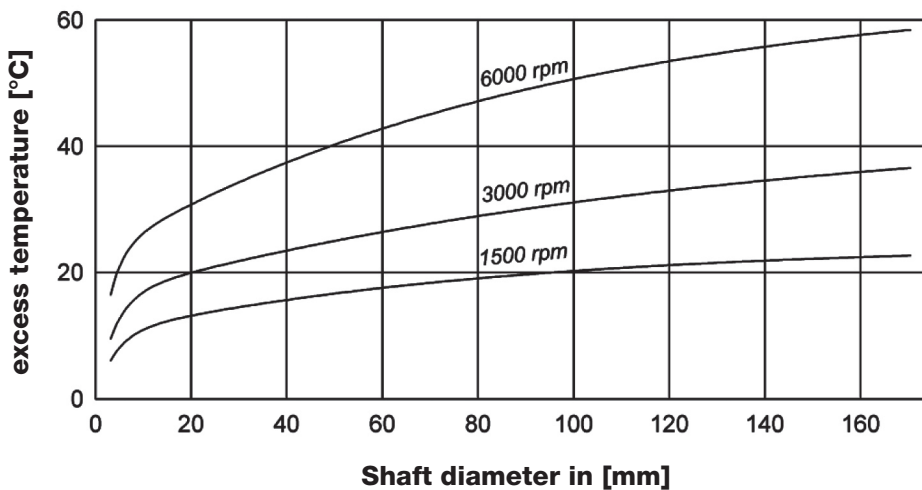

Friction not only can be detrimental to the lip material, but also can cause a power loss which could be quite significant if low power is transmitted.

Frictional power loss

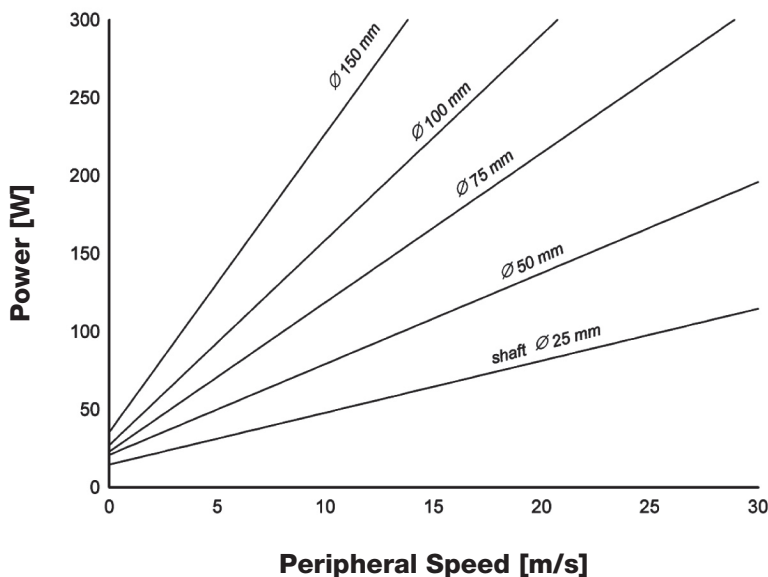

Temperature

The temperature measured on the sealing lip is the medium temperature increased by the temperature caused by frictional heat.

The higher the effective operating temperature is, the faster the ageing of the elastomer will be, thus affecting the performance of the sealing lip and the shaft.

Frictional heat depends on seal design and material, peripheral speed, sealing lip preloading, spring force, shaft design and surface finish, lubrication, medium, etc.

Permissible speeds in pressure-free state according to DIN 3760

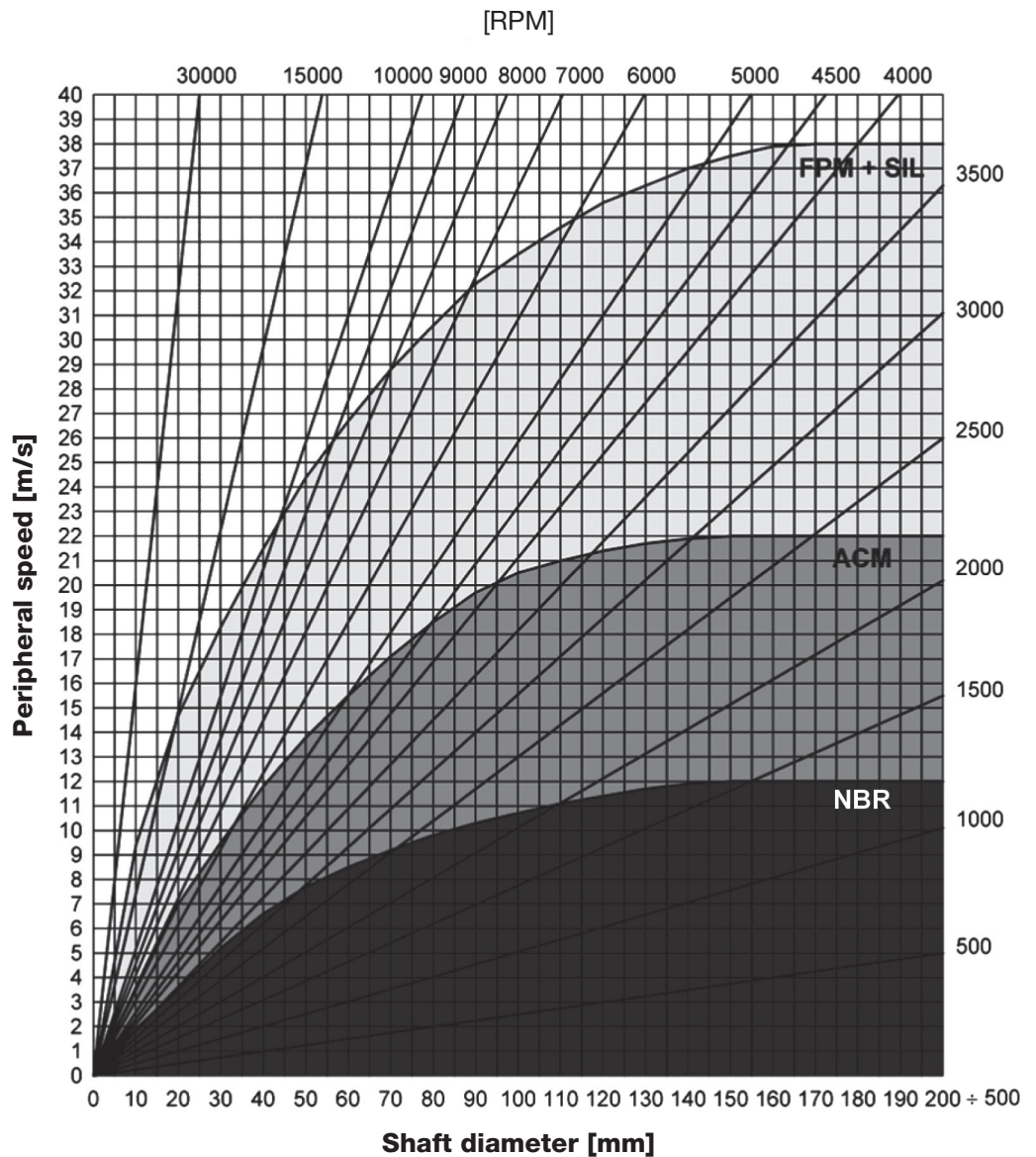

Pressure

In applications where the rotary shaft seal is exposed to pressure the sealing lip is pressed against the shaft, thus increasing temperature. In some cases the pressure can even cause overturning of the sealing lip.

Over 0.02 [MPa] at higher peripheral speeds or over 0.05 [MPa] at low peripheral speeds back-up rings or special designed rotary shaft seals with stronger sealing lip and supporting metal insert must be used. For the latter we refer to our P-types (e.g. AS-P). Nevertheless permissible overpressures with P-type shaft seals are limited (see diagram below).

Rotary shaft seals AS-P. Permissible Overpressure

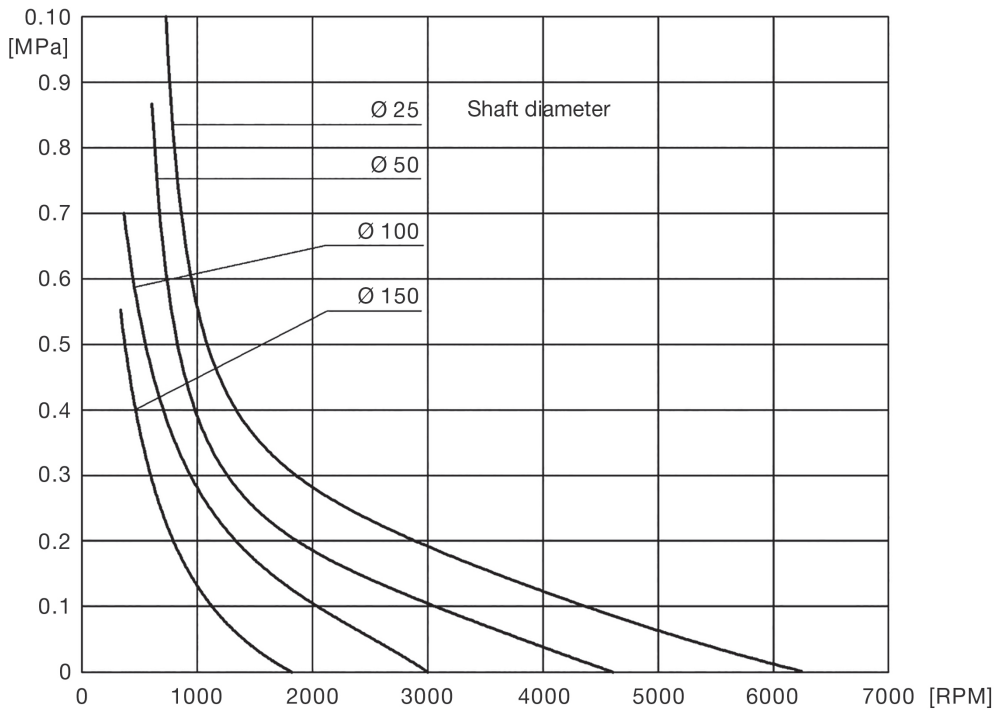

On request we can supply shaft seals with special reinforced lip to withstand pressure over the indicated value.

If back-up rings are installed standard rotary shaft seals can be used. However, back up rings increase costs and the necessary space for installation is often not available. Sometimes the use of back-up rings is not even possible, since it requires a very accurate housing as well as very low eccentricity of the shaft.

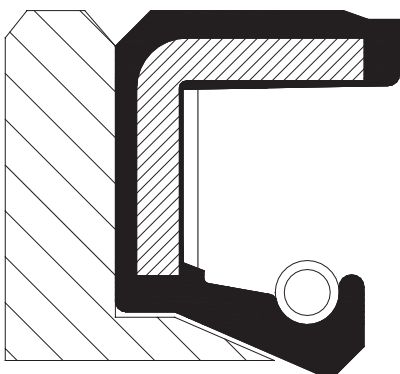

Specially designed rotary shaft seals (AS-P types) are therefore preferred, even if more accurate fitting and lower shaft's eccentricity than in normal cases are required.



Production and Quality assurance

Our rotary shaft seals are manufactured and categorized according to German Standards DIN 3760 - 3761 and Quality Assurance Standards ISO 9001.

All production phases are checked and all measurements are recorded and stored for traceability.

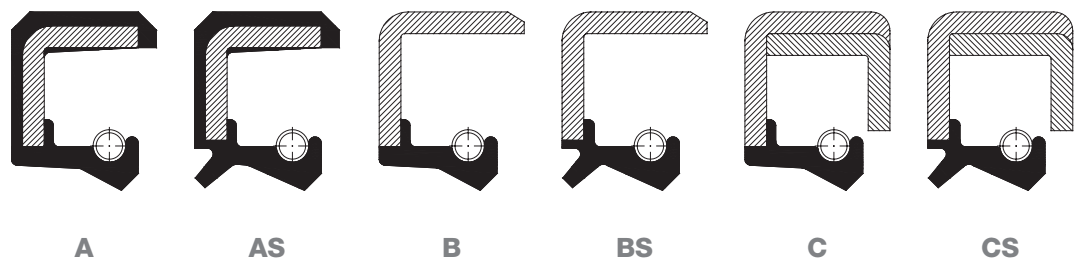

Interference allowance and permissible roundness

In accordance with German Standard DIN 3760 and ISO 6194-1

Seal outer diameter d_2 [mm]	Interference allowance ⁽¹⁾ [mm]		Roundness tolerance on d_2 ⁽²⁾ [mm]
	Types A, AS	Types B, BS, C, CS	Types A, AS, B, BS, C, CS
up to 50	+0,30 +0,15	+0,20 +0,08	0,25
over 50 to 80	+0,35 +0,20	+0,23 +0,09	0,35
over 80 to 120	+0,35 +0,20	+0,25 +0,10	0,50
over 120 to 180	+0,45 +0,25	+0,28 +0,12	0,65
over 180 to 300	+0,45 +0,25	+0,35 +0,15	0,80
over 300 to 500	+0,55 +0,30	+0,45 +0,20	1,00

- 1) The average value for d_2 taken from a number of measurements shall not be greater than the value specified for d_2 plus the interference allowance.
- 2) The tolerance on d_2 (i.e. $d_{2max} - d_{2min}$) is to be determined by taking three or more measurements equally spaced around the circumference.

Production and Quality assurance

Final inspection standard

In accordance with our production standards and DIN 3761 Part 4.

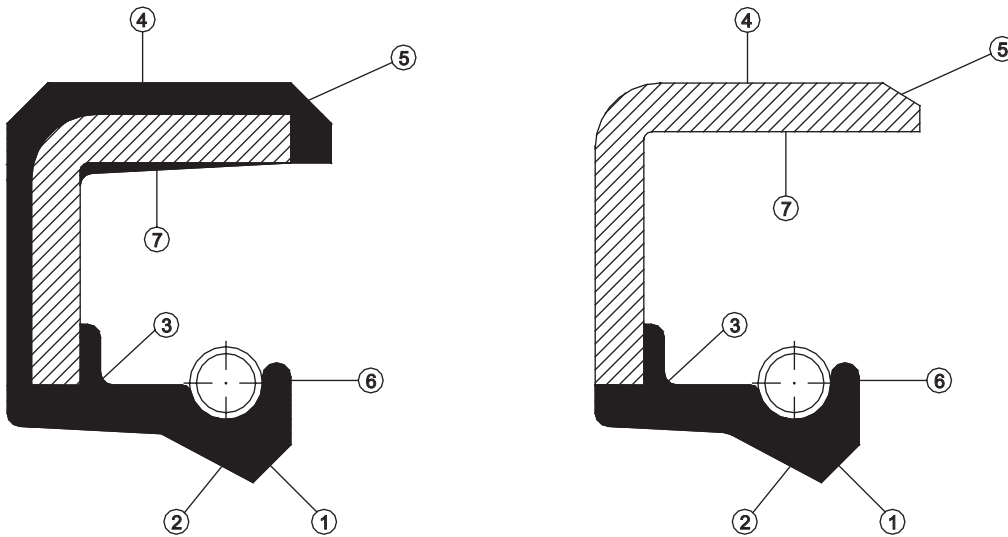

	Zone	Not permitted	Permitted
1+2	Contact band 1 = Front side 2 = Back side	Breaks in Sealing Edge	No fault permitted
3	Well of seal	Bond failures	
4	Seal O.D.	Fault which will affect the sealing on O.D.	Minor faults provided that at least 2/3 of the O.D. is unbroken at this point
5	Chamfer	Faults which will affect the installation of the seal	
6	Spring retention lip	Shortcomings could cause break	Small shortages
7	Inside wall	Free burrs	Burrs permitted if bonded or secured to the inside wall

The contact band width of the sealing lip is defined, according to DIN 3761 part 4, as follows:

Shaft diameter [mm]	Front band width [mm]	Back band width [mm]
up to 50	0,6	1,2
50 to 120	0,8	1,5
over 120	1	2



Types for special applications

Radiaseal®

Radiaseal® is a rotary shaft seal with a fabric reinforced body (outer diameter), rubber sealing lip and fitted with garter spring.

Radiaseal® has been designed as bearing seal for roll neck application of metal rolling mills, paper mills, heavy duty gear-boxes and for marine applications.

Radiaseal® has several advantages:

- accurate machining of housing bore is not essential;
- easy assembly;
- no corrosion problems;
- easy replacement.

There are different types of Radiaseal® in both endless or split version.

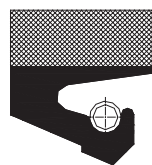

D5 Standard profile



D5S With additional dust lip

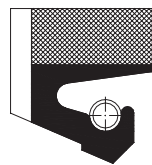

D6 With ports on the base, usually twin fitted back to back. An annular groove in the housing allows lubricant to pass around to the sealing lips

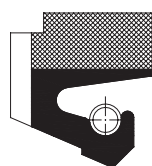

D7 With annular groove in addition to ports, allowing lubricant to pass around to the sealing lips. Usually twin fitted back to back



D5 PTFE Radiaseals® with PTFE covered sealing lip

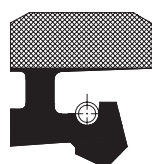

D5P This seal is designed for use in presence of pressure, up to max 0.6 [MPa]. The radial force on the shaft caused by the pressurized fluid is reduced and, as a consequence, there is a reduction of temperature. The absence of external metal avoids the possibility to damage the seal housing. This type of seal needs a retaining flange

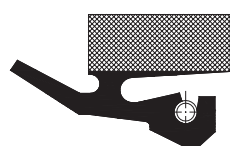

DXVT Produced with a high resistance rubberised fabric back, it allows a higher ring stiffness compared to normal seals. It is an alternative solution to avoid shavings pollution in case of underdimensioned or reduced metallic parts

Radiaseal® are produced with elastomers containing 3% PTFE. Standard stock materials are NBR and FPM. Upon request they are also available in HNBR, EPDM, SIL and with stainless spring AISI 302 (1.4300).

Types for special applications

Installation instructions

Shaft:

- tolerance ISO h11;
- surface finish roughness Ra 0.2 to 0.8 [μm];
- hardness of the shaft surface 55 HRC or more.

Housing:

- bore tolerance ISO H8;
- surface finish roughness Ra 1.6 to 6.3 [μm].

Radiaseal® is manufactured with oversized O.D. and the housing must be provided with retaining flange to give controlled axial compression to the seal, in order to correctly locate the seal in the housing, ensuring a good sealing on the O.D.

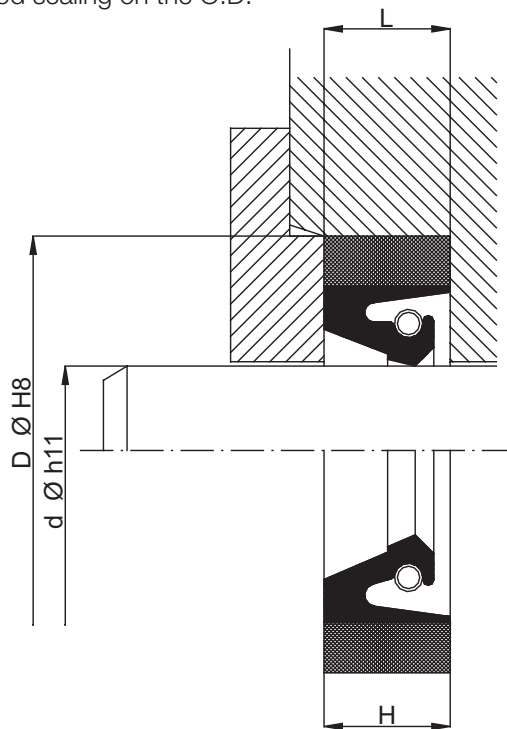

d = nominal shaft diameter
 D = nominal bore diameter
 H = shaft seal height
 L = nominal bore depth

A split Radiaseal® assembled to horizontal shaft should always be fitted with the split at the highest point of the shaft.

Where two split Radiaseals® are fitted together, the splits should be staggered at 30° on each side of the top.

The bore entrance and the shaft should be provided with lead-in chamfer to facilitate proper entrance of the seal into the cavity and to avoid lip damage. Length and angle of the chamfers should be designed according to drawing and table below.

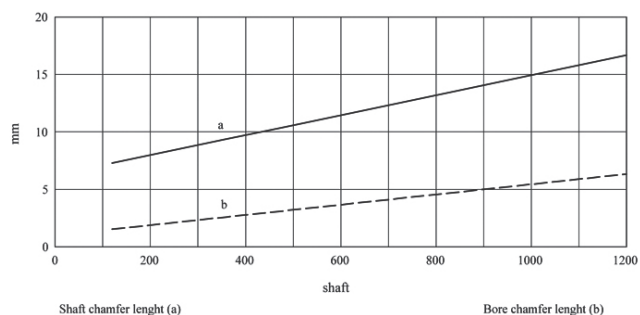
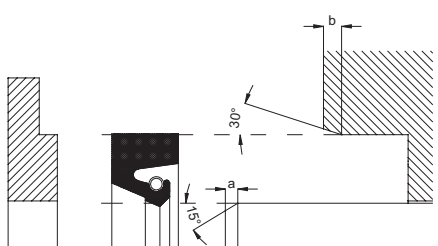

Types for special applications

Splitring®

Splitring® is a rotary shaft seal made of rubber only, split, fitted with stainless steel garter spring AISI 302 (1.4300).

Splitring® is used where a standard integral hard shaft seal cannot be fitted due to the presence of flanges or supports.

Splitring® can also be used to avoid high down-time costs.

They are produced in standard elastomer NBR. Other elastomers are available upon request.

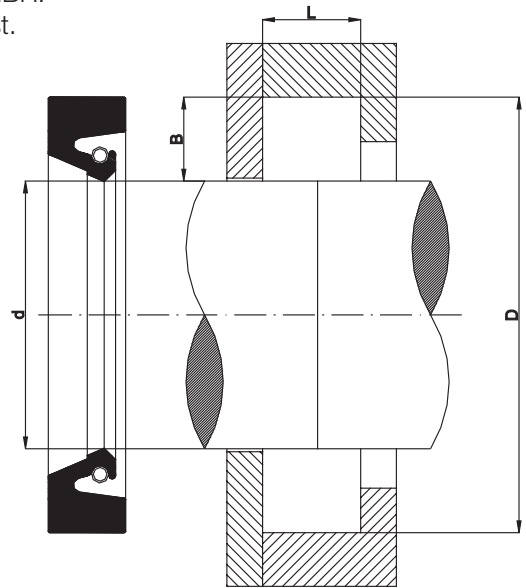

Installation instructions

Shaft tolerance ISO h11, surface finish max. roughness Rz 4 [μm], hardness of the shaft surface 55 HRC or more.

Housing bore according to table:

Shaft diameter [mm]	Bore diameter D tolerance [mm]	Bore diameter L tolerance [mm]
Up to 140	$\pm 0,12$	$\pm 0,05$
Over 140 up to 200	$\pm 0,15$	$\pm 0,07$
Over 200 up to 300	$\pm 0,15$	$\pm 0,10$
Over 300 up to 450	$\pm 0,20$	$\pm 0,12$
Over 450	$\pm 0,20$	$\pm 0,15$

Splitring® should be fitted with the split at the highest point of the shaft and should not be used where static fluid level is higher than the lowest point of the seal.

Clean the housing recess and remove all burrs and sharp edges.

Stretch the garter spring around the shaft and join it by screwing the conical end into the other and place the Splitring® around the shaft and stretch the spring into the groove on the sealing lip. Tight the Splitring® slightly against the shaft by pressing its outside diameter and insert the seal into the housing bore starting near to the split and working around the entire periphery until the Splitring® is completely inserted into the housing. The housing must be provided with retaining flange to give axial compression to the seal.

Types for special applications

DINA Seals

This is a specially designed rotary shaft seal which is used for needle bearing applications. DINA Seal is reinforced with steel insert and has a single thin lip without spring that has low frictional loss together with minimal interference. In order to better fit into the bore, DINA Seal has a wavy rubber outer diameter. DINA Seal can also be supplied with metal O.D.

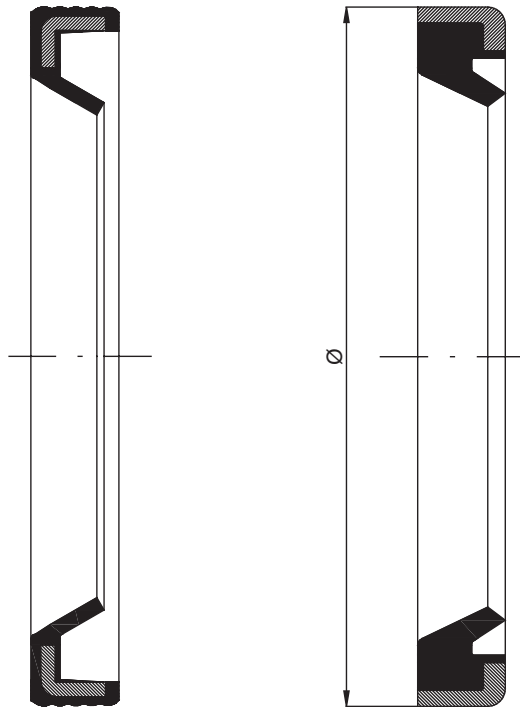

Standard DINA Seal materials are NBR elastomer and Carbon Steel insert. For special applications FPM and SIL elastomers and/or stainless steel insert are available upon request.

DINA Seal can be used to prevent lubricant leakage if mounted with the front face near to the needle bearing, or to protect the bearing from dust and dirt if mounted with the back face near to it.

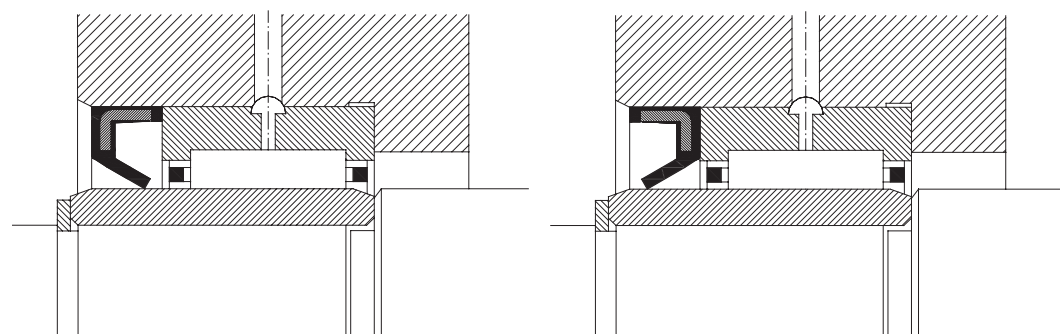

Types for special applications

C64D Seals

This seal is interchangeable with Garlock® 64 seal.

C64D shaft seal has been developed specifically for severe operating conditions in heavy industry. The performance and life of the seal in these conditions, involving important axial tolerances (shaft tolerances, shaft run out, non eccentricity and bearings clearance), are largely dependant upon the preload of the seal lip on the shaft.

C64D shaft seal has a very flexible sealing lip with a finger spring/garter spring combination that compensates shaft deviations without the need of changing the lip preload.

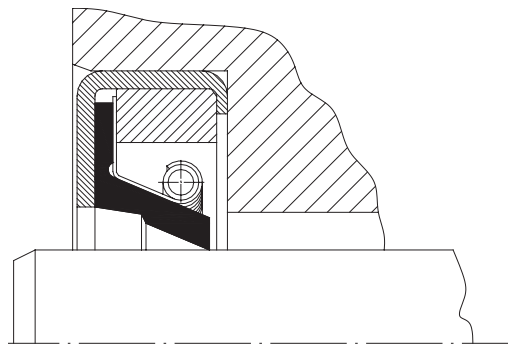

Seal construction

Garter spring

Material: AISI 302 (1.4300)

To provide a regulated loading on the sealing lip and enable the sealing element to follow shaft deflections.

Sealing lip

Compound: FPM, NBR, SIL

Stainless steel spring carrier

Material: ACX 260 AISI 316L 2D

Designed to ensure the spring retention during the assembly. If necessary to permit the removal and refitting of garter spring to provide a predetermined sealing lip preload which will permit the sealing element to follow shaft deflections.

Steel filler ring

Material: Fe 37

To provide the required rigidity and to ensure an accurate assembly of the seal in the groove.

Steel outer ring

Material: Fe-P04 (1.0338)

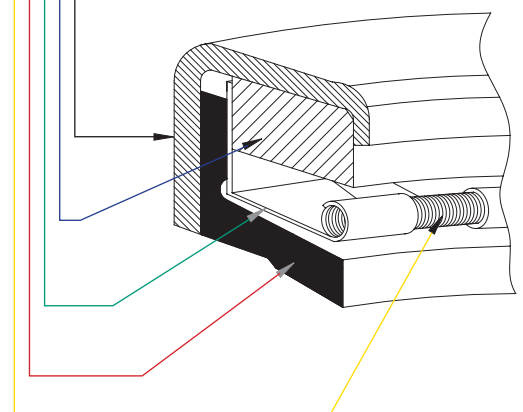

	FPM	SIL	NBR
Temperature [°C]	-20 / +220	-50 / +200	-30 / +120
Hardness [°ShA]	75	70	75
Max operating speed [m/s]	≤ 35	≤ 25	≤ 25

Storage and handling

Some storage precautions must be taken in order to avoid deterioration of the material. Rotary shaft seals should be stored in a dust free and dry atmosphere and they must be kept in their original wrapping which should only be opened just before installation. Samples should be repacked after inspection. Excessive humidity will deteriorate some elastomers as well as cause corrosive damage to metal casing and spring.

Do not drop rotary shaft seals on shelves or boxes, nor hang seals on hooks, wires or nails, since in either case the sealing lip can be damaged. Seals should be stored in a horizontal position. Seals should be used on a first-in first-out basis to avoid ageing on the shelf. Avoid storage near sources of heat or near electrical equipments that may generate ozone.

Also keep away from direct sunlight.

Shaft seals interchange table

DICHTA® types	A	AS	AS-P	A-O	A-DUO	B	BS	C	CS
Simrit-Freudenberg	BA	BASL	BABSL	BAOF	BADUO	B1	B1SL	B2	B2SL
Goetze	827N	827S	827SK	827NO	827D	822N	822S	824N	824S
Kako	DG	DGS	DGSP	DE	DGD	DF	DFS	DFK	DFSK
Simmerwerke	A	ASL		AOF	ADUO	B	BSL	C	CSL
Stefa	CB	CC	CF	CD	CK	BB	BC	DB	DC
Gaco	A	FA		SA	DUPLEX	ABI			
Pioneer Weston	R21	R23		R26	R22	R4	R6	R1	
Paulstra	IE	IEL		IO	IELR	EE	EEL	EEL	
Chicago Rawhide	HMS4	HMSA7				CRW1	CRWA1	CRWH1	CRWHA1
National	35	32				48	47	45	41
NOK	SC	TC	TCN	VC	DC	SB	TB	SA	TA
Dichtomatik	WA	WAS	WASY	WAO	WAD	WB	WBS	WC	WCS
FP	G	GP	GAP	GSM	G2	L1	L1P	L2	L2P

