



**TEREX®**

**ROUGH TERRAIN CRANE  
RT 130**

**MR. CRANE**

OPERATED CRANES / RIGGING  
ENGINEERING / SAFETY

**800.672.7263**

647 N. Hariton St., Orange, CA 92868

**www.mrcrane.com**

**DATASHEET - IMPERIAL**

**RT 130**











**Features:**

- ▶ Rated capacity:  
130 ton @ 10 ft working radius
- ▶ Maximum boom length:  
155 ft
- ▶ Maximum tip height:  
164 ft

**WORKS FOR YOU.™**

	Page:
<b>Key</b>	
.....	3
<b>Dimensions</b>	
Crane dimensions .....	4
Crane weights .....	5
Steering radii .....	6
<b>Load Charts</b>	
Range Diagram – Main Boom – Outriggers fully extended (100%) .....	8
Load Chart – Main Boom – Outriggers fully extended (100%) .....	9
Range Diagram – Main Boom – Outriggers half extended (50%) .....	10
Load Chart – Main Boom – Outriggers half extended (50%) .....	11
Range Diagram – Main Boom – 28.8 ft offsettable jib .....	12
Load Chart – Main Boom – 28.8 ft offsettable jib .....	13
Range Diagram – Main Boom – 54.9 ft offsettable jib .....	14
Load Chart – Main Boom – 54.9 ft offsettable jib .....	15
Range Diagram – Main Boom – 72.1 ft offsettable jib .....	16
Load Chart – Main Boom – 72.1 ft offsettable jib .....	17
Range Diagram – Main Boom – On tires .....	18
Load Chart – Pick & Carry .....	19
Range Diagram – Main Boom – Without Counterweight .....	20
Load Chart – Without Counterweight .....	21
<b>Technical Description</b>	
Boom .....	22
Hoist, rope and hook .....	22, 23
Superstructure .....	23
Cab, controls, operator aids and load limiter / load indicator .....	23
Carrier, engine, drive-line and hydraulic system .....	24
Vehicle performance .....	24
Tires .....	24
Other options .....	25









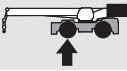
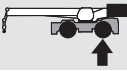
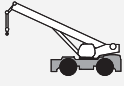
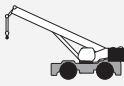

	Counterweight		General performance
	Main boom		Telescoping mode
	Boom length		Boom luffing angle
	Tip height		Working radius
	Boom with extension		Max. boom length with extension
	Main boom with aux head		Distance from the hook to the head sheave pin
	Slewing / Allowable slewing range		Slewing locked / Slewing locked at specified position
	Slewing brake		Slewing gears
	Outriggers / Lifting on outriggers (100/50/0% extended)		Lifting on wheels / Pick & Carry
	Main hoist		Auxiliary hoist
	Hoist speed		Rope length
	Rope – Standard / Optional		Max. line pull
	Rope diameter		Tire
	Hook block		Controls
	Cab		Engine
	Operator aids / Load limiter / Load indicator		Steering
	Mechanical transmission		Speed
	Hydraulics		Heating / Air conditioning
	Working temperature		Gradeability
	Lights		Gross vehicle weight
	Crane / Crane in standard configuration		Weight on front axle
	Crane without counterweight		Weight on rear axle



# CRANE WEIGHTS

RT 130

## Approximate Weights

			
	103,672 lb	69,136 lb	34,536 lb
	133,272 lb	57,411 lb	75,861 lb
<b>Add / Subtract for main crane configuration</b>			
 Stowed aside the boom	+4560 lb	+7416 lb	-2856 lb
	+130 lb	+358 lb	-228 lb
 Optional	221 lb	-50 lb	+2711 lb
 2 With standard rope	+659 lb	-253 lb	+912 lb
 2 With optional rope	221 lb	-97 lb	+318 lb
 7 sheaves, 130 ton hanging down from boom head	+2310 lb	+3889 lb	-1579 lb
 7 sheaves, 100 ton hanging down from boom head	+2120 lb	+3569 lb	-1449 lb
 5 sheaves, 75 ton hanging down from boom head	+1680 lb	+2707 lb	-1099 lb
 Hook ball, 12 ton (in tool box)	+722 lb	+749 lb	-27 lb

NOTE: Values are subject to 2% variation  
For complete list of list adds and subtracts refer to user manual

# STEERING RADII

RT 130

Two wheel steer

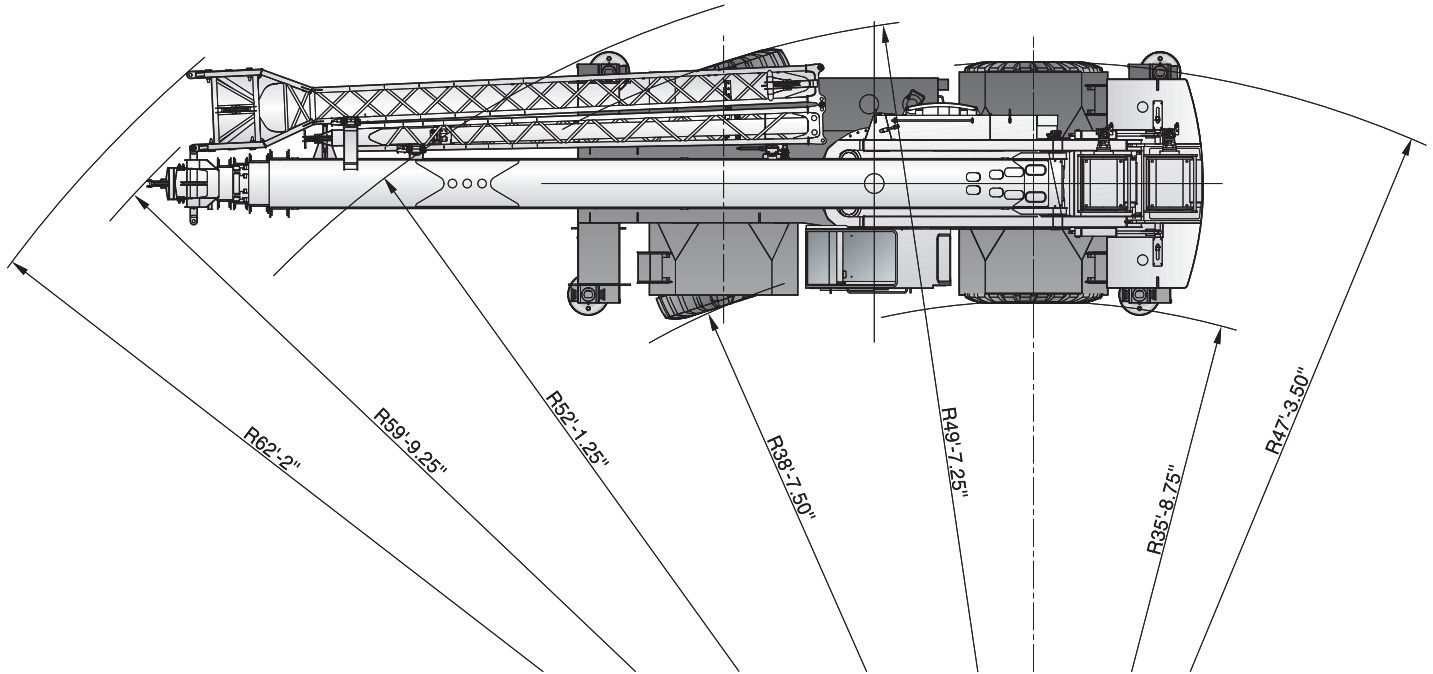

# STEERING RADII

RT 130

Four wheel steer

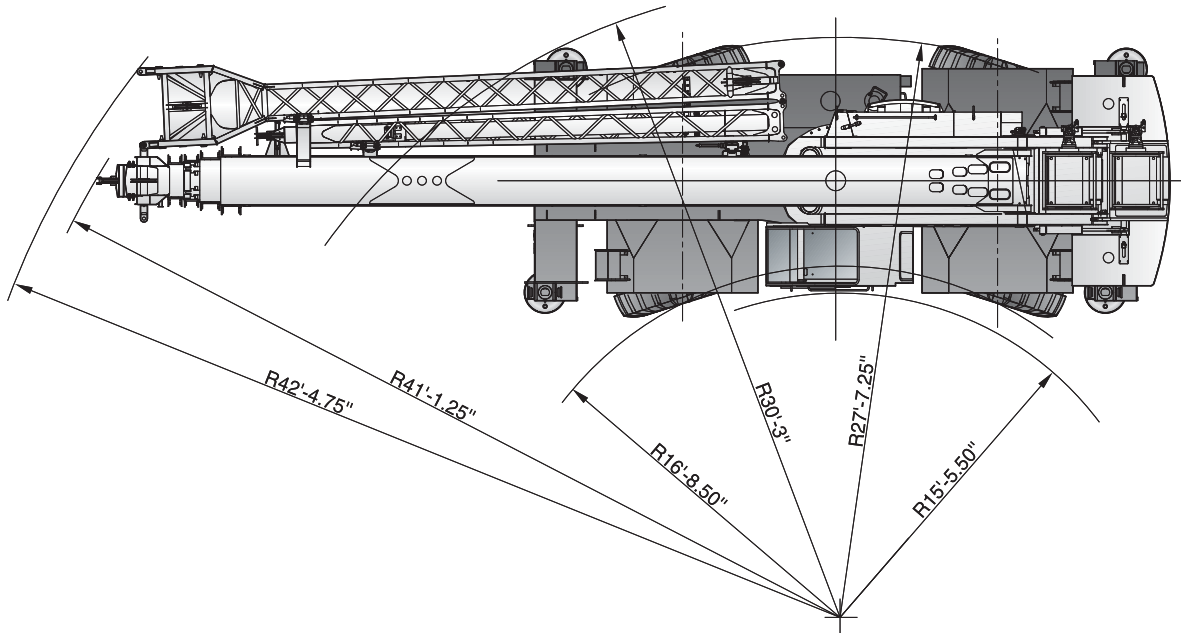

# RANGE DIAGRAM - MAIN BOOM

**RT 130**

## Outriggers Fully Extended (100%)

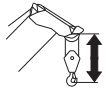
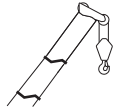

with hook ball: 7.5 ft  
with hook block: 10.0 ft

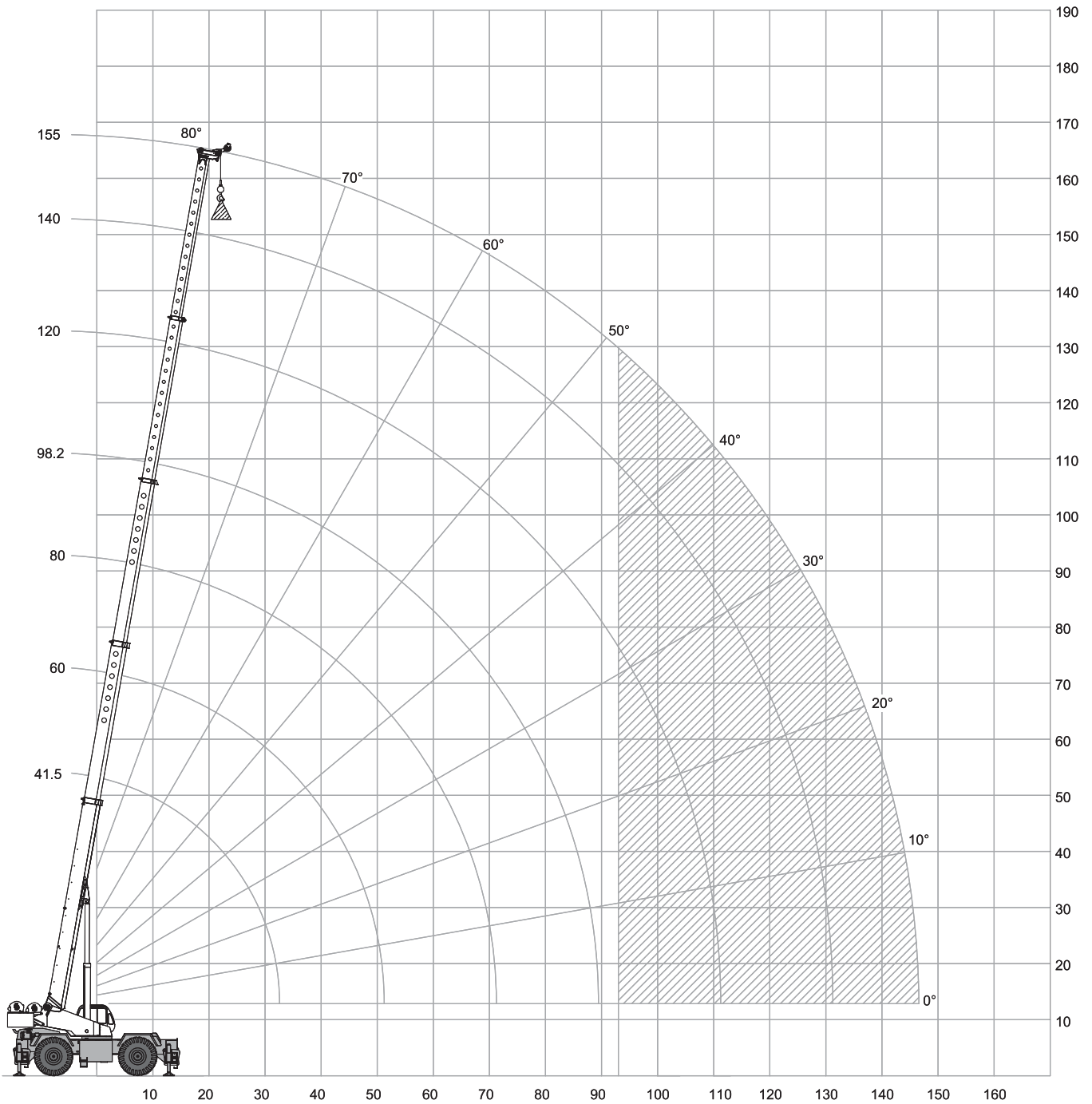



# LOAD CHART – MAIN BOOM

**RT 130**

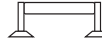

## Outriggers Fully Extended (100%)

 29,600 lbs

 26 ft (100%)

 360°

Standard ASME  
B30.5

	Boom Length							
	41.5 ft	60 ft	80 ft	100 ft	120 ft	140 ft	155 ft	
ft	lbs	lbs	lbs	lbs	lbs	lbs	lbs	ft
10	260,000							10
12	199,700	150,000						12
15	169,500	150,000	107,200					15
20	131,900	130,200	105,500	85,000				20
25	105,900	104,300	88,000	71,400	60,900			25
30	86,800	89,500	75,100	60,900	52,700	42,800		30
35		66,600	65,200	53,100	45,800	39,400	30,000	35
40		57,700	50,700	46,600	40,600	35,600	26,800	40
45		46,500	41,300	41,700	36,000	31,800	25,200	45
50		37,900	33,500	36,000	32,200	28,800	23,600	50
55			29,900	30,000	29,000	26,000	22,000	55
60			27,800	25,200	26,600	23,500	20,400	60
65			25,200	21,400	22,900	21,300	18,700	65
70			21,600	18,400	19,700	19,400	17,200	70
75				17,000	17,000	17,700	15,900	75
80				15,800	14,700	15,700	14,700	80
85				14,700	12,700	13,800	13,800	85
90				13,800	11,200	12,000	12,600	90
95					10,500	10,800	11,100	95
100					9,800	10,100	9,800	100
105					9,200	9,500	8,600	105
110					8,400	8,600	7,500	110
115						7,600	6,500	115
120						6,600	5,600	120
125						5,700	4,800	125
130						4,900	4,000	130
135							3,300	135
140							2,600	140
145							2,000	145

Mode 1 Optimized for best capacities on longer radius

Mode 2 Optimized for best capacities on short radius

### Notes to lifting capacity

Lifting capacities do not exceed 85% of tipping load. Weight of hook blocks and slings is part of the load, and is to be deducted from the capacity ratings. Consult operation manual for further details.

Note: Data published herein is intended as a guide only and shall not be construed to warrant applicability for lifting purposes. Crane operation is subject to the computer charts and operation manual both supplied with the crane.

# RANGE DIAGRAM - MAIN BOOM

**RT 130**

## Outriggers Half Extended (50%)

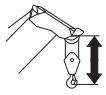
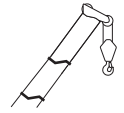

with hook ball: 7.5 ft  
with hook block: 10.0 ft

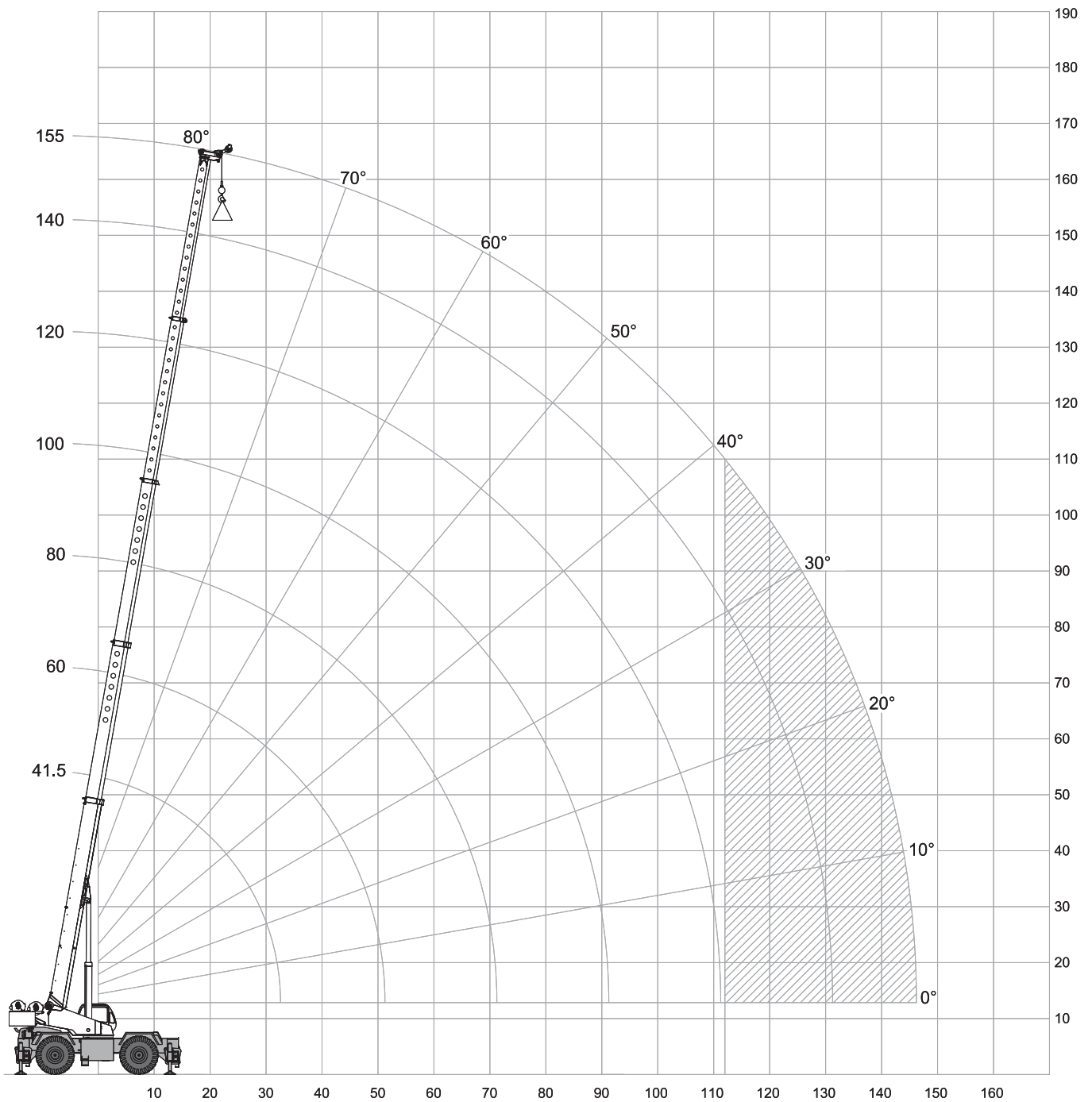

# LOAD CHART – MAIN BOOM

**RT 130**

## Outriggers Half Extended (50%)

 29,600 lbs

 18.1 ft (50%)

 360°

Standard ASME  
B30.5

	Boom Length							
	41.5 ft	60 ft	80 ft	100 ft	120 ft	140 ft	155 ft	
ft	lbs	lbs	lbs	lbs	lbs	lbs	lbs	ft
10	212,700							10
12	186,000	150,000						12
15	155,100	150,000	107,200					15
20	108,100	103,800	105,100	85,000				20
25	69,600	73,600	67,200	70,200	60,900			25
30	48,600	53,100	51,600	49,900	51,700	42,800		30
35		40,500	42,300	37,500	39,100	39,400	30,000	35
40		31,800	33,700	31,900	30,600	31,800	26,800	40
45		25,300	27,500	28,500	24,500	25,600	25,200	45
50		20,200	22,800	23,800	21,500	22,000	21,900	50
55			19,000	20,100	19,400	19,600	18,300	55
60			15,800	17,100	16,800	16,600	15,300	60
65			13,200	14,600	14,300	14,200	12,900	65
70			11,000	12,500	12,300	12,100	10,900	70
75				10,700	10,500	10,400	9,200	75
80				9,100	9,000	8,900	7,700	80
85				7,600	7,700	7,600	6,400	85
90				6,300	6,500	6,400	5,300	90
95					5,400	5,400	4,200	95
100					4,400	4,500	3,400	100
105					3,500	3,700	2,600	105
110					2,700	2,900		110

**Mode 1** Optimized for best capacities on longer radius

**Mode 2** Optimized for best capacities on short radius

## Notes to lifting capacity

Lifting capacities do not exceed 85% of tipping load. Weight of hook blocks and slings is part of the load, and is to be deducted from the capacity ratings. Consult operation manual for further details.

Note: Data published herein is intended as a guide only and shall not be construed to warrant applicability for lifting purposes. Crane operation is subject to the computer charts and operation manual both supplied with the crane.

# RANGE DIAGRAM - MAIN BOOM

**RT 130**

**With Jib, 28.8 ft offset**

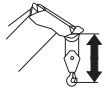
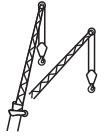

with hook ball: 7.5 ft  
with hook block: 10.0 ft

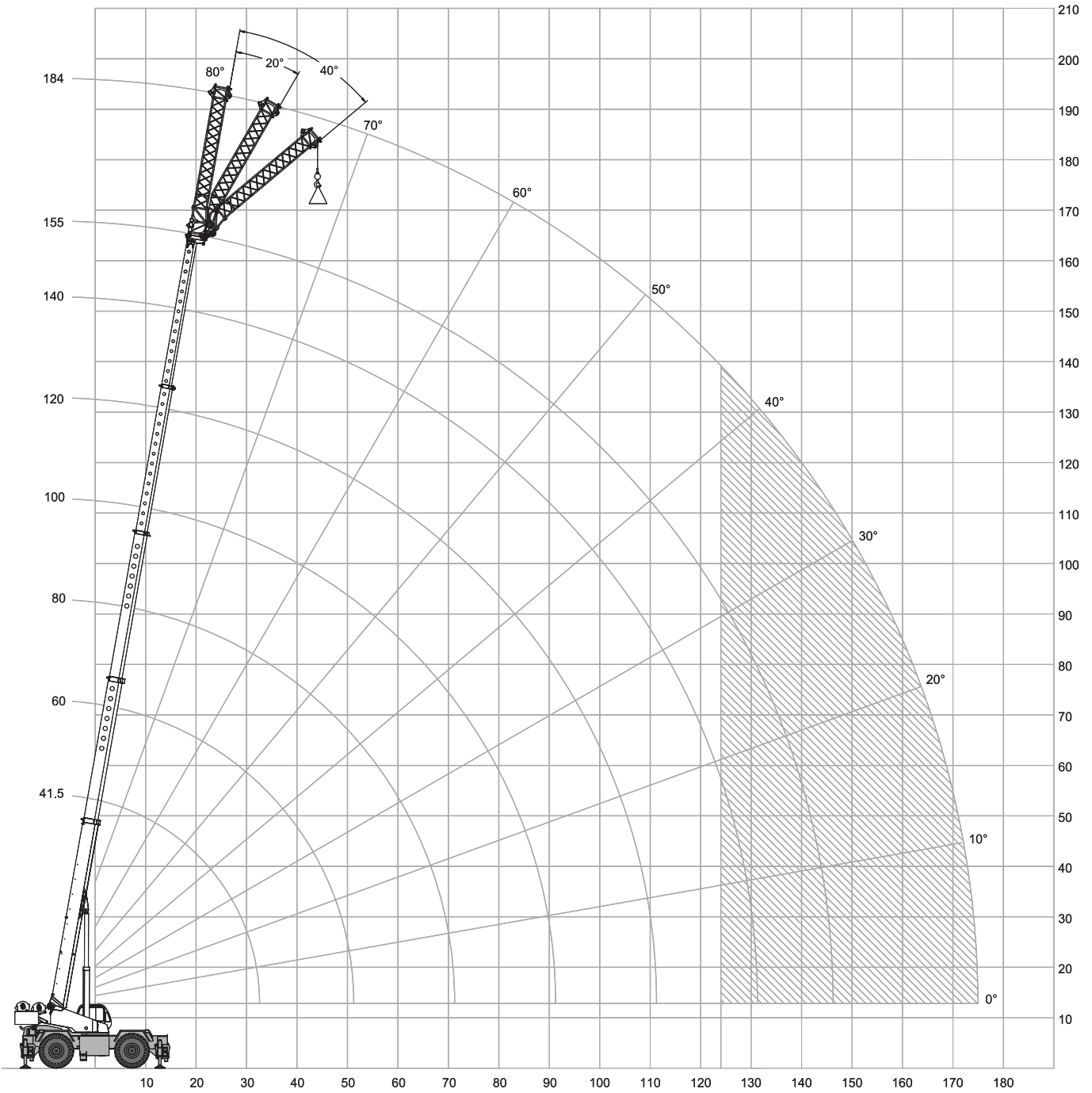

# LOAD CHART – MAIN BOOM

**RT 130**



**With Jib, 28.8 ft offset**

 29,600 lbs

 26 ft (100%)

 360°

Standard ASME  
B30.5

28.8 ft Offsettable Jib					
0°		20°		40°	
 ft	lbs	 ft	lbs	 ft	lbs
49	16,100	59	15,000	66	12,200
57	15,200	66	13,300	72	11,500
64	14,500	73	11,900	77	10,700
71	12,900	79	10,800	83	9,800
81	11,000	88	9,400	91	8,700
90	9,600	96	8,400	99	7,800
98	8,500	104	7,500	106	7,200
106	7,600	111	6,900	113	6,500
115	6,700	120	6,100	122	5,800
124	5,800	129	5,400	131	5,200
133	4,500	136	4,300	138	4,000
138	3,600	141	3,600		
148	2,400	151	2,300		
156	1,500	159	1,400		

## Notes to lifting capacity

Lifting capacities do not exceed 85% of tipping load. Weight of hook blocks and slings is part of the load, and is to be deducted from the capacity ratings. Consult operation manual for further details.

Note: Data published herein is intended as a guide only and shall not be construed to warrant applicability for lifting purposes. Crane operation is subject to the computer charts and operation manual both supplied with the crane.

# RANGE DIAGRAM - MAIN BOOM

**RT 130**

**With Jib, 54.9 ft offset**

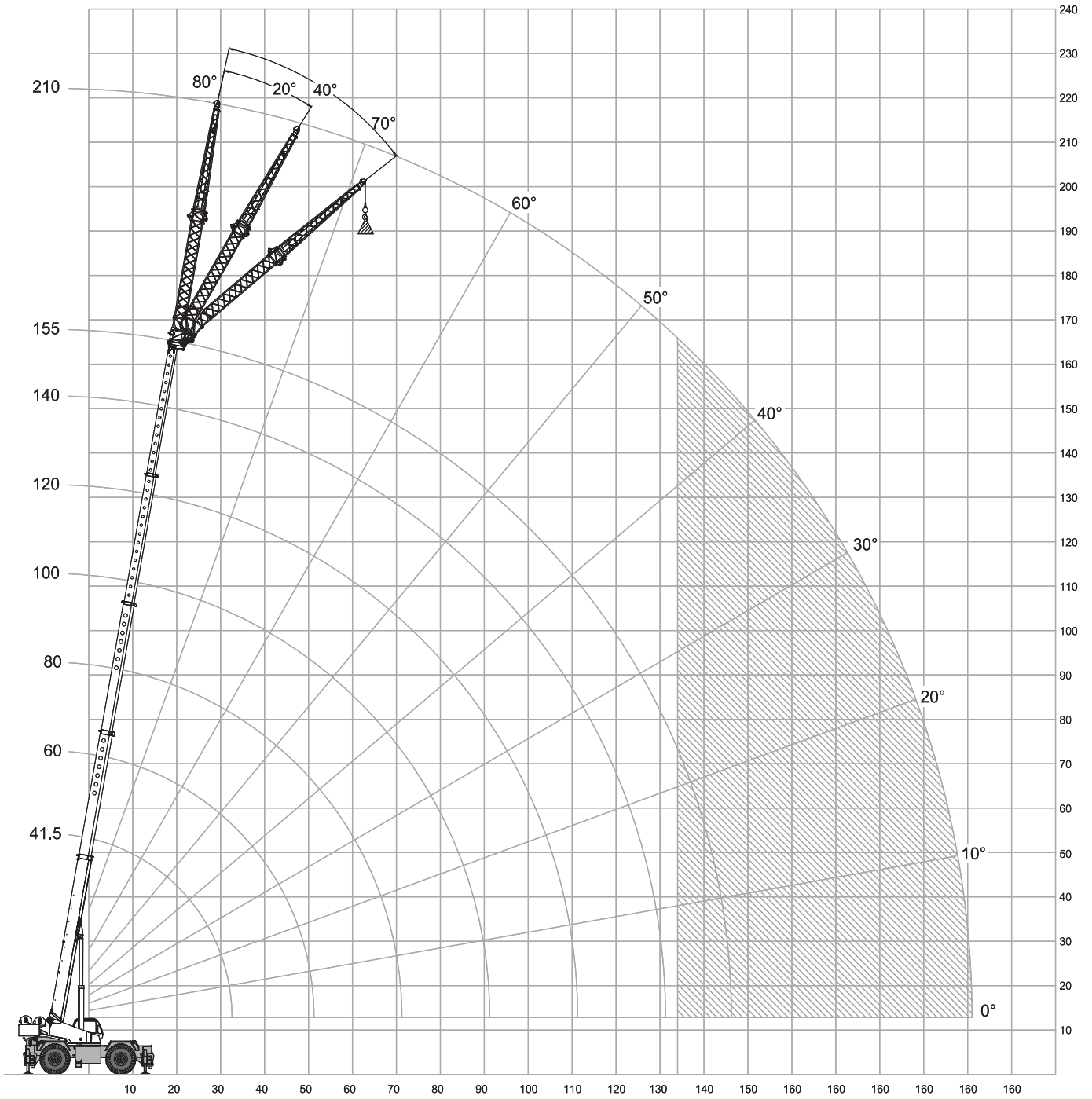
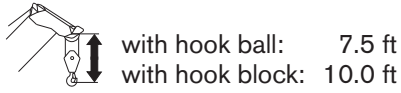
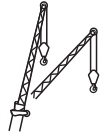

# LOAD CHART – MAIN BOOM

**RT 130**

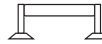

**With Jib, 54.9 ft offset**

 29,600 lbs

 26 ft (100%)

 360°

Standard ASME  
B30.5

54.9 ft Offsettable Jib					
0°		20°		40°	
 ft	lbs	 ft	lbs	 ft	lbs
55	8,700	73	6,900	87	5,600
63	8,200	80	6,500	93	5,300
71	7,700	87	6,200	99	5,000
79	7,300	94	5,800	106	4,700
91	6,600	105	5,200	114	4,300
103	5,900	116	4,600	123	3,900
114	5,200	126	4,100	131	3,500
125	4,500	135	3,600	139	3,100
136	3,700	145	3,100	149	2,600
145	2,800	154	2,600	158	2,200
154	1,800	161	1,700	167	1,600
159	1,100	167	1,100		

## Notes to lifting capacity

Lifting capacities do not exceed 85% of tipping load. Weight of hook blocks and slings is part of the load, and is to be deducted from the capacity ratings. Consult operation manual for further details.

Note: Data published herein is intended as a guide only and shall not be construed to warrant applicability for lifting purposes. Crane operation is subject to the computer charts and operation manual both supplied with the crane.

# RANGE DIAGRAM - MAIN BOOM

**RT 130**

**With Jib, 72.1 ft offset**

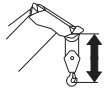
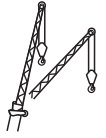

with hook ball: 7.5 ft  
with hook block: 10.0 ft

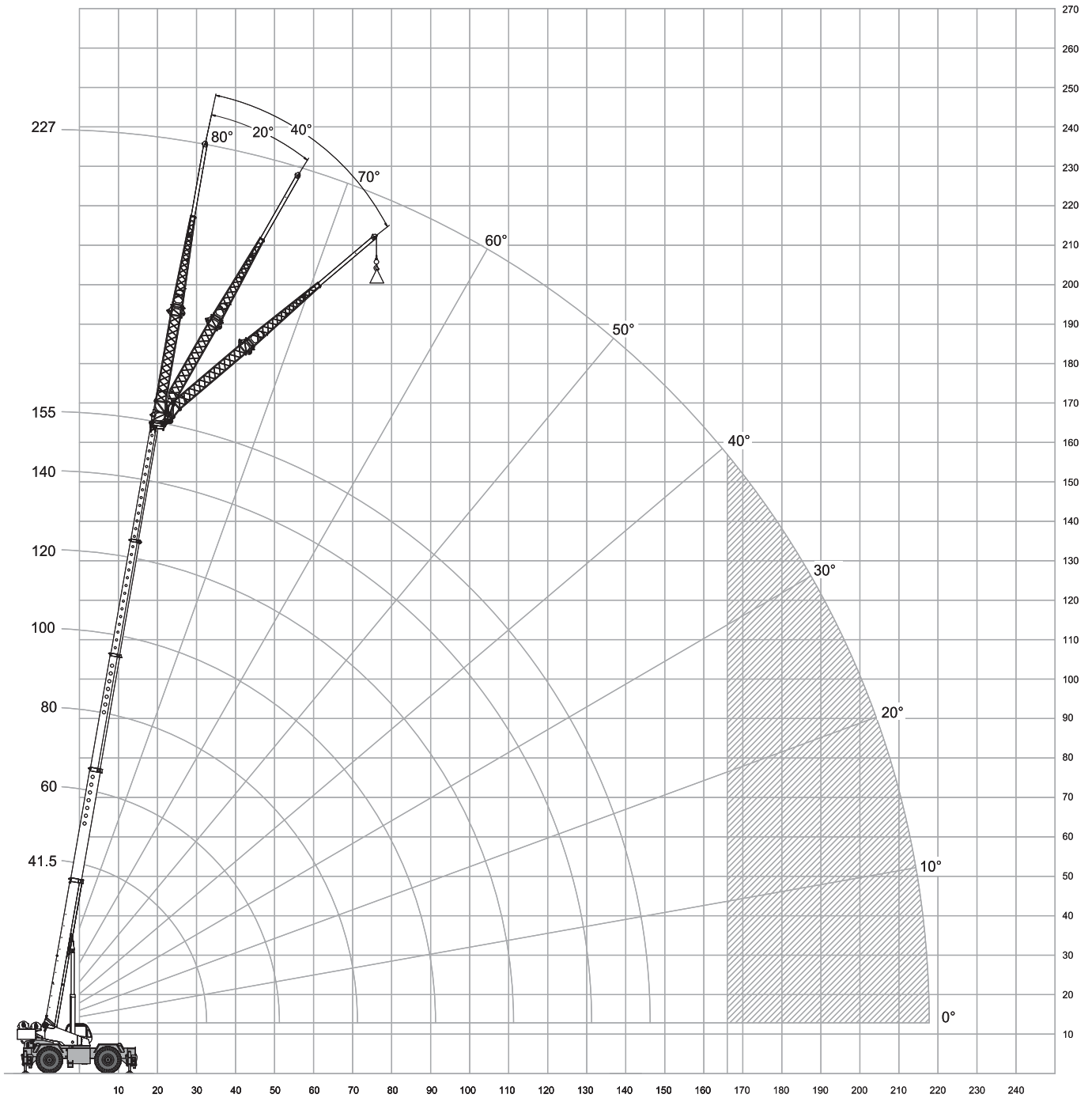



# LOAD CHART – MAIN BOOM

**RT 130**



**With Jib, 72.1 ft offset**

 29,600 lbs

 26 ft (100%)

 360°

Standard ASME  
B30.5

72.1 ft Offsettable Jib					
0°		20°		40°	
 ft	lbs	 ft	lbs	 ft	lbs
61	6,700	84	5,100	102	4,000
70	6,300	93	4,700	108	3,800
79	5,900	100	4,500	114	3,600
88	5,500	107	4,200	120	3,400
100	5,000	118	3,800	129	3,100
113	4,500	129	3,400	138	2,800
124	4,000	139	3,000	146	2,500
135	3,500	149	2,700	153	2,300
148	3,000	161	2,200	163	2,000
159	2,500	171	1,900	172	1,700
169	1,800	179	1,400	181	1,400
175	1,100				

## Notes to lifting capacity

Lifting capacities do not exceed 85% of tipping load. Weight of hook blocks and slings is part of the load, and is to be deducted from the capacity ratings. Consult operation manual for further details.

Note: Data published herein is intended as a guide only and shall not be construed to warrant applicability for lifting purposes. Crane operation is subject to the computer charts and operation manual both supplied with the crane.

# RANGE DIAGRAM - MAIN BOOM

**RT 130**

## On Tires

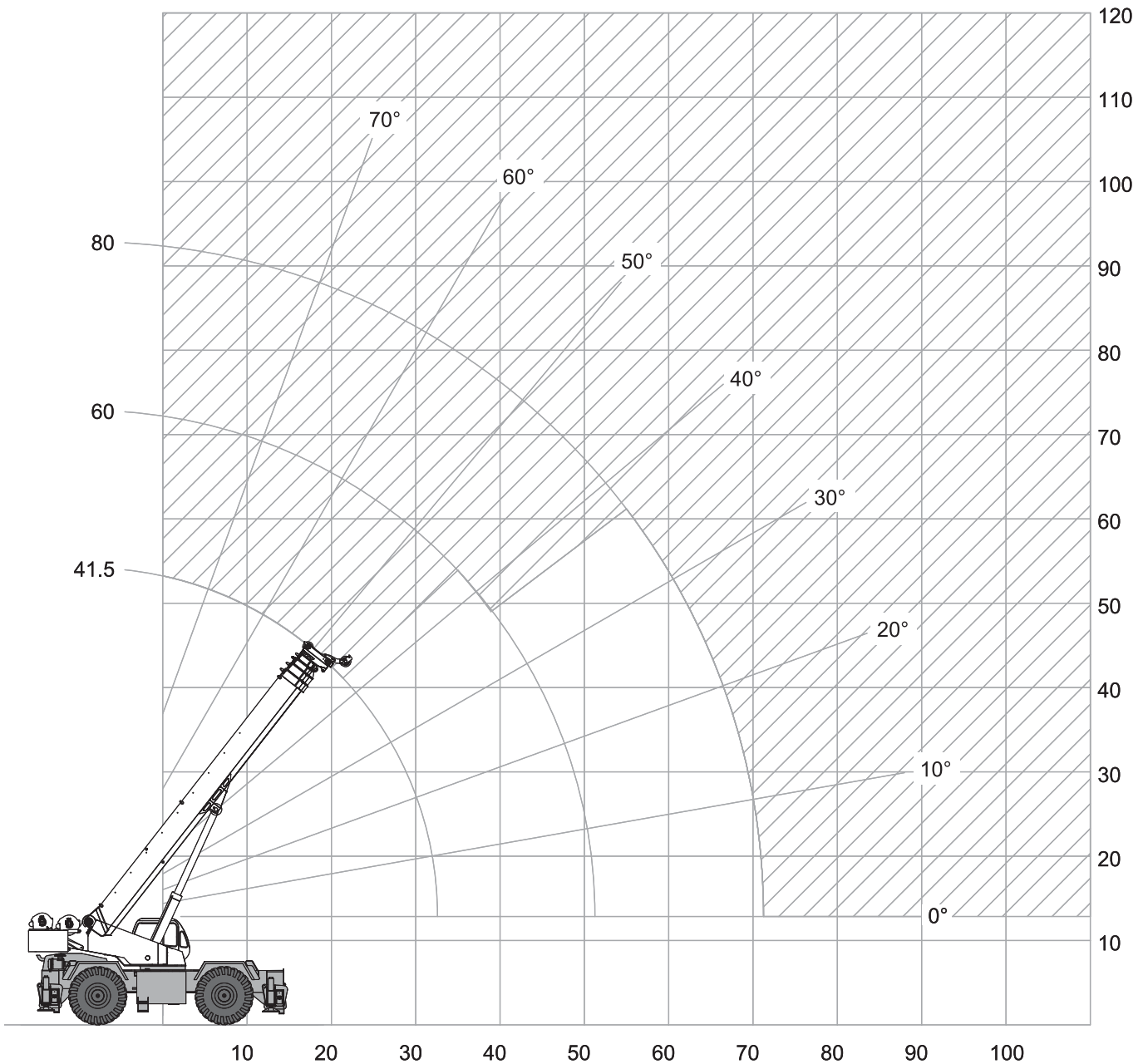
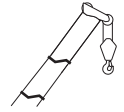
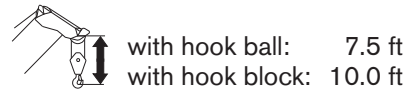

# LOAD CHART – PICK & CARRY

**RT 130**

 29,600 lbs



Standard ASME  
B30.5

Boom		360 degree rotation	Travel Speed Boom straight over front	
Radius	Length		0 mph	Creep
ft	ft	lbs	lbs	lbs
20	42	62,600	57,100	47,600
25	42	50,900	42,300	34,700
30	42	42,500	32,500	26,300
35	60	23,400	23,400	23,400
40	60	20,800	20,800	19,600
45	60	18,400	18,400	15,800
50	60	16,200	16,200	12,800
55	80	14,100	14,100	12,300
60	80	12,200	12,200	10,200
65	80	10,400	10,400	8,300
70	80	8,800	8,800	6,800

## Notes to lifting capacity

Lifting capacities do not exceed 85% of tipping load. Weight of hook blocks and slings is part of the load, and is to be deducted from the capacity ratings. Consult operation manual for further details.

Note: Data published herein is intended as a guide only and shall not be construed to warrant applicability for lifting purposes. Crane operation is subject to the computer charts and operation manual both supplied with the crane.

# RANGE DIAGRAM - MAIN BOOM

RT 130

## Without Counterweight

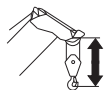
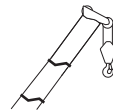

with hook ball: 7.5 ft  
with hook block: 10.0 ft

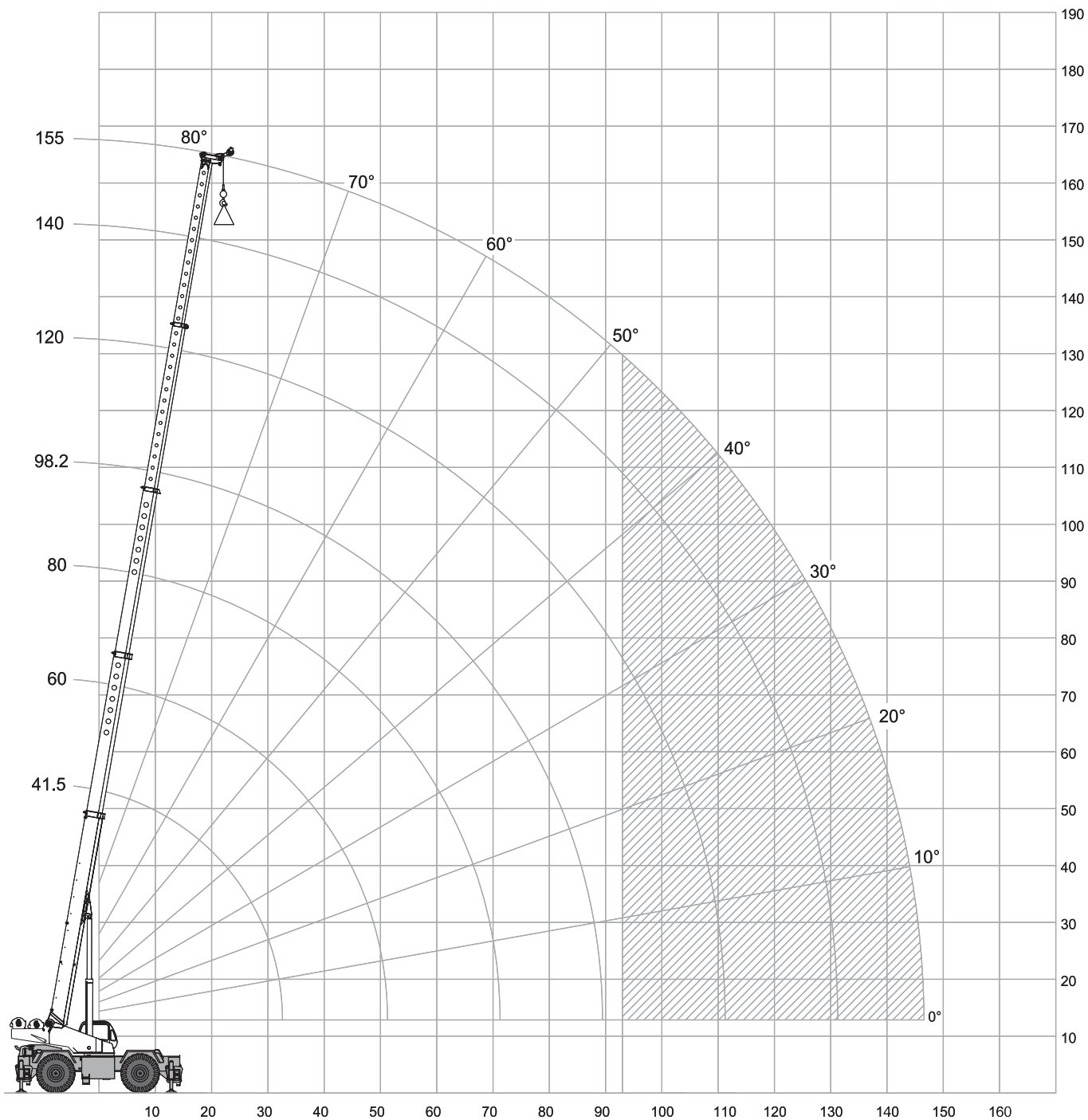

# LOAD CHART

**RT 130**

## Without Counterweight



Standard ASME  
B30.5









	Boom Length							
	41.5 ft	60 ft	80 ft	100 ft	120 ft	140 ft	155 ft	
ft	lbs	lbs	lbs	lbs	lbs	lbs	lbs	ft
10	214,200							10
12	187,700	110,000						12
15	156,500	110,000	77,500					15
20	119,700	99,100	67,800	53,100				20
25	84,100	88,900	59,400	47,300	37,700			25
30	54,300	59,300	51,600	41,200	34,300	33,700		30
35	42,000	42,800	45,000	36,000	30,000	30,600	30,000	35
40		32,400	34,900	31,900	26,900	27,500	26,800	40
45		25,100	27,200	28,400	24,000	24,500	25,200	45
50		19,400	21,900	23,000	21,500	22,000	21,100	50
55		17,700	17,800	18,900	18,600	18,500	17,100	55
60			14,600	15,700	15,400	15,300	13,900	60
65			11,900	13,100	12,800	12,700	11,300	65
70			9,500	10,900	10,700	10,500	9,200	70
75			8,700	9,100	8,900	8,800	7,500	75
80				7,600	7,300	7,200	6,000	80
85				6,100	6,000	5,900	4,700	85
90				4,800	4,800	4,800	3,500	90
95				4,300	3,800	3,600	2,500	95
100					2,900	2,600	1,700	100
105					2,000	1,700	900	105
110					1,100	900		110

### Notes to lifting capacity



Lifting capacities do not exceed 85% of tipping load. Weight of hook blocks and slings is part of the load, and is to be deducted from the capacity ratings. Consult operation manual for further details.

Note: Data published herein is intended as a guide only and shall not be construed to warrant applicability for lifting purposes. Crane operation is subject to the computer charts and operation manual both supplied with the crane.

## Boom

		Standard configuration:
	5 sections full power	
	Mode 1: optimized for best capacity on longer radius Mode 2: optimized for best capacity on short radius	
	Min. / Max.	41.5 ft / 155 ft
	Max. tip height main boom	164 ft
	Boom elevation angle range (min. / max.) Boom raising / lowering time Boom extension / retraction time	-3° / +80° 70 s / 100 s 115 s / 106 s
		Optional:
	Single sheave Tip height – boom fully retracted / boom fully extended	54 ft / 165 ft
	Lattice type, side stow, bi-fold Pullout extension Angular offsets	28.8 ft / 54.9 ft 17.2 ft 0° / 20° / 40°
	With one jib section With two jib sections With two jib sections and pullout	184 ft 210 ft 227 ft
	With one jib section With two jib sections With two jib sections and pullout	193 ft 218 ft 235 ft

## Hoist, Rope and Hook





		Standard configuration:
	Two speeds Grooved drum Storage capacity	1239 ft
	Maximum without load	453 ft / min
		Optional:
	Type: XIPS, IWRC, Right Regular Lay	
		0.75 in
		850 ft
	Min. breaking strength Max. line pull permissible	58800 lbs 16800 lbs
	35 x 7 rotation resistant compacted strand	
		0.75 in
		850 ft

# TECHNICAL DESCRIPTION





**RT 130**

	Min. breaking strength Max. line pull permissible	84000 lbs 16800 lbs
	Two speeds Grooved drum Storage capacity	1239 ft
	Maximum without load	453 ft / min
	Top swivel hook ball with latch 5 metallic sheaves 7 metallic sheaves 7 metallic sheaves	12 ton 75 ton 100 ton 130 ton





## Superstructure

	<b>Standard configuration:</b> Weight Pinned to frame and hydraulically mounted / removed	14.8 ton
	Non stop Maximum speed without load	360° 1.5 rpm
	Hydraulic motor Planetary reducer	
	360° House lock Foot pedal actuated Possibility to set up a partial and constant braking force	



## Cab, Controls, Operator aids and Load limiter / Load indicator

	<b>Standard configuration:</b> Sliding door on the left side Sliding window on the right side Hinged, tinted all glass skylight Removable front windshield Six way adjustable seat
	Armrest mounted dual axis electro-proportional joysticks Controls for hoist and hoist rotation indicator, slewing, boom elevation Foot controls for boom telescoping, swing brake and engine throttle Steering wheel column mounted controls for gear shifting Dashboard mounted switches for steering mode, outriggers
	Electronic load indicator and limiter with graphic interface
	<b>Optional:</b> Air conditioning and LP heater Air conditioning / heat pump and LP heater LP heater

## Carrier, Engine, Drive-line and Hydraulic system

Standard configuration:	
	<p>Hydraulic independent:</p> <ul style="list-style-type: none"> <li>100 % extended outrigger footprint area 693.3 ft<sup>2</sup></li> <li>50 % extended outrigger footprint area 483.9 ft<sup>2</sup></li> <li>0 % extended outrigger footprint area 283.3 ft<sup>2</sup></li> <li>Floating ground bearings diameters (area) 24 in (452 in<sup>2</sup>)</li> <li>Single outrigger jack extending and retracting time 28 s</li> <li>Single outrigger beam extending and retracting time 11 s</li> <li>Access steps to the deck from any side</li> </ul>
	<p>Cummins QSC-300 6 cylinders</p> <ul style="list-style-type: none"> <li>Rated power 300 HP @ 2200 rpm</li> <li>Maximum gross torque 1000 ft·lb @ 1400 rpm</li> <li>Intake: turbocharged with intercooler</li> <li>Fuel type Diesel</li> <li>Fuel tank capacity 80 gallons</li> </ul>
	<ul style="list-style-type: none"> <li>6 x 3 powershift with torque converter</li> <li>4WD if traveling in 1<sup>st</sup> or 2<sup>nd</sup> gears forward or reverse</li> <li>Rigid mounted front axle</li> <li>Oscillating mounted rear axle</li> <li>Automatic rear axles oscillation lock when superstructure is swung by 10° from centerline in either directions</li> <li>Pneumatic service brakes</li> </ul>
	<ul style="list-style-type: none"> <li>3 modes hydraulic power steering</li> <li>Front wheels mode – minimum steering curb clearance radius 50.1 ft</li> <li>All wheels concentric steering mode – minimum steering curb clearance radius 28.2 ft</li> <li>All wheels crab steering mode</li> </ul>
	<ul style="list-style-type: none"> <li>Gear pump for main and auxiliary winch</li> <li>Gear pump for boom hoisting and telescoping</li> <li>Gear pump for steering, outriggers and slewing</li> <li>Hydraulic oil tank capacity 304 gallons</li> <li>Hydraulic oil filters 250 μm</li> </ul>
Optional:	
	<ul style="list-style-type: none"> <li>Engine oil heater</li> <li>Hydraulic oil heater</li> <li>Battery heater</li> </ul>

## Vehicle performance

Standard configuration:	
	<ul style="list-style-type: none"> <li>Max. in 1<sup>st</sup> gear 145.6 %</li> <li>Max. in 6<sup>th</sup> gear 4.9 %</li> </ul>
	<ul style="list-style-type: none"> <li>Max. (6<sup>th</sup> gear) 20.4 mph</li> </ul>
	<ul style="list-style-type: none"> <li>Max. +125 °F</li> <li>Min. -20 °F</li> </ul>

## Tires

Standard configuration:	
	<ul style="list-style-type: none"> <li>Wide earth moving style tread (E3) 33.25x29-32 PR</li> </ul>





**[www.terexcranes.com](http://www.terexcranes.com)**

Effective Date: October 2010.

Product specifications and prices are subject to change without notice or obligation. The photographs and/or drawings in this document are for illustrative purposes only. Refer to the appropriate Operator's Manual for instructions on the proper use of this equipment. Failure to follow the appropriate Operator's Manual when using our equipment or to otherwise act irresponsibly may result in serious injury or death. The only warranty applicable to our equipment is the standard written warranty applicable to the particular product and sale and Terex makes no other warranty, express or implied. Products and services listed may be trademarks, service marks or trade-names of Terex Corporation and/or its subsidiaries in the USA and other countries. All rights are reserved. Terex® is a registered trademark of Terex Corporation in the USA and many other countries.

Copyright 2010 Terex Corporation

Terex Cranes, Global Marketing, Dinglerstraße 24, 66482 Zweibrücken, Germany  
Tel. +49 (0) 6332 830, Email: [info.cranes@terex.com](mailto:info.cranes@terex.com), [www.terexcranes.com](http://www.terexcranes.com)

---

***MR. CRANE***

---

**OPERATED CRANES / RIGGING  
ENGINEERING / SAFETY****800.672.7263**

647 N. Hariton St., Orange, CA 92868

**[www.mrcrane.com](http://www.mrcrane.com)**

---

**WORKS FOR YOU.™**