

Roundabout Planning, Design, and Operations Manual

December 2015

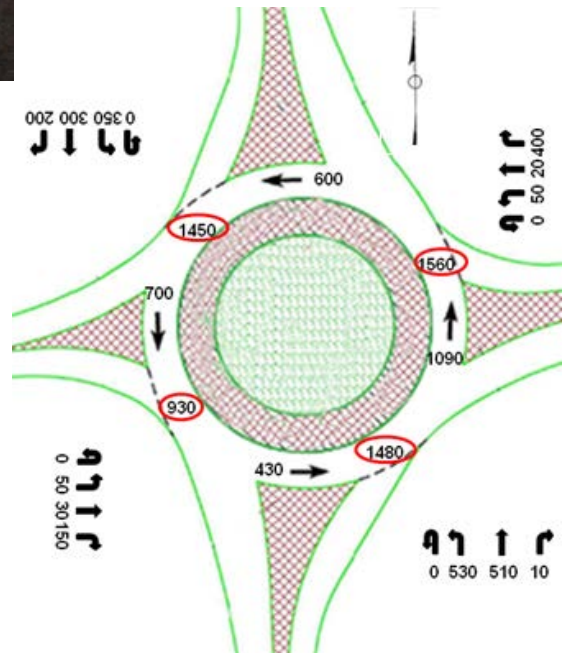
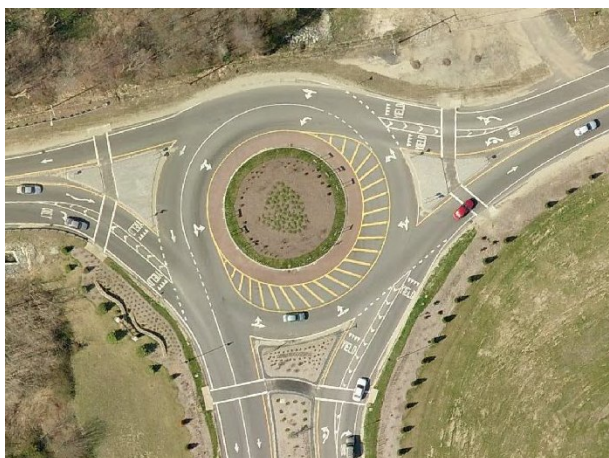
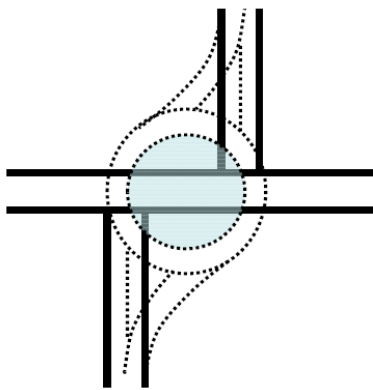

Alabama Department of Transportation

ROUNDBOUT PLANNING, DESIGN, AND OPERATIONS MANUAL

December 2015

Prepared by:

The University Transportation Center for of Alabama

Steven L. Jones, Ph.D.
Abdulai Abdul Majeed

Steering Committee

Tim Barnett, P.E., ALDOT Office of Safety Operations
Stuart Manson, P.E., ALDOT Office of Safety Operations
Sonya Baker, ALDOT Office of Safety Operations
Stacey Glass, P.E., ALDOT Maintenance
Stan Biddick, ALDOT Design
Bryan Fair, ALDOT Planning
Steve Walker, P.E., ALDOT R.O.W.
Vince Calametti, P.E., ALDOT 9th Division
James Brown, P.E., ALDOT 2nd Division
James Foster, P.E., Mobile County
Clint Andrews, Federal Highway Administration
Blair Perry, P.E., Gresham Smith & Partners
Howard McCulloch, P.E., NE Roundabouts

DISCLAIMER

This manual provides guidelines and recommended practices for planning and designing roundabouts in the State of Alabama. This manual cannot address or anticipate all possible field conditions that will affect a roundabout design. It remains the ultimate responsibility of the design engineer to ensure that a design is appropriate for prevailing traffic and field conditions.

TABLE OF CONTENTS

| | |
|--|------|
| 1. Introduction | |
| 1.1. Purpose | 1-5 |
| 1.2. Scope and Organization..... | 1-7 |
| 1.3. Limitations..... | 1-7 |
| 1.4. Organization..... | 1-7 |
| 1.5. References..... | 1-8 |
| 2. Planning | |
| 2.1. Planning Level Assessments | 2-1 |
| 2.2. Operational Analysis Procedures | 2-8 |
| 2.3. System Considerations | 2-18 |
| 2.4. Roundabout Safety | 2-18 |
| 2.5. References..... | 2-20 |
| 3. Geometric Design | |
| 3.1. Design Principles | 3-1 |
| 3.2. Design Process..... | 3-2 |
| 3.3. Design Vehicle and Vehicle Swept Path..... | 3-4 |
| 3.4. Design Speed | 3-5 |
| 3.5. Size, Position, and Alignment of Approaches..... | 3-6 |
| 3.6. Design Considerations | 3-8 |
| 3.7. Design Procedures for Single-lane and Multilane Roundabouts | 3-21 |
| 3.8. Performance Checks..... | 3-43 |
| 3.9. Pedestrian and Cyclist Treatments..... | 3-51 |
| 3.10. Grading..... | 3-55 |
| 3.11. Crossfalls | 3-55 |
| 3.12. Drainage | 3-56 |
| 3.13. Roundabout Access Management | 3-58 |
| 3.14. References..... | 3-59 |
| 4. Traffic Control | |
| 4.1. Pavement Markings | 4-1 |
| 4.2. Signing..... | 4-5 |
| 4.3. References..... | 4-8 |
| 5. Lighting | |
| 5.1. Key Items to Consider | 5-1 |
| 5.2. Lighting Levels | 5-1 |
| 5.3. Lighting Location | 5-2 |
| 5.4. References..... | 5-5 |

| | |
|---|-----|
| 6. Landscaping | |
| 6.1. Central Island Landscaping | 6-2 |
| 6.2. Splitter Island and Approach Landscaping | 6-4 |
| 6.3. References..... | 6-5 |
| 7. Construction | |
| 7.1. Construction Plans | 7-1 |
| 7.2. Construction Staging..... | 7-1 |
| 7.3. Work Zone Traffic Control | 7-1 |
| 7.4. Construction Coordination..... | 7-2 |
| 7.5. Public Education | 7-2 |
| 8. Maintenance | |
| 8.1. Landscaping Maintenance | 8-1 |
| 8.2. Snow/Ice Removal | 8-1 |
| 8.3. Pavement Maintenance and Rehabilitation | 8-2 |
| 8.4. References..... | 8-7 |

Appendix – Design Techniques

Chapter 1

Introduction

A modern roundabout is one of three types of circular intersections. Circular intersections include rotaries, neighborhood traffic circles, and modern roundabouts. There are significant differences among the three types of circular intersections. Rotaries have the largest diameters, more perpendicular angles at the approaches, higher circulatory speed limits, and often no defined priority rule for circulatory traffic over entering traffic. Neighborhood traffic circles are often built on local roadways for traffic calming purposes. They include a raised center island and raised channelization. Approach deflection is rarely used and often they cannot accommodate large trucks. Modern roundabouts, on the other hand, are characterized by yield control at entry, counterclockwise circular movement for all traffic around a central island, channelized approaches, and special geometric features that create a low-speed environment. The three different types are presented in [Figure 1.1](#), [Figure 1.2](#) and [Figure 1.3](#), respectively.



Figure 1.1 – Rotary Intersection (Source: NCHRP 672)



Figure 1.2 – Neighborhood Traffic Circles (Source: NCHRP 672)



Figure 1.3 – Modern Roundabout (Source: Google data © Google 2015, Kingston, NY)

The basic principle, “yield at entry”, forces drivers approaching the circular intersection to yield at each approach entry if an acceptable gap is not available to enter the circulating roadway. In this manual, the term “Roundabouts” is used to refer to modern roundabouts. Key characteristic features of a typical modern roundabout are shown [Figure 1.4](#) and described in [Table 1.1](#).

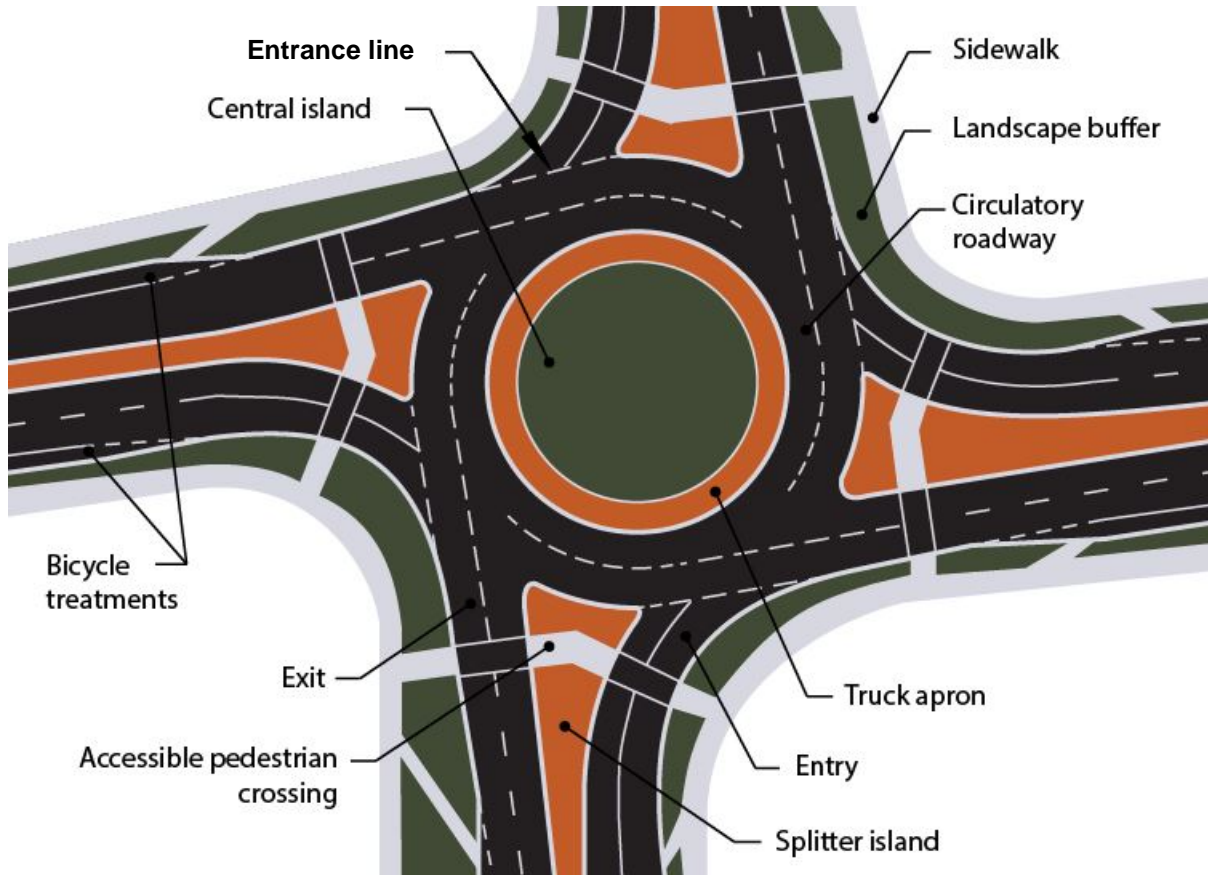

Figure 1.4 – Key Roundabout Characteristics

This manual focuses on two categories of roundabouts according to size and number of entry/circulatory lanes: single-lane and multilane (two or more entering lanes) roundabouts. [Table 1.2](#) summarizes some fundamental design and operational elements for each category and [Figure 1.5](#) shows the typical features of the respective roundabouts.

- Single-lane roundabouts are characterized as having a single-lane entry at all legs and one circulatory lane. They have large inscribed circle diameters and non-traversable central islands. The size of the roundabout is largely influenced by the choice of design vehicle and available right-of-way. The geometric design typically includes raised splitter islands, a non-traversable central island, crosswalks, and include truck aprons surrounding the non-traversable part of the central island to accommodate large vehicles.
- Multilane roundabouts have at least one approach entry with two or more circulatory lanes. In some cases, the roundabout may have different number of lanes on one or multiple approaches. Circulatory lanes may also have various sections with single or multiple lanes or a number of matching lanes with the entry lanes. The geometric design typically includes raised splitter islands, truck aprons, a non-traversable central island, and appropriate entry path

deflection and include truck aprons surrounding the non-traversable part of the central island to accommodate large vehicles.

TABLE 1.1 Key Roundabout Features (Source: NCHRP 672¹)

| Roundabout Feature | Description |
|---------------------------------|--|
| Central island | The central island is the raised area in the center of a roundabout around which traffic circulates. The central island does not necessarily need to be circular in shape and could typically be drainage / snow depressed area. |
| Splitter island | A splitter island is a raised or painted area on an approach used to separate entering from exiting traffic, deflects and slows entering traffic, and typically provides pedestrians a refuge area to cross the road in two stages. |
| Circulatory roadway | The circulatory roadway is the curved path used by vehicles to travel in a counterclockwise fashion around the central island. |
| Truck apron | A truck apron is the traversable portion of the central island adjacent to the circulatory roadway that may be needed to accommodate the rear wheel tracking of large vehicles. An apron is sometimes provided on the outside of the circulatory roadway for the same purpose. |
| Entrance/Yield lines | The entrance line marks the point of entry into the circulatory roadway. It is a physical extension of the circulatory roadway edge line but functions as a yield line in the absence of a separate yield line. Entering vehicles must yield to any circulating traffic coming from the left before crossing this line into the circulatory roadway. Yield lines are optional and may be used to supplement the yield control of entrance lines (see Section 3C of MUTCD, 2009A YIELD word pavement marking may also be used at the entrance to supplement the YIELD sign. |
| Accessible pedestrian crossings | For roundabouts designed with pedestrian pathways, the crossing location is typically set back from the entrance line, and the splitter island is typically cut to provide refuge for pedestrians, wheelchairs, strollers, and bicycles to pass through. The pedestrian crossings must be accessible with detectable warnings and appropriate slopes in accordance with ADA requirements. |
| Landscape buffer | Landscape strips separate vehicular and pedestrian traffic and assist with guiding pedestrians to the designated crossing locations. This feature is particularly important as a way finding clue for individuals who are visually impaired. Landscape strips can also significantly improve the aesthetics of the intersection and provide surface for mounting signs as well. |
| Entry | The horizontal curve of the approach roadway that leads vehicles into the circulatory roadway. It is critical to have driver entering to have clear view to the left across splitter island toward the circulatory traffic approaching. If possible, at location of yield line, a sight distance angle of approximately 90 degree from vehicle's trajectory into the circulatory lane to the left approaching vehicles should be available. |
| Exit | The horizontal curve of the departure roadway that leads vehicles out of the circulatory roadway. It is critical to have unobstructive viewing angles that allows exiting driver to see pedestrians crossing crosswalk area. |
| Sidewalk | Sidewalks provide pathway for pedestrians to walk. In the urban environment, it is common to provide a shared-use path to accommodate all non-motorized vehicles including pedestrians and cyclists. |
| Bicycle treatments | Provide transitions from bicycle lanes to allow cyclists to either ride through the roundabout with vehicles or exit through ramps on to the sidewalk. |

A detailed description of each roundabouts type and characteristic features is provided in the National Cooperative Highway Research Program Report 672, *Roundabouts: An Informational Guide, 2nd Edition*¹ (referred to herein as *NCHRP 672*). This ALDOT document specifically addresses single-lane and multilane (two circular lanes) roundabouts at at-grade intersections. For the design of other roundabouts, reference should be made to [NCHRP 672](#)¹.

Roundabouts have demonstrated substantial safety and operational performance over other forms of intersection control. FHWA identified roundabouts as one of nine safety countermeasures recognized and supported by FHWA in the 2008 release of *Guidance Memorandum on Consideration and Implementation of Proven Safety Countermeasures*⁴ stating:

“Roundabouts are the preferred safety alternative for a wide range of intersections. Although they may not be appropriate in all circumstances, they should be considered as an alternative for all proposed new intersections on federally-funded highway projects, particularly those with major road volumes less than 90 percent of the total entering volume. Roundabouts should also be considered for all existing intersections that have been identified as needing major safety or operational improvements. This would include freeway interchange ramp terminals and rural intersections.”

As such, some states (e.g. Louisiana, Georgia, and New York) have made policy changes requiring roundabout to be considered as a design alternative to all other intersection options at new and retrofitted/redesigned or reconstructed intersections.

TABLE 1.2 Characteristics of Single-Lane and Multilane Roundabout (NCHRP 672¹)

| Design Element | Single-Lane Roundabout | Multilane Roundabout |
|--|--------------------------------|--------------------------------|
| Desirable maximum entry design speed | 20 to 25 mph | 25 to 30 mph |
| Maximum number of entering lanes per approach | 1 | 2+ |
| Typical inscribed circle diameter | 110 to 180 ft | 150 to 230 ft |
| Central island treatment | Raised with traversable aprons | Raised with traversable aprons |
| Typical intersection ADT on 4-leg roundabouts. ADT volumes lower than shown may operate without requiring detailed capacity analysis | Up to approx. 25,000 ADT | Up to approx. 45,000 ADT |

1.1 Purpose

This document, the *Alabama Department of Transportation Roundabout Planning, Design, and Operations Manual* (referred to herein as the Roundabout Manual) is to serve as the official document to provide guidance for the design and operation of roundabouts in the State of Alabama. It is to provide road designers, planners, policy makers and contractors with guidance on planning, design, construction, operations and maintenance of roundabouts in the State of Alabama. It is intended to ensure consistency across the State in the implementation of roundabouts at new installations and to provide safe and efficient traffic operations in the case of retrofit/redesign or reconstruction of existing intersections. Local agencies may adopt this manual as guidance for locally funded projects.

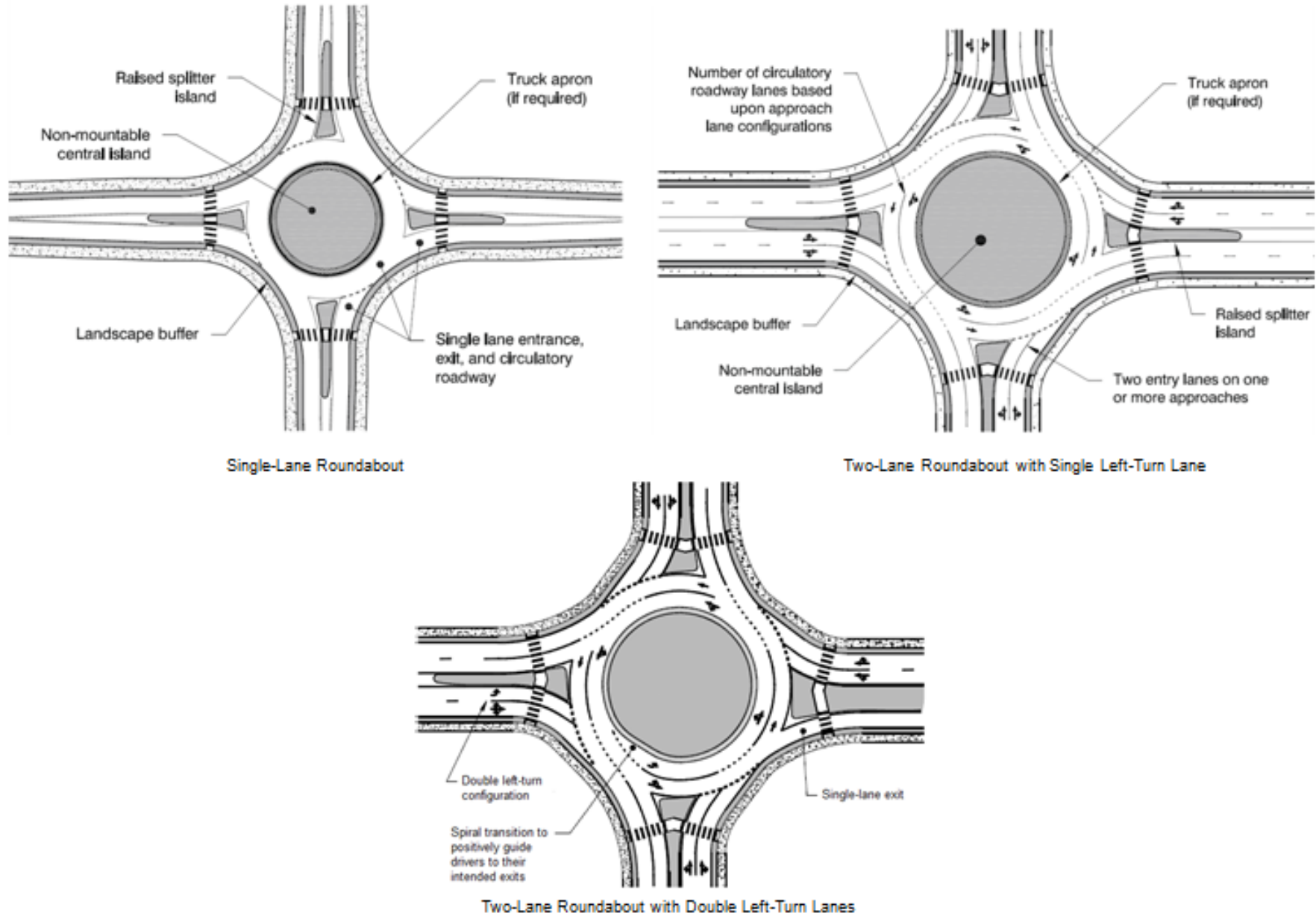

Figure 1.5 – Single-lane and Multilane Roundabout Categories (NCHRP 672¹)

1.2 Scope and Organization

This Manual provides information on roundabout design and operation at different levels, each targeting a specific user audience:

- Planning level: engineers, planners, and policymakers;
- Design level: engineers;
- Construction level: engineers, construction crews, contractors;
- Operation and maintenance level: engineers, traffic technicians, and maintenance personnel.

This Manual sets out design principles and procedures to be considered for selecting and assessing the appropriateness of a roundabout. It considers treatment for the accommodation of cyclists and pedestrians and other related topics such as pavement markings, signs, and landscaping. [NCHRP 672](#)¹, adopted as the national reference document in many states, is the main reference for this Manual. Whenever necessary, the user of this Manual should refer to the [NCHRP 672](#)¹ for detailed information. When there is a discrepancy between the recommendations in [NCHRP 672](#)¹ and the information presented in this Manual, the guidance in this Manual will take precedence.

This Roundabout Manual applies to roundabout design elements and should therefore be used in conjunction with other guidelines:

- [Alabama Department of Transportation Access Management Manual](#)
- [Alabama Department of Transportation Traffic Signal Timing and Design Manual](#)
- [AASHTO: A Policy on Geometric Design of Highways and Streets](#)²
- [Manual of Uniform Traffic Control Devices \(MUTCD\)](#)³

1.3 Limitations

The material in this Manual is based on knowledge, experiences and good practices gained over the years in other states and abroad. ALDOT will update this Manual as needed to reflect changing practices and experience gained locally. It is the responsibility of the user of this Manual to check the ALDOT website periodically for updates to this Manual.

1.4 Organization

The Roundabout Manual is organized as follows:

Chapter 1 - Introduction: This chapter provides an introduction to the manual and discusses the scope and limitations to the guide.

Chapter 2 - Roundabout Planning: This chapter provides justification for roundabouts at signalized and unsignalized at-grade intersections. It gives guidance on safety performance of roundabouts. Public participation and education are also discussed here.

Chapter 3 - Geometric Design: This chapter provides guidance on the method and parameters to be used in the geometric design of roundabouts for positioning of signs, landscaping, poles, and other roadside furniture. It also discusses drainage requirements and provides special consideration for pedestrian and cyclist treatments.

Chapter 4 - Traffic Control Devices: This chapter discusses traffic signing, and pavement markings.

Chapter 5 – **Roundabout Lighting**: This chapter discusses general principles and guidance on lighting, recommendations for setting of light furniture and equipment types.

Chapter 6 - **Landscaping**: This chapter presents recommendations for landscaping and the selection, design and siting of fixed objects at and around roundabouts.

Chapter 7 - **Construction**: This chapter discusses construction staging and work zone traffic control.

Chapter 8 - **Maintenance**: This chapter provides information on maintenance of landscaping and special provision of watering systems and drainage systems in the central island of roundabouts

1.5 References

1. Rodegerdts, L., J. Bansen, C. Tiesler, J. Knudsen, E. Myers, M. Johnson, M. Moule, B. Persaud, C. Lyon, S. Hallmark, H. Isebrands, R. B. Crown, B. Guichet and AO. *NCHRP Report 672: Roundabouts: An Informational Guide*. 2nd ed. (Transportation Research Board of the National Academies, ed.). Washington D.C; 2010. Available at: http://onlinepubs.trb.org/onlinepubs/nchrp/nchrp_rpt_672.pdf.
2. American Association of State and Highway Transportation Officials (AASHTO). *A Policy on Geometric Design of Highways and Streets*. 6th ed. Washington D.C; 2011. Available at: www.transportation.org.
3. Federal Highway Administration (FHWA). *Manual on Uniform Traffic Control Devices (MUTCD)*. 2009th ed. (FHWA, ed.). Washington D.C; 2012. Available at: http://mutcd.fhwa.dot.gov/pdfs/2009/pdf_index.htm.
4. Lindley, J., *Guidance Memorandum on Consideration and Implementation of Proven Safety Countermeasures*, FHWA, Washington D.C., July 2008.

Chapter 2

Planning

The initial steps in the consideration of a proposed roundabout begin with a planning level assessment. Defining the preliminary configuration for a proposed roundabout at an intersection requires an estimate of some of the design parameters and operational characteristics. The selected layout configuration (single-lane or multilane configuration) must be checked to ascertain its operational efficiency and safety performance. This should be followed by a side-by-side comparison of other alternatives to determine whether or not a roundabout is the most preferred alternative considering safety, operational, economic and environmental benefits. The alternatives evaluated should include all appropriate conventional intersection forms, such as a two-way stop control, all-way stop control, and/or signal control.

2.1 Planning Level Assessments

2.1.1 Roundabout Justification

Designers and planners shall consider roundabouts as a first priority when evaluating intersection options for any site with entering average annually daily traffic (AADT) of 45,000 vehicles per day or less. Particular attention shall be given to roundabouts at sites where the following conditions exist:

- At intersections that record high incidences of crashes both in terms of frequency and severity.
- On corridors where turn proportions (particularly left turns) at intersections are heavy and difficult to achieve good progression without additional through lanes were they to be signalized.
- On major arterials or state highways where left and U-turns are required for trucks. This becomes especially important where there are right-of-way constraints and providing left and U-turns for large trucks result in potential property impacts.
- On interchanges (e.g. diamond interchange) where it may be required to provide turning opportunities to traffic turning to and from ramps without needing more lanes for match-up speeds on through lanes. This may help maintain existing bridge dimensions.
- At gateway intersections and on ceremonial streets, roundabouts may offer speed reduction and landscaping opportunities and may also provide aesthetic appeal.

- At intersections with difficult skew angles of approaches, with five or more approach legs, or staggered intersections.
- At closely spaced intersections, roundabouts can potentially reduce queues and balance traffic flows.

2.1.2 Planning Level Lane Requirement Estimation

Annual Average Daily Traffic (AADT) volumes may be used to predict the possible number of circulating lanes required for planning level consideration. Figure 2.1 presents a conservative procedure for estimating the number of lanes required for the proposed roundabout at the planning level given the AADTs on each approach. The percentage of left-turns on any given approach can be estimated from an origin-destination (O/D) survey and used to improve the estimate.

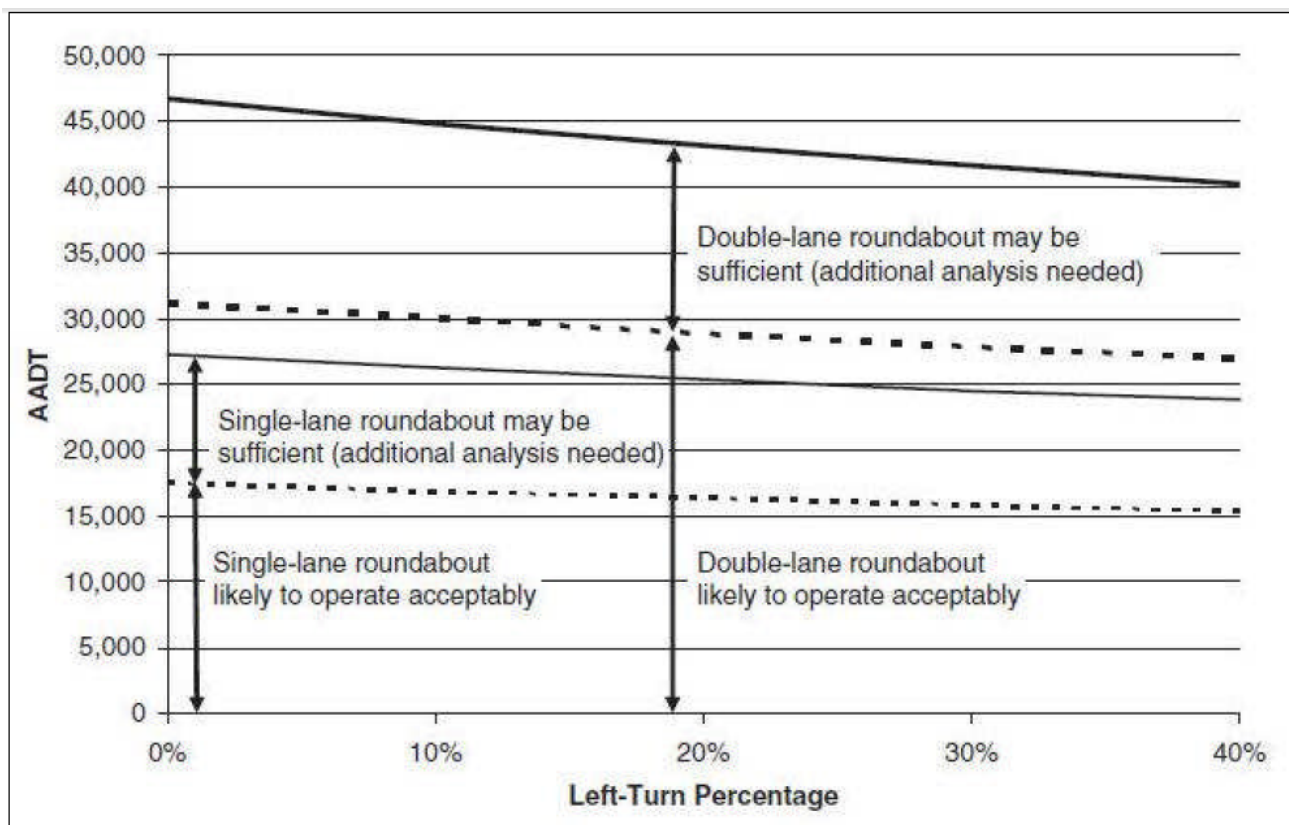

Figure 2.1 – Planning-Level Daily Intersection Volumes (Source: NCHRP 672')

Where existing and/or projected turning-movement count data is available at the planning level, this data should be used to estimate the required lane configurations. Each approach leg to the intersection is evaluated individually to determine the number of entering lanes that are required based upon the circulating flow rates (vehicles traveling along the circulatory roadway). The sum of the entering (V_e) and circulating (V_c) traffic volumes is compared to the results in Table 2.1 to determine the number of lanes required at the entry. The number of lanes within the circulatory roadway is then revised to provide lane continuity with the lanes at entry. A common rule of thumb is that a single-lane entry will likely operate acceptably if the sum of approach and circulating volumes is below 1100 vphpl. A second approach lane may be necessary when the sum of approach and circulating volumes is above 1100 vphpl and most likely necessary when sum exceeds 1400 vphpl. As the design evolves and detailed operational analysis

is performed at a later stage, the configuration of the intersection and the number of lanes are revised to reflect operational changes of the intersection.

If the preceding exercise indicates a two-lane entry, the flows are to be redistributed across all lanes subject to constraints imposed by any lane discipline. Table 2.2 provides practical guide to different lane designations and the proportions of turning traffic assumed on both the left and right lanes on a two-lane entry roundabout approach. The designer should exercise reasonable judgment in assigning these volumes on each lane.

Checks are then performed on lane by lane basis between the entry and the circulating flows. For the re-distributed flows, the 1,100 vph rule is reduced to 1,000 vph for the total conflicting volumes in the inner circulatory lanes. This is illustrated in Figure 2.2. An example calculation on preliminary lane determination is shown in Figure 2.3.

TABLE 2.1 Capacity Limits of Entry Lanes (Source: NYSDOT²)

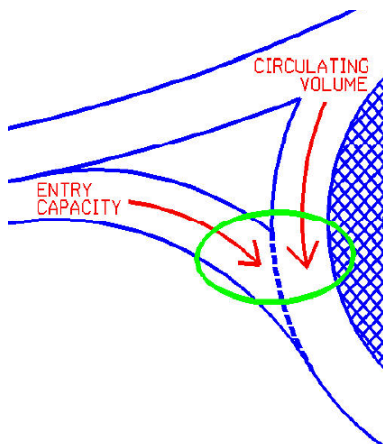

| Volume Range, entry + circulating (vphpl) | Number of Lanes Required |
|---|--|
| 0 to 1,100 | Single-lane entry is sufficient |
| 1,100 to 1,400 | Single-lane may be sufficient |
| 1,400 to 1,900 | Two-lane entry likely to be sufficient |
| 1,900 to 2,300 | Two-lane entry may be sufficient |
| 2,300 to 2,900 | Three-lane entry may be sufficient |

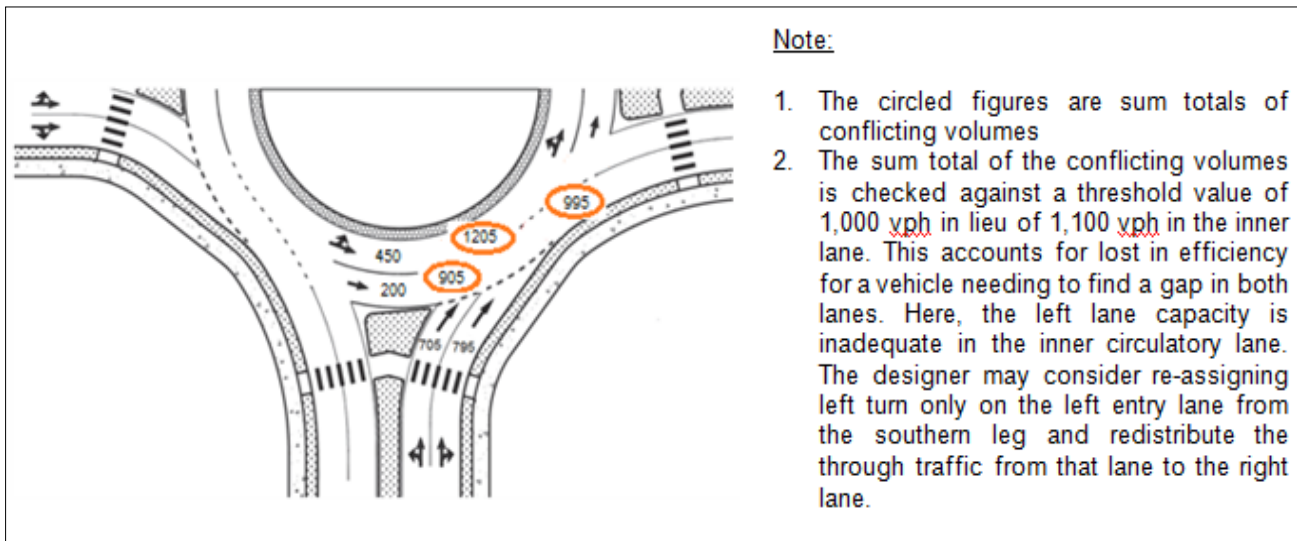
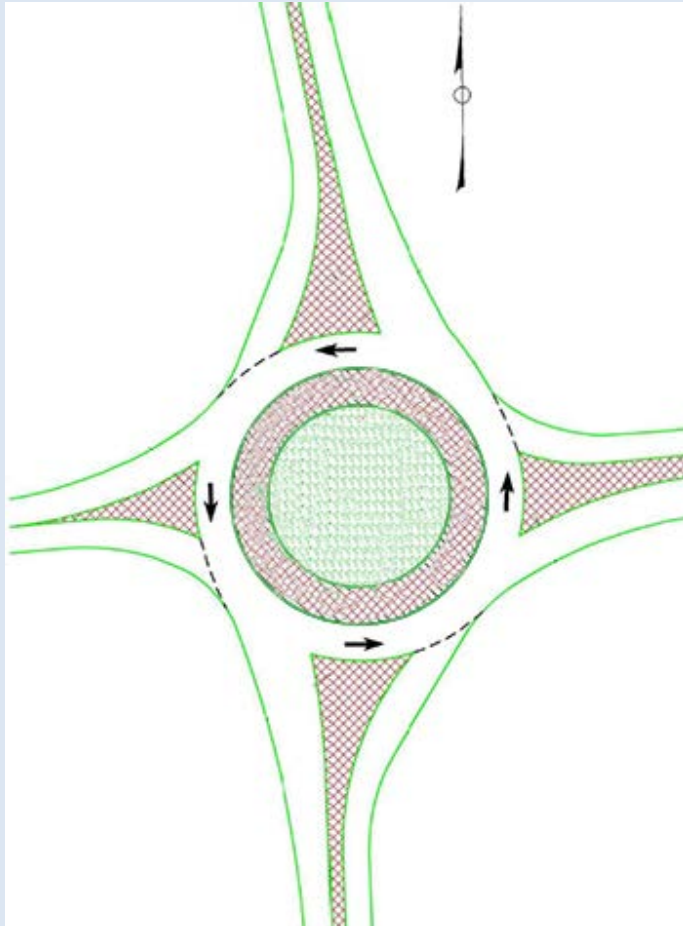

Figure 2.2 – Lane-by-Lane Checks for Capacity Limits on Two Lane Roundabout Approaches

Example Calculation: Determination of lane configuration giving turning-movement data

Consider an initial selection of a single-lane roundabout (SLR). Determine whether the configuration is adequate given the adjusted flows in the table below.



| | Volume (Veh/hr) | | | |
|------------|-----------------|-----------|-----------|------------|
| | U-Turn ↻ | Left ↶ | Thru ↑ | Right ↷ |
| Eastbound | 0 | 50 | 30 | 10 |
| Westbound | 0 | 50 | 20 | 400 |
| Southbound | 0 | 350 | 300 | 200 |
| Northbound | 0 | 530 | 510 | 10 |

Figure 2.3 – Example Calculation on Entry Lanes Determination

Procedure:

Each approach of the proposed single-lane roundabout is evaluated to determine the number of entering lanes that are required based on Table 2.1 as follows:

Northbound

Approach volume = $0 + 530 + 510 + 10 = 1050$

Circulating volume = $0 + 0 + 350 + 0 + 50 + 30 = 430$

Sum conflicting volumes = $1050 + 430 = 1480 > 1400$;
single-lane entry **not OK**

Southbound

Approach volume = $0 + 350 + 300 + 200 = 850$

Circulating volume = $0 + 0 + 530 + 0 + 50 + 20 = 600$

Sum conflicting volumes = $850 + 600 = 1450 > 1400$;
single-lane entry **not OK**

Eastbound

Approach volume = $0 + 50 + 30 + 150 = 230$

Circulating volume = $0 + 0 + 50 + 0 + 350 + 300 = 700$

Sum conflicting volumes = $230 + 700 = 930 < 1400$;
single-lane entry **WORKS**

Westbound

Approach volume = $0 + 50 + 20 + 400 = 470$

Circulating volume = $0 + 0 + 50 + 0 + 530 + 510 = 1090$

Sum conflicting volumes = $470 + 1090 = 1560 > 1400$;
single-lane entry **not OK**

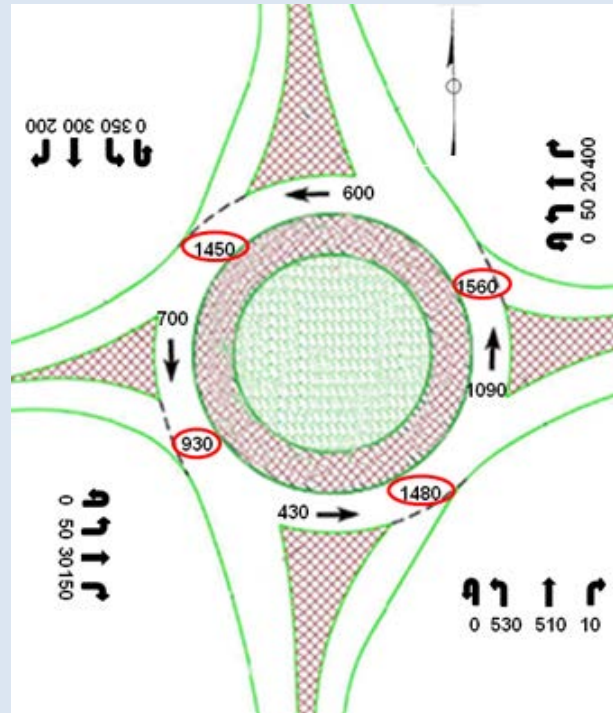

The preceding calculations indicate that a single-lane roundabout will not work for the given traffic volume. One possible solution is to consider each approach separately either by adding a right-turn bypass (slip) lane or replacing the one-lane entry with a two-lane entry or both, depending on the proportion of turning traffic at each approach. For example, the proportion of right turning traffic on the westbound approach is such that, by providing a right-turn bypass lane the total sum of entering and circulating traffic is reduced below the 1,100 vphpl warning level and definitely well below the 1,400 vphpl maximum. Adding a right-turn bypass lane to the northbound and southbound approaches has little effect in improving their capacities. A two-lane entry is recommended on the northbound and southbound approaches in this instance. Striping is used on the circulatory roadway to maintain lane continuity. A lane-by-lane check is performed on each approach as follows:

Figure 2.3 (cont.) – Example Calculation on Entry Lanes Determination

Northbound

The through lane volume is assigned to the right lane only (see Table 2.2 for lane assignments)

Left lane

Volume=0+530= 530

Circulating volume: =0+0+350+0+50+30= 430

Sum conflicting volumes: = 530 + 430 =960<1100; **OK**

Right lane

Volume =510+10=520

Circulating volume: =0+350+0+30= 380

Sum conflicting volumes: = 520 + 380 =900<1100; **OK**

Southbound

The total approach volume is split for the left lane and the right lane in the proportion of 0.47:0.53, respectively (see Table 2.2 for lane assignments)

Left lane

Volume =0.47 * 850 = 400

Circulating volume =0+0+530+0+50+20 = 600

Sum conflicting volumes =400 + 600 =1000<1100; **OK**

Right lane

Volume =0.53 * 850 = 450

Circulating volume =0+530+20 = 550

Sum Conflicting volumes = 450 + 550 =1000<1100; **OK**

Eastbound

Approach volume=0+50+30+150= 230

Outer circulating volume =250

Inner circulating volume =350+50+50=450

Sum conflicting volumes

= 230 + 250 =480<1100;(outer) **OK**

Sum conflicting volumes =0+50+30+450=530<1000

;(inner) **OK**

Westbound

Right-turn bypass volume = 400

Entry lane volume=0+50+20= 70

Outer circulating volume = 510

Inner circulating volume = 0+50+530 =580

Sum conflicting volumes = 70+ 510 = 580<1100;(outer)

OK

Sum conflicting volumes = 70+ 580 = 650<1000; (inner)

OK

Sum conflicting volumes = 400+ 510 = 910<1100; (right-turn bypass) **OK**

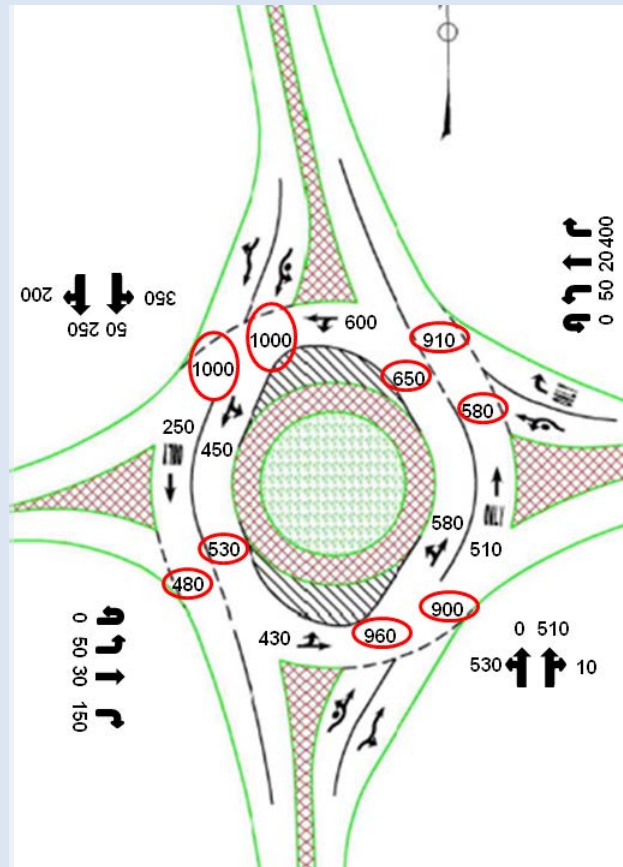

Figure 2.3 (cont.) – Example Calculation on Entry Lanes Determination

TABLE 2.2 Default Volume and Lane Assignments for Two-Lane Entries (Source: HCM 2010³)

| *Lane Assignments | | | |
|--------------------|---|-------------------------------|-------------|
| Lane Discipline | Assume Lane Assignment | | |
| LT, TR | If $V_U + V_L > V_T + V_{R,e}$: L, TR (de facto left-turn lane) → case 1 If $V_{R,e} > V_U + V_L + V_T$: LT, R (de facto right-turn lane) → case 2 Else LT, TR → case 3 | | |
| L, LTR | If $V_T + V_{R,e} > V_U + V_L$: L, TR (de facto through-right lane) → case 1 Else L, LTR → case 4 | | |
| LTR, R | If $V_U + V_L + V_T > V_{R,e}$: LT, R (de facto left-through lane) → case 2 Else LTR, R → case 5 | | |
| Volume Assignments | | | |
| Case | Assume Lane Assignment | Left Lane | Right Lane |
| 3 | LT, TR | (%LL) V_e | (%RL) V_e |
| 2 | LT, R | $V_U + V_L + V_T$ | $V_{R,e}$ |
| 3 | LT, TR | (%LL) V_e | (%RL) V_e |
| 4 | L, LTR | (%LL) V_e | (%RL) V_e |
| 5 | LTR, R | (%LL) V_e | (%RL) V_e |
| **Volume Split | | | |
| Lane Configuration | % Traffic in Left Lane (%LL) | % Traffic in Right Lane (%RL) | |
| LT, TR | 0.47 | 0.53 | |
| LTR, R | 0.47 | 0.53 | |
| L, LTR | 0.53 | 0.47 | |

Notes:

1. $V_U, V_L, V_T, V_{R,e}$ and V_e are the U-turn, left-turn, through, nonbypass right-turn and approach entry flow rates for a given entry, respectively. L = left, LT = left-through, TR = through-right, LTR = left-through-right, and R = right.
2. **These values are generally consistent with observed values for through movements at signalized intersections. These values should be applied with care, particularly under conditions estimated to be near capacity.

2.1.3 Space Requirement

Though a detailed design is required to determine the space requirements at a specific site, an estimate of the space requirement at the planning stage based on the preliminary configuration is always required to determine any potential property impacts and whether additional right of way should be acquired to accommodate the roundabout. This also provides the opportunity to assess the roundabout's spatial appropriateness against conventional intersections.

2.1.4 Comparing Performance of Alternative Intersection Types

Once a particular roundabout type (single-lane or multilane) is selected, it should be compared with other intersection types - stop or signal- controlled intersection through a set criteria. This should include capacity improvement benefits, delay benefits, reduced crash frequency and severity, property impacts, turning opportunities, cost, community acceptance etc. The set of criteria should be site specific and should address the requirements of the proposed location.

2.1.5 Recommended Planning Level Software

Preliminary lane sizing should follow the procedures set in the *Highway Capacity Manual*⁶ (HCM 2010). [ALDOT Roundabout Capacity Analysis Spreadsheet](#) and *SIDRA Intersection* are two identified analysis tools that conform to these procedures and may be adopted in the initial sizing. The use of the spreadsheet is limited to no more than four approaches, up to two entry lanes and one lane for right turn bypass lanes.

SIDRA Intersection on the other hand, can be used for more than four approaches, up to three entry lanes and one or more lanes for right turn bypass lanes. In addition, simulation software such as *VISSIM* may be used to provide visuals for the appreciation of the general public during the public information meetings. The models analyzed by these tools should be calibrated with the headway values listed in [Table 2.3](#).

2.1.6 Public Involvement

It should be acknowledged that roundabouts are “new road cultures” in the State and, as such, public education and involvement are imperative. Holding public meetings and providing education both in the print and electronic media to the community will enhance the acceptability and proper use of the facility. This awareness campaign process should include outreach to local government officials and should be initiated as soon as practical in the early stages of the planning process.

Simple and clear exhibits on the basic physical features of a roundabout and education materials on proper user behavior and attitude, especially on multilane roundabouts may be prepared to showcase to the general public at these meetings. Users should also be educated about other modes using the roundabout in order that they recognize each other as functional users of facility. For a thorough discussion on public involvement and how to organize public involvement programs, refer to [NCHRP 672](#)¹ and [ALDOT Transportation Planning Bureau](#).

2.2 Operational Analysis Procedures

The operational performance of a proposed or existing roundabout needs to be assessed in terms of

1. Capacity (its ability to accommodate the traffic demand)
2. Level of Service (LOS)
3. Queue length

2.2.1 Entry Capacity

This is the maximum hourly rate of flow of traffic under prevailing traffic and geometric conditions. This must be determined for both vehicular and pedestrian traffic. The procedures presented here refer to the HCM³ method. For more complex geometry or system wide analysis, deterministic software such as *SIDRA Intersection* or *VISSIM* simulation may be employed.

Step 1: Compute vehicle flow rate

Compute demand flow rate under base conditions in passenger car per hour (pc/h)

$$v_{i,pce} = \frac{v_i}{PHF * f_{HV}} \quad \text{[Equation 2.1]}$$

$$f_{HV} = \frac{1}{1 + P_T(E_T - 1)}$$

$v_{i,pce}$ = demand flow rate for movement i , (pc/h)

v_i = demand volume for movement i , veh/h

f_{HV} = heavy vehicle adjustment factor

P_T = proportion of demand volume that consists of heavy vehicles

E_T = passenger car equivalent for heavy vehicles (2.0 for trucks, 0.5 for bicycle)

PHF = peak hour factor

Step 2: Compute entry capacity

HCM suggests a general empirical model which relates headways to roundabout capacity as given in Equation 2.2.

$$C_{e,pce} = A \exp(-B v_{c,pce}) \quad \text{[Equation 2.2]}$$

$C_{e,pce}$ = lane capacity, adjusted for heavy vehicles (pc/h)

$v_{c,pce}$ = conflicting flow rate, total for all lanes, adjusted for heavy vehicles, pc/h

$$A = \frac{3,600}{t_f}, \quad B = \frac{t_c - \left(\frac{t_f}{2}\right)}{3,600}$$

t_c = critical headway(s)

t_f = follow-up headway(s)

This model can be calibrated to local sites by adjusting the critical and follow-up headways. A recent study funded by FHWA presented field measurement headway values from driver response behaviors at roundabouts. These values are reproduced in Table 2.3 and are recommended for estimating roundabout capacities in Alabama. Where however, headways are available at a specific local site, the model shall be adjusted as necessary to include the new headways in lieu of that presented in Table 2.3. The resulting capacity equations using the headways listed in Table 2.3 are presented in Equations 2.3 to 2.7 for the different roundabout model types.

TABLE 2.3 Recommended Headway Values (Source: Lee Rodegerdts⁴)

| Number of Entry and Circulating Lanes | Critical Headway, t_c (sec) | Follow-up Headway, t_f (sec) | Parameter A | Parameter B |
|---------------------------------------|-------------------------------|--------------------------------|-------------|-------------|
| Single-lane | 5.0 | 2.6 | 1380 | 0.00102 |
| 2x2, right lane | 4.3 | 2.5 | 1420 | 0.00085 |
| 2x2, left lane | 4.7 | 2.7 | 1350 | 0.00092 |
| 2x1, both lanes | 4.4 | 2.3 | 1420 | 0.00091 |
| 1x2, one lane | 4.3 | 2.5 | 1420 | 0.00085 |

Note:

1. Single-lane: refers to model parameters for the single entry lane when one-lane entry conflicts with one-lane circulating lane
2. 2x2, right lane refers to model parameters for the entry right lane when two entry lanes conflict with two circulating lanes
3. 2x2, left lane refers to model parameters for the entry left lane when two entry lanes conflict with two circulating lanes
4. 2x1, both lanes refers to model parameters for the each entry lane when two entry lanes conflict with one circulating lanes
5. 1x2, one lane refers to model parameters for the entry lane when one entry lane conflicts with two circulating lanes.

Capacity of a Single-lane Roundabout

Equation 2.3 gives the capacity of a single-lane entry conflicted by one circulating lane (illustrated in Figure 2.4) as follows:

$$C_{e,pce} = 1,380 \exp(-0.00102v_{c,pce}) \quad [\text{Equation 2.3}]$$

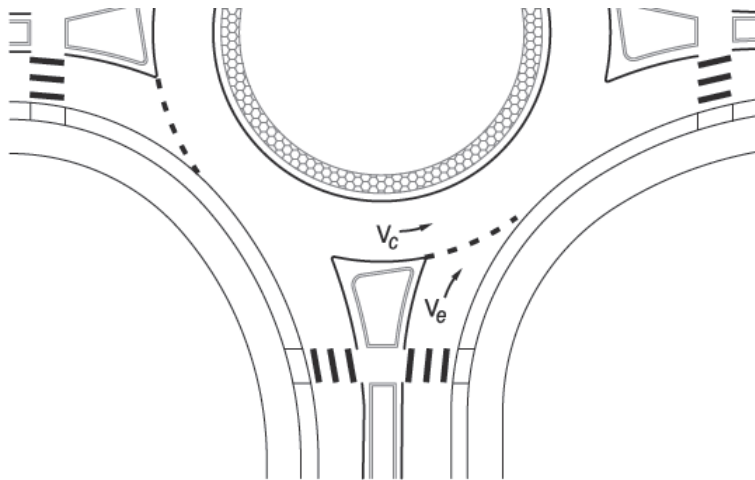

Figure 2.4 – Typical One-Lane Entry Conflicted by One Circulating Lane (Source: HCM 2010³)

Capacity of 2x2 Multilane Roundabout

Equation 2.4 and Equation 2.5 give the capacity of the right and left lanes, respectively, of two-lane entry conflicted by two circulating lanes (illustrated in Figure 2.5):

$$C_{e,R,pce} = 1,420 \exp(-0.00085v_{c,pce}) \quad [\text{Equation 2.4}]$$

$$C_{e,L,pce} = 1,350 \exp(-0.00092v_{c,pce}) \quad [\text{Equation 2.5}]$$

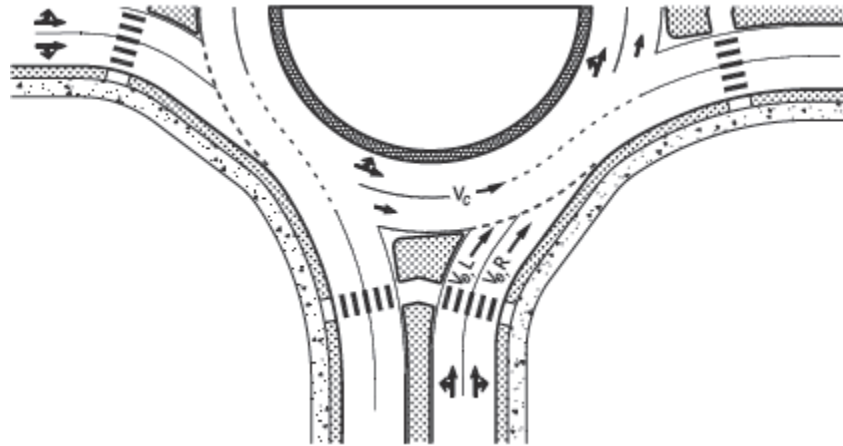

Figure 2.5 –Typical Two-Lane Entry Conflicted by Two Circulating Lanes (Source: HCM 2010³)

Capacity of 2x1 Multilane Roundabout

Equation 2.6 gives the capacity of each entry lane when a two-lane entry is conflicted by one circulating lane (illustrated in Figure 2.6) as follows:

$$C_{e,pce} = 1,420 \exp(-0.00091 v_{c,pce}) \quad \text{[Equation 2.6]}$$

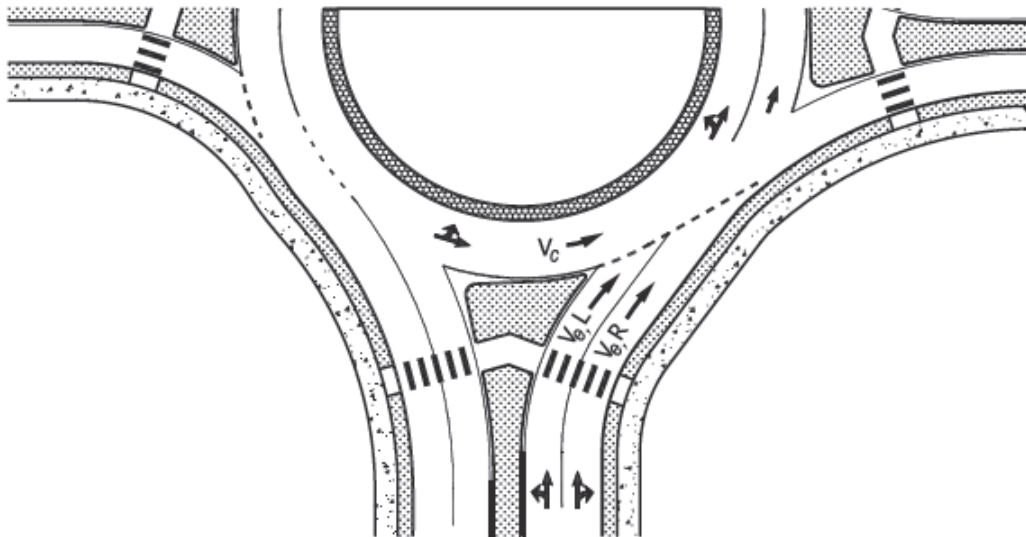

Figure 2.6 –Typical Two-Lane Entry Conflicted by One Circulating Lane (Source: HCM 2010³)

Capacity of 1x2 Multilane Roundabout

Equation 2.7 gives the capacity of a one-lane entry conflicted by two circulating lanes (illustrated in Figure 2.7) as follows:

$$C_{e,pce} = 1,420 \exp(-0.00085 v_{c,pce}) \quad [\text{Equation 2.7}]$$

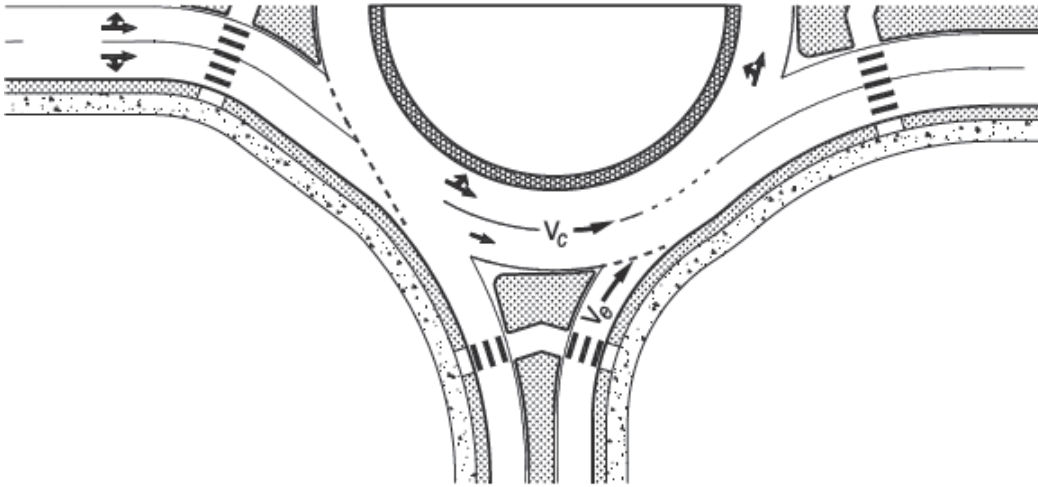
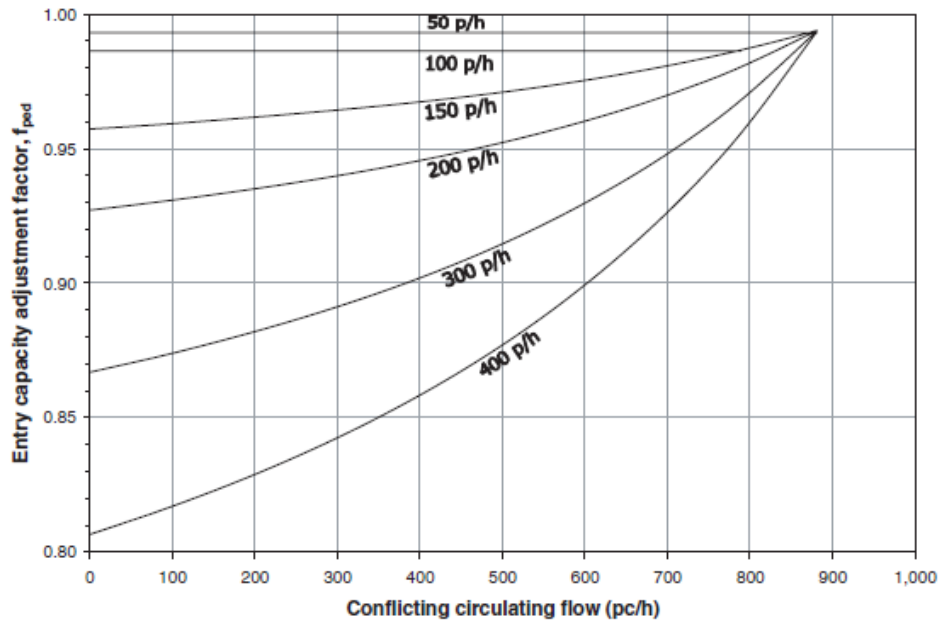

Figure 2.7 – Typical one-lane entry conflicted by two circulating lanes (Source: HCM 2010³)

Step 3: Adjust for effect of pedestrians at crossings

The flows obtained in step 2 are adjusted for the effect of pedestrians at crossings. For roundabout entries opposed by one circulating lane, Figure 2.8a can be used to approximate this effect. For entries opposed by two circulating lanes, Figure 2.8b can be used. These models are based on the assumption that pedestrians have absolute priority at roundabout crossings.

a.



b.

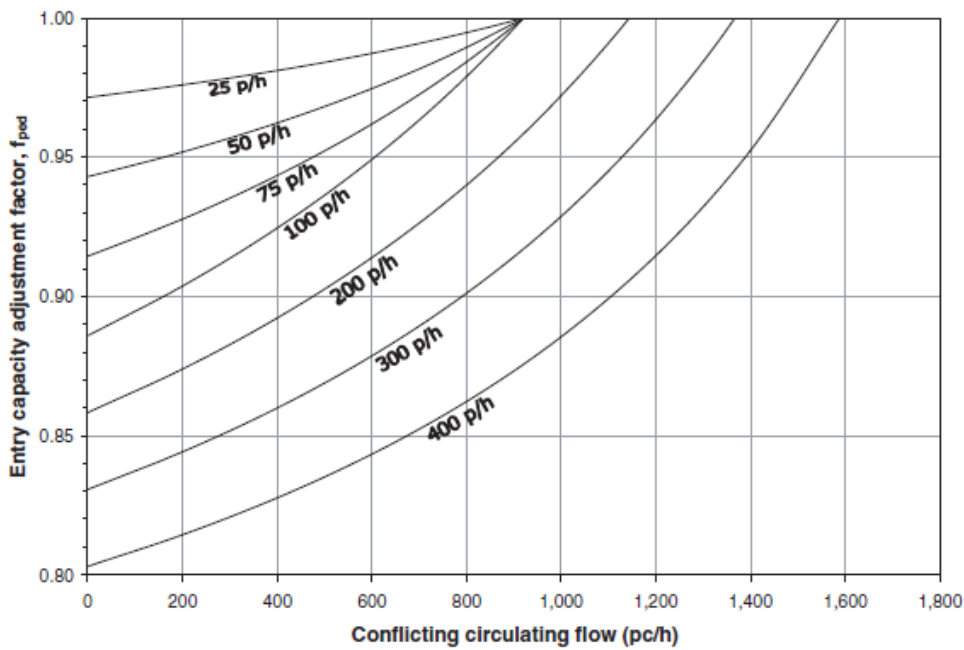

Figure 2.8 – Entry Capacity Adjustment Factor for Pedestrians (Source: HCM 2010³)

Step 4: Compute volume- to- capacity ratio

Finally, the adequacy of a given entry design is assessed by comparing the demand at the roundabout entry to the capacity of the entry. For a given lane, the volume-to-capacity ratio, x , is calculated by from Equation 2.8:

$$x = \frac{V}{C} \quad \text{[Equation 2.8]}$$

The volume to capacity ratio shall be determined for each approach lane at the roundabout. Best practices suggest V/C ratio thresholds of between 0.85 and 0.90 for satisfactory performance of the roundabout during the design year. Where the volume-to-capacity ratio exceeds 0.85, sensitivity analysis should be carried out to evaluate the deterioration levels of any relatively small incremental volume change on delays or queues.

2.2.2 Right -Turn Bypass Lanes

The capacity for a yielding bypass lane (sometimes referred to as a slip lane) opposed by one exiting lane can be approximated with Equation 2.9. For a yielding bypass lane opposed by two exiting lanes, the capacity is approximated with Equation 2.7. For bypass lanes that merge with exiting traffic through a downstream merging operation, no empirical model exists yet, but higher entry capacities are expected.

$$C_{slip,pce} = 1,380e^{(-1.0 \times 10^{-3})v_{ex,pce}} \quad \text{[Equation 2.9]}$$

$$C_{slip,pce} = 1,420e^{(-0.85 \times 10^{-3})v_{ex,pce}} \quad \text{[Equation 2.10]}$$

$C_{slip,pce}$ = capacity of the bypass lane, adjusted for heavy vehicles, pc/h; and

$v_{ex,pce}$ = conflicting exiting flow, pc/h.

2.2.3 Level of Service

The quality of service is how well a transportation facility or service operates from a user's perspective. The measure that represents that quality of service is the level-of- service. The main service measure used for LOS of roundabouts is control delay shown in Equation 2.11. This model assumes that there is no storage of vehicle from one 15-minute study period to the next. The service performance is then determined from [Table 2.4](#) with the control delay as the input value.

$$d = \frac{3,600}{c} + 900T \left[x - 1 + \sqrt{(1 - x)^2 + \frac{\left(\frac{3,600}{c}\right)x}{450T}} \right] + 5 * \min[x, 1] \quad \text{[Equation 2.11]}$$

d = average control delay, s/veh;

x = volume-to-capacity ratio of the subject lane;

c = capacity of subject lane, veh/h; and

T = time period, h

TABLE 2.4 Level-of-Service Criteria- LOS (Source: HCM 2010³)

| Control Delay (s/veh) | Level of Service by Volume-to-Capacity Ratio | |
|-----------------------|--|-----------|
| | V/C ≤ 1.0 | V/C > 1.0 |
| 0-10 | A | F |
| > 10-15 | B | F |
| > 15-25 | C | F |
| > 25-35 | D | F |
| > 35-50 | E | F |
| > 50 | F | F |

2.2.4 Queue Length

Queue estimates can be used to determine the feasibility of the intersection. Additionally, when acceptable delay levels are established the results from the queue study may inform the need for auxiliary (bypass) lanes or be used in comparative analysis with other intersection alternatives. At isolated intersections of proposed roundabout locations the 95th percentile queue for each approach lane is estimated using Equation 2.9. Where a candidate roundabout is in close proximity to other intersections simulation models may be appropriate to use to provide queue estimates. Based on the results of these analyses the performance of the roundabout compared to other alternate intersections should be evaluated and the type providing adequate performance identified.

$$Q_{95} = 900T \left[x - 1 + \sqrt{(1 - x)^2 + \frac{(3,600)}{150T}x} \right] \left(\frac{c}{3,600} \right) \quad \text{[Equation 2.12]}$$

- Q_{95} = average control delay, s/veh;
 x = volume-to-capacity ratio of the subject lane;
 c = capacity of subject lane, veh/h; and
 T = time period, h

2.2.5 Long-Term Operational Analysis

Traffic analysis is an important aspect of the design of roundabouts as it determines the number of lanes that are required on the entries, circulating roadway, and exits to ensure an appropriate level of service for motorists. Care should be taken in assessing the future traffic volumes and their patterns. It is possible that a site considered appropriate for a roundabout in the short to medium term may become inappropriate in the longer term, requiring extensive modification to the intersection. Designers should consider the potential to build flexibility into the design to accommodate possible future changes, particularly when changes to land use are likely to substantially alter traffic patterns. A lifecycle approach (possibility of change in land use pattern over the design year) should be used to assess the viability of a roundabout over its service life and to develop a strategy for the future; for example, upgrade a single-lane roundabout to a two-lane roundabout or replace the roundabout with a signalized intersection or an interchange at a future date.

Wherever practical, it is preferable to design the ultimate layout for a location so that appropriate land can be reserved for the future and the initial design provides a logical and efficient step toward the

ultimate design. Thus, if a multilane roundabout is needed to accommodate design year traffic volumes, typically projected 20 years from the present, but a single-lane roundabout can operate satisfactorily within first 10 years of opening to traffic, then the roundabout should be designed for the ultimate configuration but opened as a single-lane roundabout to serve the near-term traffic volumes. To stage the construction of a multilane roundabout, the designer should evaluate the right-of-way and geometric needs for both the single-lane and multilane configurations and how additional lanes will be constructed in the future. One technique involves adding any necessary lanes for the ultimate configuration to the outside of the interim roundabout configuration, with the central island and splitter islands remaining the same in both interim and ultimate configurations. The interim sidewalks and landscaping could also be constructed in their ultimate location.

Alternatively, the ultimate multilane roundabout can be modified to the interim single-lane roundabout by providing wide splitter islands and an enlarged central island that occupy the space required for the inside travel lanes. Future expansion to the multilane roundabout is accomplished by reducing the width of the splitter islands and widening on the inside of the existing travel lanes as shown in [Figure 2.9](#). The choice of a particular technique will depend on the Right-of- Way and funding requirements of the project.

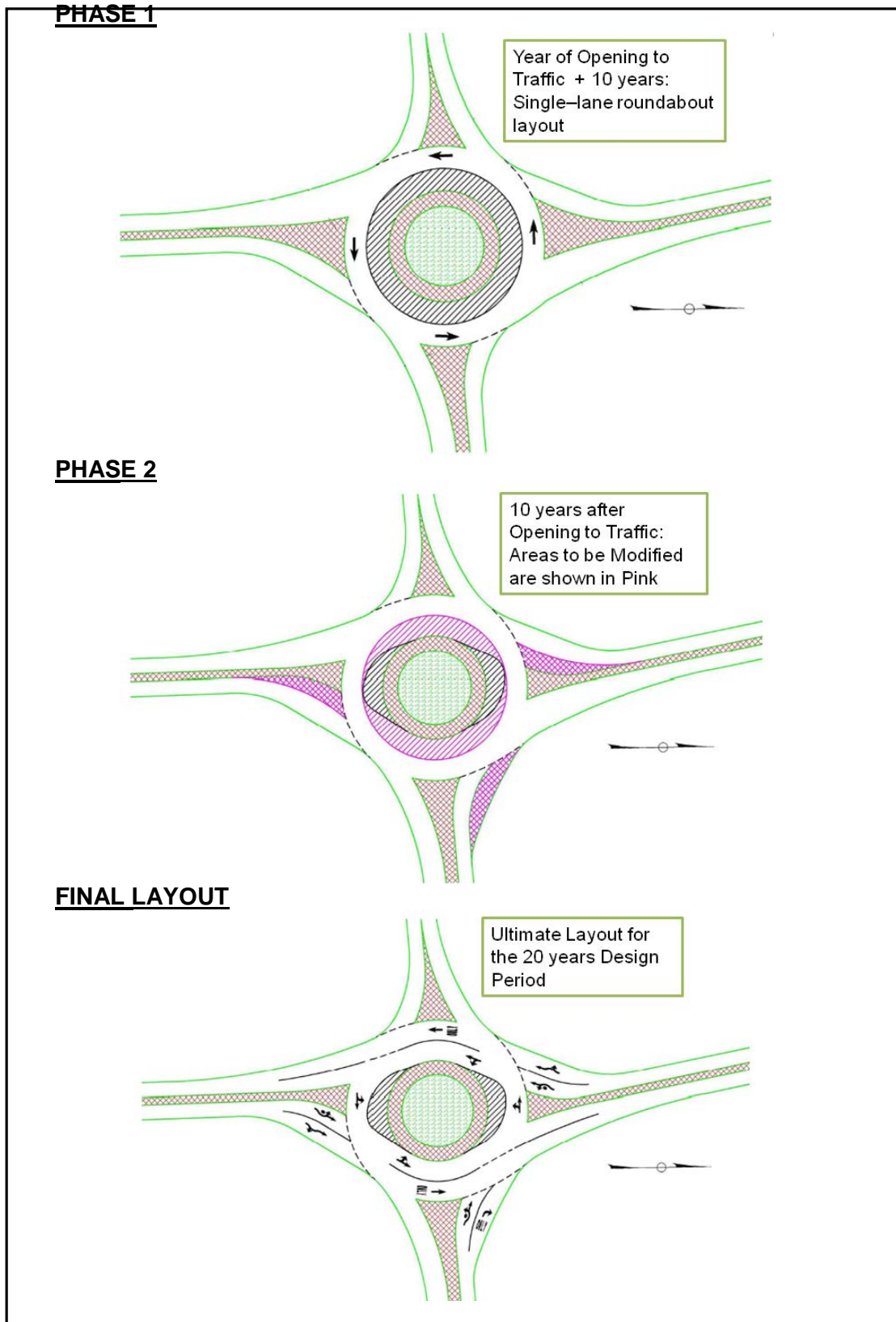

Figure 2.9 Staged Multilane Roundabout (courtesy: Howard McCulloch, NYSDOT²)

2.3 System Considerations

The implementation of roundabouts at certain sites – coordinated signal corridors, closely spaced intersections, at-grade rail crossings, etc. – may be difficult compared to other control types. The existence of one or more of these conditions does not necessarily preclude the installation of a roundabout. Careful consideration should, however, be given to roundabouts at these locations.

2.3.1 Coordinated Signal Systems

A traffic engineering study should be performed to determine the suitability of locating a roundabout within a coordinated signal network. A signalized intersection with long cycle length within a coordinated signal network may be replaced with a roundabout if it adversely impacts the progression of the coordinated system. The roundabout breaks the system coordination into two halves while still providing good progression through the network. In addition, roundabouts should only be located near a signalized intersection if no queue spillback is likely to be formed from adjacent intersections.

2.3.2 Closely Spaced Intersections

Roundabouts are considered closely spaced if the spacing between two adjacent roundabouts is less than 1,000 feet from centers. Closely spaced roundabouts can potentially reduce queues and balance traffic flows on interchange bridges. They also can accommodate a wide range of access, both public and private. It is important to ensure sufficient queuing space for vehicles between the roundabouts. In some cases, it may be necessary to minimize queuing between the roundabouts by limiting the capacity of the inbound approaches.

2.3.3 At-Grade Rail Crossings

Where a roundabout is to be located close to an at-grade rail crossing, traffic control (such as crossing gates and flashing lights) at the grade crossing should be provided and should be consistent with treatments at other highway–rail grade crossings. The treatment of at-grade rail crossings should follow the recommendations of the [MUTCD](#)⁵ and FHWA [Railroad-Highway Grade Crossing Handbook](#).

Under no circumstance, should highway traffic be forced to stop on the rail tracks. Where railroad gates are used to stop traffic, the gate placement and sequencing of the gates should be given careful consideration to allow all exiting traffic to clear the tracks prior to the train arriving.

2.4 Roundabout Safety

Roundabouts are not only noted for their reduced incidence of crash capabilities but also ensure that less severe injuries are observed when accidents occur at the intersection. In areas with large numbers of vulnerable road users or substantial crash risk, speed management complimented with good roadside treatments is a key strategy for limiting crashes.

The frequency and severity of crashes at an intersection are related to the number of conflict points and the magnitude of conflicting flows at the intersection. As shown in [Figure 2.10](#), the benefits of roundabouts are seen in the reduction of the number of vehicular conflict points at intersections. The number of vehicle-vehicle conflict points for traditional three-leg (T) intersection reduces from nine to six. Similarly, the number of vehicle-vehicle conflict points reduces from thirty-two to eight when a roundabout is considered over a traditional four-leg intersection. More importantly, however, is that roundabouts eliminate all crossing conflicts, which are often associated with the most sever crashes. As a result,

fewer total vehicular crashes and fewer high severity crashes are expected at roundabouts than conventional intersections. However, it is important to note that not much safety benefits are seen by cyclists or pedestrians when compared with alternate intersections. Special consideration must therefore be given to pedestrian and cyclist movements at roundabouts including keeping their paths outside the circulatory roadway. The location of crossings at exits must be such that the exiting vehicles can locate and safely stop for pedestrians before gaining higher speeds. Roundabouts designed with good entry curvature require entering drivers to slow down, provide more time for motor vehicle drivers to scan for cyclists, and consequently minimize cyclist crashes. Special treatments for cyclists and pedestrians are presented in Chapter 3.

While pedestrians and cyclists have a higher crash risk than motor vehicles at roundabouts, there is demonstrable evidence that roundabouts provide satisfactory treatment to minimize that risk at a wide range of intersection sites in low and high-speed environments. Nonetheless, designers must show how any potential pedestrian or cyclist with vehicular conflicts can be reduced. The procedure presented in Chapter 5 of *NCHRP 672*¹, and the *AASHTO Highway Safety Manual*⁶ may be used to assess the safety performance of the roundabouts. The results of the analysis should enable the road designer to identify potentially hazardous geometry of the proposed or existing roundabouts. The results of the predicted crash frequencies and crash types should be presented to ALDOT or the local agency (in the case of locally funded projects) for evaluation. For existing roundabouts, this should include proposed mitigations both in terms of geometry improvement and traffic control measures for the identified crashes.

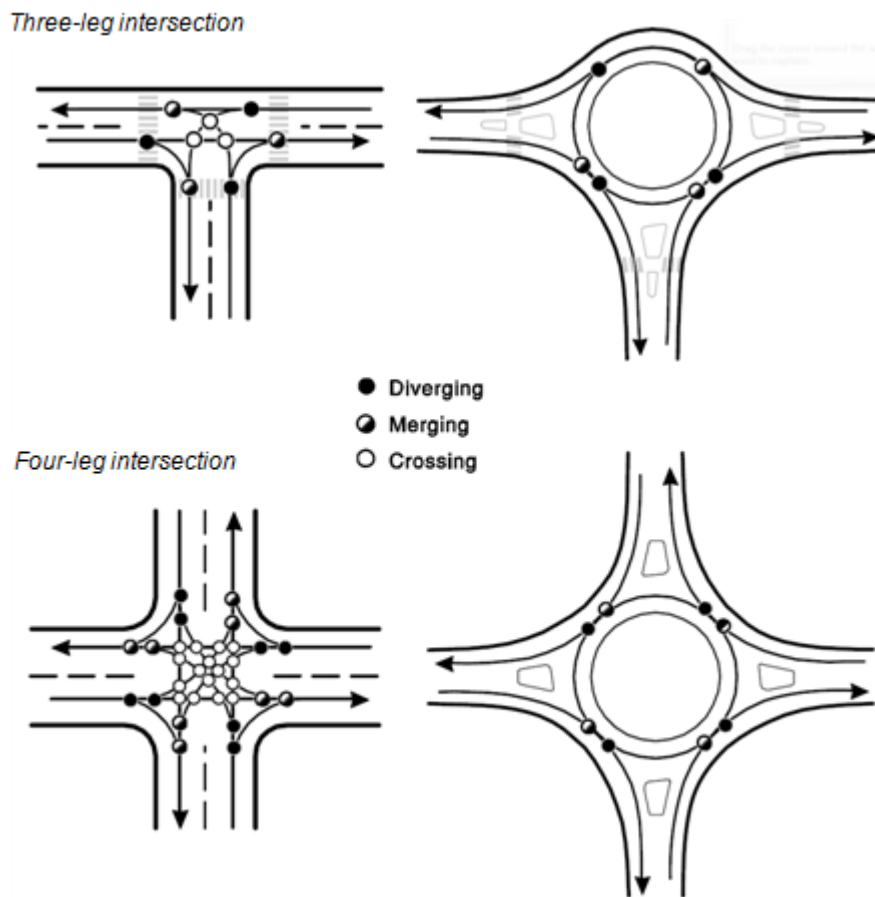

Figure 2.10 – Vehicle Conflict Points at Intersections (Source: NCHRRP 672)

2.5 References

1. Rodegerdts, L., J. Bansen, C. Tiesler, J. Knudsen, E. Myers, M. Johnson, M. Moule, B. Persaud, C. Lyon, S. Hallmark, H. Isebrands, R. B. Crown, B. Guichet and AO. *NCHRP Report 672: Roundabouts: An Informational Guide*. 2nd ed. (Transportation Research Board of the National Academies, ed.). Washington D.C; 2010. Available at: http://onlinepubs.trb.org/onlinepubs/nchrp/nchrp_rpt_672.pdf.
2. New York State Department of Transportation. *Highway Design Manual: Chapter 26 - Roundabouts*. New York; 2013.
3. National Research Council (U.S.). Transportation Research Board. *2010 Highway Capacity Manual*. (Transportation Research Board of The National Academies, ed.). Washington, D.C.; 2010.
4. Lee Rodegerdts. *Reassessment of Roundabout Capacity Models for the Highway Capacity Manual*. (TRB 4th International Roundabout Conference, ed.). Seattle,WA; 2014.
5. Federal Highway Administration (FHWA). *Manual on Uniform Traffic Control Devices (MUTCD)*. 2009th ed. (FHWA, ed.). Washington D.C; 2012. Available at: http://mutcd.fhwa.dot.gov/pdfs/2009/pdf_index.htm.
6. American Association of State Highway and Transportation Officials. *Highway Safety Manual*. National Research Council, Transportation Research Board, 2010.

Chapter 3

Geometric Design

3.1 Design Principles

Roundabout development is centered on a set of fundamental design principles that includes speed reductions, lane alignments, and human factor needs. The designer should ensure that the following principles are followed:

- Ensuring consistent speeds through the roundabout by using vehicle path deflection.
- Providing appropriate number of lanes and lane assignment to achieve adequate capacity, lane volume balance, and lane continuity.
- Providing smooth channelization that is intuitive to drivers and results in vehicles naturally using the intended lanes.
- Providing adequate accommodation for all relevant design vehicles.
- Providing adequate accommodation to meet the needs of pedestrians and cyclists.
- Providing appropriate sight distance and visibility for driver recognition of the intersection and conflicting users.

These principles are applied to roundabouts on urban arterial and rural intersections, on freeways as either ramp terminal treatments or as grade separated intersections. It is, however, important to note the different operational objectives on each functional class of road and the site specific constraints exhibited by them. For example, on local streets the operational objectives are not the same as those on arterial roads and because of constraints such as cost, limited space, and the low-speed environment, the respective designs will be quite different.

The basic geometric features considerations and key dimensions of a roundabout are presented in [Figure 3.1](#).

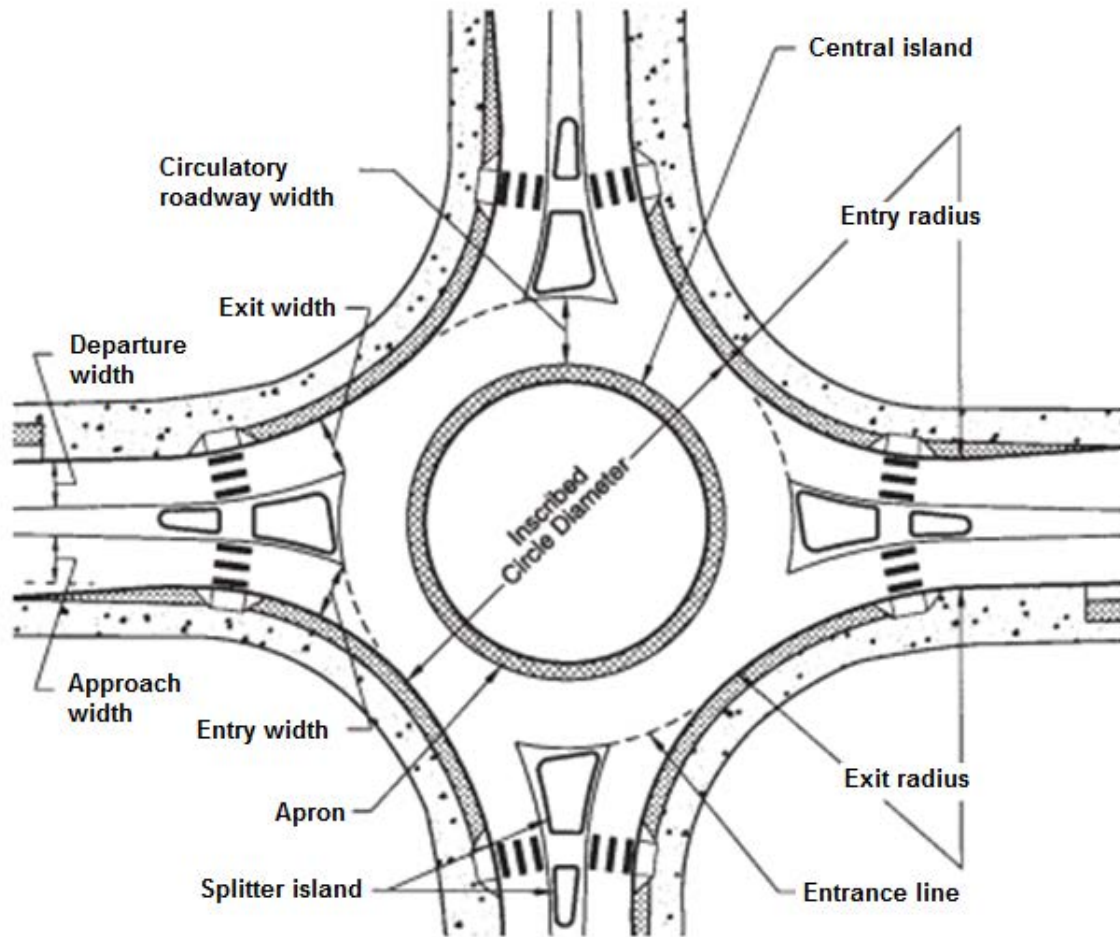

Figure 3.1 – Roundabout Geometric Design Elements (Source: FHWA¹)

3.2 Design Process

Figure 3.2 shows the general procedure for the design of roundabout intersections from planning stage through to preliminary design and to detail design. Table 3.1 further presents the basic data required for the design process. The need to undertake some of the steps will depend on the nature of the site, or on the class of road on which the facility is to be applied. For example, the design of a roundabout between two local residential streets may be a relatively simple exercise where traffic analysis is unnecessary and existing corner radii are used as controls for the location of the circulating roadway. On the other hand, an intersection between two arterial roads will usually require detailed traffic analysis, and may require several iterations to establish the optimum design.

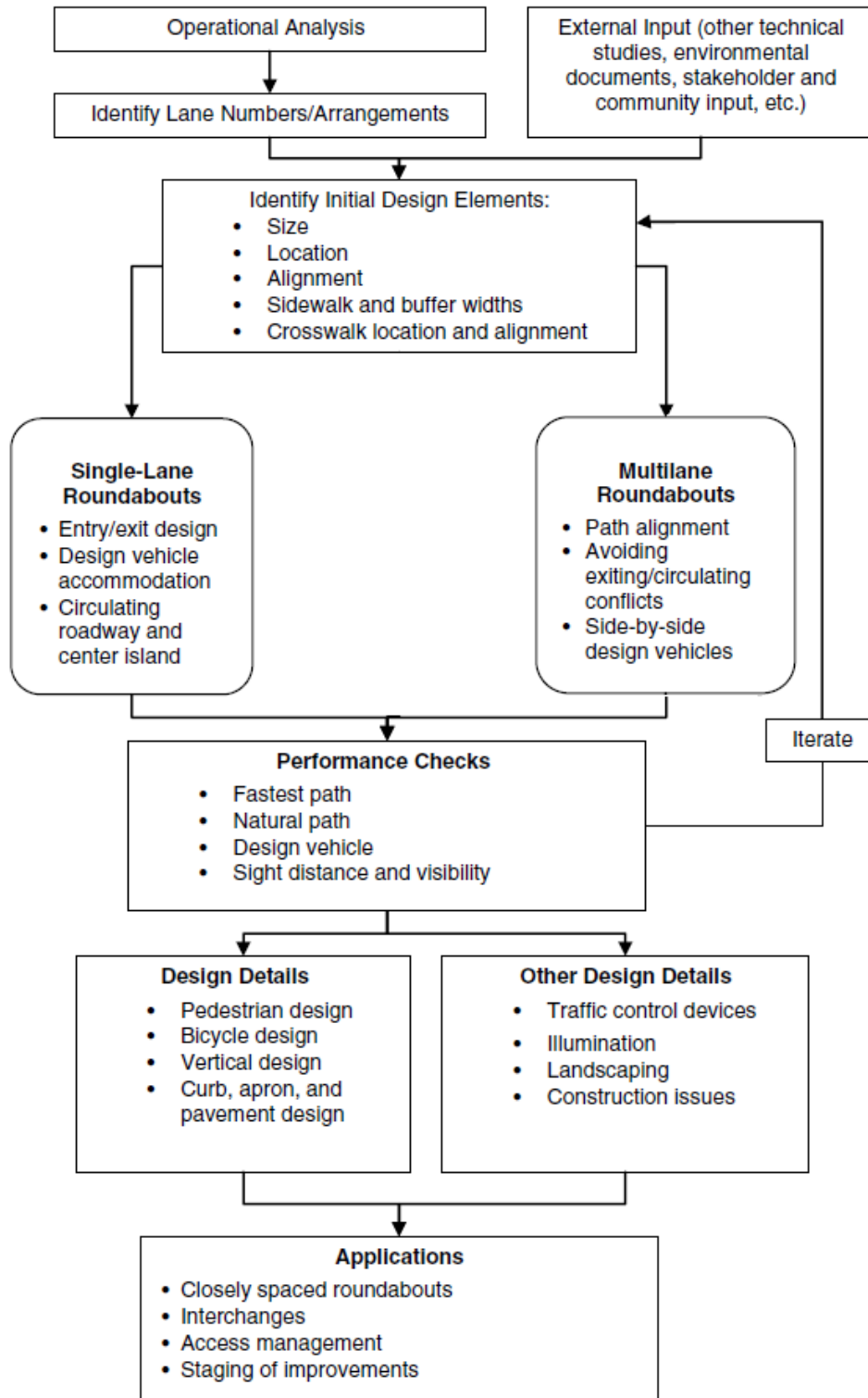

Figure 3.2 – Basic Procedure for the Design of Roundabout Intersection (Source: NCHRP 672²)

TABLE 3.1 Fundamental Data for Planning and Design of Roundabouts

| Site Condition | Data category | Remarks |
|-------------------|--|---|
| Traffic Condition | Hourly traffic volume by direction and vehicular type , peds and bikes | AM/PM peak volume (2-3hours) volume, or if necessary 12 hour or 24 hour traffic volume. Vehicles are to be classified according to AASHTO vehicle classification |
| | High volumes of vehicles, pedestrians and bicycle traffic. | For cases with particularly high volume the peak period and crash data for the last 5 years of all crossing location and conflict points may be required |
| | Adjacent traveled ways, destination routes | Include adjacent intersections and the nearby minor roads, and any large destinations and their access control. |
| | Traffic signal control method | Include the adjacent intersections |
| Road Condition | Road network characteristics | Data to include surrounding areas and minor road. Urban planning road network map on topographical map at a scale of 1/2500 or 1/5000 |
| | Land features and structures | The land features of the surrounding areas, land use and building conditions along the road |
| | Road conditions | Number of approaches and their intersecting angles, existing road feature (grade, profile and cross section), road markings, location of new connectors on a topographical map at a scale of 1/250 or 1/500, and photographs. |

3.3 Design Vehicle and Vehicle Swept Path

The selection of an appropriate design vehicle forms the basis for the design of roundabout geometric features. The turning path of this design vehicle controls many of the geometric dimensions of roundabouts. For the purposes of design, vehicles are classified as (i) passenger car and single-unit trucks, (ii) buses and (iii) trucks. [Table 3.2](#) illustrates how the design vehicle serves as control on some roundabout geometric features. [Section 2.1.1 and 2.1.2 of AASHTO Policy on Geometric Design of Highways and Streets³](#) present the dimensions and turning paths for a variety of vehicles. Large vehicles such as the WB-67 trucks (or oversized/overweight (OSOW) vehicles where anticipated) may need to be addressed at intersections on collector roads, major arterial streets and highways. Vehicles such as fire engines and single-unit trucks should be considered in urban areas on local street intersections. In rural areas, farming or mining equipment may govern the choice of design vehicle. OSOW (other specialized design) vehicle corridor through urban and rural areas should be analyzed for continuity.

TABLE 3.2 Design Vehicle Selection Based on Roundabout Geometric Feature Type

| Feature Type | Design vehicle | | |
|----------------------------------|----------------|-------|--------|
| | P + SU * | Buses | Trucks |
| Inscribed circle diameter | X | X | O |
| Circulatory roadway width | O | O | X |
| Entry width | X | X | O |
| Entry radius | X | X | O |
| Exit width | X | X | O |
| Right turn curb radius | X | X | O |
| Sight distance/ visibility splay | O | X | X |

* passenger car and single-unit truck including three-axle single-unit truck.
 X..... Not considered for design.
 O.....Considered for design.

The design vehicle and its swept path requirements may be different for the various paths through a roundabout. For example, the straight through movement at a particular roundabout may have to

accommodate a large vehicle, say WB-67, whereas the left and right-turning movements may only need to accommodate single-unit trucks and or buses. This can occur where particular large vehicles are restricted to certain routes or from entering certain areas, and consequently their turning movements at a roundabout are restricted. Also, the volumes of a particular type of large vehicle may be extremely low on particular turning movements.

To the extent that modern roundabout design involves the use of computer-aided design (CAD), several programs are available to demonstrate the adequacy of the design vehicle in the critical turning movements (based on the footprints of the design vehicle swept path on an assumed travel path, see [Figure 3.3](#)). Computer programs such as *VPATH*, *AUTOTURN*, and *AUTOTRACK* are examples. These programs may also be used to check the ability of a roundabout to accommodate any oversized/overweight vehicles (refer to [Section 3.7](#) for large trucks and oversize/overweight vehicle accommodation). A visualization program, such as *VISSIM*, can be used to demonstrate simulated travel paths and swept paths on a scaled aerial photo image. This may determine location footprint and the reduction of impacts to adjacent areas.

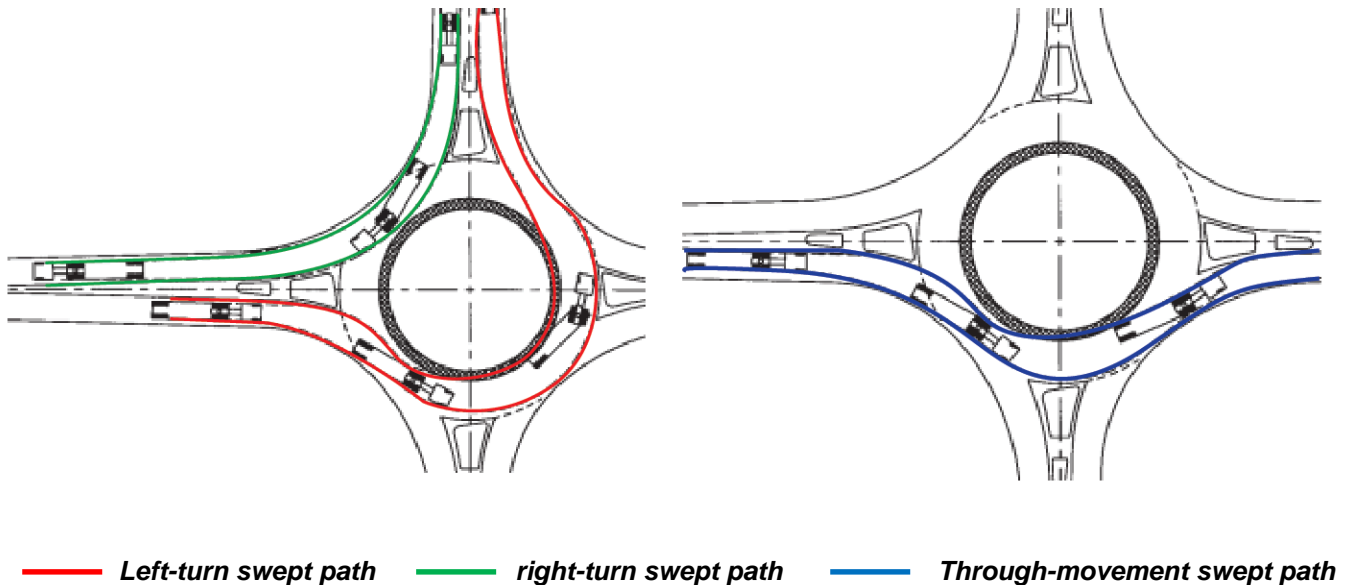

Figure 3.3– Illustration of Vehicle Swept Path Check (Source: FHWA¹)

3.4 Design Speed

The safety and operational performance of a roundabout is ensured by the speed of vehicles entering, circulating and exiting. Maintaining relatively low speeds is important for efficient roundabout operation. The recommended absolute entry design speeds for single and multilane roundabouts are 25 mph and 30 mph, respectively (see Exhibit 6-7 of [NCHRP 672²](#)). It is desirable to use graduated regulatory speed limit to and exiting roundabouts.

The differential speeds between conflicting traffic streams should not be more than 5 to 12 mph. These values are typically achieved by providing low speed for the fastest entering movements (see [Section 3.8.1](#) for fastest vehicle path analysis). Where approaches and entries differential speeds exceed 12 mph, it may be desirable to introduce geometric or cross-sectional features (e.g. introducing curves or reducing lane widths prior to entries) to reduce the speed of approaching traffic prior to the entry curvature.

3.5 Size, Position, and Alignment of Approaches

In order to ensure that the design achieves its purpose, the size of the roundabout is usually determined by balancing the need to achieve good deflection and minimizing right-of-way impacts on existing property. An initial sketch on a 1/250 or 1/500 topographical map with the existing road network will provide a guide in the initial sizing, positioning and possible re-alignment of approaches.

There can be various alternatives for approach alignment at entry points: offset left of center, radial (through center), and offset right of center. Each alternative has its own advantages and disadvantages. Although radial alignment and, very rarely, offset right may be used in limited conditions, the preferred alignment is offset left. Offsetting the approaches to the left of the center (20 to 30 feet or more) allows for an increased deflection and reduced speed prior to the yield point. In high speed environments, such as rural highways, curves may be introduced to transition approach design speeds to the desired roundabout entry speeds. [Figure 3.4](#) shows typical approach alignment and transition curves to generate desired speed reduction at entries.

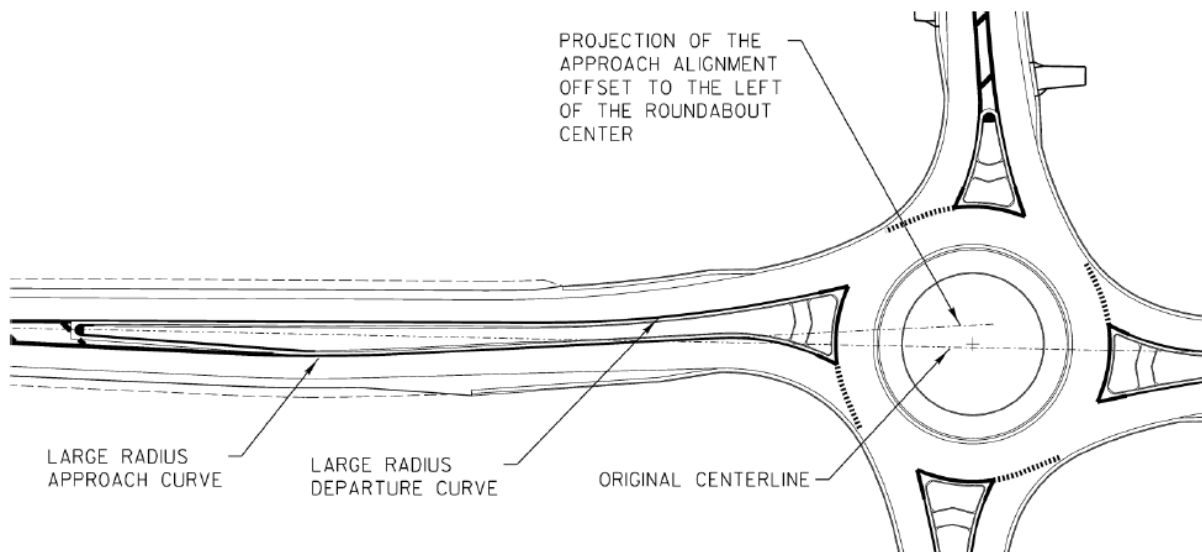

Figure 3.4 – Roundabout Entry Deflection (Source: WisDOT⁴)

In some cases (e.g., 45 mph or greater approach speeds), designers may consider the use of a chicane to manage roundabout entry speeds. A chicane consists of a series of three curves each with a smaller radius as the vehicle approaches the roundabout entry. [Figure 3.5](#) is a schematic of a chicane. [Figure 3.6](#) gives recommended values for each of the three radii across various approach speeds.

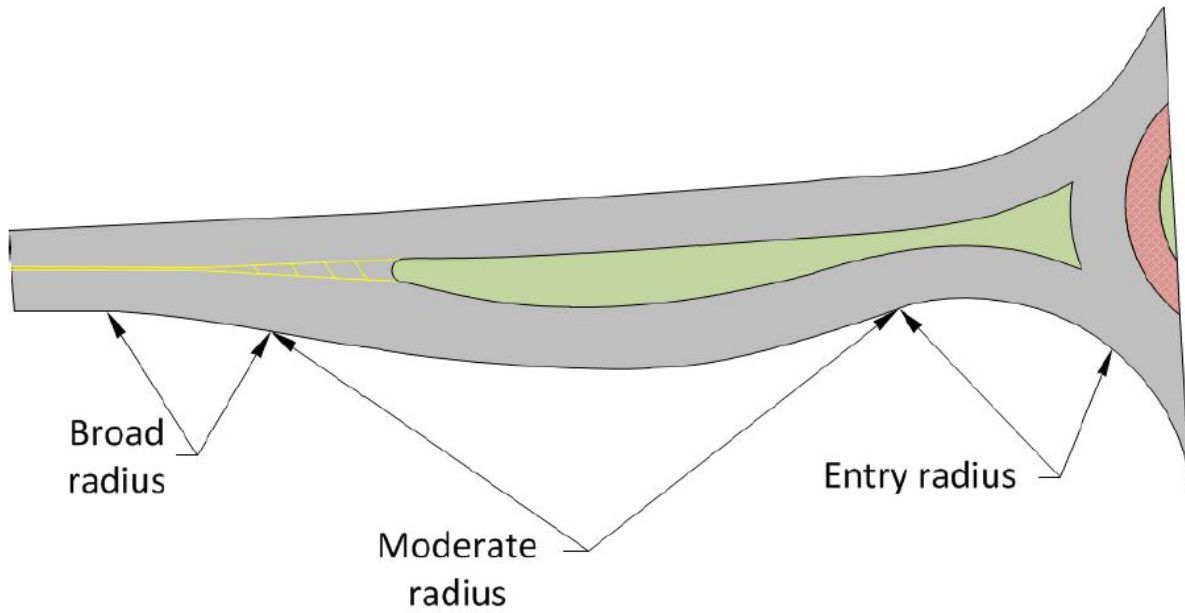

Figure 3.5 – Chicane Schematic (Source: WSDOT⁵)

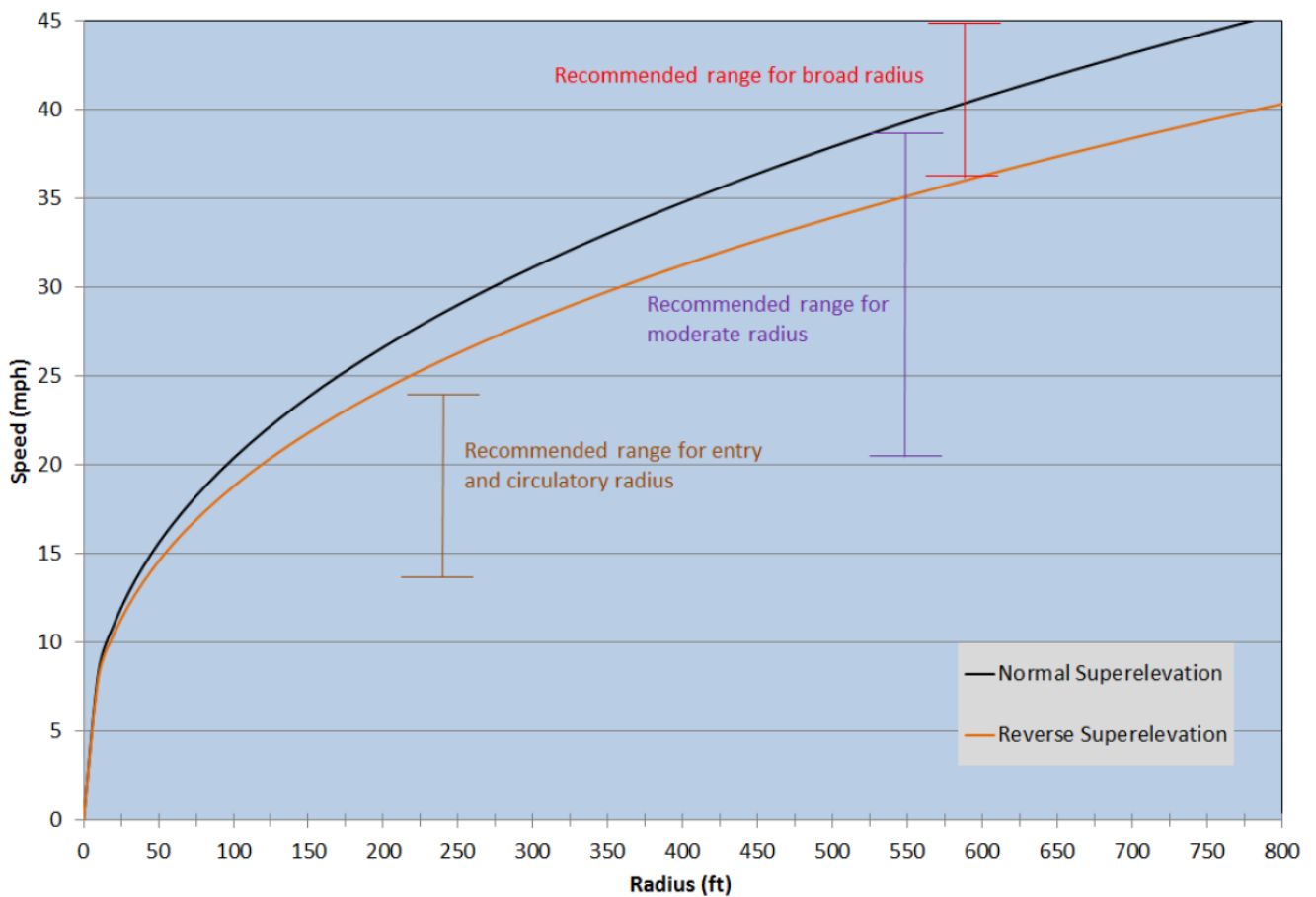

Figure 3.6 – Relationship Between Approach Speeds and Chicane Curves (Source: WSDOT⁵)

3.6 Design Considerations

This section discusses individual roundabout design elements, while [Section 3.7](#) provides detailed discussion of the design procedures for single-lane and multilane roundabouts. The design of multilane roundabouts is limited to two-lane entry design only in this manual. Three cases are used to illustrate the different types of multilane roundabouts (MLS). Case 1 designs have a single white pavement marking line separating the entry lanes. Large trucks are expected to encroach into adjacent lanes as they approach, enter, circulate, and exit the roundabout. Case 2 and 3 designs have painted gores that provide separation between the entry lanes. For Case 2, large trucks can stay in-lane as they approach and enter the roundabout, but may need to encroach into adjacent lanes as they circulate and exit the roundabout. Case 3 designs ensure trucks stay in-lane throughout the maneuvering process (see [Section 3.7.2](#) for detail discussion on each case). Additionally, treatments of roundabouts to accommodate OSOW vehicles are discussed in [Section 3.7.3](#).

3.6.1 Number of Entry Lanes

The number of entry lanes controls the capacity and or level of service on an approach. Irrespective of capacity considerations, it is generally important on arterial roads that lane continuity is available throughout roundabouts. Thus, a roundabout serving a two-lane approach on an arterial road should have at least two entry lanes even if the calculations show that one-lane would have adequate capacity. In addition, if an existing roadway is overdesigned a road diet (lane reduction) with roundabout could be used to reduce lane widths and increase livable spaces. A single lane approach may flare to multilane at the entry point, matching equal number of circulatory lanes. This can help to reduce delay.

3.6.2 Number of Circulatory Lanes

The number of circulating lanes from any particular approach must be equal to or greater than the number of entry lanes on that approach. It is not essential to provide the same number of circulating lanes for the entire length of the circulating roadway as long as the appropriate multilane exits are provided prior to reducing the number of circulating lanes. This is illustrated in [Figure 3.7](#) and [Figure 3.8](#).

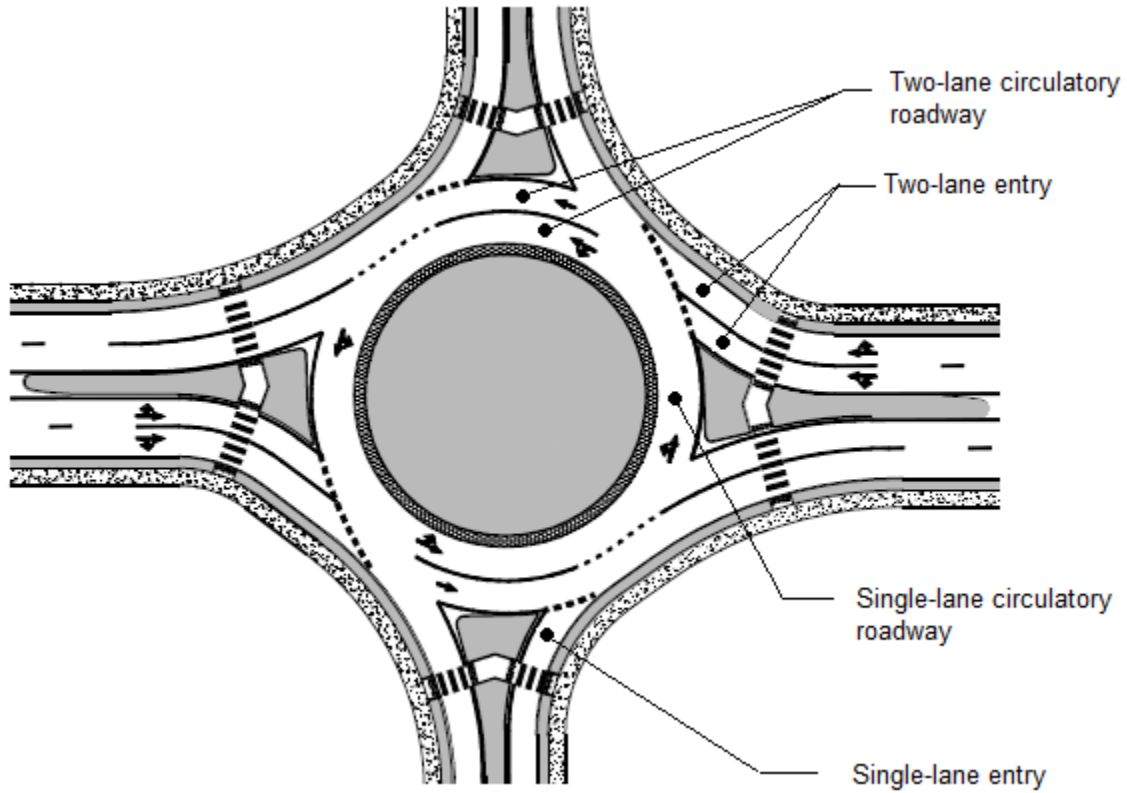

Figure 3.7 – Multilane Roundabout Partially Reduced to One Lane on Circulatory Roadway (Source: NCHRP 672²)

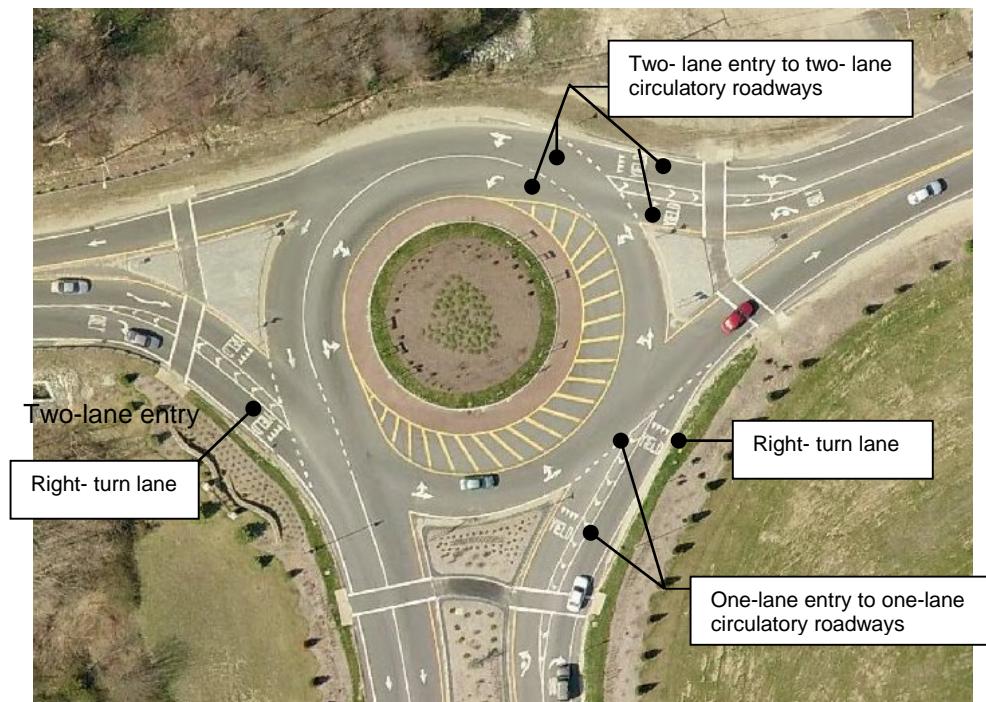

Figure 3.8– Example of Multilane with Circulatory Roadway Lanes Matching Entry Lanes (Source: FHWA¹)

3.6.3 Number of Exit Lanes

The number of exit lanes must not be greater than the number of circulatory lanes. Where a right turn bypass lane exists, this should be accommodated on the exit lanes (see discussion on bypass lane in Section 3.7.4.2). On multilane roundabouts, the number of exit lanes is based on the lane usage as determined by the pavement markings on the approaches. At some multilane roundabouts a two-lane exit is reduced to one-lane or from three lanes to two lanes beyond the exit to match mid-block conditions. It may, therefore, be necessary to provide a merge area on the departure. It is desirable that exit lanes extend from the exit, a distance between 50 feet (25 for slower speeds) to 300 feet depending on volume, followed by a merge length based on a 20:1 to 30:1 taper rate as shown in Figure 3.9. It is also desirable that a run-out (e.g. a shoulder) area be provided as an escape path in the event of potential conflict between merging vehicles. In urban areas with low speeds and Right-of-Way restrictions, shorter lengths may be used in accordance with AASHTO³ or existing ALDOT⁶ guidelines for taper rates.

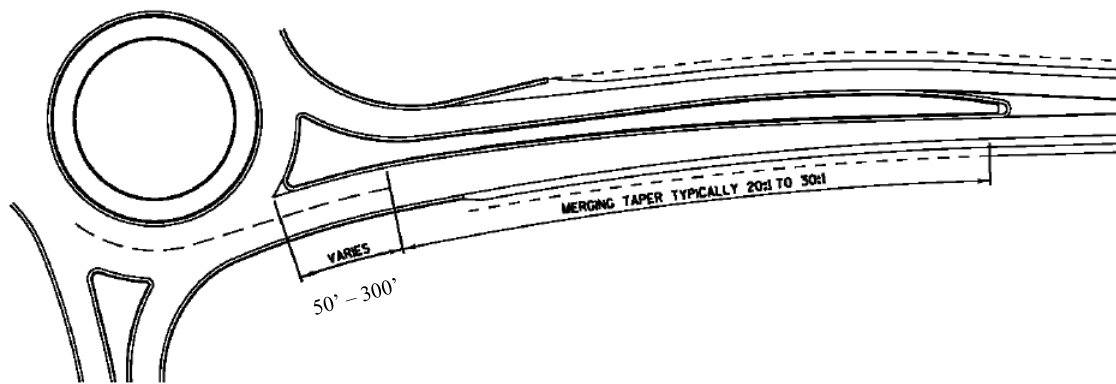

Figure 3.9 – Exit Lane and Taper (Source: WisDOT⁴)

3.6.4 Inscribed Circle Diameter (ICD)

The inscribed circle diameter (see Figure 3.1) defines the footprint of the roundabout and may be used for assessing the need to account for utility and pedestrian areas for potential Right-of-Way (ROW) impacts. It must be large enough to accommodate the design vehicle while maintaining slower speeds for small vehicles. The ICD is the sum of the central island diameter (plus truck apron width if applicable) and twice the circulatory roadway width. Table 3.3 provides typical ranges of inscribed circle diameter for various roundabout types.

TABLE 3.3 Typical Inscribed Circle Diameter Ranges* (Source: NCHRP 672²)

| Roundabout Configuration | Typical Design Vehicle | Common Inscribed Circle Diameter Range (ft) |
|--------------------------------|------------------------|---|
| Single-Lane Roundabout | B-40 | 90 to 150 |
| | WB-67 | 130 to 180 |
| Multilane Roundabout (2 lanes) | WB-67 | 165 to 220 |

* Assumes 90° angles between entries and not more than four legs. List of possible design vehicles is not all-inclusive

3.6.5 Splitter Islands

Splitter islands should be provided on all roundabouts. Their purpose is to provide refuge for pedestrians, assist in controlling speeds, guide traffic into the roundabout, physically separate entering and exiting traffic streams, and deter wrong way movements. The lateral restriction and funneling provided by the splitter island encourages speed reduction as vehicles approach the entry point. The minimum width of the splitter island depends on the type of material making up the splitter island. The minimum width is 3 feet at the start of landscaped splitter islands and 2 feet at the start of hardscape splitter islands, with additional offset to lane striping. Within the pedestrian refuge area, a minimum of 6 feet of island width is required. The crosswalk width (length of island at refuge area) requires a minimum of 7 feet, the desired width being 10 feet (NCHRP 672²). ALDOT⁶ guidelines for island design should be followed for the splitter island design. This includes using larger nose radii at approach corners to maximize island visibility and offsetting curb lines at the approach ends to create a funneling effect. Figure 3.10 and Figure 3.11 show typical minimum splitter island dimensions and typical minimum nose radii and offset dimensions respectively. Longer splitter island widths in excess of 200 feet are desirable on high speed roadways. The requirement for longer splitters could, however, greatly increase cost and ROW impacts, and may create access issues. A balance design requiring good engineering judgment should, therefore, be exercised to achieve optimum design.

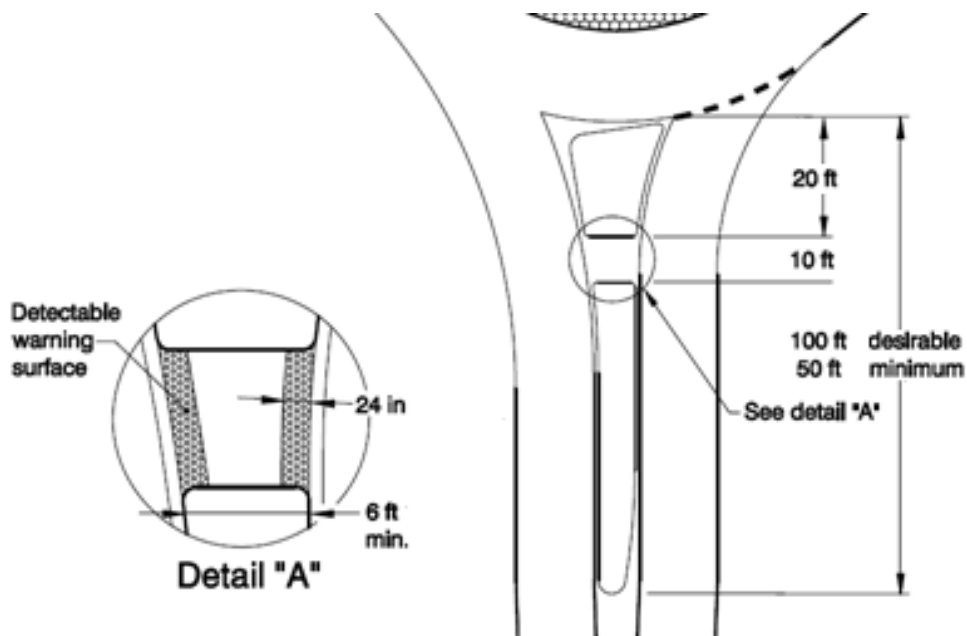

Figure 3.10 – Typical Minimum Splitter Island Dimensions (Source: NCHRP 672²)

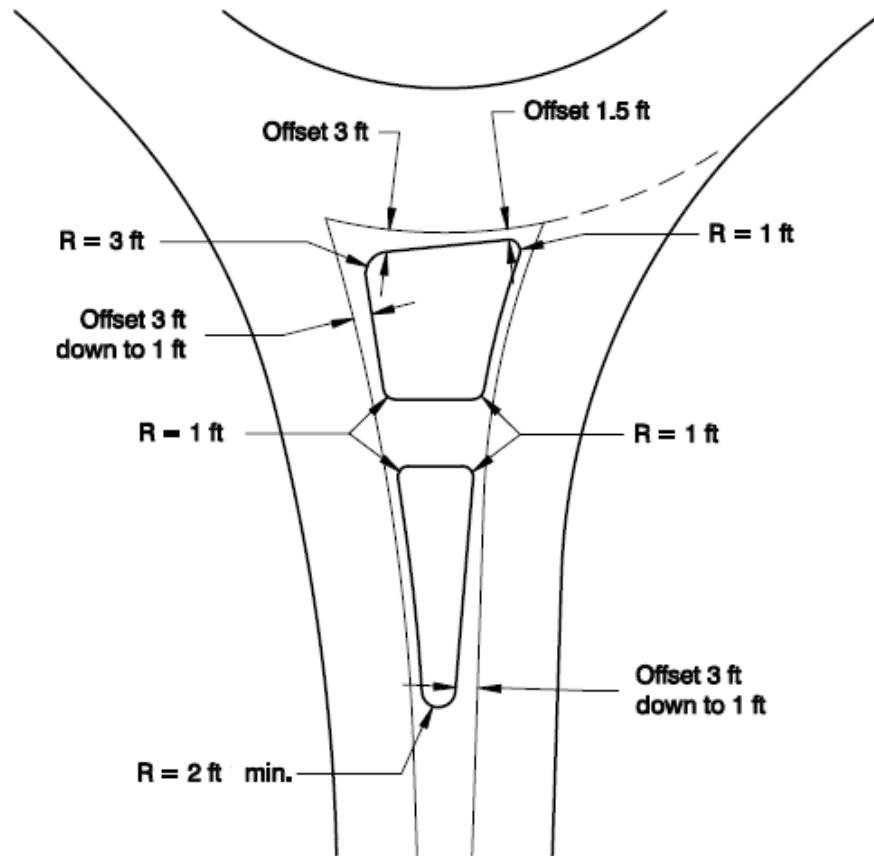

Figure 3.11 – Typical Minimum Splitter Island Nose Radii and Offset Dimensions (Source: NCHRP 672²)

3.6.6 Central Island

The central island is the raised area in the center of a roundabout around which traffic circulates. It should preferably be circular in order to achieve constant speeds in the circulatory roadway. However, elliptical, oval, or other irregular shapes are not uncommon and may be needed at irregularly-shaped intersections. These geometries result in differential speeds due to changes in curvature of the circulatory roadway. They should be used at locations where the operating speeds are low. Wherever possible, roundabout central islands should be raised to improve visibility of the island for approaching drivers. Care should be taken to ensure landscaping on the central island does not obscure entering driver's left line of sight with circulatory drivers. A recommended minimum of 6ft wide perimeter landscaping is desired around central islands to ensure adequate stopping sight distance (NCHRP 672²).

The size of the central island depends on the inscribed circle diameter and the circulatory roadway width as required by the design vehicle. In high speed environments larger central island diameters are encouraged to enable better entry and approach geometry to reduce the high approach speeds. The design of these roundabouts is more critical than that for roundabouts located in low speed areas.

3.6.7 Truck Apron

Truck aprons are used to facilitate the movement of large vehicles while maintaining relatively narrow circulatory roadway width. They are typically designed around the central island but can also be provided along splitter islands or outside curb of entries and exits to accommodate large vehicle maneuvers where there are right-of-way constraints. Trailer off-tracking is permitted on the truck apron in order to negotiate roundabouts. The truck apron is raised from the vehicle lane by a 2 to 3 inch mountable curb and must be easily distinguishable from the roadway as well as any pedestrian facilities. For this reason, a colored textured concrete pavement is commonly used (see [Figure 3.12](#)). Recommended minimum truck apron width is 12 feet on roundabouts and should have a cross slope of 1 – 2% away from the common central island and towards the roadway.

Roundabouts, both single-lane and multilane, should be provided with truck aprons around central islands. Outside truck aprons may be provided at entries and exits to accommodate right turn movements at certain locations. [Figure 3.13](#) provides the relationship between typical circulatory turning widths for normal roundabouts, to be used as guidance to size truck aprons on roundabouts. The truck apron width (h) is determined by subtracting the “g” value required by a bus design vehicle from the “g” value required by a WB-67 truck for a particular ICD.

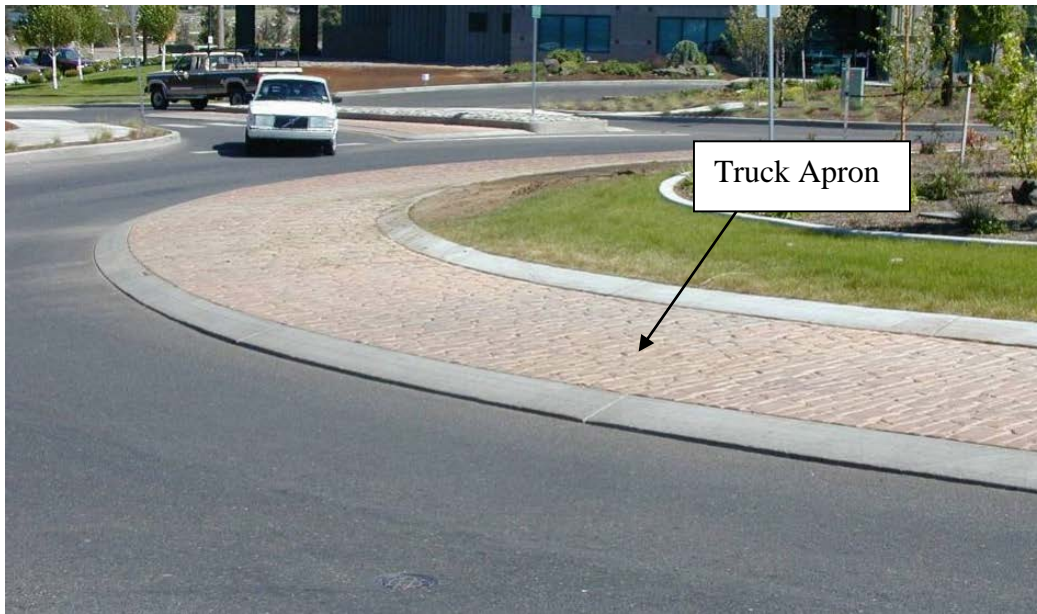
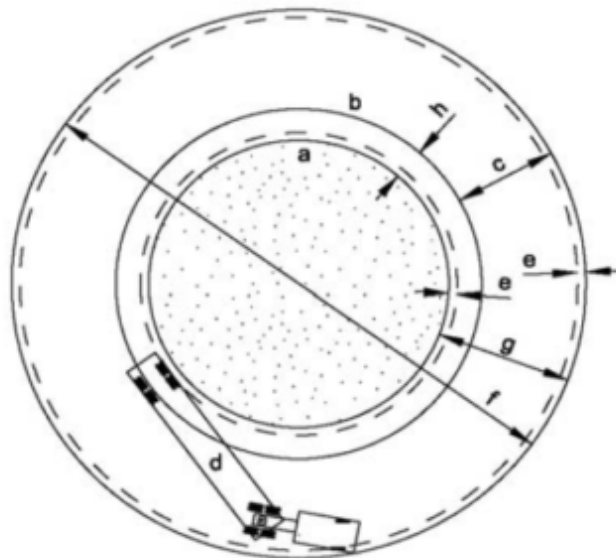

Figure 3.12 – An Example of Truck Apron⁷

Typical Circulatory Turning Widths for Normal Roundabouts



Legend

- a Raised vertical curb face at central island.
- b Low profile mountable curb at apron.
- c Remaining circulatory roadway width is 1.0 - 1.2 times the maximum entry width.
- d Design vehicle.
- e 2 feet clearance from wheels based on desirable 'c' values.
- f Inscribed circle diameter (ICD).
- g Width between curbs (face to face).
- h To obtain a circulatory roadway width for single lane roundabouts that allows a bus not to need the truck apron, determine 'g' for a truck then subtract 'g' for the bus to obtain the truck apron width (h).

| Circulatory Turning Widths (g) for Normal Roundabouts (ft) | | |
|--|----------------|-------|
| Inscribed Circle Diameter (ft) | Design Vehicle | |
| | City-Bus | WB-67 |
| 100 | 20 | N/A |
| 110 | 19 | N/A |
| 120 | 19 | NA |
| 130 | 18 | 38 |
| 140 | 18 | 36 |
| 150 | 17 | 33 |
| 160 | 17 | 32 |
| 170 | 17 | 30 |
| >180 | 17 | 29 |

Notes: the turning widths for WB-67 include truck apron widths

Figure 3.13 – Turning widths and Truck Apron Size for Single-lane Roundabout

3.6.8 Entry and Exit Widths

The width of the entry should be able to accommodate the swept path of the entering design vehicle. This is measured from the point where the entrance line intersects the left edge of traveled way to the right edge of the traveled way, along a line perpendicular to the right curb line as shown in Figure 3.14. Typical entry widths for single-lane entrances range from 19 to 22 ft wide. For a two lane entry, typical entry width ranges from 28 to 32 ft with individual lanes ranging from 12 to 15 ft. Where provision of adequate entry lane widths for large vehicles lead to inadequate entry curvature the entry lane widths should be reduced. Here, truck aprons along splitter islands and gore areas between travel lanes can be provided to accommodate for the movement of larger vehicles while maintaining good entry curvature (see Figure 3.15).

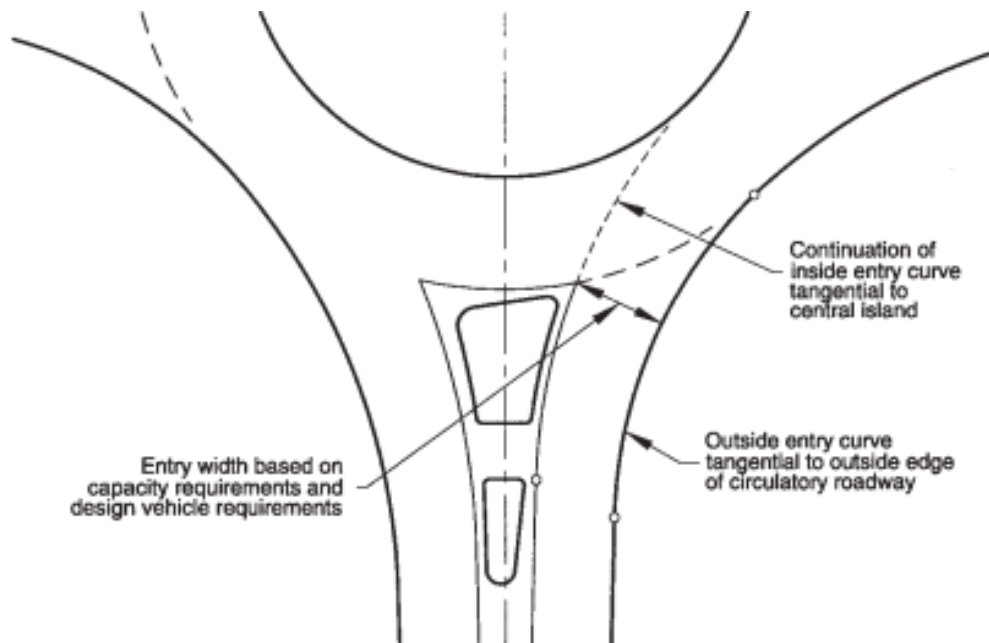

Figure 3.14– Single-Lane Roundabout Entry Design (Source: NCHRP 672²)

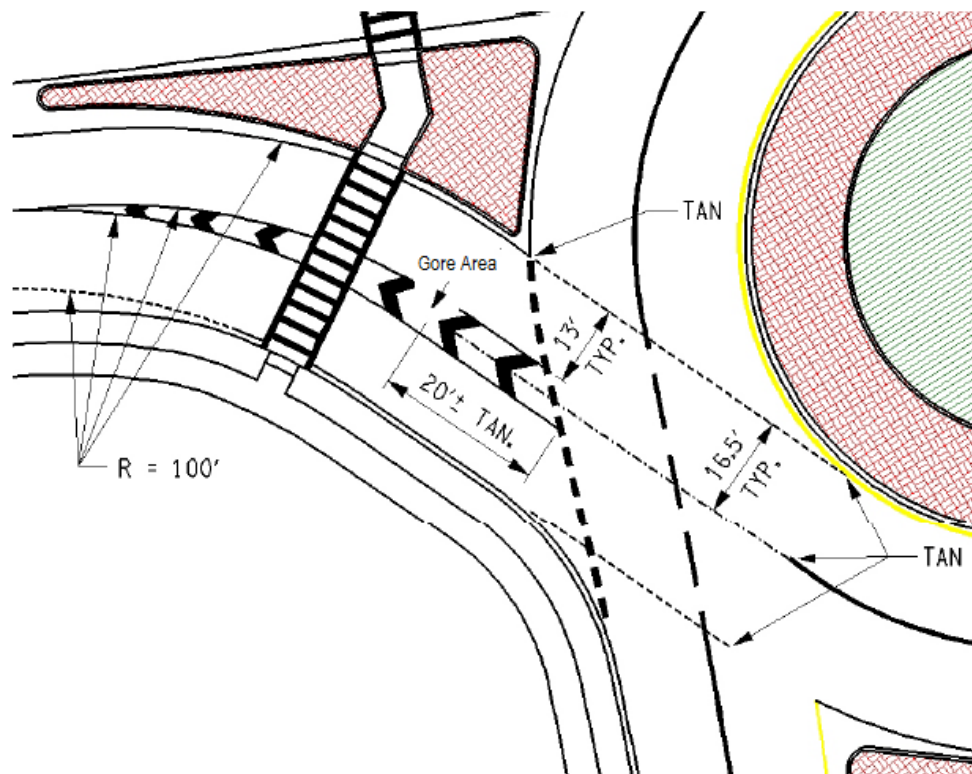

Figure 3.15 – Gore Area between Travel Lanes (Source: NYSDOT⁸)

Relatively large radii should be provided at exits to enable traffic to leave the circulating roadway as efficiently as possible. The exit width should, therefore, be based on the number of traffic lanes required plus any required offsets to curbs. For roundabouts in urban environments, where there is high pedestrian activity across exits, it is desirable to provide a smaller radius on the exits to reduce exit speeds. Large separations between legs should be avoided to prevent circulating-exiting traffic conflicts (see [Figure 3.16](#)). Where the existing geometry does not permit shorter separation, path realignment may offer a good solution (see [Figure 3.17](#)). Typical exit widths range from 28 to 32 ft on MLRs.

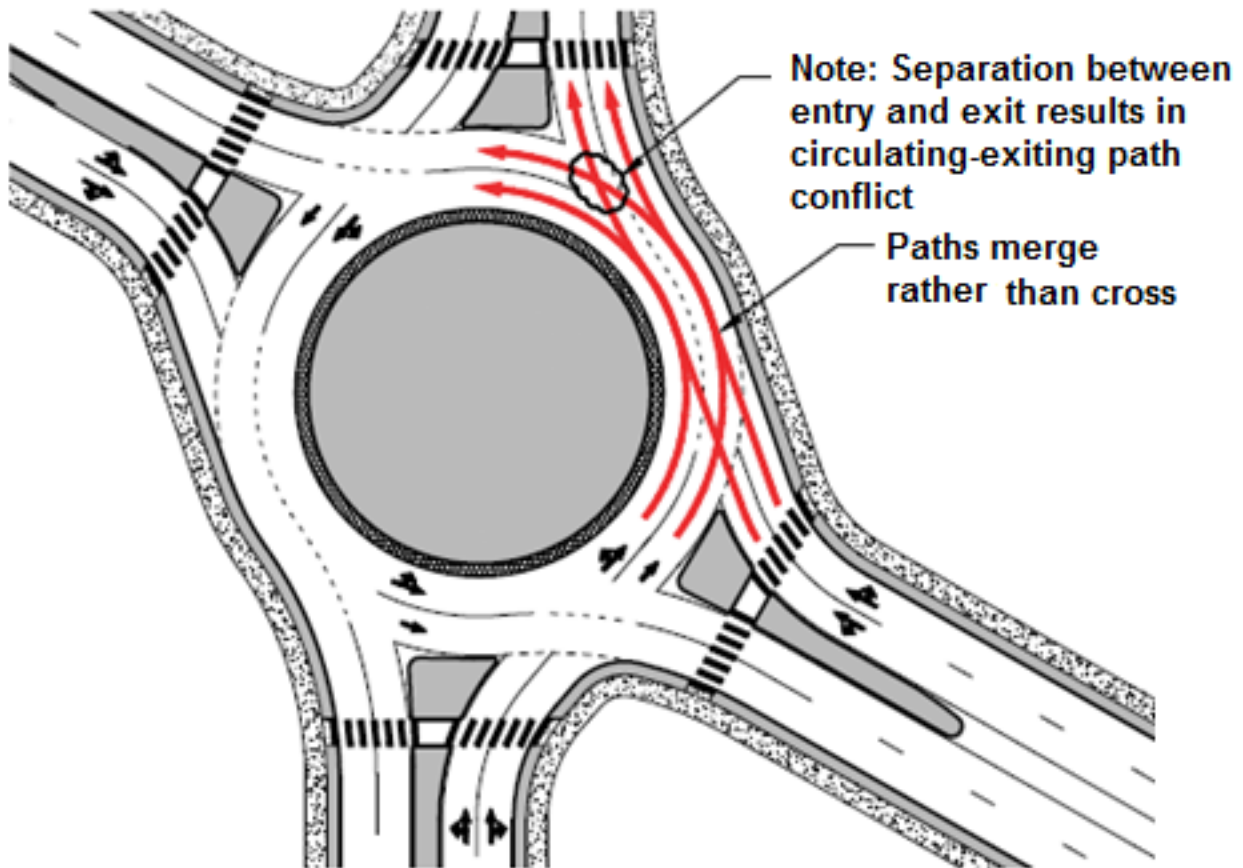

Figure 3.16 – Exit–Circulating Conflict Caused by Large Separation between Legs (Source: NCHRP 672²)

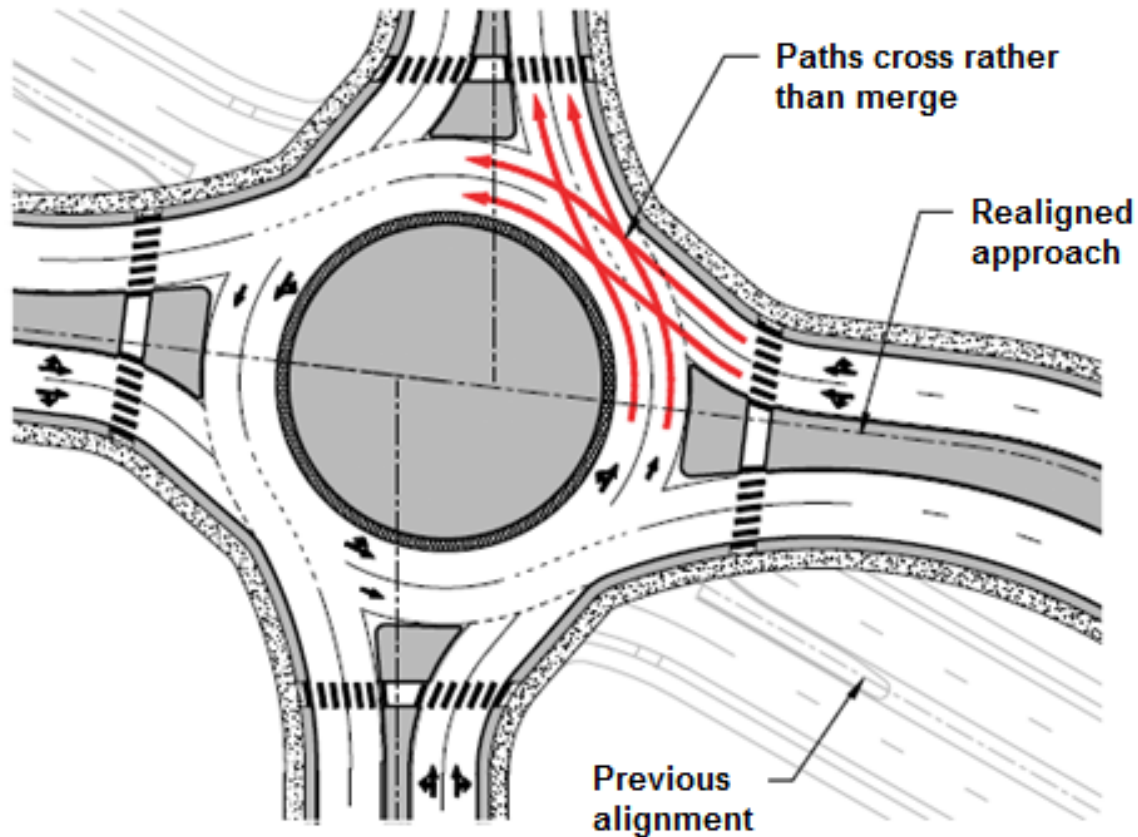

Figure 3.17 – Realignment to Resolve Exit–Circulating Conflicts (Source: NCHRP 672²)

3.6.9 Entry Geometry Design

The entry treatment, involving either single or multiple curves leading to the circulatory roadway, should achieve lower relative vehicle speeds within the roundabout. Entry curb radii should be selected to produce appropriate design speeds along the fastest path. Typical entry radii range from 65 to 110 ft. The splitter island edge line should be tangential with the central island and likewise, the outside curb line of the entry should be tangential to the outside edge of the circulatory roadway as shown in [Figure 3.17](#).

At multilane roundabouts, entry radii should typically range between 65 to 150 ft to encourage adequate natural paths and avoid sideswipe collisions on entry. Where the differential speed between the approach speed and the entry speed (as determined by the fastest path vehicle) is greater than 12 mph, the speed of the approaching vehicle should be reduced prior to the entry curve. An approach-to-entry lane separator (gore area) may aid in both lane alignment into the appropriate circulatory lane and in speed control (see [Figure 3.15](#)). This use of a separator will also deter a large vehicles' rear off-tracking from encroaching into the outside lane.

Flaring an entry from one lane to two or from two to three is not uncommon. This is done to create additional entry capacity without extensive mid-block widening. This is especially important where lane utilization for all turning movements (left and right turning traffic) is deemed to be uniform. It is then ideal to split the approach width at a point where the lane width reaches an overall width of 19 ft (see [Figure 3.18](#) and [Figure 3.19](#)).

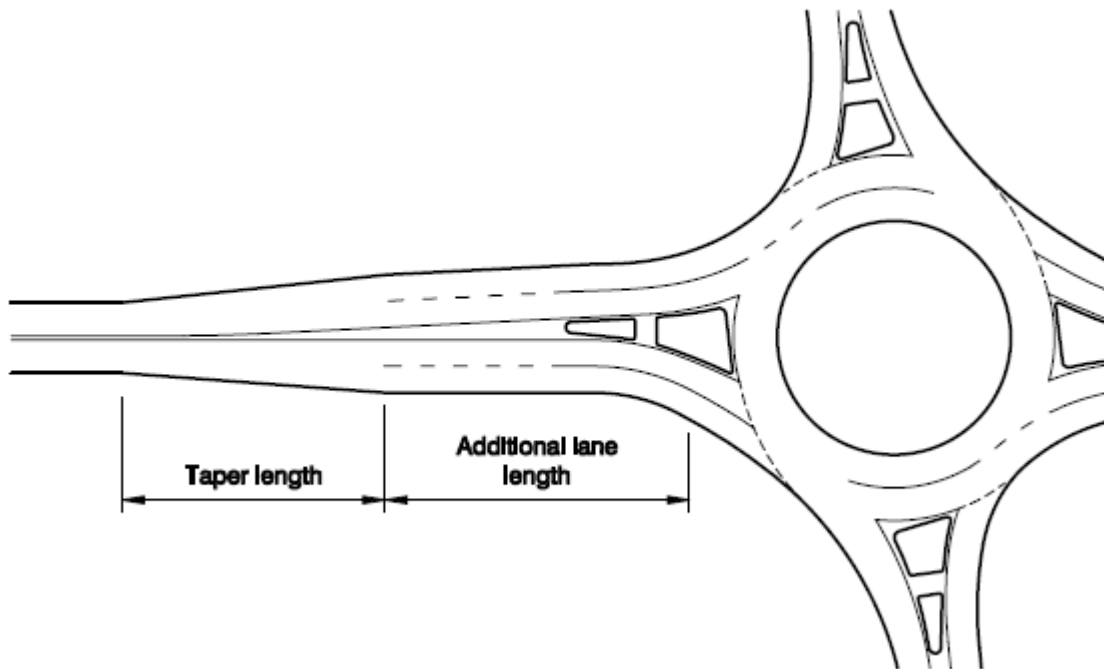

Figure 3.18 – Mid-block Widening by of Approach Lane (Source: NCHRP 672²)

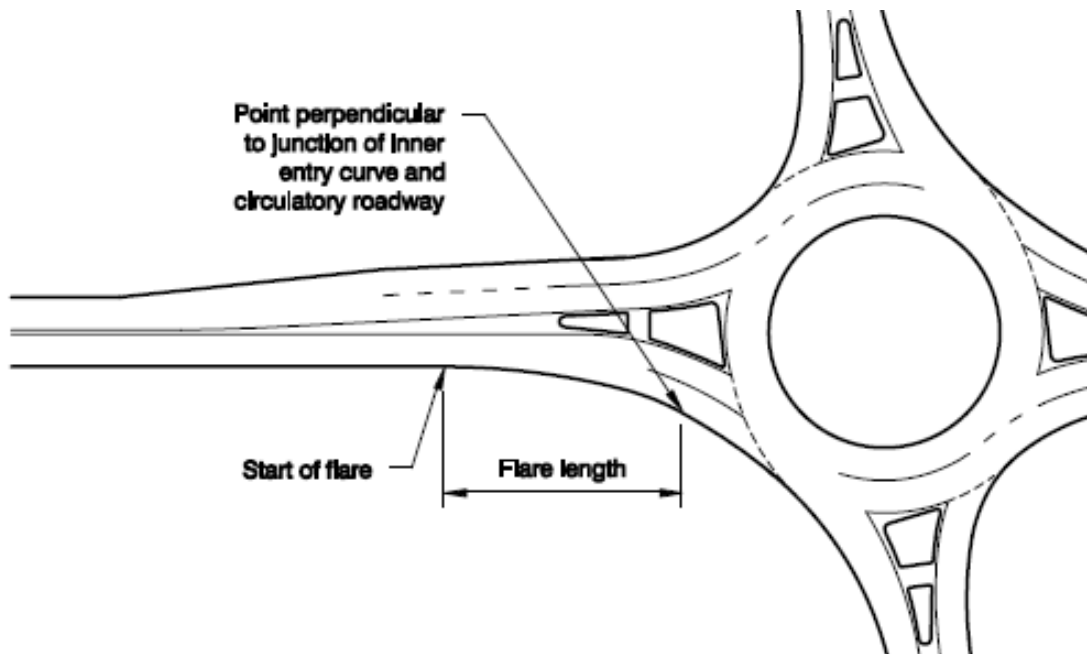

Figure 3.19 – Approach Widening by Entry Flaring (Source: NCHRP 672²)

3.6.10 Exit Geometry Design

Exit geometry design must consider the environment; (urban versus rural), pedestrian demand, the design vehicle, and physical constraints. Typical exit curb radius in urban areas ranges from 100 to 200

ft with a desirable minimum radius of 50 ft. On rural segments or where there are high truck percentages, larger exit radii (300 ft to 800 ft) may be used taking into consideration the need to maintain balance of low exit speeds upstream of pedestrian crosswalks. The outer exit curb radius is constructed tangentially to the outside edge of the circulatory roadway and inner edge radius of the exit roadway tangential to the central island as shown in [Figure 3.20](#).

3.6.11 Circulatory Roadway Width

The circulatory roadway width for a single-lane roundabout should accommodate the turning movements of the design vehicle. It should be typically about 18 to 24 ft wide from curb face to curb face. The lane width must ensure a balance in roadway usage by design vehicles and smaller vehicles so that, it is not too wide to encourage side-by-side movement. The circulatory roadway width should typically be designed to accommodate a bus design vehicle. Truck aprons should be provided around central islands to maintain relatively narrow circulatory roadways to constrain vehicular speeds of through traffic. Circulatory stripes and/or markings offset from central island may also aid in giving smaller vehicles a narrower lane path. Offsetting the outside edge line from outer circle curb can aid the larger vehicle in turning wide around the circle, while maintaining narrow roadway for small vehicles.

The circulatory roadway width of two-lane roundabouts needs to accommodate at least the movement of the largest vehicle normally expected to use the roundabout (i.e. the design vehicle). Initial selection of circulatory roadway widths required to accommodate for one large vehicle turning left alongside a passenger car are shown in [Table 3.4](#). The widths given in the table should ensure that adequate but not excessive pavement width is provided. Where a site has a high volume of large vehicles, it may be necessary to design for two large vehicles turning alongside each other (e.g. a semi trailer and a single unit truck/bus). In some situations (e.g., areas with very heavy freight traffic) it may be necessary to design for two semi-trailers turning together (see [Section 3.7.2](#) for details on this type of design). The circulatory roadway width can have varying widths at entries depending on the number of approach lanes at each entry. A two-lane road width may be provided on an approach leg with two entry lanes on the major through highway while a single lane width provided for the single minor side road.

TABLE 3.4 Initial Ranges of Design Elements

| Design element | Single-Lane | Multilane (2 lanes) |
|--------------------------------|-------------|---------------------|
| Inscribed circle diameter (ft) | 90-180 | 165-220 |
| Circulatory roadway width (ft) | 18-24 | 14-18 per lane |
| Entry width (ft) | 14 -18 | 12-17 per lane |
| Entry radii (ft) | 65-110 | 65-150 |
| Exit radii (ft) | 300-800 | 300-800 |
| Truck apron width (ft) | 12-20 | 12-20 |

Small Exit Radius Design

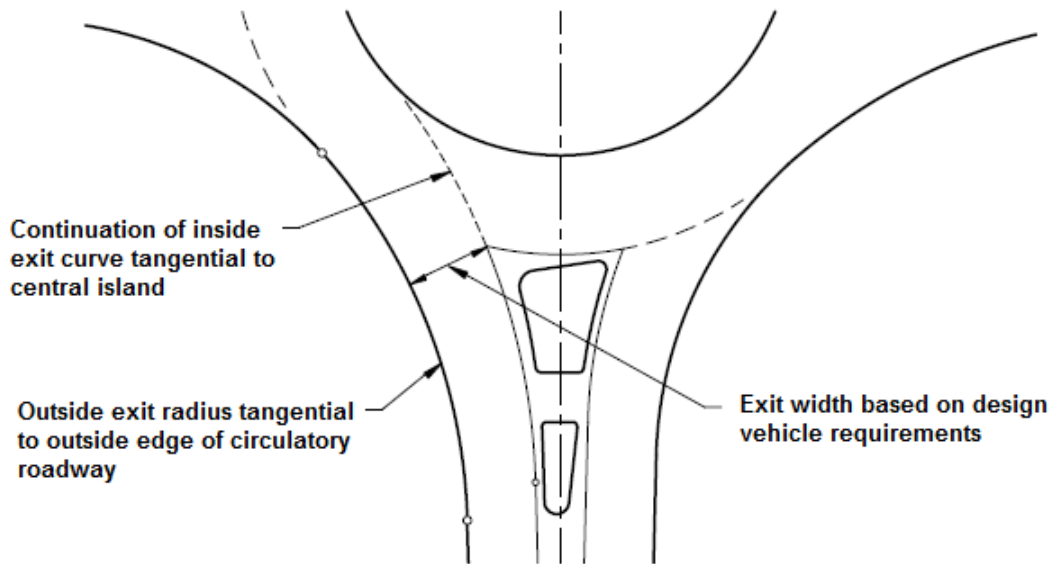

Large Exit Radius Design

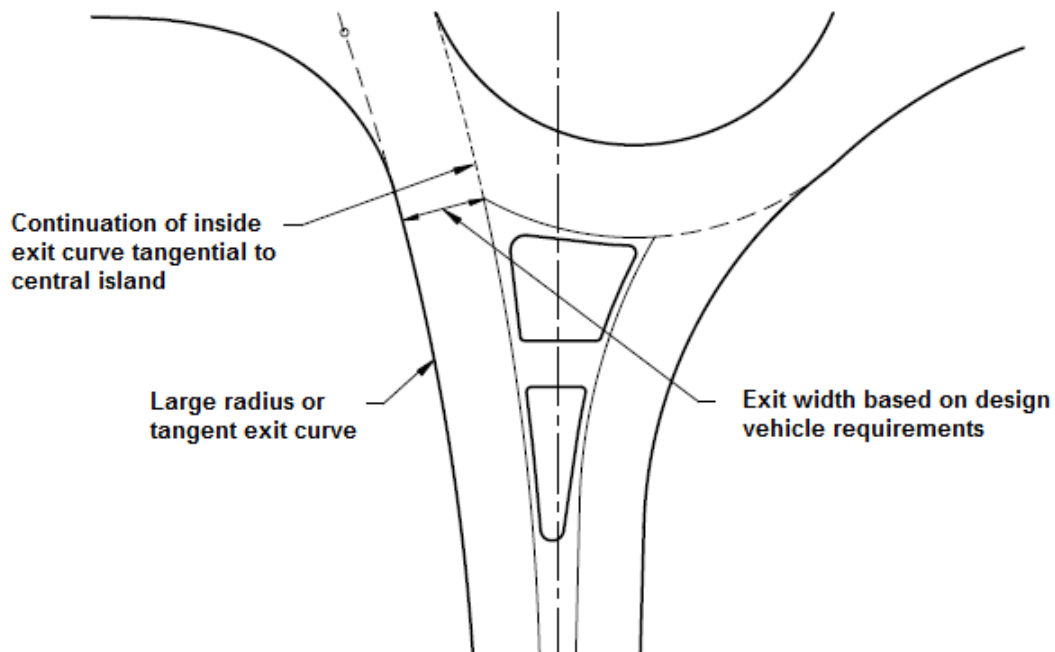

Figure 3.20 – Single-Lane Roundabout Exit Design (Source: NCHRP 672²)

3.7 Design Procedures for Single-lane and Multilane Roundabouts

3.7.1 Single-Lane Roundabouts

Single-lane roundabouts are designed to accommodate AASHTO³ City-Bus design vehicle on local residential streets. At locations with high proportion of truck traffic exceeding 5%, the design vehicle shall be an AASHTO³ WB-67 truck. Truck aprons are to be installed on all single-lane roundabouts.

Accommodating trucks requires gradual, sweeping entry radii which help right-turning trucks navigate tight curves at entries. This typically requires an entry radius of 65 ft or larger, (while entry radii of 100 to 110 ft are common) and entry angles between 30-40 degrees. Entry and exit widths typically range between 18 to 22 ft wide and circulatory roadways typically about 18 to 24 ft wide from curb face to curb face to accommodate trucks. The entry and exit widths may be wider at skewed intersections or where swept path analysis for Oversize/Overweight⁹ (OS/OW) vehicles suggests a wider width accommodation. Entries wider than approximately 18 ft (curb face to curb face) may require pavement hatched striping along the splitter island to reduce width. This technique ensures that trucks utilize hatched areas while still maintaining narrow widths at single-lane entries. Splitter island widths at entries and/or exits can occasionally be reduced to allow better accommodation of turning trucks, especially at locations with ROW constraints. The area can then be pavement marked as described above.

Single lane roundabout ICDs often range from 130 ft to 150 ft for WB-67 design vehicle. However, providing an ICD that is in the higher end of this range (i.e., 140 to 150 ft) is typically beneficial if ROW is available. This diameter range can readily accommodate all truck movements while still meeting other design requirements. Selection of the ICD size is dependent on the constraints at each intersection location, the alignment of the approaching roadways, and the selected design vehicle. . An example of single-lane roundabout is shown in [Figure 3.21](#).



Figure 3.21 – Example of Single Lane Roundabout, (Source: GHD¹⁰, Jackson WI)

3.7.2 Multilane Roundabouts

Multilane roundabouts shall be designed to accommodate legal size large trucks (trucks, which by Alabama law do not require legal permits to use state highway systems). Depending on the relative position of vehicles at entries and circulatory roadways, three categories of design methods for accommodating trucks have been identified as *Case 1*, *Case 2*, and *Case 3*. These were introduced in Section 3.6, and are presented in detail here. Case 2 is the preferred method. The selection of a particular design method is based on both the road system functional classification where MLRs are to be installed, and proportion of trucks in the traffic mix.

Case 1 designs are implemented only where Case 2 is not feasible within the site-specific constraints. They are designed with a single solid white paint line dividing the entry lanes and allow trucks to encroach into adjacent lanes as they approach, enter, circulate, and exit the roundabout. Case 2 roundabouts are designed to accommodate trucks in-lane as they approach and enter the roundabout, but may require trucks to encroach into adjacent lanes as they circulate and exit the roundabout. They have painted “gore” areas between lanes on the approaches but with narrower circulatory widths to keep car speeds down. Where costs or right-of-way impacts are prohibitively expensive compared to alternate intersection options, or at locations where design truck numbers are between 5 to 10.0%, Case 2 may be considered. Case 3 roundabouts are preferred on state highway systems (interchange ramps, OSOW designated routes) and locations with projected design year truck left turning truck traffic between 11 – 18% (near truck stops and industrial/warehouse districts). They are designed to accommodate trucks in-lane as they approach and traverse the entire intersection. They have a painted “gore” area between lanes on the approaches and are typically designed to allow trucks to stay in lane for through and left turning movements, while right turning trucks may occupy multiple lanes as they exit. Case 3 designs can accommodate OSOW vehicles with little geometric changes such as the provision of outside truck aprons. [Figure 3.22](#), [Figure 3.23](#) and [Figure 3.24](#) are examples of Cases 1, 2 and 3 design methods, respectively.

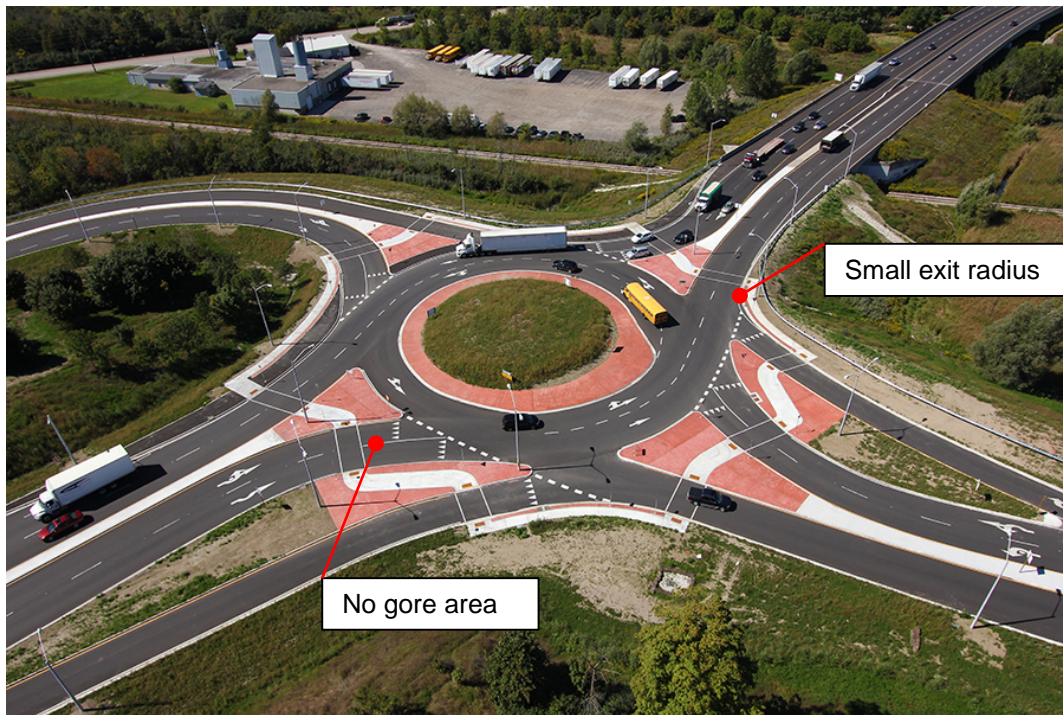

Figure 3.22 – Case 1 Roundabout (Source: GHD¹⁰, Cambridge ON)



Figure 3.23 – Case 2 Roundabout (Source: RTE¹¹)

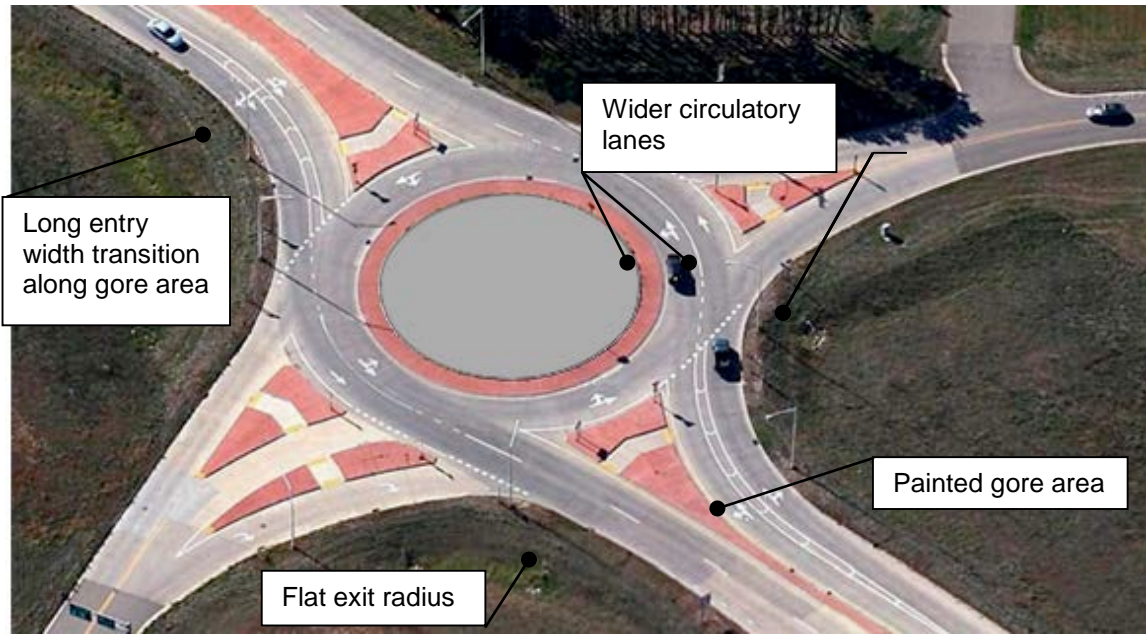

Figure 3.24 – Case 3 Roundabout (Source: RTE¹¹)

TABLE 3.5 Design Parameters for Two-Lane Roundabouts* (Joint Roundabout Truck Study¹²)

| Design element | Case 1 (may be considered on local streets) | Case 2 (preferred on all major roads) | Case 3 (maybe considered on some major roads) |
|---|--|--|--|
| Inscribed Circle Diameter ^a | 150' to 190' | 160' to 210' | 180' to 220' |
| Inner Circulatory Lane Width ^b | 11' to 13' | 13' to 15' | 13' to 15' |
| Outer Circulatory Lane Width ^b | 13' to 15' | 13' to 15' | 15' to 18' |
| Approach Gore Width | Not used | 2' to 6' | 2' to 6' |
| Entry Width ^a | 24' to 28' | 28' to 32' | 32' to 34' |
| Entry Radius | 65' or greater | 65' or greater | 65' or greater |
| Controlling Radius | 65' or greater | 65' or greater, 100' to 130' typical | 65' or greater, 100' to 130' typical |
| Controlling Radius Length | No max, typically 70' or less | No max, typically 80' + | No max, typically 80' + |
| Entry Angle | 16 to 30 degrees | 16 to 30 degrees | 16 to 30 degrees |
| Flared Entry Lane Addition | >100' Generally 100' to 300' | >100' Generally 100' to 300' | >100' Generally 100' to 300' |
| Exit Widths ^a | 28' to 32' | 28' to 32' | 28' to 32' (where large radius or tangential exit used) |

* Based on site conditions, right-of-way constraints, specific design vehicle, and other factors, designers may choose to implement geometries outside these recommended ranges

^a Measurements are from the face of curb to face of curb, (includes 2-ft gutter pans on each side)

^b Measurements are from edge gutter flange line (back of curb) to lane line

3.7.2.1 Geometric Design Considerations for Case 1

Case 1 roundabouts are designed with the intent to allow trucks to encroach on adjacent lanes at the approaches and when circulating and exiting the roundabout. Design features that encourage large truck drivers to straddle the entire lanes should be implemented. This would typically include avoiding wide lanes, long sweeping curves, large ICDs, and large radii (see [Table 3.5](#) for typical design ranges).

Generally, an alignment offset left of center is preferred. Approach roadways can have more tangential alignments to the entry curb radii with short, tighter entry radii. In some rare Case 1 design locations, where design truck swept path indicates off-tracking over the right entry radius curb, outside curb truck aprons (i.e., a sloped/mountable curb with a concrete/pavement area behind the curb, see [Figure 3.25](#)) may be implemented. This design feature must be used sparingly unless there is sufficient border separating the truck apron and sidewalks to ensure pedestrian safety. The width of this apron should be determined from the swept path analysis for trucks. [Figure 3.26](#) shows Case 1 design features. Again, additional signage should be installed to warn motorists not to drive side-by-side to trucks and direct truck drivers to occupy adjacent lanes at entries and circulatory lanes. Designers should avoid steep vertical break-over at roundabout entries and maintain maximum roll over grade between entry lane and circulatory roadway grades (the algebraic difference between grades) at 4 percent.



Figure 3.25 – Case 1 Roundabout with Outside Curb Truck Aprons (Source: MDOT¹³)

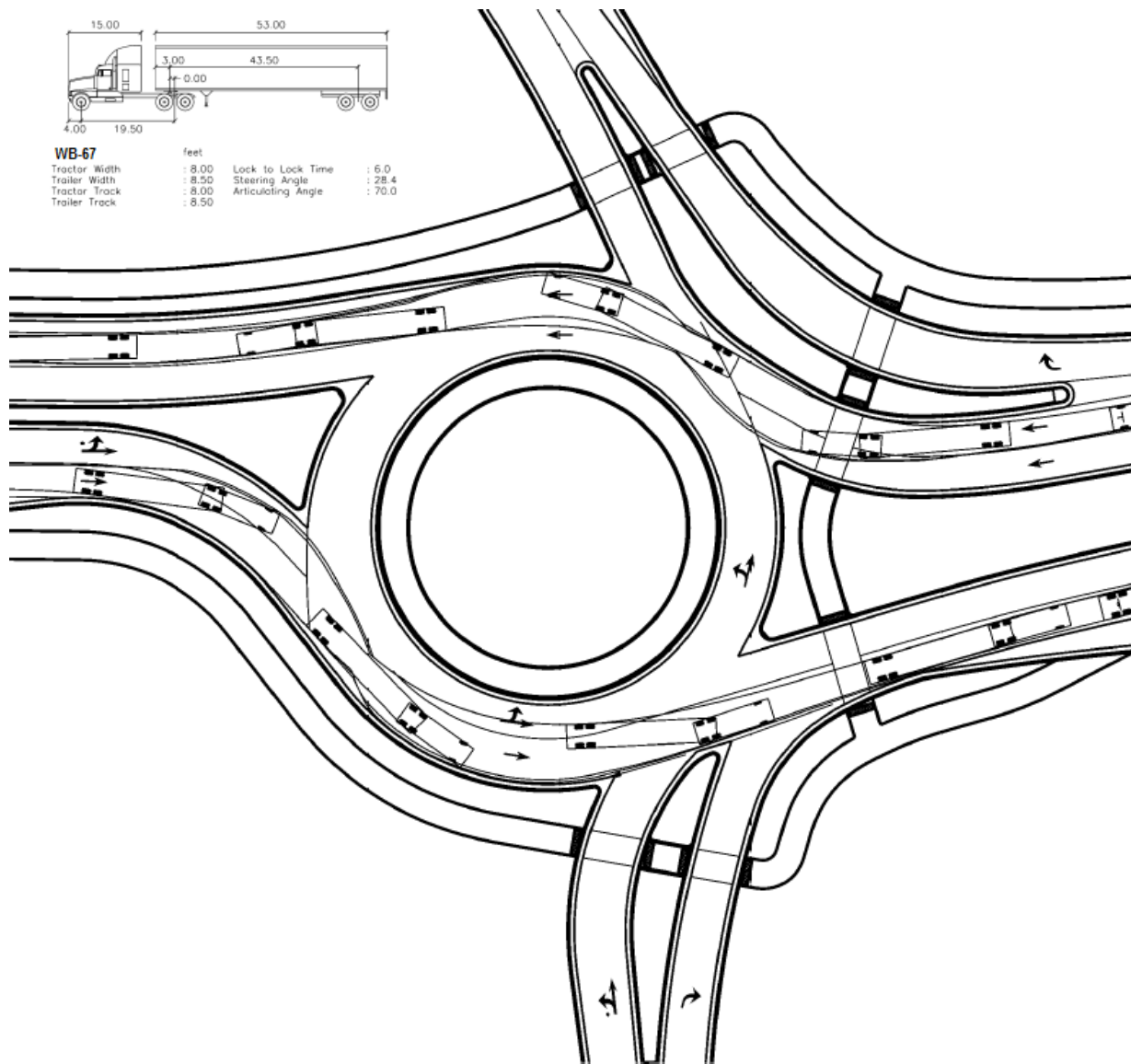

Figure 3.26– Case 1 Roundabout Design Characteristics (Source: WisDOT⁴)

3.7.2.2 Geometric Design Considerations for Case 2

Case 2 roundabout design philosophy uses painted “gore” areas on entries such that trucks stay within their lane as they enter the roundabout. The through movement from the outer lane encroaches into the inner circulatory lane as they circulate and exit the roundabout. Case 2 roundabouts have the same design characteristics at entries as Case 3 roundabouts described in [Section 3.7.2.3](#). Case 2 employ narrower circulating lanes (inner lane approximately 2 ft narrower and outer lane 2 to 3 ft narrower), differentiating them from their counterpart Case 3 types. Refer to [Figure 3.27](#) for typical design for Case 2 roundabouts.

For two lane entries on a state trunk highway, Case 2 roundabout ICDs range from 160 ft to 210 ft and are typically 10 to 20 ft smaller than for Case 3 roundabouts. Use relatively large or flat exit radii (refer to [Table 3.5](#)) to allow trucks to depart from the circulating road with minimal curvature to the right, and thus allowing them to stay in lane more easily as in the Case 3 types.

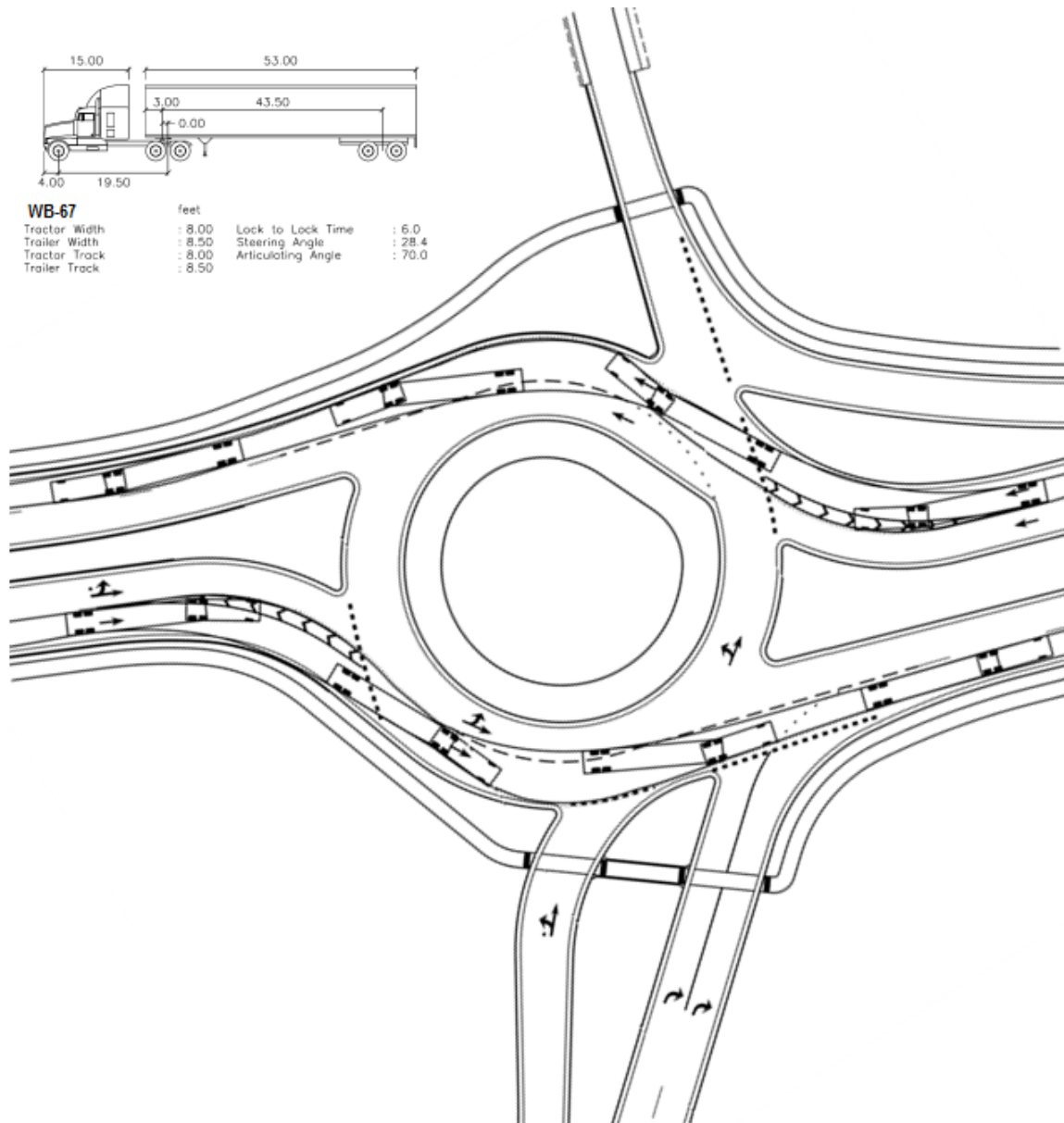

Figure 3.27 – Case 2 Roundabout Design Characteristics (Source: WisDOT⁴)

When Case 2 roundabouts are used, designers should consider using the following supplemental warning sign to ensure that all drivers are aware that trucks may use both lanes while traveling through and exiting a roundabout (see [Figure 3.28](#)).



Figure 3.28 – Sample Supplemental Warning Sign to Indicate Trucks Use Both Lanes within Roundabout

3.7.2.3 Geometric Design Considerations for Case 3

Case 3 roundabout design objective is to allow trucks to stay in lane at the entry and circulating roadway while still maintaining the primary design principles espoused in [Section 3.1](#). To achieve this design philosophy, the following additional guidelines should be followed:

1. Use relatively long width transitions to reposition trucks to stay in lane. Ensure that the total length of transition (combination of the taper and the additional full lane width utilized) accommodates the design truck as well as queuing and capacity needs. The taper rates should conform to [AASHTO Design Guide](#) tapers.
2. The gore areas should be designed such that the minimum entry widths shown in [Table 3.5](#) are maintained. This may require variable widths, including narrowing toward the entry as needed.
3. Keep entry widths (usable painted lane not including gutter pan width or gore area) as narrow as possible, typically varying from 12 to 14 ft. For a two-lane entry, the total lane width (from curb face to curb face, including gore area should typically not exceed 34 ft.
4. Ensure that controlling curb radius has sufficient length (not radius value) to provide deflection while allowing for maximum truck maneuverability. The controlling curb radius length value is dependent upon site specific constraints and can often range from 50 to 150 ft.
5. Ensure that controlling radius value is at least 65 ft. A more common value ranges between 100 to 130 ft.
6. Avoid steep vertical break-over at roundabout entries, as this may result in “low boy” trucks bottoming out. The maximum roll over grade between entry lane and circulatory roadway grades (the algebraic difference between grades) is 4 percent.

7. The outside circulating lane is often in the range of 15 to 18 ft (from edge of outer curb gutter flange line to lane line) and typically wider than the inside lane which ranges from 13 to 15 ft (from edge of central island gutter flange to lane line).
8. Ensure sufficient truck apron width (12 ft minimum) to provide lateral tracking width for the truck's trailer to off-track while the truck's tractor stays in the circulatory lane when traversing the inside lane.
9. Use relatively large or flat exit radii (refer to [Table 3.5](#)) to allow trucks to depart from the circulating road with minimal curvature to the right, and thus allowing them to stay in lane more easily.

Figure 3.29 illustrates a typical Case 3 roundabout design.

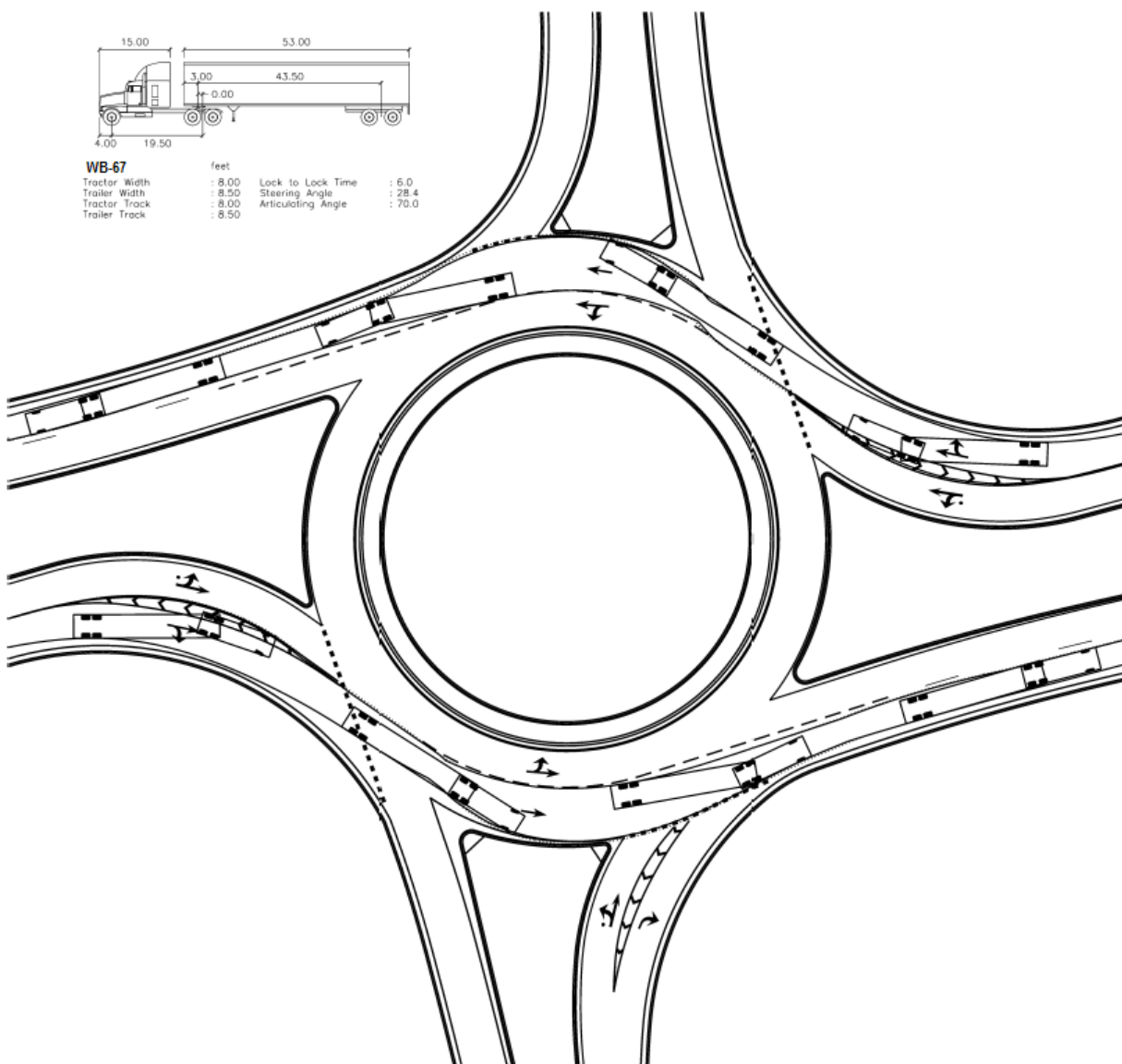

Figure 3.29 – Case 3 Roundabout Design Characteristics (Source: WisDOT⁴)

3.7.3 Accommodating Oversized/Overweight (OSOW) Vehicles

An oversized/overweight (OSOW) vehicle is a non-standard vehicle or Combination of no more than two vehicles and loads whose weight, width, or height, or combination thereof, exceeds the maximum limits specified by law. The legal dimensions, none of which must be exceeded in Alabama, are 14' wide, 16' high and 150,000lbs. Alabama DOT provides special permitting to OSOW vehicles to operate or move upon the State's public roads and local roads from trip origins to destinations. They often are followed by escorts.

Single-lane or multilane lane roundabouts on existing or anticipated OSOW routes must be designed such that they are easily adaptable to accommodate OSOW vehicles. Roundabouts designed for a WB-67 vehicle tend to accommodate OSOW vehicles more easily. As such, it is prohibitively expensive and unwise to consider OSOW as a design vehicle (rather than as 'check' vehicles to identify appropriate turning requirements) for any roundabout type design due to ROW and safety requirements. Instead, roundabouts designed to accommodate WB-67 design vehicle may be reviewed and modified to accommodate OSOW vehicles by considering one or combinations of the following techniques; 1. Traversable truck aprons around central island, splitter island, and/or outer curbs, 2. Counter flow technique using temporary traffic control measures, and 3. Hamburger (through roads) configuration technique. These techniques are discussed in detail in the following sections. The selection of the appropriate technique depends on the desired movement through the roundabout and the generated swept paths with minimal right-of-way impacts, less traffic disruptions and of course, least cost.

Wisconsin DOT compiled an inventory of six OSOW check vehicles and can be used, in the absence of local OSOW vehicles information, to check OSOW requirements at roundabouts (WisDOT⁴ Vehicle Library). [Figure 3.30](#) illustrates the different check vehicles and listed here as;

1. 55 meter wind blade NL (Vehicle Length (L) =209ft)
2. 80' mobile home (L=112.5ft)
3. 165' beam L (L=201.10ft)
4. Combine (L=28.80ft; W=20 ft)-width outside State legal dimension
5. Wind tower section 78L (L=112.50ft)
6. Wind tower upper mid-section (L=148.80ft)

The designer is encouraged to consult local trucking industries and DOT's OSOW permitting office or the [Bureau of Transportation Planning and Modal Programs](#) to identify the OSOW vehicles that possibly will use the proposed facility. If the roundabout is located on the OSOW Freight Network, swept path analysis should be performed to ensure that the roundabout geometry, splitter islands and truck apron can accommodate the appropriate OSOW check vehicle. Information on the Alabama Freight Route Planning can be found at the [ALDOT Freight Network Mapping](#) website.

3.7.3.1 Accommodation of OSOW with Truck Aprons

The use of truck apron technique follows upon successful OSOW swept path analysis, which defines the area of maneuverability, ensuring unobstructed horizontal clearance in the OSOW's turning path. This involves one or combination of the following;

1. Wide truck aprons (12 feet or more) around the central island with cross slope of 1 – 2% and a mountable curb of 3 inches rise over 24 inches run
2. Customized central island to address known left turns
3. Tapered central island to support through movements
4. Paved area behind curb (right side for off-tracking)
5. Installing removable signs and providing set-backs for permanent fixtures (light poles)

Figure 3.31 illustrates an example of OSOW turning requirements around central and splitter islands. Note that part or all of the splitter islands would be made traversable for large trucks and OSOW. Figure 3.32 further shows an OSOW taking a left turn at a roundabout with a wide truck apron.

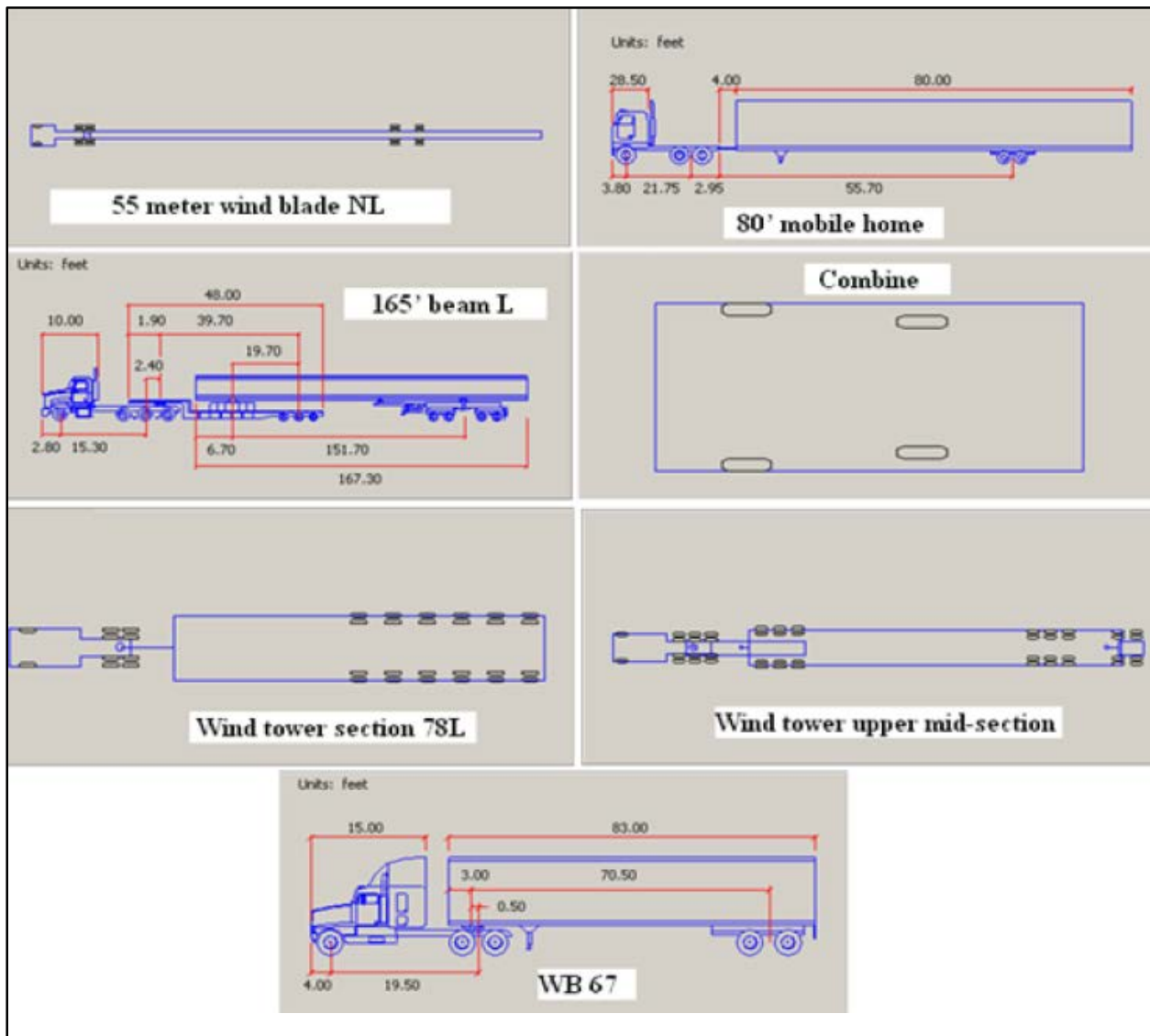

Figure 3.30 – OSOW Check Vehicles (Source: WisDOT⁴)

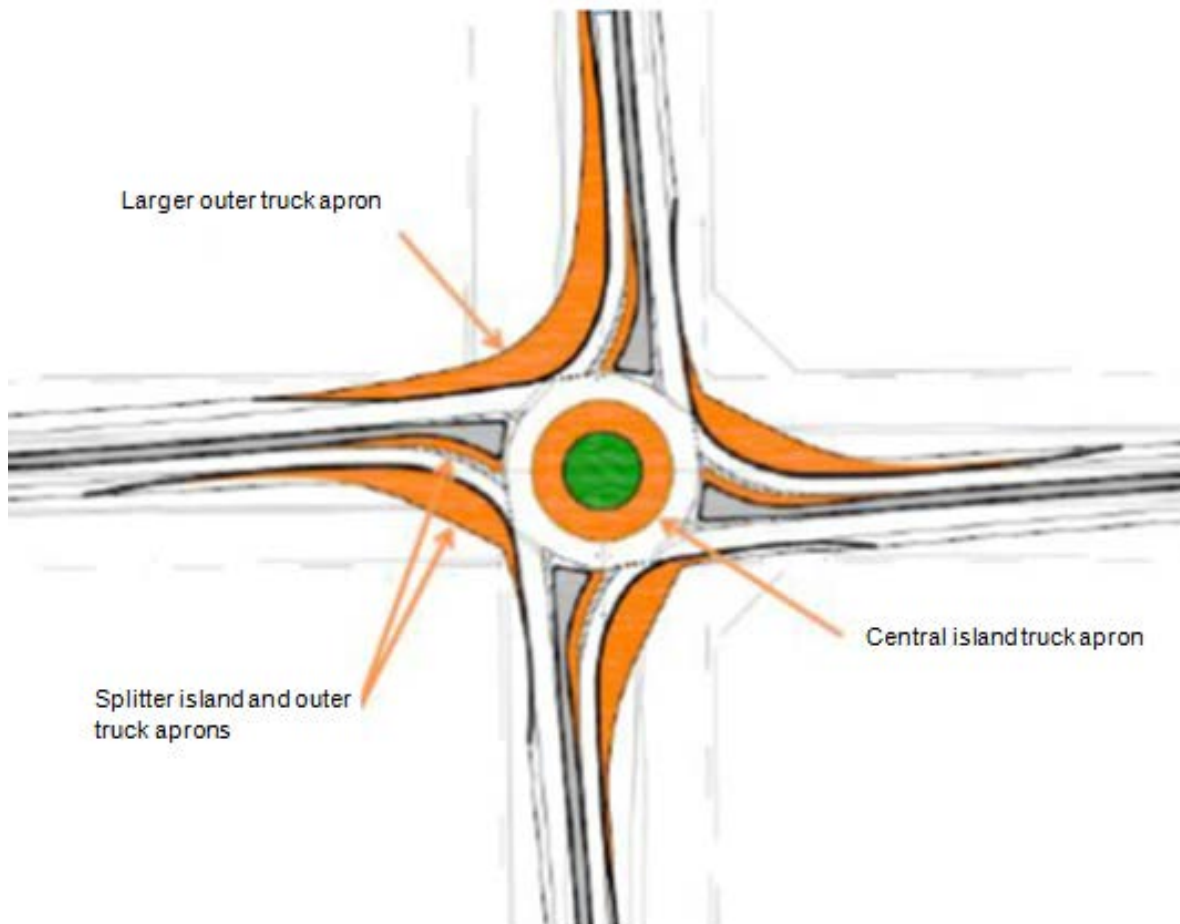

Figure 3.31 – Design Locations of Truck Apron for OSOW Movement (Source: RTE¹¹)



Figure 3.32 – Wide Truck Apron for OSOW Accommodation (Source: RTE¹¹)

3.7.3.2 Accommodating OSOW by Counter Flow

This technique allows trucks to cross over medians in a counter flow direction before the roundabout to make a left turn in the opposing lane and then cross back over after the turn. In many cases, providing for counter flow in and through a roundabout allows sufficient accommodation for OSOW with a relatively smaller roundabout. This provides a simple solution for required OSOW movements to be accommodated while keeping size and cost down. Curb heights are to be kept as low as possible (3 inches typical) in the intended paths, and landscaping in the center island are to be set-back from the truck turning paths. In [Figure 3.33](#), the shaded areas show where extra truck aprons or additional tracking pavement to both the central island and outer curb line would be necessary. The arrows show the counter flow movements. Counter flow technique requires greater traffic control operations and this can be provided by trained escorts, who are required by law to accompany all OSOW vehicles. Other permanent fixtures (e.g. light poles) should be set-back away from truck turning paths. It is beneficial to install removable signs that can easily be removed and replaced by the escorts during OSOW turning operation.



Figure 3.33 – Counter flow OSOW Tuning Movements (Source: Ourston Roundabout Engineering¹⁰)

3.7.3.3 Accommodating OSOW with Through Roads (Hamburger Configuration)

This technique requires a road through the central island to accommodate OSOW (see [Figure 3.34](#)). It is necessary to gate the entrances to the central island if the through road is a contiguous alignment from the roundabout approach alignments, in order to avoid other vehicles running through the central island. On the other hand, the central island through-road can be skewed to the exits; avoiding gated entrances (see [Figure 3.35](#)). For this concept, the OSOW needs to move to the opposite lane prior to entering, and lines up with the offset entrance of the through-road. However, these techniques only accommodate OSOW going straight through the roundabout and require some level of traffic control such providing escort to direct traffic.



Figure 3.34 – Roundabout Showing Straight-Through Path (Source: Google Map data © Google 2015, Netherlands)



Figure 3.35– Skewed Road Running through Central Island (Source: Google Map data © Google 2015, Netherlands)

3.7.4 Other Geometric Design Considerations

3.7.4.1 Vehicle Path Overlap

Vehicle path overlap occurs only in multilane roundabouts where the natural paths of vehicles in adjacent lanes overlap or cross one another as a result of poor entry or exit path alignment, or vehicle tracking on approach and in circulatory roadway (in Case 1 roundabouts). The natural path is the normal trajectory of the aligned vehicle at yield line into the circulatory and exit lanes. Where entry path overlap exists, for example, vehicles in the left lane on entry are cut off by vehicles in the right lane, as shown in [Figure 3.36](#). At exits with inadequate alignment geometry or small exit radii, vehicles in the left-hand lane may cut into the right-hand exit lane, increasing the potential for sideswipe and single-vehicle crashes. An example of path overlap at a site is shown in [Figure 3.37](#), where only the inner circulatory lane is utilized by vehicles. This potentially reduces the capacity of the roundabout and increases potential for vehicle sideswipe and single-vehicle crashes.

Entry path overlaps can be eliminated by the use of left offset design as shown in [Figure 3.38](#). This procedure involves initial introduction of a small-radius entry curve (65 to 120 ft, typical) set back 20 ft from the edge of the circulatory roadway and followed by a tangent between the curve and the circulatory lane (see [Appendix: Design Techniques](#)). Where a large proportion of trucks is present, truck gore striping may be deployed to supplement the left offset design to align vehicles into the proper circulatory lane at the entrance line (see [Figure 3.39](#)). Large exit radii and proper pavement markings should be provided at exits to avoid exit path overlaps. As such, Case 1 roundabouts should only be used at low truck volume locations (see [Section 3.7.2](#)). At existing sites, lane striping may be used to eliminate path overlap problems (see [Figure 3.40](#)).

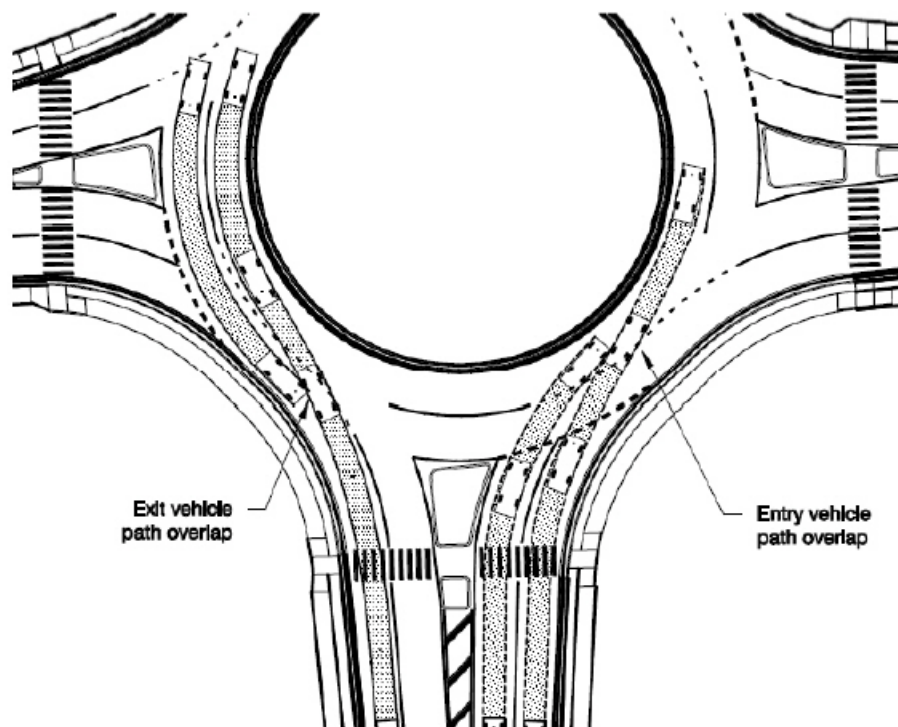

Figure 3.36 – Illustration of Entry Path Overlap (Source: NCHRP 672²)



Figure 3.37 – Entry Path Overlap Example (Source: NYSDOT¹⁴)

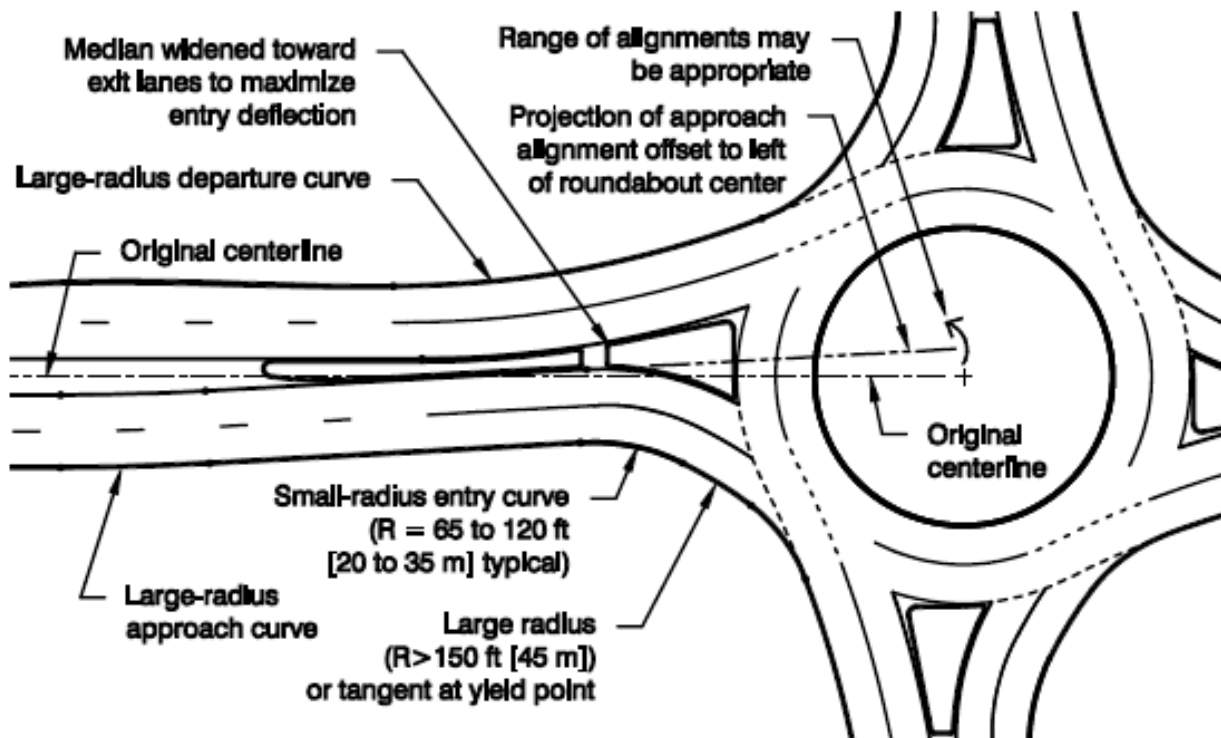

Figure 3.38– Illustration of Left Offset Entry design (Source: NCHRP 672²)

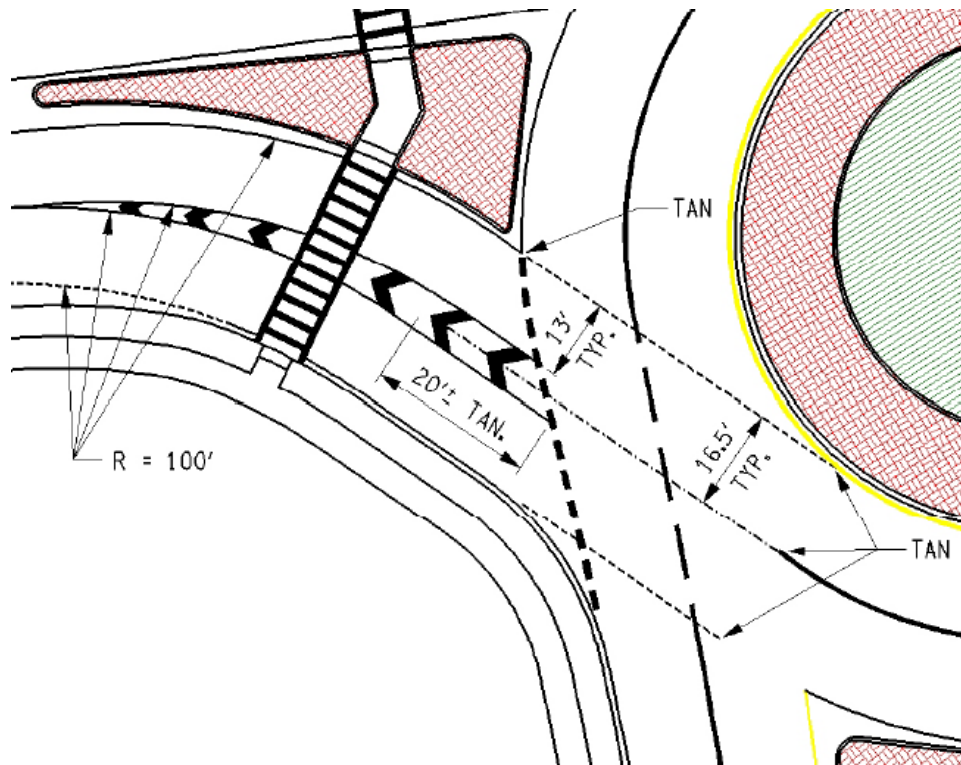

Figure 3.39 – Left Offset Design and Truck Gore Striping (Source: NYSDOT¹⁴)



Figure 3.40 – Lane Striping to Eliminate Path Overlap (Source: NYSDOT¹⁴)

3.7.4.2 Right-Turn Bypass Lanes

Bypass lanes (sometimes refer to as slip lanes) are most beneficial where the capacity of an approach is exceeded and with significant proportion of right-turn traffic or where the geometry for right turns is too tight to allow trucks to turn. They should be implemented only at locations with minimal pedestrian and bicycle activity, or where bicycle and pedestrian concerns can be addressed through other design elements.

Full bypass lanes which require application of acceleration lanes with merging tapers to the main exit lanes are implemented at locations where pedestrian and bicycle activity is low and the right-turn lanes merge with higher functionally classified roads. [Figure 3.41](#) illustrates a full bypass lane configuration. The acceleration length and the taper rate should follow the provisions in the AASHTO³ design guidelines. Partial bypass lanes are design alternative lanes that provide yield controlled entrance onto the adjacent exiting roadways. They consist of either raised vane islands or painted gores (less than or equal to 4 ft wide) as illustrated in [Figure 3.42](#). This design option is beneficial at locations with prevalent pedestrian and bicycle activity and/or right of way concerns. The radius of the right-turn bypass for both design options should not be larger than 1.5 times the radius of the fastest entry path provided at the roundabout.

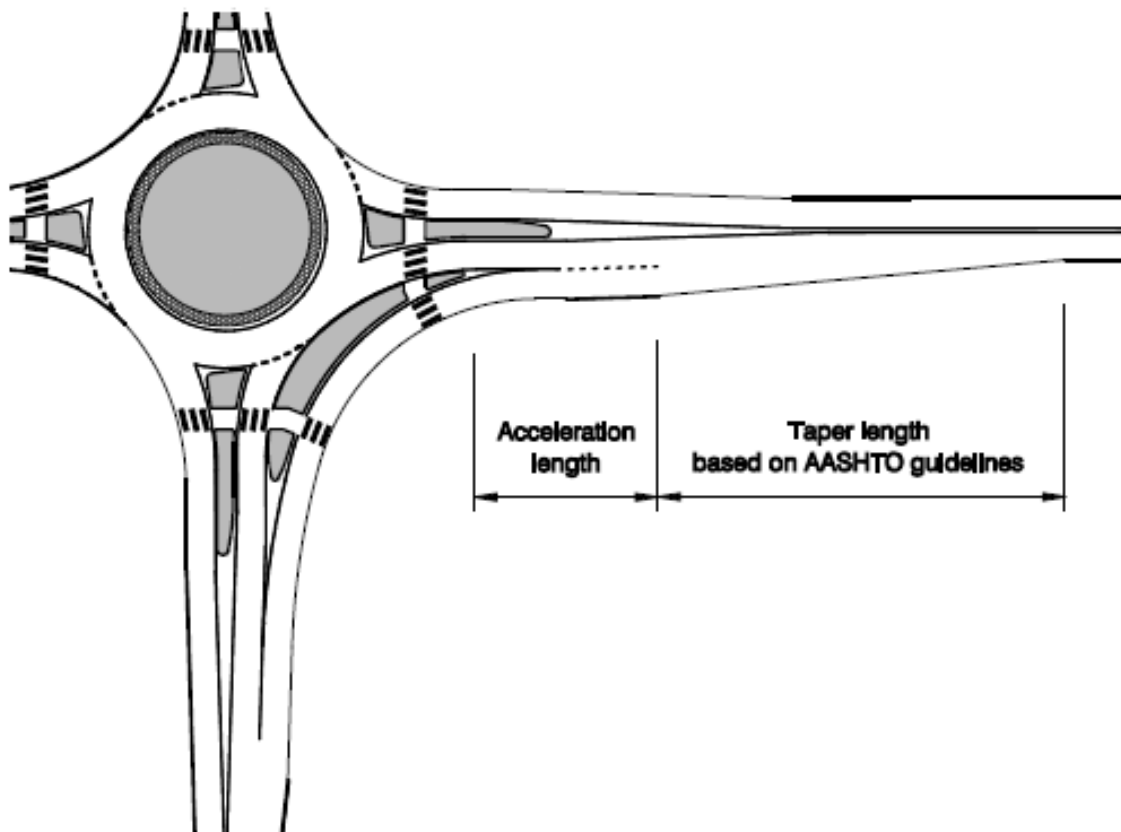

Figure 3.41 – Right-Turn Bypass Lane with Acceleration Lane and Taper (Source: NCHRP 672²)

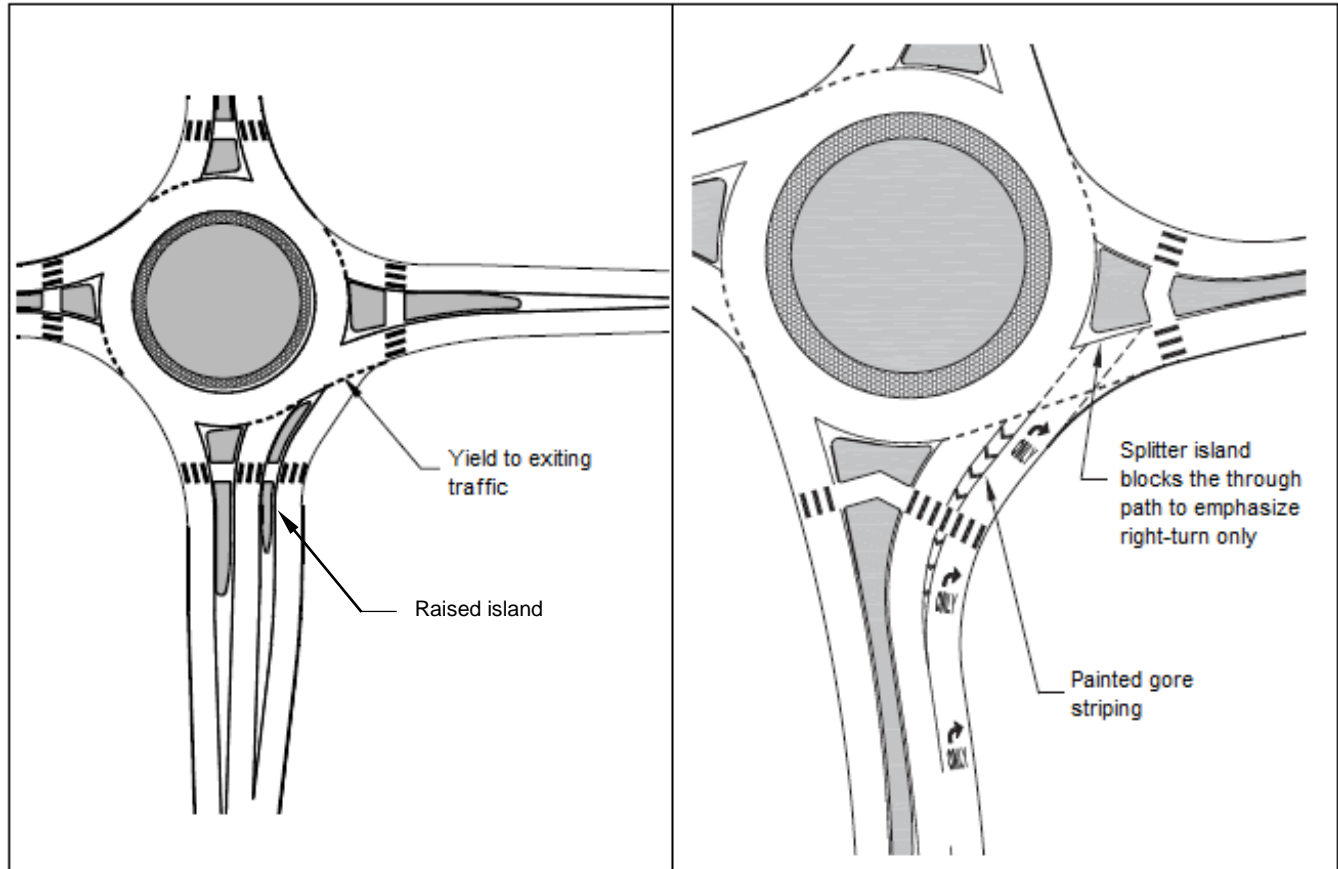

Figure 3.42 – Right-Turn Bypass Lane with Yield at Exit Leg (Source: NCHRP 672²)

3.7.4.3 Spirals

Spirals are introduced on circulatory roadways as additional lanes to transition left-turn entry vehicles in the innermost lane to their intended exits without being trapped or changing lanes. Striping or spiral marking of the circulatory road provides visual guidance to the left-turn entry vehicles into the spiral lane. Spirals are only encouraged on large inscribed circle diameter roundabouts (greater than 200 ft) to ensure adequate transitioning length to the exits. [Figure 3.43](#), [Figure 3.44](#) and [Figure 3.45](#) illustrate the use of spirals in roundabout design.

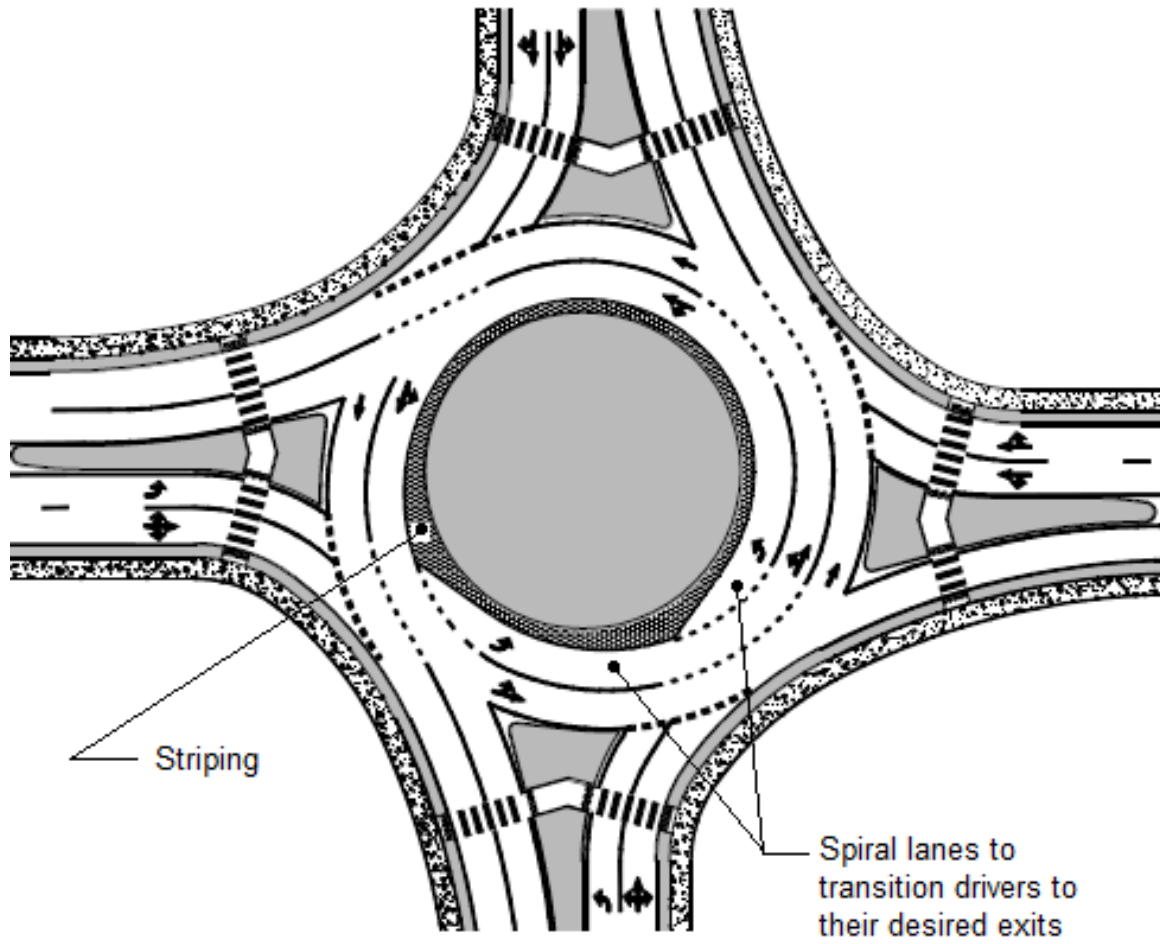

Figure 3.43 – Two-lane Roundabout with Spiral lanes to transition Left-Turn Traffic (Source: NCHRP 672²)



Figure 3.44 – Example of Two-Lane Roundabout with Spiral Lane to Transition Innermost Left Turn Traffic from Southern Approach Leg to Exit (Source: GHD¹⁰)



Figure 3.45 – Example of Two-Lane Roundabout with Spiral Lane and Additional Exit Lane to Transition the Innermost Through/Left Turn to Exit (Source: GHD¹⁰)

3.8 Performance Checks

Performance checks are validation procedures to assess the operational and safety performance of roundabouts. These checks are performed on the proposed roundabout geometry and help an engineer determine whether the design meets its performance objectives. They include fastest path analysis, vehicle path construction, speed estimation, vehicle natural path and driver sight distance requirements.

3.8.1 Fastest Path

The fastest path is the path of a single vehicle, in the absence of other traffic and ignoring all lane markings, traversing through the entry, around the central island, and out the relevant exit. It relates the turning radii to the design speed expected at a roundabout. It consists of series of reverse curves (R1 through to R3) representing the trajectory of the fastest vehicle in a particular movement through the roundabout (see [Figure 3.46](#)). The maximum speed along this path is checked against the recommended speeds discussed in [Section 3.4](#).

3.8.2 Construction of Vehicle Paths

The construction of the fastest path should begin at least 165 ft prior to the entrance line using the appropriate offsets identified in [Figure 3.47](#). The R1 radius is the smallest circular curve over a distance of at least 65 to 80 ft near the entrance line. The design speed of the roundabout is determined from the smallest radius along the fastest allowable path. The smallest radius usually occurs on the circulatory roadway as the vehicle curves to the left around the central island.

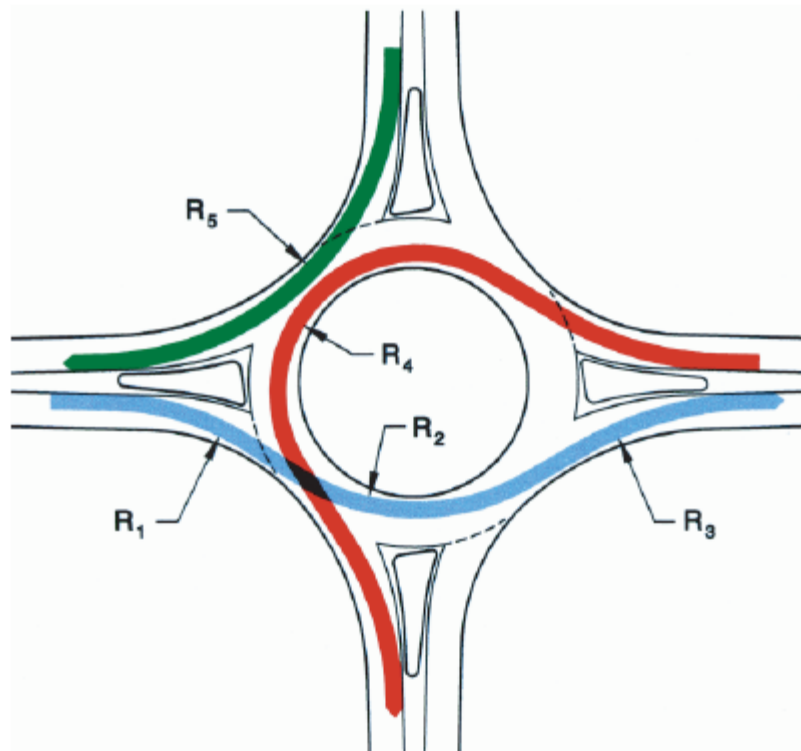

Figure 3.46– Vehicle Path Radii (Source: NCHRP 672²)

3.8.3 Vehicle Speed Estimation

The speed – curvature relationship between vehicle path radius and its fastest achievable speed is shown in [Figure 3.48](#). The speeds are affected by superelevation cross slope construction on the circulatory roadway (positive or negative superelevation). The commonly used superelevation rate on asphalt pavement is 2%. The estimated radii from the vehicle path analysis are entered on the appropriate superelevation plot and their corresponding speeds determined. [Figure 3.48](#) presents a simplified speed-radius relationship and may over predict entry and exit speeds in cases where the radius is large. Alternatively, the radii may be entered into the [ALDOT Fastest Speed Analysis Spreadsheet](#) (which uses Equation 6-3 of [NCHRP 672²](#)) to predict actual speeds. The maximum speed obtained is compared with the recommended maximum speeds in [Section 3.4](#). If the thresholds are exceeded, the design is modified to limit it to the desired speed. An example of fastest path analysis performed on an intersection is illustrated in [Figure 3.49](#).

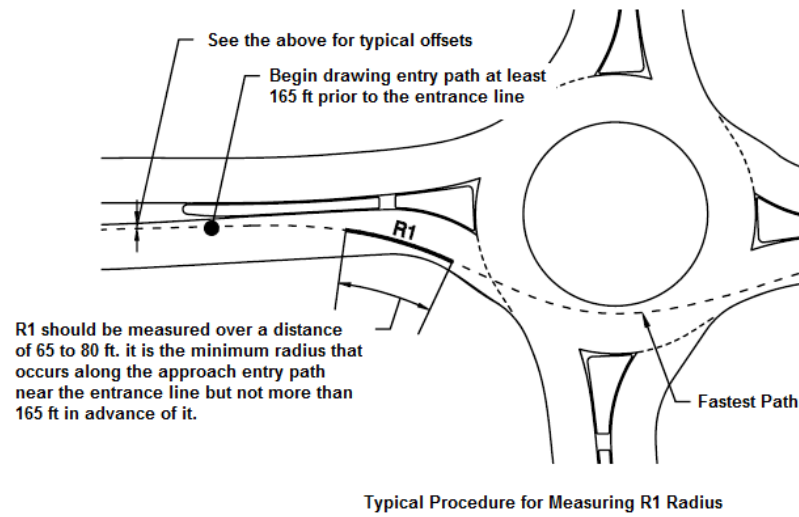
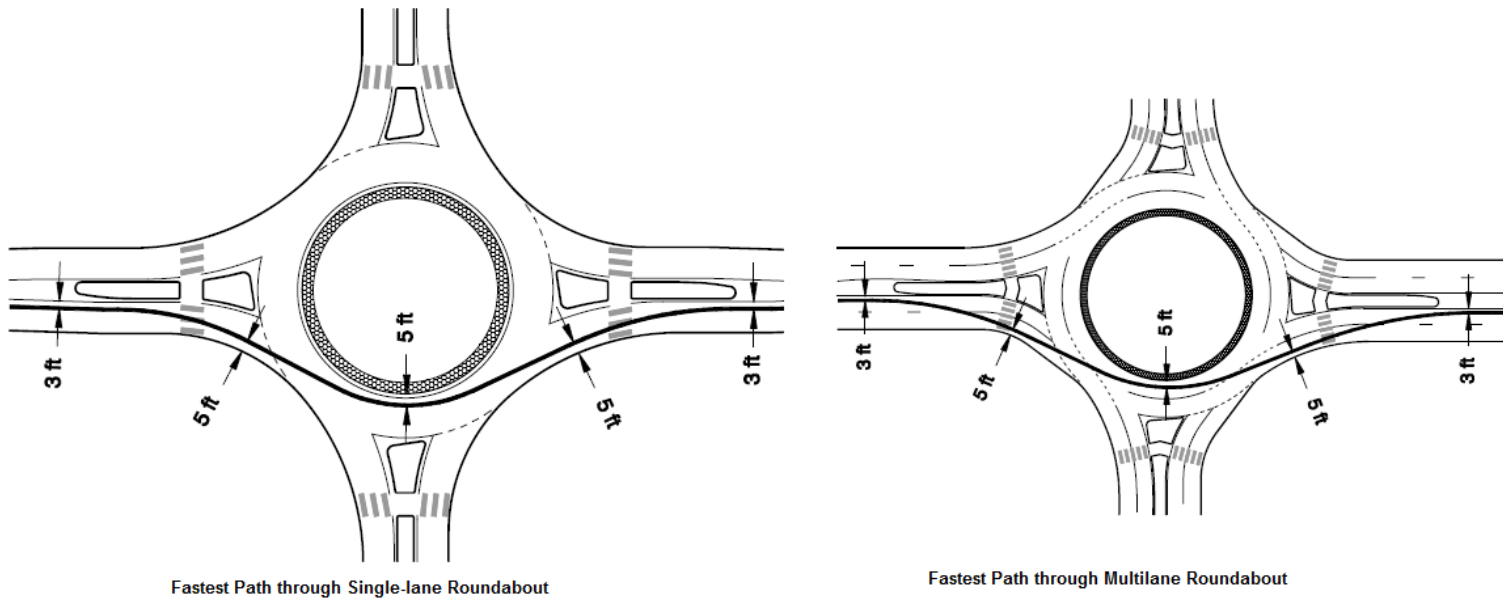

Figure 3.47 – Fastest Path Radii Construction (Source: NCHRP 672²)

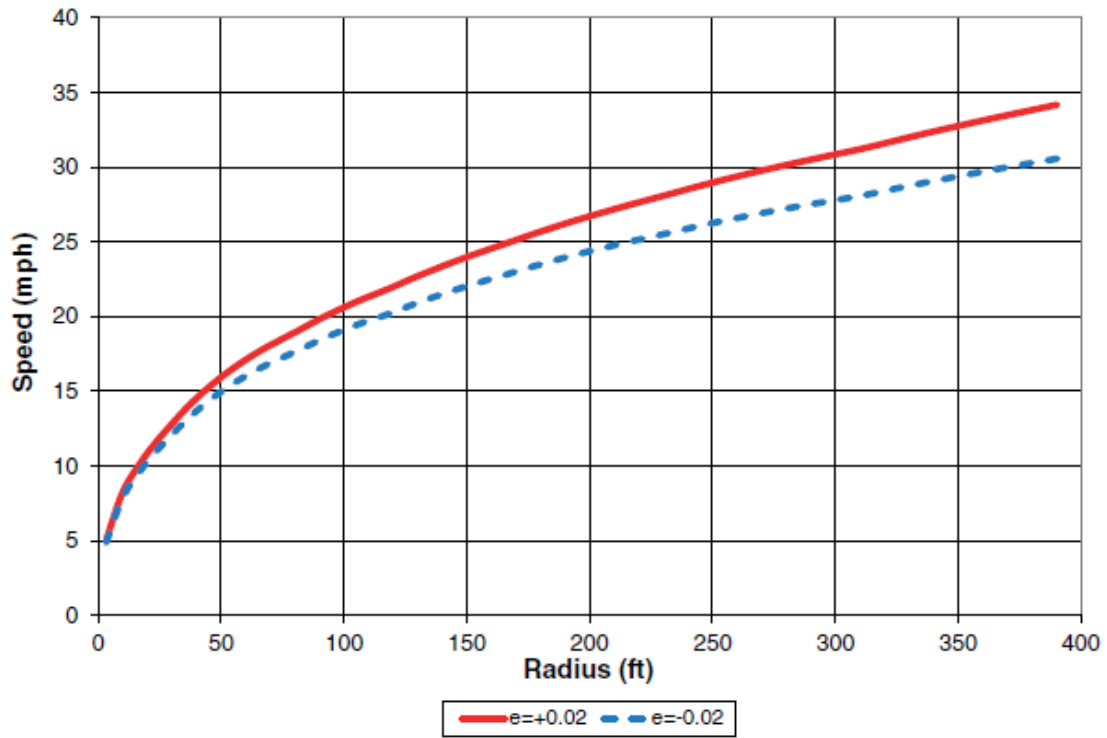

Figure 3.48– Speed-Radius Relationship (Source: NCHRP 672²)

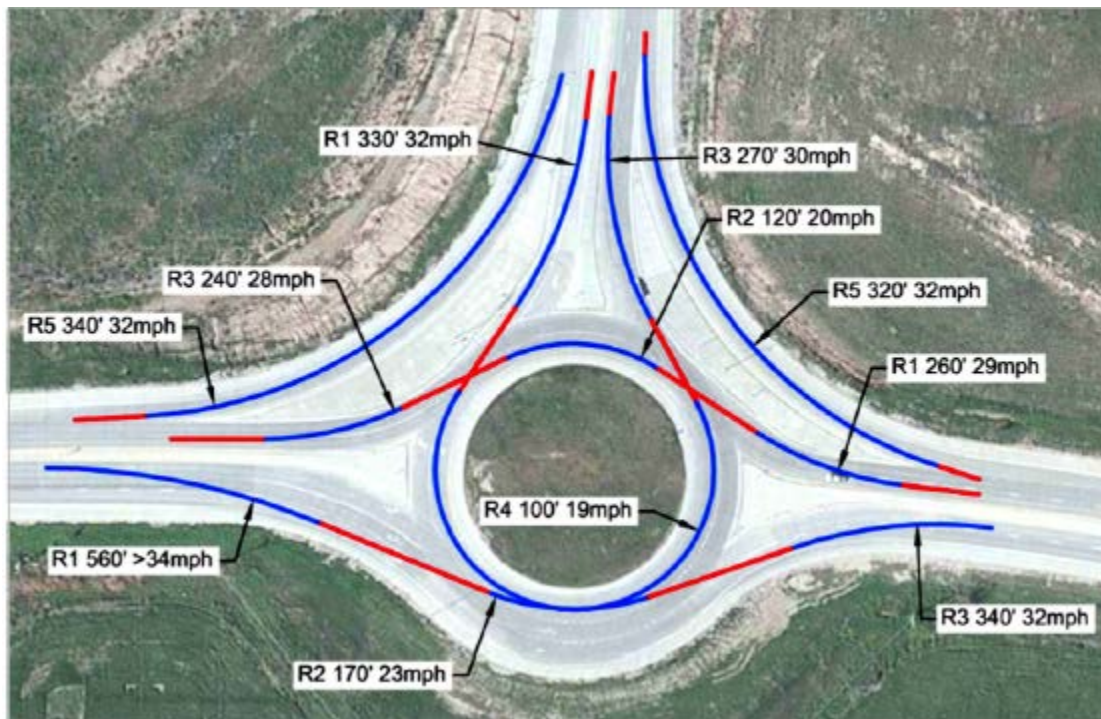

Figure 3.49 – Fastest Path Example (Source: Kittelson and Associates, Inc)

3.8.4 Natural Path Alignment

Unlike the fastest path through the roundabout, the natural vehicle path is drawn to mimic the natural path of an approaching vehicle assuming there is traffic on all approach lanes. It is convenient to draw the natural path over the geometric layout by freehand, rather than use a computer drafting program. This enables the designer to feel how changes in one curve affect the smooth transition of driving through the roundabout. It also presents any conflicting traffic that poses path overlap to the attention of the designer.

3.8.5 Sight Distance

3.8.5.1 Stopping Sight Distance (SSD)

Stopping sight distance (represented in Equation 3.1) is the distance required for a driver to perceive and react to an object in the roadway and to bring his vehicle to a complete stop before reaching that object. The derivation of stopping sight distance is based on assumed values for total driver perception - reaction time (t) of 2.5 sec and the rate of deceleration (a), assumed to be 11.2 ft/sec².

$$SSD = (1.47)(t)(V) + 1.087 \frac{V^2}{a} \quad \text{[Equation 3.1]}$$

The recommended values based on $t = 2.5$ sec and $a = 11.2$ ft/sec² are shown in [Table 3.6](#).

TABLE 3.6 Minimum Stopping Sight Distance (Source: NCHRP 672²)

| Speed (mph) | Computed Distance (ft) ¹ | Design Distance(ft) ² |
|-------------|-------------------------------------|----------------------------------|
| 10 | 46.4 | 45 |
| 15 | 77.0 | 80 |
| 20 | 112.4 | 115 |
| 25 | 152.7 | 155 |
| 30 | 197.8 | 200 |
| 35 | 247.8 | 250 |

Note:

1. The computed distances are rounded up or down to the nearest multiple of 5
2. The distance computed from Equation 3.1 is compared with the values in the table for the given speed V (entry, circulatory or exit speed)

Three critical locations should be checked for stopping sight distance requirement:

- Approach sight distance ([Figure 3.50a](#))
- Sight distance on circulatory roadway ([Figure 3.50b](#))
- Sight distance to crosswalk on exit ([Figure 3.50c](#))

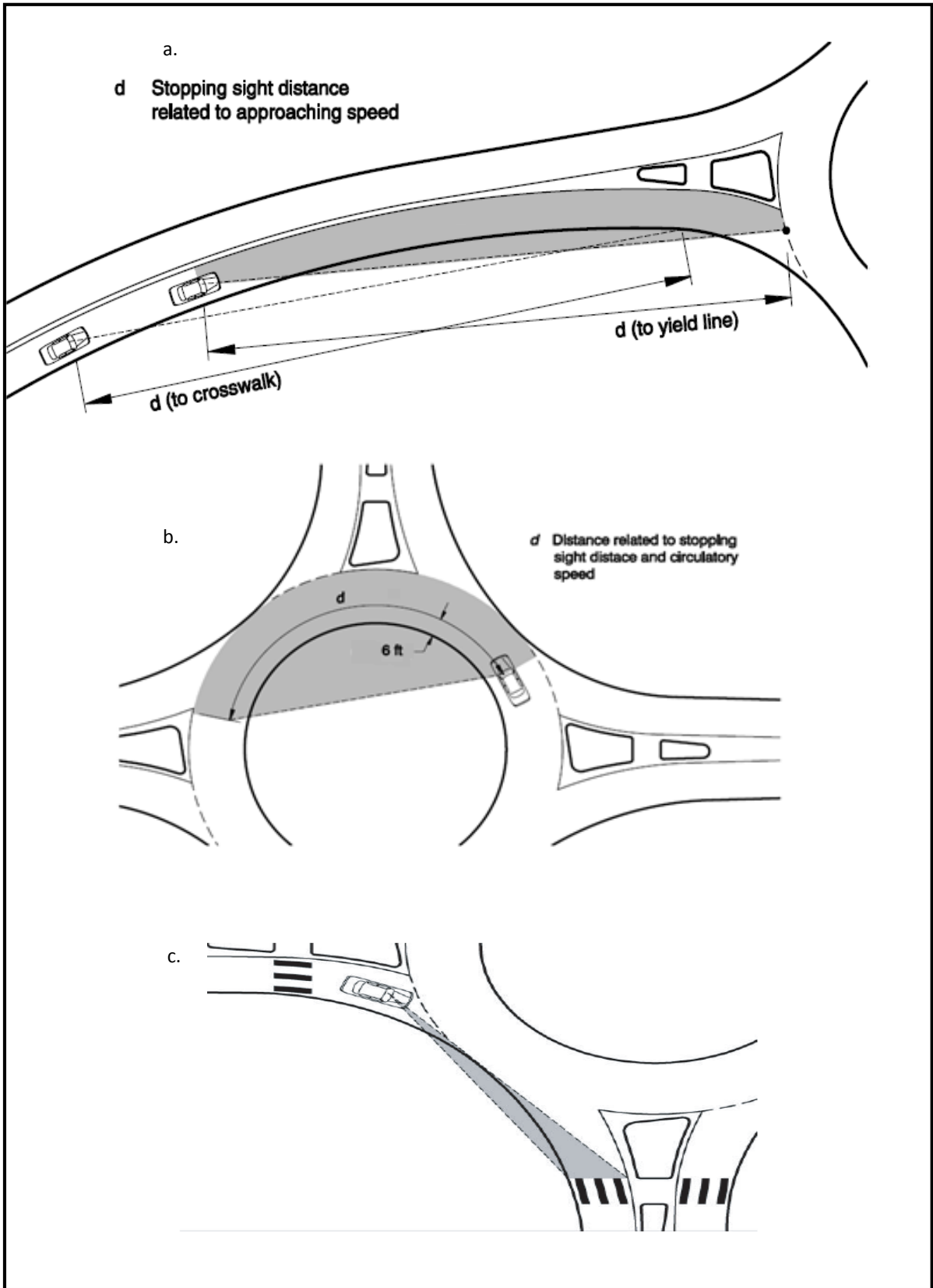

Figure 3.50– Critical Stopping Sight Distance Locations (Source: NCHRP 672²)

3.8.5.2 Intersection Sight Distance (ISD)

This is the distance required for a driver, placed at 50 ft from the roundabout entry line, to perceive and react to the presence of conflicting vehicles for a decision to be made to yield to on-coming left traffic streams. There are two identifiable traffic streams for ISD analysis: the immediate left entering stream (d_1) and the circulatory stream (d_2) as shown in [Figure 3.51](#) and are estimated from Equation 3.2 and Equation 3.3 respectively.

$$d_1 = 1.47(V_1)(t) \quad \text{[Equation 3.2]}$$

$$d_2 = 1.47(V_2)(t) \quad \text{[Equation 3.3]}$$

Where, V_1 = the estimated speed from speed-radius relationship in [Figure 3.12](#) taking as the average of speeds due to R1 and R2 vehicle path

V_2 = the estimated speed from speed-radius relationship in [Figure 3.12](#) due to R4 vehicle path

The recommended values based on critical headway, $t = 5.0$ sec are shown in [Table 3.7](#).

TABLE 3.7 Minimum Intersection Sight Distance (Source: NCHRP 672²)

| Conflicting Approach Speed (mph) | Computed Distance, d_i , (ft) | Design Distance (ft) |
|----------------------------------|---------------------------------|----------------------|
| 10 | 73.4 | 75 |
| 15 | 110.1 | 110 |
| 20 | 146.8 | 145 |
| 25 | 183.5 | 185 |
| 30 | 220.2 | 220 |

Note:

1. The computed distances are rounded up or down to the nearest multiple of 5
2. The distances computed from Equation 3.2 and Equation 3.3 are compared with the values in the table for the given speeds V_1 and V_2

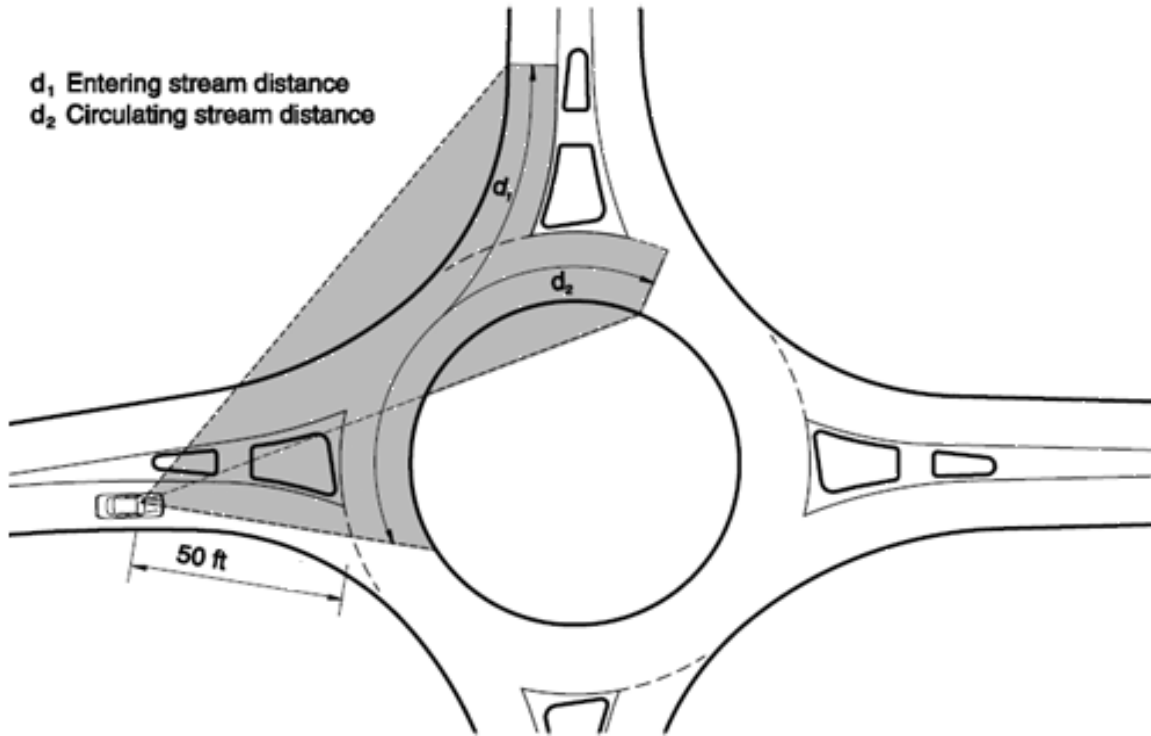

Figure 3.51 – Critical Intersection Sight Triangles (Source: NCHRP 672²)

Each approach leg should be checked for SSD and ISD requirements. It may be convenient to superimpose both SSD and ISD sight triangles on a single layout drawing as shown in [Figure 3.52](#). This should give a visual guide as to the placement of landscaping objects and or other treatments around the roundabout.

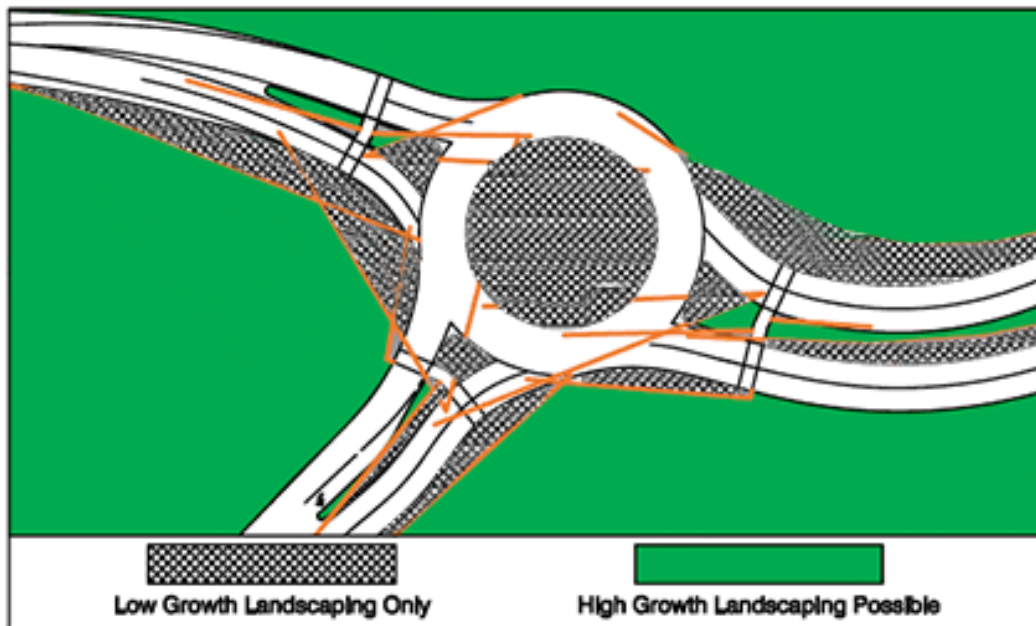

Figure 3.52 – Example Sight Distance Diagram (Source: NCHRP 672²)

3.9 Pedestrian and Cyclist Treatments

Under [Section 32-5A-211](#) of the Alabama Code, the driver of a vehicle is obliged to yield the right-of-way to a pedestrian crossing the roadway within a crosswalk at an intersection with no traffic signal. This provision mandating drivers to yield to crossing pedestrians provides suitable grounds for the successful implementation of roundabouts in the state of Alabama. Nonetheless, the designer should make provision for pedestrian crossing at specific locations to formalize the crossing points around roundabouts.

3.9.1 Pedestrians

3.9.1.1 Sidewalk

Sidewalks should be set back from the edge of the circulatory roadway with a landscape strip. A set back distance of 8 ft is recommended with an absolute minimum of 2 ft. Sidewalk widths may vary from 4 to 8 ft. Sidewalks less than 5 ft in width require the addition of a passing section every 200 ft for accessibility (see [AASHTO Policy on Geometric Design of Highways and Streets](#)³). Where pedestrians are to share sidewalk space with cyclists, additional width should be added to allow peds/cyclists movements. A typical sidewalk treatment is illustrated in [Figure 3.53](#).

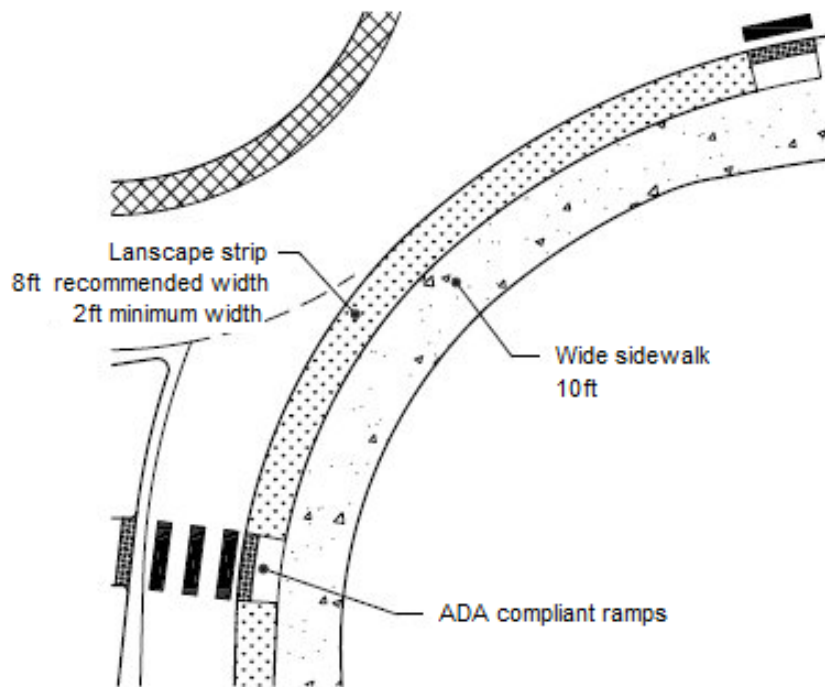

Figure 3.53 – Typical Sidewalk Treatment (Source: NCHRP 672²)

3.9.1.2 Crosswalk

Pedestrian crossings may be provided at roundabouts with a desirable minimum of 20 ft set back distance in advance of the yield line so that pedestrians crossing the road are not impeded by a car waiting on the approach. Sufficient refuge width should be provided within the splitter island. The refuge area should be at least 6 ft. in width to accommodate a typical bicycle or person pushing a stroller. Design features that could be expected to improve the level of service and safety for pedestrians at roundabouts include:

- ADA compliant ramps and storage areas in splitter islands adequate to accommodate the pedestrian demand (a minimum of 6 ft is desired) and
- ADA compliant ramps and crossings are orientated perpendicular to travel lane to provide for pedestrians to travel across with the least possible amount of exposure time to traffic.

3.9.2 Cyclists

Roundabouts should be designed to provide an acceptable level of safety for cyclists. At low speed single-lane roundabouts (e.g. 20 mph) cyclists should be able to safely share the road with general traffic. At larger single-lane or multilane roundabouts where speeds are higher, consideration should be given to treatments that assist young or inexperienced cyclists as well as commuter cyclists. In such situations, bicycle tracks can be shared with pedestrian sidewalks with ramps provided at terminals to provide access. Where cyclists share driving space with vehicles at the roundabout, the bicycle lane should be terminated approximately 50 feet upstream of the yield line (see [Figure 3.54](#), [Figure 3.55](#) and [Figure 3.56](#)). This ensures the vehicles are slow enough for the bicycles to ride in line with them. In no case should the bicycle lane continue through the roundabout.

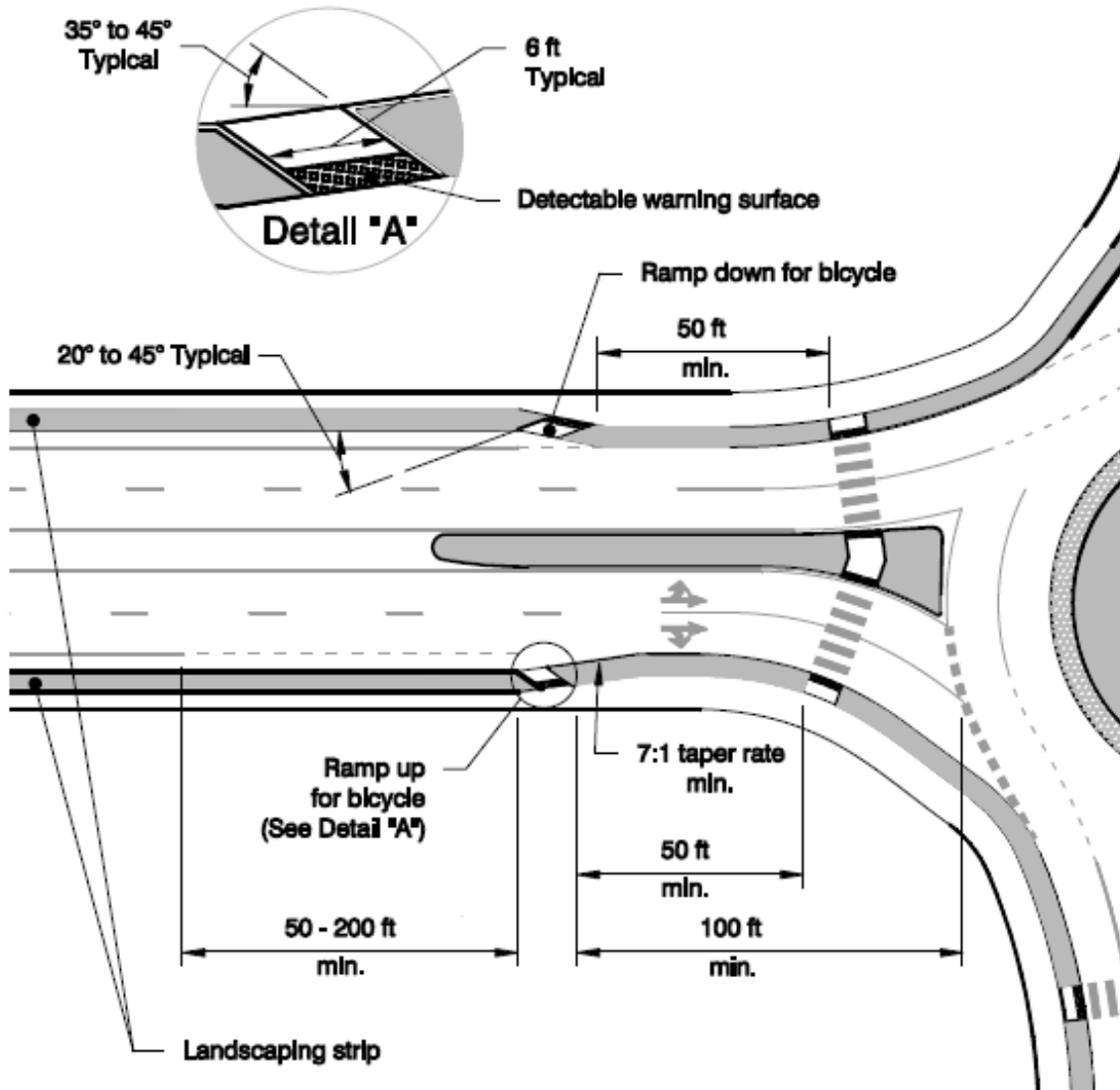

Figure 3.54 – Typical Pedestrian and Cyclist Treatment (Source: NCHRP 672²)



Figure 3.55– Example Pedestrian and Cyclist Treatment (Source: NCHRP 672²)

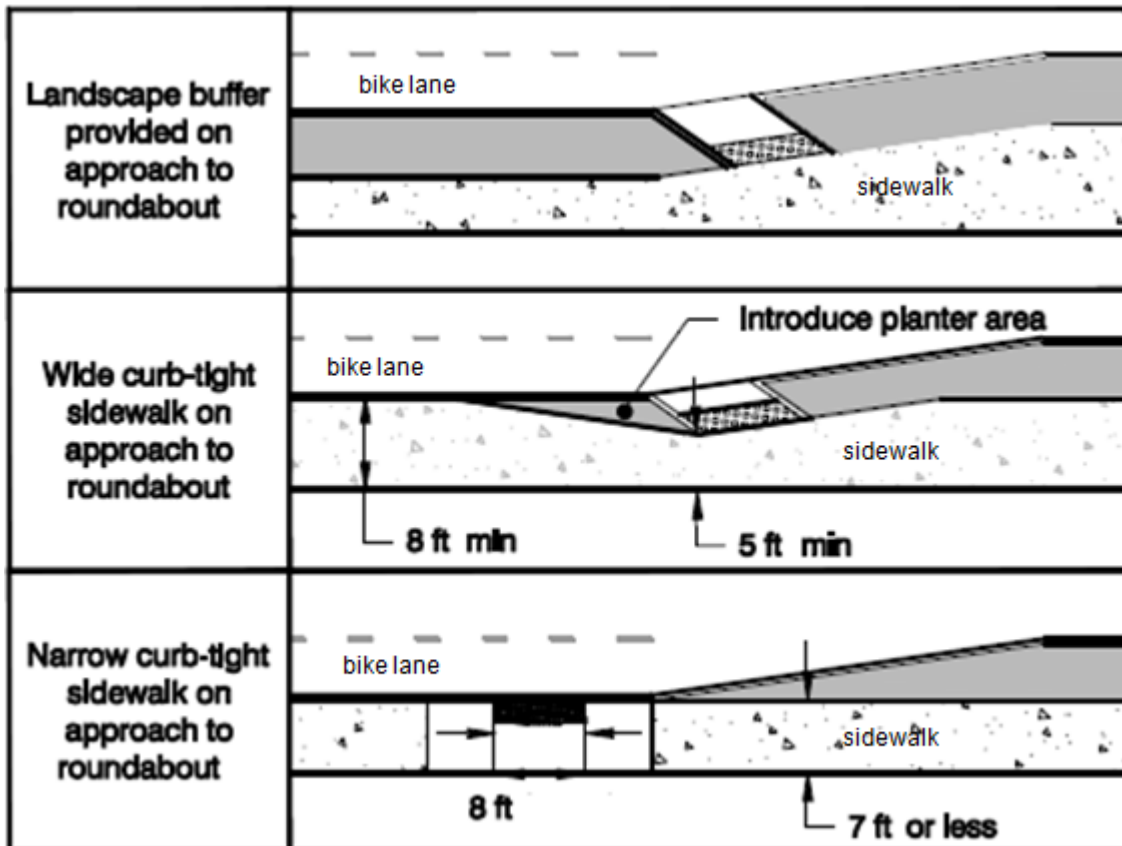

Figure 3.56– Bicycle Ramp Design Options (Source: NCHRP 672²)

3.10 Grading

Generally, it is desirable that the longitudinal gradient on approaches to roundabouts be limited to 3% - 4% and with an absolute maximum of 6%. Where a roundabout must be located at an intersection on a steeper terrain (> 6%), the designer should consider:

- If the entry lane is approaching the circulatory roadway on steep acclivity, a gentle slope should be provided at design vehicle length from the entry line to roadway. A smooth crest curve with adequate sight distance should be introduced to transition between the two slopes, or
- If the entry lane is approaching the circulatory roadway on declivity – a smooth sag curve should be introduced to transition the steep downhill slope to the circulatory roadway channel avoiding sharp curves.

On circulatory roadways, the longitudinal gradient has desirable minimum slope of 0.5% and desirable grade of 2%. Grades on the circulatory roadway greater than 4% should be avoided. Where the general slope of the land is greater than 4%, it will be necessary to grade the area around the roundabout, using a desirable maximum grade of 3% with an absolute maximum grade of 4% (see [Figure 3.57](#)).

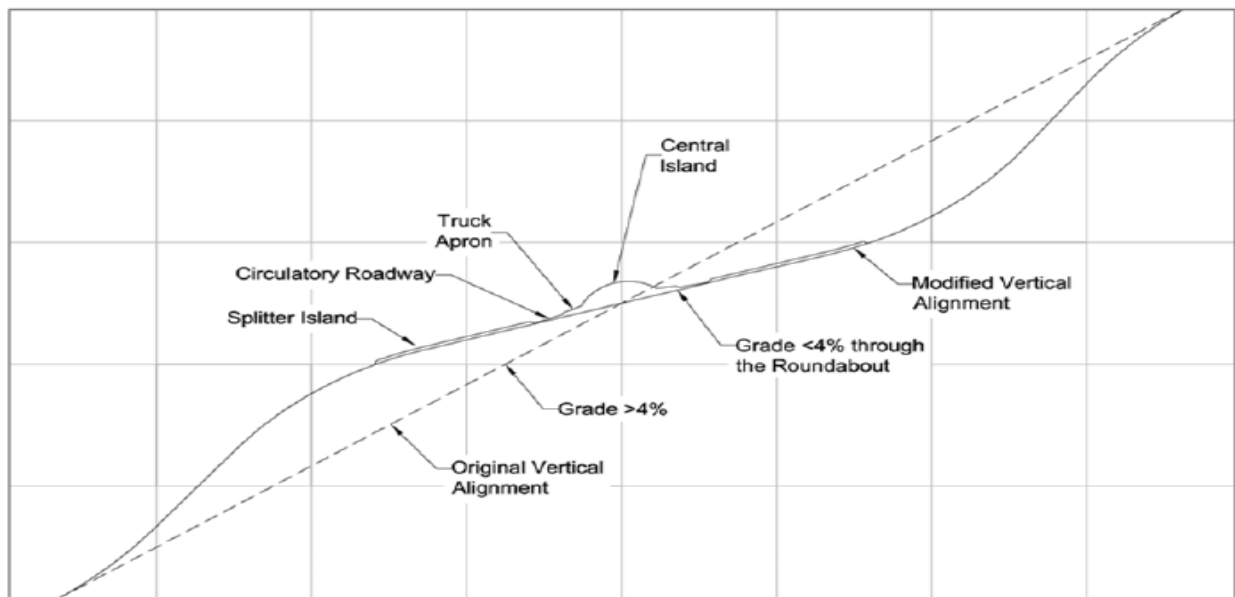

Figure 3.57 – Modification of the Vertical Profile to Achieve a More Desirable Grade (Source: Kittelson & Associates, Inc.)

3.11 Crossfalls

Adverse crossfalls (negative superelevation or non-crowned circulatory roadway) are generally recommended on single-lane roundabout circulatory roadways. The crossfall should be limited to a maximum of 3% depending on the surface pavement type. A desirable range of crossfalls commonly used on Portland cement concrete or asphalt concrete pavements are between 1.0 to 2.0%. On multilane roundabouts, adverse crossfalls are still preferred but care should be taken to ensure that the 3% slope threshold is not exceeded. Alternatively, the center line (or crown) on a multilane circulatory roadway can be cambered having positive superelevation to the inside half of the roadway towards the central island and adverse slope to the outer half away from the central island. Similarly, the 2/3 -1/3 rule should be followed ensuring that inner superelevation run off has the larger portion (see [Figure 3.55](#)). This has the advantage of providing positive superelevation for vehicles, particularly trucks that

are turning left through the roundabout and consistent cross slope for right-turning vehicles from the approach lanes. However, the use of a crown could cause some destabilization to the through traffic movements which would experience twists in the pavement from positive to negative to positive. If a crown is used at roundabouts the crossfalls used should preferably not exceed 2.0% (grade change of 4% across the crown). A further disadvantage is that a crown is relatively difficult to construct on a circulatory roadway with crossfalls.

3.12 Drainage

Drainage is an important consideration in the design of all roundabouts. The adverse camber on the circulatory roadway provides easy drainage and maintenance. It ensures the avoidance of cross drainage structures required to convey storm water from the curb inlet of the central island if positive superelevation were to be used. However, there may be circumstances where it is preferable to provide positive superelevation on a circulating roadway (e.g. on grade separated roundabouts on concrete decks) and drainage will have to be provided in the central island. Where positive superelevated circulating roadways are used, water will drain from the circulating roadway to the central islands. Care must be taken to ensure that there is no water pooling at the low points on the circulatory roadway profiles. A mountable curb design is recommended for curbs near truck aprons as shown as [Figure 3.58](#) (refer to *ALDOT Standard and Special Drawings* for typical curb drain details).

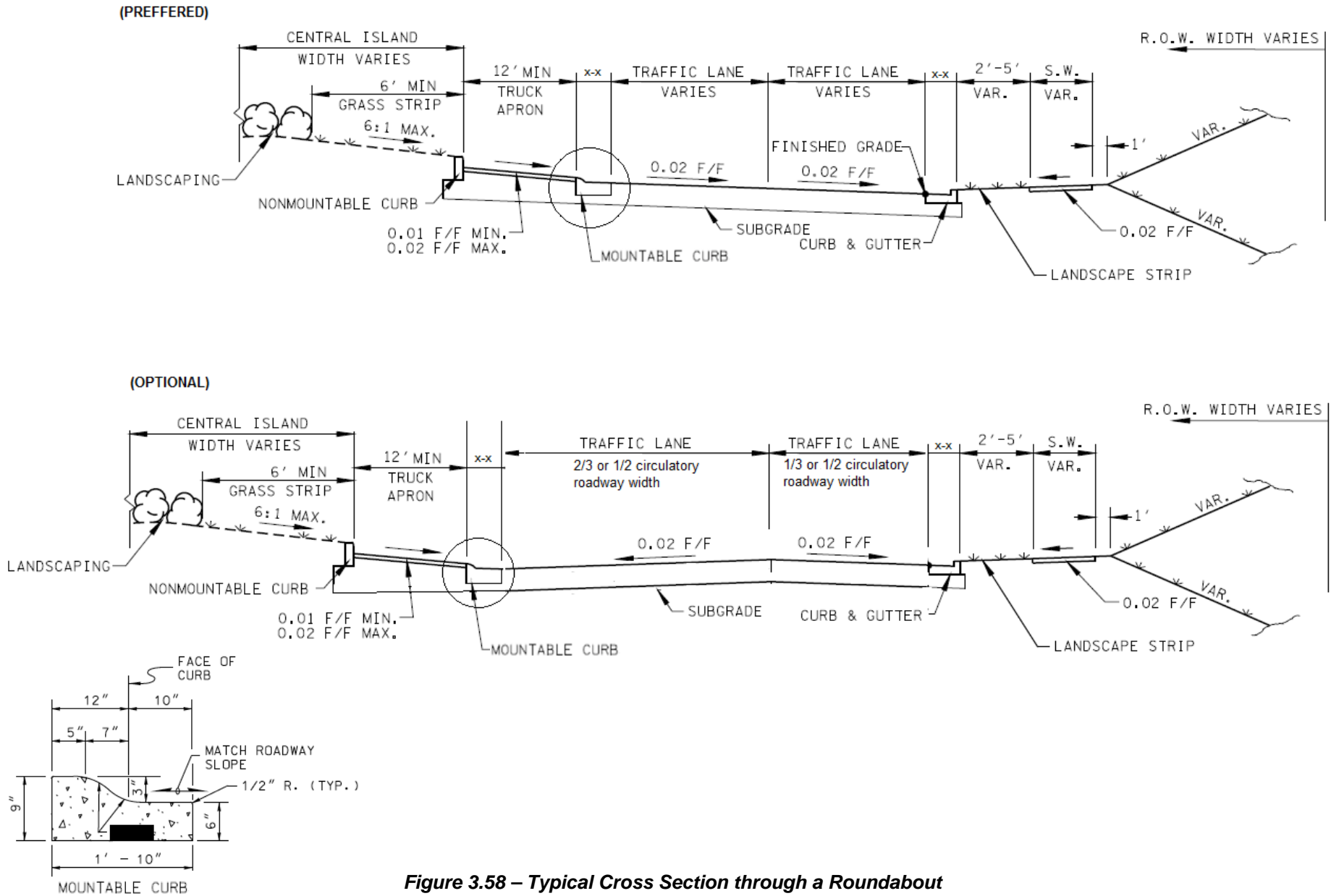

Figure 3.58 – Typical Cross Section through a Roundabout

3.13 Roundabout Access Management

An access management plan should be developed for the proposed location of the roundabout. The provision of accesses both public and private should conform to [ALDOT Access Management Manual](#) or other local guidelines. Private driveways may be accommodated closer to the roundabout with a right-in/right-out access control. Commercial driveways accessing the intersection should be designed as a small leg of the roundabout or provide one-way access outside splitter extent. Providing direct access for commercial driveways to the circulating lane without designing them as a leg of the roundabout should be avoided. Sample photographs are provided in [Figure 3.59](#) and [Figure 3.60](#).



Figure 3.59– Residential Driveways with Right-In/Right-Out Access Control (Source: NYSDOT¹⁴)



Figure 3.60– Commercial Driveway as Approach Leg to circulatory roadway (Source: NYSDOT¹⁴)

3.14 References

1. Robinson, B. W., L. Rodegerdts, W. Scarbrough, W. Kittelson, R. Troutbeck, W. Brilon, L. Bondzio, K. Courage, M. Kyte, J. Mason, A. Flannery, E. Myers, J. Bunker and GJ. Roundabouts: An Informational Guide. FHWA-RD-00 ed. (FHWA, ed.); 2000.
2. Rodegerdts, L., J. Bansen, C. Tiesler, J. Knudsen, E. Myers, M. Johnson, M. Moule, B. Persaud, C. Lyon, S. Hallmark, H. Isebrands, R. B. Crown, B. Guichet and AO. NCHRP Report 672: Roundabouts: An Informational Guide. 2nd ed. (Transportation Research Board of the National Academies, ed.). Washington D.C; 2010. Available at: http://onlinepubs.trb.org/onlinepubs/nchrp/nchrp_rpt_672.pdf.
3. American Association of State and Highway Transportation Officials (AASHTO). A Policy on Geometric Design of Highways and Streets. 6th ed. Washington D.C; 2011. Available at: www.transportation.org.
4. Wisconsin Department of Transportation (WisDOT). Wisconsin Department of Transportation Roundabout Guide. Wisconsin; 2013.
5. Washington State DOT (WSDOT). Design Manual. M. 22.1.10. Section 1320.05.
6. Alabama Department of Transportation (ALDOT). Standard and Special Drawings for Highway Construction.; 2014. Available at: http://alletting.dot.state.al.us/Docs/Standard_Drawings/2014_English/STDUS14_1000.pdf.
7. Federal Highway Administration (FHWA). Safety Aspects of Roundabouts.; 2014. doi:10.1190/SAGEEP.27-099.
8. New York State Department of Transport. Highway Design Manual: Chapter 26-Roundabouts. New York; 2013.
9. Russell ER. Accommodating Oversize / Overweight Vehicles at Roundabouts. (Kansas State University Transportation Center, ed.); 2013.
10. Ourston Roundabout Engineering. GHD Photo Gallery. (GHD, ed.). Available at: <http://www.roundaboutresources.org/complex-two-or-more-lane.html>.
11. Ritchie Scott and Wes Butch. Accommodating Trucks at Multilane Roundabouts. (TRB International Roundabout Conference, ed.). Carmel,IN; 2011.
12. Wisconsin Department of Transportation (WisDOT), And Minnesota Department of Transportation (MnDOT). Joint Roundabout Truck Study.; 2012. Available at: <http://www.terreroadalliance.org/research/factsheets/roundabouttrucks/documents/final.pdf>.
13. Michigan Department of Transport (MDOT). MDOT Photo Gallery.
14. Richard Schell, Howard McCulloch MH. Modern Roundabout Design. (New York State Department Of Transportation, ed.). New York; 2014. Available at: http://www.virginiadot.org/business/resources/LocDes/Presentations_L_n_D/vdot_design.pdf.

Chapter 4

Traffic Control

The [Manual on Uniform Traffic Control Devices for Streets and Highways](#)¹ (MUTCD) governs the installation of traffic control devices in the U.S. The guidance provided in the *ALDOT Roundabout Manual* should be supplemented with the most recent MUTCD¹. The role of traffic control devices is to help achieve the desired operational and safety standards of roundabouts. These control devices include pavement markings and road signs which guide and regulate road users entering, traveling within, and exiting the roundabout. Markings and signs should be consistent with the geometry and compatible with each other. They should be intuitive and be placed such that drivers have enough time to choose their desired lanes.

4.1 Pavement Markings

Markings on roundabout approaches and on circular roadways delineate the entries, exits, and the circulatory roadway lanes. These provide guidance for pedestrians and vehicle operators, and facilitate movement through the roundabout such that vehicles do not have to change lanes within the circulatory roadway in order to exit the roundabout in a given direction. [Figure 4.1](#) shows a typical pavement marking layout. The following sections discuss some of the relevant pavement markings adopted for roundabouts.

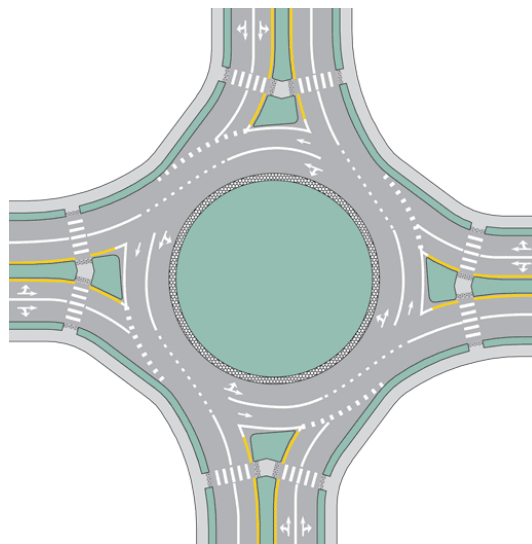

Figure 4.1 – Typical Pavement Marking Layout for Single Thru/Right lane and Left Turn lane
(Source: MUTCD, 2009)

4.1.1 Lane and Edge Striping for Approach and Circulatory Lanes

Figure 4.2 illustrates some of the more relevant pavement markings at roundabouts. All pavement marking materials shall however, conform to [ALDOT Standard Specifications for Highway Construction 2012 or latest Edition](#)².

4.1.2 Lane-Use Arrows

- Within the circulatory roadway of multilane roundabouts, normal lane-use arrows should be provided.
- If used on approaches to a multilane roundabout, lane-use arrows shall be fish-hook arrows, and the arrow in the left-most lane shall include an oval symbolizing the central island as shown in Figure 4.2.

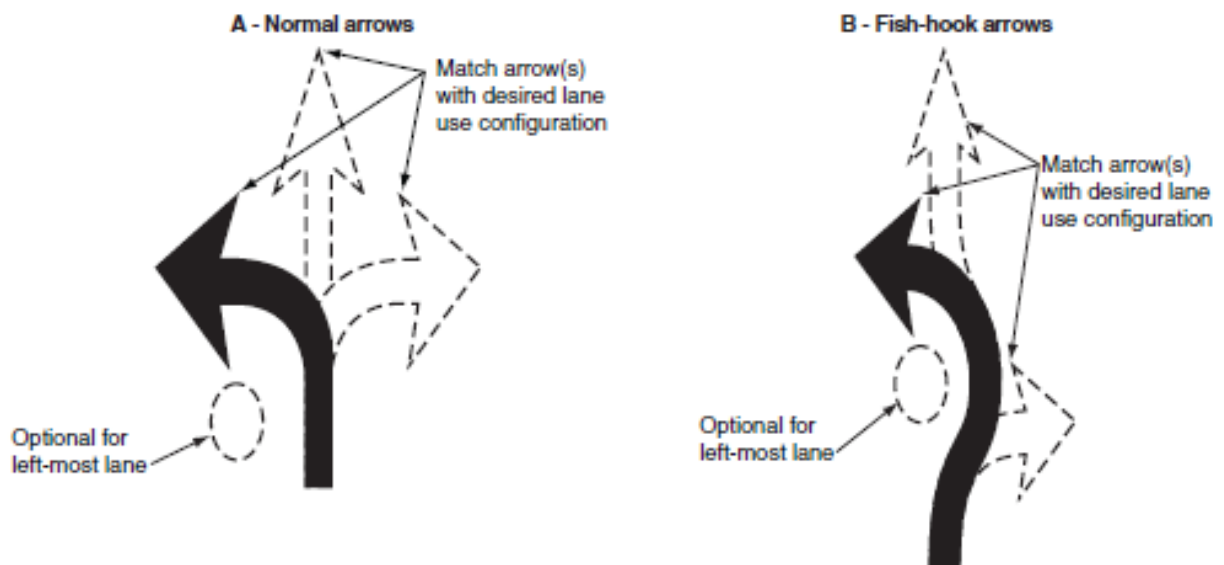

Figure 4.2 – Lane-Use Arrows (Source: MUTCD¹, 2009)

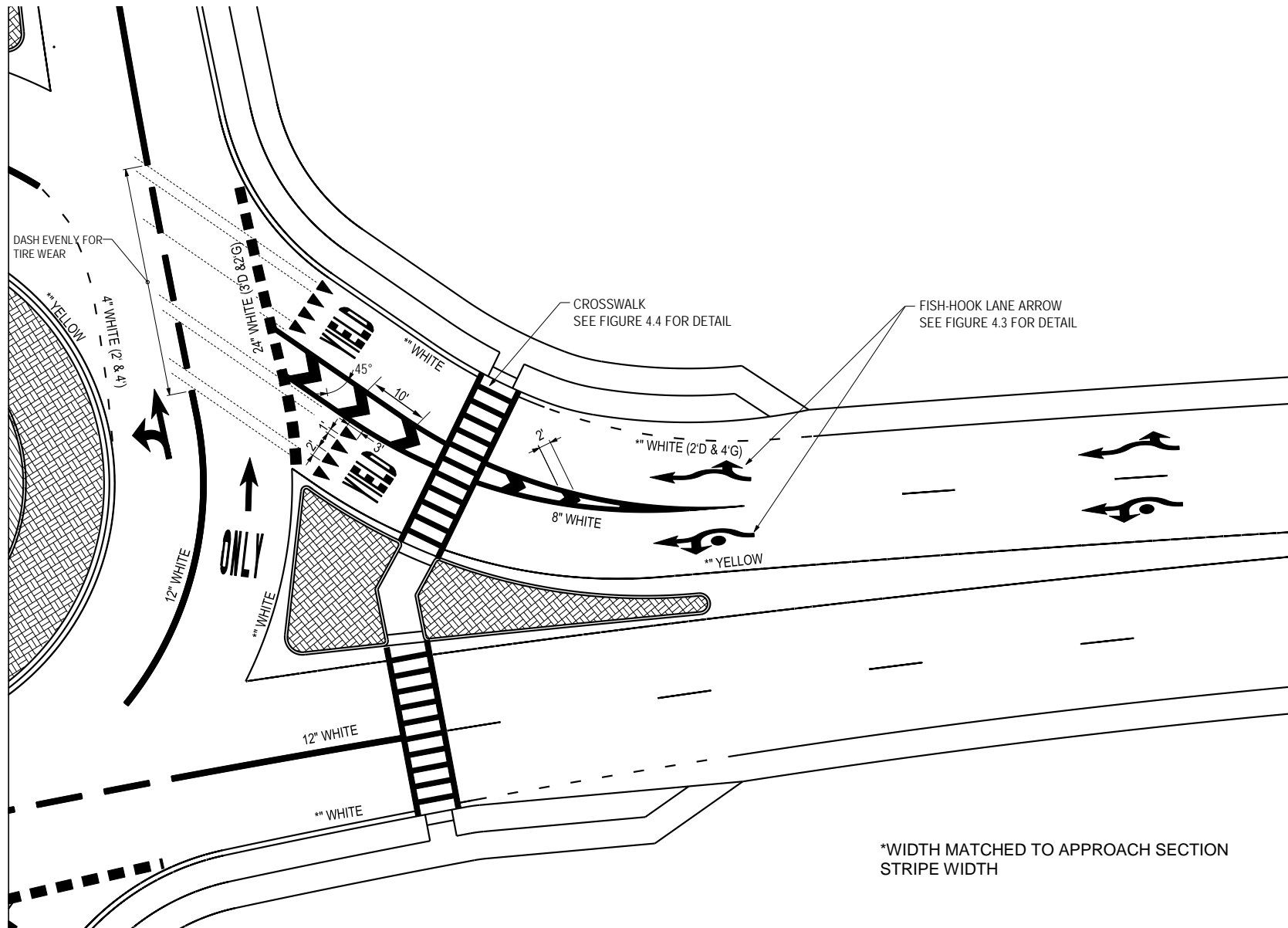

Figure 4.3 – Standard Lane Striping Widths and Color Markings (NYSDOT³)

4.1.3 Pedestrian Crossings

- No pedestrian crosswalks to or from the central island of roundabouts.
- Crosswalks should be marked across roundabout entrances and exits to indicate where pedestrians are intended to cross.
- Crosswalks should be a minimum of 20 feet from the edge of the circulatory roadway.
- All crosswalk markings shall be white.
- The ladder type and the combined type shall have the longitudinal lines parallel to the lane lines.

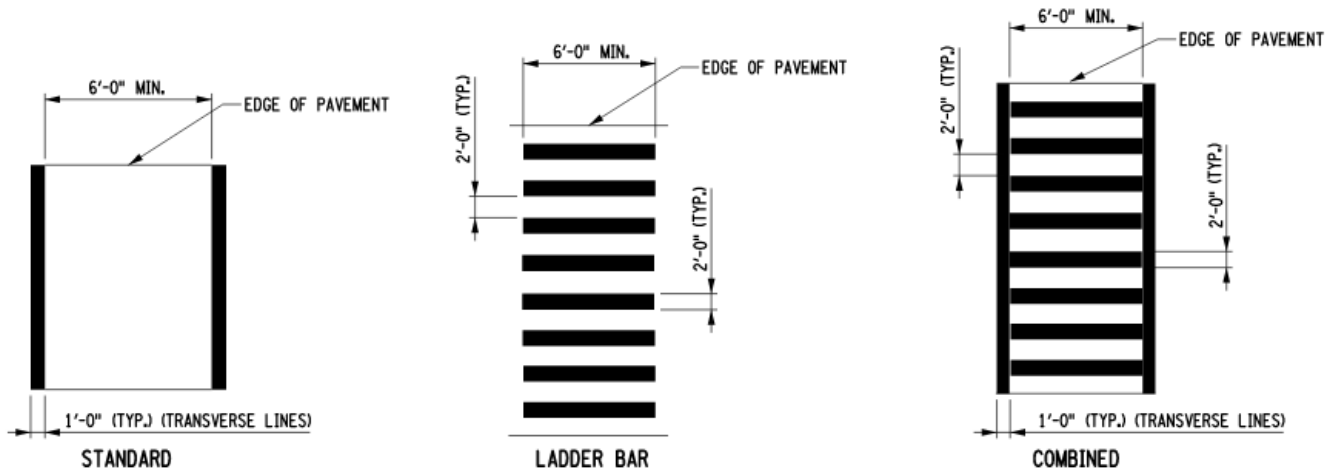

Figure 4.4 – Typical Crosswalk Details

4.1.4 Yield Warning Triangles

- A yield line may be used to indicate the point behind which vehicles are required to yield at the entrance to a roundabout.
- If used at multilane roundabouts, yield lines should be staggered on a lane-by-lane basis.

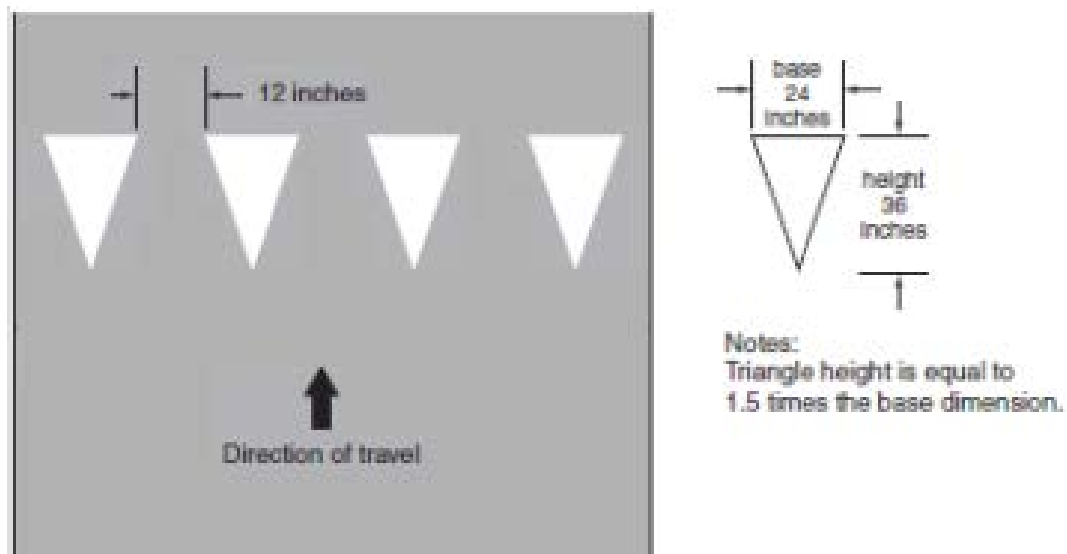

Figure 4.5 – Yield Line Dimensions (Source: MUTCD¹)

4.1.5 Pavement Words and Symbols

Words and symbols may be used as determined by engineering judgment to supplement signs and pavement markings for additional emphasis as shown in [Figure 4.6](#). Among the words and symbols that may be used are the following:

- ONLY (word) may be used on approaches to roundabout
- YIELD AHEAD (word or symbol) may be used on approaches to roundabout
- YIELD (word) may be used on approaches to roundabout.

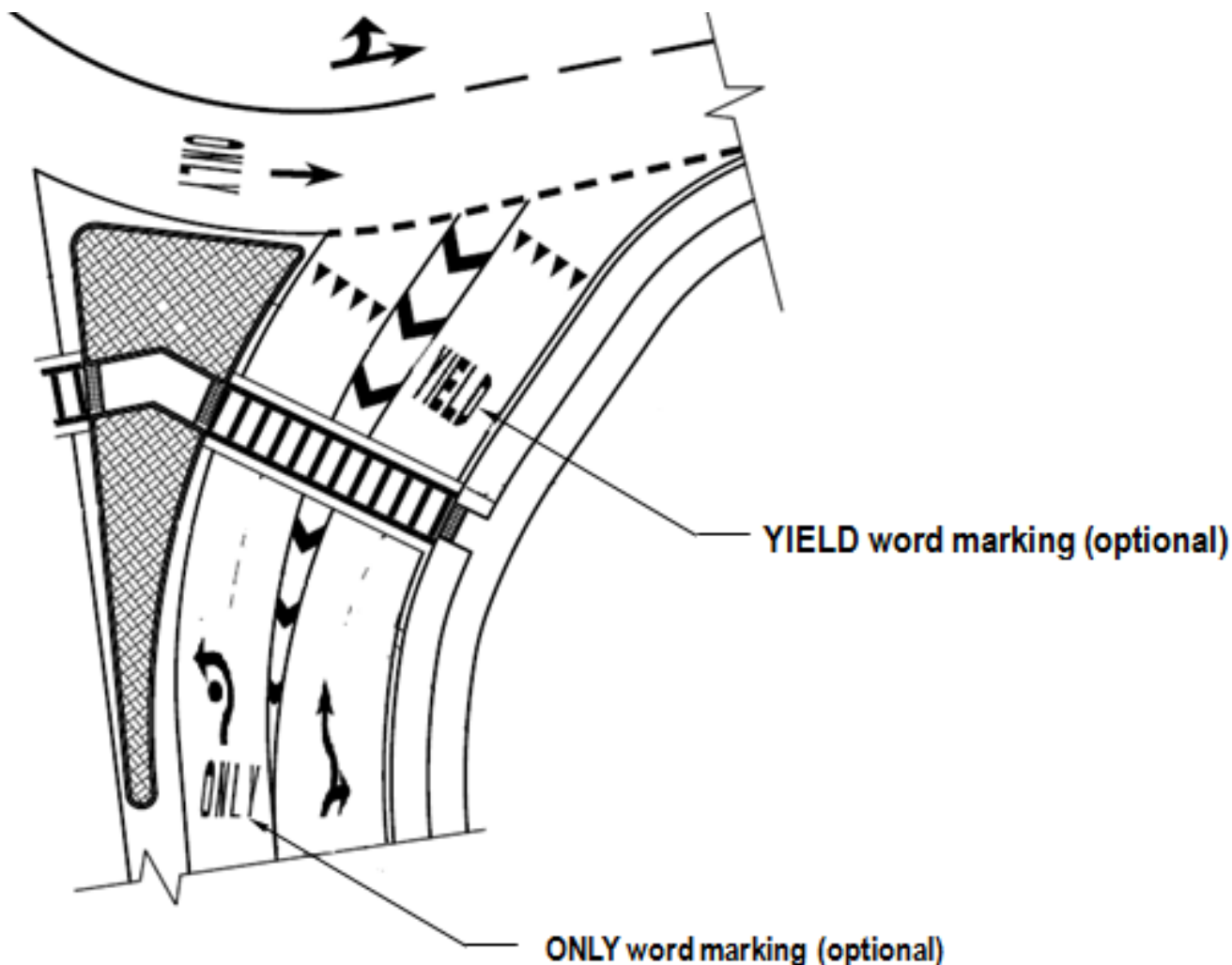









Figure 4.6 – Pavement Words and Symbols (Source: NCHRP 672⁴)

For further guidance on pavement markings for roundabout of various geometric and lane use configurations refer to the relevant section ([Section 3B:20](#)) of the latest version of MUTCD¹.

4.2 Signing

Signing must be consistent with the pavement markings and should provide emphasis to the geometry and pavement markings. [Table 4.2](#) presents a list of signs used in roundabout design. A typical signing placement plan at a roundabout is shown in [Figure 4.7](#).

TABLE 4.2 Type and Placement Signs within Roundabout

| | |
|---|---|
|  <p>W2-6 W13-1</p> | <p>Roundabout Ahead Sign (W2-6) with Speed Advisory Plaque (W13-1) – Follow the MUTCD guidelines for placement of this sign. The advisory sign should be the circulating speed of the roundabout.</p> |
|  <p>R3-8</p> | <p>Lane Usage Sign (R3-8) – This sign must be consistent with the pavement markings. This sign should not be combined with the destination sign for clarity of the user. It is useful to provide a detail of this sign. This sign should be placed according to MUTCD guidelines</p> |
|  <p>D1-special</p> | <p>Destination Sign (D-1 special) – This sign does not need to be used in every roundabout design, but is useful in intersections with tourist destinations. A detail of this sign must be provided in the roundabout plan set and can be seen in Standard Detail RB-11. This sign should be placed in accordance with MUTCD guidelines after the Roundabout Ahead sign, but before the Lane Usage Sign</p> |
|  <p>W11-2 W16-7P</p> | <p>Pedestrian Crosswalk Sign (W11-2) and Supplemental Arrow (W16-7p)-These should be placed near the outside curb of the roundabout on the entrance crosswalk and exit crosswalk. Care must be taken to avoid masking a pedestrian with this sign and the yield sign on the entrance.</p> |
|  <p>R1-2</p> | <p>Yield Sign (R1-2) – On a multilane roundabout this sign should be placed both on the outside of the roundabout curb and in the splitter island. On a single-lane roundabout with a skewed approach, this sign should be placed on the splitter island as well as along the outside curb so that the vehicle approaching the roundabout has adequate time to see it.</p> |
|  <p>R6-1 R6-4a</p> | <p>ONE WAY Sign (R6-1R) and or Chevron Sign (R6-4a-b) – The signs can be used separately to indicate direction of travel in the circulatory roadway or together to re-emphasize the direction of travel within the circulatory roadway. This sign should be placed in line with drivers-eye view. The height of this sign is 4.5 feet.</p> |
|  <p>R4-7</p> | <p>KEEP RIGHT signs (R4-7, R4-7a and R4-7b) should be used at the nose of all non-mountable splitter islands.</p> |
|  <p>R2-1</p> | <p>SPEED LIMIT sign (R2-1) is optional and should be used to reduce higher speed limits in advance of the roundabout.</p> |

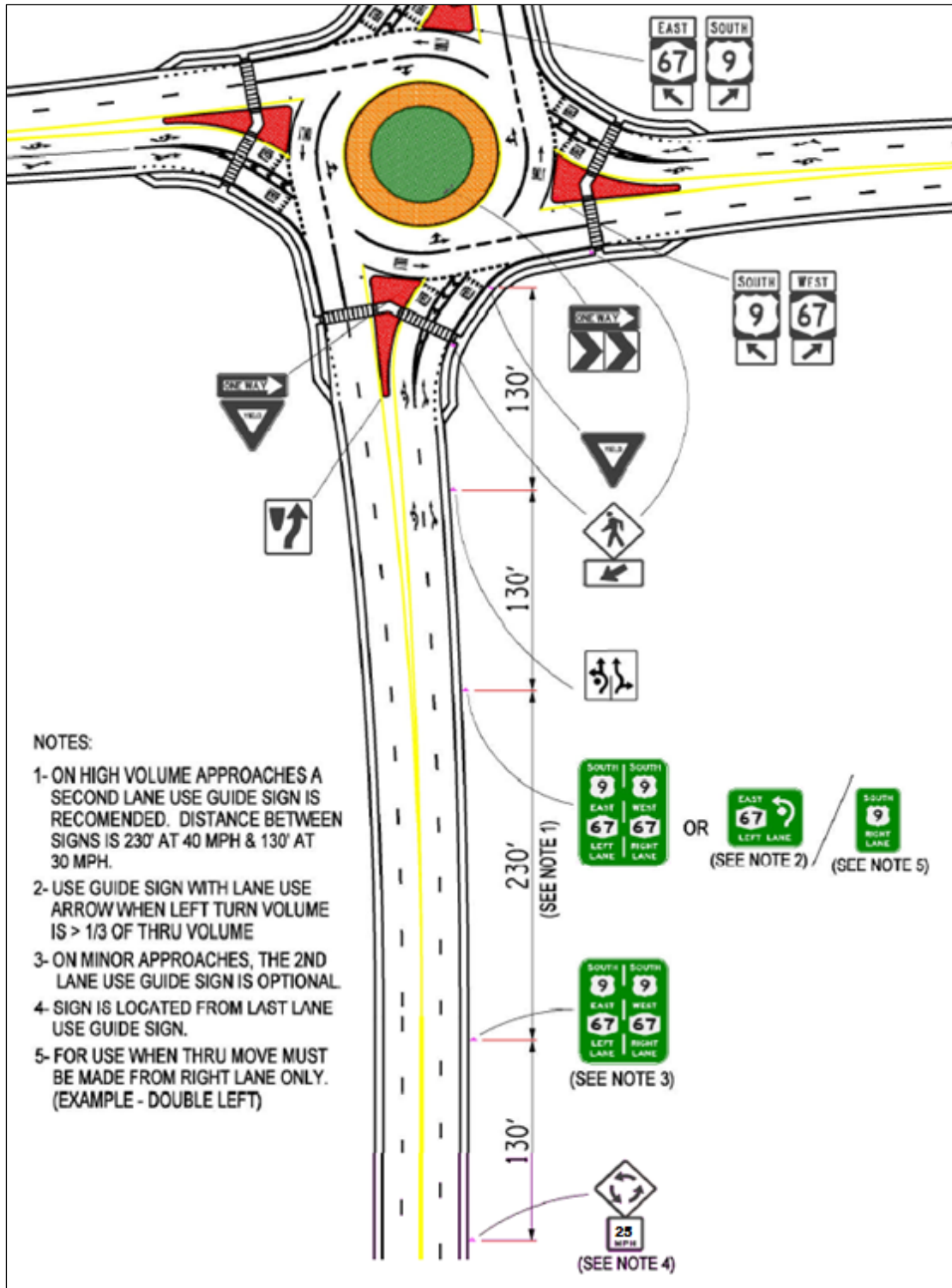

Figure 4.7 – Typical Signing Placement Layout (Source: NYSDOT³)

4.3 References

1. Federal Highway Administration (FHWA). *Manual on Uniform Traffic Control Devices (MUTCD)*. 2009th ed. (FHWA, ed.). Washington D.C; 2012. Available at: http://mutcd.fhwa.dot.gov/pdfs/2009/pdf_index.htm.
2. Alabama Department of Transportation (ALDOT). *Standard Specifications for Highway Construction*.; 2012. Available at: <http://www.dot.state.al.us/conweb/doc/Specifications/2012 DRAFT Standard Specs.pdf>.
3. New York State Department of Transport. *Highway Design Manual: Chapter 26-Roundabouts*. New York; 2013.
4. Rodegerdts, L., J. Bansen, C. Tiesler, J. Knudsen, E. Myers, M. Johnson, M. Moule, B. Persaud, C. Lyon, S. Hallmark, H. Isebrands, R. B. Crown, B. Guichet and AO. *NCHRP Report 672: Roundabouts: An Informational Guide*. 2nd ed. (Transportation Research Board of the National Academies, ed.). Washington D.C; 2010. Available at: http://onlinepubs.trb.org/onlinepubs/nchrp/nchrp_rpt_672.pdf.

Chapter 5

Lighting

A driver approaching a roundabout must be able to perceive and react to other vehicles approaching or circulating in the roundabout and pedestrians at the crosswalk at all times. In the absence of daylight, lighting provides the needed visibility and supplements traffic control devices to properly guide drivers and pedestrians through the roundabout. This underscores the safety and operational importance of providing lighting at roundabouts. Existing roadway lighting should not eliminate the need to provide lighting for the roundabout. Consideration, however, may be given to the amount of illumination provided by existing road lighting to ensure uniformity in lighting between the approach and the roundabout. The amount of light in the intersection should be equal to the sum of the values used for each approaching roadway. It may be sufficient to have retroreflectorized signs and markings to guide drivers through the roundabout without requiring additional lighting, especially at locations of low pedestrian activity. This judgment should be exercised sparingly and in consultation with ALDOT.

5.1 Key Items to Consider

Lighting should emphasize roundabout features by achieving the following:

- all pedestrian crosswalks and bicycle merging areas are clearly identifiable and pedestrians in the crosswalk are visible in advance and are not backlit by the placement of light beyond crosswalk
- vehicles operating on the circular roadway can clearly see around the roadway and anticipate entering or exiting vehicles as well as pedestrians
- lighting within the roundabout is consistent with the lighting of the intersecting roadways and the local environment
- lighting is supplemented by signs and markings to emphasize and support safe driving behavior.

5.2 Lighting Levels

Desired illumination levels vary depending on both road functional classification and pedestrian or area classification as shown in [Table 5.1](#). The illumination levels indicated in the table are the combined effect of illuminations of the intersecting roadways at the roundabout. Consideration should be given to local illumination guidelines at the roundabout to ensure that lighting is consistent.

The structural requirements (design and equipment types) for roadway lighting shall be in accordance with the requirements given in Section 718, [ALDOT Standard Specification for Highway Constructions](#)¹. Additional information and guidelines in developing lighting plans can be found in the following:

- [IES Design Guide for Roundabout Lighting](#)²
- [AASHTO Roadway Lighting Design Guide](#)³
- [IES RP-8: The American National Standard Practice for Roadway Lighting](#)⁴

TABLE 5.1 Recommended Minimum Level of Lighting at Roundabout (Source: NCHRP 672⁵)

| Functional Classification | Maintained Average Horizontal Lighting on the Pavement based on Pedestrian/ Area Classification* | | | Uniformity Ratio |
|---------------------------|--|-----------------|-----------------|-------------------|
| | Commercial | Intermediate | Residential | E_{avg}/E_{min} |
| Arterial/Arterial | 3.4 fc (34 lux) | 2.6 fc (26 lux) | 1.8 fc (18 lux) | 3:1 |
| Arterial/Collector | 2.9 fc (29 lux) | 2.2 fc (22 lux) | 1.5 fc (15 lux) | 3:1 |
| Arterial/Local | 2.6 fc (26 lux) | 2.0 fc (20 lux) | 1.3 fc (13 lux) | 3:1 |
| Collector/Collector | 2.4 fc (24 lux) | 1.8 fc (18 lux) | 1.2 fc (12 lux) | 4:1 |
| Collector/Local | 2.1 fc (21 lux) | 1.6 fc (16 lux) | 1.0 fc (10 lux) | 4:1 |
| Local/Local | 1.8 fc (18 lux) | 1.4 fc (14 lux) | 0.8 fc (8 lux) | 6:1 |

*Note:

1. Commercial: Business areas where ordinarily there are many pedestrians during night hours. These include downtown retail areas, concert halls, stadia, transit terminals definition. The areas contain land use which attracts a relatively heavy volume of nighttime vehicular and/or pedestrian traffic on frequent basis (over 100 peds/hour)
2. Intermediate: Those areas of a municipality often with moderately heavy nighttime pedestrian activity (11 to100 peds/hour) such as in blocks having libraries, community recreation centers, large apartment buildings, industrial buildings, or neighborhood retail stores
3. Residential: A residential development, or a mixture of residential and small commercial establishments, with few pedestrians at night (10 or less peds/hour)

5.3 Lighting Location

It is preferred to place lighting at locations on the approach side of crosswalks to provide positive contrast for the crossing pedestrians, Yield signs, and other devices around the perimeter of the roundabout (center island offset across from splitter island with truss arms). Thus, illumination should be provided for each of the conflict points between circulating and entering traffic in the roundabout and at the beginning of the raised splitter islands. Luminaires should be positioned on the downstream side of each crosswalk to improve the visibility of pedestrians. Ground-level lighting within the central island that shines upward toward features, including signs and landscaping in the central island, can also improve visibility. [Figure 5.1](#) and [Figure 5.2](#) illustrate different layouts of luminaire pole placement at roundabouts.

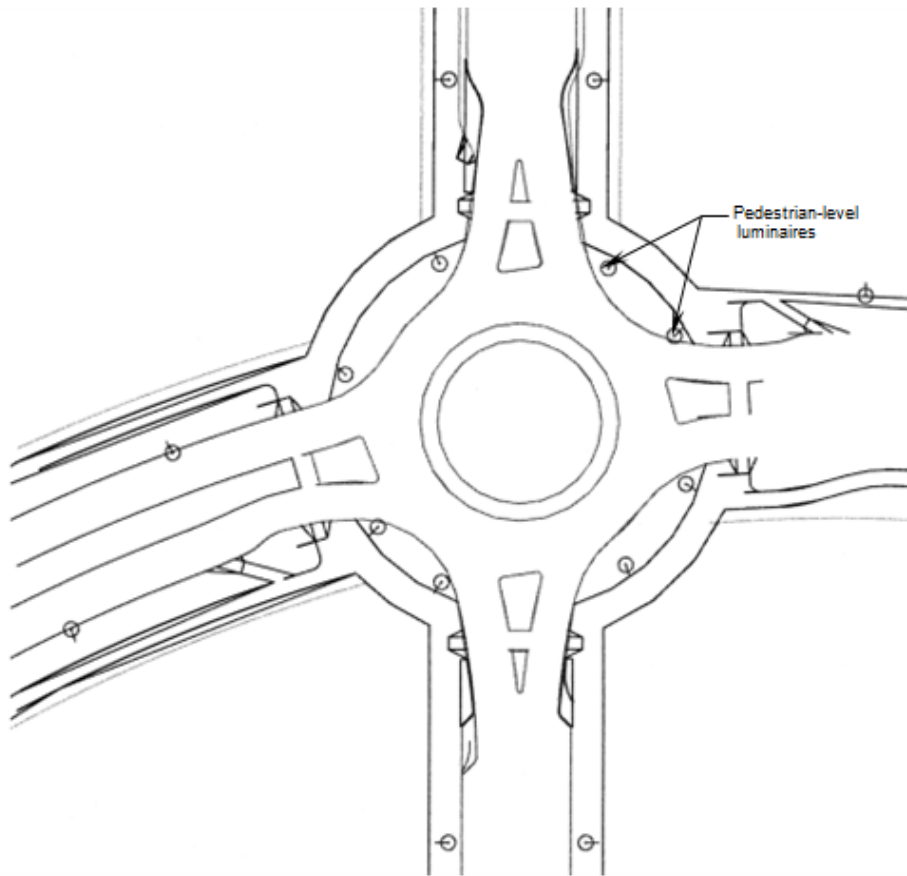

Figure 5.1 – Typical Pole Placement Plan Using Pedestrian-Level Luminaire (Source: KDOT⁶)

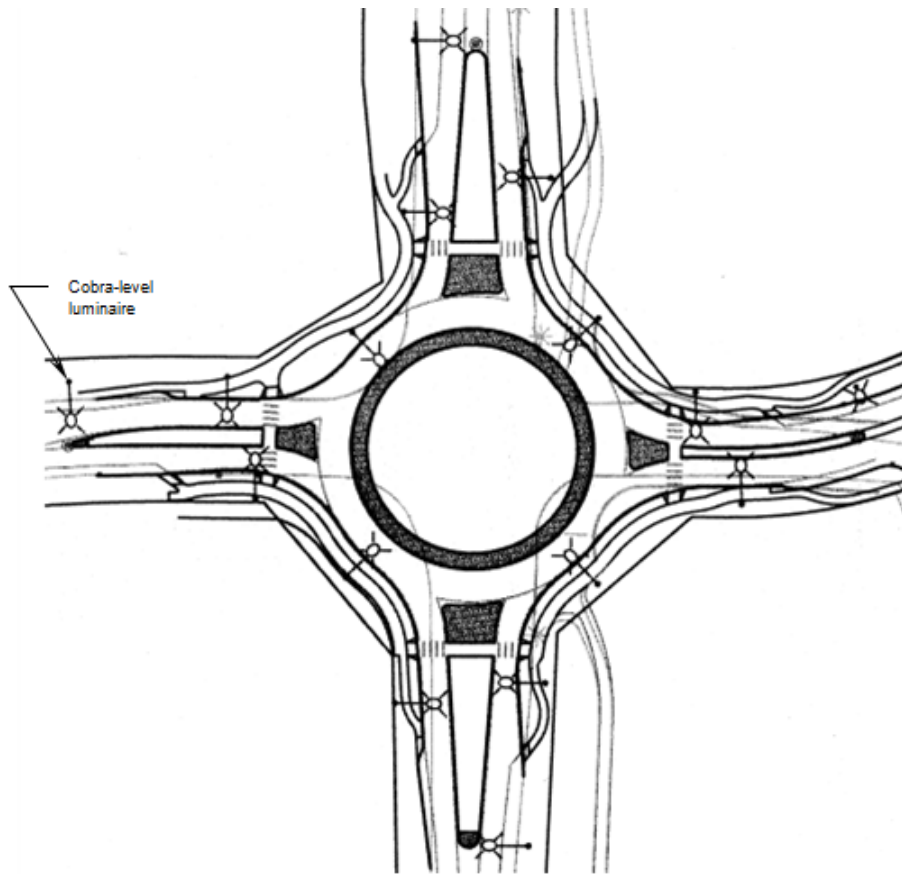

Figure 5.2 – Typical Pole Placement Plan Using Cobra-Style Luminaire (Source: KDOT⁶)

5.4 References

1. Alabama Department of Transportation (ALDOT). *Standard Specifications for Highway Construction.*; 2012. Available at: <http://www.dot.state.al.us/conweb/doc/Specifications/2012 DRAFT Standard Specs.pdf>.
2. Illuminating Engineering Society of North America. *Design Guide for Roundabout Lighting.* IES DG-19-. New York; 2008.
3. AASHTO. *Roadway Lighting Design Guide.* 2005.
4. Illuminating Engineering Society of North America. *American National Standard Practice for Roadway Lighting.* RP-8th-00 ed. New York; 2005.
5. Rodegerdts, L., J. Bansen, C. Tiesler, J. Knudsen, E. Myers, M. Johnson, M. Moule, B. Persaud, C. Lyon, S. Hallmark, H. Isebrands, R. B. Crown, B. Guichet and AO. *NCHRP Report 672: Roundabouts: An Informational Guide.* 2nd ed. (Transportation Research Board of the National Academies, ed.). Washington D.C; 2010. Available at: http://onlinepubs.trb.org/onlinepubs/nchrp/nchrp_rpt_672.pdf.
6. Kittelson & Associates, Inc. and TC. *Kansas Roundabout Guide: A Supplement to FHWA's Roundabouts: An Informational Guide.* (Kansas Department of Transportation., ed.). Topeka, Kansas; 2003. Available at: <http://safety.fhwa.dot.gov/Intersection/resources/fhwas09027/resources/Kansas Roundabout Guide.pdf>.

Chapter 6

Landscaping

Roundabouts provide landscaping opportunities not possible for traditional intersections. The primary objectives and considerations of incorporating landscaping into a roundabout design are to:

- Make the central island the focal point, reducing entire viewing areas across from the entry point and thus improving safety
- Improve the aesthetics of the surrounding area
- Provide visual guidance to the roundabout
- Reduces glare in the roundabout environment
- Avoid obscuring the vehicles in the roundabout or signage to the driver
- Maintain adequate left entry sight distance and right exit sight distance for vehicles
- Clearly indicate to drivers that they cannot pass straight through the intersection
- Help pedestrians who are visually impaired to locate sidewalks and crosswalk
- Mitigate erosion

Landscaping plans must give consideration of future maintenance requirements to ensure traffic is not unduly interrupted during maintenance activities. Candidate zones with landscaping opportunities within roundabouts are shown in [Figure 6.1](#).

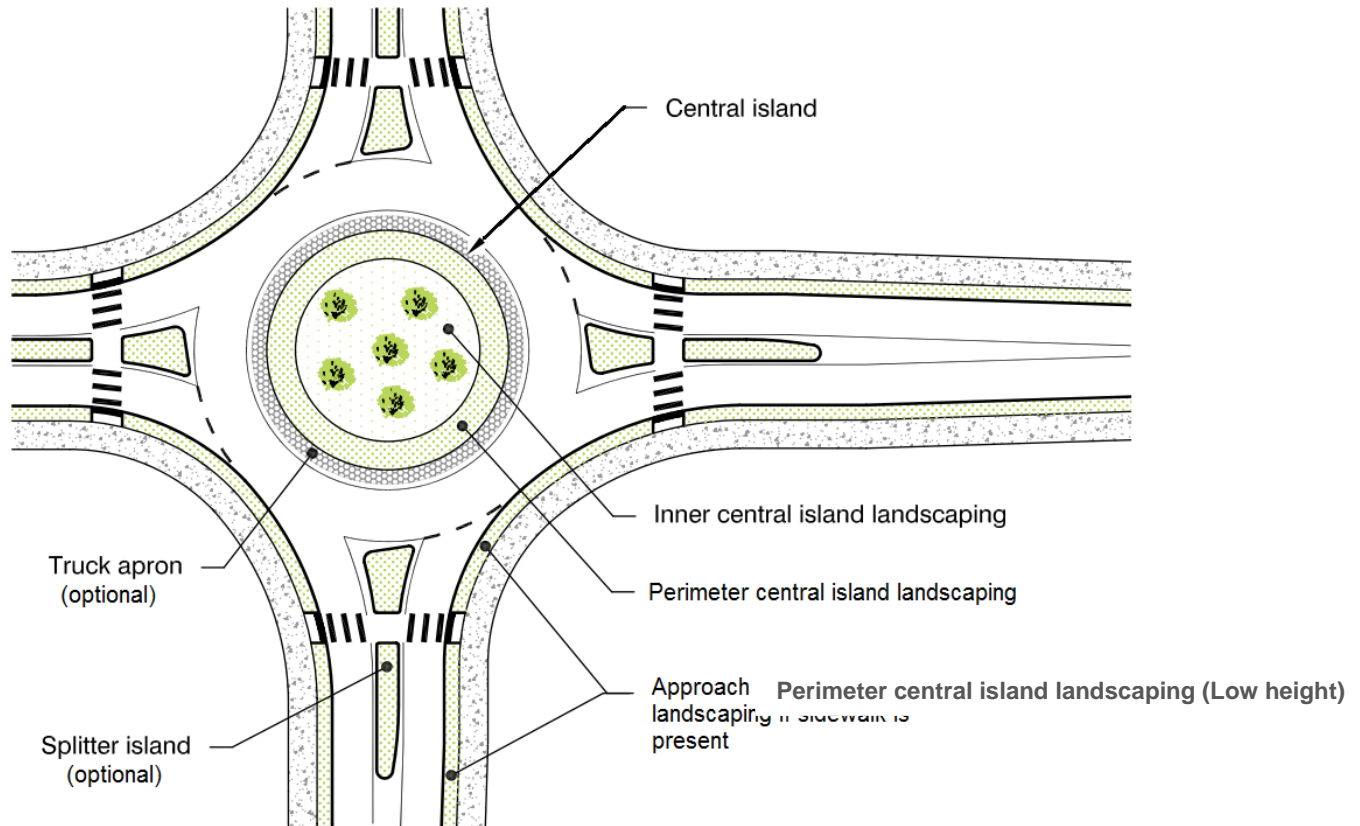

Figure 6.1 – Typical Landscaping Zones within Roundabout (Source: NCHRP 672¹)

6.1 Central Island Landscaping

The primary considerations for the central island landscaping include:

- Landscaping within the central island should be kept outside the sight triangles (as shown in [Section 3.8.5.2](#)) unless low growth vegetation less than 2ft is provided
- Vegetation within the central island should preferably contrast with vegetation on the outside of the roundabout to help increase driver recognition of the central island
- Landscaping materials that require frequent watering should be avoided. However, if watering is required or planned, conduits under roadway are recommended (to be install during construction)
- Conduits for electrical services (and other utilities) should be considered as deemed appropriate
- Fixed objects must be located outside the sight distance and located to minimize the incidence of errant vehicles running into them
- Street furniture that may attract pedestrian traffic to the central island, such as benches, monuments with small text, and fountains should be avoided
- No parking of vehicles is allowed in the roundabout, except for maintenance purposes.

A schematic representation of landscaping detail in a central island is shown in Figure 6.2. An example illustration of a central Island landscaping is shown in Figure 6.3.

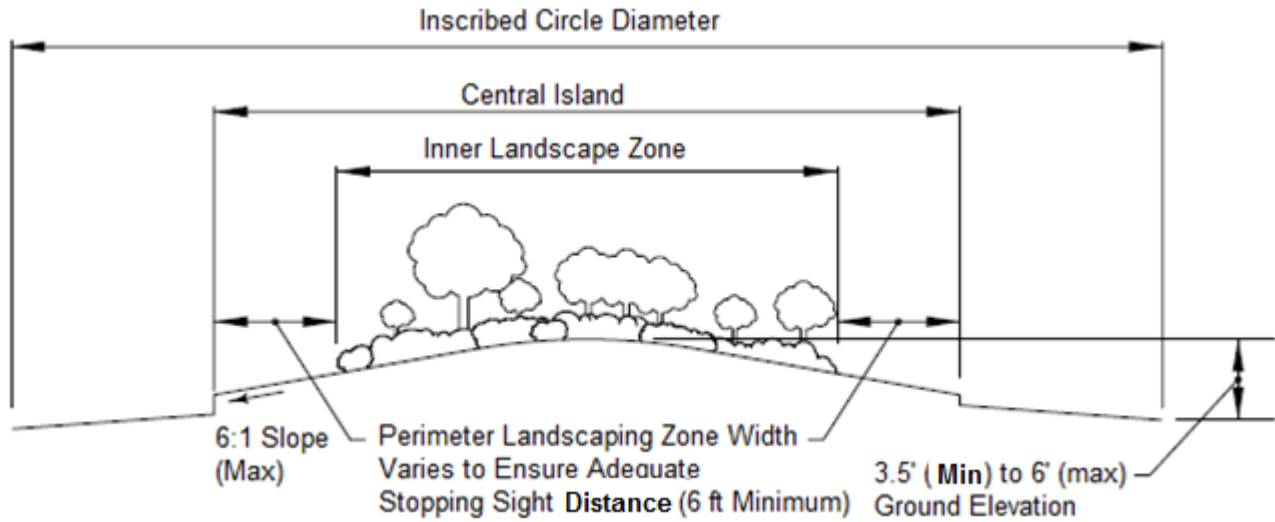

Figure 6.2 – Typical Landscaping Detail in Central Island (Source: NCHRP 672¹)



Figure 6.3 – Example of Central Island Landscaping (Source: WISDOT, US 45/ Fernau Avenue²)

6.2 Splitter Island and Approach Landscaping

The primary considerations for splitter island and approach landscaping include:

- Landscaping should be done in such a way to avoid obstructing vehicles, pedestrians, and sight distance, since the splitter islands are usually located within the critical sight triangles
- Landscaping in the outer curb of the approach lanes and on the splitter island should be constructed with low-growth plants and grasses
- Splitter islands should generally not contain trees, planter boxes, or light poles
- Preference should be given to hardscape treatments like a simple patterned concrete or paver surface on splitter islands in lieu of landscaping

An example illustration of splitter island landscaping is shown in [Figure 6.4](#).



Figure 6.4 – Example of Splitter Island Landscape Treatment (Source: FHWA 00067³)

6.3 References

1. Rodegerdts, L., J. Bansen, C. Tiesler, J. Knudsen, E. Myers, M. Johnson, M. Moule, B. Persaud, C. Lyon, S. Hallmark, H. Isebrands, R. B. Crown, B. Guichet and AO. *NCHRP Report 672: Roundabouts: An Informational Guide*. 2nd ed. (Transportation Research Board of the National Academies, ed.). Washington D.C; 2010. Available at: http://onlinepubs.trb.org/onlinepubs/nchrp/nchrp_rpt_672.pdf.
2. Wisconsin Department of Transportation (WISDOT). *US 41 Project Gallery*. Wisconsin; 2010. Available at: <http://www.us41wisconsin.gov/gallery/roundabouts>.
3. Robinson, B. W., L. Rodegerdts, W. Scarbrough, W. Kittelson, R. Troutbeck, W. Brilon, L. Bondzio, K. Courage, M. Kyte, J. Mason, A. Flannery, E. Myers, J. Bunker and GJ. *Roundabouts: An Informational Guide*. FHWA-RD-00 ed. (FHWA, ed.); 2000.

Chapter 7

Construction

7.1 Construction Plans

The following plan sheets shall be included in the roundabout construction drawings. This list is not exhaustive and may require additional drawings depending on the project scope:

- (1) Staging plan with detour routes (as appropriate)
- (2) Staking plan with curve data (if applicable)
- (3) Paving plan and jointing plan
- (4) Lighting plan
- (5) Signing plan
- (6) Pavement marking plan
- (7) Drainage plan
- (8) Landscaping plan (if applicable)

7.2 Construction Staging

Full road closures, partial road closures, and lane closures all facilitate the completion of roadway construction projects. When applied strategically, these strategies can serve as effective ways to manage safety and disruption of traffic in work zones. Full closures in commercially developed areas or at single point location should be avoided. Temporary bypass lanes may supplement construction staging with partial closure.

7.3 Work Zone Traffic Control

Full road closure is designed to eliminate the exposure of motorists to work zones and workers to traffic by temporarily closing a facility for rehabilitation or maintenance. During full road closure, traffic is detoured, allowing workers full access to roadway facilities. It is not suitable for all construction situations. A full closure approach may be used for an extended period of time, on weekends or nights.

All traffic control devices should be installed as indicated in the traffic control plan (TCP). These traffic controls should remain in place as long as construction is occurring and then be removed when the

controls no longer apply. As construction nears completion, use of stop control may be used when the intersection is not fully operational as a roundabout (refer to Part 6 of the MUTCD for requirements regarding work zone traffic control).

7.3.1 Pavement Markings

Temporary pavement markings should be used on binder layer only. They should be the same layout and dimension as those used for the final pavement. Additional pavement markings may be used to clearly show the intended direction of travel. In cases where pavement markings cannot be placed, channelizing devices (i.e., cones, tubular markers, and/or drums) should be used to establish the travel path (see Chapter 4 for more details on pavement markings).

7.3.2 Signing

The signing in work zones should consist of all necessary signing for the efficient movement of traffic through the work area; pre-construction signing advising the public of the planned construction, and any regulatory and warning signs necessary for the movement of traffic outside of the immediate work area. All permanent roundabout signings must be installed and inspected before opening a roundabout to traffic (see Chapter 4 for more details on signing).

7.3.3 Lighting

Temporary night lighting shall be provided at all flagger stations. Desired illumination levels vary depending upon the nature of the task involved. An average horizontal luminance of 5 foot candles can be adequate for general activities. An average horizontal luminance of 10 foot candles can be adequate for activities around equipment. Tasks requiring high levels of precision and extreme care can require an average horizontal luminance of 20 foot candles. Partial use of the intersection may require temporary lighting to help direct the drivers (see Chapter 5 for more details on lighting).

7.4 Construction Coordination

The designer, District Manager, or project engineer must be responsive to the contractor's questions and remain engaged to ensure that design details are implemented according to the design specifications. Occasionally, variations may arise as a result of unanticipated site conditions. *Any changes in lane widths, radii, grades, or other geometric parameters must be communicated to the design engineer as this can adversely affect safety and operational performance of the roundabout.*

Water, gas and power lines must be identified and clearly marked out on the layout plan to guide construction and to avoid severances to utility services. New or proposed utility lines must be built into the design including provision of underground conduits, manhole placement, and setting minimum vertical clearances for utility lines. This requires coordination with the utility service providers in anticipation of their future spatial requirements within the intersection.

7.5 Public Education

The strategies adopted in Section 2.1.6 of Chapter 2 can be applied during the construction stage to notify the public about any changes in traffic patterns. Any detour plans should be posted on the agency website and in the newspaper for the public notice.

Chapter 8

Maintenance

Maintenance activities on roundabouts are key components in ensuring safe and efficient use of the roundabout. Both routine and periodic maintenance should be performed by the road agency. The agency may consider a performance-based contract for maintenance activities and re-assess the performance periodically every 4-5 years, or as may be determined by the agency. Routine (typically annual) maintenance activities include shrub pruning/ trimming, cleaning drainage structures, pothole patching, snow removal. Periodic maintenance (pavement resurfacing) should take place every 8-10 years (as appropriate), provided that routine maintenance is carried out appropriately and road use is as expected.

8.1 Landscaping Maintenance

Maintenance of landscaping in the central island is particularly onerous as maintenance vehicles on the circulatory roadway can create disruption of traffic. The landscape designer should take into consideration this difficult task and should provide landscape objects that require minimal maintenance as much as applicable. Maintenance activities should be scheduled during off-peak traffic periods and preferably restricted to smaller machines and manual operations. Where large traffic volume is expected, a parking area may be provided in the central island to serve as docking platform for maintenance vehicles (see [Figure 8.1](#)). It is advantageous to have drainage structures outside the circulatory roadway for easy maintenance and minimal traffic interference. This can be achieved by having negative super elevation runoff away from the central island. Where mechanical sprinkler systems for landscaping on central islands are to be used, an underdrain should be installed to prevent excess water flowing onto the circulating roadway as this may decrease vehicle side friction.

8.2 Snow/Ice Removal

Although snow is a rare event in most of Alabama, some areas occasionally experience snow dusting to moderately heavy snowfall every few years. A significant portion of the state faces icing threats each year. The agency may deploy the appropriate snow removal technology (such as application of chemical treatment and/or sanding to improve traction) to these areas or incorporate this activity in the performance-based maintenance contract. Care should be taken when storing snow around the roundabout (see [Figure 8.2](#)). The windrows created must be kept away from obstructing drivers' sight lines and away from the entry visibility splays. For more information on snow removal, refer to *NCHRP 672*¹.



Figure 8.1 – Parking Area Provision for the Docking of Maintenance Vehicle (Source: NCHRP 672¹)



Figure 8.2 – Typical Snow Removal Activity around a Roundabout (Source: NCHRP 672¹)

8.3 Pavement Maintenance and Rehabilitation

Pavement maintenance may be routine (in the case of pothole patching or pavement marking) or periodic (in the case of pavement resurfacing). In either case, maintaining traffic flow with minimal disturbance is encouraged. As with all maintenance activities, this should be performed during off-peak hours. A traffic control plan should be developed to control traffic movement within the work zone. A simple flagging operation plan may be implemented to coordinate traffic movement. Examples of roundabout flagging operation plans involving lane closures for a resurfacing project are shown in

[Figure 8.3](#), [Figure 8.4](#) and [Figure 8.5](#) for single-lane lane closure, multilane inside lane closure, and multilane outside lane closure, respectively².

A detour may be considered an alternative to flagging operation where it is necessary to carry out maintenance under heavy traffic conditions. The detour plan should be posted on the agency website and published in the print media or any other media outlet for the purpose of educating the general public prior to the commencement of the maintenance activity (see [Section 2.1.6](#) of Chapter 2).

Special attention should be given to large truck operations when maintenance and rehabilitation activities are planned on routes with high levels of commercial vehicle traffic. Trucks should be accommodated in all traffic control and detour plans. In particular, large trucks may need wider paths during activities to allow for safe and efficient left turn maneuvers.

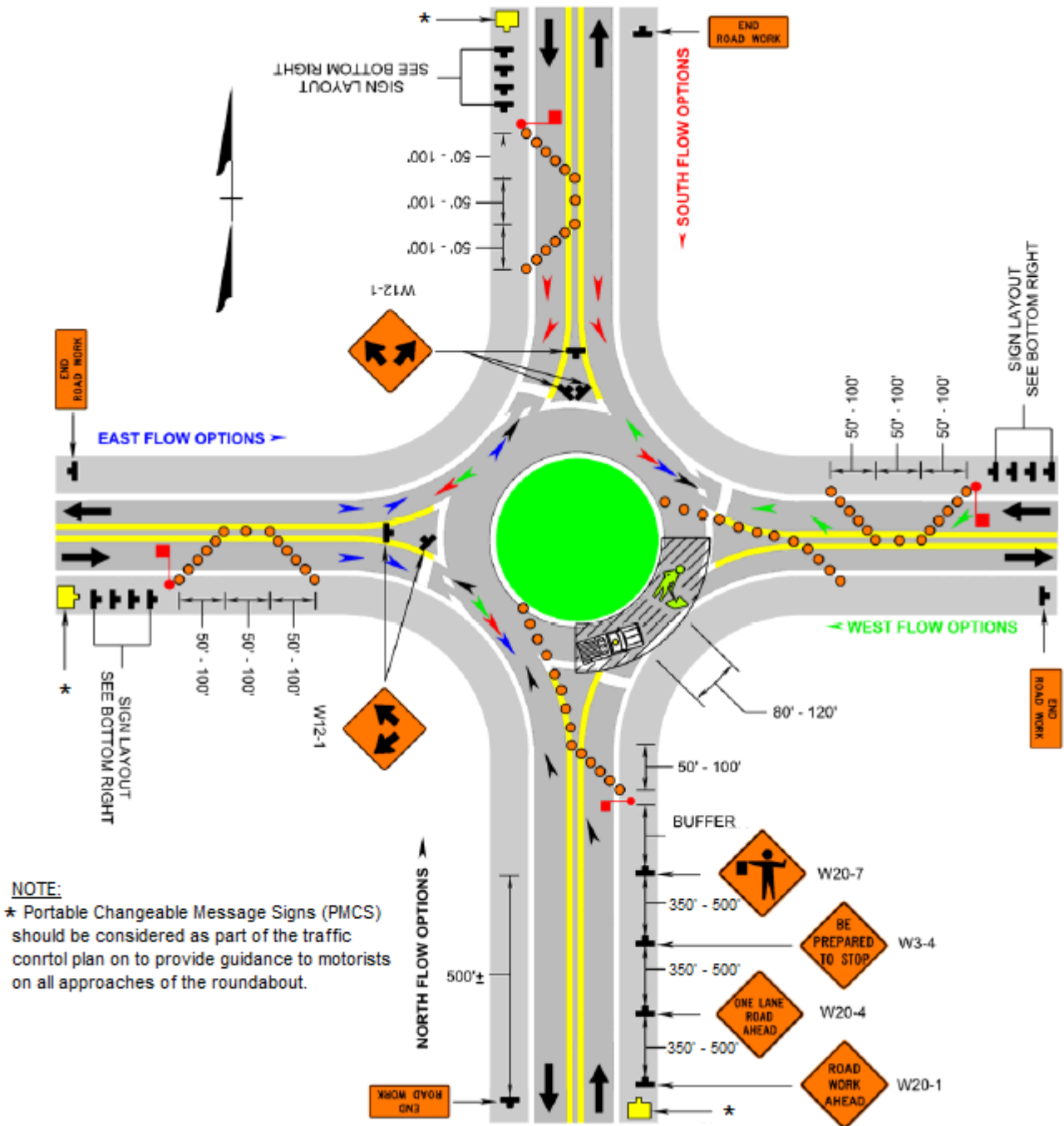

Figure 8.3 – Typical Single-Lane Roundabout Flagging Operation (Source: VDOT³)

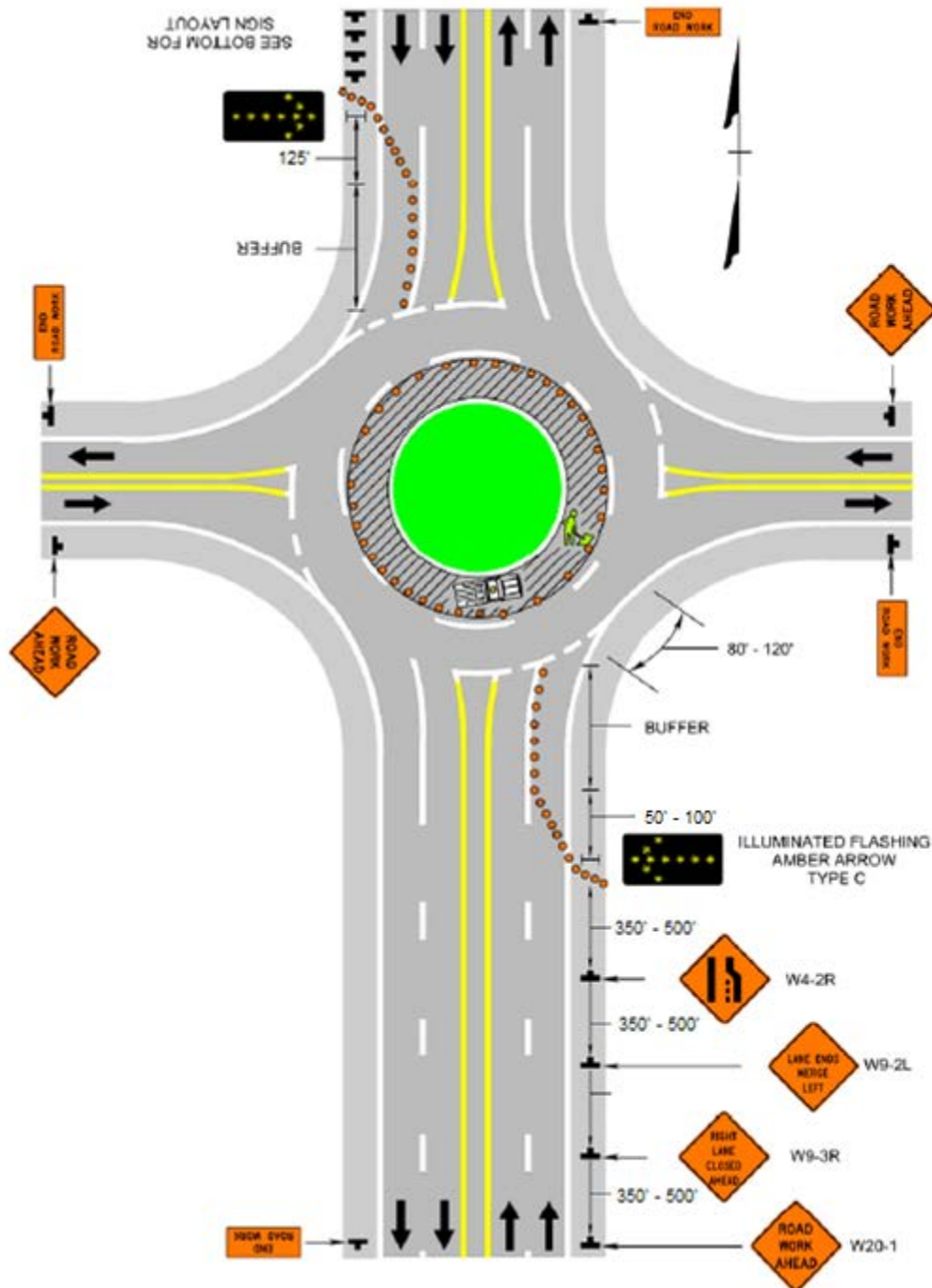

Figure 8.4 – Typical Multi-Lane Roundabout Inside Lane Closure Operation (Source: VDOT³)

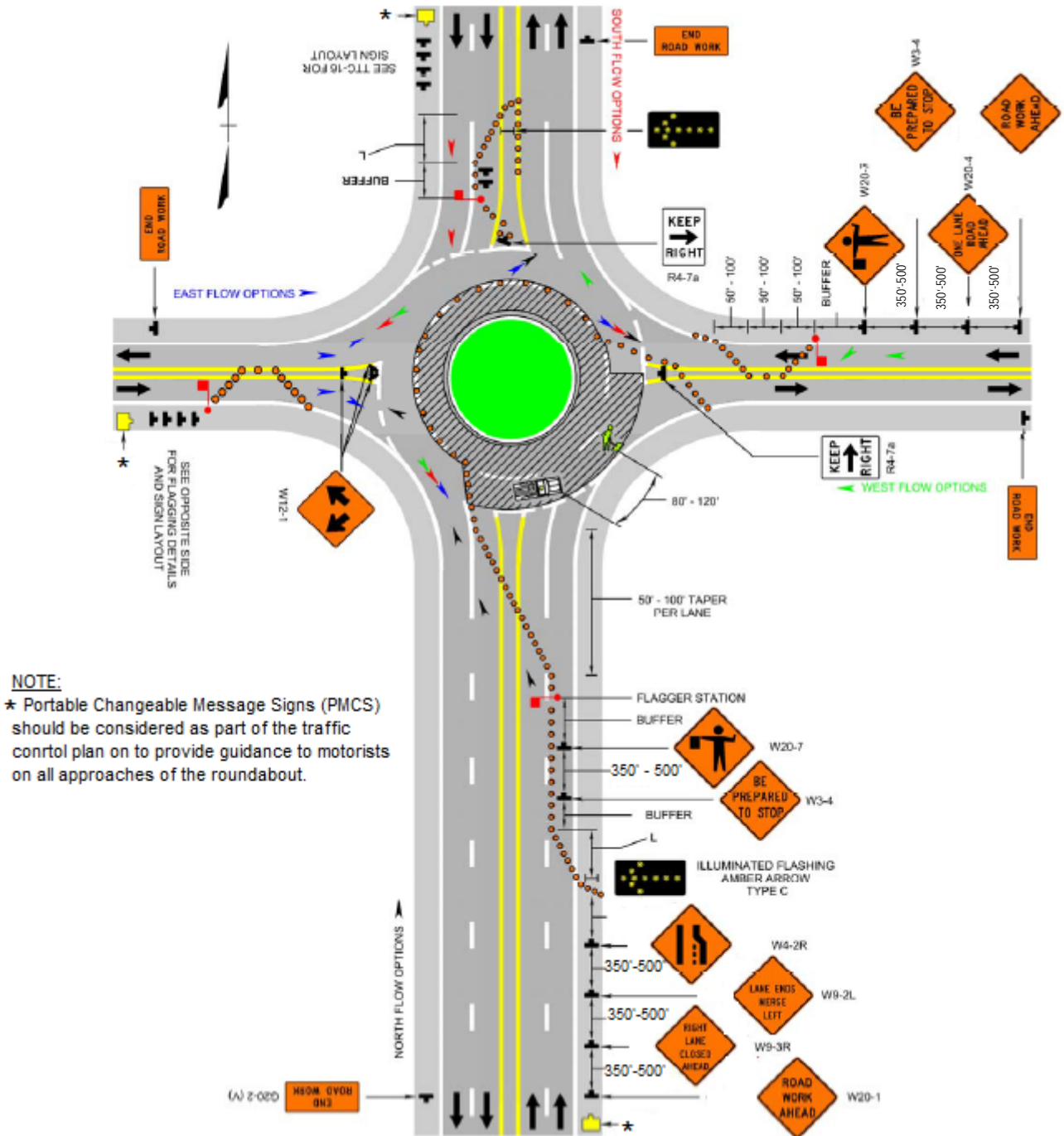

Figure 8.5 – Typical Multi-Lane Roundabout Outside Lane Closure Operation (Source: VDOT³)

8.4 References

1. Rodegerdts, L., J. Bansen, C. Tiesler, J. Knudsen, E. Myers, M. Johnson, M. Moule, B. Persaud, C. Lyon, S. Hallmark, H. Isebrands, R. B. Crown, B. Guichet and AO. *NCHRP Report 672: Roundabouts: An Informational Guide*. 2nd ed. (Transportation Research Board of the National Academies, ed.). Washington D.C; 2010. Available at: http://onlinepubs.trb.org/onlinepubs/nchrp/nchrp_rpt_672.pdf.
2. Federal Highway Administration (FHWA). *Manual on Uniform Traffic Control Devices (MUTCD)*. 2009th ed. (FHWA, ed.). Washington D.C; 2012. Available at: http://mutcd.fhwa.dot.gov/pdfs/2009/pdf_index.htm.
3. Virginia Department of Transportation. *Virginia Work Area Protection Manual (WAPM): Standards and Guidelines for Temporary Traffic Control*. 2011th ed. Richmond; 2011. Available at: <http://www.virginiadot.org/business/trafficeng-WZS.asp>.

Appendix

Design Techniques

APPENDIX 1: Design Geometric Parameters

TABLE A1.1 Initial Ranges of Design Elements

| Design element | Single-Lane | Multilane (2 lanes) |
|--------------------------------|-------------|---------------------|
| Inscribed circle diameter (ft) | 90-180 | 165-220 |
| Circulatory roadway width (ft) | 18-24 | 14-18 per lane |
| Entry width (ft) | 14 -18 | 24-34 both lanes |
| Entry radii (ft) | 65-110 | 65-150 |
| Exit radii (ft) | 300-800 | 300-800 |
| Truck apron width (ft) | 12-20 | 12-20 |

Note:

1. Exit width – Based on design vehicle
2. Circulatory roadway width – Based on bus tracking
3. Truck apron width – Based on design vehicle tracking
4. The minimum inscribed diameter to accommodate a WB-67 should be greater than 110 feet

APPENDIX 2: Offset Alignment Preference

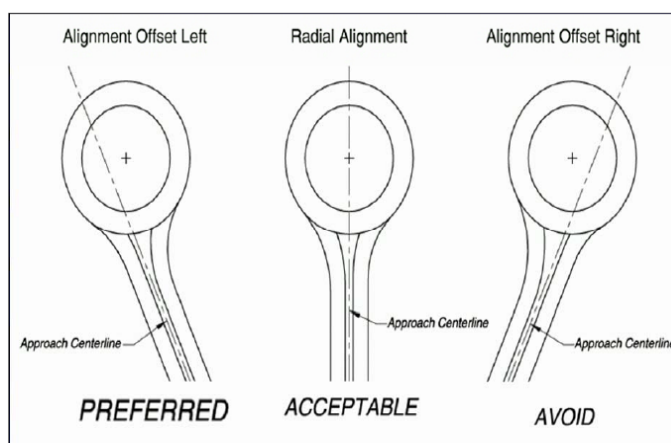

Figure A2.1 – Offset Alignment Preference

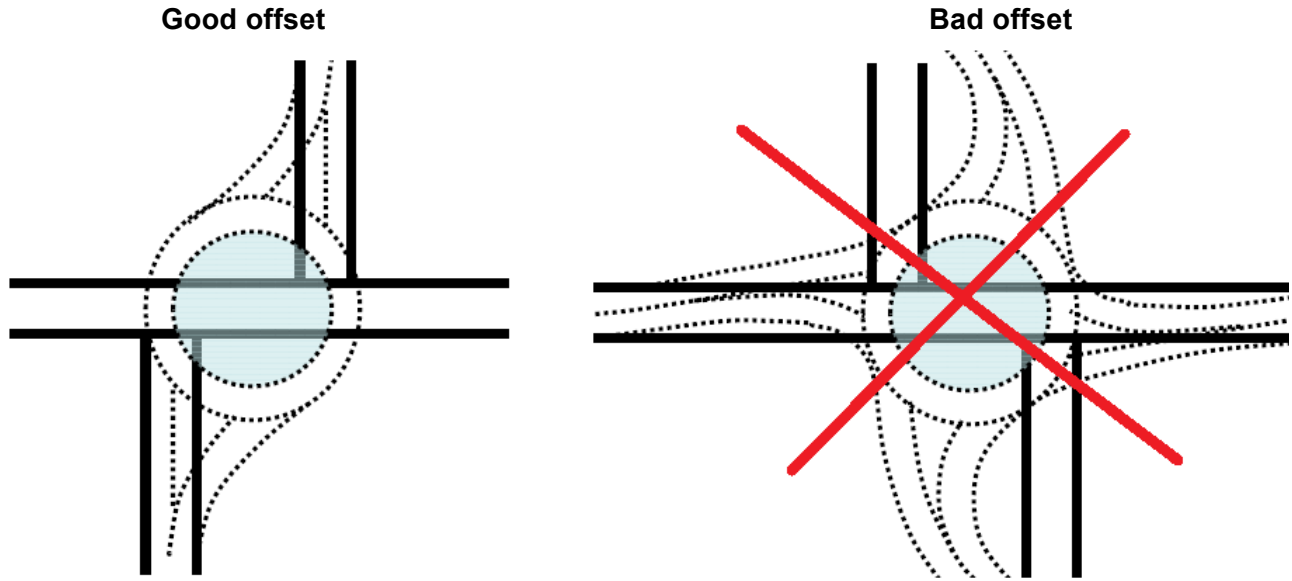

Figure A2.2 – Offset Alignment Preference at Staggered Intersection

APPENDIX 3: Single-lane Design Steps

- a. Place 150' (or your selected inscribed circle diameter) diameter circle at center of existing intersection as shown in [Figure A3.2](#). All work being done at this point is with paint lines – curb lines are just offsets from the paint lines

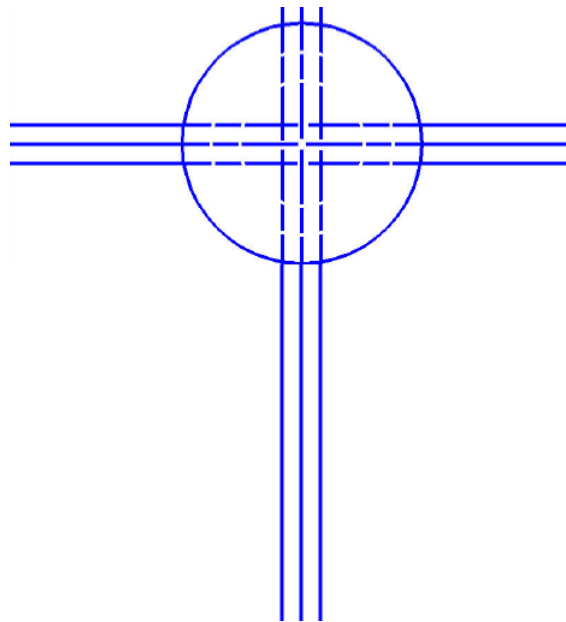

Figure A3.1 – Placement of 150' Inscribed Circle Diameter

- b. Copy 150' diameter circle parallel around 18' or so twice – once for the travel lane and another time for the truck apron as shown in [Figure A3.2](#). NOTE: later you will need to check with AutoTurn, AutoTrack or similar program

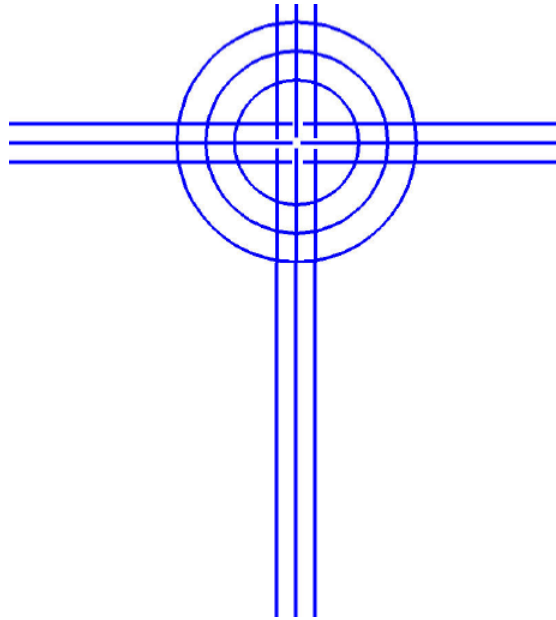

Figure A3.2 – Travel Lane and Truck Apron Offsets

- c. Hatch out the truck apron so it is clear what that area is going to be used for as shown in [Figure A3.3](#)

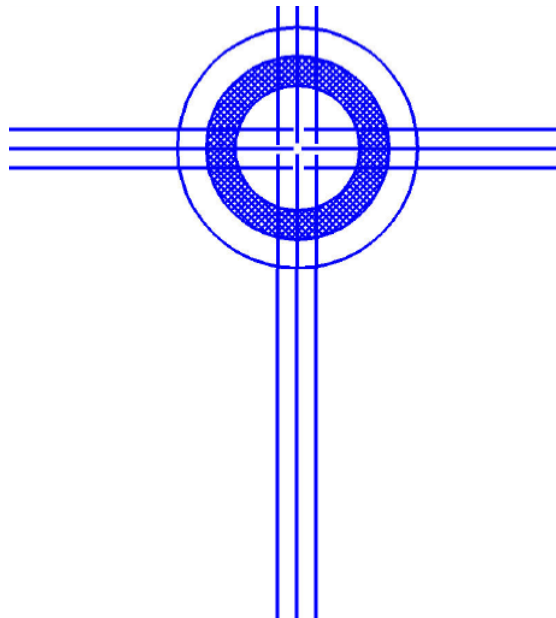

Figure A3.3 – Truck Apron Construction

- d. Use a 300' to 800' fillet to tie the center line to the exit side of the truck apron and the left edge line to the outside of the roundabout as shown in [Figure A3.4](#). Use the same radius to let CAD worry about the taper

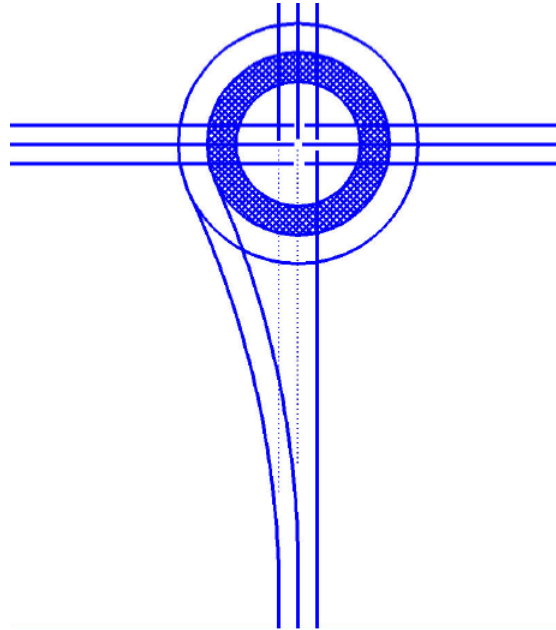

Figure A3.4 – Exit Lane Construction

- e. Copy the new center line over 12' for your new right edge line as shown in [Figure A3.5](#)

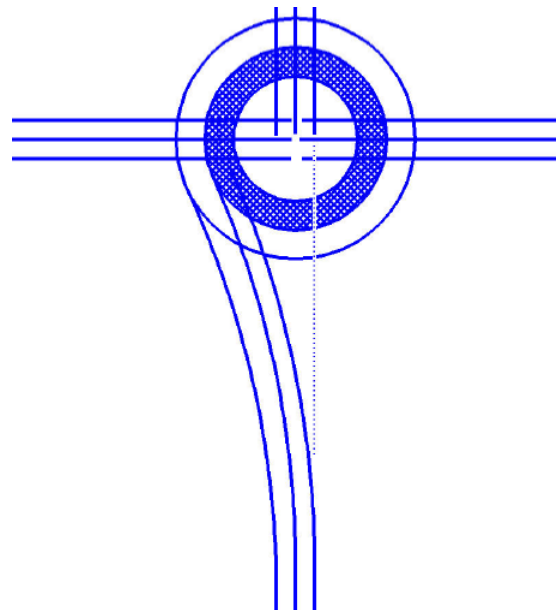

Figure A3.5 – Approach Lane Construction

- f. Use a 90' to 110' fillet to tie in the approach. Use the same radius on both sides – let CAD take care of the taper as shown in [Figure A3.6](#)

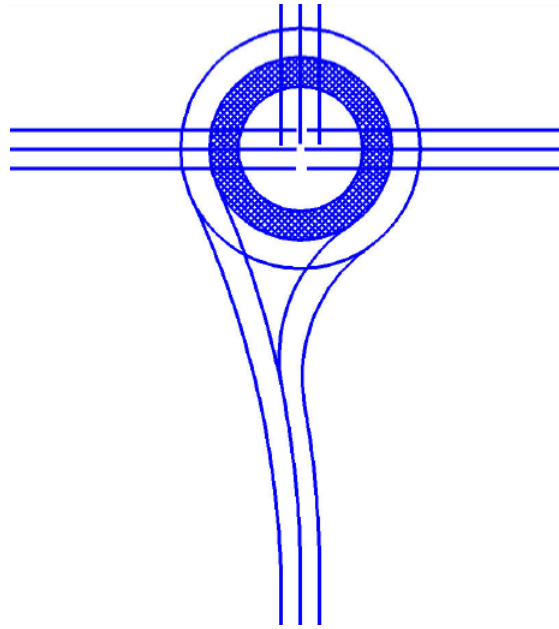

Figure A3.6 – Exit and Entry Lane on One Leg Completed

- g. One leg is done – you now have an approach with geometry that requires vehicles to slow down before the yield line. This technique has 2 points of speed reduction – you have staged and staggered the speed reduction

APPENDIX 4: Multilane (2- lane) Design Steps

- a. Place 200' diameter circle at center of existing intersection. Offset the circle parallel around 18' or so thrice – two for the travel lanes and the third for the truck apron. Note that later you will need to check with AutoTurn, AutoTrack or similar. Hatch out the truck apron and use a 300' to 800' fillet to tie the left edge line of inner exit lane to the side of the truck apron, the center line of the exit lanes to the center line of the circulatory roadway lanes and the right edge line of the outer exit lane to the outside of the roundabout – use the same radius to let CAD worry about the taper(see [Figure A4.1](#))

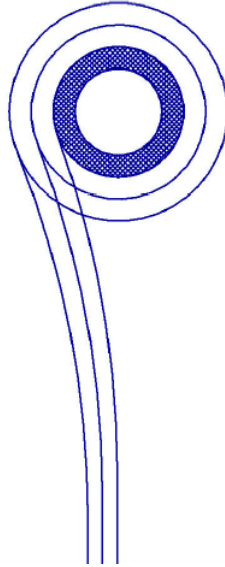

Figure A4.1 – Truck Apron and Multilane Exit Construction

- a. Offset the left edge line of the inner exit lane for approach lanes. Do not worry about splitter at this stage. Construct a tangent line to the center of the circulatory roadway, noting a suitable angle that gives good deflection (see [Figure A4.2](#)).

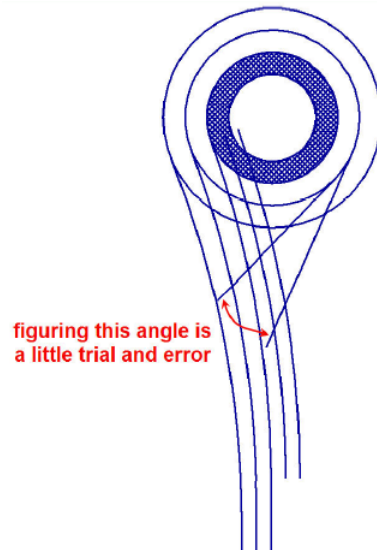

Figure A4.2 – Multilane Entry Construction

- b. Use 100' to fillet between the center of approach lanes and the straight tangent line (see [Figure A4.3](#))

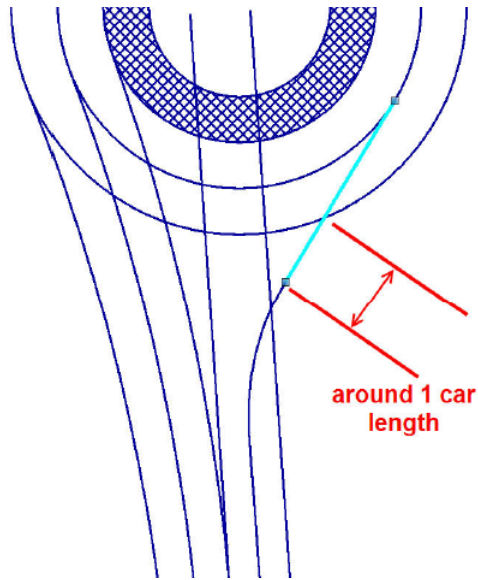

Figure A4.3 – Good Entry Deflection to Avoid Path Overlap

- c. Offset the newly formed center line of the approach lane to the desired widths (see [Figure A4.4](#))

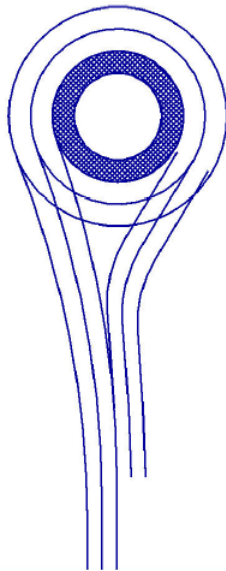

Figure A4.4 – Exit and Entry Lane on One Leg Completed

- d. One leg is done – Splitter island is then added with the appropriate offsets