

# Rubber Bumpers / Cellular Bumpers

Program 0170 / 0180



**CONDUCTIX**  
wampfler

Load diagrams for our bumpers (KAT0170-0003-US and KAT0180-0001-US) can be downloaded from: [www.conductix.us](http://www.conductix.us)

**Availability:** Part Numbers marked with + are normally stocked in the USA for quick delivery. Part numbers marked with \* are part of our standard range and are available from stock in Weil am Rhein, Germany. Delivery times for other part numbers can be provided by request.

# Table of Contents

---

<b>Rubber Bumpers / Cellular Bumpers – General Information</b>	4
Rubber Bumpers and Cellular Bumpers at a glance.....	4
Project Planning.....	6
Possible Bumper Arrangements .....	6
Bumper Loads .....	6
Basic Formulas for Calculating.....	7
<hr/>	
<b>Rubber Bumpers</b>	9
General .....	9
How to Order .....	9
Application Examples .....	9
Conductix-Wampfler Standard Rubber Quality .....	10
Quality Grades of Common Materials.....	10
Dimension Tables.....	11
<hr/>	
<b>Rubber-Metal Elements</b>	17
General .....	17
Application Examples .....	17
How to Order .....	17
Conductix-Wampfler Standard Rubber Quality .....	18
Quality Grades of Common Materials.....	18
Dimension Tables.....	19
<hr/>	
<b>Cellular Bumpers</b>	25
General .....	25
Application Examples .....	25
Conductix-Wampfler Standard Cellular Bumper Quality .....	25
Fall Protection.....	25
Quality Grades .....	25
Dimension Tables.....	26
<hr/>	
<b>Rubber Bumpers / Cellular Bumpers FAQs</b>	28

---

# Rubber Bumpers / Cellular Bumpers Program 0170 / 0180

---

## General Information

---

Stop bumpers are essentially damping units that absorb energy, for example at the end of a crane runway, to prevent damage and allow for smaller structural dimensions. In general, "energy before geometry" applies to bumpers because load diagrams, precisely defined characteristic curves, physical dimensions, and mathematical formulae are used when dimensioning the bumpers. Geometrical dimensions are of secondary importance here. Stop bumpers are not to be used as vibration dampers or supports.

**Safety, quality, and know-how are our main focus!**



Modern production methods, constantly increasing working speeds, and increasing demands for ergonomic working environment, make greater demands on existing bumper systems. Due to the wide variety of available bumper designs, we can offer a solution for every application. We have a large standard range of rubber bumpers and cellular bumpers to provide for individual solutions. Special designs are always possible by request.

### Applications:

- Travel limitation
- Energy absorption
- End stops
- End position dampening

### Rubber Bumpers: Program 0170

Since rubber bumpers are made from cost-effective, basic materials, our program offers an economic solution for most technical requirements. The energy absorption of a rubber bumper is limited due to the compression limits of the material.

### Rubber-Metal Elements: Program 0170

Rubber-metal elements are used to support dynamic loads and isolate them from vibration. As a rule, the rubber-metal elements in this catalog are calculated based on construction attributes, as opposed to energy absorption or vibrational characteristics, given their usual application as a support member and isolation element.

### Cellular Bumpers: Program 0180

Due to their excellent energy absorption properties the cellular bumper program is a suitable complement to the rubber bumper program. Their volume compressibility allows long compression lengths and very good deceleration values.

---

## Rubber Bumpers and Cellular Bumpers at a glance

---



- Highest dynamic and mechanical capacity
- Versatile resilience against demanding environmental conditions
- Compression travel up to 50% bumper height



- High energy absorption abilities make cellular bumpers a maintenance-free and inexpensive alternative to complex bumper systems.
- Low delay values and very good damping qualities
- Lightweight design
- Compression travel up to 80% bumper height

# Rubber Bumpers / Cellular Bumpers Program 0170 / 0180

## Fall Protection

Accidental falling of the stop bumpers is prevented by safeguard measures – so-called "fall protection" – which provides comprehensive safety for man and machine. Cellular bumpers with integrated safety rope and form-fitting, foam-covered cap are used for installation heights > 3 m. Fall protection is a standard feature for all cellular bumpers. The reliable vulcanization process, permanently joining the fastening element to the rubber bumper body, adds to the overall safety of the bumpers. We take special care when choosing the raw material for our bumpers, using only the best quality materials. This results in homogenous base compounds, very high durability, and consistently excellent energy absorption of the bumpers. Years of experience and continued development by the inventor of stop bumpers, Manfred Wampfler, still form the knowledge base of bumper manufacturing to this day.

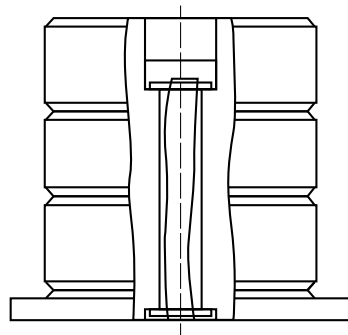

Integrated safety rope  
(250 mm bumper diameter or higher)

## Placement

Mounting surfaces and counter-pressure surfaces must be level and parallel with the bumper. This avoids lateral forces and ensures a concentric, linear application of force and impact over the whole reception area of the bumpers.

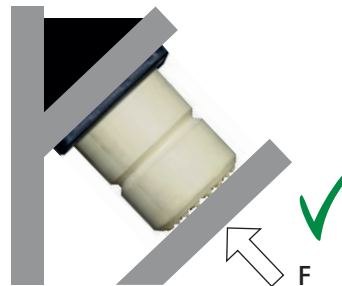
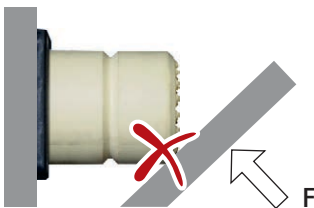
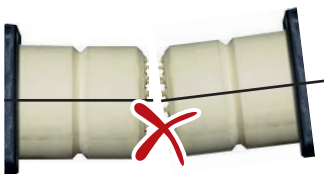

Vertical eccentricity of oppositely mounted bumpers must not be higher than 10% of the bumper's diameter:

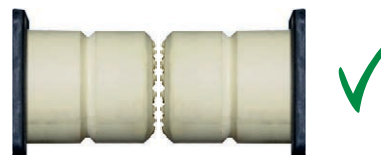
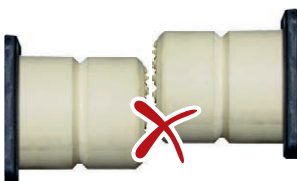

# Rubber Bumpers / Cellular Bumpers Program 0170 / 0180

## Project Planning

- Determine the effective mass and impact velocity.
- Calculate the basic energy formula:  $W = \frac{1}{2} m \times v^2$ .
- Determine the energy distribution for each single bumper.
- Select the needed bumper (cellular or rubber material), depending on general requirements.
- Select the bumper geometry according to maximum bumper energy  $W_{max}$  from the tables on pages 11, 26, and 27 depending on bumper type.
- Calculate the expected compression length (from load diagrams – see catalog "Bumper Load Diagrams - Rubber (KAT0170-0003-US) or "Bumper Load Diagrams - Cellular (KAT0180-0001-US" on [www.conductix.us](http://www.conductix.us)
- Calculate the resulting reacting force
- Check the resulting deceleration

## Possible Bumper Arrangements

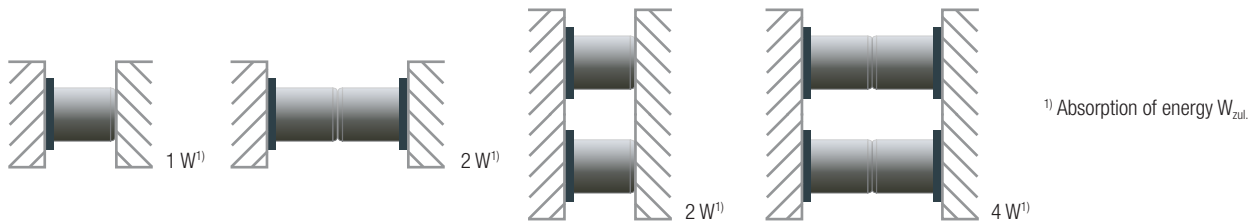

## Bumper Loads

The load on the bumper has to be central and perpendicular to the bumper base plate. Do not weld the bumper base plate to the host surface. Use mounting screws according to DIN 6912 or DIN 7984.

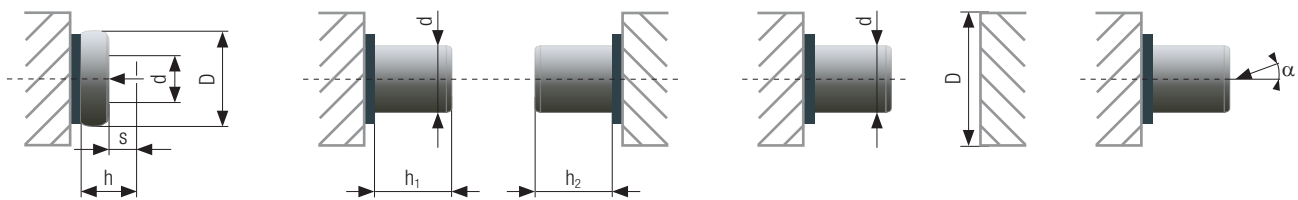

Diameter expansion with maximum load:

- Rubber bumper:  
 $s = 0.5 h \hat{=} D = 1.4 d$
- Cellular bumper:  
 $s = 0.5 h \hat{=} D = 1.25 d$   
 $s = 0.8 h \hat{=} D = 1.4 d$

Bumper against bumper arrangement (cellular bumpers):

- Permissible:  
 $h_1 + h_2 \leq 2 d$
- Not permissible:  
 $h_1 + h_2 > 2 d$

Because of variations in guiding and impact accuracy, the impact surface must be at least 25% greater than the bumper diameter:  $D > 1.25 d$   
 $D$  = impact surface  
 $d$  = bumper diameter

Impact direction:  
 $\alpha_{max} = \pm 4^\circ$

The bumper characteristics are shown by the load-length curves. With rubber bumpers the shape of the curves mainly depends on the shape and the shore hardness.

With cellular bumpers, volumetric density is the decisive factor for their physical behavior. Due to the spring characteristic curve of rubber and cellular bumpers (load  $F$  depending on the compression length  $s$ ) the bumper final pressures, which are required for the specification of the neighboring components, can only be determined with static tests.

- $A1$  = energy loss (hysteresis)
- $A2$  = restoring energy
- $A1 + A2$  = energy absorbed by the bumper

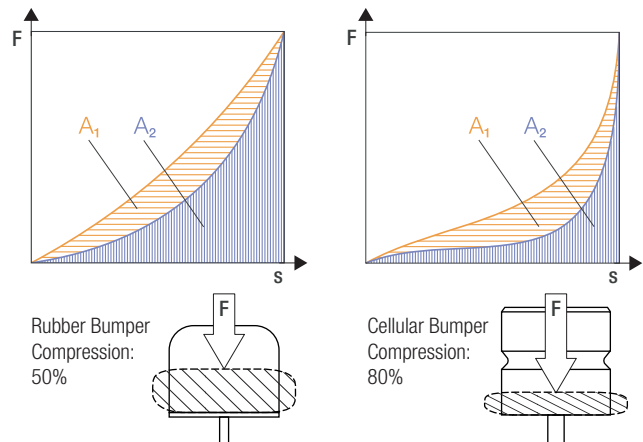

# Rubber Bumpers / Cellular Bumpers

## Program 0170 / 0180

### Basic Calculation Formulas

- Mass against limit stop

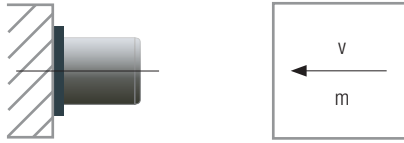

$$W = \frac{1}{2}m \cdot v^2$$

- Mass against mass

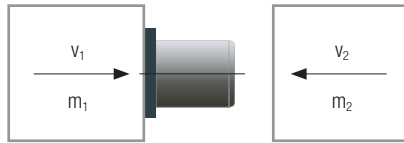

$$W = \frac{m_1 \cdot m_2 (v_1 + v_2)^2}{2(m_1 + m_2)}$$

$$m_1 = m_2 \text{ and } v_1 = v_2$$

$$W = m \cdot v^2$$

- Driven mass against limit stop



$$W = \frac{1}{2}m \cdot v^2$$

$$W_2 = F_0 \cdot f'$$

Bumper force-travel diagram

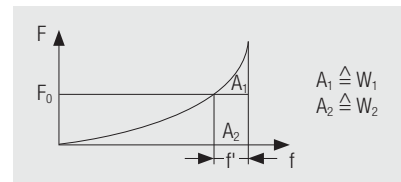

- Free fall (this formula does not apply for elevators)

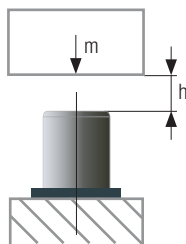

$$W = m \cdot g \cdot h$$

- Calculation of bumpers for cranes

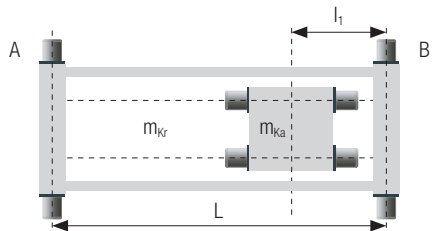

$$W_B = \frac{1}{2}m_B \cdot v^2$$

$$m_B = \frac{m_{kr}}{2} + \frac{m_{ka}(L-l_1)}{L}$$

- Oscillating masses need not be taken into account
- Centrifugal moment of rotating parts must be taken into account
- Velocity must be reduced according to DIN 15018:  
 $v = 100\%$  rated velocity on trolleys  
 $v = 85\%$  rated velocity on cranes  
 $v = 70\%$  rated velocity on cranes with brakes

- Formulas for calculating the deceleration

$$a_{mitt} = \frac{v^2}{2f}$$

$$a_{max} = \frac{F}{m}$$

$a_{mitt}$ : Median deceleration (m/s<sup>2</sup>)

$a_{max}$ : Maximum deceleration (m/s<sup>2</sup>)

$F_0$ : Driving force (kN)

$F$ : Maximum bumper force (kN)

$f$ : Compression length (mm)

$f'$ : Acting compression (mm)

$g$ : Gravity acceleration (9.81 m/s<sup>2</sup>)

$h$ : Drop height (m)

$L$ : Rail spacing (m)

$l$ : Distance  $m_{ka}$  to B (m)

$m$ : Mass (kg)

$m_{kr}$ : Mass crane without trolley (kg)

$m_{ka}$ : Mass of trolley (kg)

$m_1/m_2$ : Mass body 1 / body 2 (kg)

$m_B$ : Mass on rail B (kg)

$v$ : Velocity (m/s)

$v_{1/2}$ : Velocity body 1 / body 2 (m/s)

$w$ : Kinetic energy (kJm)

$w_1$ : Kinetic energy (kJm)

$w_2$ : Work acting through  $F_0$  (kJm)

$w_{zul}$ : Max. energy absorption (kJm)





# Rubber Bumpers Program 0170

---

## General Information

---

Natural caoutchouc rubbers are characterized by their very high elasticity, notch impact resistance, and good abrasion resistance. Among all elastomers, these have the highest mechanical and dynamic load capacities. Natural caoutchouc is not resistant to electrolytic liquids, aliphatic, aromatic hydrocarbons, or chlorinated hydrocarbons.

Oil and natural gas are the basic materials for synthetic caoutchouc. For many years, this has been a substitute material for natural caoutchouc, but today synthetic caoutchouc is increasingly used as first choice for many applications. Today there are a wide range of synthetic caoutchoucs, whose properties allow a variety of applications thereby establishing the use of rubber technology within modern methods. Rubber is not merely a chemical substance, but a compound of many different materials. The varied mechanical and anti-corrosive properties can only be achieved by a recipe of several hundred substances. Caoutchouc, as a macro-molecular material, provides the elastic components of the rubber. The mechanical properties, such as breaking elongation, resilience elasticity, strength, and continuous breaking strength are dependent on it. The addition of chemicals and other additives and the subsequent vulcanization process make the material useful. The multitude of additive combinations as well as the many physical forms means that for most problems there is a solution.

Rubber bumpers are molded to the metal base plates. In rubber bumpers with threaded bolts, the bolts are inserted twist-proof. Visible areas are primed or galvanized, respectively.

---

## Example Part Number

---

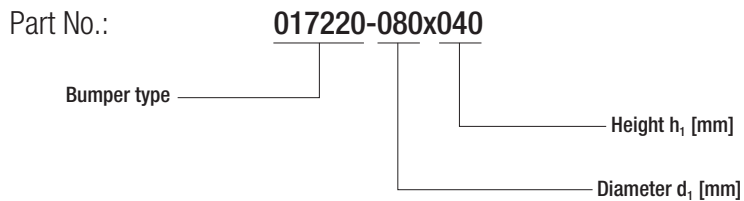

---

## Application Examples

---

- Crane systems
- Transfer cars
- Smelter and rolling mill machines
- Handling technology
- Plant construction and engineering
- Conveyor, transport, and gate systems, etc.

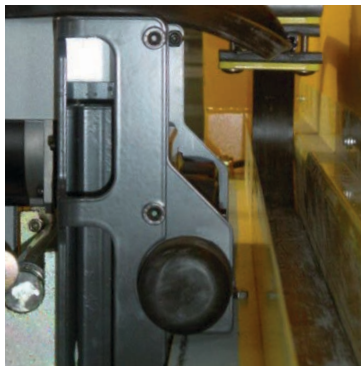
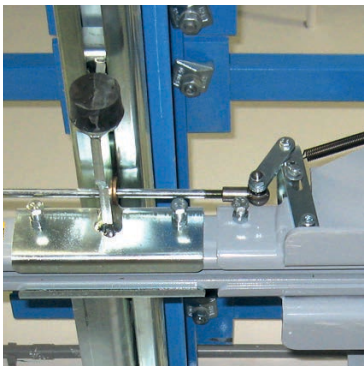

# Rubber Bumpers Program 0170

## Conductix-Wampfler Standard Rubber Quality

### N-Quality

- Resilient and tear-resistant
- Aging resistant
- Material incompressible
- Operating temperature: -30 to +70°C \*
- Hardness: 70 Shore A +/-5

### S-Quality (by request only)

- Seawater and ozone-resistant, weather-proof, oil, and to a large extent, acid and aging resistant
- Operating temperature: -30 to +80°C
- Hardness: 70 Shore A +/-5

Special qualities and special constructions by request!

\* Characteristics may change depending on ambient temperature

## Quality Degrees of the Most Common Materials

Conductix-Wampfler Qualities	N		S		Special Qualities <sup>1)</sup>	
	NR Natural caoutchouc	CR Chloroprene caoutchouc	SBR Styrene-Butadiene caoutchouc	EPDM Ethylene-Propylene Terpolymere	NBR Nitrile-Butadien caoutchouc	VMQ Silicone caoutchouc
International abbreviated designation						
Abrasion resistance	++	++	++	+	++	--
Breaking elongation	+++	++	++	+	++	○
Tear resistance	++	++	+	+	+	---
Rebound resistance	++	+	+	+	+	+
Tensile strength not reinforced	+++	+	--	--	--	---
Tensile strength reinforced	+++	++	++	+	++	○
Temperature resistance, hot air	+90 °C	+120 °C	+100 °C	+150 °C	+130 °C	+200 °C
Temperature resistance, coldness	-50 °C	-30 °C	-40 °C	-40 °C	-40 °C	-80 °C
Alkali resistance	+	++	+	++	+	--
Aging resistance	+	++	+	+++	+	+++
Gasoline resistance	---	++	○	--	+++	--
Electrical insulation resistance	+++	+	++	++	4	+++
Oil and grease resistance	---	++	--	○	+++	+++
Ozone resistance	○	++	○	+++	+	+++
Acid resistance	+	++	+	+++	○	--
Hot water	+	+	++	++	+	--

Quality degrees of the individual material properties (depending on interactions and exposure time):

- +++ Very good
- ++ Good
- + Satisfactory
- Sufficient
- Deficient
- =Insufficient

Tolerances of the rubber parts according to ISO 3302-1M

<sup>1)</sup> Special qualities available only in large order quantities – please contact us!

# Rubber Bumpers Program 0170

## With Steel Base Plate

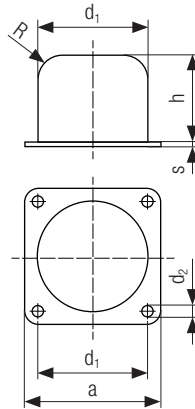

Part No.	$W_{max}$ [J]	F [kN]	Weight [kg]	$d_1$ [mm]	h [mm]	a [mm]	$d_2$ [mm]	R [mm]	s [mm]	PU <sup>1)</sup> [Qty.]
017110-040x032N <sup>2)</sup> * +	57.5	9	0.09	40	35	50	5.5	–	2	1
017110-050x040N <sup>2)</sup> * +	90	13	0.17	50	43	63	6.5	–	2	1
017110-063x050N <sup>2)</sup> * +	200	25	0.36	63	54	80	6.5	–	3	1
017111-080N*	400	40	0.88	80	63	100	11	16	6	1
017111-100N* +	800	63	1.82	100	80	125	13	20	6	1
017111-125N* +	1600	100	3.25	125	100	160	17	25	6	1
017111-160N* +	3200	160	6.50	160	125	200	17	32	8	1
017111-200N* +	6300	250	11.30	200	160	250	21	40	8	1
017111-250N* +	12500	400	22.60	250	200	315	21	50	10	1
017111-315N*	25000	630	41.20	315	250	400	21	63	10	1

\* Standard range + Usually stocked in the USA

1) = Packing Unit = Minimum Order Quantity

2) = Conical form, see drawing on page 13

## With Threaded Bolt

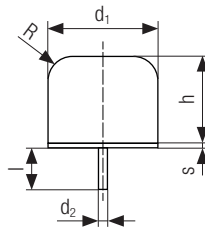

Part No.	$W_{max}$ [J]	F [kN]	Weight [kg]	$d_1$ [mm]	h [mm]	l [mm]	$d_2$ [mm]	R [mm]	s [mm]	PU <sup>1)</sup> [Qty.]
017120-080N* +	400	40	0.6	80	63	37	M12	16	3	1
017120-100N* +	800	63	1.1	100	80	36	M12	20	4	1
017120-125N* +	1600	100	2.1	125	100	46	M16	25	4	1
017120-160N* +	3200	160	4.4	160	125	44	M16	32	6	1
017120-200N* +	6300	250	8.4	200	160	49	M20	40	6	1
017120-250N*	12500	400	16.3	250	200	47	M20	50	8	1

\* Standard range + Usually stocked in the USA

1) = Packing Unit = Minimum Order Quantity

# Rubber Bumpers Program 0170

With Two Threaded Bolts

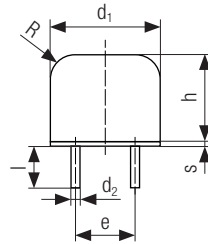

Part No.	$W_{max}$ [J]	F [kN]	Weight [kg]	$d_1$ [mm]	h [mm]	$d_2$ [mm]	e [mm]	l [mm]	R [mm]	s [mm]	PU <sup>1)</sup> [Qty.]
017121-100N +	800	63	1.2	100	80	M12	50	36	20	4	1
017121-125N	1600	100	2.2	125	100	M16	63	46	25	4	1

Other dimensions available by request. + Usually stocked in the USA

1) = Packing Unit = Minimum Order Quantity

## Wheel Bumpers with Mounting Holes or Threaded Bolts



017131-060x150

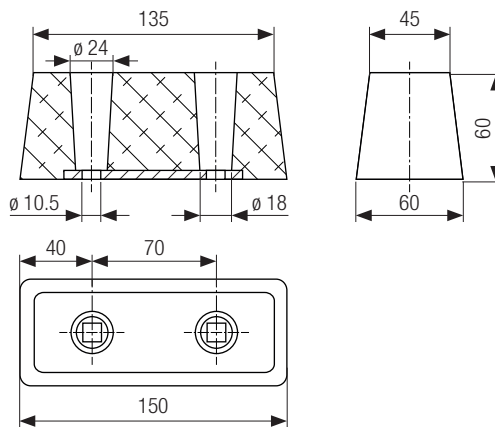

017132-060x150

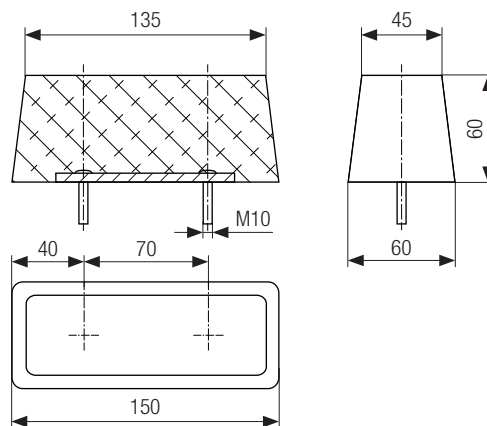

Part No.	$W_{max}$ [J]	F [kN]	Weight [kg]	PU <sup>1)</sup> [Qty.]
017131-060x150 +	550	50	0.65	10
017132-060x150	1000	100	0.77	10

1) = Packing Unit = Minimum Order Quantity + Usually stocked in the USA

# Rubber Bumpers Program 0170

## Conical Bumpers with Threaded Bolt

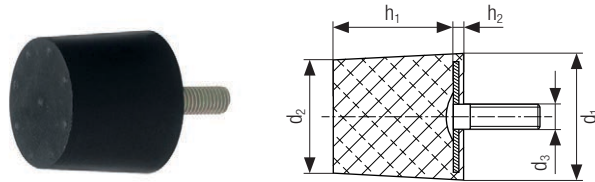

Part No.	W <sub>max</sub> [J]	F [kN]	Weight [kg]	d <sub>1</sub> [mm]	d <sub>2</sub> [mm]	d <sub>3</sub> [mm]	h <sub>1</sub> [mm]	h <sub>2</sub> [mm]	l [mm]	PU <sup>1)</sup> [Qty.]
017220-016x006,3	1.2	0.9	0.008	16	15.5	M5	6.3	0.5	20	1
017220-016x008	1.5	0.9	0.009		15.0		8			125
017220-016x010* +	1.8	0.9	0.010		15.0		10			1
017220-016x012,5	2.2	0.9	0.011		14.5		12.5			125
017220-016x016*	2.8	0.9	0.012		14.0		16			1
017220-020x008	2.5	1.8	0.013	20	19.5	M6	8	0.6	25	1
017220-020x010	3.0	1.65	0.016		19.0		10			100
017220-020x012,5	3.8	1.5	0.019		18.5		12.5			1
017220-020x016 +	4.8	1.4	0.021		18.0		16			100
017220-020x020	6.0	1.35	0.023		17.5		20			1
017220-025x010	7.0	4.6	0.025	25	24.0	M6	10	0.6	25	1
017220-025x012,5	8.0	4.0	0.027		23.5		12.5			100
017220-025x016* +	10.0	3.5	0.029		23.0		16			1
017220-025x020 +	12.0	3.2	0.031		22.5		20			100
017220-025x025* +	15.0	3.0	0.034		22.0		25			1
017220-032x012,5	22.5	12.5	0.046	32	31.5	M8	12.5	2.3	28	100
017220-032x016	23.0	8.8	0.049		30.0		16			100
017220-032x020* +	24.0	7.0	0.053		29.5		20			1
017220-032x025	25.5	5.8	0.057		29.0		25			100
017220-032x032*	27.5	5.0	0.064		28.5		32			1
017220-040x016	51.0	17.5	0.069	40	38.0	M8	16	2.8	28	1
017220-040x020	53.0	13.5	0.075		37.5		20			100
017220-040x025 +	55.0	11.0	0.082		37.0		25			100
017220-040x032* +	57.5	9.0	0.090		36.5		32			1
017220-040x040* +	60.0	7.5	0.100		36.0		40			1
017220-050x020	70.0	22.5	0.121	50	47.5	M10	20	3.0	32	50
017220-050x025	75.0	18.0	0.131		47.0		25			50
017220-050x032*	80.0	15.0	0.145		46.5		32			1
017220-050x040* +	90.0	13.0	0.160		46.0		40			1
017220-050x050 +	100.0	11.0	0.179		45.5		50			50
017220-063x020*	150.0	40.0	0.202	63	60.5	M10	20	4.0	31	1
017220-063x025	160.0	37.0	0.218		60.0		25			25
017220-063x032* +	170.0	32.5	0.241		59.5		32			1
017220-063x040	180.0	28.5	0.266		59.0		40			25
017220-063x050* +	200.0	25.0	0.297		57.5		50			1
017220-063x063	220.0	21.0	0.337	56.0	63	25				
017220-080x020*	255.0	85.0	0.331	80	77.5	M12	20	4.2	36	1
017220-080x025	275.0	70.0	0.358		77.0		25			25
017220-080x032	290.0	58.5	0.396		76.5		32			25

\* Standard range + Usually stocked in the USA

# Rubber Bumpers Program 0170

## Conical Bumpers with Threaded Bolt (Cont'd.)

Part No.	W <sub>max</sub> [J]	F [kN]	Weight [kg]	d <sub>1</sub> [mm]	d <sub>2</sub> [mm]	d <sub>3</sub> [mm]	h <sub>1</sub> [mm]	h <sub>2</sub> [mm]	l [mm]	PU <sup>1)</sup> [Qty.]
017220-080x040*	320.0	50.0	0.437	80	76.0	M12	40	4.2	36	1
017220-080x050	350.0	42.0	0.490		74.5		50			25
017220-080x063	390.0	34.0	0.556		73.0		63			25
017220-080x080*	450.0	27.5	0.643		71.5		80			1
017220-100x020*	370.0	150.0	0.506	100	97.5	M12	20	5.2	35	1
017220-100x025	400.0	90.0	0.549		97.0		25			10
017220-100x032	425.0	75.0	0.609		96.5		32			10
017220-100x040	470.0	65.0	0.676		96.0		40			10
017220-100x050*	510.0	57.5	0.760		94.5		50			1
017220-100x063	580.0	50.0	0.867		93.0		63			10
017220-100x080	650.0	45.0	1.007		91.5		80			10
017220-100x100*	750.0	40.0	1.168		90.0		100			1

\* Standard range

1) = Packing Unit = Minimum Order Quantity

Tolerances of the rubber parts according to ISO 3302-1M3

## Conical Bumpers with Mounting Holes

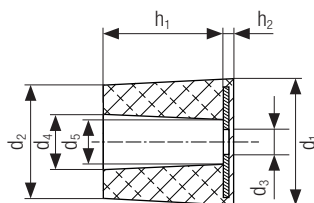

Part No.	W <sub>max</sub> [J]	F [kN]	Weight [kg]	d <sub>1</sub> [mm]	d <sub>2</sub> [mm]	d <sub>3</sub> [mm]	d <sub>4</sub> [mm]	d <sub>5</sub> [mm]	h <sub>1</sub> [mm]	h <sub>2</sub> [mm]	PU <sup>1)</sup> [Qty.]
017230-016x008	0.9	0.6	0.004	16	15.0	ø 5.3	10.0	9	8	2.0	1
017230-016x010	1.0	0.5	0.005		15.0		10.0		100		
017230-016x012,5	1.1	0.4	0.005		14.5		10.5		12.5		100
017230-016x016*	1.25	0.38	0.006		14.0		11.0		16		1
017230-020x010	1.6	1.1	0.008	20	19.0	ø 6.4	12.0	11	10	2.1	1
017230-020x012,5	1.7	0.8	0.008		18.5		12.5		12.5		100
017230-020x016	1.8	0.5	0.009		18.0		13.0		16		100
017230-020x020*	1.9	0.3	0.010		17.5		13.5		20		1
017230-025x010	5.9	4.5	0.014	25	24.0	ø 6.4	12.0	11	10	2.1	100
017230-025x012,5	6.1	3.2	0.015		23.5		12.5		12.5		100
017230-025x016	6.5	2.1	0.017		23.0		13.0		16		100
017230-025x020	7.0	1.6	0.019		22.5		13.5		20		100
017230-025x025*	7.8	1.3	0.021	22.0	14.0	25	1				
017230-032x012,5	13.0	6.5	0.023	32	31.5	ø 9.4	15.5	14	12.5	2.3	100
017230-032x016	13.5	4.4	0.025		30.0		16.0		16		100
017230-032x020	14.0	3.1	0.028		29.5		16.5		20		100
017230-032x025	14.5	2.5	0.032		29.0		17.0		25		100
017230-032x032*	15.0	2.0	0.037		28.5		17.5		32		1

\* Standard range

# Rubber Bumpers Program 0170

## Conical Bumpers with Mounting Holes (Cont'd.)

Part No.	W <sub>max</sub> [J]	F [kN]	Weight [kg]	d <sub>1</sub> [mm]	d <sub>2</sub> [mm]	d <sub>3</sub> [mm]	d <sub>4</sub> [mm]	d <sub>5</sub> [mm]	h <sub>1</sub> [mm]	h <sub>2</sub> [mm]	PU <sup>1)</sup> [Qty.]
017230-040x016	34.0	14.0	0.046	40	38.0	ø 9.4	16.0	14	16	2.8	100
017230-040x020	35.0	9.0	0.051		37.5		16.5		20		100
017230-040x025	37.0	6.5	0.057		37.0		17.0		25		100
017230-040x032	39.5	5.1	0.063		36.5		17.5		32		100
017230-040x040*	41.0	4.9	0.071		36.0		18.0		40		1
017230-050x020	55.0	18.0	0.078	50	47.5	ø 10.5	20.5	18	20	3.0	50
017230-050x025	58.0	14.0	0.086		47.0		21.0		25		50
017230-050x032	62.0	11.0	0.097		46.5		21.5		32		50
017230-050x040	67.0	8.0	0.109		46.0		22.0		40		50
017230-050x050*	72.0	7.5	0.124		45.5		22.5		50		1
017230-063x025	110.0	23.0	0.173	63	60.0	ø 10.5	21.0	18	25	4	25
017230-063x032	120.0	18.0	0.193		59.5		21.5		32		25
017230-063x040	135.0	14.0	0.215		59.0		22.0		40		25
017230-063x050	150.0	12.0	0.243		57.5		23.5		50		25
017230-063x063*	175.0	10.0	0.277		56.0		25.0		63		1
017230-080x025	230.0	57.0	0.282	80	77.0	ø 13.9	23.0	20	25	4.2	25
017230-080x032	245.0	44.0	0.317		76.5		23.5		32		25
017230-080x040	265.0	35.0	0.355		76.0		24.0		40		25
017230-080x050	285.0	29.0	0.402		74.5		25.5		50		25
017230-080x063	315.0	24.0	0.459		73.0		27.0		63		25
017230-080x080	350.0	20.0	0.536		71.5		28.5		80		1
017230-100x020	360.0	130.0	0.433	100	97.5	ø 13.9	22.5	20	20	5.2	10
017230-100x025	380.0	90.0	0.473		97.0		23.0		25		10
017230-100x032	410.0	75.0	0.430		96.5		23.5		32		10
017230-100x040	440.0	65.0	0.593		96.0		24.0		40		10
017230-100x050	470.0	55.0	0.672		94.5		25.5		50		10
017230-100x063	520.0	45.0	0.770		93.0		27.0		63		10
017230-100x080	575.0	37.0	0.900		91.5		28.5		80		10
017230-100x100*	650.0	30.0	1.045		90.0		30.0		100		1

\* Standard range

1) = Packing Unit = Minimum Order Quantity

# Rubber Bumpers Program 0170

## Conical Bumpers with Internal Thread

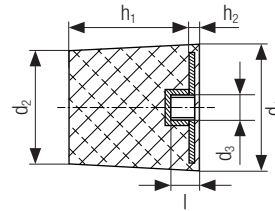

Part No.	W <sub>max</sub> [J]	F [kN]	Weight [kg]	d <sub>1</sub> [mm]	d <sub>2</sub> [mm]	d <sub>3</sub> [mm]	h <sub>1</sub> [mm]	h <sub>2</sub> [mm]	l [mm]	PU <sup>1)</sup> [Qty.]
017240-020x012,5*	3.8	1.5	0.015	20	18.5	M6	12.5	2.1	7.1	1
017240-020x016	4.8	1.4	0.016		18		16.0			100
017240-020x020*	6.0	1.35	0.018		17.5		20.0			1
017240-025x012,5	8.0	4.0	0.023	25	23.5	M6	12.5	2.1	7.1	100
017240-025x016	10.0	3.5	0.025		23.0		16.0			100
017240-025x020	12.0	3.2	0.027		22.5		20.0			100
017240-025x025*	15.0	3.0	0.030		22.0		25.0			1
017240-032x016	23.0	8.8	0.039	32	30.0	M8	16.0	2.3	9.3	100
017240-032x020	24.0	7.0	0.043		29.5		20.0			100
017240-032x025	25.5	5.8	0.048		29.0		25.0			100
017240-032x032*	27.5	5.0	0.054		28.5		32.0			1
017240-040x016*	51.0	17.5	0.060	40	38.0	M8	16.0	2.8	9.3	1
017240-040x020	53.0	13.5	0.068		37.5		20.0			100
017240-040x025	55.0	11.0	0.073		37.0		25.0			100
017240-040x032	57.5	9.0	0.081		36.5		32.0			100
017240-040x040* +	60.0	7.5	0.091		36.0		40.0			1
017240-050x020	70.0	22.5	0.104	50	47.5	M10	20.0	3.0	11.5	50
017240-050x025	75.0	18.0	0.114		47.0		25.0			50
017240-050x032	80.0	15.0	0.127		46.5		32.0			50
017240-050x040	90.0	13.0	0.142		46.0		40.0			50
017240-050x050* +	100.0	11.0	0.162		45.5		50.0			1
017240-063x020*	150.0	40.0	0.183	63	60.5	M10	20.0	4.0	11.5	1
017240-063x025	160.0	37.0	0.199		60.0		25.0			25
017240-063x032	170.0	32.5	0.222		59.5		32.0			25
017240-063x040	180.0	28.5	0.247		59.0		40.0			25
017240-063x050	200.0	25.0	0.278		57.5		50.0			25
017240-063x063*	220.0	21.0	0.317		56.0		63.0			1
017240-080x025	275.0	70.0	0.305	80	77.0	M12	25.0	4.2	13.7	25
017240-080x032	290.0	58.5	0.343		76.5		32.0			25
017240-080x040	320.0	50.0	0.385		76.0		40.0			25
017240-080x050	350.0	42.0	0.437		74.5		50.0			25
017240-080x063	390.0	34.0	0.503		73.0		63.0			25
017240-080x080*	450.0	27.5	0.590		71.5		80.0			1
017240-100x025	400.0	90.0	0.507	100	97.0	M12	25.0	5.2	13.7	10
017240-100x032	425.0	75.0	0.567		96.5		32.0			10
017240-100x040	470.0	65.0	0.634		96.0		40.0			10
017240-100x050	510.0	57.5	0.718		94.5		50.0			10
017240-100x063	580.0	50.0	0.825		93.0		63.0			10
017240-100x080	650.0	45.0	0.965		91.5		80.0			10
017240-100x100*	750.0	40.0	1.126		90.0		100.0			1



# Rubber-Metal Elements Program 0170

## General Information

Rubber-metal elements are used as flexible mechanical fastenings for vibration-free mounting of light to middle weight machinery. These elements are usually defined geometrically and by hardness and have no determined energy absorption.

The following vibrations are insulated, or dampened respectively:

1. Mechanical vibrations caused by components of the system (e.g. electric motor) and abrupt impacts.
2. Impact sound (sound waves that spread over the system parts).



## Application Examples

- Machine frames in material handling
- Frames with drive and control units  
in general engineering
- Conveyor systems
- Machine tools

## Example Part Number

Part No.: **017221-050x040/615**

Bumper type \_\_\_\_\_  
 Width  $d_1$  [mm] \_\_\_\_\_  
 Height  $h_1$  [mm] \_\_\_\_\_  
 Reference number: \_\_\_\_\_  
 screw length  $l$  / thread depth  $t$  [mm] \_\_\_\_\_  
 Reference number: \_\_\_\_\_  
 material \_\_\_\_\_  
 Reference number: \_\_\_\_\_  
 hardness shore A \_\_\_\_\_

Selection Chart: Materials

Ref. No.	Material
1	<b>NR</b> Natural caoutchouc
2	<b>CR</b> Chloroprene caoutchouc
3	<b>NBR</b> Nitrile-Butadiene caoutchouc

Selection Chart: Shore Hardness

Ref. No.	Shore A
4	40
5	55
6	60
7	70
8	80

## Types and Quality Characteristics

Vulcanization guarantees the highest cohesiveness between rubber and steel.

### Rubber-Metal Elements:

- Metal parts vulcanized to one or two sides
- Metal parts galvanized

# Rubber-Metal Elements Program 0170

## Conductix-Wampfler Standard Rubber Quality

- Natural caoutchouc, hardness 55 Shore A +/-5
- Highly elastic and tear-resistant
- Material incompressible
- Aging resistant
- Operating temperature: -30 to +70°C
- Not suitable for permanent contact with gasoline, greases, oils, and ozone

Special qualities and special constructions by request!

## Quality Degrees of the Most Common Materials

Conductix-Wampfler Qualities	N		S			
	NR Natural caoutchouc	CR Chloroprene caoutchouc	SBR Styrene-Butadiene caoutchouc	EPDM Ethylene-Propy- lene Terpolymere	NBR Nitrile-Butadien caoutchouc	VMQ Silicone caoutchouc
<b>International abbreviated designation</b>						
<b>Abrasion resistance</b>	++	++	++	+	++	--
<b>Breaking elongation</b>	+++	++	++	+	++	○
<b>Tear resistance</b>	++	++	+	+	+	---
<b>Rebound resistance</b>	++	+	+	+	+	+
<b>Tensile strength not reinforced</b>	+++	+	--	--	--	---
<b>Tensile strength reinforced</b>	+++	++	++	+	++	○
<b>Temperature resistance hot air</b>	+90 °C	+120 °C	+100 °C	+150 °C	+130 °C	+200 °C
<b>Temperature resistance coldness</b>	-50 °C	-30 °C	-40 °C	-40 °C	-40 °C	-80 °C
<b>Alkali resistance</b>	+	++	+	++	+	--
<b>Aging resistance</b>	+	++	+	+++	+	+++
<b>Gasoline resistance</b>	---	++	○	--	+++	--
<b>Electrical insulation resistance</b>	+++	+	++	++	4	+++
<b>Oil and grease resistance</b>	---	++	--	○	+++	+++
<b>Ozone resistance</b>	○	++	○	+++	+	+++
<b>Acid resistance</b>	+	++	+	+++	○	--
<b>Hot water</b>	+	+	++	++	+	--

Quality degrees of the individual materials' properties (depending on interactions and exposure time):

+++ = very good; ++ = good; + = satisfactory; ○ = sufficient; -- = deficient; --- = insufficient

Tolerances of the rubber parts according to ISO 3302-1M

<sup>1)</sup> Special qualities available only in large order quantities – please contact us!

# Rubber-Metal Elements

## Program 0170

### Cylindrical Bumpers with Two Threaded Bolts (Type A)

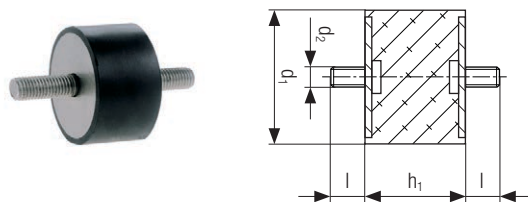

Part No.	d <sub>1</sub> [mm]	h <sub>1</sub> [mm]	d <sub>2</sub> [mm]	l [mm]	PU <sup>1)</sup> [Qty.]
017211-008x008	8	8	M3	6	300
017211-010x010	10	10	M4	10	300
017211-015x008	15	8	M4	10	300
017211-015x010	15	10	M4	10	300
017211-015x015	15	15	M4	10	300
017211-015x020	15	20	M4	13	300
017211-020x010	20	10	M6	18	300
017211-020x015	20	15	M6	18	300
017211-020x020	20	20	M6	18	300
017211-020x025	20	25	M6	18	300
017211-025x010	25	10	M6	18	200
017211-025x015	25	15	M6	18	200
017211-025x020	25	20	M6	18	200
017211-025x025	25	25	M6	18	200
017211-025x030	25	30	M6	18	200
017211-030x015	30	15	M8	20	200
017211-030x020	30	20	M8	20	200
017211-030x025	30	25	M8	20	200
017211-030x030	30	30	M8	20	200
017211-030x040	30	40	M8	20	200
017211-040x015	40	15	M8	13	100
017211-040x025	40	25	M8	13	100
017211-040x030	40	30	M8	23	100
017211-040x040	40	40	M8	23	100
017211-050x020	50	20	M10	28	100
017211-050x030	50	30	M10	28	100
017211-050x040	50	40	M10	28	100
017211-050x050	50	50	M10	28	100
017211-060x040	60	40	M10	28	50
017211-070x045	70	45	M10	28	50
017211-075x025	75	25	M12	37	50
017211-075x040	75	40	M12	37	50
017211-075x050	75	50	M12	37	50
017211-100x040	100	40	M16	41	25
017211-100x050	100	50	M16	41	25
017211-100x060	100	60	M16	41	25
017211-100x075	100	75	M16	41	25
017211-150x050	150	50	M16	41	10
017211-150x075	150	75	M16	41	10

1) = Packing Unit = Minimum Order Quantity

# Rubber-Metal Elements

## Program 0170

### Cylindrical Bumpers with Threaded Bolt and Internal Thread (Type B)

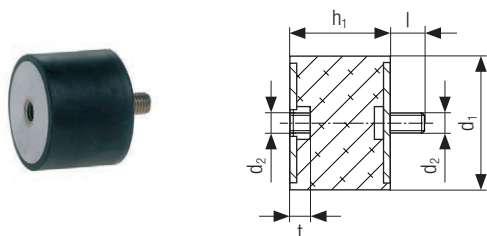

Part No.	d <sub>1</sub> [mm]	h <sub>1</sub> [mm]	d <sub>2</sub> [mm]	l [mm]	t [mm]	PU <sup>1)</sup> [Qty.]
017212-008x008	8	8	M3	6	6	300
017212-010x010	10	10	M4	10	4	300
017212-010x015	10	15	M4	10	4	300
017212-015x015	15	15	M4	10	6	300
017212-015x020	15	20	M4	10	5	300
017212-015x030	15	30	M4	15	4	300
017212-020x015	20	15	M6	18	6	300
017212-020x020	20	20	M6	18	6	300
017212-020x025	20	25	M6	18	6	300
017212-025x015	25	15	M6	18	6	200
017212-025x020	25	20	M6	18	6	200
017212-025x025	25	25	M6	18	6	200
017212-025x030	25	30	M6	18	6	200
017212-030x015	30	15	M8	21	8	200
017212-030x020	30	20	M8	20	8	200
017212-030x025	30	25	M8	20	8	200
017212-030x030	30	30	M8	20	8	200
017212-030x040	30	40	M8	20	8	200
017212-040x025	40	25	M8	23	8	100
017212-040x030	40	30	M8	23	8	100
017212-040x040	40	40	M8	23	8	100
017212-050x020	50	20	M10	28	10	100
017212-050x025	50	25	M10	28	10	100
017212-050x030	50	30	M10	28	10	100
017212-050x040	50	40	M10	28	10	100
017212-050x045	50	45	M10	28	10	100
017212-050x050	50	50	M10	28	10	100
017212-060x040	60	40	M10	28	10	50
017212-070x045	70	45	M10	28	10	50
017212-075x025	75	25	M12	37	12	50
017212-075x040	75	40	M12	37	12	50
017212-075x055	75	55	M12	37	12	50
017212-100x040	100	40	M16	41	16	25
017212-100x050	100	50	M16	41	16	25
017212-100x060	100	60	M16	41	16	25
017212-100x075	100	75	M16	41	16	25
017212-150x050	150	50	M16	41	16	10
017212-150x075	150	75	M16	41	16	10

1) = Packing Unit = Minimum Order Quantity

# Rubber-Metal Elements Program 0170

## Cylindrical Bumpers with Two Internal Threads (Type C)

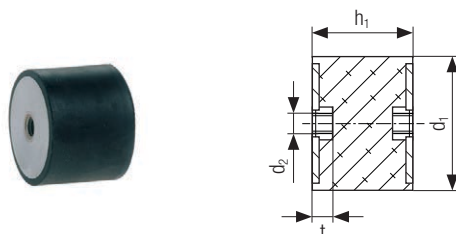

Part No.	d <sub>1</sub> [mm]	h <sub>1</sub> [mm]	d <sub>2</sub> [mm]	t [mm]	PU <sup>1)</sup> [Qty.]
017213-008x008	8	8	M3	3	300
017213-010x010	10	10	M4	4	300
017213-010x015	10	15	M4	4	300
017213-015x015	15	15	M4	5	300
017213-015x020	15	20	M4	5	300
017213-020x015	20	15	M6	6	300
017213-020x020	20	20	M6	6	300
017213-020x025	20	25	M6	6	300
017213-025x020	25	20	M6	6	200
017213-025x025	25	25	M6	6	200
017213-025x030	25	30	M6	6	200
017213-030x020	30	20	M8	8	200
017213-030x025	30	25	M8	8	200
017213-030x030	30	30	M8	8	200
017213-030x040	30	40	M8	8	200
017213-040x030	40	30	M8	8	100
017213-040x040	40	40	M8	8	100
017213-050x030	50	30	M10	10	100
017213-050x040	50	40	M10	10	100
017213-050x045	50	45	M10	10	100
017213-050x050	50	50	M10	10	100
017213-060x040	60	40	M10	10	50
017213-070x045	70	45	M12	12	50
017213-075x040	75	40	M12	12	50
017213-075x050	75	50	M12	12	50
017213-100x040	100	40	M16	16	25
017213-100x050	100	50	M16	16	25
017213-100x060	100	60	M16	16	25
017213-100x075	100	75	M16	16	25
017213-150x050	150	50	M16	16	10
017213-150x075	150	75	M16	16	10
017213-200x100	200	100	M20	18	2

1) = Packing Unit = Minimum Order Quantity

# Rubber-Metal Elements

## Program 0170

### Cylindrical Bumpers with Threaded Bolt (Type D)

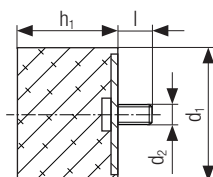

Part No.	d <sub>1</sub> [mm]	h <sub>1</sub> [mm]	d <sub>2</sub> [mm]	l [mm]	PU <sup>1)</sup> [Qty.]
017221-010x010	10	10	M4	10	300
017221-010x015	10	15	M4	10	300
017221-015x008	15	8	M4	10	300
017221-015x010	15	10	M4	10	300
017221-015x015	15	15	M4	10	300
017221-020x005	20	5	M6	18	300
017221-020x011	20	11	M6	18	300
017221-020x015	20	15	M6	18	300
017221-020x020	20	20	M6	18	300
017221-020x025	20	25	M6	18	300
017221-025x010	25	10	M6	18	200
017221-025x015	25	15	M6	18	200
017221-025x020	25	20	M6	18	200
017221-025x025	25	25	M6	18	200
017221-025x030	25	30	M6	18	200
017221-030x015	30	15	M8	20	200
017221-030x020	30	20	M8	20	200
017221-030x025	30	25	M8	20	200
017221-030x030	30	30	M8	20	200
017221-030x040	30	40	M8	20	200
017221-040x020	40	20	M8	23	100
017221-040x030	40	30	M8	23	100
017221-040x040	40	40	M8	23	100
017221-050x020	50	20	M10	28	100
017221-050x030	50	30	M10	28	100
017221-050x040	50	40	M10	28	100
017221-050x045	50	45	M10	28	100
017221-050x050	50	50	M10	28	100
017221-060x040	60	40	M10	28	50
017221-070x025	70	25	M10	35	50
017221-070x045	70	45	M10	28	50
017221-075x025	75	25	M12	37	50
017221-075x040	75	40	M12	37	50
017221-075x050	75	50	M12	37	50
017221-100x040	100	40	M16	41	25
017221-100x050	100	50	M16	41	25
017221-100x060	100	60	M16	41	25
017221-100x075	100	75	M16	41	25
017221-150x050	150	50	M16	41	10
017221-150x060	150	60	M16	41	10
017221-150x075	150	75	M16	41	10

1) = Packing Unit = Minimum Order Quantity

# Rubber-Metal Elements Program 0170

## Cylindrical Bumpers with One Internal Thread (Type E)

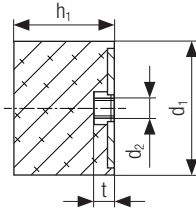

Part No.	d <sub>1</sub> [mm]	h <sub>1</sub> [mm]	d <sub>2</sub> [mm]	t [mm]	PU <sup>1)</sup> [Qty.]
017241-010x010	10	10	M4	4	300
017241-010x015	10	15	M4	4	300
017241-015x015	15	15	M4	5	300
017241-020x011	20	11	M6	6	300
017241-020x015	20	15	M6	6	300
017241-020x020	20	20	M6	6	300
017241-020x025	20	25	M6	6	300
017241-025x010	25	10	M6	6	200
017241-025x015	25	15	M6	6	200
017241-025x020	25	20	M6	6	200
017241-025x025	25	25	M6	6	200
017241-025x030	25	30	M6	6	200
017241-030x015	30	15	M8	8	200
017241-030x020	30	20	M8	8	200
017241-030x025	30	25	M8	8	200
017241-030x030	30	30	M8	8	200
017241-040x030	40	30	M8	8	100
017241-040x040	40	40	M8	8	100
017241-050x020	50	20	M10	10	100
017241-050x030	50	30	M10	10	100
017241-050x040	50	40	M10	10	100
017241-050x045	50	45	M10	10	100
017241-050x050	50	50	M10	10	100
017241-060x040	60	40	M10	10	50
017241-070x045	70	45	M10	10	50
017241-075x025	75	25	M12	12	50
017241-075x040	75	40	M12	12	50
017241-075x050	75	50	M12	12	50
017241-100x040	100	40	M16	16	25
017241-100x050	100	50	M16	16	25
017241-100x060	100	60	M16	16	25
017241-100x075	100	75	M16	16	25
017241-150x050	150	50	M16	16	10
017241-150x060	150	60	M16	16	10
017241-150x075	150	75	M16	16	10

1) = Packing Unit = Minimum Order Quantity

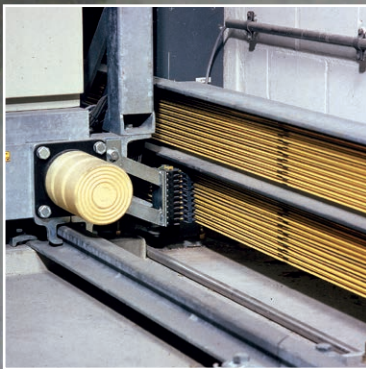
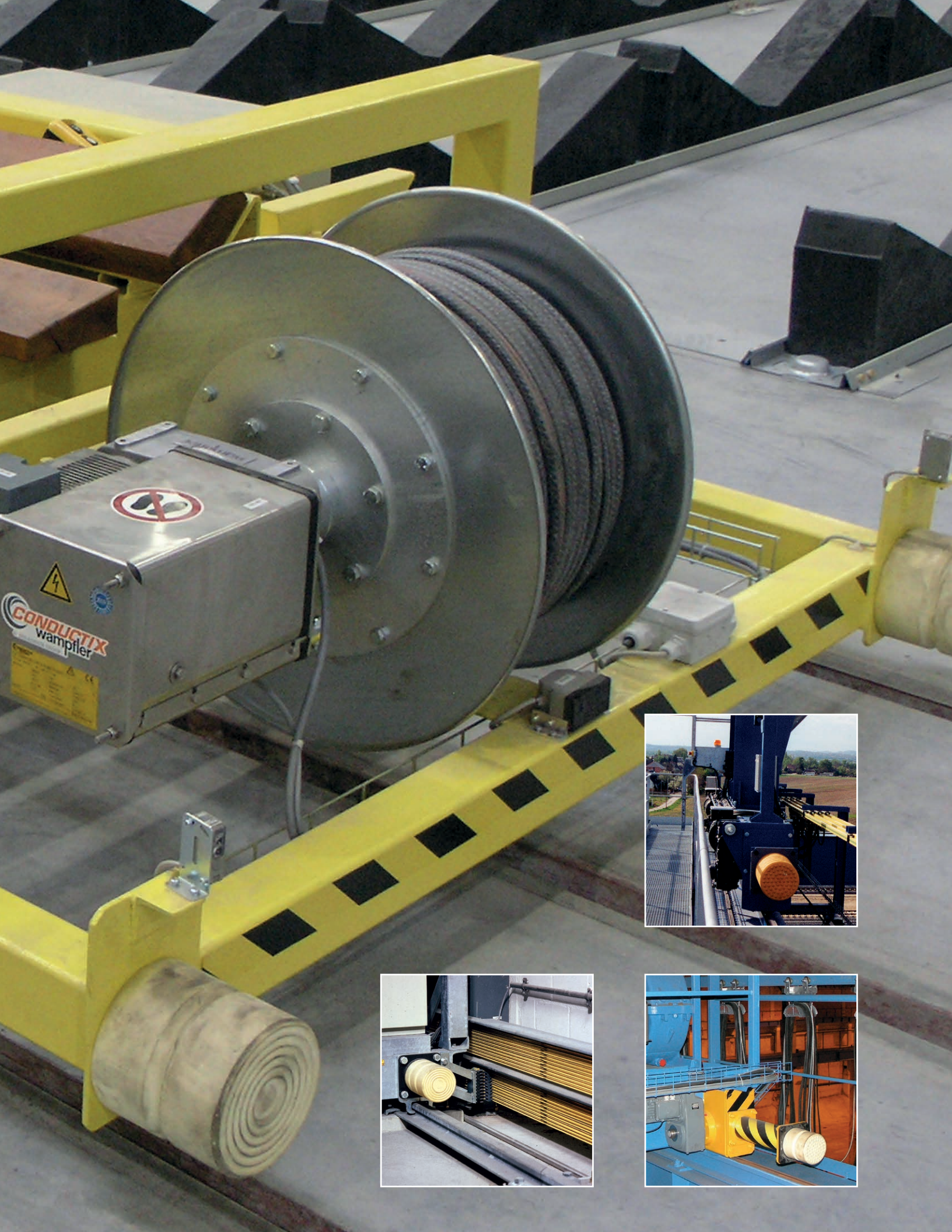



# Cellular Bumpers Program 0180

## General Information

Cellular bumpers have high absorption capacity with long compression lengths. This results in small end loads and favorable deceleration values. Cellular bumpers have a compression body made of cellular polyurethane elastomer with high structural stability. Their outstanding characteristic is their volume compressibility, which produces a short transverse elongation under pressure. Cellular bumpers are resistant to aliphatic hydrocarbons, such as oils and greases, as well as ozone, UV-radiation, and aging. Technically, you can expect generally high durability. When exposed to hydraulic oil, hot water, or water vapor over longer periods, the cellular body has limited durability. Cellular bumpers are not resistant to strong acids and leaches. The operating temperature is between  $-20^{\circ}\text{C}$  and  $+80^{\circ}\text{C}$ . Temporary temperature peaks of  $+100^{\circ}\text{C}$  are practicable and do not harm the bumper. When exposed to  $-20^{\circ}\text{C}$  the material becomes harder, but this does not affect the consistency of the material. The mounting structure must be flat and rigid. A mounting area of at least 1.5 x the diameter of the cellular bumper is required to accommodate the diameter increase of the bumper during compression.

## Example Part Number

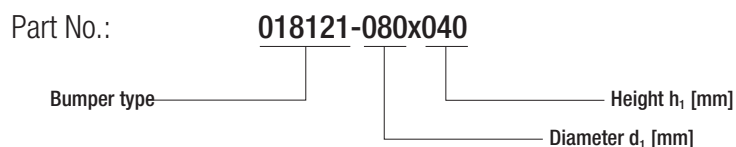

## Application Examples

- Cranes
- Transfer cars
- Smelter and rolling mill machines
- Handling technology
- Plant construction and engineering
- Conveyor, transport and gate systems that are equipped with form-locking drives (e.g. chain or toothed rack).

## Conductix-Wampfler Standard Cellular Bumper Quality

Cellular polyurethane elastomer with a volumetric weight of  $0.53 \text{ g/cm}^3$

- Highly elastic and tear-resistant
- Aging resistant
- Material is volume compressible
- Operating temperature:  $-20^{\circ}\text{C}$  to  $+80^{\circ}\text{C}$  (characteristics may change depending on ambient temperature)

## Fall Protection

We recommend using 018112 series bumpers for installation heights of 3 m or higher. All series 018112 bumpers have an integrated fall arresting device. Bumpers with diameters up to 200 mm have base plates made of glass fiber reinforced plastic and an integrated fall arresting device. Bumpers with diameters of 250 mm or higher (optionally from 200 mm) have primed steel base plates. These bumpers are glued to the base plate and have a fall arresting device in case of failure of the bond seam due to environmental conditions. For use as a safety component, please consider the applicable regulations for the final product and the recommendations from the risk analysis for this case. Bumpers should be replaced every five years for safety-relevant applications.

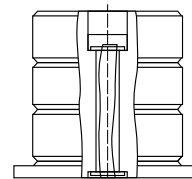

## Quality Degrees

Abrasion resistance	++
Breaking elongation	++
Tear resistance	++
Rebound resistance	++
Tensile strength	++
Temperature resistance hot air	$+80^{\circ}\text{C}$
Temperature resistance coldness	$-20^{\circ}\text{C}$
Alkali resistance	○
Aging resistance	++

Gasoline resistance	○
Electrical insulation resistance	+
Oil and grease resistance	++
Ozone resistance	+++
Acid resistance	---
Hot water	+

Quality degrees of the individual material properties (depending on interactions and exposure time): +++ = Very good; ++ = Good; + = Satisfactory; ○ = Sufficient; -- = Deficient; --- = Insufficient  
International abbreviation: PUR (cellular polyurethane elastomer)

# Cellular Bumpers Program 0180

## Cellular Bumpers with Base Plate

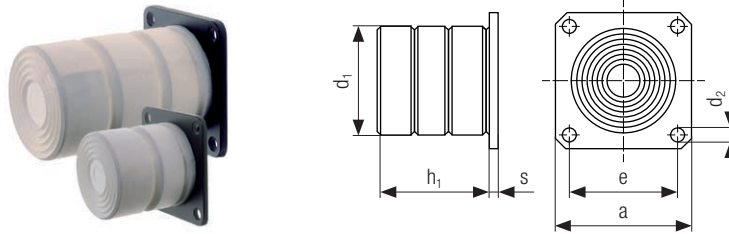

### With Plastic Base Plate

Part No.	W <sub>max</sub> [kJ]		F [kN]	Weight [kg]	d <sub>1</sub> [mm]	h <sub>1</sub> [mm]	a [mm]	d <sub>2</sub> [mm]	e [mm]	s [mm]	PU <sup>1)</sup> [Qty.]
	static	4 m/s**									
018112-080x040*	0.37	0.80	31	0.4	80	40	110	∅ 14	80	10	1
018112-080x080*	0.70	1.52		0.6		80					1
018112-080x120*	1.08	2.33		0.7		120					1
018112-100x050*	0.69	1.50	50	0.6	100	50	125	∅ 14	100	10	1
018112-100x100*	1.42	3.10		0.9		100					1
018112-100x150*	2.10	4.50		1.15		150					1
018112-125x063*	1.33	2.90	65	1.2	125	63	160	∅ 18	125	12	1
018112-125x125*	2.61	5.70		1.65		125					1
018112-125x188*	3.94	8.60		2.25		190					1
018112-160x080*	2.30	6.00	125	2.2	160	80	200	∅ 18	160	12	1
018112-160x160*	4.70	11.40		3.1		160					1
018112-160x240*	7.10	18.00		4.0		240					1
018112-200x100*	5.50	12.20	190	4.0	200	100	250	∅ 22	200	14	1
018112-200x200*	10.80	24.00		5.8		200					1
018112-200x300*	15.80	35.00		7.5		300					1

### With Steel Base Plate

Part No.	W <sub>max</sub> [kJ]		F [kN]	Weight [kg]	d <sub>1</sub> [mm]	h <sub>1</sub> [mm]	a [mm]	d <sub>2</sub> [mm]	e [mm]	s [mm]	PU <sup>1)</sup> [Qty.]
	static	4 m/s**									
018112-200x200-A	10.80	24.00	190	5.8	200	200	250	∅ 22	200	8	1
018112-200x300-A	15.80	35.00		7.5		300					1
018112-250x125*	10.54	23.00	275	12.9	250	125	315	∅ 21	250	12	1
018112-250x250*	21.13	46.00		16.2		250					1
018112-250x375*	31.71	69.00		19.6		375					1
018112-315x158*	13.30	47.00	650	22.2	315	158	400	∅ 21	315	12	1
018112-315x315*	26.60	93.00		29.0		315					1
018112-315x475*	39.84	140.00		35.9		475					1
018112-400x200*	31.13	94.00	1050	43.8	400	200	500	∅ 25	400	15	1
018112-400x400	50.00	190.00		57.6		400					1
018112-400x600	80.00	282.00		70.4		600					1
018112-500x250	50.00	190.00	1700	74.6	500	250	600	∅ 25	500	15	1
018112-500x500	100.00	370.00		101.1		500					1
018112-500x750	150.00	555.00		128.0		750					1
018112-600x300	87.50	317.00	2500	130.0	600	300	730	∅ 25	600	20	1
018112-600x600	175.00	633.00		176.0		600					1
018112-600x900	250.00	950.00		222.0		900					1

# Cellular Bumpers Program 0180

With Threaded Bolt

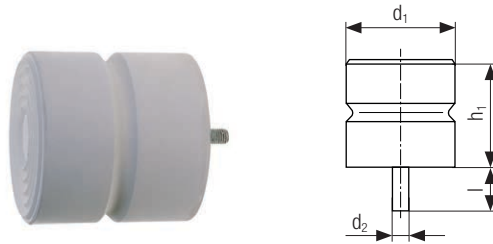

Part No.	W <sub>max</sub> [kJ]		F [kN]	Weight [kg]	d <sub>1</sub> [mm]	h <sub>1</sub> [mm]	d <sub>2</sub> [mm]	l [mm]	PU <sup>1)</sup> [Qty.]
	static	4 m/s**							
018121-080x040	0.37	0.80	31.5	0.21	80	40	M12	35	1
018121-080x080	0.7	1.52		0.31		80			1
018121-080x120	1.08	2.33		0.42		120			1
018121-100x050*	0.69	1.50	50	0.31	100	50	M12	35	1
018121-100x100*	1.42	3.10		0.52		100			1
018121-100x150*	2.10	4.50		0.72		150			1
018121-125x063*	1.33	2.90	65	0.51	125	63	M12	35	1
018121-125x125*	2.61	5.70		0.91		125			1
018121-125x188*	3.94	8.60		1.32		188			1
018121-160x080*	2.30	6.00	125	0.95	160	80	M12	35	1
018121-160x160*	4.70	11.40		1.80		160			1
018121-160x240*	7.10	18.00		2.66		240			1
018121-200x100*	5.50	12.20	190	1.76	200	100	M12	35	1
018121-200x200*	10.80	24.00		3.43		200			1
018121-200x300*	15.80	35.00		5.09		300			1
018121-250x125*	10.54	23.00	275	5.40	250	125	M24	80	1
018121-250x250*	21.13	46.00		8.47		250			1
018121-250x375*	31.71	69.00		11.53		375			1
018121-315x158*	13.30	47.00	650	8.49	315	158	M24	80	1
018121-315x315*	26.60	93.00		14.64		315			1
018121-315x475	39.84	140.00		20.79		475			1
018121-400x200	31.13	94.00	1050	16.48	400	200	M30	80	1
018121-400x400	50.00	190.00		29.04		400			1

\* Standard Range 1) = Packing Unit = Minimum Order Quantity

Tolerances of cellular bumpers according to ISO 3302-1M3 ISO 3302-1M4

\*\* Lower speeds reduce the maximum energy absorption. See Load Diagrams KAT0170-0003-US and KAT0180-0001-US on [www.conductix.us](http://www.conductix.us).

# Rubber Bumpers / Cellular Bumpers

## FAQs

---

### How is a bumper's hardness specified?

---

The hardness of a rubber bumper is measured in Shore A. The lower the hardness index number, e.g. 50 Shore A, the softer the bumper. Example reference values for shore hardness would be: 40 Shore A (soft – gummy bear), 60-70 Shore A (middle – car tire), 90 Shore A (hard – softwood).

#### Rough hardness classification of bumpers:

40-50 Shore A = medium soft bumper

70 Shore A = normal hardness

80-90 Shore A = hard rubber parts

Shore hardness is specified with very high tolerances of at least +/-5 Shore A, corresponding to deviations occurring during production. Lower tolerances are only possible to a limited extent, making stricter specifications of bumpers uneconomical.

Contrary to rubber bumpers, cellular bumpers do not receive a hardness grading. Due to their cell structure a measurement of hardness is not possible. To determine the characteristics, volume weight is used. High cell number/low density = low volume weight. Low cell number/high density = high volume weight.

---

### How does energy absorption correlate to ambient temperature and bumper intervals?

---

The stated value for maximum energy absorption refers to a standardized room temperature of +20 °C. This value decreases with rising temperatures. For a single thrust, e.g. 1 x per hour, this only needs to be taken into account when higher temperatures (> 50 °C ambient temperature) occur.

However, if the bumper is impacted repeatedly in shorter intervals, this has to be taken into account, as well as the fact that the bumper might not have enough time to disperse the thermal energy. Also, the bumper will settle and will not take his original shape in time. This lowers the possible energy absorption value for the next thrust. If energy input and energy disposal are not balanced, the bumper will be destroyed. The resulting heat in conjunction with the pressure forces make the bumper lose its characteristics and it will eventually crystallize.

---

### What are the consequences if a bumper is overdimensioned?

---

To ensure sufficient safety, bumpers are often ordered larger than necessary. However, when compressed, a bumper will build up a counter-force directly proportional to the bumper size. The larger the bumper, the higher the reset force and the corresponding deceleration.

Therefore, bumpers should not be dimensioned too large, "just to be on the safe side". Maximum permissible deceleration and end forces on the structure must be observed.

---

### What makes rubber bumpers unsuitable?

---

Standard quality rubber bumpers are not suitable for low temperature applications, or for exposure to mineral oils or gasoline. When exposed to mineral oils, bumpers made from NBR, CR or our S-quality bumpers must be used.

---

### Which specifications are necessary for bumper planning?

---

The minimum details required are effective mass, velocity, maximum permissible deceleration, and information about the framework conditions and particular application.

---

### How should bumpers be arranged when installed next to each other?

---

For this kind of arrangement, the distance between the outer planes of the bumpers must be at least 40% of the bumpers' diameter (e.g. if the bumper diameter is 100 mm, the distance between bumpers must be 40 mm). Furthermore, bumpers arranged next to each other must strike simultaneously.

---

### What are the requirements for the counter-pressure surface of the end stop bumper?

---

The size of the counter-pressure surface must be defined by the equipment manufacturer. The size of the surface area depends on bumper diameter and guide clearances. The bumpers must strike over the whole counter-pressure surface area.

---

### Important aspects during operation

---

No permanent loads must be applied to the bumpers, and therefore they must not be used as bearing points (in compressed state) for repair or maintenance work. Only perpendicular (to the base plate) application of force is permissible. Furthermore, bumpers must not be climbed on or be exposed to other extreme lateral forces.

# Rubber Bumpers / Cellular Bumpers FAQs

## Are there specific maintenance and cleaning instructions for bumpers?

During standard operational and environmental conditions, rubber and cellular bumpers are maintenance-free, with a long life cycle. We recommend regular visual checks concerning cracks, embrittlement, or other damages. If such damages are detected, the bumpers must be replaced. Bumpers should be replaced at least every 5 years when used as a safety component. Bumpers showing damage or traces of weathering must be replaced immediately, if necessary, measures to avert possible hazards must be taken – please consult maintenance instruction WV0180-0170-E.

## How are smaller bumpers/rubber-metal elements designed?

End stop bumpers with diameters up to 50 mm are called rubber-metal elements, these are chiefly regarded as mounting parts. Only limited data about their compression length and energy absorption can be found on the market. A calculated construction in the traditional sense of the word does not occur, since expenses and energy values would be disproportionate to the tolerances in calculation and materials. In practice, mounting dimensions and practical trials are used to lay out the rubber-metal elements.

## What does under-delivery and overdelivery of made-to-order rubber bumpers mean?

The vulcanization process produces a significant amount of discard, thus fluctuations in quantities occur during production. Remanufacturing often proves to be more expensive than the original batch ordered, hence conditional under or overdeliveries of up to 10% are acceptable sales standard in the rubber industry.

## Discoloring of cellular bumpers

New cellular bumpers are ivory or cream colored. Under the influence of light, bumpers can change color to a dark brown tint. This process is material-inherent and has no effect on operational or characteristic values of the bumper.

## Load diagrams of our bumpers are available on: [www.conductix.us](http://www.conductix.us)

For exact calculations of required bumper sizes, please consult our load diagram catalogs KAT0170-0003-US and KAT0180-0001-US on [www.conductix.us](http://www.conductix.us).

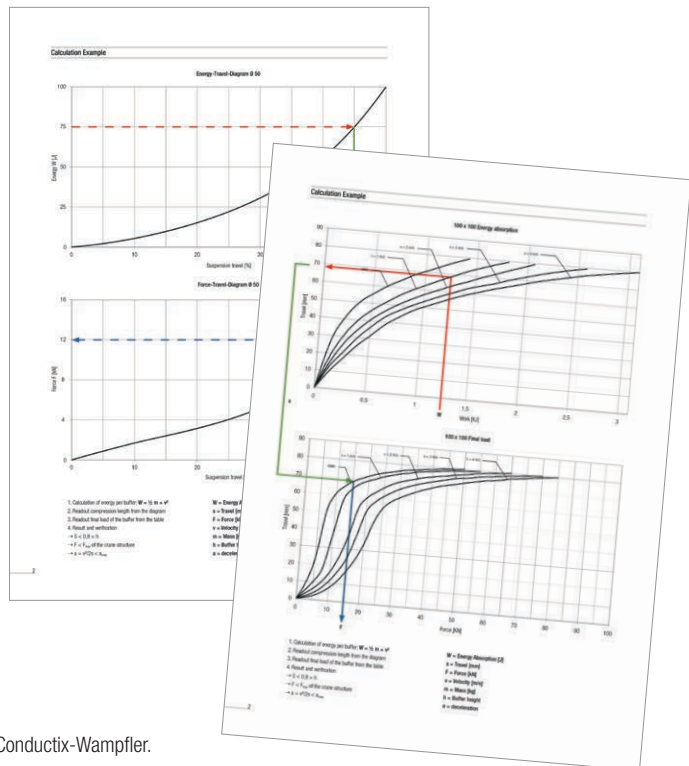

Warranty and liability claims are only assumed after written confirmation by Conductix-Wampfler.



# Custom services!

Conductix-Wampfler is a customer-focused, market-driven company. Our customers can rely on us to provide service for their specific needs and requirements.

With Conductix-Wampfler anything is possible, from the initial design and development to long-term service contracts. Whatever your needs are, we can deliver!

For complicated systems, high expectations for extended service life, and absolute need for operational reliability, it makes sense to take advantage of our after-sales service. When it comes to service, you can count on Conductix-Wampfler to perform.

## Project Planning

- Inclusion of application parameters in coordination with the customer
- Selection of the suitable bumper system
- Layout creation according to customer's needs
- Software-aided process simulation

## Mounting / Installation

- Complete system mounting
- Complete installation
- Adjustment of controls



## Initial operation

- Initial commissioning by trained personnel
- Test operation and accident simulation
- Scrutinizing the installation with the customer
- Training and briefing on-site

## Maintenance & Service

- Regular maintenance and inspections increase the life cycle of the system and thus ensure prolonged availability
- Conductix-Wampfler service contracts: the "worry-free package"

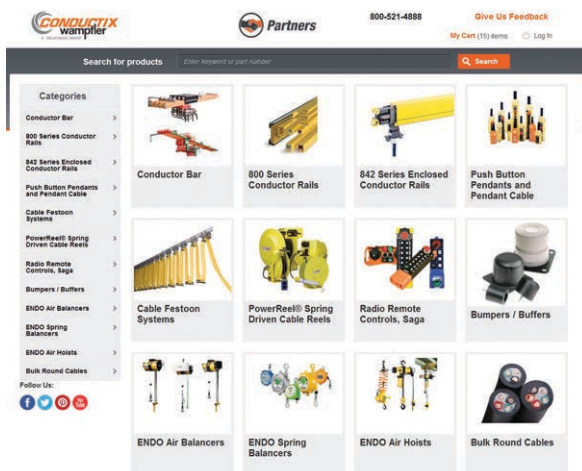

Ordering standard products and basic systems online – fast and easy

# Partners Online Store for our Customers' Convenience

Over 3000 standard products from our catalogs are available for direct ordering. You can conveniently order your products online from our Partners site (<https://partners.conductix.us/>) any time you choose.

With Partners, you can do business with us 24/7/365. Once logged in, you will see your customer-specific prices, quickly and easily – anytime.

Partners is user-friendly, with integrated search and navigation menus. The ordering process is

easy and takes no time at all.

Keep track of all transactions on your account using the comprehensive administration function.

And best of all . . . when you order online there is **no minimum order charge for small quantities!**

**<https://partners.conductix.us/>**

# Other Products from Conductix-Wampfler

The products described in this catalog represent a few of the products from the broad spectrum of Conductix-Wampfler components and systems for the transfer of energy, data, gases, and fluids. The solutions we deliver for your applications are based on your specific requirements. In many cases, a combination of several different Conductix-Wampfler products are needed to fill the application. You can count on all of Conductix-Wampfler's business units for hands-on engineering support - coupled with the perfect solution to meet your energy management and control needs.



### Motor driven cable reels

Motor driven reels by Conductix-Wampfler are the perfect solution for managing long lengths of heavy cable and hoses in very demanding industrial applications. Monospiral, level wind, and random wind spools.



### Slip ring assemblies

Whenever powered machinery needs to rotate 360°, field proven slip ring assemblies by Conductix-Wampfler can flawlessly transfer energy and data. Here, everything revolves around flexibility and reliability.



### Conductor bar

Whether they are enclosed conductor rails, expandable single-pole bar systems, or high amperage bar for demanding steel mill use up to 6000 amps. Conductix-Wampfler's conductor bar is the proven solution to reliably move people and material.



### Spring driven cable reels

We have 60 years experience and trusted brands such as Insul-8, Wampfler, and IER. We offer small cord reels all the way to large multi-motor units, a wide range of accessories, and hazardous location reels.



### Cable Festoon systems

It's hard to imagine Conductix-Wampfler cable trolleys not being used in virtually every industrial application. They are reliable and robust and available in an enormous variety of sizes and models.



### Push Button Pendants

Our ergonomic pendants are ideally suited for industrial control applications. They are available in a wide range of configurations for overhead cranes and other machinery.



### Radio remote controls

Safe, secure, and reliable radios use the latest in microprocessor technology. Available in several models for overhead crane control and other types of machinery.



### Inductive Power Transfer IPT®

The contact-less system for transferring energy and data. For all tasks that depend on high speeds and absolute resistance to wear.



### Data Transfer: ProfiDAT® | Nexus

Safe & reliable wireless communication using slotted waveguide technology that's PROFIsafe compatible.

Nexus NB for narrow band signal transfer over power conductors



### LJU Automation EMS Controller

Specialized controllers Programmable by parameters, Ideal for Electrified Monorails at automotive plants, with over 1500 in service worldwide. Adaptable for other applications



### BridgeGuard™

Prevents crane to crane and crane to end collisions. IP69K rated for indoor and outdoor use, with a 3 ft to 150 ft range. Compliant with IEC 60068-2-6:2007



### Air & Spring balancers | Air hoists

Conductix-Wampfler offers the full line of ENDO positioning devices. Rugged, reliable steel construction increasing safety and decreasing fatigue and body stress.

# www.conductix.us

## USA / LATIN AMERICA

10102 F Street  
Omaha, NE 68127

Customer Support  
Phone +1-800-521-4888

Phone +1-402-339-9300  
Fax +1-402-339-9627

info.us@conductix.com  
latinamerica@conductix.com

## CANADA

1435 Norjohn Court  
Unit 5  
Burlington, ON L7L 0E6

Customer Support  
Phone +1-800-667-2487

Phone +1-450-565-9900  
Fax +1-450-951-8591

info.ca@conductix.com

## MÉXICO

Calle Treviño 983-C  
Zona Centro  
Apodaca, NL México 66600

Customer Support  
Phone (+52 81) 1090 9519  
(+52 81) 1090 9025  
(+52 81) 1090 9013

Fax (+52 81) 1090 9014

info.mx@conductix.com

## BRAZIL

Rua Luiz Pionti, 110  
Vila Progresso  
Itu, São Paulo, Brasil  
CEP: 13313-534

Customer Support  
Phone (+55 11) 4813 7330

Fax (+55 11) 4813 7357

info.br@conductix.com

Contact us for our Global Sales Offices

