



# Workshop Manual

Our energy working for you.™



**Power  
Generation**

## S3.8 Engine



## FOREWORD

This manual is designed to be of assistance to all Personnel concerned with the maintenance and overhaul of the S 3.8 Series Engine.

It presents a complete and detailed Description of the Engine, together with precise instruction on servicing and overhaul procedure and dimensions which should be closely followed when overhauling any part of the Engine to the Manufacturers standards.

Effective maintenance can only be carried out if the personnel concerned are fully conversant with the various components of the Engine.

Before maintenance operations are commenced, this manual should be carefully studied, and it should at all times be kept where it will be needed in the workshop.

Thoroughly read the Workshop Manual before operating the generator set.

Safe operation and top performance can be obtained only when equipment is operated and maintained properly.

This manual is for guidance and assistance with recommendations for correct and safe procedures. Cummins Power Generation Limited cannot accept any liability whatsoever for problems arising as a result of following recommendations in this manual.

The information contained within the manual is based on information available at the time of going to print. In line with Cummins Power Generation Limited policy of continuous development and improvement, information may change at any time without notice. The Installers should therefore ensure that before commencing any work, they have the latest information available.

Consult your Authorised Distributor for further information or assistance if required. It is essential that the utmost care is taken with the application, installation and operation of any diesel engine due to their potentially dangerous nature. Careful reference should also be made to other Cummins Power Generation Limited literature, in particular the Health and Safety Manual 0908-0110.

Should you require further assistance contact:

Cummin India Limited  
Power Generation Business Unit  
35A/1/2, Erandwane  
Pune, 411038  
India

Tel: +91 2030248600  
Fax: +91 2066028090  
E-mail: [cpgiservicesupport@cummins.com](mailto:cpgiservicesupport@cummins.com)  
Web Site: [www.cumminspower.com](http://www.cumminspower.com)

## TABLE OF CONTENTS

DESCRIPTION	PAGE NO.
To the Owner and Operator .....	6
Routine Service and Parts .....	7
10 Maintenance Steps for Cummins Engines .....	8
Section 1 .....	9
Operating Instructions New and rebuilt engine break-in .....	
Section 2 .....	15
Special Operating Instructions	
Section 3 .....	17
Engine Operation in Cold Weather	
Section 4 .....	18
Maintenance of Engine Laid up for Long Period	
Section 5 .....	19
Maintenance Operations	
Section 6 .....	25
Lubricants, Fuels & Coolant	
Section 7 .....	29
Checking Valve Timing	
Section 8 .....	37
Tightening Torques	
Section 9 .....	39
Troubleshooting	

## To the Owner and Operator

### General Information

Preventative maintenance is the easiest and least expensive type of maintenance. Follow the maintenance schedule outlined in this manual.

Keep records of regularly scheduled maintenance.

Use the correct fuel, lubricating oil and coolant in your engine.

Cummins Inc. uses the latest technology and highest quality components to produce its engines. Cummins Inc. recommends using genuine Cummins new parts and ReCon<sup>®</sup> exchange parts.

Personnel at Cummins Authorized Repair Locations have been trained to provide expert service and parts support.

## **Routine Service and Parts**

### **General Information**

Personnel at Cummins Authorized Repair Locations can assist you with the correct operation and service of your engine. Cummins has a worldwide service network of Distributors and Dealers who have been trained to provide sound advice, expert service, and complete parts support.

## **Problem Solving**

### **General Information**

Normally, any problem that arises with the sale, service, or repair of your engine can be handled by a Cummins Authorized Repair Location in your area. If the problem has not been handled satisfactorily, follow the steps outlined below:

1. If the disagreement is with a Dealer, talk to the Cummins Distributor with whom the has his service agreement.
2. If the disagreement is with a Distributor, call the nearest Cummins Division or Regional Office; however, most problems are solved below the Division or Regional Office level. Before contacting, write down the following information:
  - Engine model and serial number
  - Type and make of equipment
  - Total hours of operation
  - Warranty start date
  - Nature of problem
  - Summary of the current arranged in order of occurrence
  - Name and location of the Cummins Distributor or Dealer

## **10 MAINTENANCE STEPS FOR CUMMINS ENGINES**

- 1. KEEP DIRT OUT OF THE ENGINE.**
- 2. MAINTAIN A LUBRICATING FILM ON ALL BEARING SURFACES.**
- 3. REGULATE THE ENGINE'S FUEL.**
- 4. CONTROL OPERATING TEMPERATURE.**
- 5. GUARD AGAINST CORROSION.**
- 6. LET THE ENGINE BREATHE.**
- 7. PREVENT OVER-SPEEDING.**
- 8. KNOW YOUR ENGINE'S CONDITION.**
- 9. CORRECT PROBLEMS WHILE THEY ARE SIMPLE.**
- 10. SCHEDULE & CONTROL YOUR ENGINE MAINTENANCE.**

## Section 1

### OPERATING INSTRUCTIONS

The engine operator must assume responsibility of engine care while engine is being operated. There are comparatively few rules which operator must observe to get best service from a Cummins Diesel Engine.

#### GENERAL-ALL APPLICATION

##### New and rebuilt Engine Break-In

S-3.8 engines are tested before being shipped from the factory and are ready to be put to work.

 **Note :** One receipt of engine by truck, ensure unloading of the engine by skilled personnel. The Personnel have to use necessary personal protective equipment to avoid accidents. Engines are to be un loaded using the lifting hooks fitted on the engines. During the engine installation ensure proper fitment of Anti Vibration Mounting Pad.

 **Warning :** Ensure that the shipping bracket is removed during the engine installation.

You will get better life from engine by,

1. Avoiding operation for long periods at engine idle speeds, or at maximum horsepower levels in excess of five minutes.
2. Developing the habit of watching engine instruments closely during operation and letting up on throttle if oil temperature reaches. 250°F (121°C) or coolant temperature exceeds 203°F (95°C)
3. Checking engine oil level prior to engine start.
4. For continuous rating, load can be applied after the engine is commissioned.

##### New or Rebuilt Engines.

##### Pre-Starting Instructions-First Time Priming the Fuel System.

1. Fill fuel filter with clean No. 2 diesel fuel oil meeting the specification outlined.
2. Check the oil level of the MICO fuel pump with the dipstick provided.
3. Check & fill fuel tanks.

##### Oil Pan Capacities

High (liters)	Low (liters)
8	6

1. Fill engine with amount of oil listed as low-level oil pan capacity.
2. Allow five (5) minutes or more for oil to drain to the oil pan. If engine and/or oil temperature is below 40° F (4° C), a longer period may be required for full drain.
3. Insert dipstick into gauge tube fully seated; hold for five (5) ten (10) seconds, then withdraw slowly.
4. Add enough additional oil to fill engine to listed high-level capacity. The dipstick has mark to high & low oil level.
5. Start engine and operate at idle for 3 minutes. Stop engine wait for 10 minutes and fill to high mark. Additional oil may be required to fill oil filters and lines.

Do not confuse with complete oil system capacity which also includes drilled passages, lines and filters.

##### Priming the Lubricating System

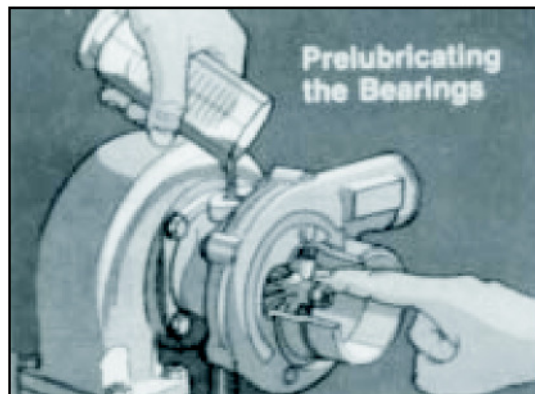



Fig. 1-1 : Pre-lubricating Turbo

 **Note :** On turbocharged engines, remove oil inlet line from the turbocharger and pre-lubricate bearing by adding 2 to 3 oz. (50 to 60cc) of clean lubricating oil. Reconnect oil supply line.

## Check Air Connection

Check air connection to **air cleaner and air crossovers to assure all are secured.**

## Check Engine Coolant Supply

Remove the radiator cap and check engine coolant level. Add coolant as needed.

## COOLING SYSTEM

Check and top up radiator with Specified coolant if required. If the coolant starts boiling, there could be a defect in the cooling system which may be on account of :

- i. Less coolant or dirt/scale having accumulated inside cooling water passages, especially in the radiator cores.
- ii. Choking of the radiator air passages due to foreign material or damaged radiator fins.
- iii. Loss of coolant by evaporation and leakage through defective radiator cap.
- iv. Loose water pump drive belt.
- v. Coolant leakage from the cooling system.

Always use genuine radiator cap. A proper radiator cap firmly fitted maintains pressure in the cooling system and makes the engine more efficient by permitting a slightly higher operating temperature. The vacuum in the radiator is relieved by a valve provided in the cap. The radiator pressure cap value is 7 PSI. Degrease and clean cooling system regularly.



**Caution : Do not add cold water too quickly to hot engine.**

## FUEL SYSTEM

The photograph shows different points for fuel system. The description of these points are,

1. Bleeding screw primary filter
2. Bleeding screw secondary filter
3. Drain plug secondary filter.
4. Drain plug primary filter.
5. Bleeding screw on fuel injection pump.



**Fig. 1-2: Engine Fuel Filter**

## Fuel System Bleeding

If the performance of the engine is affected due to presence of air in the fuel system (commonly known as air lock) the defect can be removed by bleeding the fuel system as follows :

- a. Loosen bleeding screw on primary filter.
- b. Unscrew lift pump lever knob and prime till diesel coming out of the bleeding screw of the primary filter is free from any air bubble.
- c. Tighten bleeding screw and plunger knob.
- d. Repeat this process on bleeding screw on the secondary fuel filter and then on the fuel injection pump gallery. If the air bubbles continue coming out of the bleeding screws, either there is less diesel in the tank or there is an air leak in the suction pipe. Check and rectify.

## Overflow Valve

In case the engine running is found to be irregular or shows a tendency to fall or there is loss of power, this may be due to faulty operation of the overflow valve in the fuel filter system.

If necessary, replace it.

## Nozzle Operation

If the engine is running irregularly or there is a diesel knock or the fuel consumption is abnormal,



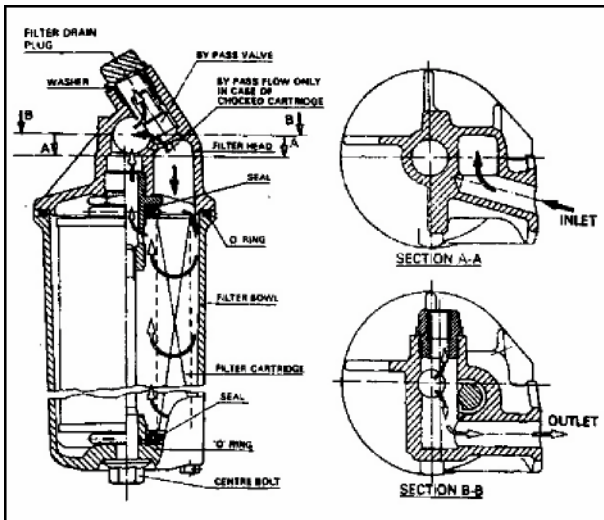

**Fig. 1-3 Cross-section of Lub-oil Filter**

faulty injection nozzle operation may be the cause. Generally, this is due to dirt in the fuel system. If excessive black smoke is emitted on acceleration, it could be due to drubbing of nozzles. Get the nozzles checked at **MICO dealer point**.

### CHANGING ENGINE OIL

The engine oil should be drained while it is still hot.

- a. Unscrew sump drain plug and allow the oil to drain out for 20 mins.
- b. Unscrew filler plug of oil filter, drain out oil and refit filler plug.
- c. Unscrew centre bolt and remove oil filter bowl. Discard oil filter cartridge. **The filter cartridge should not be cleaned or reused.**
- d. **Check "O" ring and seal for any damage. Replace if found damaged.**
- e. **Clean the bowl thoroughly** and insert a **new genuine fuel flow oil filter cartridge** into the bowl.
- f. During re-assembly of the oil filter, fill the filter bowl with one litre of engine oil through the drain plug and fit the filter bowl to the top cover and tighten the centre bolt to the specified torque. Before starting, crank the engine with the help of ignition key, so that

the oil can immediately flow to the bearings and the time required by the oil to attain the correct pressure is minimised.

If this instruction is ignored the bearing may get damaged. The oil filter must be kept clean as far as possible to protect the engine components from rapid and excessive wear and tear due to abrasion. Tighten the centre bolt to 4 Kg-m. torque.

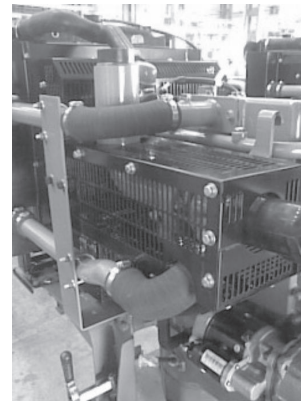

**Fig. 1-4 : Oil Filling Point on Engine**

**Note :** In case the old filter cartridge was found damaged/punctured, the filter top cover assembly should also be removed and refitted after thorough cleaning.

Proceed as below :

- i. Remove the two screws holding the filter top cover to the crankcase and remove it with its gasket.
- ii. Remove the bypass valve assembly and clean the valve and its seat.
- iii. Clean all oil passage in cover thoroughly. Replace "O" ring and seals if found damaged.
- iv. Reassemble bypass valve with new sealing washer if necessary.
- v. Fit new gasket on the cover.
- vi. Refit oil filter cover assembly to the crankcase taking care that the gasket does not get damaged during fitment.
- vii. Tighten evenly and equally the two mounting bolts of cover to 6 Kg-m. torque.

- viii. Clean the drain plug of the engine oil sump and refit with a new sealing washer if necessary. Tighten to 4 to 6 Kg-m. torque.
- ix. Fill in 8 liters of engine oil into the sump.
- x. Start engine and allow it to run for a few minutes and stop.
- xi. After 2° minutes check level of oil indicated on the dipstick. It should be at the upper mark and if not, top up.
- xii. Check oil level in fuel injection pump and governor. Top up, if necessary.



**Caution : Make sure that only genuine oil filter cartridge is used. Inspection of non genuine filter cartridges available in the market at low prices have revealed:**

- i. Use of inferior filtering material which cannot properly filter the engine oil.
- ii. Improper dimensions which cannot prevent filtered oil getting mixed with unfiltered oil.

Since it is extremely difficult to distinguish between genuine and non-genuine filter elements, obtain these only from Cummins Dealers.

#### **PREPARING THE ENGINE FOR A OPERATION PREPARING THE ENGINE FOR A DAY'S WORK Check the following :**

1. Fuel level in fuel tank, Top up, if necessary and secure cap.
2. Engine oil level - First thing in the morning or at least 2° minutes after stopping the engine. Top up, if oil level is less than midway between minimum and maximum marks.

The oil Should not exceed the maximum level mark. Use only approved brand of oil.

3. Radiator coolant level. Top up, if necessary and secure radiator cap.
4. Condition and tension of fan belt. Adjust tension, if necessary.
5. All gauges, for proper functioning.
6. Leakage of coolant, fuel or oil at all joints of hoses and pipes and rectify, if necessary.

### **Starting the Engine**

Starting requires the clean air & fuel to be supplied to the combustion chambers in proper quantities at the correct time.

### **Engine Warm-up**

When the engine is started, it takes a while to get the lubricating oil film re-established between shafts and bearings and between pistons and liners. The most favourable clearances between moving parts are obtaining only after all engine parts reach normal operating temperature. Avoid seizing pistons in liners and running dry shafts in dry bearings by brining the engine up to operating speed gradually as it warms up.

### **Oil Temperature**

The oil temperature gauge normally should read between 167° F (75° C) and 221° F (1°5° C). Under full load conditions, an oil temperature of 24° F (116° C) for a short period is not a cause for alarm.



**Caution : Any sudden increase in oil temperature which is not caused by load increase is a warning of possible mechanical failure and should be investigated at once.**

During warm-up period, apply load gradually until oil temperature reaches 14° F (6° C). While oil is cold it does not do a good job of lubricating. Continuous operating or long periods of idle with oil temperatures below 14° F (6° C) may cause crankcase dilution and acids in the lubricating oil which quickly accelerate engine wear.

### **Water Temperature**

A water temperature of 167° to 2°3° F (75° C to 95° C) is the best assurance that working parts of the engine have expanded evenly to the most favourable of clearances. Maximum engine coolant temperatures should not exceed 2°3° F (95° C). Keep thermostats always in the engine, avoid long period of idling and take necessary steps to keep water temperature up to a minimum of 167° F (75° C). If necessary in cold weather, use radiator shutters or cover a part of the radiator to prevent overcooling.

## Oil Pressure

Normal engine oil Pressure at temperature 221<sup>0</sup> F (105<sup>0</sup> C) should be between 2.5 to 5 Kg/cm<sup>2</sup> at rated speed and 1 to 2 Kg/cm<sup>2</sup> at low idle speed.

 **Note : Please note that oil pressure will vary with temperature.**

 **Note : Individual engines may vary from above normal pressures. Observe and record pressure when engine is new to serve as guide for indication of progressive engine condition. (High oil pressure during start up is not a cause for alarm.) For record purposes these readings are more accurate and reliable when taken immediately after an oil change.**

## Engine Exhaust

The engine exhaust is a good indicator of engine operation and performance. A smoky exhaust may be due to a poor grade of fuel, dirty air cleaner, overfueling or poor mechanical conditions.

If engine exhaust is smoky, corrective action should be taken.

 **Warning : Inhalation of exhaust gases can result in severe personal injury or death. Use extreme care during installation to provide a tight exhaust system. Terminate exhaust pipes away from enclosed or sheltered areas, windows, doors and vents.**

## High Altitude Operation

Some engines, particularly naturally aspirated, lose horsepower when operated at high altitude because the air is too thin to burn as much fuel as at sea level. This loss is about 5 percent for each 1800 ft. of altitude above sea level for a naturally aspirated engine. Operate the engine using a lower power requirement at high altitude to prevent smoke and over-fueling.

## Engine Shut-Down

### Idle Engine A Few Minutes Before Shut-

**Down** It is important to idle an engine 3 to 5 minutes

before shutting it down to allow lubricating oil and water to carry heat away from the combustion chamber, bearings shafts etc. This is especially important with turbocharged engines.

The turbocharger contains bearings and seals that are subject to the high heat of combustion exhaust gases. While the engine is running, this heat is carried away by oil circulation, but if the engine is stopped suddenly, the turbocharger temperature may rise above 360<sup>0</sup> F. The results of extreme heat may be seized bearings or loose oil seals.

## Do Not Idle Engine For Excessively Long Periods

Long periods of idling are not good for an engine because combustion chamber temperatures drop so low the fuel may not burn completely. This will cause carbon to clog the injector spray holes and piston rings and may result in stuck valves.

If engine coolant temperature becomes too low, raw fuel will wash lubricating oil off cylinder walls and dilute crankcase oil so all moving parts of the engine will suffer from poor lubrication.

If the engine is not being used, shut it down.

**Switch off the engine with the shut down coil provided on engine.**

**Or**

The engine can be shut down by pulling down mechanical lever fitted on MICO pump.

## Radiator

The radiator used on S-3.8-G engine are state of the art aluminium radiators. These radiators are with aluminium tubes & fins. The top and bottom tank are of moulded plastic material. These radiators do not have de-aeration cooling system.

 **Warning : Do not remove the guarding when the engine is in working condition.**



## Section 2

### SPECIAL OPERATING CONDITIONS

#### **Precautions to be observed when operating at high altitudes and low ambient temperatures.**

Because of low atmospheric pressure which reduces the oxygen content at high altitudes it is necessary to make certain adjustments in the fuel injection pump output to prevent black smoke caused by unburnt fuel emitting from the engine.

Similarly the lubrication, fuel and the cooling system have to be properly attend to when S-3.8-G engine is operated at very low ambient temperatures.

We are giving below **special instructions** to be followed while **operating Cummins Diesel Engines at high altitudes and low ambient temperature.**

#### **1) HIGH ALTITUDE OPERATION**

##### **Fuel System**

The engine output decreases due to reduction in the atmospheric pressure and density. To ensure an optimum operation of the engine at these conditions, it is necessary to reduce fuel supply for the range of altitudes are given below. This is necessary since devices which will correct fuel supply during operation at varying altitudes are not available.

For Alternating in low and high altitudes up to approx. 2000 meters, no changes of the setting are necessary in general.

For operation above 2000 meters, injection pumps which inject a reduced quantity of fuel as compared to the standard pump are required.

In injection pumps installed as standard equipment, the quantity of fuel injected can be reduced by loosening the lock nut & turning the full-load stop screw for the control rod clockwise for RSV pumps. The adjustment should be made on an injection pump test stand. Turning the stop screw

clockwise or anti-clockwise direction as the case may be, results in a reduction of quantity of fuel injection, 1/4 turn correspond to approx. 7% of the total quantity injected.

For smoke-free operation of the diesel altitude, the quantity above 2000 meters altitude, the quantity injected should be reduced by about 20% (corresponding to 3/4 turn of the stop screw)

Mark injection pump by the letter "z" behind the pump designation after the work was carried out.

The adjustment to the fuel injection pump should be carried out at authorised MICO dealers workshops.

#### **2) LOW TEMPERATURE OPERATION**

##### **Lubrication System**

The lubrication oils for engine, are required to be of lower viscosity.

Recommendations for the same are as under :

The recommended types of engine oils and the range of ambient temperatures at which these can be used are given in the following table.

<b>Ambient temperature in deg. C</b>	<b>Engine oil grade</b>
-10 and above	SAE 15W40
-20 to 0	SAE 10W30
-10 and Below	SAE 5W20

These oils should confirm to SAE API CF4+ specification.

##### **Cooling System**

Certain precautions have to be taken to enable the cooling system to function properly at very low ambient temperatures. To attain the recommended working temperature of the engine faster, it is necessary to use a radiator blind.

Use the antifreeze and water to 50:50 proportion.

### Recommended Antifreeze Agents

The specification for low silicate antifreeze which meets ASTM 4985 test (GM6038M spec) criteria.

**Note :**

1. Engine is supplied with Premix Coolant as First Fill.
2. Mixing of other brands with Antifreeze Coolant is not recommended.

Before adding the antifreeze agent into the cooling system.

- i. Inspect the cooling system for leakages and clean it thoroughly.

Certain precautions have to be taken to enable the cooling system to function properly at very low ambient temperatures. To attain the recommended working temperature of the engine faster, it is necessary to use a radiator blind.

In view of the grave risk of damage due to frost, the cooling system of the engine should be filled with recommended quantity of antifreezing agent.

Percentage of antifreeze agent in cooling system which depends upon ambient temperature is shown in following table :

Upto Ambient Temperature °C	Percentage	
	Water	Antifreeze agent
All Temp. ranges 50	50	

Before adding the antifreeze agent into the cooling system.

- i. Inspect the cooling system for leakages and clean it thoroughly.
- ii. Inspect the thermostat and replace if found defective.

It is advisable to attach a warning sign to the radiator neck reading.

**"Antifreeze Solution is effective upto -40°C. Do not drain off cooling system"**

It is recommended that the entire cooling system should be drained and filled with fresh mixture of antifreeze agent and water in the ratio of 50:50 for ambient temperature of upto -40°C Coolant should be drained and replenished in the recommended ratio **every two years Or 2400 hrs. which ever is earlier.**

### Electrical System

At low ambient temperatures particular care should be taken for electrical system. Useful instructions on this subject are given below.

A full state of charge in battery should be maintained by carefully servicing and reduced current consumption. Below ambient temperatures, the starting capacity of a battery is seriously affected.

**The specific gravity of the electrolyte should be raised from 1.21 to 1.28 when operating at temperatures below -15°C.** The battery should be removed and stored in a warm place when not in operation. While reconnecting the battery, observe polarity and care should be taken to check that the terminals are kept clean and free from oxide. A run down battery should be charged. Do not add distilled water to discharged or cold battery.

## Section 3

### ENGINE OPERATION IN COLD WEATHER

Satisfactory performance of a diesel engine operating in low ambient temperature conditions requires modification of the engines, surrounding equipment, operating practices and maintenance procedures. The colder the temperature encountered the greater the amount of modification required and yet with the modifications applied, the engines must still be capable of operation in warmer climates without extensive changes. The following information is provided to engine owners, operators and maintenance personnel on how the modifications can be applied to get satisfactory performance from their diesel engines.

There are three basic objectives to be accomplished :

1. Reasonable starting characteristics followed by practical and dependable warm-up of engine and equipment.
2. A unit of installation which is as independent as possible from external influences.
3. Modifications which maintain satisfactory operating temperatures with a minimum increase in maintenance of the equipment and accessories.

4.	<b>Winterize</b>	<b>Winterize</b>	<b>Artic</b>	<b>Specifications</b>
----	------------------	------------------	--------------	-----------------------

3° F (-1° C) to -1° F (-23° C)	to -25° F (-32° C)	to -25° F (-32° C)	to -65° F (-54° C)
-----------------------------------	-----------------------	-----------------------	-----------------------

Use antifreeze to protect to -2° F (-29° C)	Use ethylene glycol antifreeze 5% water 5%	Use ethylene glycol antifreeze 5% water 5% mixture.
---	--	---

If satisfactory engine temperature is not maintained higher maintenance cost will result due to increased engine wear, poor performance and formation of excessive carbon, varnish and other deposits. Special provisions to overcome low temperatures are definitely necessary, whereas

a change to warmer climate normally required only a minimum of revision. Most of the accessories should be designed in such a way that they can be disconnected so there is little effect on the engine when they are not in use.

The two commonly used terms associated with preparation of equipment for low temperature operation are "Winterization" and "Artic Specifications."

Winterization of the engine and/or components so starting and operation possible in the lowest temperature to be encountered requires :

1. Use of correct materials.
2. Proper lubrication, low temperature lubricating oil.
3. Protection from the low temperature air. The metal temperature does not change, but the rate of heat dissipation is affected.
4. Fuel of proper grade for lowest temperature.
5. Heating to be provided to increase engine block and component temperature to a minimum of -25° F (-32° C) for starting in lower temperatures.
6. Proper external heating source available.
7. Electrical equipment capable of operating in lowest expected temperature.

Artic Specification refer to the design material and specifications of components necessary for satisfactory engine operation in extreme low temperatures to -65° F (-54° C). Contact Cummins India Limited or the equipment manufacturer to obtain the special items required.



**Caution : "Anti-leak" antifreeze are not recommended to use in Cummins Engines. The "anti-leak" agents may clog the coolant filters and render them ineffective.**



## Section 4

### MAINTENANCE OF ENGINE LAID UP FOR LONG PERIOD

For engines which are not likely to be operated for a long period the following maintenance operations are recommended to prevent deterioration :

1. Add 1% of water soluble anticorrosion oil to the cooling water in the radiator. Then run the engine until it is warm-water temperature should reach at least 60°C, so that the anticorrosion oil is distributed throughout the cooling system. Then drain cooling water completely.
2. For preserving the fuel system 5 to 10% of engine anticorrosion oil has to be added to the fuel in the fuel tank as well as to the oil in the housing of the injection pump. Then operate the engine for a few minutes. The above fuel mixture provides sufficient protection against corrosion even if the injection pump is not operated for a long period of time. Then remove pump cover and spray pump elements and springs with engine oil containing 5 to 10% of anticorrosion oil. Screw on pump cover and spray outside of the pump with the mixture.
3. To preserve the engine, drain engine oil while it is hot and replace by recommended anticorrosion oil. Then crank the engine for 5 seconds with the starter motor.
4. For the protection of the cylinder walls remove the nozzles and inject 20 cc of anticorrosion engine oil into each cylinder. When doing so, the piston should be at the bottom dead centre. Refit nozzle and crank the engine with the starter motor for about 5 seconds. Before doing so, disconnect injection lines from the injection pump, so that
5. Spray the unpainted parts of the engine with anticorrosion oil Rustban 339 compound. Cover the fan belt and rubber hoses before

doing so.

- After the cylinder head cover has been removed and the inlet ports closed, the rocker arms, valves etc. should be sprayed with engine anticorrosion oil and the cover refitted.
6. Batteries, which are not used, should be serviced at regular intervals, in order to keep them in good condition. Batteries should be stored in a cool and dry room. Check battery condition every fortnight and if necessary recharge.
  8. Cover up opening for air cleaner, exhaust pipe and engine breather pipe. The parking area should be airy and dry.

#### PREPARATION OF ENGINE AFTER EXTENDED STORAGE PERIOD

- i. a. Check engine oil level, top up, if necessary.  
b. Remove injectors and check for spray and nozzle opening pressure.
- ii. Hold injection pump control lever in "stop" position.
- iii. a. Crank the engine with the help of starter until oil pressure is indicated on the gauge. Do not depress accelerator pedal. Cranking interval should be long enough to allow for battery recoveries.  
b. Refit injectors.
- iv. Finally start engine in the usual manner.
- v. The initial operation oil (running-in-oil) may remain in the engine for a short period of time (not more than 25 hrs.) after termination of the storage period. However, the oil should be drained as soon as possible and replaced by HD oil grade in accordance with the ambient temperature conditions.



## Section 5

# MAINTENANCE OPERATIONS

**Maintenance is the key to lower operating costs. A diesel engine requires regularly scheduled maintenance to keep it running efficiently.**

### MAINTENANCE SCHEDULE

Preventive maintenance is the easiest and least expensive type of maintenance. It permits the Maintenance Department to do the work at a convenient time.

#### **A good Maintenance Schedule Depends on Engine Application**

Actual operating environment of the engine governs the maintenance schedule. The suggested check-sheet on the following page indicates some checks have to be performed more often heavy dust or other special conditions.

#### **Using the Suggested Schedule Check Sheet**

The maintenance schedule check-sheet is designed as guide until adequate experience is obtained to establish a schedule to meet a specific operation.

A detailed list of component checks is provided through several check periods; also a suggested schedule basis is given for hours of operation, or calendar of time.

A maintenance schedule should be established using the check-sheet as a guide; the result will be a maintenance program to fit a specific operation.

The check-sheet shown can be reproduced by any printer. The person making each check can then indicate directly on the sheet that the operation has been completed. When a complete column (Under A, B, C etc.) of checks is indicated, the engine will be ready for additional service until the next check is due.

#### **Storage for Engines Out of Service**

If an engine remains out of service and its use is not immediately forthcoming, special precautions should be taken to prevent rust as per procedure given in Section 4.



**Note : Please refer the table for the engine maintenance schedule and mandatory checks for S series.**

ENGINE MAINTENANCE SCHEDULE & MANDATORY CHECKS FOR 'S' SERIES With Spin-on type Fuel & Lube Oil Filter				
SYSTEM	A – Check	B – Check	C - Check	D - Check
<b>GROUP</b>	Daily	Every 475 – 500 Hrs OR 6 months, which is earlier	Every 1450 – 1500 Hrs OR 12 months, which is earlier	Every 2900- 3000 Hrs OR 24 months, which is earlier
<b>LUBRICATION SYSTEM</b>	<ul style="list-style-type: none"> <li>▪ Check Lube oil level &amp; top-up Lube oil upto 'H' mark on Dipstick</li> <li>* Use only <b>CH4-15W40</b> Lube oil</li> </ul>	<ul style="list-style-type: none"> <li>▪ Repeat A Check</li> <li>▪ <b>Change Lube Oil</b></li> <li>* Use only <b>CH4-15W40</b> Lube Oil</li> <li>▪ <b>Change Spin-on Lube Oil Filter.</b></li> </ul>	<ul style="list-style-type: none"> <li>▪ Repeat B Check.</li> <li>* Check visually for metal particles in used Lube Oil</li> <li>▪ Clean Breather arrangement</li> </ul>	<ul style="list-style-type: none"> <li>▪ Repeat C Check</li> <li>▪ Measure Blow Bye . ( Max. 8 inches of H<sub>2</sub>O Water column with 0.221 inches Dia Orifice )</li> </ul>
<b>COOLING SYSTEM</b>	<ul style="list-style-type: none"> <li>* Check for leaks. Rectify leak if found any.</li> <li>* Check Coolant level in Radiator (Caution : Do not remove Cap when hot )</li> <li>* Check Coolant level in Tank, coolant.. If required, fill Premix Coolant only in the Tank, coolant up to H mark.</li> </ul>	<ul style="list-style-type: none"> <li>▪ Repeat A Check</li> <li>▪ Check Fan Drive arrangement.</li> <li>* <b>Check Belt for looseness. Tighten if required.</b></li> </ul>	<ul style="list-style-type: none"> <li>▪ Repeat B Check.</li> <li>▪ Check condition of Hoses &amp; clamps. Replace if necessary.</li> <li>* Check sealings around Radiator</li> <li>▪ If required, clean dust on Core of Radiator by very very low pressure of Air. ( 0.2 Kg / cm<sup>2</sup> )</li> <li>* Check Cap, radiator for seal. Change the Cap if required.</li> </ul>	<ul style="list-style-type: none"> <li>▪ Repeat C Check</li> <li>▪ Change Belt, Fan Drive</li> <li>▪ <b>Change Coolant &amp; fill Radiator with Premix coolant only</b></li> </ul>
<b>FUEL SYSTEM</b>	<ul style="list-style-type: none"> <li>* Check for fuel leaks.</li> <li>* Rectify leak if any. In case of leak at Banjo, change the Copper Washer</li> <li>▪ Drain Sediments from Fuel Water Separator</li> </ul>	<ul style="list-style-type: none"> <li>▪ Repeat A Check</li> <li>▪ <b>Change Spin-on Fuel Filter</b></li> <li>* Clean Fuel tank inlet strainer</li> <li>▪ Clean Breather on Fuel Tank</li> </ul>	<ul style="list-style-type: none"> <li>▪ Repeat B Check.</li> <li>▪ Check all joints in Fuel Lines &amp; tighten.</li> <li>▪ Clean Pre-Filter of Feed Pump, Fuel.</li> </ul>	<ul style="list-style-type: none"> <li>▪ Repeat C Check</li> <li>▪ <b>Change Fuel Hoses</b> if Required</li> <li>* Calibrate Nozzles &amp; FIP at BOSCH service centre.</li> </ul>
<b>AIR SYSTEM</b>	<ul style="list-style-type: none"> <li>▪ Check Indicator Service for Air Restriction ( Red Band indication ).</li> <li>* Clean Element, Air Cleaner in reverse direction of Air flow, using dry air with max 0.5 kg / cm<sup>2</sup> pressure</li> <li>▪ Check sealing &amp; condition of Air Cleaner</li> </ul>	<ul style="list-style-type: none"> <li>▪ Repeat A Check</li> <li>▪ Clean Element, Air Cleaner, if required</li> </ul>	<ul style="list-style-type: none"> <li>▪ Repeat B Check</li> <li>* <b>Change the Element, Air Filter</b></li> <li>* Check Hose &amp; Clamps.</li> <li>* Check indicator Service, for its proper function.</li> </ul>	<ul style="list-style-type: none"> <li>▪ Repeat C Check</li> <li>* Check axial &amp; radial clearances of Turbocharger.</li> <li>* Measure exhaust Back pressure. Should not exceed 3" of Hg. Take corrective action as required.</li> </ul>
<b>ENGINE INSPECTION &amp; ENGINE TESTING</b>	<ul style="list-style-type: none"> <li>* Check lugs of Battery cable, for tightness.</li> <li>* Ensure Battery charging</li> <li>▪ Run Engine, till coolant attain minimum operating temp. 80° C).</li> <li>* <b>Record all Parameters in Log Book.</b></li> </ul>	<ul style="list-style-type: none"> <li>▪ Repeat A Check</li> <li>▪ Check condition of Battery</li> <li>▪ Clean Battery Leads</li> <li>▪ Secure all connectors in Engine Electrical system.</li> </ul>	<ul style="list-style-type: none"> <li>▪ Repeat B Check</li> <li>▪ Check Valve lashes &amp; adjust, if required</li> <li>▪ Check AVMs condition. Change if required</li> </ul>	<ul style="list-style-type: none"> <li>▪ Repeat C Check</li> <li>▪ Tighten all clamps &amp; mounting nut bolts.</li> <li>* Check Coupling bolts.</li> </ul>



**Note : The daily checks can be performed by the operator whereas weekly (and above) are to be done by Specialist only.**

**\* Belt to be checked by skilled service engineer only**

## SERVICE DETAILS:

### 1) ROUTINE SERVICE - DAILY (A-check)

1. **Check** engine oil level, top up is necessary.
2. **Check** fuel level in fuel tank and secure the tank cap.
3. **Check** coolant level in radiator & top up if necessary and secure the cap.
4. **Check** for leakage of coolant, fuel and lube oil and rectify.
5. **Check** if all instruments are functioning.

### 2) ONE TIME SERVICE

#### Commissioning Service

This service is to be performed only once at the time of commissioning the engine.

### 3) REGULAR SERVICING ACCORDING TO THE MAINTENANCE SCHEDULE

In the chart indicating Maintenance Intervals the type of service to be performed are specified according to the hours of operation and the fuel consumed. The Service intervals prescribed in the chart are valid for normal operating conditions. Abnormal or extreme operating conditions would necessitate servicing at shorter intervals.

## RECORDING OF SERVICES

The maintenance jobs which have been carried out at specified intervals are to be recorded in the OPERATOR'S SERVICE BOOK. As per the chosen basis for servicing, the actual hours of operation or the amount of fuel consumed are to be entered in the appropriate columns.

## COMMISSIONING SERVICE

At the time of commissioning the Equipment and before the engine is put to operation, please

ensure that the following service has been carried out. This service should be carried out by the authorised dealer.

1. **Check** coolant level in radiator, top-up if necessary and secure radiator cap.
2. **Lubricate** with the oil can. Controls to the fuel injection pump.
3. **Check** oil level in FIP and governor and top-up if necessary.
4. **Check** the oil level in the sum and top-up if necessary.
5. **Clean** air cleaner.
6. **Check and tighten if necessary :**

Delivery valve holders, injection pressure lines, leak-off lines, oil sump screws, heat exchanger bolts, oil pressure connection on heat exchanger, coolant temperature transducer on upper cooling line, exhaust manifold, push rod cover, timing gear cover, cylinder head cover, air filter mounting, air hose connection, engine and radiator mountings, radiator hose connection, fuel filter mounting bolts, alternator and starter motor.

7. **Check** connections of starter motor and alternator and tighten if necessary.
8. **Check** for leakage of fuel at :

Fuel lines, pre-filter on feed pump, fuel filter. 9. **Check** for leakage of engine oil at :

Oil sump, cylinder head cover, push rod cover, timing gear cover, oil filter, heat exchanger and oil pressure connections.

10. **Check** for leakage of coolant at :

Radiator (check cap), water pump, thermostat, hose connections and coolant temperature transducer.

11. **Remove** and clean engine breather cap strain in kerosene oil and by blowing air in reverse direction and refit.

12. **Tighten** cylinder head nuts (with engine warm) and in correct sequence. Check valve clearance and adjust if necessary. (This is to

be done after 5 to 10 hours of every remounting of cylinder head).

13. **Check** condition of alternator and fan belt and adjust tension, if necessary.

14. **Start engine and check :**

- (a) Engine idling and running (watch for any unusual noise)
- (b) Alternator and regulator operation (watch battery charging indicator lamp)
- (c) Oil pressure
- (d) Water temperature.

## MAINTENANCE SCHEDULE FOR STARTER AND ALTERNATOR

PRODUCT	DAILY MAINTENANCE	WEEKLY MAINTENANCE	MONTHLY MAINTENANCE	QUARTERLY MAINTENANCE
6M-14 starter (Lucas make)	Check tightness of Battery and circuit connections  Check visually battery electrolyte level.	Check battery specific gravity.	Top up *DE Shield reservoir with Multi grade 20W40 (API-CD) oil.	Remove **CE cover and smear Molybdenum Sulphide grease over CE bearing pin.  Clean the brush dust inside the starter and secure CE cover properly. Apply Elcoprine sealing compound around cover.  Check the tightening torque of the fasteners.  Check the tightening torque of the fasteners.  Check the smoothness of ball bearings.
A115 Alternator (Lucas TVS make) No. 322000	Check belt tension  Check tightness of output & WL terminal connections		Check battery terminal voltage while charging.  Clean and apply petroleum jelly for battery terminals.	

\*\*DE - Drive end  
\*\*CE - Commutator end

### GENERAL INSTRUCTIONS :

- Ensure the panel switch is not stickily.
- Do not crank the starter more than 20 seconds
- If the clutch slip noise is heard, do not try to start the engine.
- Check whether Warning Lamp 'goes off' when the engine is started.
- Before starting the engine, check warning Lamp glows when the engine is started.
- Ensure the correct wattage of Warning Lamp. The wattage of the bulb to be 2.2 Watt.



## Section 6

# LUBRICANTS, FUELS & COOLANT

**Providing and maintaining an adequate supply of clean, high quality fuel, lubricating oil, grease and coolant in an engine is one way of insuring long life and satisfactory performance.**

### FUELS

HS-Diesel oils recommended for use on S 3.8 G series diesel engines conform to following specification.

IS 1460

DIN 51601 or equivalent

Do not mix kerosene with diesel as a cost reducing measure. This mixture has poor lubricating properties. It causes faster wear and tear of fuel injection equipment components under normal operating conditions.

Cleanliness of the fuel influences the efficiency and life of the fuel filters and fuel injection equipment. It is, therefore, more economical to fill clean fuel into the tank. All precautions should be taken to ensure that no dirt enters the tank while filling the fuel.

#### Special precautions if fuel is stored in drums.

1. Do not roll the drum to the engine to pump the fuel into the tank. The drum must be kept standing for at least 24 hours to allow impurities to settle down.
2. When placing the suction pump into the drum see that approximately 15 cm distance is left between the bottom of the drum and the end of the suction pipe, so that sediments (dirt, mud, water) are not sucked in.
3. The suction bore at the end of the suction pipe must be protected by a fine mesh sieve.
4. Put a piece of clean flannel cloth into filter opening.
5. Keep suction pump free from dust. Do not place it on the floor.

To ensure that clean fuel is always available for refuelling it is advisable to set up a large tank (containing about 500 to 1000 liters, according to requirement) at a suitable place, thus establishing

a small and cheap private filling station. Before refilling, drain off the sediments through the drain cock provided at the bottom of the tank.

If the diesel fuel has been split, the affected spots can be cleaned by using a mixture of 25-50% vinegar and 75-50% water (depending on the degree of contamination). This will help to get rid of the offensive odour.

At very low temperatures fluidity of diesel may become insufficient to paraffin separation. It is therefore, necessary to mix supplementary fuel with summer or winter grade diesel. The supplementary fuel to be used is kerosene or aviation turbine fuel.

Ratios for mixing of supplementary fuel and diesel are shown in table :

Ambient temperature °C	Percentage	
	Summer grade diesel	Supplementary fuel
up to 0		100
0 to -10		70/30

Ambient temperature °C	Percentage	
	Winter grade diesel	Supplementary fuel
up to -15	100	0
-15 to -20	70	30
-20 and below	50	50

Care should be taken that diesel and supplementary fuel are thoroughly mixed before filling.

### COOLANTS

Presence of dirt in coolant chokes up radiator, water passages in cylinder head and crankcase, thereby causing overheating of engine.

To prevent rust formation and freezing of water inside water jackets of crankcase and cylinder head mix antifreezing agent as recommended.

Percentage of antifreeze agent in cooling system which depends upon ambient temperature is shown in following table :

<b>Up to Ambient temperature °C</b>	<b>Heavy Duty Water</b>	<b>Antifreeze agent</b>
-40	50	50

### **Recommended Antifreeze Agents**

Volvoline

It is recommended that the entire cooling system should be drained and filled with fresh mixture of antifreeze agent and water in the ratio of 50:50 for ambient temperature of up to -40 C. Coolant should be drained and replenished in the recommended ratio every two years Or 1500 hrs which ever is earlier.

### **LUBRICANTS**

Please use only recommended brands of oil for getting optimum engine performance and life. There are several brands of lubricating oils in the market. Only some of these oils have been approved by us for use in S-3.8-G engine. The lubricating oils approved by us is volvoline which conform to following specification :

SAE API CF4 Engine Oils

The recommended oils have certain vital properties that help to reduce the wear and tear of the components. We have tested these oils for thousands of hours in similar conditions your equipments is likely to encounter. The optimum period of use for each oil filling has been carefully determined. Therefore, always use only the approved oil. Strictly adhere to the engine oil and

oil filter cartridge change period specified by us. The engine oil should be replace by at every 500 hrs along with the engine oil filter cartridge and 'O' ring.

The oils of two different specification should not be mixed.

Do not use recycled oils even for topping up. They have already lost their vital properties. The adverse effect using reclaimed oil will not be seen immediately, but the life of the components will be greatly reduced.

It is difficult to recognise a poor quality oil. Therefore, buy the recommended brands in sealed tins only from authorised dealers.

The oil change periods recommended in maintenance schedule should be adhered to.

Recommended grades of engine oils conforming to SAE API CF4 and MB 228.1 specifications and grade selected according to range of ambient temperatures are to be as given below :

### **Coolant**

Coolant reservoir is to be filled externally, upto 'L' level with same coolant concentration.

Coolant is recommended to prevent corrosion of engine & radiator and to increase boiling point of water. An ethylene glycol (type JIS K 2234-94, class 2)

During initial fill of coolant in the engine 5 liter ethylene glycol is to be mixed with 5 liter of soft water. And the mixture is to be poured in the radiator. Please note that colour of the ethylene glycol supplied along with engine is green.

50:50 water to ethylene glycol mixture is to be used for top up.

Change Coolant during every D Check.



## CLEANING OF COOLING SYSTEM

Wait until the temperature falls below 50°C before draining.

### Draining procedure

Drain the cooling system. Use a drain pan with a capacity of 20 litres.

**Prolonged and repeated contact with used antifreeze can cause skin disorders or other body injury.**

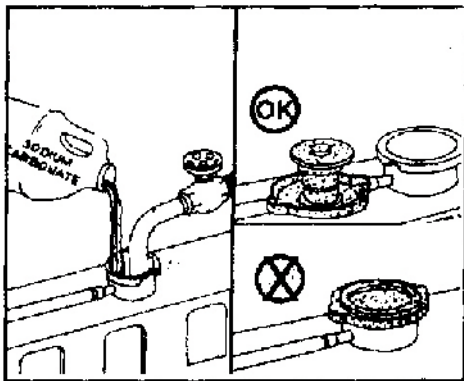

### System flushing & filling

Mix 0.5 kg of sodium carbonate with water for preparing flushing mixture.

Fill the system slowly.

Wait 2 or 3 minutes to allow air to be vented and add mixture to bring the level to the top.

Do not install the radiator cap.

### Operating procedure

Operate the engine for 5 mins. with the flushing mixture temperature above 80°C.

Shut the engine off and drain the cooling system.

### System filling

#### RECOMMENDATIONS

Quality of Lubricating oil is one of the key drive factors to decide the performance, durability and total cost of operation of diesel engine. Hence we have always been recommending the best available/suitable engine oil to be used in our engine.

Cummins strongly recommends the use of SAE 15W40 lub oil with API, CF4 classification for all Cummins engines to get the various advantages and optimum performance from the engine.

This oil should have a minimum TBN of 10.5.

#### NOTE

Above limits are for reference only and exact applicable values can be obtained from the respective oil manufacturer against specific brand of oil.

The responsibility of meeting oil quality lies with the oil manufacturer and Cummins will not be responsible for problems occurring on engines due to poor quality of oil.

If in doubt about the lub oil quality, contact lub oil manufacturing company and get the oil analysed in laboratories.

#### CAUTIONS

Beware of spurious oils in the market. Bad quality of lubricating oil is detrimental to engine performances. Hence, oil should always be procured from the original manufacturer or the authorized distributors.

Lubricating oil to be used on the engine must meet all the qualities as per manufacturer's specifications. Cummins recommends audit checks of fresh engine oil to ensure the quality of oil. Facility to check suitability of oil for using it in the engine is available with Cummins Service Network.

Do not intermix different brands of oil since two different brands may not be compatible with each other. It is therefore recommended that the brand which is used for initial fill, should only be used for top-up.

However, in case of non-availability of specific brand, different brand of oil may be used at the time of oil change. In that case, drain all the existing oil and flush the lub oil system with new brand oil and then charge the system with new brand oil.

#### COOLANT RECOMMENDATIONS

Cummins recommends, use of Premix Coolant, for engine cooling. This is 'Ready to Use' type Coolant & is available



in 5 Litre Can. Coolant is 'Ethylene Glycol' (Type JIS K 2234-94, Class 2)

Coolant is recommended to prevent Corrosion of Engine & Radiator. It also broadens the Operating Temperature range by Lowering the coolant freezing point & by raising it's boiling point.

**NOTE**

**This Premix Coolant Do-Not require, any addition OR mixing of Raw Water. Coolant is to be used, directly from Coolant Can (Ready To Use)**

**Coolant recovery Bottle is to be filled externally, with Coolant. Radiator is to be filled slowly, upto bottom of Fill Neck.**

**Check Coolant Level Daily, before starting Gen-set.**

**CAUTION**

**Do-not add cold coolant to hot engine. Engine castings can be damaged . Allow engine to cool below 50 °C, before adding Coolant.**

**Do-Not remove Cap, Radiator, from hot engine. Allow engine to cool below 50 °C, before adding Coolant. Failure to do so, can result in personal injury from steamy coolant.**

**Do-Not use sealing additives, to stop leaks in the cooling system. This can result in coolant system plugging & inadequate coolant flow, causing, engine to Over heat.**

**Operating procedure**

Again operate the engine for 5 mins. with the water temperature above 80 °C

Shut the engine and drain the cooling system.

If the water drained is still dirty, the system must be flushed again until the water is clean.

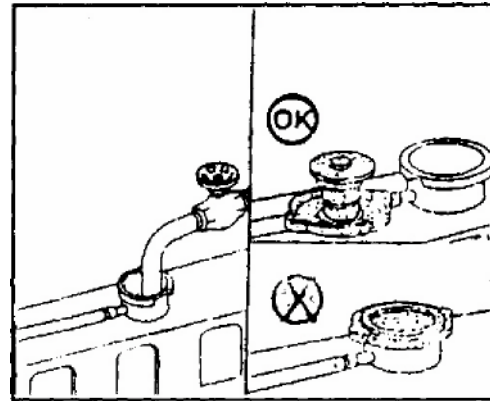

**TIGHTENING OF CYLINDER HEAD NUTS**

After every remounting of cylinder head, the cylinder head nuts should be tightened in the sequence as shown in the figure. Clean and oil threads on the collared nuts as well as on the cylinder head studs prior to figment. Tighten evenly in three stages till the maximum torque is achieved. A special socket must be used for tightening the nuts below the rocker arm shaft. Then adjust intake and exhaust valve clearances to specified valve.

Run the engine for approximately one hour, thereafter, retighten cylinder head nuts and recheck valve clearances. Repeat the above procedure after 5 to 16 hrs. of operating everytime a cylinder head is refitted. Always fit a new cylinder head gasket and ensure that the marking "TOP" is towards the cylinder head side.

For removing the cylinder head, loosen nuts in the reverse order of tightening sequence.

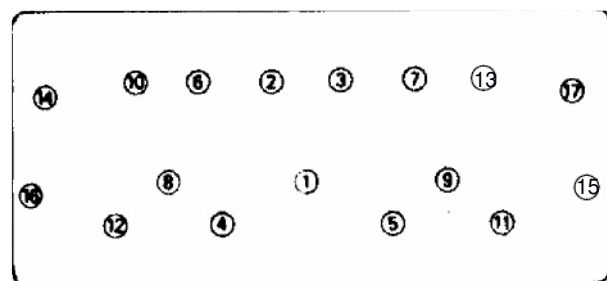

Cylinder head nut tightening sequence

## Section 7

### CHECKING VALVE TIMING

1. Attach suitable graduated disc to the vibration damper pulley and mark 'BDC' position on the periphery of the vibration damper pulley by turning crankshaft by 180° from 'TDC' position. Fig. 7-1.
2. Remove cylinder head cover.
3. Adjust valve clearance (inlet 0.2 mm; outlet 0.3 mm). Eliminate No.1 inlet valve clearance by inserting a 0.2 thick feeler gauge between valve tip and rocker. Fig. 7-2.
4. Turn crankshaft to bring No. 1 piston to TDC. (compression stroke). In this position, valves of the No. 6 cylinder will be overlapping.
5. Attach magnetic stand with dial gauge to the cylinder head in such a way that the plunger of the dial gauge rests on the spring retainer of the 1st cylinder inlet valve with a preload of about 10 mm. Position plunger on the spring retainer as away as possible from the centre to avoid fouling of the rocker. Adjust dial gauge pointer (bigger) to zero and also note down the reading of the smaller needle.
6. Turn crankshaft clockwise slowly through 360° to bring No. 1 piston just to TDC II position (end of the exhaust stroke). Do not turn crankshaft in anti-clockwise direction to adjust TDC position.

 **NOTE : Before reaching the TDC position, preloaded plunger of the dial gauge will move along the spring retainer of the valve. Note down dial gauge reading when the TDC position is just reached.**

7. The difference between dial gauge readings will give valve lift. The valve timing is correct if the lift indicated by the dial gauge is within the specified value of 0.8+ 0.2 mm.
8. The valve timing can be counter checked by turning the crankshaft clockwise further by

180° in order to bring No. 1 piston to BDC

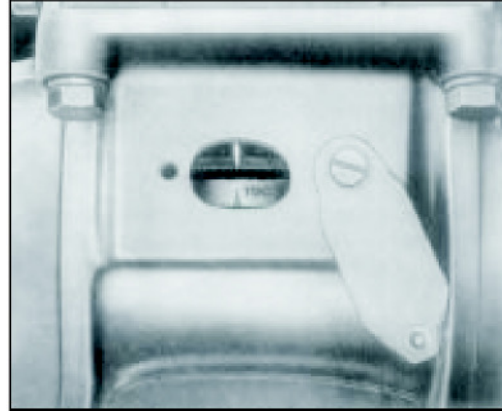

Fig. 7-1



Fig. 7-2

II position (End of the suction stroke). Note down the dial gauge reading when the BDC position is just reached. The difference between this and the initial dial gauge reading will give the valve lift in this position. The timing is correct if the lift is within the specified value of 3.9+ 0.3 mm.

9. Valve timing can also be ascertained by checking the lift of the exhaust valve. To be doubly sure, it is preferable to check the lift of the exhaust valve of No. 6 cylinder. The valve lift at BDC I (end of power stroke) and TDC II (end of exhaust stroke) should correspond to specifications.
10. Valve lift readings beyond the specification suggest wrong valve timing possibly on account of worn out crankshaft - camshaft



gears/ damaged woodruff keys / mismatched timing gears (i.e. '1' mark on crankshaft gear tooth is not matched with '3-3' mark on camshaft gear.

11. Identify the defect and rectify.

### REMOVAL OF FUEL INJECTION PUMP

(Linkages, oil line etc. disconnected)

1. Disconnect accelerator linkage.
2. Remove timing gear housing plug,
3. Unscrew coupling nuts of injection lines with a suitable spanner or socket, 000 589 0509 from fuel injection pump. Fig. 1.
4. Unscrew fuel line from feed pump and fuel injection pump.
5. Remove high pressure lubrication oil line between F.I.P. & oil filter.
6. Unscrew the screws holding fuel injection pump on timing gear housing Fig. 2 and remove fuel injection pump. Fig. 3.  
(Preferably align the timing mark on F.I.P. gear & pointer before removal of F.I.P.)

### INSTALLATION OF FUEL INJECTION PUMP AND TIMING ADJUSTMENT

1. Remove clutch housing inspection cover and rotate crankshaft till 20 deg mark (yellow) on flywheel coincide with pointer. Fig. 4. Ensure that piston No. 1 is in compression stroke by the feel of the push rods of No.1 cylinder which should be free.
2. Install fuel injection pump with new gasket

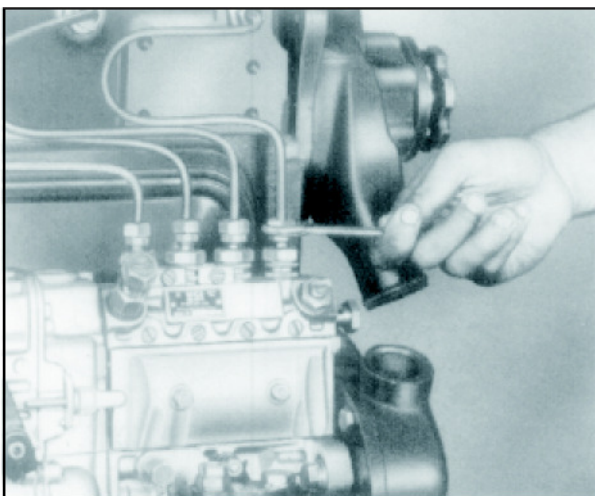

Fig.1

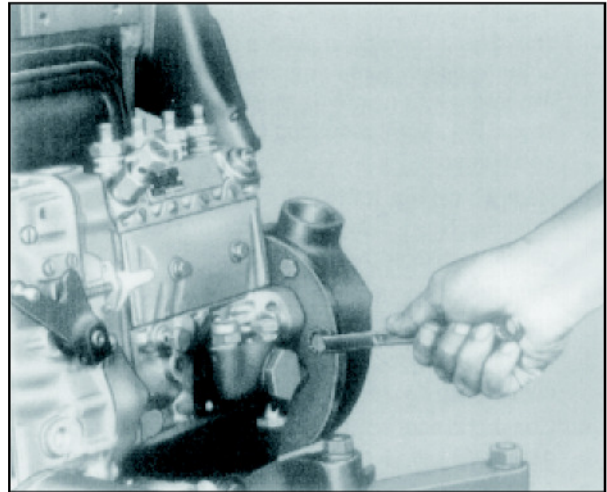

Fig. 2

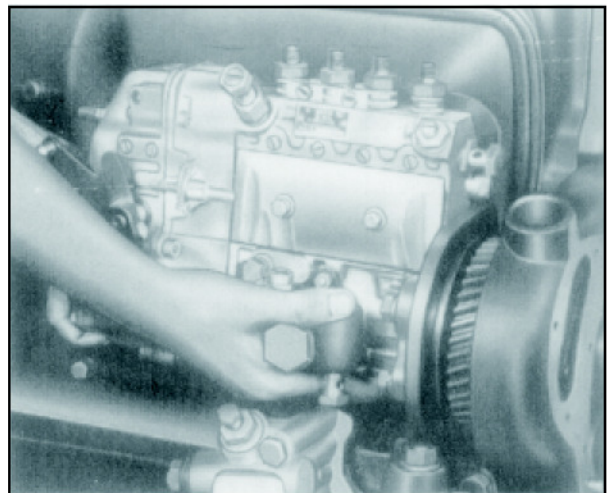

Fig. 3



Fig. 4

into timing gear housing in such a manner that the tooth of the injection pump gear marked with a notch is in alignment with pointer in timing housing smaller cover. Fig. 5. Fit mounting bolts with spring washer and tighten.

3. Remove clamps for Nos 1 and 2 valve holders. Unscrew No. 1 delivery valve holder and remove delivery valve spring and peg. Fig. 6.
4. Refit delivery valve holder without delivery valve, spring and peg and tighten to specified torque.
5. Install swan neck tube, 312 589 0223, on this holder. Fig. 7
6. Connect diesel bowl pipe to the fuel injection pump gallery. Fig. 7
7. Set control lever to full throttle position.
8. Loosen mounting bolts of the fuel injection pump to intermediate plate and swivel pump towards engine when fuel should start flowing freely through swan neck. Fig. 8. Swivel pump away from the engine. Fuel flow should completely cut off. Fig. 9. If this condition does not exist, either timer is faulty or crankshaft gear mismatched or the fuel injection pump is not properly timed to the engine camshaft. If the pump is correctly mounted, proceed as follows:

Swivel fuel injection pump towards engine, when the flow of fuel will resume. Now swivel

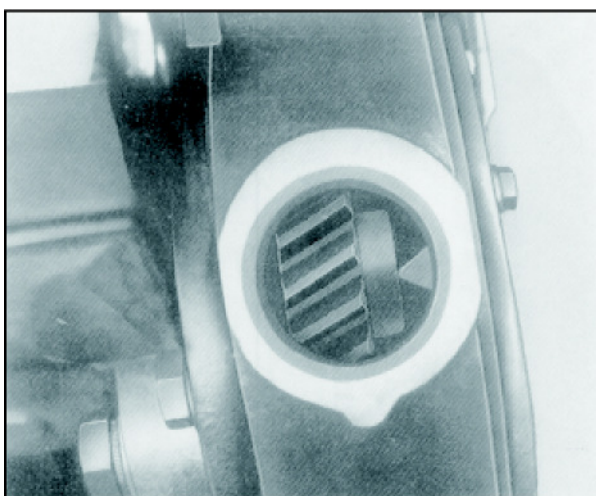

Fig. 5

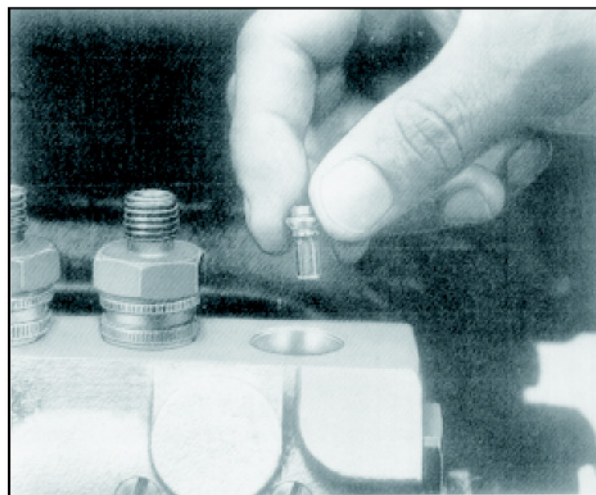

Fig. 6

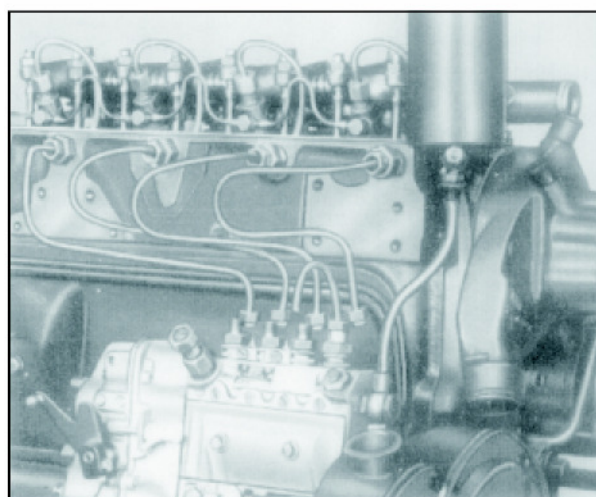

Fig. 7

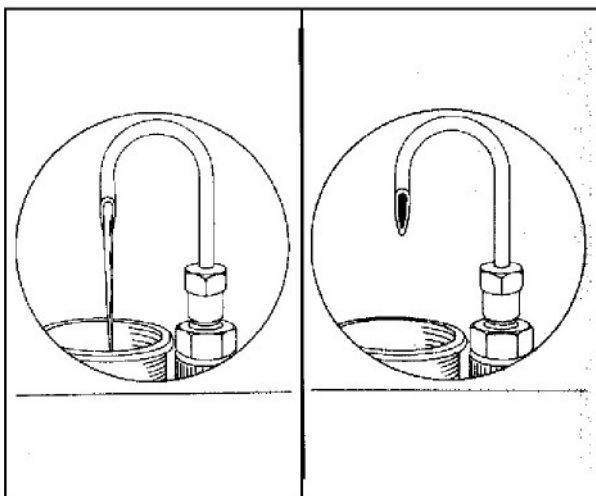

Fig. 8

Fig. 9



pump away from the engine slowly when the flow of fuel decreases. Fig. 10 and ultimately the flow nearly stops, giving a drop in 15 to 20 seconds. Fig. 11. Check flywheel position once again to make sure that the yellow mark (18 before TDC) on the flywheel aligns with the pointer.

9. Tighten fuel injection pump bolts (4 numbers) carefully so as not to disturb the position of the fuel injection pump.
10. Turn crankshaft in the reverse direction by approx. 30 degrees. The fuel will start flowing freely. Then slowly turn crankshaft in the forward direction till the fuel flow nearly stops and a drop forms on the swan neck in 15 to 20 seconds.

The position should coincide with 20 degrees before TDC mark on flywheel aligning with the pointer. Fig. 12. This check confirms that the fuel injection timing has been correctly set.

11. Disconnect swan neck and fit back delivery valve, spring and peg after cleaning them. Fig. 13. Tighten delivery valve holder to 4.5 mkg. Fit delivery valve holder clamps.
12. Refit timing gear housing plug and clutch housing inspection cover.
13. Disconnect diesel bowl from the fuel injection pump gallery.
14. Connect fuel hoses to the feed pump and fuel injection pump main gallery.
15. Connect high pressure lines to injection pumps. Tighten cap nuts to 2.5 mkg. Ensure that the high pressure lines are free from tension. If necessary, align high pressure lines with special tools, Part No 312 580 0085.
16. Bleed the fuel system as follows. Unscrew and operate hand primer (up and down strokes) until resistance is felt. Loosen the bleeding screw on the fuel filter and allow air to escape. Operate the primer slowly with the bleeding screw open till bubble free fuel starts flowing. Tighten the bleeding screw. Bleed the fuel injection pump gallery in the same manner and tighten bleeding screw. Operate the hand primer for a few strokes. Check for

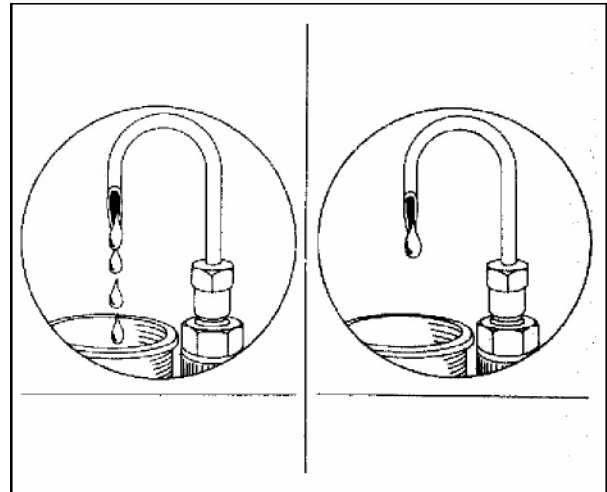

Fig. 10

Fig. 11



Fig. 12

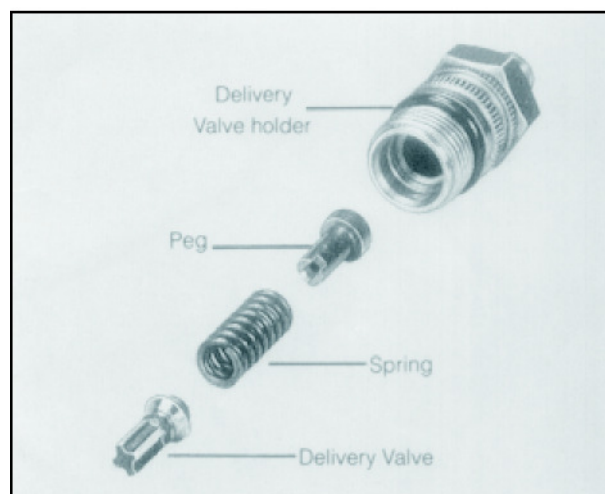

Fig. 13

leakages if any and screw on the hand primer knob fully.

17. Connect accelerator linkage.

**⚠ Caution : Ensure adequate tightness on feed pump fuel inlet banjo to avoid fuel starvation.**

### REMOVAL AND INSTALLATION OF INJECTOR AND PROTECTIVE SLEEVE

#### REMOVAL

- 1 Drain coolant from radiator and cylinder block.
- 2 Remove cylinder head cover.
- 3 Remove clamps holding high pressure lines.
- 4 Loosen the outer screw plugs sealing high pressure lines and remove inner screw plugs holding high pressure line in cylinder head.
5. Disconnect high pressure lines from injectors and delivery valve holders and slide high pressure lines away from injectors.

**👉 NOTE : Do not bend high pressure lines.**

6. Unscrew leak off line banjo bolts along with sealing washer and remove leak off line assembly Fig. 14. Unscrew and remove pressure screw holding nozzle holder to the cylinder head with the help of socket, 000 589 0209. Fig. 15.
7. Remove nozzle holder with puller, 000 589 0119. Fig. 16.
8. Loosen protective sleeve in cylinder head with adaptor, 000 589 0309. Fig. 17.
9. Remove protective sleeve and its sealing ring from cylinder head.

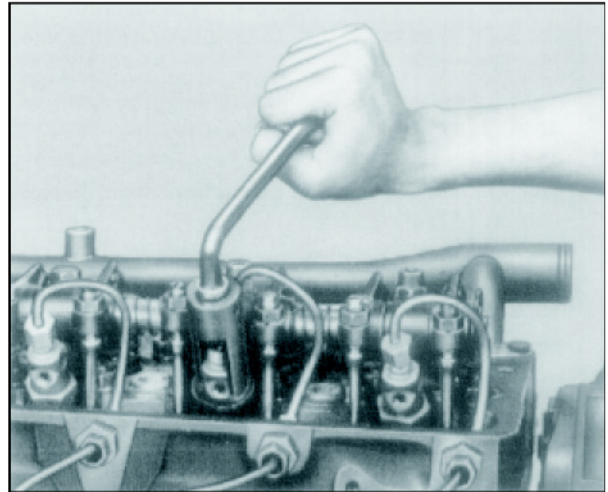

Fig. 15

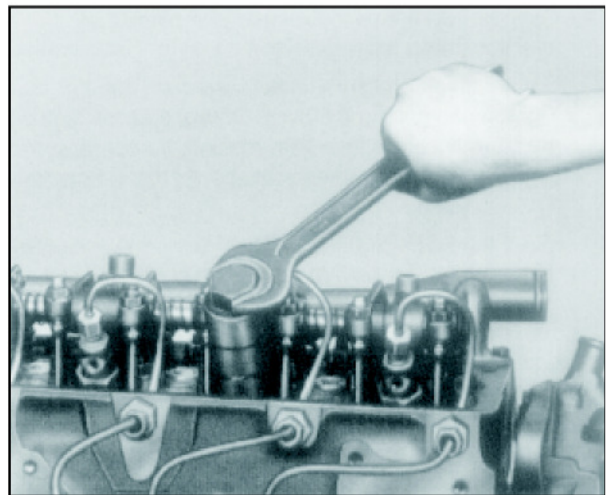

Fig. 16

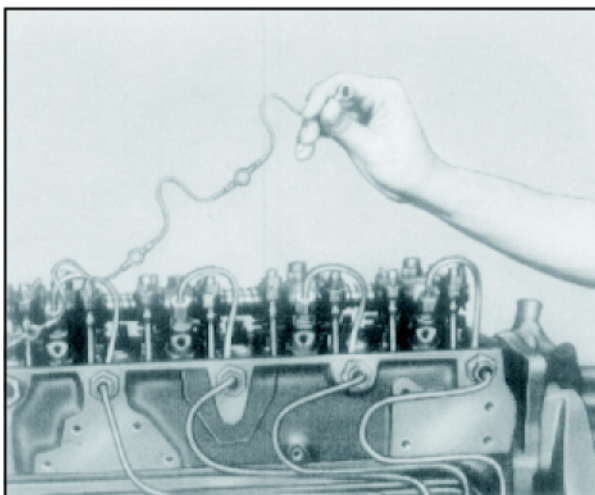

Fig. 14

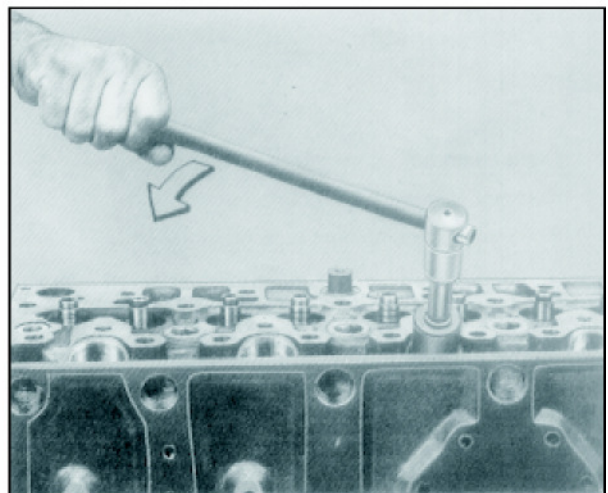

Fig. 17

## INSTALLATION

1. Apply a light coat of grease/oil to new sealing ring and place it in cylinder head. Fig. 18.
2. Screw in protective sleeve into cylinder head with adapter, 000 589 0309 and tighten to specified torque. Fig. 19.
3. Insert new copper washer for the injectors into protective sleeves.
4. Insert injectors into cylinder head after aligning the locating lug of the nozzle holder into slot provided into cylinder head.
5. Screw-in pressure screw for nozzle holder with socket, 000 589 0209 and tighten to specified torque. Fig. 20.
6. Install leak off line with new sealing washers and tighten banjo bolts to specified torque.
7. Connect high pressure line to injectors and delivery valve holder ensuring the pipes are free from tension. If necessary align pipes free of tension with special tool, 312 580 0085. Tighten high pressure lines cap nuts to specified torque. Fig. 21.
8. Screw-in and tighten inner screw plugs into cylinder head.
9. Tighten outer screw plug into the inner screw plug over sealing rings.
10. Fit high pressure line clamps.
11. Install cylinder head covers with gasket.

## INSPECTION OF INJECTION NOZZLES

(Injectors removed)

### 1. CHECKING NOZZLE OPENING PRESSURE

Carefully remove carbon deposits from nozzle. Connect injector assembly to nozzle tester. Depress nozzle tester lever down slowly with pressure gauge connected one stroke per second and read opening pressure when nozzle starts opening. If the opening pressure is too high or too low, disassemble and clean injection nozzle and adjust as required by selecting the adjusting shims. (If the pressure

is too high, use thinner shims, if too low, use

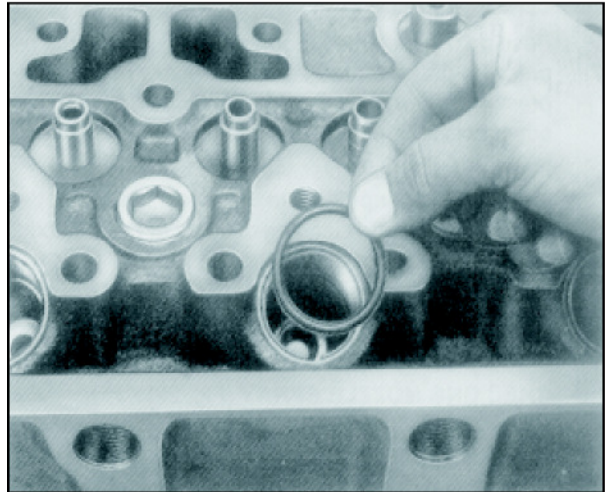

Fig. 18

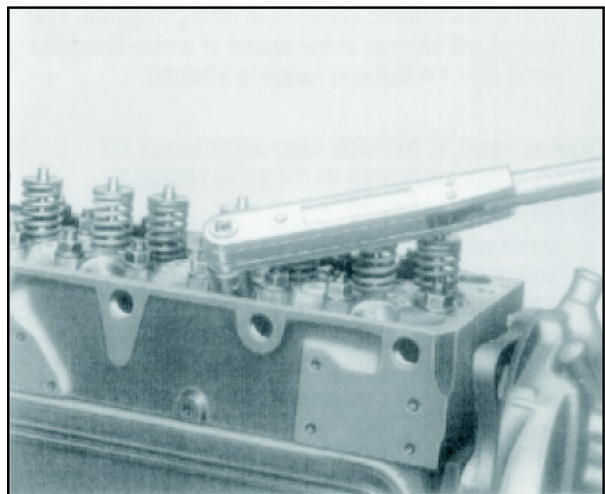

Fig. 19

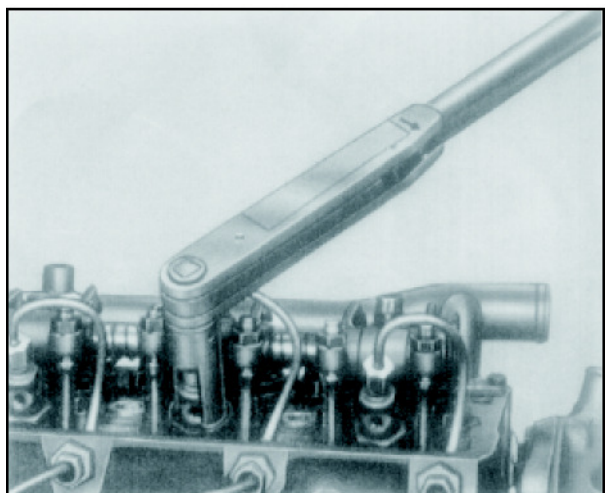

Fig. 20



thicker shims). When testing nozzle, never put your hand under the jet of a spraying nozzle. The jet will penetrate into the skin which is dangerous.

## 2. CHECK NOZZLE FOR LEAKAGE

Push nozzle tester lever down slowly until needle on pressure gauge shows 20 kg/cm<sup>2</sup> below opening pressure. The nozzle is leak proof if no drop comes out of nozzle tip within 10 seconds.

In the event of leak, disassemble injection nozzle and clean as per procedure. If the leak could not be repaired by careful cleaning of seats or nozzle body and nozzle needle, replace nozzle.

(When testing injectors with the pressure gauge in circuit, operate nozzle tester lever slowly as otherwise gauge may get damaged.)

## 3. CHECKING NOZZLE SPRAY (Fig. 22)

Cut off the pressure gauge from the circuit by closing shut off valve. Move pump lever up and down approx. 4 to 5 times per second. The nozzle will then buzz very softly. Atomization is satisfactory when the 4 jet cones have uniform closed contours and are finely atomized. There should be no lateral streams. The presence of small non-buzzing ranges with non-atomized cones is of no significance. The test oil will emerge in the shape of a non-atomized cone until the buzzing range is attained.

## DISASSEMBLY, REPAIR AND ASSEMBLY OF NOZZLE HOLDER AND INJECTION NOZZLE

(Nozzle holder removed)

- 1 Insert nozzle holder in to holder 403 589 00 31 00 and unscrew pressure nut with special wrench 000 589 01 13 00 from nozzle body. Fig. 23.
- 2 Clean nozzle externally and internally in diesel fuel, particularly the middle seat and the ring groove by means of a small piece of wood. Clean injection holes of nozzle body with a cleaning needle from special tool 000 589 00 68 00. Fig. 24.

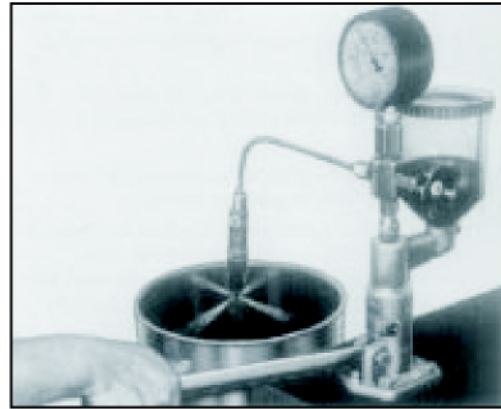

Fig. 21

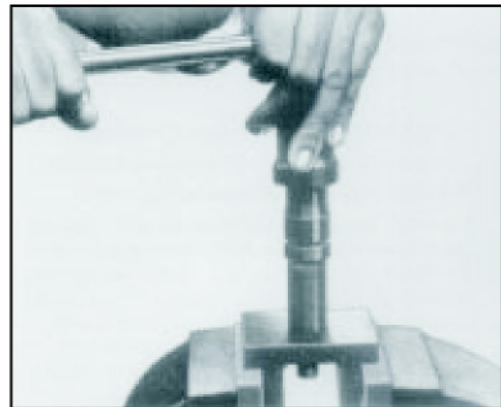

Fig.



Fig. 23

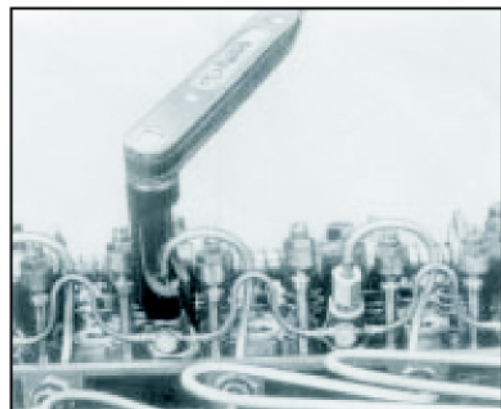

Fig. 24

- 3 Immerse nozzle needle and nozzle body in clean diesel oil and check slide ability by means of drop test.

### DROP TEST

Keep nozzle body vertical, pull out the needle to one- third of its length. It must drop back on its seat by its own weight slowly. If the needle does not slide in body, smear a little mutton allow on it and lap the needle in nozzle body. Do lapping in back and forth and rotary movement of needle in nozzle body. While doing so, the nozzle needle seat should not touch the seat in nozzle body. Wash in diesel and recheck by drop test.

4. Assemble nozzle in the sequence as shown into the nozzle holder taking care to match the locating pins on intermediate disc and screw on pressure screw. Fig. 25
5. Place nozzle holder into holder 403 589 00 31 00.
6. Tighten pressure nut with special wrench 000 589 01 13 00 to specified torque. Fig. 26.

Mark injection pump by the letter "Z" behind the pump designation after the work has been carried out.

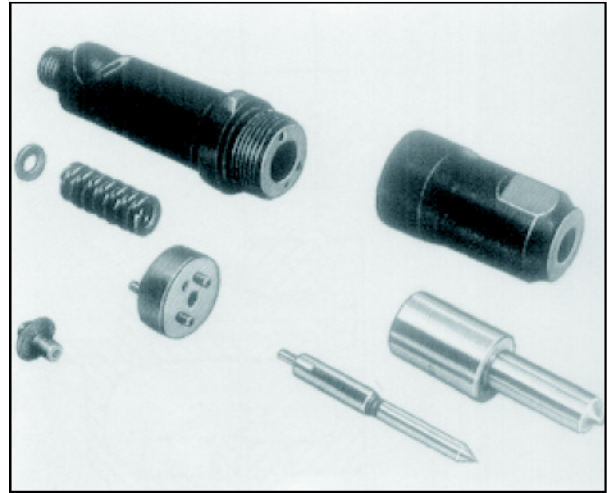

Fig. 25

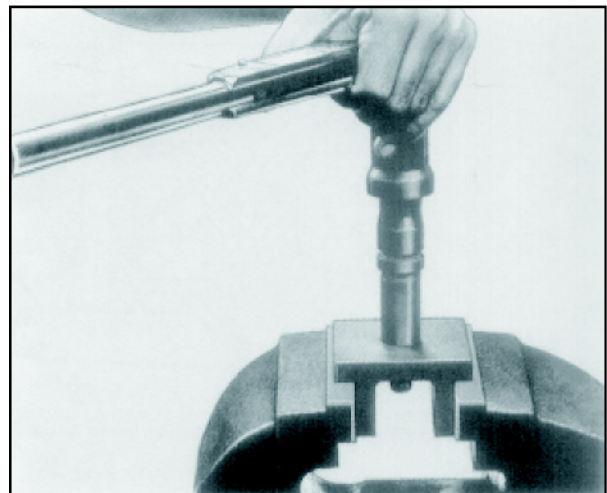

Fig. 26

Fig. 27

## SECTION 8

### TIGHTENING TORQUES

When selecting torque wrench, remember that it should not be subject to torque exceeding three-fourth of its maximum capacity. Before tightening, clean threads and apply a little oil to them.

Description		Torque (Kgfm)	
<b>Engine</b>			
1	Main bearing cap bolts	5 <sup>+1</sup>	*Further
2	Counterweight bolts on crankshaft	3 <sup>+1</sup>	tightening
3.	Connecting rod bearing cap bolts M 15 x 1.5 cap nuts - M14	10 <sup>+1</sup>	by 90° + 20°)
4.	Cylinder head nuts -		
	Tighten cylinder head	1st stage	6
	in 3 stages as per sequence shown on page 22	2nd stage	9
		3rd stage	11
5.	Screw plug in cylinder head		10 to 20
6.	Protective sleeve in cylinder head	M14 x 1	6
7	Nozzle in nozzle holder		8
8	Nozzle holder in cylinder head		7
9	Cap nuts on high pressure lines		2.5
10	Rocker arm support bolts	M12	11
11	Cylinder head cover bolts	M8	2.5
12	Screw plug in crankcase	M18	8
13	Push rod chamber cover bolts	M8	0.4 - 0.6
14	Oil cooler bolts on Cyl. Cr. case	M8	3.5
15	Timing gear housing on crankcase	M10	4.5
16	Timing gear nut (Injection pump)	M14 x 1.5	8
17	Timing gear housing cover	M6	0.8
18	Camshaft center pin (timer on camshaft)		30
19	Vibration damper lock bolt	M24 x 1.5	50 to 55
20	Flywheel mounting bolts	M12	10
21.	Flywheel housing on crankcase		9
22.	Oil pump to crankcase		4
23	Oil pump pressure relief valve		4.5
24	Oil sump screw - M 6		0.5
25	Oil sump screw - M 8		0.5
26	Oil sump drain plug		5 <sup>+1</sup>
27	Screw on water pump pulley hub		3.5
28	Exhaust manifold bolts	M10	3.5
29	Starter motor on clutch housing	M10	5
30	Clamping bolt for alternator	M10	5
31	Nut on alternator pulley	M14 x 1.5	3.5
32	Fuel filter bowl mounting bolts	M12 x 1.5	2
33.	Nuts to banjo union on leak oil line		5
34.	Banjo bolt of leak oil line		2.5
35.	Centre bolt of oil filter housing		6
36.	Oil filter on crankcase	M10	6
37.	Oil pump cover on oil pump	M8	3
38.	Suction pipe on oil pump cover	M8	3
39.	Screw plug oil pressure relief valve	M24	1.5 <sup>+1</sup>



## Section 9

### TROUBLE SHOOTING

I. When Starting Trouble	Cause	Remedy
A) Starter Motor does not operate	<p>Key not inserted properly into main line switch.</p> <p>Battery not in order :</p> <ol style="list-style-type: none"> <li>1. Inadequate charging condition.</li> <li>2. Bad contact.</li> </ol> <p>Starting switch damaged (the parts are loose, the switch does not engage, it is burnt out).</p> <p>Solenoid switch in starter motor stuck.</p> <p>The starter motor terminal or brushes have body contact.</p> <p>Carbon brushes of starter motor are not in contact with the commutator, stuck in their guide broken, oily or dirty.</p> <p>Excessive voltage drop in the lines, damaged lines or loose line connections.</p>	<p>Insert Key correctly.</p> <p>Have battery recharged via an outside source of current.</p> <p>Thoroughly clean battery and cable terminals so that they are bright.</p> <p>Replace starting switch.</p> <p>Have it repaired at authorised dealers workshop.</p> <p>Eliminate body contact.</p> <p>Check, clean or replace carbon brushes.</p> <p>Check starter motor lines and their connections.</p>
B) The armature is turning, but the pinion does not mesh.	<p>Pinion or ring gear damaged, burns visible on the teeth.</p> <ol style="list-style-type: none"> <li>1. Battery insufficiently charged.</li> <li>2. Insufficient pressure of carbon brushes.</li> <li>3. Excessive voltage drop in the lines.</li> </ol>	<p>smoothen burns.</p> <p>Charge battery.</p> <p>Check, clean or replace carbon brushes.</p> <p>Check lines and their connections.</p>
When switching on, the starter armature turns until the pinion is positively connected, and then stops.	<p>Starting switch does not disengage.</p>	<p>Immediately disconnect starting cable at battery or starter motor. Have switch repaired or replaced or have starter motor repaired.</p>
Starter motor continues to operate after the switch has been released.	<p>Pinion or flywheel teeth are very dirty or damaged : release spring is weak or broken.</p>	<p>Thoroughly clean or smoothen burr at the flywheel toothing and pinion, have starter motor repaired.</p>
Pinion does not disengage after the engine has started.	<p>No fuel in the tank.</p>	<p>Refill tank. After filling a tank which has been completely emptied, at first vent the fuel system.</p>
C) Engine does not start although the starter motor is operating.	<p>Engine is too cold. Inadequate venting of fuel system.</p>	<p>Follow the instruction for winter operation. Vent system once more. When doing so, Check the fuel pipes for leaks and the filler for dirt.</p>

## II. During Operation Trouble

	<b>Cause</b>	<b>Remedy</b>
A) Engine fails.	<ol style="list-style-type: none"> <li>1. No fuel in tank</li> <li>2. Fuel filter is dirty</li> <li>3. Leaking fuel pipe.</li> <li>4. Fuel feed pump does not supply fuel.</li> <li>5. Dirty or damaged injection nozzles</li> </ol>	<p>Refill tank. After filling a tank which has been completely emptied. at first vent the fuel system.</p> <p>Clean. Firmly tighten connections. Replace. Have the old pump checked at MICO dealer. Replace nozzles : have old nozzles checked or cleaned by MICO dealer.</p>
B) Engine suddenly starts knocking heavily	Injection nozzle has got stuck.	Remove load from the engine. Repeatedly shift from idling to full load for a short time. If the knocking does not stop, have the entire fuel system cleaned as soon as possible.
C) Some Cylinders fail to operate.	<p>One or more nozzles are not working. Injection pump does not function properly. Broken valve spring at intake or exhaust valve. Nozzles are damaged or the nozzle needle got stuck.</p>	<p>Dismount and check nozzles at MICO dealer's workshop. Get it checked a MICO Dealer's workshop. Replace it.</p>
D) Engine emits dense black smoke.	<ol style="list-style-type: none"> <li>1. Fuel injection pump is not working properly.</li> <li>2. Incorrect fuel injection timing.</li> <li>3. Air filter is dirty. Fuel filter choked.</li> </ol>	<p>Check. if necessary, change and clean them. Have this repaired at MICO authorised service station only. Check and reset the fuel timing. Clean. Replace fuel filter elements &amp; clean fuel filter bowls.</p>
E) Engine output decreases.	1. Lack of water in radiator.	Slowly add cooling water only while the engine is running.
F) Engine overheating.	<ol style="list-style-type: none"> <li>2. Leaking pipes.</li> <li>3. Cooling system is dirty.</li> <li>4. Thermostat is damaged.</li> <li>5. Water pump is damaged.</li> <li>6. V-belt tension is not in order.</li> <li>7. Cylinder head gasket leaks (can be noticed by gas bubbles in the cooling water)</li> </ol>	<p>Retighten pipe connection, if necessary Replace gaskets. Clean Remove. Replace by new over as soon as possible. Have it repaired at CDSS Dealer's workshop. Check Check gasket. When fastening cylinder head again pay attention to the tightening sequence.</p>

**Caution : Immediately put engine Back to idling position and stop it after some minutes !**

**Trouble**

G) Oil pressure suddenly drops.

**Caution : In case of a sudden decrease stop the engine immediately !**

**Cause**

Lack of oil in crankcase.

Line between engine housing and oil filter is leaking.

The drive of engine oil pump or the pump itself is damaged.

If the above-mentioned conditions do not apply, the oil pressure gauge is not working properly or the engine is damaged.

**Remedy**

Refill

Tighten connecting screws.

Dismount pump and have it repaired at a CDSS Dealer workshop.

Loosen connection line from pressure gauge at filter. If oil flows out of the connecting joint while the engine is running, then the oil pressure gauge or the pressure gauge line is damaged and should be replaced. Otherwise, the engine is damaged, which should only be repaired at authorised dealer's workshop.

Find out and eliminate leakage.

H) Oil pressure increases, vapours and moist air escapes through the breather.

There is water in the oil due to leakage in cylinder head or crankcase

I) Engine output drops and it is breathing irregularly.

**Stop engine immediately**

The piston is seized

Lack of oil or inadequate cooling.

Crankshaft or connecting rod bearing are seized. Vaporous and moist breathing of engine.

Lack of oil.

There is water in the oil due to leakage.

J) Trouble with alternator and regulator.

Battery is not charged.

Defective regulator or alternator.

Brushes are not in contact with the commutator, they get stuck in their guides, are worn out, broken, oily or dirty.

Commutator dirty or oiled up.

Commutator worn out.

Loose or damaged lines.

Replace piston, if necessary, re-bore/hone cylinder at CDSS Dealer workshop, Replace bearing, check crankshaft.

Get complaint attended by CDSS Dealer's workshop.

Have it repaired at an **authorised dealer's workshop.**

Check, clean or replace brushes.

Clean commutator.

Smoothen and recut commutator.

Repair or replace lines, tighten connections.