

# S-Pixie QRP Kit

---

## Student Manual

Revision V 1-0

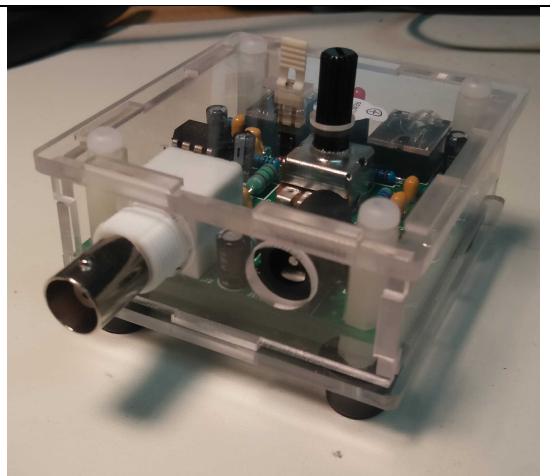
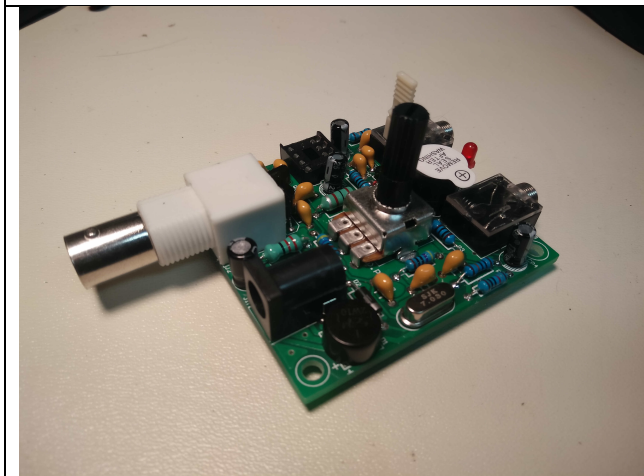

## Introduction

The Pixie 2 is a small, versatile radio transceiver that is very popular with QRP (low power) amateur radio operators the world over. It reflects a history of contributions from amateur radio operators looking to build the simplest transceiver possible. At its core it is a crystal controlled (single frequency) sub 1-Watt QRP CW transceiver. One of the most impressive features of the Pixie 2 besides its simplicity, are the modification possibilities such as operating at a wide range of RF frequencies.

In this guide, the version we will be building is the S-Pixie as designed by Jason BG2XNN of LXQQFY.com in China. Jason has taken the original Pixie design and produced a kit that is available online via his website <http://www.lxqqfy.com> as well as a number of resellers on eBay.

## What you will need

Kit building is meant to be time enjoyed and not a race to the finish. While it is possible to put this kit together in two hours, take the time to enjoy the experience. Patience comes in because you are working with small components. Here is a list of tools required:

Tools	Comments
Soldering Station	Hakko FX888 or Weller WES51 equivalent
Solder	Standard 60/40 Rosin Core
Solder wick	Flat copper braid used for desoldering
Desoldering pump / Solder Suckit	Alternate method for desoldering a component
Digital Multimeter	Verify the values for various components before installing
Small Phillips Screwdriver	Do not use one with dull/chipped tip
Board Vise	Holds the circuit board at various angles while soldering components
Magnifier Headset	Helps to see what you are soldering. Many small components with small markings
Small Flush Diagonal cutters	For nipping leads off of components once solder. Use a quality tool.

## Theory and Design

The S-Pixie design consists of four sections; oscillator, power amplifier/mixer, low pass filter, and audio amplifier.

### Oscillator

A 9-12 VDC power source is connected to J1, an Antenna to J2, a Morse CW key to J3, and a speaker to J4. When power is applied to J1, Q1 and X1 plus surrounding passive components are part of a continually running Colpitts oscillator with a 7030 KHz signal at the emitter of Q1. Running the oscillator continuously assures frequency stability.

### Receive Mode and Mixer

When J3 is open (Morse CW key not keyed), the radio is in receive mode with Q2 and surrounding passive components serving as a Mixer. The mixer takes the signal from the Colpitts oscillator capacitively coupled (C4) into the base of Q2 and mixes it with the signals received on it's collector. The Q2 collector is capacitively coupled (C2) to a low pass filter (C5, L2, and C6) and then to an Antenna connected at J2. The frequency difference emerges from the Q2 emitter at audio frequencies and is sent to the Audio amplifier (U1) and in turn to a speaker connected to J4.

### Transmit Mode and Power Amplifier

When J3 is closed (Morse CW keyed), the radio is in transmit mode. Q2 and surrounding passive components serve as a Class C Power Amplifier taking the signal from the Colpitts oscillator capacitively coupled via C4 into the base of Q2 and amplifying it. The amplified signal at Q2 collector is capacitively coupled (C2) to the low pass filter and out the Antenna (J2.)

## Preparation

### Inventory

Start within inventorying all parts. It is not uncommon for kits to include extra resistors or capacitors. Be sure to verify values of all resistors and capacitors with charts and/or multimeter given the markings can be quite small.

Resistors (1/4 Watt)		Capacitors (Ceramic)		Capacitors (Electrolytic)	
R1	47 K	C1, C10	0.1 uF (104)	CP1	100 uF / 16V
R2	33 K	C2, C4, C8, C11	10 nF (103)	CP2, CP3, CP4	10 uF / (16V
R3	1 K	C3, C7	100 pF (101)		
R4	470 ohm	C5, C6	470 pF (471)	Inductors	
R5, R8	10 K	C9	47 nF (473)	L1	22 uH (Red,Red,Black,Silver)
R6	100 K			L2	1 uH (Brown,Black,Gold,Silver)
R7	10 ohm			L3	100 uH (Brown,Black,Brown,Silver)
Transistors		Assorted		Diodes	
Q1	9018 Triode	U1	LM386 Audio Amp	D1	2W10 Bridge Rectifier
Q2	8050 Triode	Y1	7.030 Mhz Crystal	D2	1N4001
		W1	47 K Var Resistor	D3	1N4148
		PCB		D4	LED
		Acrylic Case			
		Buzzer		Connectors	
		51 Ohm Res (Dummy Load)		J1	DC Jack
				J2	Antenna (BNC)
				J3	Key (3.5 mm)
				J4	Speaker (3.5 mm)
				J5	Pin & Jumper Cap

## Approach

Which components should I solder first? The table below is the recommended order of installation.

1. Resistors	11. Phone Jack
2. Inductors	12. Key Jack
3. Diodes (Signal and Rectifier)	13. Power Jack
4. Ceramic Capacitors	14. Antenna Jack
5. Crystal oscillator	15. Buzzer
6. IC Socket	16. Variable Resistor
7. Electrolytic capacitors	17. Jumper
8. Transistors	18. IC into socket
9. Bridge Rectifier	19. Case
10. LED	

## Before you solder it

Trust but verify. Before soldering each component confirm the components value and the correct location it should be soldered onto the board. Especially important when it comes to your first component verifying you are soldering it on the correct side of the printed circuit board. Components sit on the silkscreened side with their leads inserted into the through holes and soldered on the other side. Even experienced kit builders make the mistake of putting the first component on the wrong side of the board.

## Soldering

Main thing to remember when soldering is not to use too much solder, to use enough heat, and to try to get it right the first time. These kits are fairly robust, so it is not too serious if you need to repeatedly solder the same pad. That being said, it is preferable to only do it once. If you must resolder a components just use solder wick to keep the board tidy and to reduce the risk of unintentional shorts.

What also helps reduce unintentional shorts is use a quality flush diagonal cutter when nipping leads off of components once they are soldered. You will get clean close cuts to the board with out leaving "tails." Also be sure to account for all leads nipped to insure no pieces are either on the board or on your bench and risk a possible short circuit.



## Crystal, IC Socket, Electrolytic Capacitors

Next we solder the crystal. Going forward we need to be conscientious of components that require installation in a particular orientation. Note the IC socket has a notch on one end. Insure the notch is aligned with the silkscreen silhouette on the board. For electrolytic capacitors take note the polarity orientation is correct when soldering. The negative lead (which is the shortest) goes through the shaded side of the silkscreen silhouette.

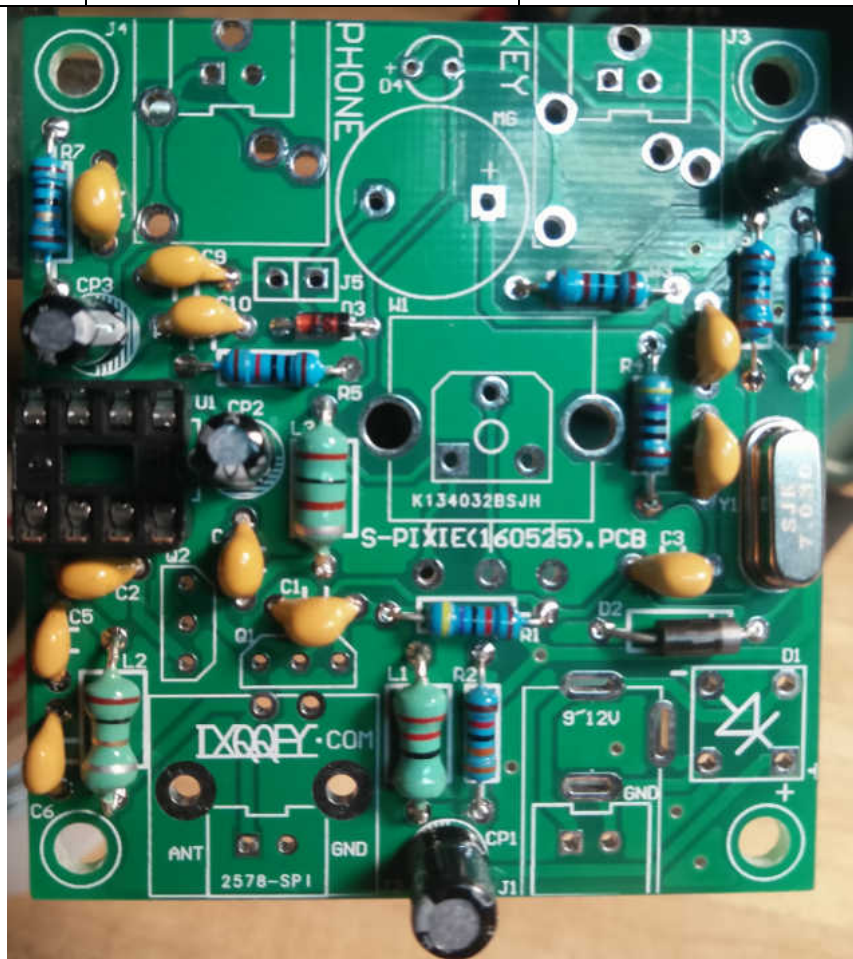
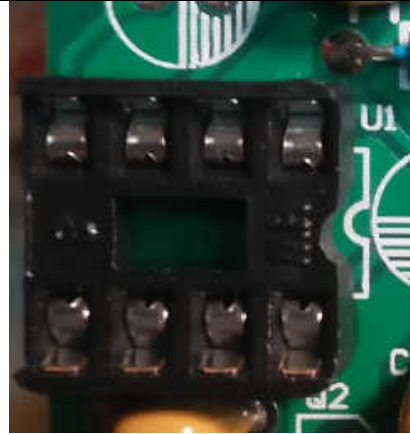

## Transistors, Bridge Rectifier, LED

As with the previous section, be conscientious of the orientation of each of these components. For transistors, insure the flat side is aligned with the flat side of the silhouette. For the bridge rectifier take note of the area labeled + and – on both the rectifier and the silhouette. For the LED, insure the flat side is aligned with the flat side of the silhouette.

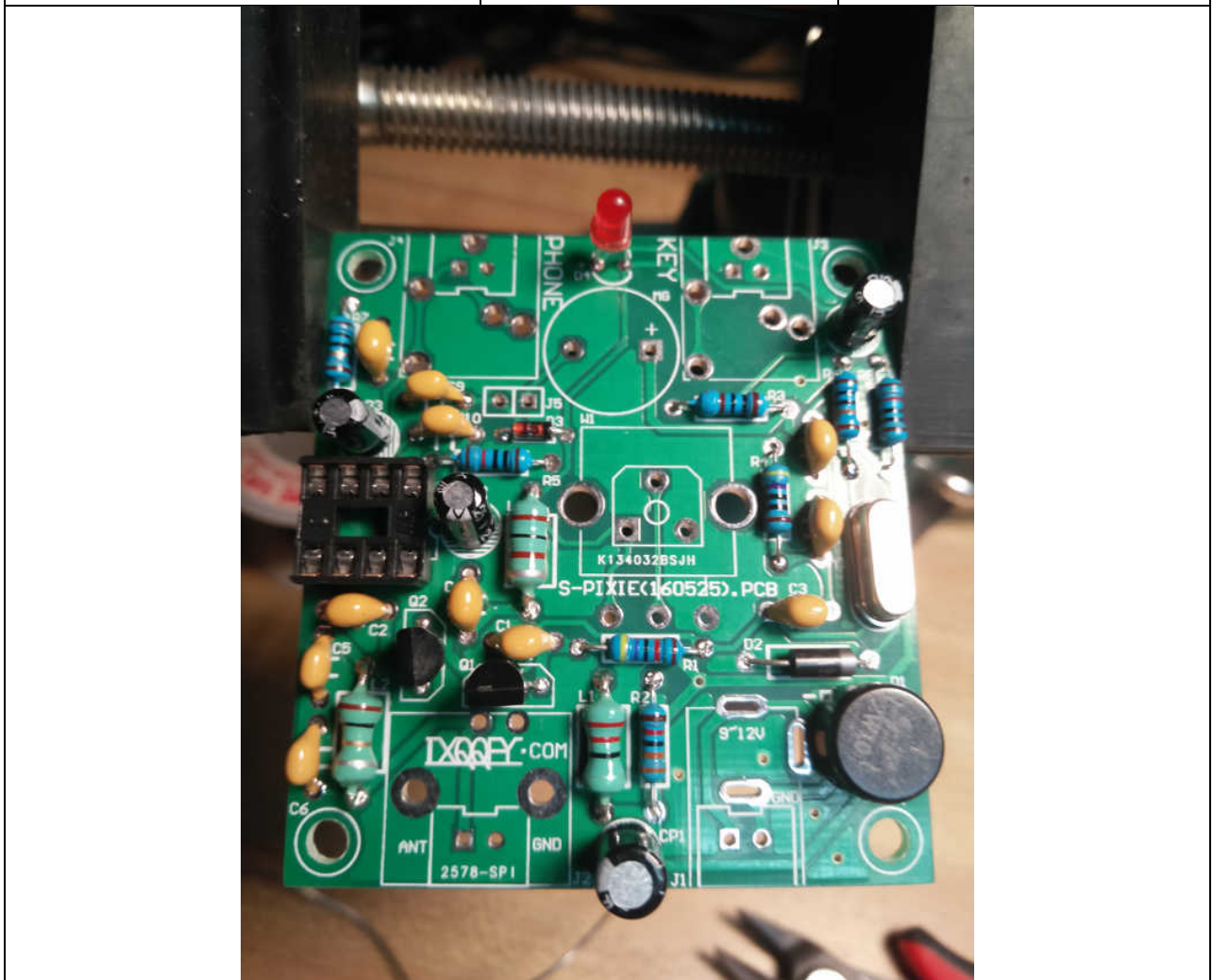
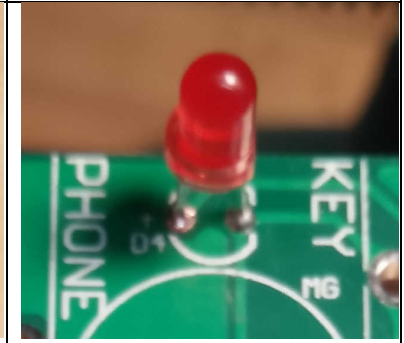
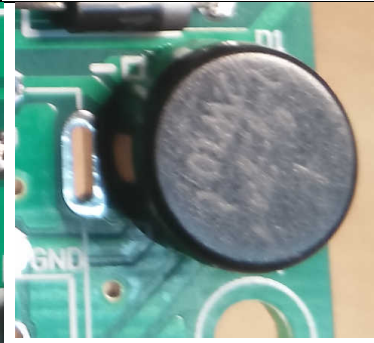
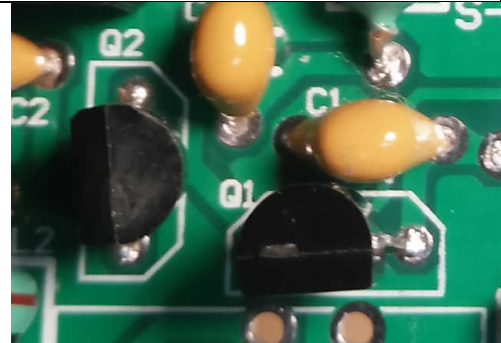



## Connectors, Buzzer, Variable Resistor, Jumper

You can be more liberal with solder used on components in this section (less the buzzer) since they have to deal with the strain of physical interaction. Start with soldering the Phone connector and Key connector – they use identical parts. Then in order solder the power and antenna connectors, buzzer, variable resistor, and jumper. Be sure to insert the jumper cap and finally insert the IC into its socket noting correct orientation.

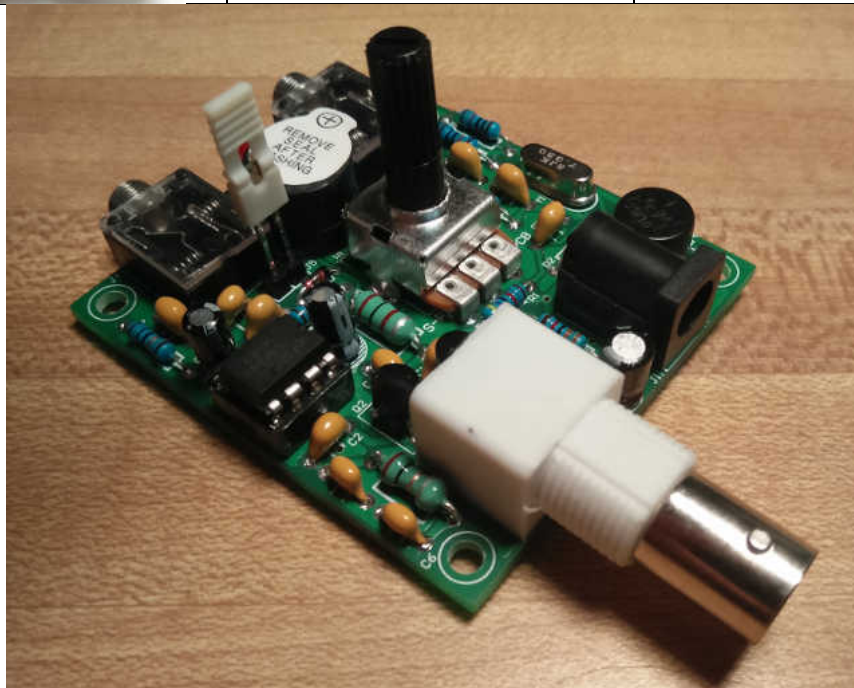
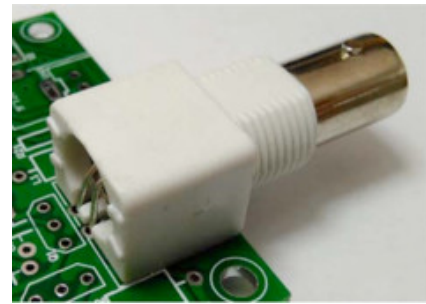
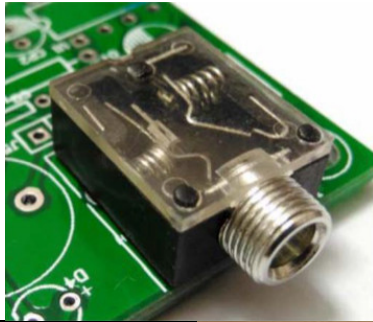

## Acrylic Case

Remove the protective paper from the acrylic pieces. The bottom portion of the case is assembled first using the long plastic screws first through the feet, then the bottom of the case. Next screw the long plastic screws into the plastic standoffs the circuit board will sit on top of. Place the circuit board on the standoffs and then place the acrylic slides that have connector holes in place. Then screw the plastic extensions to the standoffs. Next place the acrylic slide with no holes in place and then acrylic top. Use the remaining short screws to secure the top.

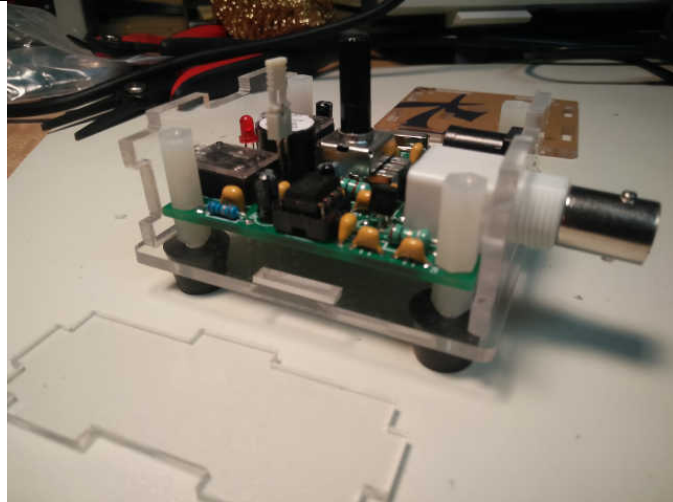
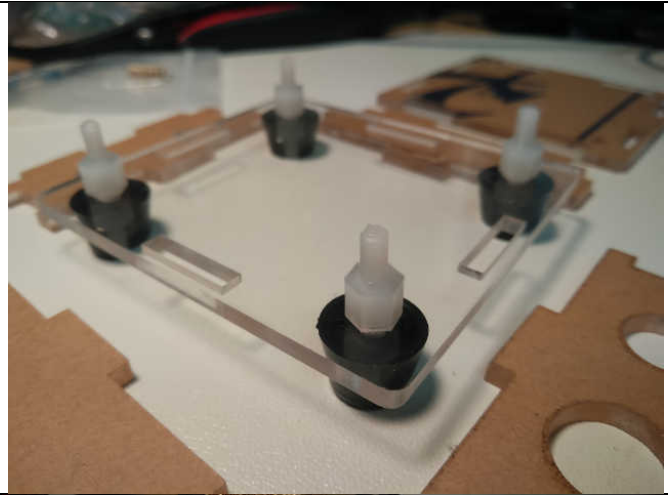
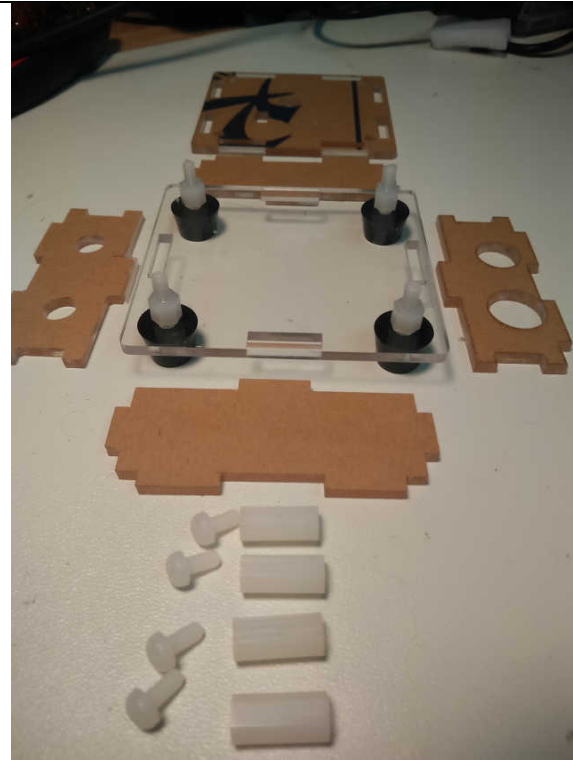

## Testing

### Setup

Prior to applying power connect either an antenna or dummy load to the antenna jack (J2.) A 50 Ohm resistor is included to be used as a dummy load. Simply solder the resistor across the center and shield of a BNC connector.

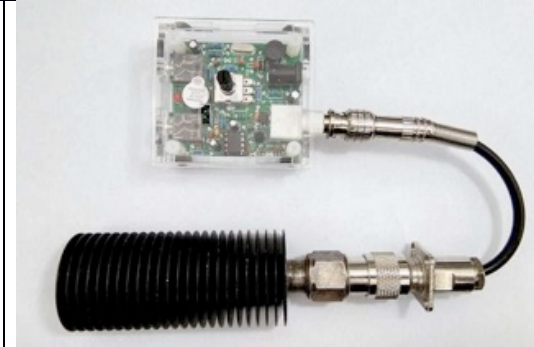

### Key & Headphone

Stereo connectors are used for both the key (J3) and phone (J4) connections. Since the straight key uses a mono jack, the middle and outer sleeves of the key connector (J3) are ground. Use 8 ohm headphones when connecting to the phone (J4) connection.

Manual-Key Wiring diagram



### Operation

With antenna, headphone, and key connected, go ahead and apply power. Don't expect the audio to be loud or to readily hear signals. Using the potentiometer you will be able to tune a few KHz around your operating frequency of 7030 KHz. Tap the CW key and you will hear the buzzer emit a side tone as you transmit a signal.

# Appendices

## Schematic

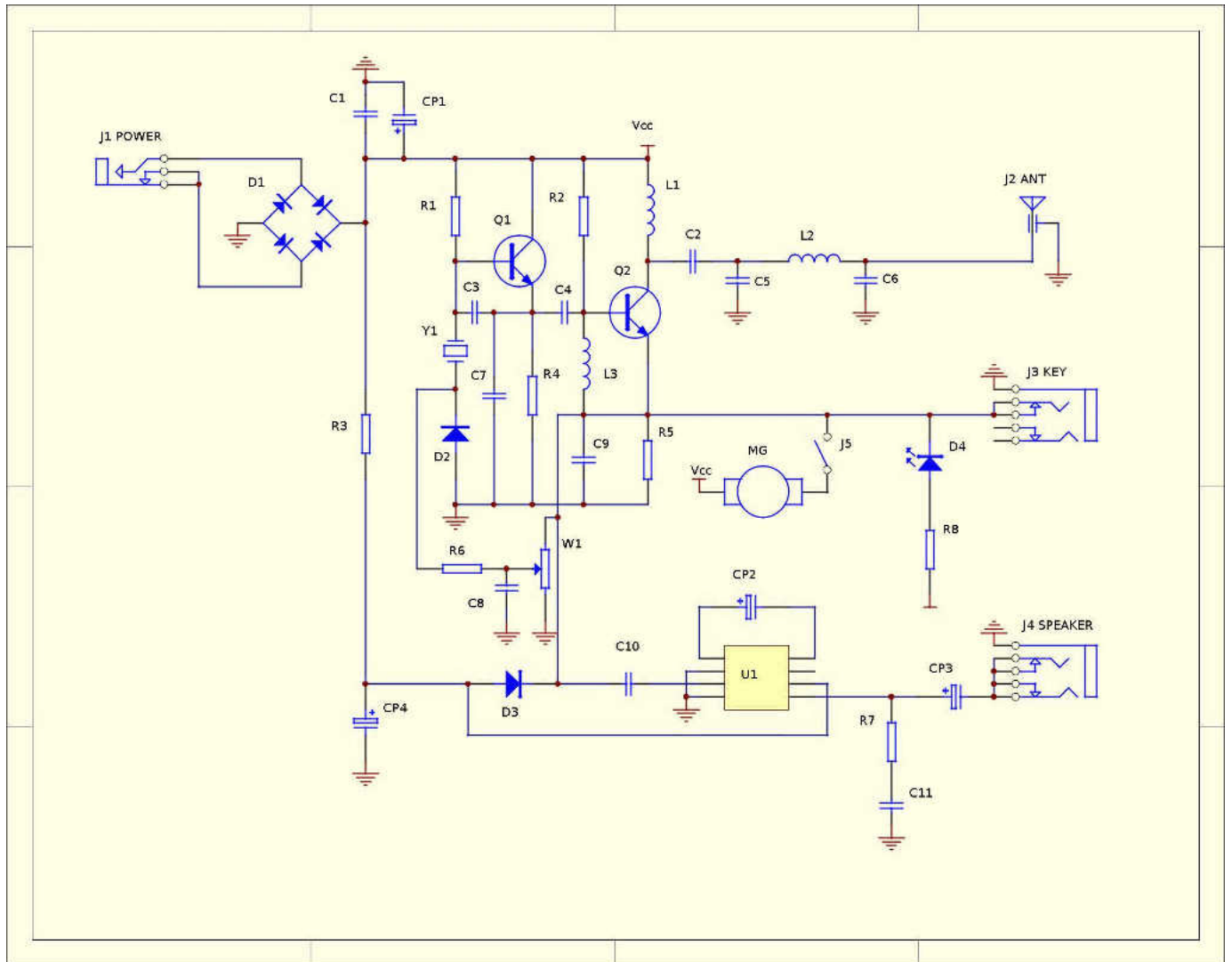

## Resistor Chart

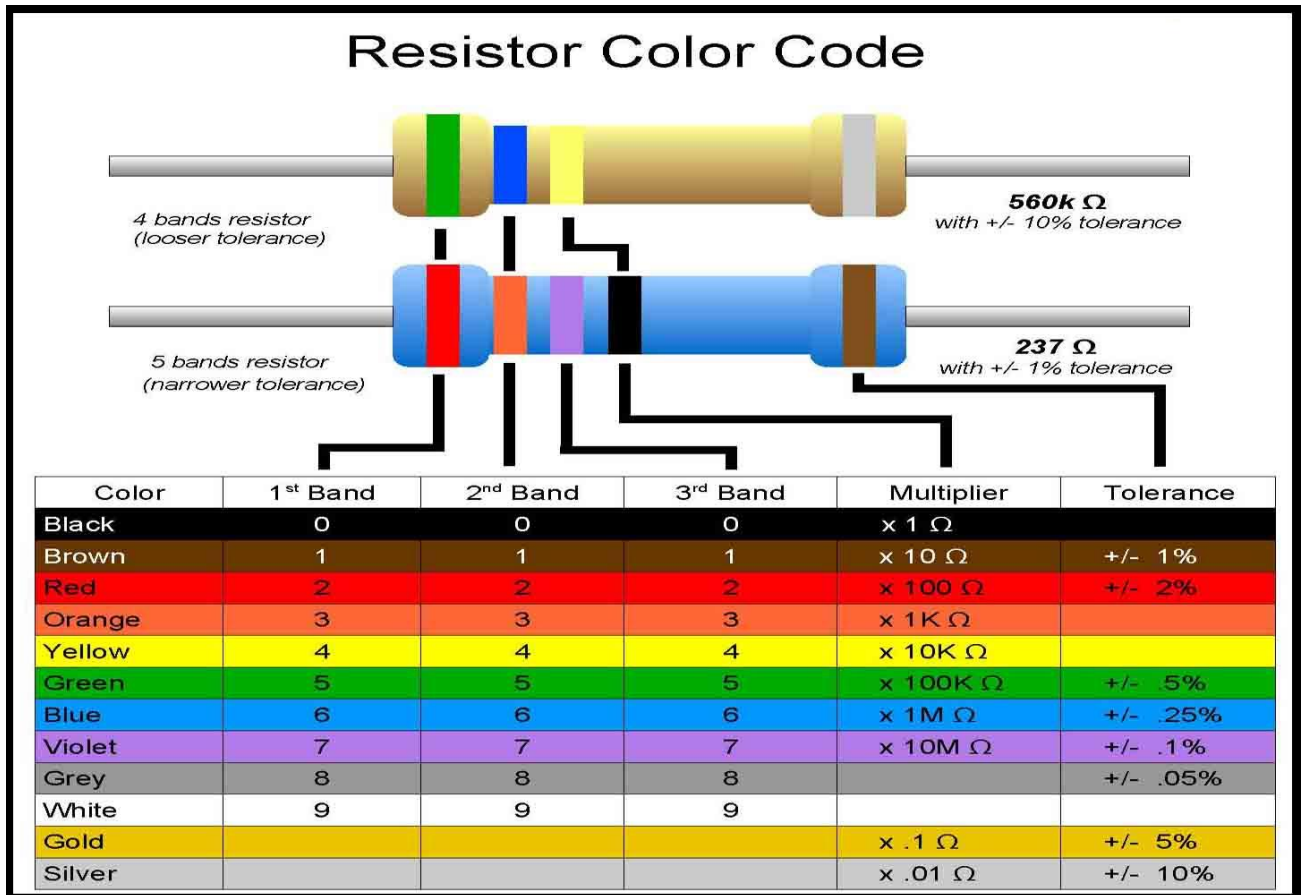

## Advanced Topic

### DDS VFO

The S-Pixie can be modified to cover the whole 40 Meter band by replacing the oscillator with a VFO. A popular approach has been to use a Direct Digital Synthesizer (DDS) controlled by an Arduino. The human interface includes an LCD display and rotary encoder.

Popular DDS choices include the AD9850 and the SI5351.

Remove/Omit C3, C7, Y1, W1, D2, R6, and C8.	
Place a 47K resistor between Q1 base and GND. Connect the DDS across that resistor.	