



S Series and S200 Series

Tubular and interconnected locks





Contents

4-5	Mechanical lock guide
6-7	S Series and S200 Series introduction
8-9	S Series performance features and exploded view
10-11	S Series lever designs, lever finishes and door handing
12	S Series lock functions
13	Cylinders and key systems
14	Standard cylinders, full size interchangeable core and Primus XP high security cylinders
15	Interchangeable core conversion kits
16-17	Latches, strikes and rabbeted latch and strike kit
18	S Series specifications, certifications
20-21	S200 Series performance features and exploded view
22-23	S200 Series lever designs
24	S200 Series lever finishes and door handing
25	S200 Series lock functions
26	Cylinders and key systems
27	Standard cylinders and Primus high security cylinders
28	Interchangeable core, cores and IC cylinders and parts
29	S200 Series latches and deadbolts, door reinforcement and strikes
33	S200 Series specifications, certifications

Pictured here: S Series Saturn lever shown in 626 satin chrome

Cover photo: S Series Jupiter lever shown in 626 satin chrome

Put your trust in the name you know

For more than 90 years, Schlage® has been creating the strongest and most technologically advanced security products for schools, hospitals, hotels, commercial and institutional buildings, multi-family properties and homes. From durable mechanical locks to comprehensive electronic access control solutions and biometrics, Schlage provides protection at critical moments – when property and personal security are at stake. With a wide range of products, styles and finishes, Schlage has products for the most demanding project specifications. In public buildings, in the workplace, and in homes, at the end of the day Schlage stands for one thing: strong.



Real security is knowing exactly what you want and getting it

When you know exactly what you want, you don't want to waste time finding out whether it meets your project specifications. That's why we offer the world's largest team of hardware specification writers to help you and your clients turn your vision into reality. And when it comes to products, our commercial suiting options, wide variety of lever designs and rich selection of finishes give you the tools you need to make your projects perfect. You know what you want. With Schlage, you can be sure you'll get it.

Safety, security and confidence

When you choose a Schlage lock, you can be sure you've done the job right, the first time. After all, our products are among the most durable and dependable on the market today. Our locks are easy to install, and simple to repair and maintain. That means fewer callbacks for you and total safety and security for your customers.



Tubular interconnected locks



Tubular locks



Tubular interconnected locks







Cylindrical locks



Cylindrical interconnected locks

CS200 Series	S Series	S200 Series	A Series	H Series
Grade 2	Grade 2		Grade 2	
Security level:				
ANSI/BHMA certified A156.12-2013 Exceeds 400,000 ANSI cycles Medium traffic	ANSI/BHMA certified A156.2-2011 Exceeds 400,000 ANSI cycles Light traffic	- - Exceeds 400,000 ANSI cycles Medium traffic	ANSI/BHMA certified A156.2-2011 Exceeds 400,000 ANSI cycles Medium traffic	- - Exceeds 400,000 ANSI cycles Medium traffic
Typical applications:				
Exterior Interior New construction Retrofit	- Interior - Retrofit	Exterior Interior New construction Retrofit	Exterior Interior New construction Retrofit	Exterior Interior - Retrofit
Functions available:				
1 Function - -	6 Functions - -	5 Functions - -	11 Functions - -	5 Functions - -
Design options:				
7 Finishes 15 Lever styles - 1 Matching rose 2 Interior escutcheons Tactile warning available	7 Finishes 4 Lever styles - 1 Matching rose - Tactile warning available	7 Finishes 4 Lever styles - 1 Matching rose 1 Interior escutcheon -	10 Finishes 1 Lever style 4 Knob styles 1 Matching rose - -	7 Finishes 1 Lever style 2 Knob styles 1 Matching rose 1 Interior escutcheon -
Often used in:				
Commercial Multi-family Office	Commercial Multi-family Office	Commercial Multi-family Office	Commercial Govt/military Healthcare Hospitality Office Retail	Commercial Govt/military Multi-family

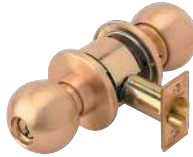
Not all functions and finishes available with all products. Please consult your SSC representative for details.

				
Cylindrical locks	Deadbolts	Cylindrical locks	Cylindrical locks	Mortise locks
AL Series	B Series	D Series	ND Series	L Series
Grade 2	Grade 2	Grade 1	Grade 1	Grade 1
Security level:				
ANSI/BHMA certified A156.2-2011 Exceeds 400,000 ANSI cycles Medium traffic	ANSI/BHMA certified A156.36-2010 Exceeds 150,000/250,000 ANSI cycles High traffic, heavy-duty	ANSI/BHMA certified A156.2-2011 Exceeds 1,000,000 ANSI cycles High traffic	ANSI/BHMA certified A156.2-2011 Exceeds 1,000,000 ANSI cycles Heavy-duty traffic	ANSI/BHMA certified A156.13-2012 Exceeds 1,000,000 ANSI cycles Heavy-duty traffic
Typical applications:				
Exterior Interior New construction Retrofit	Exterior - New construction Retrofit	Exterior Interior - Retrofit	Exterior Interior New construction Retrofit	Exterior Interior New construction Retrofit
Functions available:				
10 Functions - -	7 Functions - -	6 Functions - -	14 Functions 2 Electrified -	29 Functions 6 Electrified Vandlgard® available
Design options:				
10 Finishes 4 Lever styles - 1 Matching rose - Tactile warning available	10 Finishes - - - - Indicator rose	10 Finishes - 3 Knob styles 1 Matching rose - -	9 Finishes 5 Lever styles - 2 Matching roses - Tactile warning available	13 Finishes 32 Lever style 3 Knob styles 5 Matching roses 2 Escutcheons Tactile warning available Antiligature available
Often used in:				
Commercial Healthcare Hospitality Office Retail	Commercial/institutional Govt/military Heavy-duty residential Hospitality Office Retail	Institutional Govt/military Hospitality Retail	Institutional Education Healthcare Office Retail	Commercial/institutional Govt/military Education Healthcare Office Retail

This chart shows the most common uses/applications. These products are often used in other applications in addition to those listed.

Rev. 04/14



S Series and S200 Series

Smart security for light commercial and multi-family applications

At Schlage, we know that every product you specify has to stand up to constant use, while meeting your needs for security at every level.

Our S Series and S200 Series locks are designed to deliver constant, reliable performance in light commercial applications like small hotels, laboratories and office tenant spaces, as well as apartment buildings.

We don't compromise on security

The safety and security of your clients' buildings is something we take very seriously. That's why every Schlage lock and deadbolt undergoes intensive testing to determine its ANSI grade level:

- Cycle tests
- Resistance tests
- Door impact tests
- Warped door tests
- Bolt strength tests

We pay attention to these details so you can focus on creating a functional and aesthetically pleasing environment for your clients. In fact, every one of our S Series locks meets ANSI Grade 1 standards for safety.

Pictured here: S Series Flair level shown in 626 satin chrome



S Series

Schlage S Series levers are engineered for long life and optimum durability. Easy to install, service and maintain, an S Series lever can help you keep people and property secure.

Pictured here: S Series Neptune lever shown in 626 satin chrome



Built tough from the inside out

- Heat-treated steel locking components for extra strength
- Independent heavy-duty lever torsion springs for durability and long life
- Everest 29™ patented keys standard for commercial applications

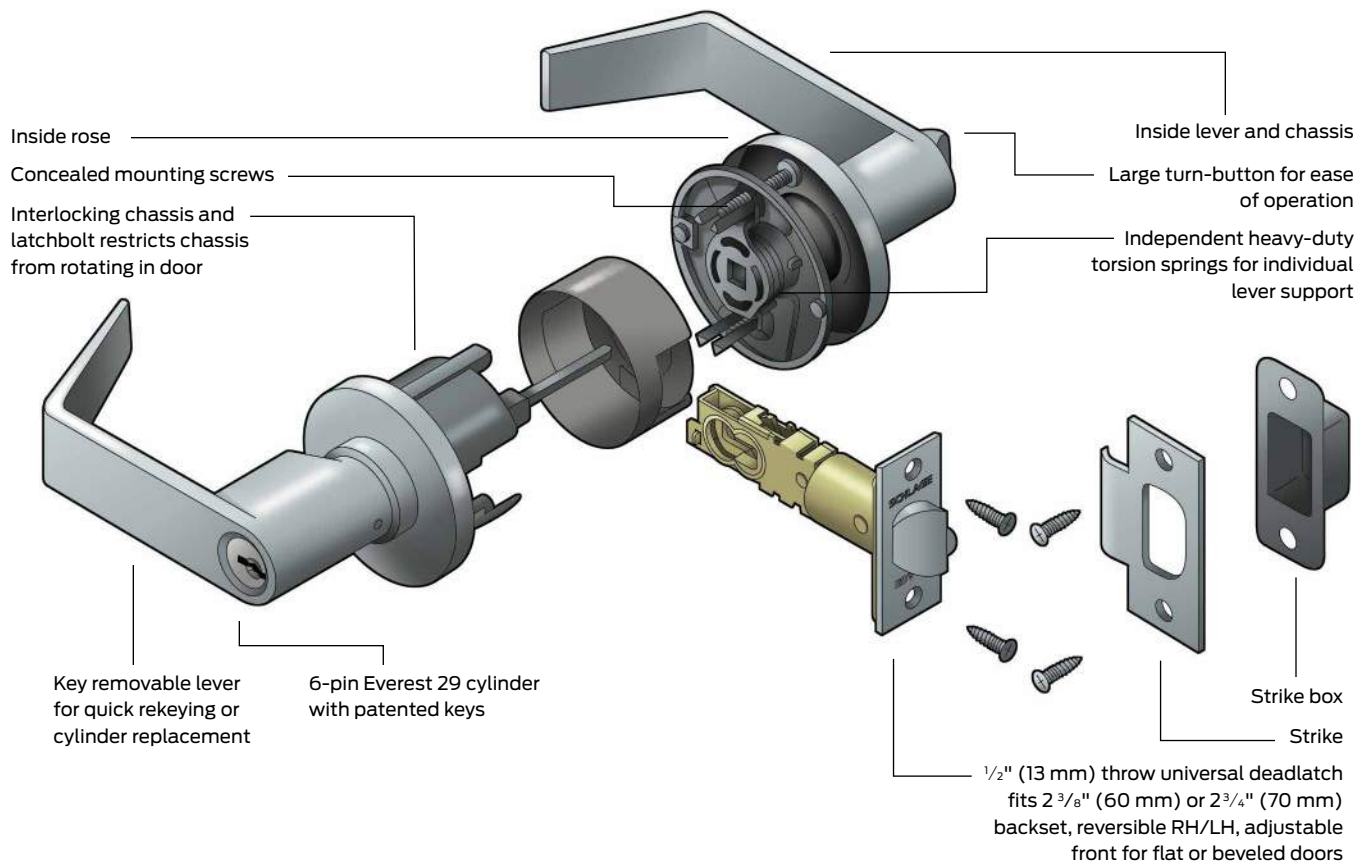

S Series lever designs

Jupiter (JUP)

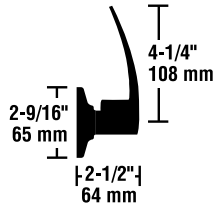

Symbol: JUP
Material: Pressure cast zinc



Neptune (NEP)

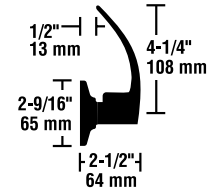

Symbol: NEP
Material: Pressure cast zinc



Saturn (SAT)

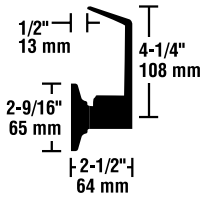

Symbol: SAT
Material: Pressure cast zinc



Flair (FLA)

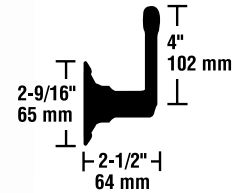

Symbol: FLA
Material: Pressure cast zinc



Tactile warning

Milled

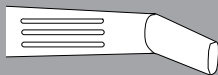

Order as follows:
BSA for Saturn



Only available on outside lever, unless otherwise specified

All designs shown in 626 satin chrome

-  = Standard cylinder.
-  = FSIC full size interchangeable core option.
-  = Complies with ADA accessibility guidelines.
-  = Meets California code for 1/2" or less return to the door.
-  = Extended factory lead time.

Lever finishes

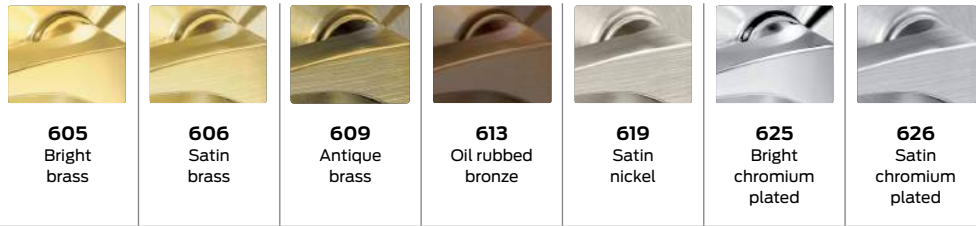

S Series locks							
Flair	•	•	•	•	•	•	•
Jupiter	•	•		•	•	•	•
Neptune	•	•		•	•	•	•
Saturn	•	•	•	•	•	•	•

Door handing

With the exception of the Flair lever design, the S Series lock is reversible. Hand information is necessary to ensure proper cylinder orientation in keyed functions, and finish of latchbolt and strike for locks that are to be installed on reverse bevel doors. Follow the diagram to correctly determine the hand of the door.

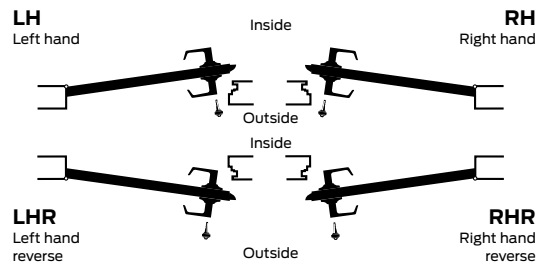

ADA-compliant products



In compliance with the American National Standards Institute (ANSI A117.1) and the Americans with Disabilities Act (ADA), Schlage Lock Company offers a wide selection of locks designed for the needs of the physically challenged. This act is designed to provide protection for people with disabilities.

The intent of ADA is that owners of certain types of buildings must remove barriers and provide people with disabilities with access equal to, or similar to, that available to the general public.

Product information and specifications contained in this catalog are subject to change without notice. Please consult the factory.

S Series lock functions

ANSI A156.2 Series 4000 Grade 2

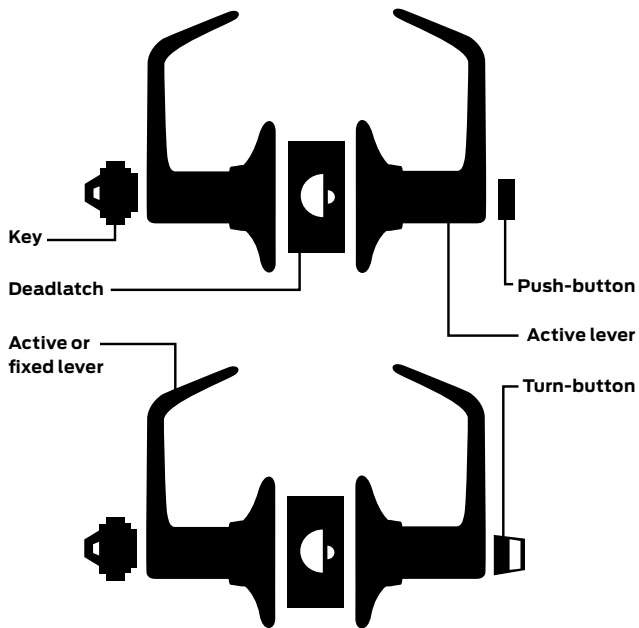
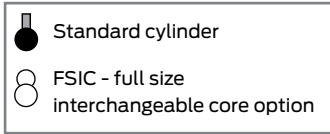

Non-keyed functions

Schlage **S10D** ANSI **F75**

Passage latch

- Both levers always unlocked.

Outside Inside

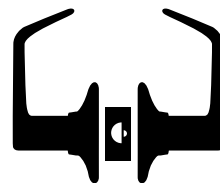

Schlage **S40D** ANSI **F76**

Bath/bedroom privacy lock

- Push-button locking.
- Can be opened from outside with small narrow tool.
- Turning the inside lever releases button.

Outside Inside

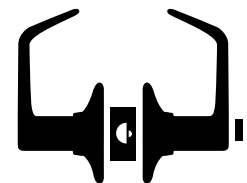

Keyed functions

Schlage **S170** ANSI **—**

Single dummy trim

- Dummy trim for one side of door.
- Used for door pull or as matching inactive trim.

Outside/Inside



Schlage **S70PD** ANSI **F84**

Classroom lock

- Outside lever locked and unlocked by key.
- Inside lever always unlocked.

Outside Inside

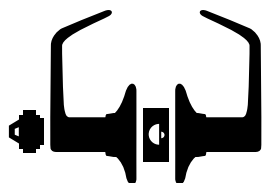

Schlage **S80PD** ANSI **F86**

Storeroom lock

- Outside lever fixed.
- Entrance by key only.
- Inside lever always unlocked.

Outside Inside

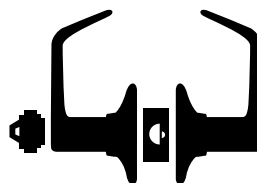

Schlage **S51PD** ANSI **F81**

Entrance lock

- Outside lever locked and unlocked by key or by turn-button on inside lever.
- Inside lever always unlocked.

Outside Inside

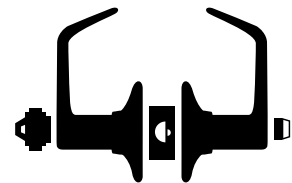



Cylinders and key systems

Protect new key systems with Everest 29

Schlage can help you design a system that can grow and change along with your needs, allowing you the flexibility to upgrade your security without the need to replace all your cylinders.



What it operates	What it is
<ul style="list-style-type: none"> Everest 29 Primus® XP cylinders Everest 29 restricted cylinders Everest 29 open cylinders 	<p>UL 437 version</p> <ul style="list-style-type: none"> UL 437 versions provide drill and pick resistance and withstand physical attack High security cylinders have a second set of pins for added security Patented key control sold with various levels of geographic exclusivity Keys operate high security, as well as restricted security or standard security cylinders Available only in conventional
<ul style="list-style-type: none"> Everest 29 Primus XP cylinders Everest 29 restricted cylinders Everest 29 open cylinders 	<p>Controlled access</p> <ul style="list-style-type: none"> Patented key control sold with various levels of geographic exclusivity High security cylinders have a second set of pins for added security and pick resistance Keys operate high security, as well as restricted security or standard security cylinders Available only in conventional and FSIC  <p>EVEREST 29[™] PRIMUS XP High security</p>

<ul style="list-style-type: none"> Everest 29 restricted cylinders 	<ul style="list-style-type: none"> Key distribution is restricted duplication must be authorized End user's ID numbers are stamped on all keys, enabling Schlage to identify the source of any unauthorized keys Patent-protected keys are drop-shipped from the factory directly to an end-user specified location to guarantee exclusivity Available in conventional, SFIC and FSIC  <p>EVEREST 29[™] Restricted security</p>
---	--

<ul style="list-style-type: none"> Everest 29 open cylinders 	<ul style="list-style-type: none"> Patented key blanks can be stored by commercial locksmiths and security dealers Keys can be duplicated without any paperwork or signature verification Sold only through commercial outlets Available in conventional and FSIC  <p>EVEREST 29[™] Standard security</p>
---	--

Upgrade existing classic key systems with Primus XP

Schlage offers key system solutions that are ideal for upgrading an existing key system to control key management. Our patent-protected cylinders help prevent unauthorized duplication and can be integrated into virtually any existing system.

What it is	What it operates
<p>UL 437 version</p> <ul style="list-style-type: none"> UL 437 versions provide drill and pick resistance and withstand physical attack High security cylinders have a second set of pins for added security Patented key control sold with various levels of geographic exclusivity Keys operate high security, as well as restricted security or standard security cylinders Available only in conventional 	<ul style="list-style-type: none"> Primus XP cylinders Classic cylinders
<p>Controlled access</p> <ul style="list-style-type: none"> Patented key control sold with various levels of geographic exclusivity High security cylinders have a second set of pins for added security and pick resistance Keys operate high security, as well as restricted security or standard security cylinders Available only in conventional  <p>PRIMUS XP High security</p>	<ul style="list-style-type: none"> Primus XP cylinders Classic cylinders
<p>CLASSIC</p> <p>Basic security</p> 	<ul style="list-style-type: none"> Keys can be duplicated at most retail and commercial points of sale with no restrictions Recommended only for residential applications or existing commercial systems that cannot rekey Can be upgraded to Primus XP without rekeying the entire facility Available in conventional and FSIC <ul style="list-style-type: none"> Classic cylinders

Standard cylinders

Standard cylinders are available in Classic keyways or in patented Everest 29 keyways. Specify keyway to differentiate between Everest 29 and Classic.
Example: C (Classic) vs. S123 (Everest 29).

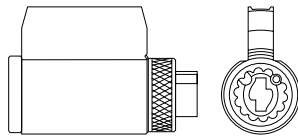

Cylinders for keyed levers - options

- 6-pin conventional cylinder (standard)
- Primus high security cylinder
- Primus UL437 Listed high security cylinder

Available in 606 and 626 finish only.
Everest 29 S123 keyway standard for commercial; C keyway standard for residential.

Sleeve S605-192 included.

Full size interchangeable core

Schlage interchangeable core (IC) locksets allow immediate rekeying at the door simply by using the special control key to replace the core in seconds.

FSIC locksets are available in Jupiter, Neptune and Saturn designs.



Full size interchangeable cores can be integrated into any 5 or 6-pin Schlage key system with no adverse affects on keying capacity.



Full size interchangeable cores - options (for JD suffix locksets)

- Conventional core
- Primus high security core

Available in 606 and 626 finish only.
Everest 29 S123 keyway standard for commercial; C keyway standard for residential.

Primus XP high security cylinders

Primus XP cylinders are recommended for upgrading existing Classic key systems. Due to its extended patent life, the newly designed Everest 29 Primus is recommended for new key systems and for upgrading existing Everest 29 key systems. Specify keyway to differentiate between Everest 29 and Classic.
Example: CP (Classic) vs. S123 (Everest 29).

Interchangeable core conversion kits

It is easy to convert standard S Series locksets to accept Schlage full size interchangeable cores by changing the lever and adding the parts shown.

Interchangeable core components - options

- Lever, driver, plug, retainer*
- Lever only*
- Retainer
- Driver
- IC installation tool

* Specify design and finish.

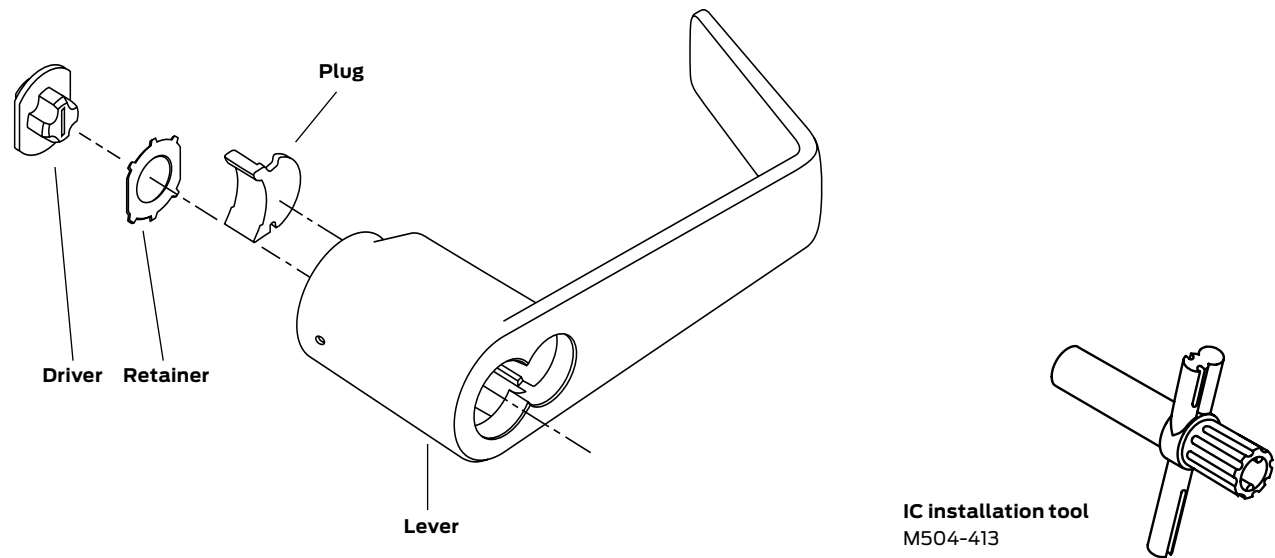

Latches

The standard universal backset deadlatch fits both 2³/₈" (60 mm) and 2³/₄" (70 mm) backsets. They are adjustable for flat or beveled edge doors and have a 1/2" (13 mm) throw. Orders for complete locks are provided with a G506-815 sleeve for 7/8" diameter latches installed in doors with 1" (25 mm) edge bore. All latches have 1" x 2 1/4" (25 mm x 57 mm) square corner fronts. Standard latches are shown in bold type.

Note: Failure to use the below referenced latches and fire cup, included with the lockset, will invalidate the UL Listing.

Deadlatches - options

Backset	Faceplate description	Hsg dia
2 ³ / ₈ " or 2 ³ / ₄ "	1" x 2 1/4" Square corner*	7/8"
	1" x 2 1/4", 1/4" Radius round corner	7/8"
5"	1" x 2 1/4" Square corner*	7/8"

*Latches include A501-878 faceplate adapter for 1 1/8" face.

Square corner deadlatch
16-203

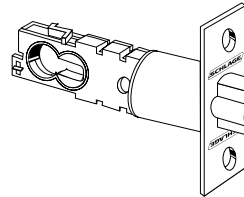

Round corner deadlatch
16-204

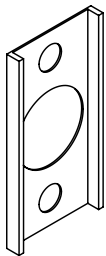
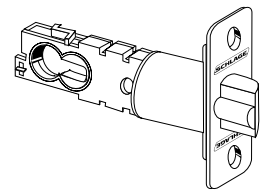

Latch front adapter
A501-878

Used to adapt 1" (25 mm) wide square front faceplates to 1 1/8" (29 mm) wide door preparations. Furnished in black plastic. Order in multiples of 100.

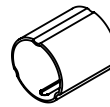

Sleeve
G506-815

Used on 7/8" (22 mm) diameter latch housings in 1" (25 mm) edge bore. Furnished standard with complete locks.

Door Reinforcement

Schlage reinforcing units help prevent the collapse of hollow metal doors when locksets are tightly mounted.



A501-566
1 3/4" (44 mm) doors

A501-565
1 3/8" (35 mm) doors

Strikes

All Schlage strikes are furnished complete with screws. The 10-001 standard S Series strike has a 1 1/8" (29 mm) lip. When ordering separately, specify quantity, product number, finish, and lip length. Standard strike is shown in bold type.

Strikes - options

- 1", 1 1/8" (Std), 1 1/4", 1 1/2", 1 3/4", 2" (25 mm, 29 mm, 32 mm, 38 mm, 44 mm, 51 mm - 1 1/8" x 2 3/4" (29 mm x 70 mm) square corner, standard
- 1 1/8" (29 Mm) - 1 1/8" x 2 3/4" (29 mm x 70 mm) 1/8" (3 mm) radius, round corner
- 1 3/16", 1 3/8" (30 mm, 35 mm) - 1 1/4" x 4 7/8" (32 mm x 124 mm) ANSI
- 1 1/8" (29 mm) - 1 5/8" x 2 1/4" (41 mm x 57 mm) full lip, square corner
- 1 1/8" (29 mm) - 1 5/8" x 2 1/4" (41 mm x 57 mm) full lip, 1/4" (6 mm) radius, round corner
- Box, ANSI

T-strike – standard

10-001

1 1/8" x 2 3/4" x 3/32"
(29 mm x 70 mm x 2 mm)

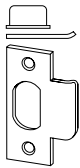

ANSI strike

10-025

1 1/4" x 4 7/8" x 3/32"
(32 mm x 124 mm x 2 mm)

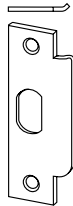

Full lip - square corner

10-026

1 5/8" x 2 1/4" x 3/32"
(41 mm x 57 mm x 2 mm)

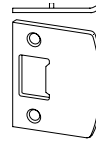

Full lip - round corner

10-027

1 5/8" x 2 1/4" x 3/32"
(41 mm x 57 mm x 2 mm)

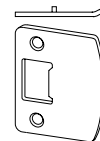

Rabbeted latch and strike kit

Rabbeted latch and strike kit finishes: 605, 626.

This kit adapts square corner latches and strikes for 1/2" (13 mm) rabbeted door and frame preparations.

Rabbeted latch and strike kit

39-030

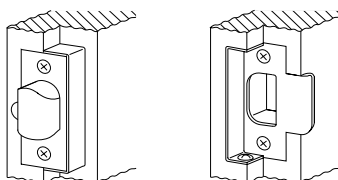

Specifications

Handing:

Not handed, except Flair design.

Door thickness:

1³/₈" to 2" (35 mm-51 mm) except S40D: 1³/₈" to 1⁷/₈" (35 mm-48 mm)

Backset:

Universal backset latches standard, fit either 2³/₈" (60 mm) or 2³/₄" (70 mm). 5" (127 mm) optional.

Fronts:

Steel. 1" x 2¹/₄" (25 mm x 57 mm) square corner, beveled, for 2³/₄" backset standard.

Lock chassis:

Tubular construction. Zinc with steel cover.

Latch bolt:

Brass, chrome plated, 1/2" (13 mm) throw, deadlocking.

Exposed trim:

Levers are zinc base, plated to match finish symbols. Roses, latch faceplates and strikes are wrought brass or bronze.

Strike:

T-strike 1¹/₈" x 2³/₄" (29 mm x 70 mm) x 1¹/₈" (29 mm) lip to center with box standard. Optional strikes, lip lengths and ANSI strike box available.

Cylinder and keys:

Commercial: 6-pin patented Everest 29 S123 keyway standard with two nickel silver keys per lock.

Residential: 6-pin C keyway, keyed 5-pin.

Keying options:

Interchangeable core and Primus high security cylinders. Master keying, grand master keying, and construction keying.

Warranty:

Commercial: Three-year limited.

Certifications

ANSI

Meets or exceeds A156.2 Series 4000, Grade 2 strength and operational requirements.

Federal:

Meets FF-H-106C.

California State Reference Code:

(Formerly Title 19, California State Fire Marshal Standard)

All levers with a return to door of 1/2" (64mm) or less comply.

UL / cUL:

All locks listed for A label single doors, 4' x 8'.

Letter F and UL symbol on latch front indicate listing.

UL437 Listed locking cylinder optional: specify Primus 20-500 Series cylinder.

ADA compliant:

Schlage Lock Company offers a wide selection of locks designed to meet the Americans With Disabilities Act.

S200 Series

When it comes to quick, easy egress and dependable security, Schlage S200 Series interconnected locks get the job done. Designed for applications ranging from military housing to multi-family and small hotel/motel buildings, the S200 Series is a lock you can depend on.

Pictured here: S200 Series interconnected lock with Flair lever in 626 satin chrome



Safety, security and long-lasting performance

- Heat-treated steel locking components for extra strength
- Independent heavy-duty lever torsion springs for durability and long life
- Non-handed levers for easy field installation
- Extra-strong Everest 29™-patented keys standard for commercial applications

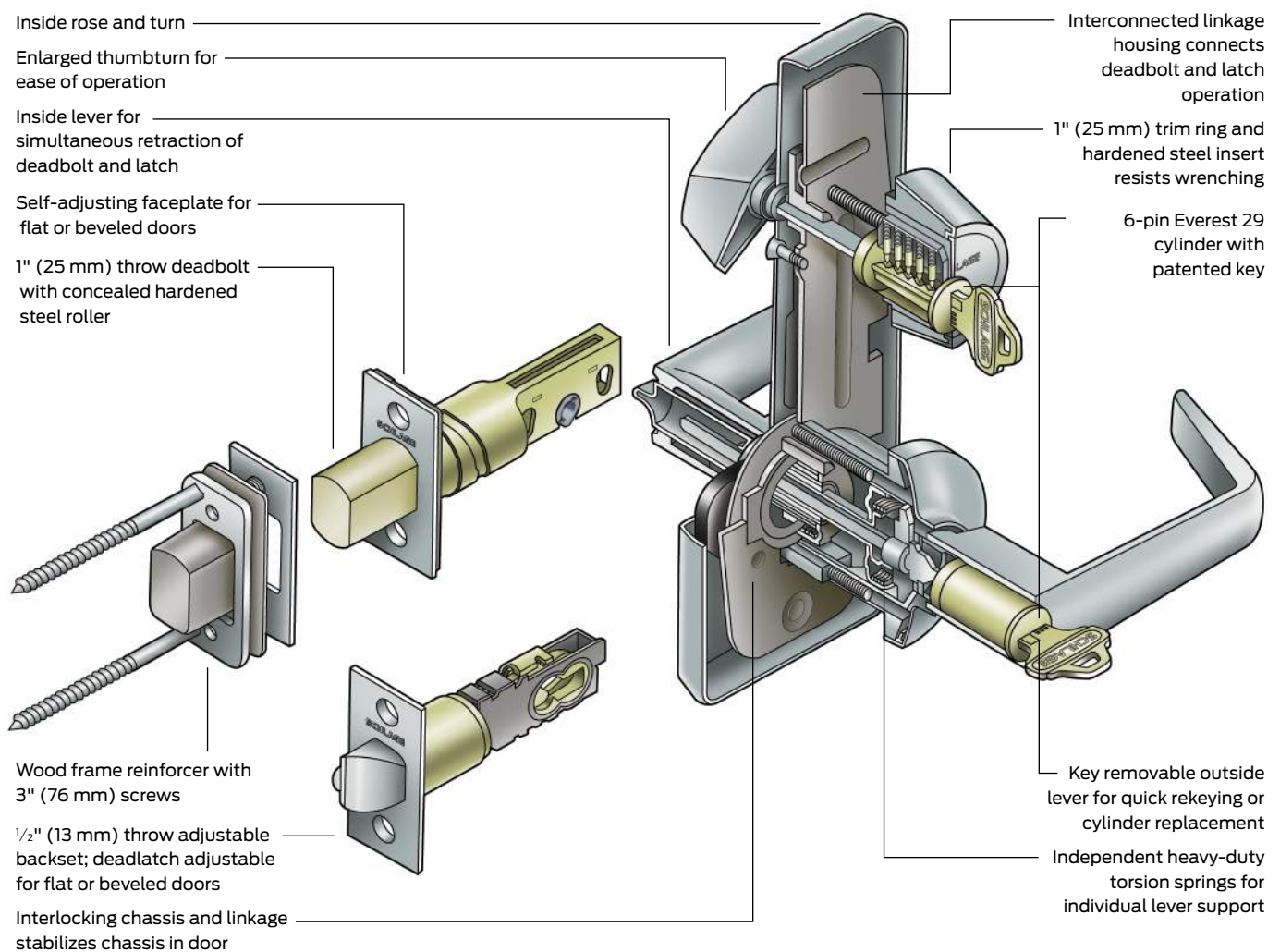

S200 Series lever designs

Flair (FLA)

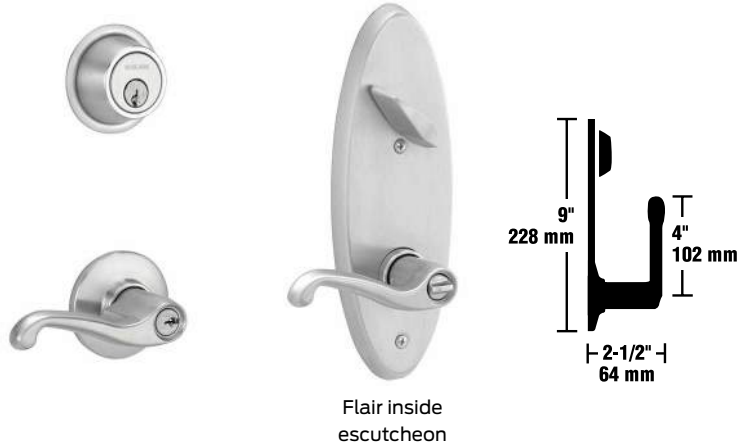

Symbol: FLA
Material: Pressure cast zinc



Saturn (SAT)



Symbol: SAT
Material: Pressure cast zinc



Neptune (NEP)

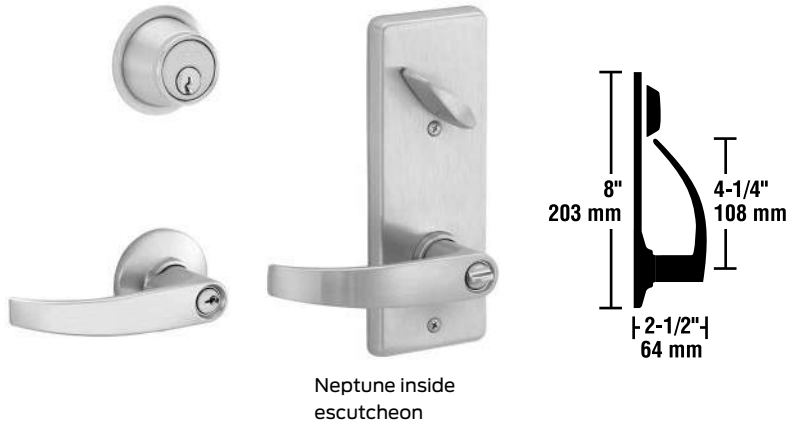

Neptune inside escutcheon

Symbol: NEP
Material: Pressure cast zinc



Meteor outside escutcheon



Order separately
Material: Pressure cast zinc

Jupiter (JUP)



Jupiter inside escutcheon

Symbol: JUP
Material: Pressure cast zinc



All designs shown in 626 Satin Chrome



= Standard cylinder.



= Complies with ADA accessibility guidelines.









= FSIC full size interchangeable core option.



= Meets California code for 1/2" or less return to the door.

Lever finishes

								
	605 Bright brass	606 Satin brass	609 Antique brass	612 Satin bronze	613 Oil rubbed bronze	619 Satin Nickel	625 Bright chromium plated	626 Satin chromium plated
S200 Series locks								
Flair	•	•	•	•	•	•	•	•
Jupiter	•	•			•	•	•	•
Neptune	•	•			•	•	•	•
Saturn	•	•	•	•	•	•	•	•
Meteor (36-056)	•	•	•	•	•	•	•	•

Door handing

All Schlage locks are reversible. Hand information is necessary to ensure proper cylinder orientation in keyed functions, and finish of latchbolt and strike for locks that are to be installed on reverse bevel doors. Follow the diagram to correctly determine the hand of the door.

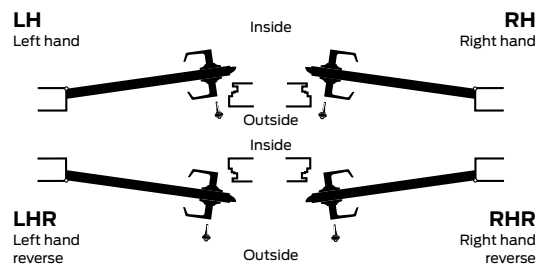

ADA-compliant products



In compliance with the American National Standards Institute (ANSI A117.1) and the Americans with Disabilities Act (ADA), Schlage Lock Company offers a wide selection of locks designed for the needs of the physically challenged. This act is designed to provide protection for people with disabilities.

The intent of ADA is that owners of certain types of buildings must remove barriers and provide people with disabilities with access equal to, or similar to, that available to the general public.

Product information and specifications contained in this catalog are subject to change without notice. Please consult the factory.

S200 lock functions

ANSI A156.12-1992, Grade 2

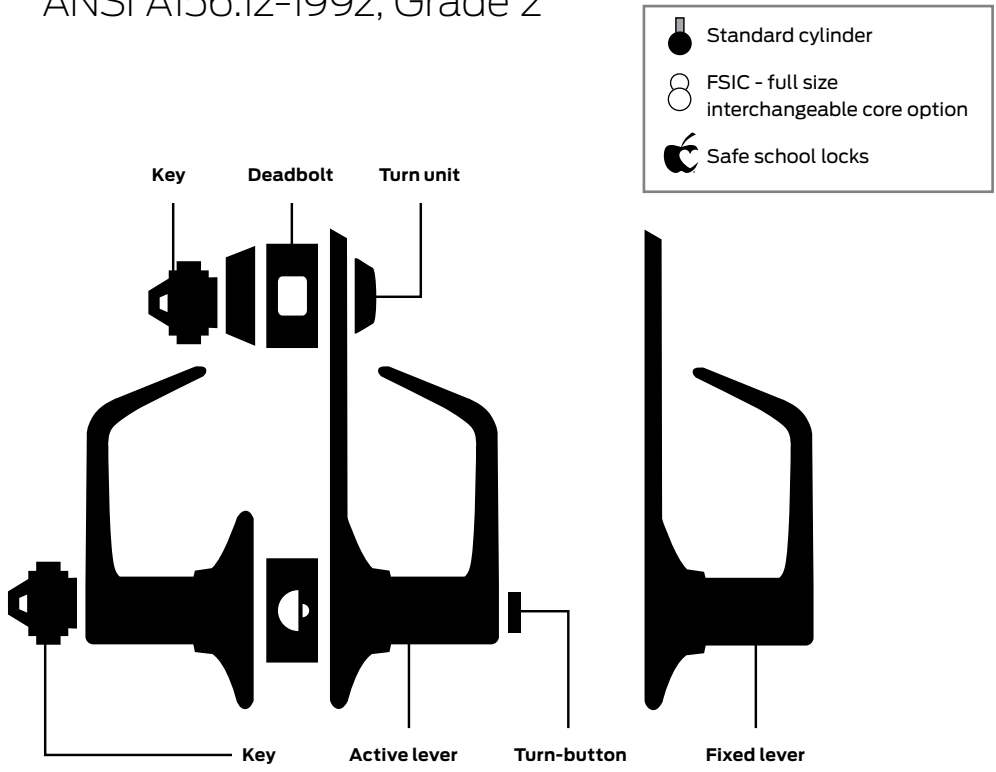

Keyed functions

Schlage ANSI
S210PD **F95**

Entrance, single locking

- Deadbolt operated by key from outside or by turning unit from inside.
- Bolt automatically deadlocks when fully thrown.
- Latchbolt retracted by lever from either side.
- Turn inside lever to simultaneously retract deadbolt and latchbolt for immediate exit.

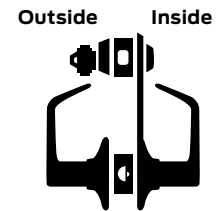

Schlage ANSI
S251PD **F97**
Entrance, double locking

- Deadbolt operated by key from outside or by turning unit from the inside.
- Bolt automatically deadlocks when fully thrown.
- Outside lever is unlocked by key from the outside or by turn-button on inside lever.
- Turn inside lever to simultaneously released deadbolt and latchbolt for immediate exit.
- Latch automatically deadlocks when door is closed.

Outside Inside



Schlage ANSI
S270PD -
Classroom lock

- Deadbolt operated by key from outside or by turning unit inside.
- Bolt automatically deadlocks when fully thrown.
- Outside lever is locked and unlocked by key from the outside.
- Turn inside lever to simultaneously retract deadbolt and latchbolt for immediate exit.
- Latch automatically deadlocks when door is closed.

Outside Inside



Schlage ANSI
S280 **F98**
Storeroom lock

- Deadbolt operated by key from outside or by turning unit from the inside.
- Bolt automatically deadlocks when fully thrown.
- Outside lever is fixed.
- Entrance by key only.
- Inside lever simultaneously retracts both latch and deadbolt for immediate exit.
- Latch automatically deadlocks when door is closed.

Outside Inside

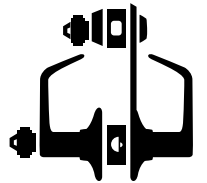

Schlage ANSI
S290PD -
Single dummy trim

- Dummy trim for one side of door.
- Used for door pull or as matching inactive trim.

Outside/Inside









Cylinders and key systems

Protect new key systems with Everest 29

Schlage can help you design a system that can grow and change along with your needs, allowing you the flexibility to upgrade your security without the need to replace all your cylinders.

Upgrade existing classic key systems with Primus XP

Schlage offers key system solutions that are ideal for upgrading an existing key system to control key management. Our patent-protected cylinders help prevent unauthorized duplication and can be integrated into virtually any existing system.

What it operates		What it is	
<ul style="list-style-type: none"> Everest 29 Primus[®] XP cylinders Everest 29 restricted cylinders Everest 29 open cylinders 	<ul style="list-style-type: none"> UL 437 version UL 437 versions provide drill and pick resistance and withstand physical attack High security cylinders have a second set of pins for added security Patented key control sold with various levels of geographic exclusivity Keys operate high security, as well as restricted security or standard security cylinders Available only in conventional 	<ul style="list-style-type: none"> UL 437 version UL 437 versions provide drill and pick resistance and withstand physical attack High security cylinders have a second set of pins for added security Patented key control sold with various levels of geographic exclusivity Keys operate high security, as well as restricted security or standard security cylinders Available only in conventional 	<ul style="list-style-type: none"> Primus XP cylinders Classic cylinders
<ul style="list-style-type: none"> Everest 29 Primus XP cylinders Everest 29 restricted cylinders Everest 29 open cylinders 	<p>Controlled access</p> <ul style="list-style-type: none"> Patented key control sold with various levels of geographic exclusivity High security cylinders have a second set of pins for added security and pick resistance Keys operate high security, as well as restricted security or standard security cylinders Available only in conventional and FSIC  <p>EVEREST 29[™] PRIMUS XP High security</p>	<p>Controlled access</p> <ul style="list-style-type: none"> Patented key control sold with various levels of geographic exclusivity High security cylinders have a second set of pins for added security and pick resistance Keys operate high security, as well as restricted security or standard security cylinders Available only in conventional  <p>PRIMUS XP High security</p>	<ul style="list-style-type: none"> Primus XP cylinders Classic cylinders
<ul style="list-style-type: none"> Everest 29 restricted cylinders 	<ul style="list-style-type: none"> Key distribution is restricted duplication must be authorized End user's ID numbers are stamped on all keys, enabling Schlage to identify the source of any unauthorized keys Patent-protected keys are drop-shipped from the factory directly to an end-user specified location to guarantee exclusivity Available in conventional, SFIC and FSIC  <p>EVEREST 29[™] Restricted security</p>	<p>Controlled access</p> <ul style="list-style-type: none"> Patented key control sold with various levels of geographic exclusivity High security cylinders have a second set of pins for added security and pick resistance Keys operate high security, as well as restricted security or standard security cylinders Available only in conventional  <p>PRIMUS XP High security</p>	<ul style="list-style-type: none"> Primus XP cylinders Classic cylinders
<ul style="list-style-type: none"> Everest 29 open cylinders 	<ul style="list-style-type: none"> Patented key blanks can be stored by commercial locksmiths and security dealers Keys can be duplicated without any paperwork or signature verification Sold only through commercial outlets Available in conventional and FSIC  <p>EVEREST 29[™] Standard security</p>	<p>Controlled access</p> <ul style="list-style-type: none"> Patented key control sold with various levels of geographic exclusivity High security cylinders have a second set of pins for added security and pick resistance Keys operate high security, as well as restricted security or standard security cylinders Available only in conventional  <p>PRIMUS XP High security</p>	<ul style="list-style-type: none"> Classic cylinders
		<p>CLASSIC Basic security</p>	<ul style="list-style-type: none"> Keys can be duplicated at most retail and commercial points of sale with no restrictions Recommended only for residential applications or existing commercial systems that cannot rekey Can be upgraded to Primus XP without rekeying the entire facility Available in conventional and FSIC

Standard cylinders

Schlage locks are provided with cylinders precision built to extremely close tolerances and the highest standards of accuracy. Using only solid brass plugs, extruded brass shells, phosphor bronze springs, nickel silver keys and pins, ensures long life and ease of operation.

Conventional cylinders are available in Classic keyways or in the newly patented Everest 29 keyways. Specify keyway to differentiate between Everest 29 and Classic. Example: C (Classic) vs. S123 (Everest 29).

Cylinders for deadbolt (top) - options

- 6-pin conventional (standard)
- Primus XP high security
- Primus XP UL437 Listed high security

Cylinder only available in 606 and 626 finish only.
Cylinder with housing available 605, 606, 609, 612, 613, 625, 626.

Everest 29 S123 keyway standard for commercial; C keyway standard for residential.



Cylinder only

Cylinders for keyed levers (bottom)- options

- 6-pin conventional (standard)
- Primus XP high security cylinder
- Primus XP UL437 Listed high security

Available in 606 and 626 finish only.
Everest 29 S123 keyway standard for commercial;
C keyway standard for residential.
Sleeve S605-192 included.

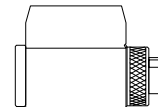

Primus XP access control and high security cylinders

Primus XP access control and high security cylinders are available to add patented key control and varying degrees of geographical exclusivity to most Schlage 6-pin key systems, whether Everest 29 or Classic keyways.

In addition to a conventional pin tumbler mechanism, Primus cylinders incorporate a patented finger pin and sidebar design, providing a “dual-locking” cylinder that is virtually pick-proof. Resistance to drilling and other physical attack is optional by specifying 20-500 Series UL437 Listed cylinders.

Classic Primus XP cylinders are recommended for upgrading existing Classic key systems. Due to its extended patent life, the newly designed Everest 29 Primus XP is recommended for new key systems and for upgrading existing Everest key systems. Specify keyway to differentiate between Everest 29 and Classic. Example: C or CP (Classic) vs. S123 (Everest 29).

Visit allegion.com for more information.

Interchangeable core 8

Schlage interchangeable core (IC) locksets allow immediate rekeying at the door simply by using the special control key to replace the core in seconds.

IC locksets are available in all designs except Flair.

Full size interchangeable cores can be integrated into any 5 or 6-pin Schlage key with no adverse affects on keying capacity.

To order complete locks with full size cores, change suffix from **PD** to **RD**. Example: S251**RD**. To order locks less core, change suffix to **JD**. To order with full size construction core, change suffix to **TD**.



All designs shown in 626 satin chrome

Cores, and IC cylinders and parts



Full size interchangeable cores - options

- 6-pin conventional (standard)
- Primus high security cylinder

Available in 606 and 626 finish only. Everest 29 S123 keyway standard for commercial; C keyway standard for residential.

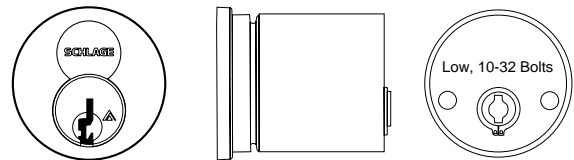

IC cylinders for deadbolt (top) - options

Tailpiece not included.

- Conventional core
- Primus core
- Primus XP core
- Housing less core

Available in 605, 606, 609, 612, 613, 625 and 626 for housing; 606 and 626 for cores and cylinders only.

Everest 29 S123 keyway standard for commercial; C keyway standard for residential.

IC installation tool

This tool is used to install the driver and retainer for full size IC in Schlage knobs and levers. Its other ends are designed to install and remove mortise cylinder housings and test mortise cylinder cam action for both small format and full size interchangeable core cylinders.

M504-413
 (Order separately)

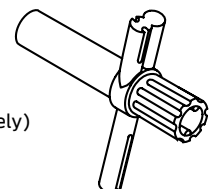

Latches and deadbolts

The standard universal backset deadlatch fits both 2³/₈" (60 mm) and 2³/₄" (70 mm) backsets. They are adjustable for flat or beveled edge doors and have a 1/2" (13 mm) throw. Orders for complete locks are provided with a G506-815 sleeve for 7/8" diameter latches installed in doors with 1" (25 mm) edge bore. Deadbolts have 1" (25 mm) housings and 1" (25 mm) throw. All latches and bolts for the S200 Series have 1¹/₈" x 2¹/₄" square corner fronts.

Note: Failure to use the below-referenced latches and fire cup, which are included with the lockset, will invalidate the UL Listing.

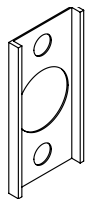

Latch front adapter
A501-878

Used to convert 1" (25 mm) wide squarefront faceplates for 1¹/₈" (29 mm) wide doorpreparations. Furnished in black plastic. Order in multiples of 100.

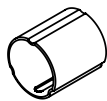

Sleeve
G506-815

Used on 7/8" (22 mm) diameter latch housings in 1" (25 mm) edge bore. Furnished standard with complete locks.

Strikes

Deadbolt strikes

Part number	Description	Lip length
10-064	Circular drive-in, thimble strike, 1 ³ / ₁₆ " diameter, 494 (for 626 only)	-
10-092	1/4" radius round corner, full lip, no box, 1 ⁵ / ₈ " x 2 ¹ / ₄ "	1 ¹ / ₈ "
10-094	Square corner, box, 1 ¹ / ₈ " x 2 ³ / ₄ " standard	-
10-095	Square corner, full lip, no box, 1 ⁵ / ₈ " x 2 ¹ / ₄ "	1 ¹ / ₈ "

Deadlatch strikes

Part number	Description	Lip length
10-001	Square corner, T-strike, box, 1 ¹ / ₈ " x 2 ³ / ₄ ", standard	1 ¹ / ₈ "
10-026	Square corner, full lip, no box, 1 ⁵ / ₈ " x 2 ¹ / ₄ "	
10-027	1/4" Radius round corner, full lip, no box, 1 ⁵ / ₈ " x 2 ¹ / ₄ "	1 ⁷ / ₃₂ "
10-058	Circular, adjustable, 1 ³ / ₄ " diameter, 605 and 626 only	

Deadbolt/deadlatch strike combinations

Combo number	Deadbolt strike	Deadlatch strike
10-109	10-094	10-001, 1 ¹ / ₈ " lip
10-251	10-064	10-001, 1 ¹ / ₈ " lip
10-110	10-094	10-026
10-253	10-064	10-026
10-111	10-094	10-027
10-256	10-064	10-027
10-257	10-092	10-027
10-258	10-064	10-058
10-259	10-095	10-026

Deadbolt/deadlatch combinations

Backset	Deadbolt	Deadlatch	Combo pair
2 ³ / ₈ " or 2 ³ / ₄ "	12-288	16-480	16-481
5"	12-633	16-132*	16-484

* 5" backset deadlatch includes A501-878 latch front adapter for 1¹/₈" preparation. Specify finish.

Deadbolt (top)
Fixed backset

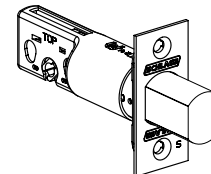

Latch (bottom)
Adjustable backset

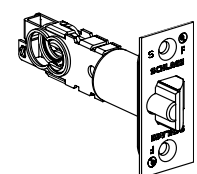

Door reinforcement

Schlage reinforcing units help prevent the collapse of hollow metal doors when locksets are tightly mounted.



A501-565
1¹/₈" (35 mm) doors

A501-566
1³/₄" (44 mm) doors

10-064



10-092

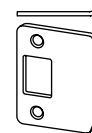

10-094

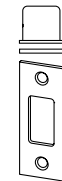

10-095

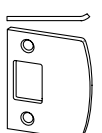

10-001



10-026

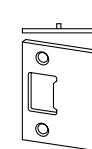

10-027



10-058

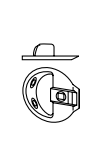

Specifications

Handing:

Not handed, except Flair design.

Door thickness:

1³/₈" to 2" (35 mm-51 mm).

Backset:

2³/₈" (60 mm) Standard, 2³/₄" (70 mm) and 5" (127 mm) available.

Fronts:

Brass or bronze. 1¹/₈" x 2¹/₄" (29 mm x 57 mm) square corner, beveled, for 2³/₄" backset standard.

For availability with specific backsets, see page 29.

Lock chassis:

Steel, zinc dichromate plated for corrosion resistance.

Deadbolt:

1" (25 mm) throw with hardened steel roller, and 1" (25 mm) housings standard.

Latch bolt:

Brass, chrome plated, 1/2" (13 mm) throw, deadlocking.

Exposed trim:

Levers are zinc base, plated to match finish symbols. Roses, escutcheons, latch faceplates and strikes are wrought brass or bronze.

Strike:

T-strike 1¹/₈" x 2³/₄" (29 mm x 70 mm) x 1¹/₈" (29 mm) lip to center with box standard. Optional strikes, lip lengths and ANSI strike box available.

Cylinder and keys:

Commercial: 6-pin patented Everest 29 S123 keyway standard with two nickel silver keys per lock.

Residential: 6-pin C keyway, keyed 5-pin.

Keying options:

Interchangeable core and Primus high security cylinders. Master keying, grand master keying, and construction keying.

Warranty:

Commercial: Three-year limited.

Certifications

Federal:

Meets FF-H-106C.

California State Reference Code:

(Formerly Title 19, California State Fire Marshal Standard)

All levers with a return to door of 1/2" (64 mm) or less comply.

UL / cUL:

All locks listed for A label single doors, 2' x 8'.

Letter F and UL symbol on latch front indicate listing.

UL437 Listed locking cylinder optional: specify Primus 20-500 Series cylinder.

ADA compliant:

Schlage Lock Company offers a wide selection of locks designed to meet the Americans With Disabilities Act.

About Allegion

Allegion (NYSE: ALLE) creates peace of mind by pioneering safety and security. As a \$2 billion provider of security solutions for homes and businesses, Allegion employs more than 8,000 people and sells products in more than 120 countries across the world. Allegion comprises 27 global brands, including strategic brands CISA®, Interflex®, LCN®, Schlage® and Von Duprin®.

For more, visit www.allegion.com

aptiQ ■ LCN ■ **SCHLAGE** ■ STEELCRAFT ■ VON DUPRIN