

cricket[®]
wireless

Samsung Galaxy J2 Pure
User manual



SAMSUNG

Table of contents

Device features	1
Learn more	2
Getting started	3
Device layout	4
Assemble your device	6
Remove the back cover	6
Install a SIM card and memory card	7
Replace the battery	9
Charge the battery	9
Start using your device	11
Use the Setup Wizard	11
Lock or unlock your device	12
Accounts	12
Transfer data from your old device	13
Set up voicemail	14
Navigation	15
Navigation bar	20

Customize the home screen	22
Bixby	29
Multi window	30
Enter text	32
Emergency mode	35
Apps	37
Using apps	38
Add an apps shortcut	38
Search for apps	38
Uninstall or disable apps	38
Sort apps	39
Create and use folders	39
Apps settings	40
Samsung apps	42
Galaxy Essentials	42
Galaxy Apps	42
Samsung+	42
Samsung Health	43
Samsung Notes	45

Calculator	47
Calendar	48
Camera	50
Clock	54
Contacts	60
Email	63
Gallery	66
Internet	71
Messages	74
Phone	77
Google apps	85
Chrome	85
Drive	85
Duo	85
Gmail	85
Google	85
Maps	86
Photos	86
Play Movies and TV	86

Play Music	86
Play Store	86
YouTube	86
Carrier apps	87
myCricket	87
Visual Voicemail	87
Additional apps	88
Amazon Shopping	88
Facebook	88
Settings	89
Access Settings	90
Search for Settings	90
Connections	91
Wi-Fi	91
Bluetooth	93
Data usage	94
Mobile networks	96
Location	96
Mobile hotspot	97

Nearby device scanning	100
Connect to a printer	100
MirrorLink	100
Virtual Private Networks	101
Sounds and vibration	102
Sound mode	102
Vibrations	102
Volume	103
Ringtone	104
Notification sounds	104
Do not disturb	104
System sounds	105
Key-tap feedback	105
Dolby Atmos	105
Equalizer	105
Headset audio options	106
Adapt sound	106
Notifications	107
Customize app notifications	107

Block app notifications	107
Display	108
Screen off settings	108
Screen brightness	108
One-handed mode	109
Device maintenance	109
Quick optimization	109
Battery	110
Storage and memory card	110
Language and input	112
Date and time	114
Report diagnostic information	115
Reset	115
Factory data reset	115
Auto restart	116
Software update	116
Lock screen and security	117
Screen lock types	117
Clock and information	118

Google Play Protect	118
Find My Mobile	118
Security update	119
Install unknown apps	119
Secure Folder	120
App permission monitor	120
Secure startup	120
Encrypt SD card	120
Factory data reset password	121
Set up SIM card lock	121
View passwords	121
Security update service	122
Device administration	122
Credential storage	122
Advanced security settings	123
Accounts	124
Samsung Cloud	124
Add an account	124
Account settings	124

Synchronize accounts	125
Remove an account	125
Backup and restore	125
Google settings	126
Accessibility	127
Vision	127
Hearing	128
Dexterity and interaction	129
Accessibility services	130
Other settings	130
Help	130
Device assistance app	131
Dual messenger	131
About phone	131
Legal information	132
Intellectual property	133
Open source software	134
Disclaimer of warranties; exclusion of liability	134
Modification of software	135

Notice from Cricket	135
Samsung Knox	135
Restricting children's access to your mobile device	136
Samsung Electronics America, Inc.	136

Device features



Meet Bixby

Bixby frees you to focus on what matters most. It learns what you like to do and works with your favorite apps and services to help you get more done. See [Bixby](#) on page 29.



Direct Share

Share content with specific people directly. See [Direct share](#) on page 62.



Media volume limiter

Limit the maximum output of the device's volume. See [Media volume limiter](#) on page 103.



Multi window

Multitask by using two applications at the same time. See [Multi window](#) on page 30.

Learn more

Videos

samsung.com/us/support/videos

Smart Simulator

samsungsimulator.com

Tips

samsung.com/us/support/tips

Samsung Care

samsung.com/us/support

Getting started

Device layout

Assemble your device

Start using your device





Device layout





Assemble your device

Your SIM card may be preinstalled.

-  Small components such as a SIM and memory card can pose a choking risk.
-  Use only charging devices and batteries (if applicable) that are approved by Samsung. Samsung charging devices and batteries are designed for your device to maximize battery life. Using other charging devices and batteries may void your warranty and may cause damage.

Remove the back cover

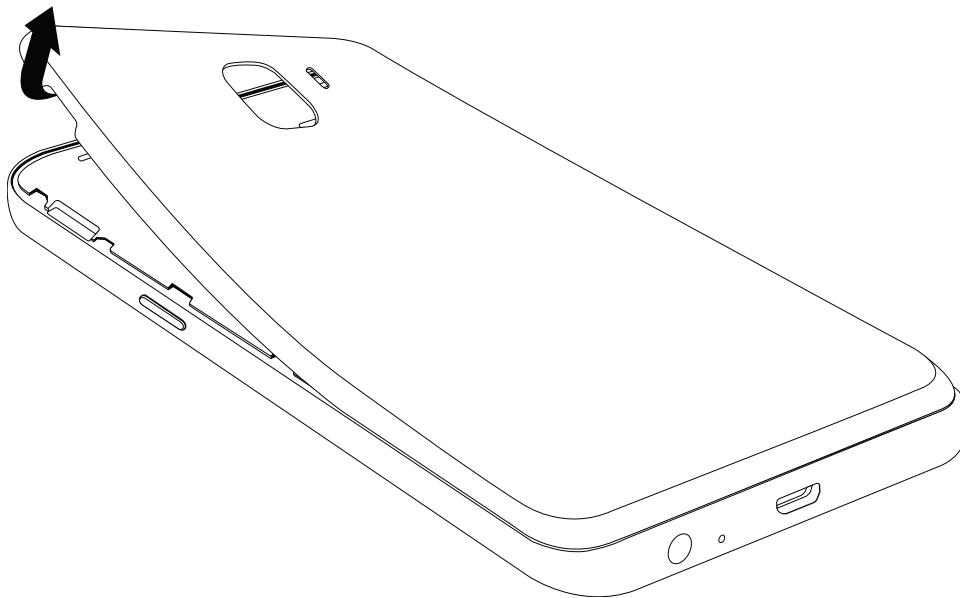

- Lift the cover up and to the left of the device.

To replace the back cover:

1. Place the back cover onto the back of the device and press down.
2. Press along the edge of the back cover until you have a secure seal.

Install a SIM card and memory card

When you subscribe to a cellular network, you are provided with a SIM card. You may be able to use your previous SIM card.

You can install an optional microSD™ memory card (not included) to add more memory space to your device. A memory card can be installed at any time. It is not necessary to install it prior to using the device.

1. Carefully slide the SIM card into the SIM card slot. Make sure that the card's gold contacts face down into the device and that the card is positioned as shown.

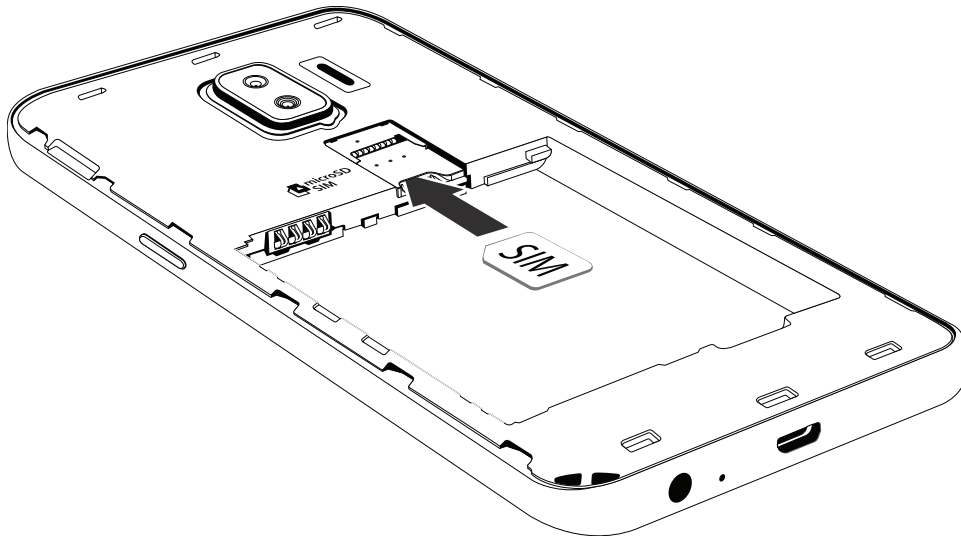

2. Slide the memory card into the slot with the gold contacts facing down.

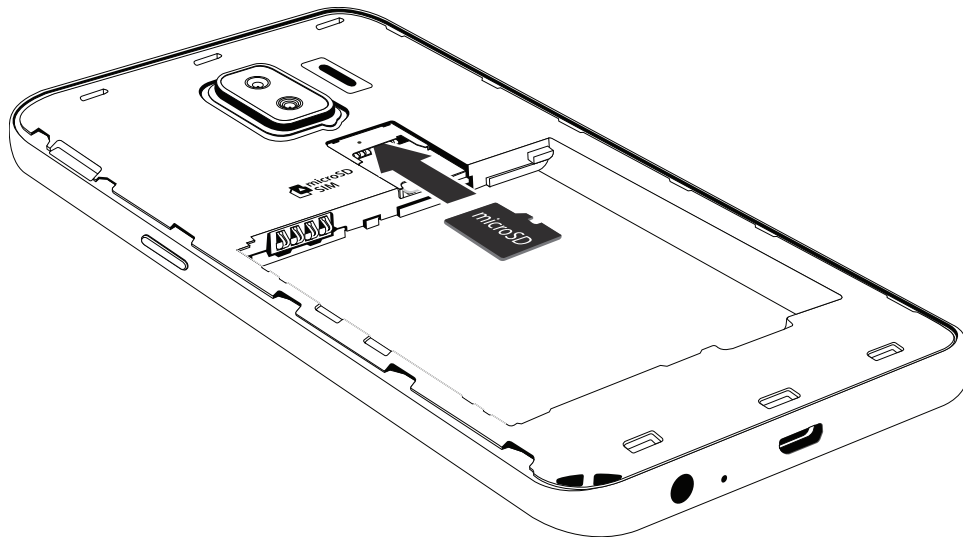

Replace the battery

The battery is installed in the back of the device.

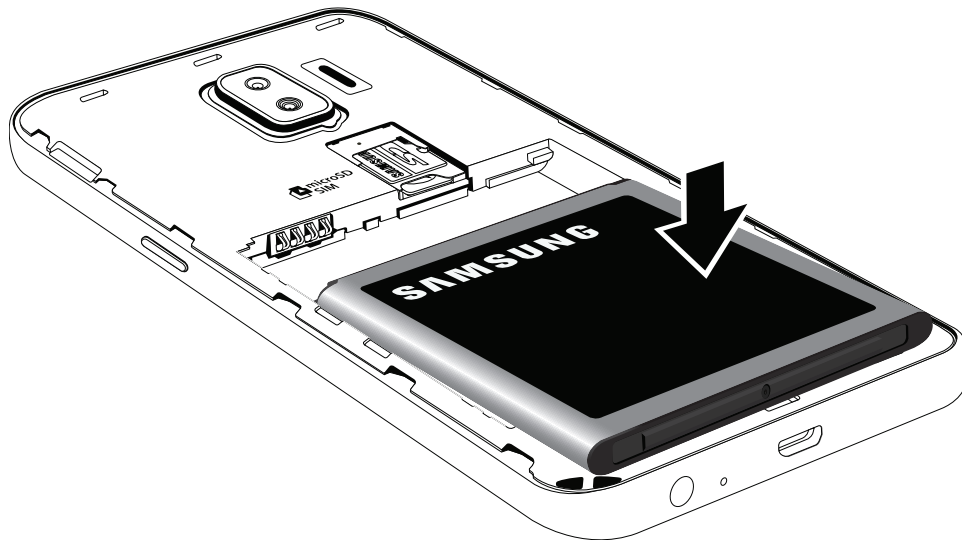

1. Insert the battery into the opening on the back of the device, making sure the connectors align.
2. Gently press down to secure the battery.

Charge the battery

Your device is powered by a rechargeable battery. A charger (charging head and USB cable) is included with the device for charging the battery from any standard outlet.

The battery comes partially charged. You can use the device while charging.

- 💡 Use only charging devices and batteries that are approved by Samsung. Samsung charging devices and batteries are designed for your device to maximize battery life. Using other charging devices and batteries may void your warranty and may cause damage.

1. Insert the USB cable into the USB charger/Accessory port.

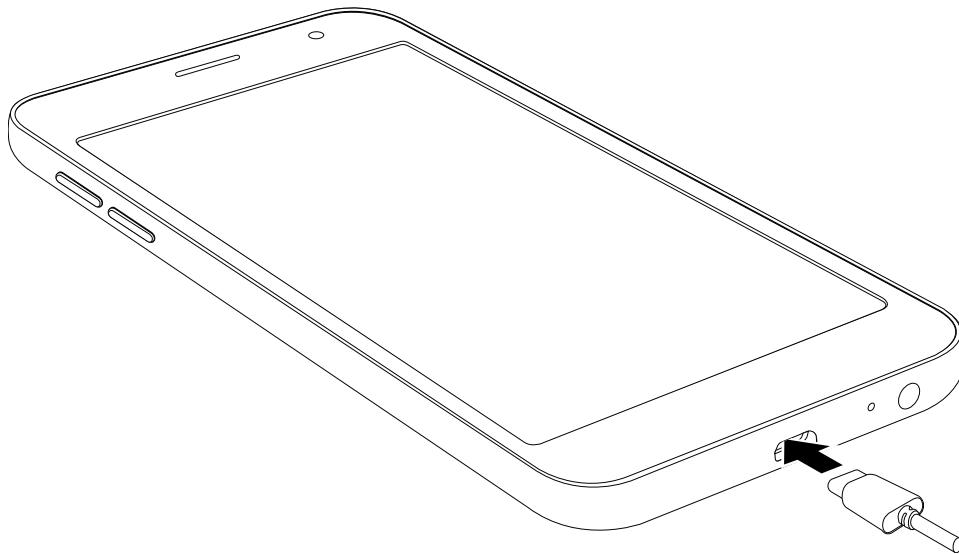

2. Connect the USB cable to the charging head, and then plug the charging head into a standard outlet.
3. Unplug the charging head from the outlet and remove the USB cable from the device when charging is complete.

While charging, the device and the charger may become hot and stop charging. This usually does not affect the device's lifespan or performance and is in the device's normal range of operation.

Disconnect the charger from the device and wait for the device to cool down. For more information, visit samsung.com/us/support/answer/ANS00076952.

Start using your device

Use the Power key to turn your device on or off.



Power key
Press and hold to
turn your phone
on or off.

Use the Setup Wizard

The first time you turn your device on, the Setup Wizard guides you through the basics of setting up your device.

Follow the prompts to choose a default language, connect to a Wi-Fi® network, set up accounts, choose location services, learn about your device's features, and more.

Lock or unlock your device

Use your device's screen lock features to secure your device. By default, the device locks automatically when the screen times out.



Power key

Press to lock.
Press and hold,
and then drag
your finger across
the screen to
unlock.

The default Screen lock on your device is Swipe. To choose a secure screen lock, see [Set a secure screen lock](#) on page 117.

Accounts

Set up and manage accounts, including email accounts, your Google account, and Samsung account.

-  Account may support email, calendars, contacts, and other features. See your service provider for more information.

Add a Google account

Your new device uses your Google™ account to fully utilize its Android™ features.

1. From Settings, tap **Cloud and accounts** > **Accounts**.
2. Tap  **Add account** > **Google**.

 When you sign in to a Google account, Factory Reset Protection (FRP) is activated. FRP requires your Google account information when resetting to factory settings. For more information, see **Factory data reset** on page 115.

Samsung account

You can enable backup of your information to your Samsung account.

- From Settings, tap **Cloud and accounts** > **Backup and restore** for options:
 - **Back up data:** Configure your Samsung account to back up your data.
 - **Restore data:** Use your Samsung account to restore your backup data.

Add an email account

View and manage all of your email accounts.

- From Settings, tap **Cloud and accounts** > **Accounts**, and then tap  **Add account** > **Email**.

Transfer data from your old device

Use Smart Switch™ to transfer contacts, photos, and other content from your old device.



For more information, visit samsung.com/us/support/owners/app/smart-switch.

1. From Settings, tap **Cloud and accounts** > **Smart Switch**.
2. Follow the prompts and select the content to transfer.

Visit samsung.com/smarts witch for more information.

Set up voicemail

You can access your voicemail from a Home screen.

1. From  **Phone**, tap  **Voicemail**.
2. Follow the tutorial to create a password, record a greeting, and record your name.

Navigation

Tap

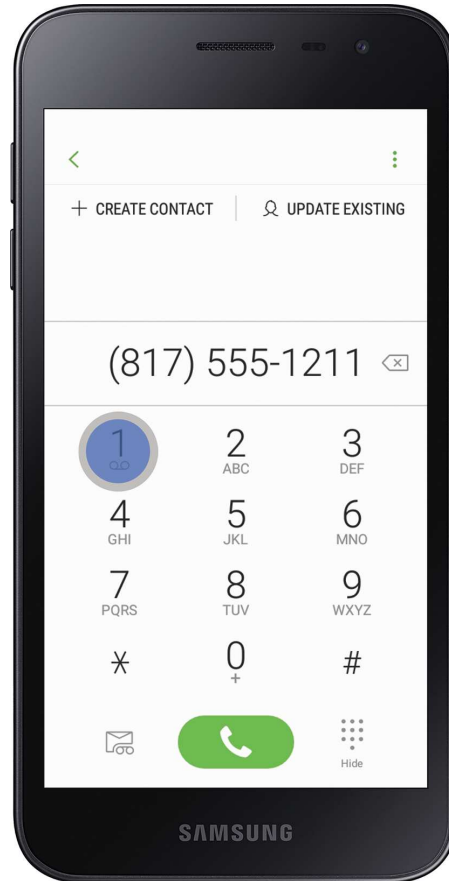

Lightly touch items to select or launch them.

- Tap the keyboard to enter characters or text.
- Tap an item to select it.
- Tap an app shortcut to launch the app.
- Double-tap an image to zoom in or out.

Swipe

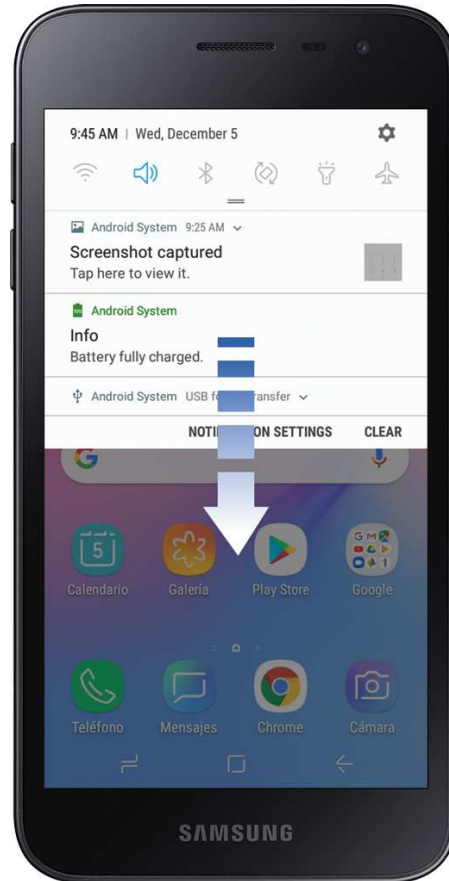

Lightly drag your finger vertically or horizontally across the screen.

- Swipe the screen to unlock the device.
- Swipe the screen to scroll through the Home screens or menu options.

Drag and drop



Touch and hold an item, and then move it to a new location.

- Drag an app shortcut to add it to a Home screen.
- Drag a widget to place it in a new location.

Zoom in and out



Pinch the screen using your thumb and forefinger or spread by moving your fingers apart.

- Pinch the screen to zoom out while viewing a picture or a web page.
- Spread your fingers on the screen to zoom in while viewing a picture or a web page.

Touch and hold







Touch and hold items to activate them.

- Touch and hold a field to display a pop-up menu of options.

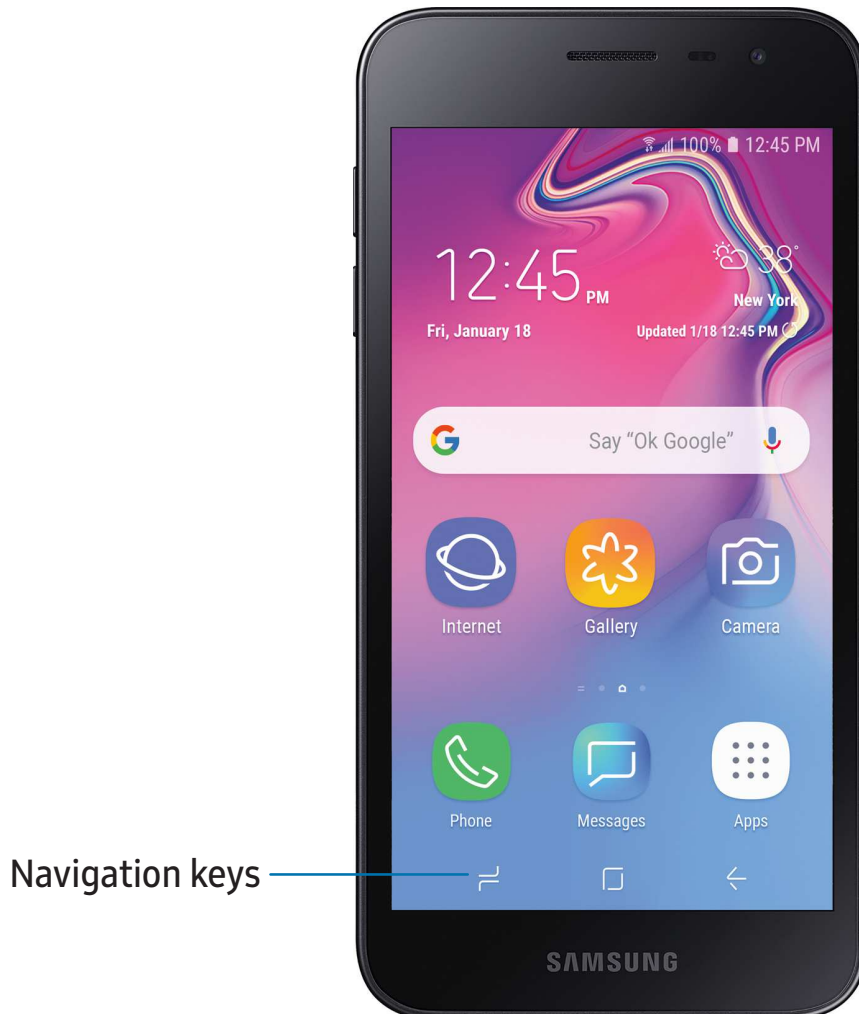
Navigation bar

The Navigation bar, at the bottom of the screen, displays the navigation keys.



- Tap  **Recent** to view all open apps.
- Tap  **Home** to return to the main home screen.
- Tap  **Back** to return to the previous screen.

Full screen mode

The navigation keys are hidden in full screen mode.

To enter or exit full screen mode:

- Double-tap the **Hide/Show** icon to the left of the navigation keys.

To view the navigation keys in full screen mode:

- Swipe up from the bottom of the screen to display the Navigation bar.

Navigation bar settings

You can configure the Navigation bar background color and button layout.

- From Settings, tap **Display** > **Navigation bar** for the following options:
 - **Show and hide button:** Add a button on the left side of the navigation bar to show or hide the Navigation bar.
 - **Background color:** Choose a color for the background of the Navigation bar.
 - **Button layout:** Choose the position of the navigation keys.

Customize the home screen

Your device has multiple Home screens to hold app shortcuts and widgets. You can add, remove, change the order of screens, as well as choose a different main Home screen.

App icons

You can use app icons to launch an app from any Home screen.

- From Apps, touch and hold an app icon to open the options menu, and then tap  **Add to Home**.

To remove an icon:

- Touch and hold an app icon to open the options menu, and then tap  **Remove from Home**.

 Removing a icon does not delete the app, it just removes the icon from a Home screen.

Use folders

You can organize app in folders on the Apps screens and Home screens.

For more information, see [Create and use folders](#) on page 39.

Wallpapers

You can change the look of the Home and Lock screens by choosing a favorite picture or preloaded wallpaper.

1. Touch and hold a Home screen.
2. Tap **Wallpapers** to customize.
3. Tap an image to choose it.
4. Tap **Set as wallpaper**, and confirm when prompted.

Icon frames

You can show icons with shaded frames to make them stand out on the Home screen and Apps list screen.

1. From Settings, tap **Display** > **Icon frames** and choose one of the following options:
 - **Icons only:** Show icons only.
 - **Icons with frames:** Show frames around icons.
2. Tap **Done**, and confirm when prompted.

Widgets

Widgets run on the home screen to give you quick access to info or apps.

1. Touch and hold a Home screen.
2. Tap **Widgets**.
3. Touch and hold a widget, drag it to a Home screen, and release it.

To remove a widget from a Home screen:

1. From a Home screen, touch and hold a widget to open the options menu.
2. Tap  **Remove from Home screen**.

Home screen settings

Customize your Home and Apps screens.

1. Touch and hold a Home screen.
2. Tap  **Home screen settings** to customize:
 - **Home screen layout:** Set your device to have separate Home and Apps screens, or only a Home screen where all apps are located.
 - **Home screen grid:** Choose a layout option to determine how icons are arranged on the Home screen.
 - **Apps screen grid:** Choose a layout option to determine how icons are arranged on the Apps screen.
 - **Apps button:** Add a button to the Home screen for easy access to the Apps screen.

- **App icon badges:** Select how to show icon badges when apps receive notifications.
- **Add apps to Home screen:** Automatically add newly-downloaded apps to the Home screen.
- **Quick-open notification panel:** Enable this feature to open the Notification panel from the Home screen by swiping down.
- **Portrait mode only:** Prevent the Home screen from rotating to Landscape mode.
- **Hide apps:** Select apps to hide.
- **About Home screen:** View version information.

Easy mode

Switch between the default screen layout and a simpler layout. The Easy mode layout has larger text and icons, making for a more straightforward visual experience.

1. From Settings, tap **Display** > **Easy mode**.
2. Tap **Easy mode** to enable this feature.
3. Tap **Done** to confirm.

To disable Easy mode:

1. From Settings, tap **Display** > **Easy mode** > **Standard mode**.
2. Tap **Done** to exit Easy mode.

Status bar

The Status bar provides device information on the right side and notification alerts on the left.

Status icons



Battery full



Battery low



Charging



Vibrate



Mute



Airplane mode



Bluetooth active



NFC active



Wi-Fi active



Location active

Notification icons



Missed calls



Call in progress



Call on hold



New email



Voicemail



New message



Download



Upload



Wi-Fi available



App update

Configure display options for the Status bar.

- From Settings, tap **Display > Status bar** for the following options:
 - Tap **Show recent notifications only** to display only the three most recent notification icons on the Status bar.
 - Tap **Show battery percentage** to display the battery charge percentage next to the battery icon on the Status bar.

Notification panel

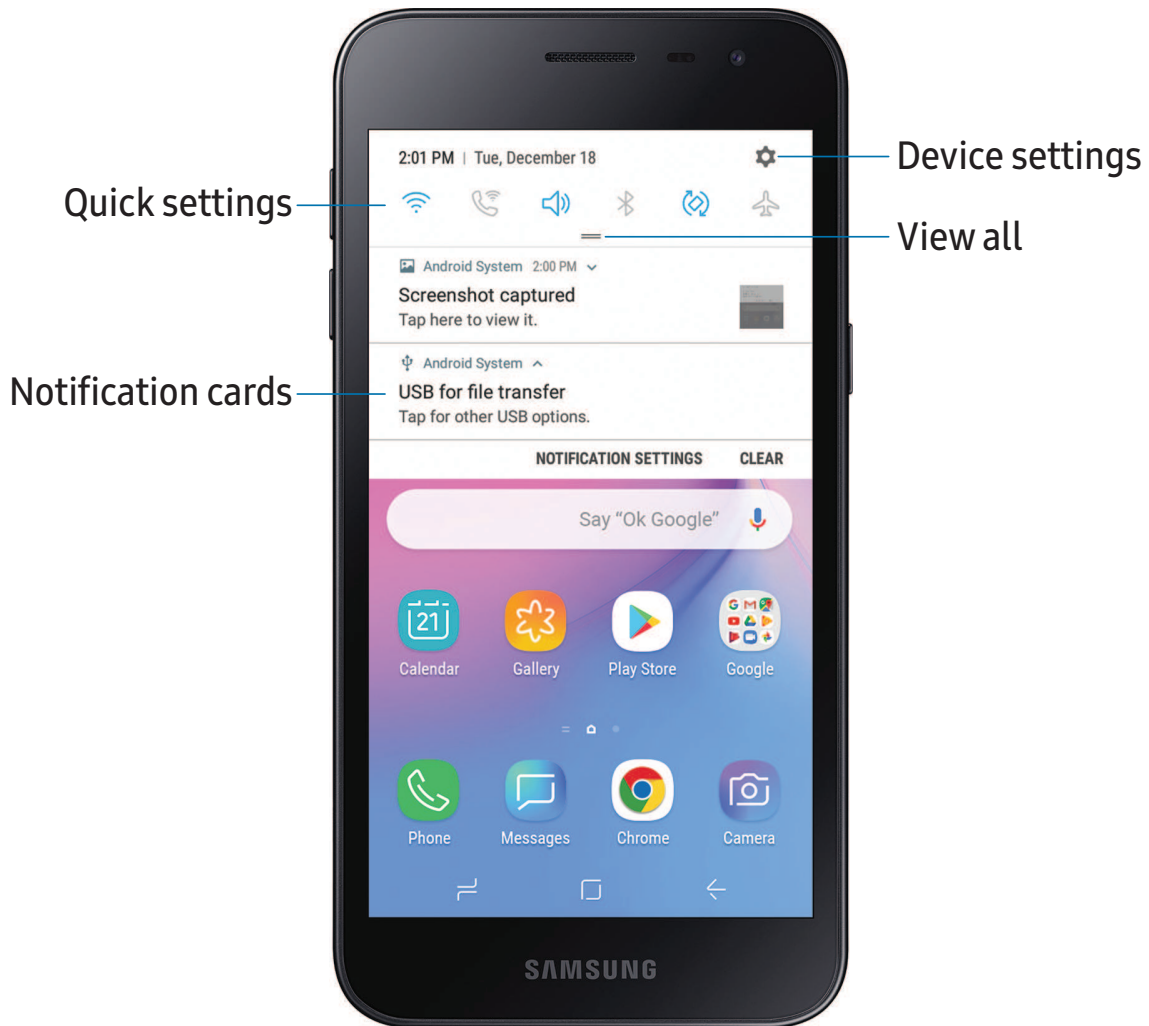





View the Notification panel

You can access the Notification panel from any screen.

1. Drag the Status bar down to display the Notification panel.
2. Swipe down the list to see notification details.
 - To open an item, tap it.
 - To clear a single notification, drag the notification left or right.
 - To clear all notifications, tap **Clear**.
3. Drag upward from the bottom of the screen or tap  **Back** to close the Notification panel.

Quick settings

The Notification panel also provides quick access to device functions, allowing you to quickly turn them on or off.

1. Drag the Status bar down to display the Notification panel.
2. Drag  **View all** downward.
 - Tap a quick setting icon to turn it on or off.
 - Touch and hold a quick setting icon to open the setting.
 - Tap  **Search** to search the device.
 - Tap  **Settings** to quickly access the device's settings menu.
 - Tap  **More options** to reorder Quick settings or to change the button layout.
3. Drag  **View all** upward to close Quick settings.

Bixby

Bixby is a virtual assistant that learns, evolves, and adapts to you. It learns your routines, helps you set up reminders based on time and location, and is built in to your favorite apps. Visit samsung.com/us/support/owners/app/Bixby for more information.

Bixby Home



The Bixby Home page displays customized content based on your interactions. Bixby learns from your usage patterns and will suggest content you may like.

- From a Home screen, swipe right.

Multi window

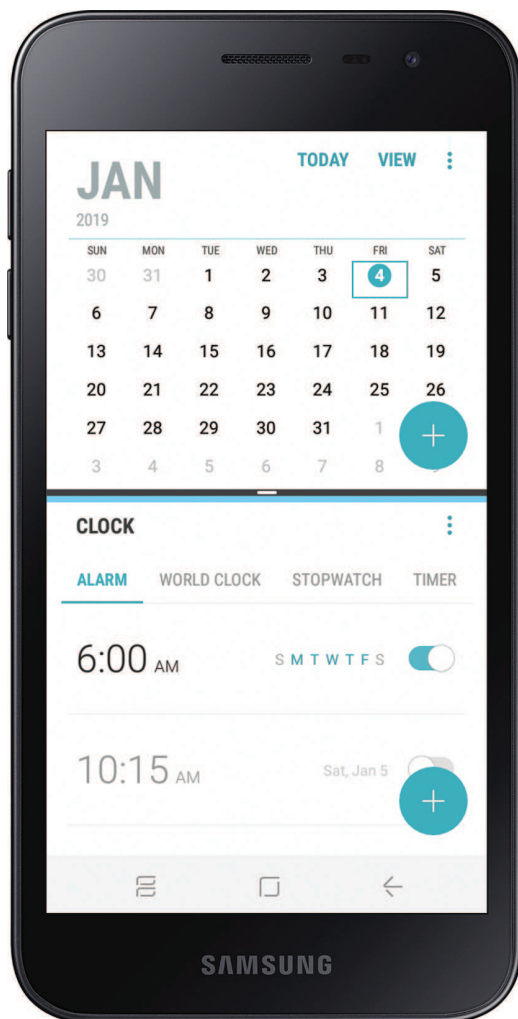

Multitask by using two apps at the same time. Apps that support Multi window™ can be displayed together on a split screen. You can switch between the apps and adjust the size of their windows.



1. From any screen, tap  **Recent apps**.
2. Tap  **Multi window** in the title bar to launch an app in split screen view.
 - Recently opened apps are displayed in the lower window. Apps that support Multi window have the  **Multi window** icon in their title bar.
 - If there are no recently opened apps that support Multi window, or if you want to launch a different app, tap **App list**.
3. Tap an app in the lower window to add it to the split screen view.





Window controls

The Window controls modify the way app windows are displayed in split screen view.

- Tap the middle of the window border for the following options:
 -  **Add app pair on Home screen:** Add the open pair of apps as a shortcut to the Home screen.
 -  **Switch windows:** Swap the two windows.
 -  **Close app:** Close the selected app.

Split screen view action



The Recent apps key can be configured to switch between full screen view and split screen view.

1. From Settings, tap  **Advanced features** > **Multi window**, and then tap  to enable **Split screen view action**.
2. To use  **Recent apps** to switch between views:
 - To change the current app from full screen view to split screen view, touch and hold  **Recent apps**.
 - While in split screen view, touch and hold  **Recent apps** to close the app on the bottom.

Enter text

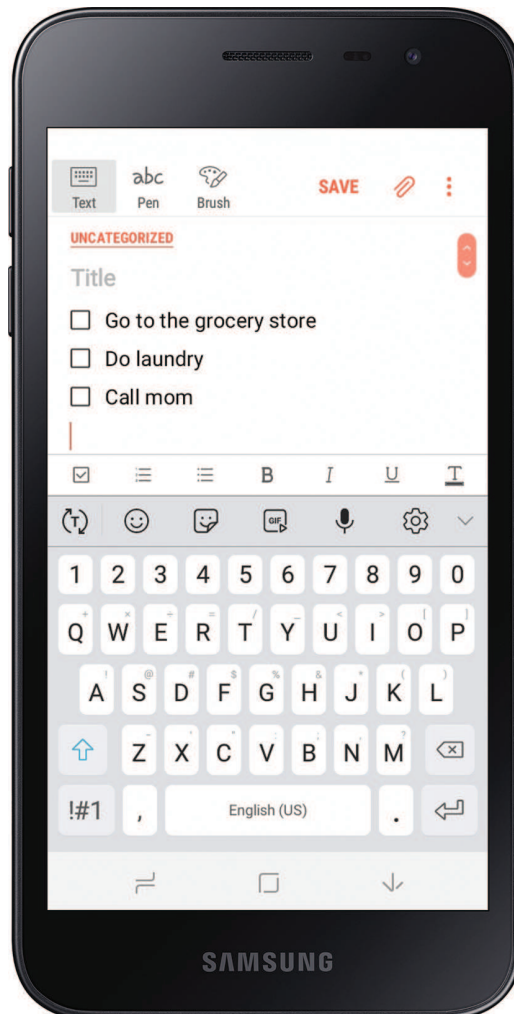







Text can be entered using a keyboard or your voice.



- Tap a field to display the Samsung keyboard.
 - Tap  Show predictive text to view suggested words while you type.
 - Tap  Show toolbar functions to view all keyboard options.

Toolbar functions

The toolbar provides additional helpful functions.

- From the Samsung keyboard, tap  **Expand toolbar** for the following options:
 -  **Clipboard**: Access the clipboard.
 -  **Emojis**: Insert an emoji.
 -  **GIF keyboard**: Add animated GIFs.
 -  **One-handed keyboard**: Change the keyboard layout for use with one hand.
 -  **Settings**: Access keyboard settings.
 -  **Stickers**: Add illustrated stickers.
 -  **Voice input**: Use Google Voice™ typing.

Configure the Samsung keyboard

Set customized options for the Samsung keyboard.

- From the Samsung keyboard, tap  **Settings** for the following options:
 - **Languages and types**: Set the keyboard type and choose which languages are available on the keyboard.
 - To switch between languages, slide the Space bar sideways.
 - **Smart typing**: Use predictive text and auto-correction features to prevent common typing mistakes. Type by swiping between letters.
 - **Keyboard layout and feedback**: Customize the appearance and function of the keyboard.
 - **Reset to default settings**: Return keyboard to original settings and clear personalized data.
 - **About Samsung keyboard**: View version and legal information for the Samsung keyboard.

Use Google Voice typing

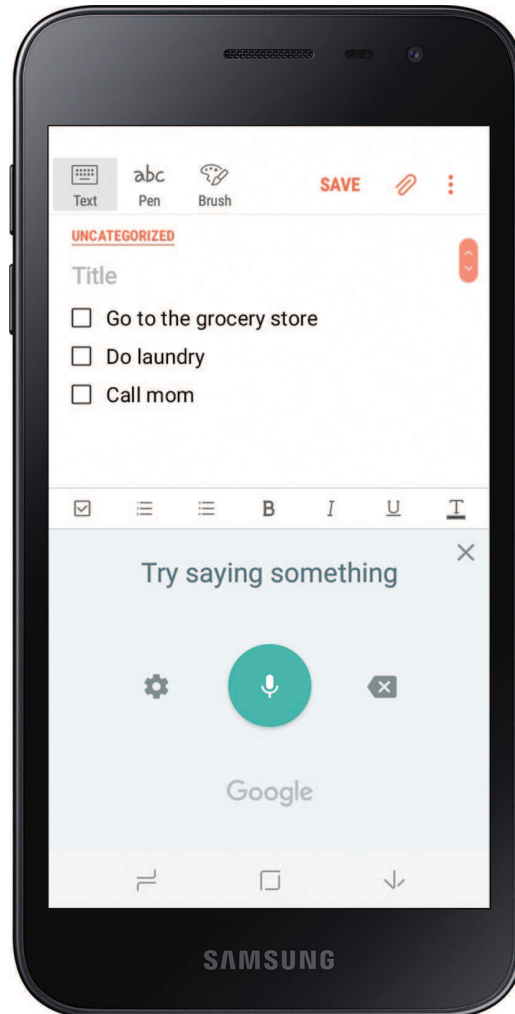

Instead of typing, enter text by speaking.



1. From the Samsung keyboard, tap  Voice input.
2. Tap the screen and speak your text.

Configure Google Voice typing

Set customized options for Google voice typing.

1. From the Samsung keyboard, tap  **Voice input**.
2. Tap  **Settings** for options.
 - **Languages:** Choose the language for the keyboard.
 - **Offline speech recognition:** Download languages for offline Google voice typing.
 - **Block offensive words:** Hide potentially offensive words with asterisks.

Emergency mode

Use Emergency mode to access helpful emergency features and conserve your device's power during an emergency situation.

To save battery power, Emergency mode:

- Restricts application usage to only essential applications and those you select.
- Turns off connectivity features and Mobile data when the screen is off.

Activate Emergency mode



To activate Emergency mode:

1. Press and hold the **Power** key.
2. Tap **Emergency mode**.
 - When accessing for the first time, read and accept the terms and conditions.
3. Tap **Turn on**.

Emergency mode features

While in Emergency mode, only the following apps and features are available on the Home screen:

- **Flashlight:** Use the device's flash as a steady source of light.
- **Emergency alarm:** Sound an audible siren.

- **Share my location:** Send your location information to your emergency contacts.
- **Phone:** Launch the call screen.
- **Internet:** Launch the web browser.
-  **Add**
 - **Email:** Launch the Email app.
 - **Maps:** Launch Google Maps™.
-  **Battery charge:** Display estimated battery charge remaining.
- **Estimated usage time remaining:** Display estimated standby time that can be reached based on current battery charge and usage.
- **Emergency call:** Dial the emergency telephone number (for example, 911). This kind of call can be made even without activated cellular service.
-  **More options:**
 - **Turn off Emergency mode:** Disable Emergency mode and return to standard mode.
 - **Remove:** Choose apps to remove from the screen.
 - **Manage emergency contacts:** Manage your medical profile and ICE (In Case of Emergency) group contacts.
 - **Settings:** Configure the available settings. Only a limited number of settings are enabled in Emergency mode.

Turn off Emergency mode

When emergency mode is turned off, the device returns to standard mode.

1. Press and hold the **Power** key.
2. Tap **Emergency mode**.

 When Emergency mode is activated, Locating method is set to Battery saving. After Emergency mode is turned off, check your location settings. For more information, see **Location** on page 96.

Apps

Using apps

Samsung apps

Google apps

Carrier apps

Additional apps



Using apps

The Apps list displays all preloaded and downloaded apps. Apps can be downloaded from Galaxy Apps and the Google Play store. Not all apps can be uninstalled, but you can disable them to remove them from view.

- From a Home screen, swipe the screen upward to access the Apps list.

Add an apps shortcut

In addition to swiping to access apps, you can add an Apps button to the Home screen.

1. From Apps, tap  **More options** > **Home screen settings** > **Apps button**.
2. Tap **Show Apps button** > **Apply**.

Search for apps

If you are not sure where to find an app or a setting, you can use the Search feature.

- From Apps, tap  **Search phone**, enter a word(s), and tap a result to go to that app.

 To customize the Finder search settings, tap  **More options** > **Settings**.

Uninstall or disable apps

If you want to remove apps from your device, you can uninstall or disable them.



 Some preloaded apps can only be disabled, not uninstalled. Disabled apps are turned off and hidden from view.

- From Apps, touch and hold an app and tap **Uninstall/Disable**.

Sort apps



App shortcuts can be listed alphabetically or in your own custom order.

- From Apps, tap  **More options** > **Sort** for the following sorting options:
 - **Custom order:** Arrange apps manually.
 - **Alphabetical order:** Sort apps alphabetically.

 When apps are arranged manually (Custom order), empty icon spaces can be removed by tapping  **More options** > **Clean up pages**.

Create and use folders

You can make folders to organize App shortcuts on the Apps list.

1. From Apps, touch and hold an app shortcut, and then drag it on top of another app shortcut until it is highlighted.
2. Release the app shortcut to create the folder.
 - **Enter folder name:** Name the folder.
 -  **Palette:** Change the folder color.
 -  **Add apps:** Place more apps in the folder. Tap apps to select them, and then tap **Add**.
3. Tap  **Back** to close the folder.

Copy a folder to a Home screen

You can copy a folder to a Home screen.

1. From Apps, touch and hold a folder to open the options menu.
2. Tap  **Add to Home**.

Delete a folder

When you delete a folder, the app shortcuts return to the Apps list.

1. From Apps, touch and hold a folder to delete.
2. Tap  **Delete folder**, and confirm when prompted.

Apps settings



You can customize Apps settings like permissions and notifications.

 Use these features to monitor how an app affects your device usage.

1. From Settings, tap  **Apps**.
2. Tap an app for the following options:
 - **Uninstall/Disable:** Uninstall or disable the app.
 - **Force stop:** Stop an app that is not working correctly.
 - **Mobile data:** Monitor and restrict mobile data usage.
 - **Battery:** View battery usage since the last full charge.
 - **Storage:** Manage the app's storage usage.
 - **Memory:** View memory usage.
 - **Notifications:** Configure notifications from the app.
 - **Permissions:** View permissions granted to the app for access to your device's information.
 - **Set as default:** Set the app as a default for a certain category of apps.

Customize the Apps settings view

Manage your downloaded and preloaded apps.

1. From Settings, tap  **Apps** >  **Menu** to set which apps to view.
2. Tap  **More options** for the following options:
 - **Sort by size/name:** Sort the apps by size or name.
 - **Default apps:** Choose or change apps that are used by default for certain features, like email or browsing the Internet.
 - **App permissions:** Control which apps have permissions to use certain features of your device.
 - **Show/Hide system apps:** Show or hide system (background) apps.
 - **Special access:** Select which apps can have special access permissions to features on your device.
 - **Reset app preferences:** Reset options that have been changed. Existing app data is not deleted.

Samsung apps

The following apps are either preloaded or downloaded over-the-air to your device during setup.

Galaxy Essentials

You can find and download apps that are designed for your Galaxy device.

- From Apps, tap  **More options** > **Galaxy Essentials**.



Galaxy Apps

Find and download premium apps that are exclusive to Galaxy devices. A Samsung account is required to download from Galaxy Apps.

- From Apps, tap **Samsung** folder >  **Galaxy Apps**.



Samsung+

Samsung+ allows you to access live customer support, view device diagnostics, and learn about your registered Samsung devices.

For more information, visit samsung.com/us/samsung-plus.

- From Apps, tap  **Samsung+**.



Samsung Health

In addition to managing health records and fitness goals, Samsung Health™ allows you to use the following features:

- Take part in group challenges
- Discover health related content
- Record lifestyle information like food, and caffeine intake

For more information, visit samsung.com/us/support/owners/app/samsung-health.

○ From Apps, tap **Samsung** folder >  **Samsung Health**.



The information gathered from this device, Samsung Health, or related software is not intended for use in the diagnosis of disease or other conditions, or in the cure, mitigation, treatment or prevention of disease.

Before you start exercising

Although the Samsung Health application is a great companion to your exercise routine, it is always best to make sure you consult with your physician before beginning any exercise regimen. While moderate physical activity, such as brisk walking, is safe for most people, health experts suggest that you talk with your doctor before you start an exercise program, particularly if you have any of the following conditions:

- Heart disease; asthma or lung disease; diabetes, or liver or kidney disease; arthritis.

Before beginning your exercise regimen check with your doctor if you have symptoms suggestive of heart, lung, or other serious disease, such as:

- Pain or discomfort in your chest, neck, jaw, or arms during physical activity;
- Dizziness or loss of consciousness;
- Shortness of breath with mild exertion or at rest, or when lying down or going to bed;
- Ankle swelling, especially at night;

- A heart murmur or a rapid or pronounced heartbeat;
- Muscle pain when walking upstairs or up a hill that goes away when you rest.

It is recommended that before engaging in an exercise routine, you consult with your doctor or medical practitioner. If you are unsure of your health status, have several health problems, or are pregnant, you should speak with your doctor before starting a new exercise program.

The accuracy of the information and data provided by this device and its related software, including heart rate readings, may be affected by factors such as environmental conditions, skin condition, specific activity performed while using/wearing the device, settings of the device, user configuration/user-provided information, placement of the sensor on the body, and other end-user interactions.

For more information on proper wear and use, visit samsung.com/us/heartratesensor.

Samsung Notes

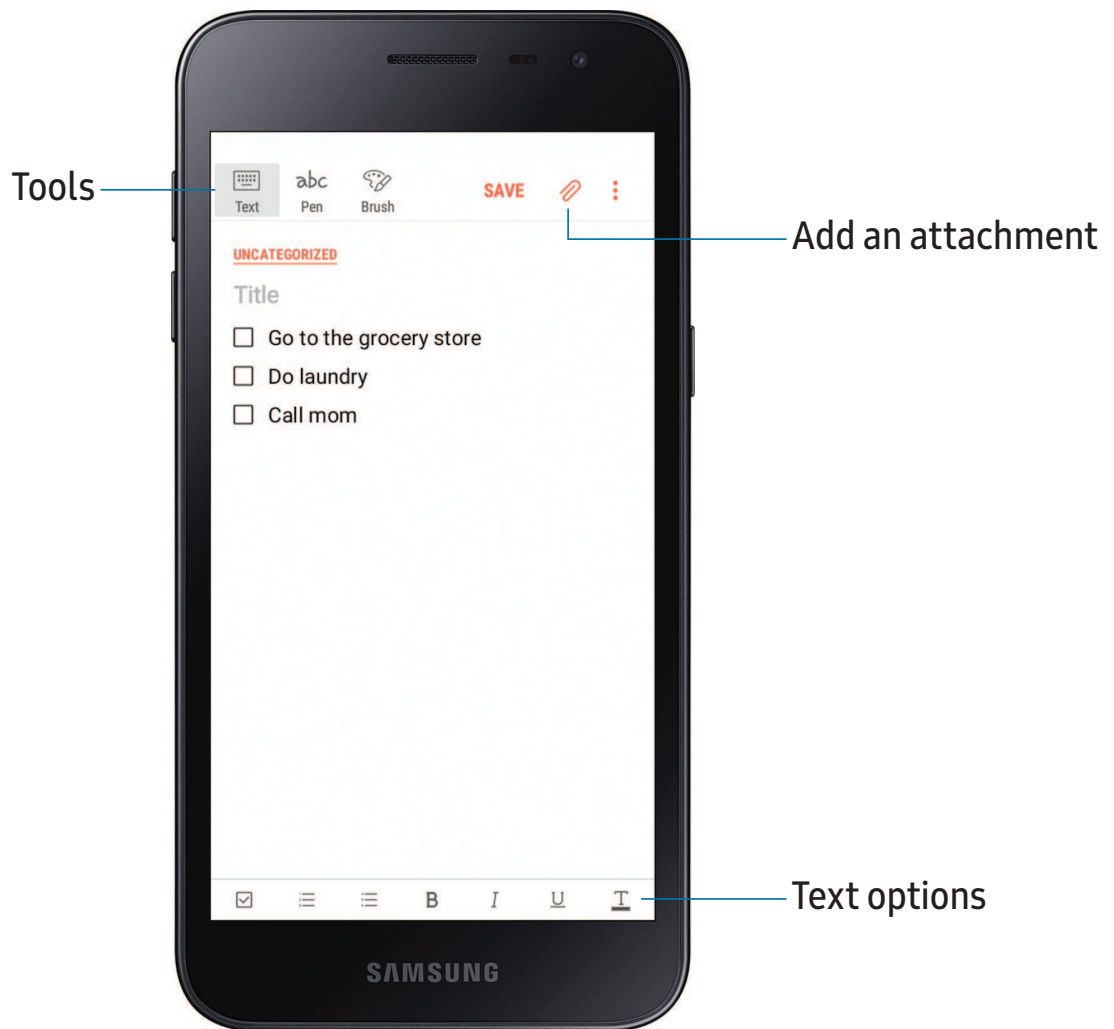

Use Samsung Notes to write and save notes. For more information, visit samsung.com/us/support/owners/app/samsung-notes.

- From Apps, tap Samsung folder >  Samsung Notes.



Browse notes

Browse notes you create.

- From  **Samsung Notes**:
 - Browse note entries by swiping up or down.
 - To search for a note, tap  **Search**.



Edit notes

Make edits to notes you create.

1. From  **Samsung Notes**, tap a note to view it.
2. Tap **Edit** to make changes.
3. Tap **Save**.

Notes options

You can edit, share, or manage notes.

- From  **Samsung Notes**, tap  **More options** for the following options:
 - **Edit**: Select notes to share, delete, or move.
 - **Sort by**: Change the way notes are organized.
 - **List/Grid view**: Switch between List view and Grid view.
 - **Trash**: View deleted notes.
 - **Settings**: View settings for the Samsung Notes app.

Calculator

The Calculator app features both basic and scientific math functions, as well as a unit converter.

- From Apps, tap  Calculator.

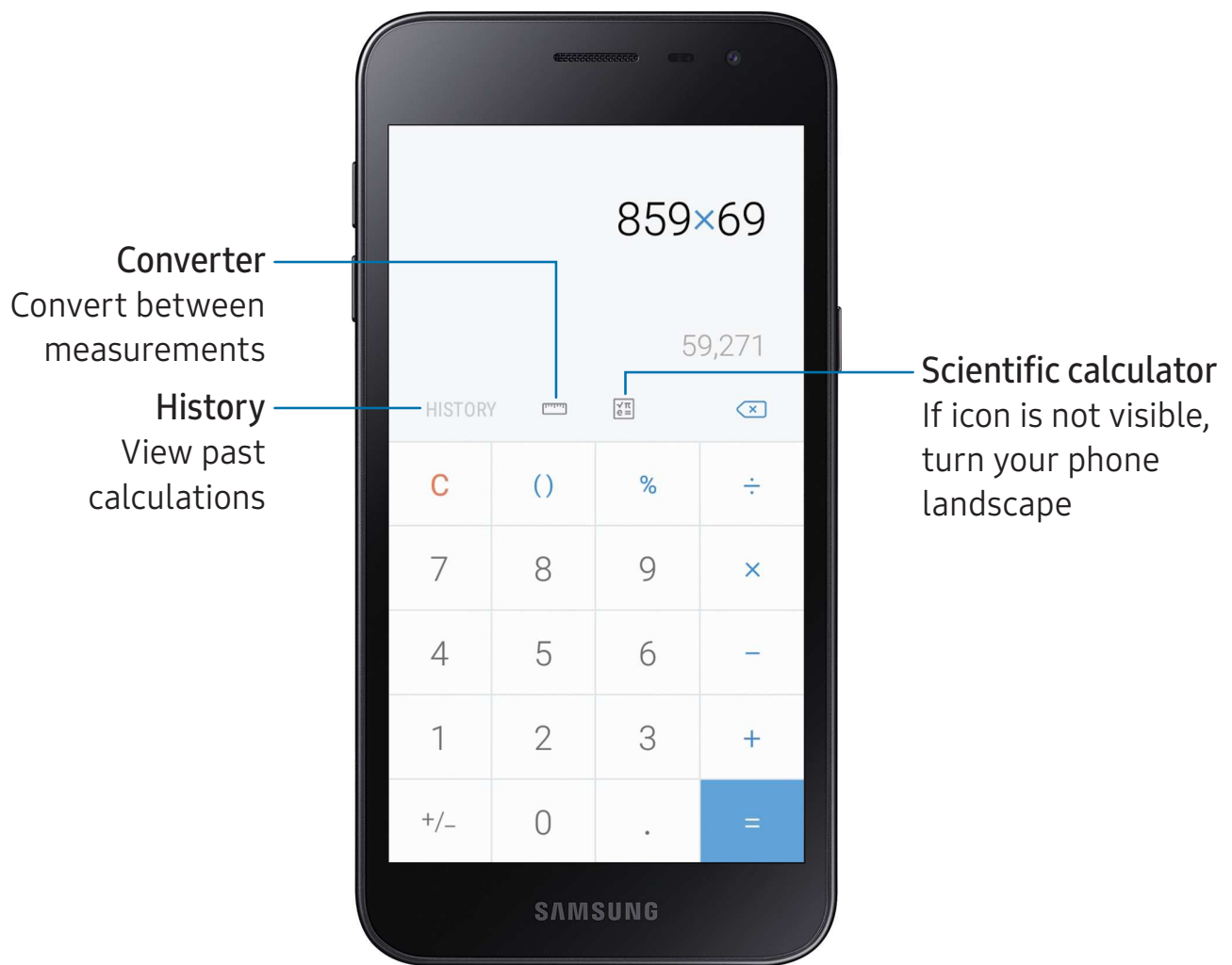

Calendar

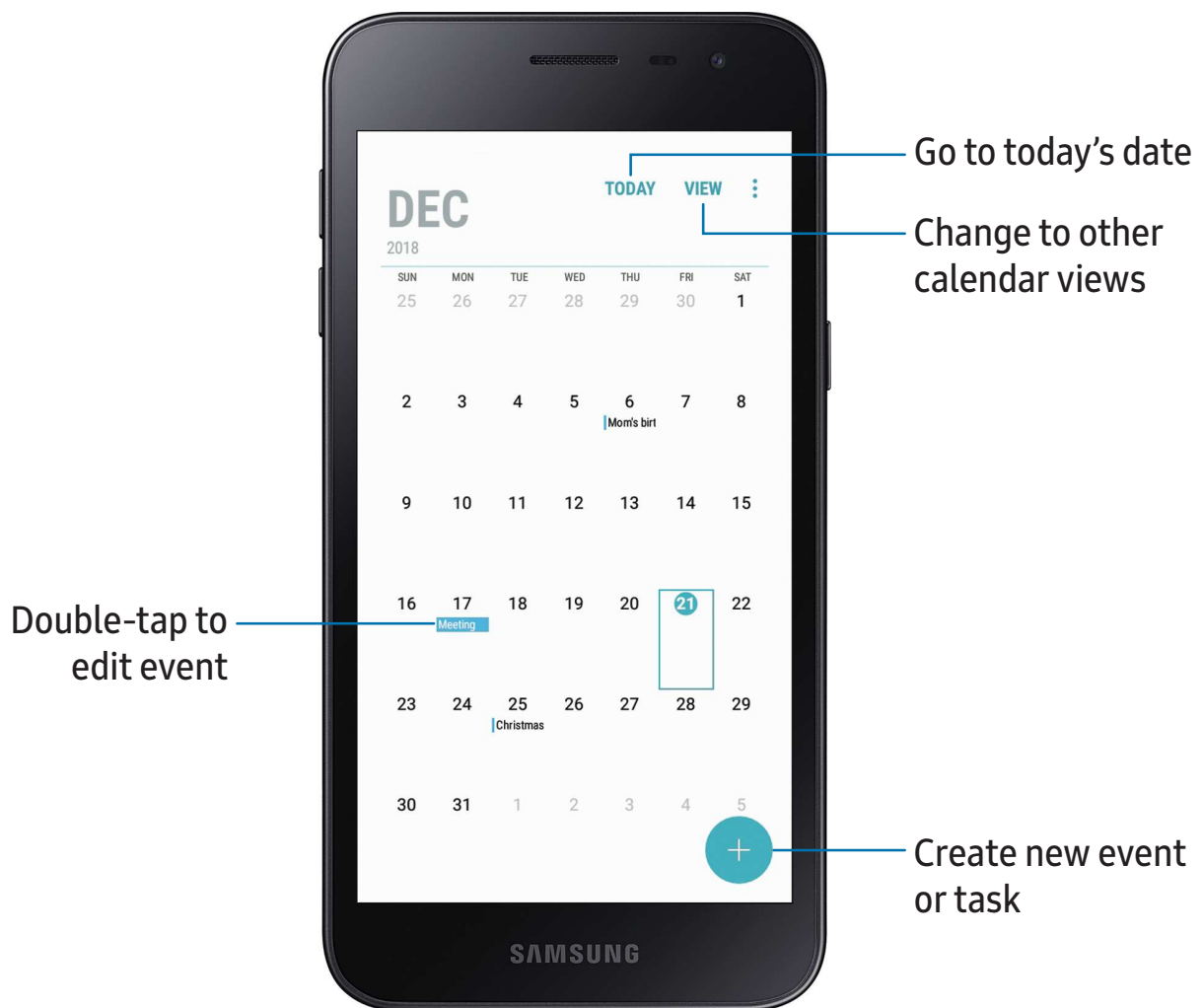

The Calendar app can be connected to your various online accounts to consolidate all your calendars in one place.

- From Apps, tap  Calendar.





Add calendars

Add existing calendars to the Calendar app.

1. From  Calendar, tap  **More options**.
2. Tap **Manage calendars** >  **Add account**, and select an account type.
3. Enter your account information and follow the prompts.

Create a task

Use your Calendar to create tasks. Tasks are items you add to the calendar to be accomplished on a certain day. A task displays as a checklist item and is removed once you mark the task as complete.

1. From  Calendar, tap **View** > **Tasks**.
2. Tap  **Add** to add a task.
3. Enter details for the task, and then tap **Save**.

Delete a task

Delete tasks from your Calendar.

1. From  Calendar, tap **View** > **Tasks**.
2. Tap the **Checkbox** by the task to mark it as complete and remove it from the calendar.
 - To delete a task, tap the task to open it, tap **Delete**, and confirm when prompted.

Camera



You can capture high-quality pictures and videos using the Camera app.

- From Apps, tap  Camera.



Navigate the camera screen

Take stunning pictures with your device's front and rear cameras.

1. From  **Camera**, set up your shot with the following features:
 - Tap the screen where you want the camera to focus.
 - When you tap the screen, a brightness scale appears. Drag the light bulb to adjust the brightness.
 - To quickly switch between the front and rear cameras, swipe the screen up or down.
 - To change to a different shooting mode, swipe the screen right or left.
 - To change camera settings, tap  **Settings**.
2. Tap  **Capture**.

Shooting modes

Allow the camera to determine the ideal mode for your pictures or choose from several shooting modes.

- From Apps, tap  **Camera**, and swipe to the right or left to see the available shooting modes. To view and reorganize shooting modes, touch and hold a shooting mode.

Rear camera

- **Panorama**: Create a linear image by taking pictures in either a horizontal or vertical direction.
- **Pro**: Manually adjust the ISO sensitivity, exposure value, white balance, and color tone while taking pictures.
- **Beauty**: Automatically airbrush out minor imperfections when you take pictures of people.
- **Auto**: Allow the camera to determine the ideal mode for the picture.
- **Stickers**: Add stickers to your pictures.
- **Continuous shot**: Touch and hold the Camera button to take multiple photos.
- **Sports**: Take clearer pictures of fast moving subjects.

Front camera

- **Selfie:** Take selfie shots and apply various effects, such as an airbrushed effect.
- **Stickers:** Add stickers to your selfies.
- **Wide selfie:** Take wide-angle selfie shots to fit more people into your pictures.

Camera settings

Use the icons on the main camera screen and the settings menu to configure your camera's settings.

- From Apps, tap  **Camera** >  **Settings**.

Rear camera

- **Picture size:** Select a resolution. Selecting a higher resolution for higher quality requires more memory.
- **Video size:** Select a resolution. Selecting a higher resolution for higher quality requires more memory.
- **Timer:** Take time-delayed pictures or videos.
- **HDR (rich tone):** Enables the light sensitivity and color depth features of the device to produce a brighter and richer picture.

Front camera

- **Picture size:** Select a resolution. Selecting a higher resolution for higher quality requires more memory.
- **Video size:** Select a resolution. Selecting a higher resolution for higher quality requires more memory.
- **Timer:** Take time-delayed pictures or videos.
- **Save pictures as previewed:** Save self-portraits or self-recordings as viewed on the camera screen, not as flipped images.
- **Shooting methods:** Create a shortcut to take pictures.

Common

- **Edit camera modes:** Enable, disable, and rearrange shooting modes.
- **Grid lines:** Display viewfinder grid lines to help compose a picture or video.
- **Location tags:** Attach a GPS location tag to the picture.
- **Review pictures:** Review pictures after taking them.
- **Quick launch:** Press the Power key twice in quick succession to open the camera.
- **Storage location:** Select a memory location.
 - A memory card (not included) must be installed to view Storage location.
- **Floating Camera button:** Add an extra camera button that you can move anywhere on the screen in Auto and Selfie modes.
- **Press Volume key to:** Use the Volume key to take pictures, record video, zoom, or control system volume.
- **Shutter sound:** Play a tone when taking a picture.
- **Reset settings:** Reset the camera settings.

Clock

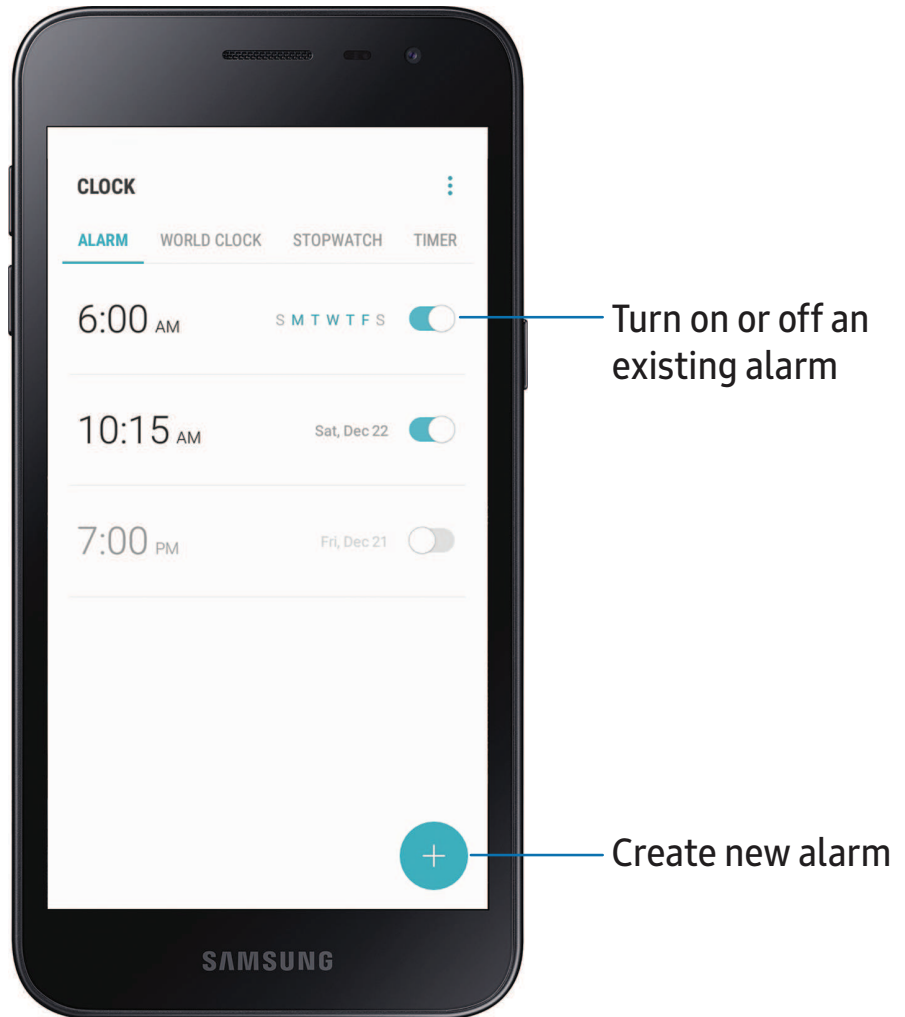

The Clock app offers features for keeping track of time and setting alarms.

- From Apps, tap  Clock.



Alarm

Use the Alarm tab to set one-time or recurring alarms, and choose options for how to be notified.

1. From  **Clock**, tap  **Add alarm**.
2. Tap the following items to configure an alarm:
 - **Date**: Choose the day for this alarm.
 - **Time**: Set a time for the alarm.
 - **Repeat**: Choose when to repeat the alarm.
 - **Alarm name**: Enter a name for the alarm.
 - **Snooze**: Allow snoozing. Set interval and repeat values for the alarm while snoozing.
 - **Alarm sound**: Choose a sound to play for the alarm, and drag the slider to set the volume of the alarm.
 - **Vibration**: Choose whether the alarm uses vibration alert.
 - **Read time aloud**: Read the time aloud when the alarm rings.
3. Tap **Save** to save the alarm.

Dismiss an alarm

At the set alarm time, the phone sounds the alarm and/or vibrates.

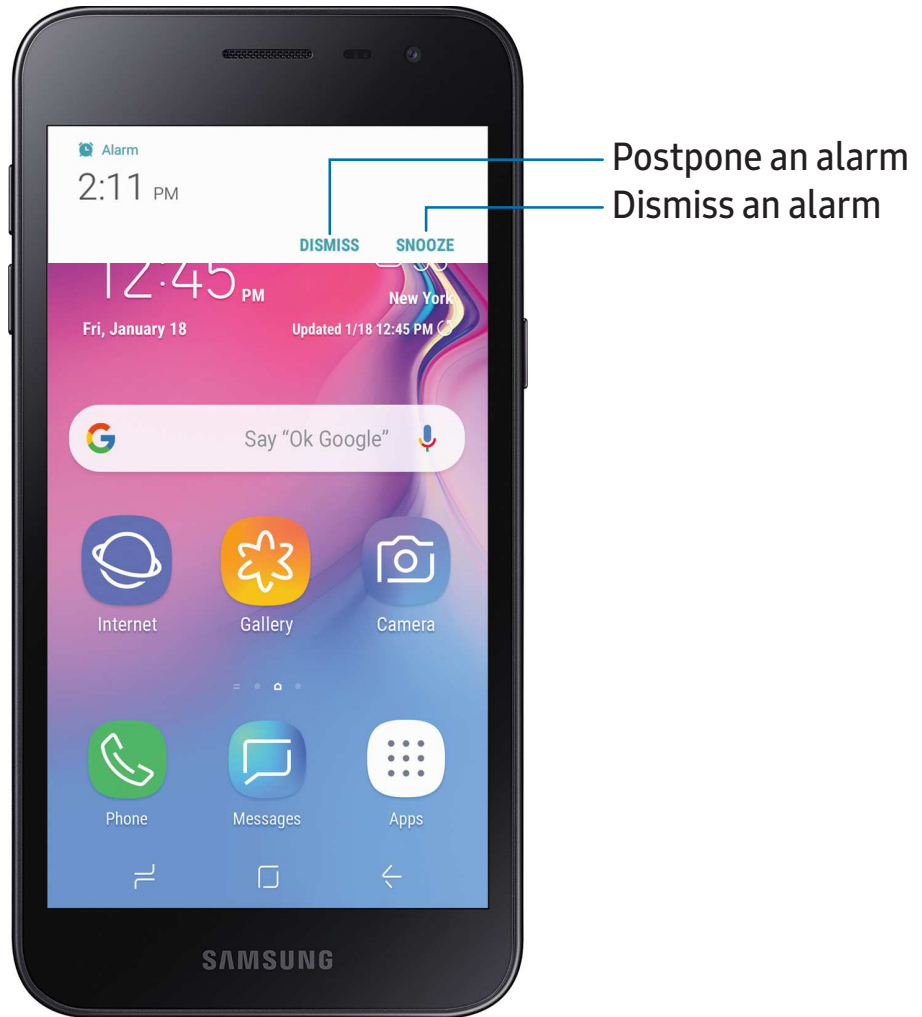

Delete an alarm

You can delete an alarm that you created.

- From  **Clock**, touch and hold an alarm, and then tap **Delete**.

Stopwatch

The Stopwatch lets you time events down to a hundredth of a second.

1. From  **Clock**, tap **Stopwatch**.
2. Tap **Start** to begin timing.
 - To keep track of lap times, tap **Lap**.
3. Tap **Stop** to end timing.
 - To continue timing after stopping the clock, tap **Resume**.
 - To reset the Stopwatch to zero, tap **Reset**.

Timer



Set a countdown timer for up to 99 hours, 59 minutes, and 59 seconds.

1. From  **Clock**, tap **Timer**.
2. Use the keypad and tap **Hours**, **Minutes**, and **Seconds** to set the Timer.
3. Tap **Start** to begin the Timer.
 - To temporarily stop the Timer, tap **Pause**. To continue, tap **Resume**.
 - To stop and reset the Timer, tap **Cancel**.

World clock

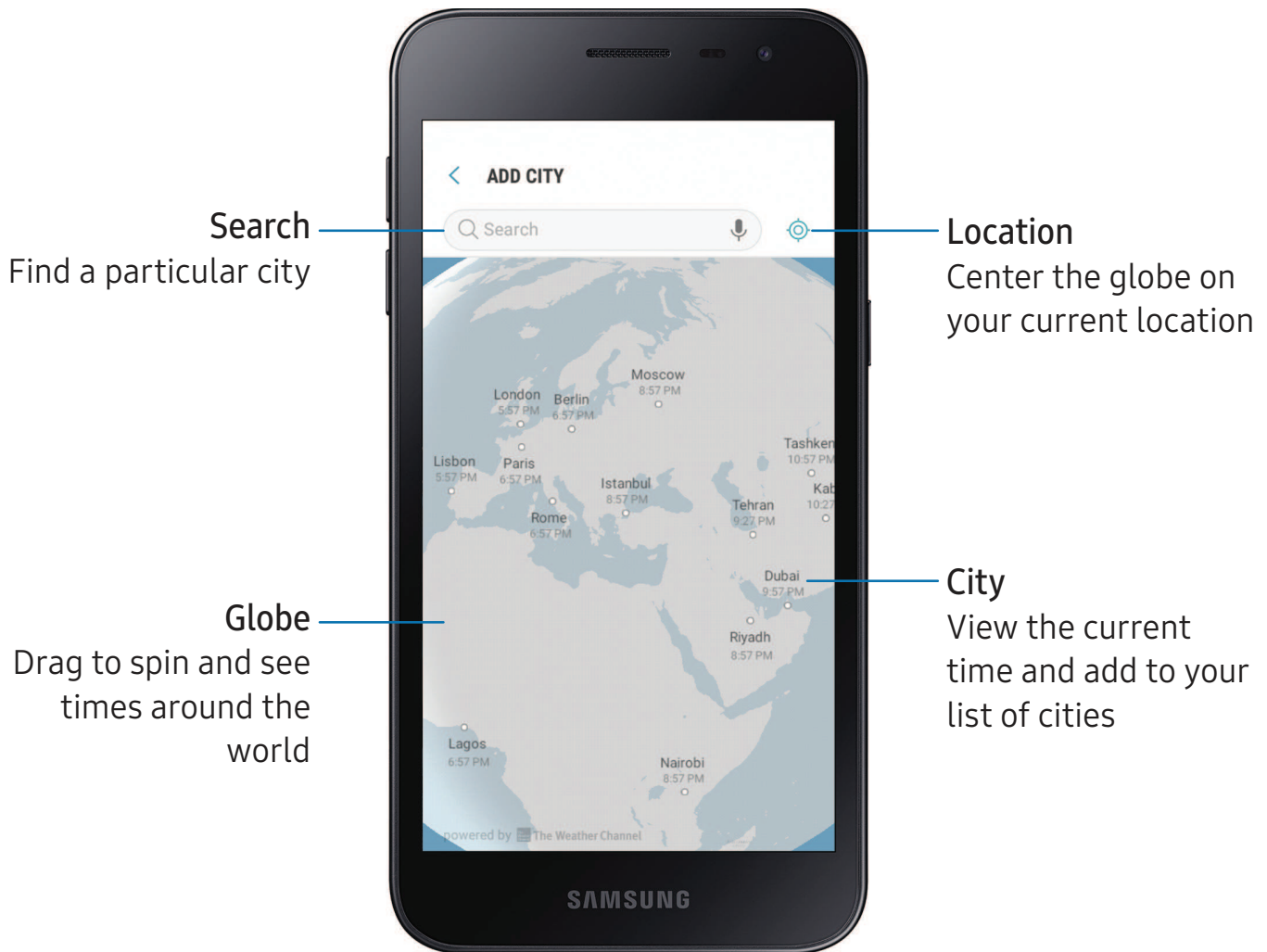
The World clock lets you keep track of the current time in multiple cities around the globe.





1. From  Clock, tap World clock.
2. Tap  Add city.
3. Tap Search and enter the name of the city.

4. Tap the city name in the list, and then tap **Add**.
 - To remove a city, touch and hold it, and tap **Delete**.

Time zone converter

Set a time in a city on your World clock list to see what the local times would be in the other listed cities.

1. From  **Clock**, tap **World clock**.
2. Tap  **Time zone converter**.
3. Tap  **Menu** to choose a different city.
 - To add a city to the list, tap **Add city**.
4. Swipe the hours, minutes, and period (**AM** or **PM**) on the clock to set a time. Local times for the other cities listed are automatically updated.
 - To return the clock to the current time, tap **Reset**.

Contacts

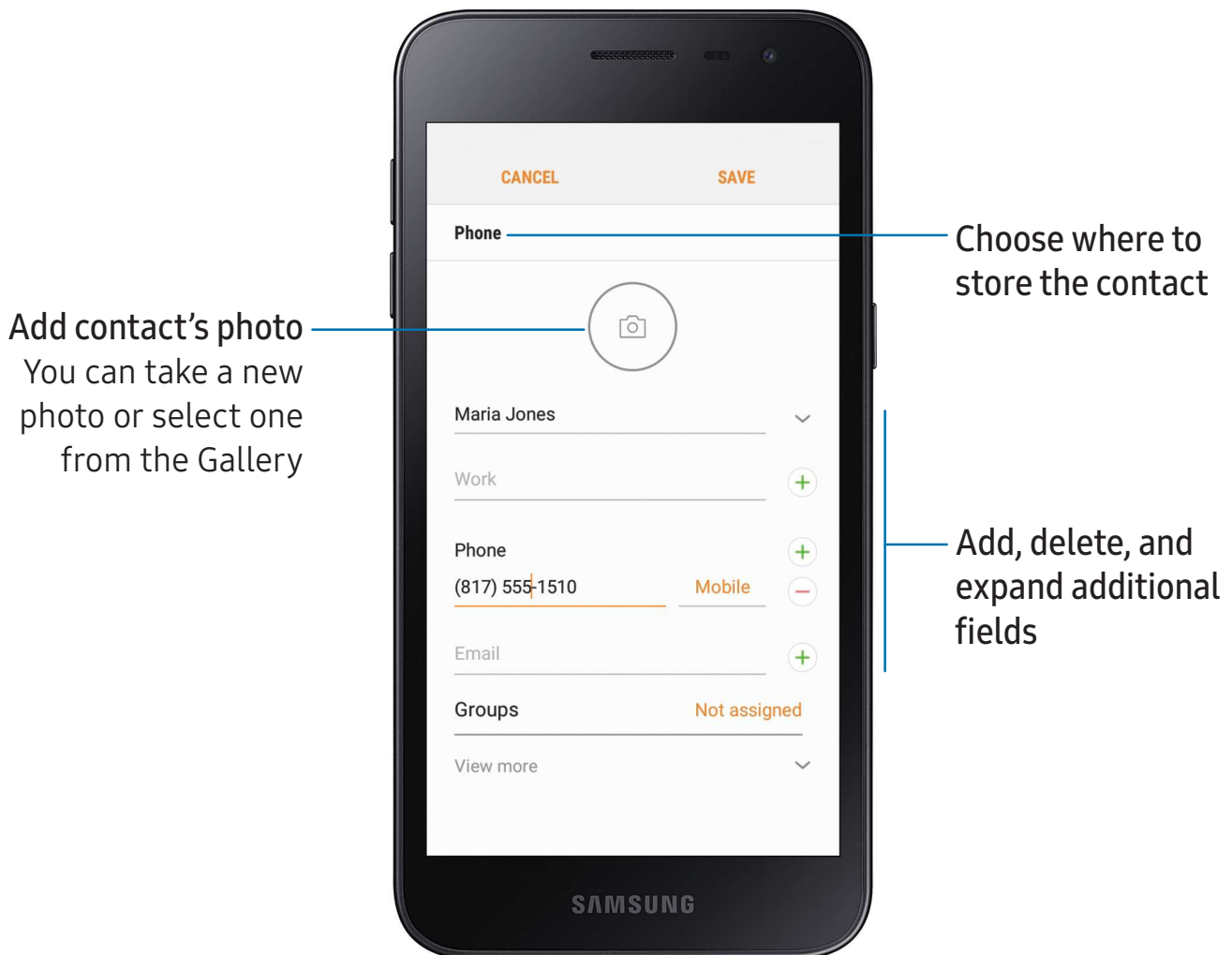

Store and manage your contacts. You can synchronize with personal accounts added to your device.

- From Apps, tap  **Contacts** >  **Create contact**.







Edit a contact

When editing a contact, you can tap a field and change or delete information, or you can add more fields to the contact's list of information.

1. From  **Contacts**, tap a contact.
2. Tap  **Details** > **Edit**.
3. Tap any of the fields to add, change, or delete information.
4. Tap **Save**.



Favorites

When you mark contacts as favorites, they are easily accessible from other apps.

1. From  **Contacts**, tap a contact.
2. Tap  **Details**.
3. Tap  **Add to Favorites** to mark the contact as a favorite.
 - To remove the contact from Favorites, tap  **Favorite**.



Export contacts

Manually back up contacts to an installed memory card (not included).



1. From  **Contacts** tap  **More options** > **Manage contacts**.
2. Tap **Import/Export contacts**.
3. Tap **Export** and follow the prompts.

Link or unlink contacts

Consolidate contact information from multiple sources into one contact by linking entries into a single contact.



1. From  **Contacts**, tap the contact to select it.
2. Tap  **Details** >  **More options** > **Link contacts**.
3. Tap contacts to choose them.
4. Tap **Link**.

To unlink contacts:

1. From  **Contacts**, tap the contact to select it.
2. Tap  **Details** >  **More options** > **Manage linked contacts**.
3. Tap **Unlink** beside contacts to unlink them from the main contact.

Share a contact

Share a contact with others by using various sharing methods and services.

1. From  **Contacts**, tap a contact.
2. Tap  **Details** > **Share**.
3. Tap either **vCard file (VCF)** or **Text**.
4. Choose a sharing method and follow the prompts.

Delete contacts

Delete a single contact or multiple contacts.

1. From  **Contacts**, touch and hold a contact to select it.
 - You can also tap other contacts to select them for deletion.
2. Tap **Delete**, and confirm when prompted.

Direct share

Share content directly with your contacts from within any app. Once enabled, your frequent contacts are displayed in the Share window.

- From Settings, tap  **Advanced features** > **Direct share**, and tap  to enable.

Email

View and manage all of your email accounts in one app. To add an email account, see [Add an email account](#) on page 13.





- From Apps, tap  Email.



Devices and software are constantly evolving — the illustrations you see here are for reference only.



Create and send an email

Learn how to create and send email messages.

1. From  **Email**, tap  **Compose new email**.
 - Different email account may have additional steps and options.
2. Tap the **To** field to add an email address or tap  **Add from Contacts** to select a recipient from your contacts.
 - When adding multiple recipients, separate them with a semicolon (;). More recipients can be added at any time before the message is sent.
 - If adding a recipient from your Contacts, tap the contact to place a checkmark, and then tap **Done**. The contact is displayed in the recipients field.
 - Tap  **Show additional fields** to add Cc and Bcc fields.
3. Tap the **Subject** and **Message** fields to enter text.
 - Tap **Attach** to add files, images, audio, and more to your email.
 - Tap  **More options** for additional email options.
4. Review your message and tap **Send**.



Manage the inbox

There are several tools available from the Inbox screen.

- From  **Email**:
 - Tap a message to read and reply or forward it.
 - Tap **Search** to search for key words in your email inbox.
 - Tap **Edit** for additional message options.
 - Tap **Sort** to customize how messages display.
 - Tap  to change the inbox view and settings.

Email settings

Modify settings associated with using the Email app.

- From  **Email**, tap  >  **Settings**.
 - Under **General**, tap an option, and then follow the prompts.
 - Tap an account to configure specific settings for only that account.

Gallery

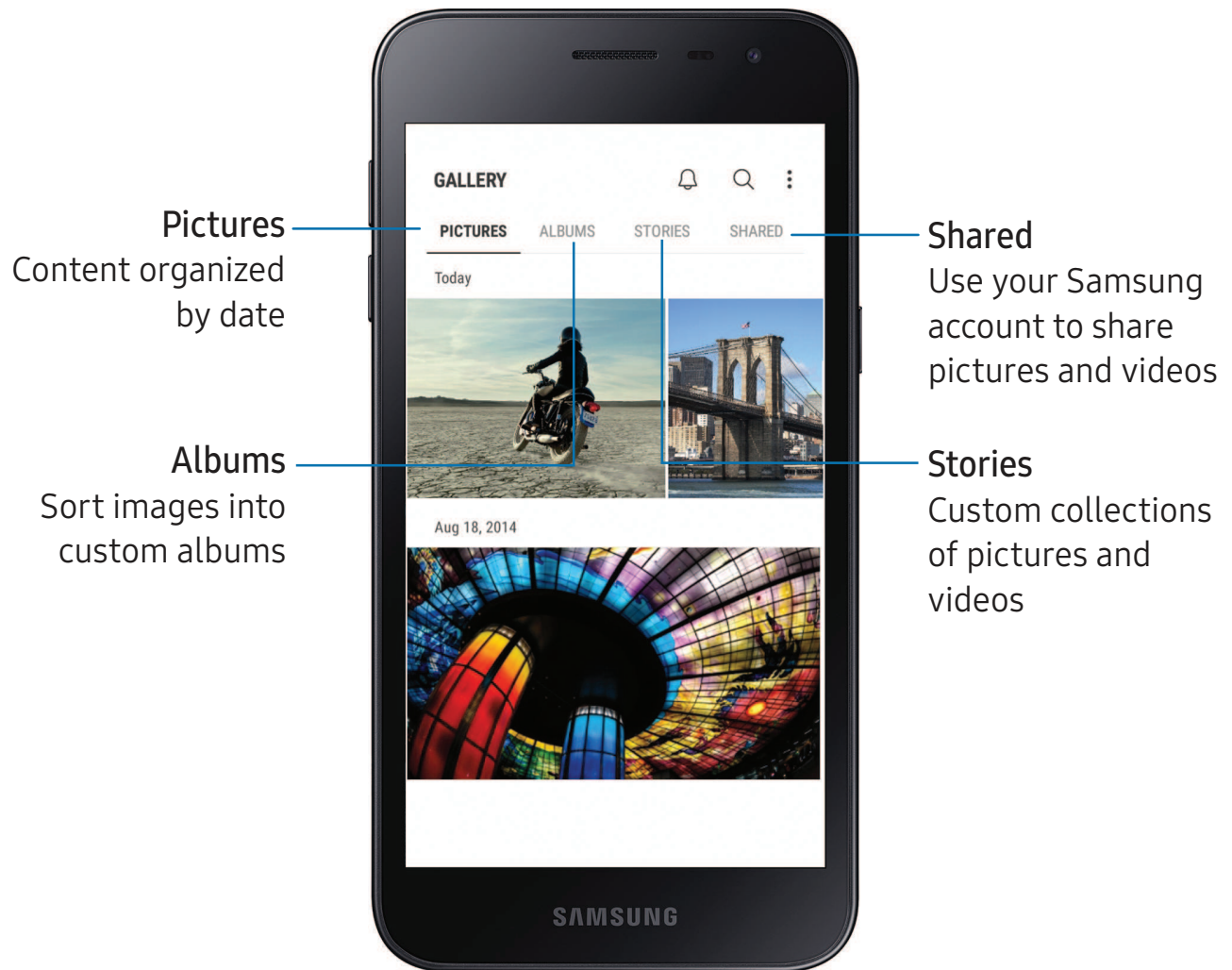

View, edit, and manage pictures and videos.

- From Apps, tap  Gallery.



View pictures

Pictures stored on your device are viewable in the Gallery app.

1. From  **Gallery**, tap **Pictures**.
2. Tap a picture to view it. Swipe left or right to view other pictures or videos.
 - To access the following features, tap  **More options**:
 - **Details**: View and edit information about the picture.
 - **Set as wallpaper**: Set the picture as wallpaper.
 - **Show date and location tags**: See date and location tags when viewing your pictures.
 - **Print**: Send the picture to a connected printer.
 - **Open in Photo Editor Pro**: Edit the picture in Photo Editor Pro.

Edit pictures





Edit pictures stored on your device.

- From  Gallery, tap **Pictures**, and tap a picture to edit.





Play video

Play videos stored on your device.

1. From  **Gallery**, tap **Pictures**.
2. Tap a video to view it. Swipe left or right to view other pictures or videos.
 - To mark the video as a favorite, tap  **Favorite**. The video is added to Favorites under the Albums tab.
 - To access the following features, tap  **More options**:
 - **Details**: View and edit information about the video.
 - **Show date and location tags**: See date and location tags when viewing your videos.
3. Tap  **Play video** to play the video.



Edit video

Edit videos stored on your device.

1. From  **Gallery**, tap **Pictures**.
2. Tap a video to view it.
3. Tap  **Edit** to cut segments of the video.
4. Tap **Save**, and confirm when prompted.



Share pictures and videos

Share pictures and videos from the Gallery app.

1. From  **Gallery**, tap **Pictures**.
2. Tap  **More options** > **Share**, and then tap pictures and videos to select them.
3. Tap **Share**, and then choose an app or connection to use for sharing your selection. Follow the prompts.

Delete pictures and videos

Delete pictures and videos stored on your device.

1. From  **Gallery**, tap  **More options** > **Edit**.
2. Tap pictures and videos to select them, or tap the **All** checkbox at the top of the screen to select all pictures and videos.
3. Tap **Delete**, and confirm when prompted.

Take a screenshot

Capture an image of your screen. It will automatically create a Screenshots album in the Gallery app.

- From any screen, press and hold the **Power** and **Volume down** keys.

Internet

You can access the Internet with a fully-featured web browser.

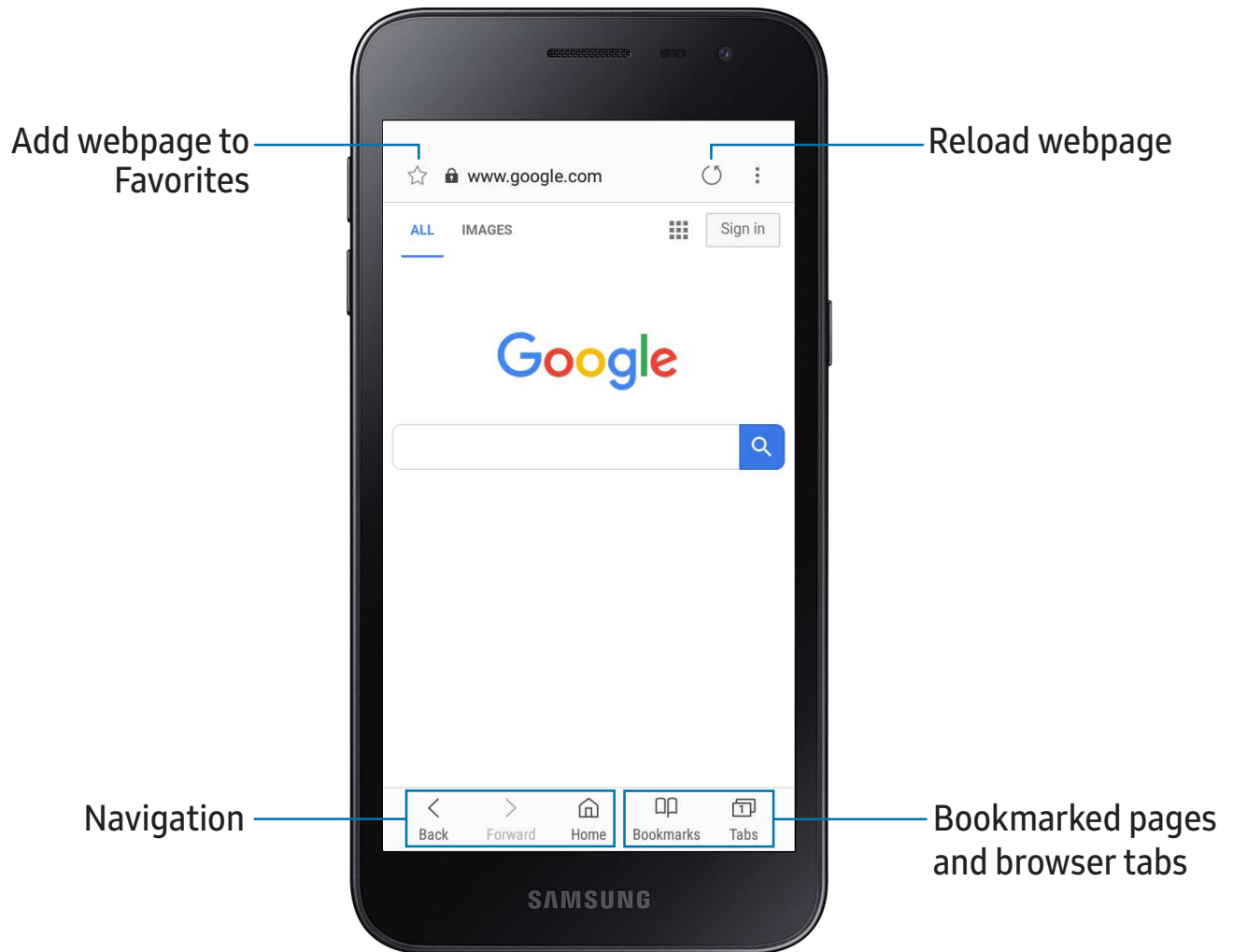

- From Apps, tap  Internet.



 Visit samsung.com/us/support/owners/app/samsung-internet for more information.

Browser tabs

Use tabs to view multiple web pages at the same time.



- From  Internet, tap  Tabs > New tab.
 - To close a tab, tap  Close tab.

Bookmarks

The Bookmarks page stores Bookmarks, Saved pages, and your browsing History.

Open a Bookmark

Quickly launch a web page from the Bookmarks page.

1. From  Internet, tap  Bookmarks > Bookmarks.
2. Tap a bookmark entry.

Save a web page

Saving a web page stores its content on your device so that you can access it offline.



- From  Internet, tap  More options > Save webpage.

 To view saved web pages, tap  Bookmarks > Saved pages.

View history

View a list of recently visited web pages:

- Tap  Bookmarks > History.

 To clear your browsing history, tap  More options > Clear history.

Share pages



Web pages can be shared with your contacts.

- From  Internet, tap  More options > Share, and follow the prompts.

Secret mode

Pages viewed in Secret mode are not listed in your browser history or search history, and leave no traces (such as cookies) on your device. Secret tabs are a darker shade than the normal tab windows.

Any downloaded files remain on your device after you close the secret tab.



1. From  **Internet**, tap  **Tabs** > **Turn on secret mode**.
2. Tap **Set password** to protect your Secret mode data with a password.

To turn off Secret mode:

- From  **Internet**, tap  **Tabs** > **Turn off secret mode**.

Internet settings

Modify settings associated with using the Internet app.

1. From  **Internet**, tap  **More options** > **Settings**.
2. Tap an option and follow the prompts.

Messages

You can send and receive text messages (SMS) and multimedia messages (MMS).

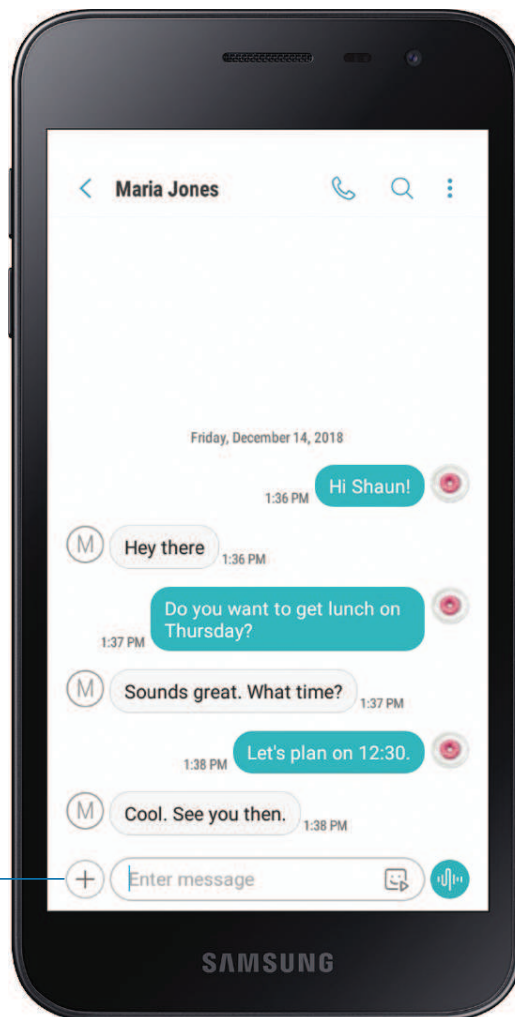

- From Apps, tap  Messages >  Compose.

Add attachment



Message search

Search through your messages by using the search feature.

1. From  **Messages**, tap **Search**.
2. Enter a word or phrase to search for, and then tap  **Search** on the keyboard.

Delete messages



You can delete individual text messages from a conversation.

1. From  **Messages**, tap a conversation.
2. Touch and hold a message, and then tap **Delete**.
3. Tap each message that you want to delete.
4. Tap **Delete** and confirm when prompted.

 Deleting text messages only removes them from your device. It does not remove sent text messages from the recipient's device.

Delete conversations

Entire conversations can be deleted at once.

1. From  **Messages**, tap  **More options** > **Edit**.
2. Tap each conversation that you want to delete.
3. Tap  **Delete** and confirm when prompted.

Emergency alerts

Emergency alerts notify you of imminent threats and other situations. There is no charge for receiving an Emergency alert message.

1. From Settings, tap **Connections** > **More connection settings**.
2. Tap **Wireless emergency alerts** > **Settings** to customize notifications for emergency alerts.

Send SOS messages

Send a message with your location to designated contacts when you are in an emergency situation.

1. From Settings, tap **Advanced features** > **Send SOS messages**, and then tap  to enable this feature.
2. Tap **Send messages to** > **Add** and add recipients by creating new contacts or selecting from Contacts.
 - To include a picture from your front and rear camera, tap **Attach pictures**.
 - To include a five-second audio recording in your SOS message, tap **Attach audio recording**.
3. Press the **Power** key quickly three times to send an SOS message.

Messages settings

Configure the settings for text and multimedia messages.

- From  **Messages**, tap  **More options** > **Settings**.

Phone

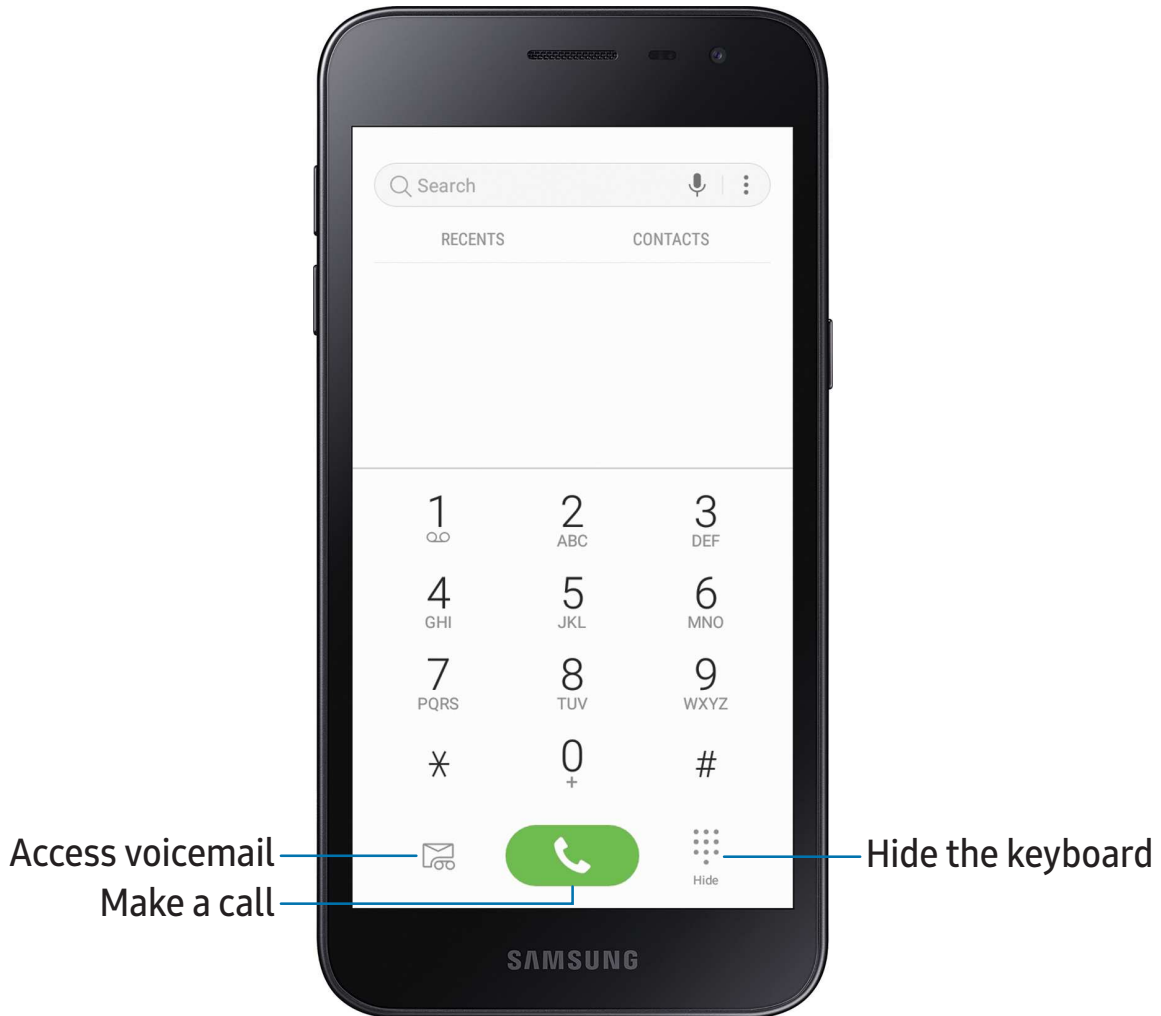

You can make and receive phone calls, check voicemail messages, and set up speed dial numbers.

- From a Home screen, tap  **Phone**.



Make a call

Make a call from a Home screen.

- From  **Phone**, enter a number on the keypad and tap  **Call**.
 - Tap  **Keypad** if the keypad is not displayed.



Enable swipe to call

Swipe a contact or number to the right to make a call.

1. From Settings, tap  **Advanced features** > **Swipe to call or send messages**.
2. Tap  to enable this feature.

Make a call from Recents

All incoming, outgoing, and missed calls are recorded in the Call log.

1. From  **Phone**, tap **Recents** to display a list of recent calls.
2. Tap a contact, and then tap  **Call**.

Make a call from Contacts

Call a contact from the Contacts app.

1. From Apps, tap  **Contacts**.
2. Swipe your finger across a contact to the right to call the contact.

Answer a call

When a call is received, the phone rings and the caller's phone number or name is displayed. If you are using an app, a pop-up screen is displayed for the incoming call.

- On the incoming call screen, drag  **Answer** to the right to answer the call.

– or –

On the incoming call pop-up screen, tap  **Answer** to answer the call.

Decline a call

You can choose to decline an incoming call. If you are using an app, a pop-up screen is displayed for the incoming call.

- On the incoming call screen, drag  **Decline** to the left to reject the call and send it to your voicemail.

– or –

On the incoming pop-up screen, tap  **Decline** to reject the call and send it to your voicemail.

Decline with a message

You can choose to decline an incoming call with a text message response.

- On the incoming call screen, drag **Send message** upward and select a message.

– or –

On the incoming call pop-up screen, tap **Send message** and select a message.

End a call

- Tap  **End** when you are ready to end your call.

Actions while on a call

You can adjust call volume, switch to a headset or speaker, and even multitask while on a call.

Adjust the call volume



- Press the **Volume** keys to increase or decrease the volume.

– or –

Tap  **Extra volume** to quickly add more volume to the incoming audio.

Switch to headset or speaker

Listen to the call using the speaker or through a Bluetooth® headset (not included).

- Tap  **Speaker** to hear the caller using the speaker or tap  **Bluetooth** to hear the caller using a Bluetooth headset.

Multitask

If you exit the call screen to use another app, your active call is indicated in the Status bar.

To return to the call screen:

- Drag the Status bar down to display the Notification panel and tap the call.

To end a call while multitasking:

- Drag the Status bar down to display the Notification panel, and then tap  **End call**.



Call log

The numbers of the calls you have dialed, received, or missed are stored in the Call log.

- From  **Phone**, tap **Recents**. A list of recent calls is displayed. If the caller is in your Contacts list, the caller's name is displayed.

Save a contact from a recent call

Use recent call information to create a contact or update your Contacts list.

1. From  **Phone**, tap **Recents**.
2. Tap the call that contains the information that you want to save to your Contacts list.
3. Tap  **Details**.
4. Tap **Create contact**.

– or –

If you want to replace the number for an existing contact, tap **Update existing**.



Delete call records

To delete Call log entries:

1. From  **Phone**, tap **Recents**.
2. Touch and hold the call you want to delete from the Call log.
3. Tap **Delete**.

Block a number

By adding a caller to your Block list, future calls from this number are sent directly to your voicemail, and messages are not received.





2. From  **Phone**, tap **Recents**.
3. Tap the caller you want to add to the Block list.
4. Tap  **Details** > **Block number**, and confirm when prompted.

You can also modify your Block list in Settings:

- From  **Phone**, tap  **More options** > **Settings** > **Block numbers**.

Speed dial

You can assign a shortcut number to a contact for speed dialing their default number.

1. From  **Phone**, tap  **More options** > **Speed dial numbers**. The Speed dial screen displays the reserved speed dial numbers.
2. Tap an unassigned number.
 - Tap  **Menu** to select a different Speed dial number than the next one in sequence.
 - Number 1 is reserved for Voicemail.
3. Type in a name or number, or tap  **Add from Contacts** to assign a contact to the number.
 - The selected contact is displayed in the Speed dial number box.



Make a call with Speed dial

You can make a call using Speed dial.

- From  **Phone**, touch and hold the Speed dial number.
 - If the Speed dial number is more than one digit long, enter the first digits, and then hold the last digit.



Remove a Speed dial number

You can remove an assigned Speed dial number.

1. From  **Phone**, tap  **More options** > **Speed dial numbers**.
2. Tap  **Remove** by the contact you want to remove from Speed dial.



Emergency calls

You can dial the emergency telephone number in your region regardless of the phone's cellular service status. If your phone is not activated, you can only make an emergency call.

1. From  **Phone**, enter the emergency telephone number (911 in North America) and tap  **Call**.
2. Complete your call. During this type of call, you have access to most in-call features.

Make an emergency call from a locked screen

The emergency telephone number can be dialed even if the phone is locked, allowing anyone to use your phone to call for help in an emergency. When accessed from a locked screen, only the emergency calling feature is accessible to the caller. The rest of the phone remains secured.





1. Drag  **Phone** upward to open the call screen.
2. Tap **Emergency call** to display the Emergency dialer.
3. Enter the emergency telephone number (911 in North America) and tap  **Call**.
4. Complete your call. During this type of call, you have access to most in-call features.

Optional calling services

If available with your mobile service plan, the following calling services are supported.

Place a multi-party call

If your service plan supports this feature, you can make another call while a call is in progress.

1. From the active call, tap  **Add call** to dial the second call.
2. Dial the new number and tap  **Call**. When the call is answered:
 - Tap  **Swap** to switch between the two calls.
 - Tap  **Merge** to hear both callers at once (multi-conferencing).



Wi-Fi calling

Make calls over Wi-Fi when you are connected to a Wi-Fi network. Contact your carrier for details.

1. From Settings, tap **Connections** > **Wi-Fi calling**.
2. Tap  to enable this feature.
3. Follow the prompts to set up and configure Wi-Fi calling.

Phone settings

These settings allow you to modify settings associated with the Phone app.



1. From  **Phone**, tap  **More options** > **Settings**.
2. Tap an option and follow the prompts.

Real Time Text (RTT)

Type back and forth in real time with the other person while on a call.

 To use RTT, you must be connected to a 4G LTE or Wi-Fi network.

You can use RTT whenever you are calling someone whose phone also supports RTT or is connected to a teletypewriter (TTY) device. The RTT icon appears on all incoming RTT calls.

1. From  **Phone**, tap  **More options** > **Settings**.
2. Tap **Real time text** for the following options:
 - **Always visible:** Show the RTT call button on the keypad and during calls.
 - **Use external TTY keyboard:** Hide the RTT keyboard when an external TTY keyboard is connected.

Google apps

Enjoy these apps from Google.



Chrome

Browse the Internet with Chrome™ and bring your open tabs, bookmarks, and address bar data from your computer to your mobile device.

Visit support.google.com/chrome to learn more.



Drive

Open, view, rename, and share files saved to your Google Drive™ cloud account.

Visit support.google.com/drive to learn more.



Duo

Make one-to-one video calls.

Visit support.google.com/duo to learn more.



Gmail

Send and receive email with Google's web-based email service.

Visit support.google.com/mail to learn more.



Google

Find online content with tools that learn what interests you. Turn on your personalized feed to receive customized content.

Visit support.google.com/websearch to learn more.



Maps

Get directions and other location-based information. You must enable location services to use Google Maps. For more information, see **Location** on page 96.

Visit support.google.com/maps to learn more.



Photos

Store and back up your photos and videos automatically to your Google Account with Google Photos™.

Visit support.google.com/photos to learn more.



Play Movies and TV

Watch movies and TV shows purchased from Google Play. You can also view videos saved on your device.

Visit play.google.com/store/movies to learn more.

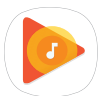

Play Music

Play music and audio files on your device.

Visit support.google.com/music to learn more.



Play Store

Find new apps, movies and TV shows, music, books, magazines, and games in the Google Play™ store.

Visit support.google.com/play to learn more.



YouTube

Watch and upload YouTube™ videos right from your device.

Visit support.google.com/youtube to learn more.

Carrier apps

Some apps require a data plan or paid subscription. Contact your carrier for additional information.



myCricket

Access billing, make a quick payment, view usage and access support from the palm of your hand.



Visual Voicemail

View and play voicemail messages, easily save important numbers to your Favorites list, and respond by calling or texting.

Additional apps

The following apps are preloaded or downloaded over-the-air to your device.



Amazon Shopping

Shop at amazon.com™ from your device.



Facebook

Keep up with friends and family with the Facebook app. Share updates, photos, and videos, as well as text, chat, and play games.

Settings

Access Settings

Connections

Sounds and vibration

Notifications

Display

Device maintenance

Lock screen and security

Accounts



Accessibility

Other settings



Access Settings

There are a couple of ways to access your device settings.

- From a Home screen, swipe up to access Apps, and then tap  **Settings**.
- Swipe down from the Status bar, and then tap  **Settings**.

Search for Settings

If you are not sure exactly where to find a certain setting, you can search for it.



1. From Settings, tap  **Search**.
2. Enter keywords in the **Search** field. As you type, settings that match display on the screen.
3. Tap an entry to go to that setting.

Connections

Manage connections between your device and a variety of networks and other devices.

Wi-Fi



You can connect your device to a Wi-Fi network to access the Internet without using your mobile data.

1. From Settings, tap  **Connections** > **Wi-Fi**, and then tap  to turn on Wi-Fi and scan for available networks.
2. Tap a network.
 - When you select an open network, connection happens automatically. Otherwise, enter a password to connect.

Manually connect to a Wi-Fi network



If the Wi-Fi network you want is not listed after a scan, you can still connect to it by entering the information manually.

Ask the Wi-Fi network administrator for the name and password before you begin.

1. From Settings, tap  **Connections** > **Wi-Fi**, and then tap  to turn on Wi-Fi.
2. Tap  **Add network** at the bottom of the list.
3. Enter information about the Wi-Fi network:
 - **Network name:** Type the exact name of the network.
 - **Security:** Select a security option from the list, and enter the password if required.
 - **Auto reconnect:** Choose this option if you want to automatically reconnect to this network whenever you are in range.
 - **Show advanced options:** Add any advanced options, such as IP and Proxy settings.
4. Tap **Connect**.



Advanced Wi-Fi settings

You can configure connections to various types of Wi-Fi networks and hotspots, manage saved networks and look up your device's network addresses.

1. From Settings, tap  **Connections** > **Wi-Fi**, and then tap  to turn on Wi-Fi.
2. Tap  **More options** > **Advanced**.
 - **Switch to mobile data:** When enabled, your device switches to mobile data whenever the Wi-Fi connection is unstable.
 - **Turn on Wi-Fi automatically:** Turn on Wi-Fi in frequently-used locations.
 - **Manage networks:** View your saved Wi-Fi networks.
 - **Wi-Fi control history:** View devices that have turned your Wi-Fi on or off.
3. Tap **View more** to see additional network settings.
 - **Hotspot 2.0:** Connect automatically to Wi-Fi networks that support Hotspot 2.0.
 - **WPS push button:** Connect to a Wi-Fi network by pressing the WPS button on a router.
 - **WPS PIN entry:** Connect to a Wi-Fi network by entering your WPS PIN.
 - **MAC address:** View your device's MAC address, required when connecting to some secured networks (not configurable).
 - **IP address:** View your device's IP address (not configurable).

Wi-Fi Direct

Wi-Fi Direct shares data directly between devices using Wi-Fi.

1. From Settings, tap  **Connections** > **Wi-Fi**, and then tap  to turn on Wi-Fi.
2. Tap **Wi-Fi Direct**.
 - Your device scans for discoverable Wi-Fi Direct devices.
3. Tap a device, and then follow the prompts to connect.

 When sharing a file, tap  **Wi-Fi Direct** to use this feature.



Disconnect from Wi-Fi Direct

Disconnect your device from a Wi-Fi Direct device.

- From Settings, tap  **Connections** > **Wi-Fi** > **Wi-Fi Direct**, and tap a device to disconnect it.

Bluetooth

Bluetooth allows you to pair your device to another Bluetooth-enabled device. Once a pairing is created, the devices remember each other and exchange information without having to enter a passcode.



1. From Settings, tap  **Connections** > **Bluetooth**, and then tap  to turn on Bluetooth.
 - Your device automatically scans for discoverable Bluetooth devices. Tap **Scan** to search again.
2. Tap a device, and follow the prompts to connect.

 When sharing a file, tap  **Bluetooth** to use this feature.

Rename a paired device

You can rename a paired device to any name you choose.



 Renaming a paired device may make it easier to recognize.

1. From Settings, tap  **Connections** > **Bluetooth**, and then tap  to turn on Bluetooth.
2. Tap  **Settings** next to the device name, and then tap **Rename**.
3. Enter a new name, and tap **Rename**.

Unpair from a Bluetooth device

When you unpair from a Bluetooth device, the two devices no longer recognize each other.

 You will need to pair with the device in order to connect to it.

1. From Settings, tap  **Connections** > **Bluetooth**, and then tap  to turn on Bluetooth.
2. Tap  **Settings** next to the device, and then tap **Unpair**.

Data usage

Check your current mobile and Wi-Fi data usage. You can also customize warnings and limits.

- From Settings, tap  **Connections** > **Data usage**.

Monitor mobile data

You can customize your mobile data access by setting limits and restrictions.



Use these features to stay within your data plan and avoid overage fees or throttling (slower speeds).

- From Settings, tap  **Connections** > **Data usage**. The following options are available:
 - **Mobile data:** Turn on mobile data services.
 - **International data roaming:** Enable mobile data services while roaming internationally.
 - **Mobile data usage:** View data usage over mobile connections over a period of time. You can view total usage as well as usage by app.
 - **Billing cycle and data warning:** Set the day of the month to start the bill cycle for your device.



Monitor Wi-Fi data

You can restrict Wi-Fi data access by customizing usage limits and networks.

- From Settings, tap  **Connections** > **Data usage**. The following options are available:
 - **Wi-Fi data usage:** View data usage over Wi-Fi connections over a period of time. You can view total usage as well as usage by app.
 - **Restrict networks:** Select networks to prevent apps that are running in the background from using them.



Turn on Data saver

Use Data saver to reduce your data consumption by preventing selected apps from sending or receiving data in the background.

1. From Settings, tap  **Connections** > **Data usage** > **Data saver**.
2. Tap  to turn on Data saver.
 - To allow some apps to have unrestricted data usage, tap **Allow app while Data saver on**, and tap  next to each app to specify restrictions.



Mobile networks

Use Mobile networks to configure your device's ability to connect to mobile networks and use mobile data.

-  Use these features to help manage connection settings that may affect your monthly bill.
- From Settings, tap  **Connections** > **Mobile networks**.
 - **Mobile data:** Enable mobile data usage.
 - **International data roaming:** Change voice, text and data roaming settings for international roaming.
 - **Disable 2G:** Do not use 2G mobile data networks.
 - **Access Point Names:** Choose or add APNs, which have the network settings your device needs to connect to your provider.
 - **Network operators:** Choose available and preferred networks.

Location

Location services use a combination of GPS, mobile network and Wi-Fi to determine the location of your device.

-  Some apps require location services be turned on for full functionality.
1. From Settings, tap  **Connections** > **Location**.
 2. Tap  to turn on Location services.
 3. Tap **Locating method** to select how your location is determined:
 - **High accuracy:** Uses GPS, Wi-Fi, and mobile networks.
 - **Battery saving:** Uses Wi-Fi and mobile networks (no GPS).
 - **Phone only:** Uses GPS only.
 4. Tap **Improve accuracy** to use other connections for determining your location:
 - **Wi-Fi scanning:** Allow apps and services to scan for Wi-Fi networks automatically, even when Wi-Fi is turned off.
 - **Bluetooth scanning:** Allow apps to scan for and connect to nearby devices automatically through Bluetooth, even when Bluetooth is turned off.



Location services

Location services store and use your device's most recent location data. Select apps can use this data to improve your search results based on places that you have visited.

1. From Settings, tap  **Connections** > **Location**.
2. Tap an entry under **Location services** to use as a location service.

Recent location requests



View a list of apps that have requested your location.

1. From Settings, tap  **Connections** > **Location**.
2. Tap  to turn on Location services.
3. Tap an entry under **Recent location requests** to view the app's settings.

Mobile hotspot

Mobile hotspot uses your data plan to create a secure Wi-Fi network that can be used by multiple devices.

 Check with your service provider about service fees.

1. From Settings, tap  **Connections** > **Mobile hotspot and tethering** > **Mobile hotspot**.
2. Tap  to turn on Mobile hotspot.
3. On the devices you want to connect, activate Wi-Fi and select your device's Mobile hotspot. Enter the Mobile hotspot password to connect.

Change the mobile hotspot password



You can customize your Mobile hotspot password to make it easier to remember.

1. From Settings, tap  **Connections** > **Mobile hotspot and tethering** > **Mobile hotspot**.
2. Tap the password, enter a new password, and then tap **Save**.

Allowed devices list



Create a custom list of devices that are allowed to connect to your Mobile hotspot.

 You need the device name and MAC address of devices that you want to add to the Allowed devices list.

1. From Settings, tap  **Connections** > **Mobile hotspot and tethering** > **Mobile hotspot**.
2. Tap  **More options** > **Allowed devices**, and then tap **Add** to enter the other device's Device name and MAC address.
3. Tap **Add** to add the device.
 - To restrict connections to your Allowed devices list, tap **Allowed devices only**.

Configure mobile hotspot settings

You can customize your mobile hotspot's security and connection settings.

1. From Settings, tap  **Connections** > **Mobile hotspot and tethering** > **Mobile hotspot**.
2. Tap  **More options** > **Configure mobile hotspot** for the following settings:
 - **Network name:** View and change the name of your Mobile hotspot.
 - **Hide my device:** Prevent your Mobile hotspot from being discoverable by other devices.
 - **Security:** Choose the security level for your Mobile hotspot.
 - **Password:** If you choose a security level that uses a password, you can view or change it.
 - **Show advanced options:** Configure additional Mobile hotspot settings.

Tethering

You can use tethering to share your device's Internet connection with another device.



 The other device does not need Wi-Fi to use this sharing method.

1. From Settings, tap  **Connections** > **Mobile hotspot and tethering**.
2. Connect the computer to the device using a USB cable, and then tap **USB tethering**.

Timeout settings

You can set the Mobile hotspot to automatically turn off when there are no connected devices.

 This feature can help you manage your data usage.

1. From Settings, tap  **Connections** > **Mobile hotspot and tethering** > **Mobile hotspot**.
2. Tap  **More options** > **Timeout settings**, and then select an interval.

Wi-Fi sharing



Turn on Wi-Fi sharing to quickly share your Wi-Fi network with other devices.

 Use this feature to share your Wi-Fi network without giving out your Wi-Fi password.

1. From Settings, tap  **Connections** > **Mobile hotspot and tethering** > **Mobile hotspot**.
2. Tap **Wi-Fi sharing** to turn on this feature.

Nearby device scanning



Easily set up connections to other available devices by turning on Nearby device scanning. This feature sends you a notification when there are available devices to connect to.

1. From Settings, tap  **Connections** > **More connection settings** > **Nearby device scanning**.
2. Tap  to turn on the feature.

Connect to a printer

Connect your device to a printer on the same Wi-Fi network to easily print documents and images from your device.

 Make sure the app you want to print from supports printing.

1. From Settings, tap  **Connections** > **More connection settings** > **Printing**.
2. Tap  **Add service** and follow the prompts to add a print service.
3. Tap the print service, and then tap  **More options** > **Add printer**.

MirrorLink

If your car is compatible with Mirrorlink™ you can mirror your device's display on your car's entertainment and information screen using a USB connection. For more information, visit mirrorlink.com.

1. Connect your device to your car's system using the USB cable.
2. From Settings, tap  **Connections** > **More connection settings** > **MirrorLink**.
3. Tap **Connect to car via USB**, and follow the prompts.

Virtual Private Networks



A Virtual Private Network (VPN) allows you to connect to a private secured network from your device. You will need the connection information from your VPN administrator.

 A secured screen lock is required to set up a VPN.

1. From Settings, tap  **Connections** > **More connection settings** > **VPN**.
2. Tap **Add VPN**.
3. Enter the VPN network information provided by your network administrator.

Manage a VPN

Use the VPN settings menu to edit or delete a VPN connection.

1. From Settings, tap  **Connections** > **More connection settings** > **VPN**.
2. Tap  **Settings** next to a VPN.
3. Edit the VPN and tap **Save**, or tap **Delete** to remove the VPN.

Connect to a VPN

Once you have set up a VPN, connecting to and disconnecting from a VPN is easy.

1. From Settings, tap  **Connections** > **More connection settings** > **VPN**.
2. Tap a **VPN**, enter your log in information, and tap **Connect**.
 - To disconnect, tap the VPN, and then tap **Disconnect**.

Sounds and vibration

You can control the sounds and vibrations used to indicate notifications, screen touches, and other interactions.

Sound mode

You can change the sound mode on your device without using the volume keys.



Use the sound mode setting instead of the volume keys to change the sound mode without losing your customized sound levels.

- From Settings, tap  **Sounds and vibration** > **Sound mode**, and then choose a mode:
 - **Sound**: Use the sounds, vibrations, and volume levels you have chosen in Sound settings for notifications and alerts.
 - **Vibrate**: Use vibration only for notifications and alerts.
 - **Mute**: Set your device to make no sounds.
 - **Temporary mute**: Set a time limit for muting the device.

Easy mute

Quickly mute sounds by covering the screen or turning the device over.

- From Settings, tap  **Advanced features** > **Easy mute**, and tap  to enable.

Vibrations



You can control how and when your device vibrates.

1. From Settings, tap  **Sounds and vibration**.
2. Tap options to customize:
 - **Vibrate while ringing**: Set your device to vibrate in addition to ringing when you receive a call.
 - **Vibration pattern**: Choose from preset vibration patterns.

Volume

Set the volume level for call ringtones, notifications, and other audio.

○ From Settings, tap  **Sounds and vibration** > **Volume**, and drag the sliders.

 You can also use the **Volume** key to adjust the volume. Tap  **More** to customize all volume options.



Use Volume keys for media

Set the default of the Volume key to control the media volume.

1. From Settings, tap  **Sounds and vibration**.
2. Tap **Use Volume keys for media** to enable this feature.

Media volume limiter

Limit the maximum output of the device's volume while using headphones or Bluetooth speakers (not included).

1. From Settings, tap  **Sounds and vibration** > **Volume**.
2. Tap  **More options** > **Media volume limiter**.
3. Tap  to enable this feature.
 - To set the maximum output volume, drag the **Custom volume limit** slider.
 - To require a PIN to make changes to the volume setting, tap **Set volume limit PIN**.

Ringtone

Customize your call ringtone by choosing from preset sounds or adding your own.

1. From Settings, tap  **Sounds and vibration** > **Ringtone**.
2. Tap a ringtone to hear a preview and select it, or tap **Add** to use an audio file as a ringtone.

Notification sounds

Choose a preset sound for all notification alerts.

 You can also customize notifications sounds to be unique for each app using the App settings menu.

1. From Settings, tap  **Sounds and vibration** > **Notification sounds**.
2. Tap a sound to hear a preview and select it.

Do not disturb

Do not disturb allows you to block sounds and notifications while this mode is turned on. You can also specify exceptions for people, apps, and alarms.

 Do not disturb has a scheduling feature so that you never forget to silence your phone during important meetings.

- From Settings, tap  **Sounds and vibration** > **Do not disturb** and configure the following:
 - **Turn on now:** Put your device in Do not disturb mode.
 - **Allow exceptions:** Customize which notifications are allowed while your device is in Do not disturb mode.
 - **App rules:** Manage rules set by apps.
 - **Hide visual notifications:** Select options for preventing visual notifications for apps silenced by Do not disturb.

System sounds

Customize your device's sounds for things like tapping the screen to charging the device.

- From Settings, tap  **Sounds and vibration** for the following options:
 - **Touch sounds:** Play tones when you touch or tap the screen to make selections.
 - **Screen lock sounds:** Play a sound when you unlock the screen.
 - **Charging sound:** Play a sound when a charger is connected.



Key-tap feedback

Play tones when keys are tapped.

- From Settings, tap  **Sounds and vibration**, and tap an option to customize:
 - **Dialing keypad tones:** Play a tone when dialing numbers on the Phone keypad.
 - **Keyboard sound:** Play a sound when typing with the Samsung keyboard.

Dolby Atmos

Enjoy Dolby Atmos quality when playing content that was specifically mixed for Atmos.

1. From Settings, tap  **Sounds and vibration** > **Sound quality and effects**.
2. Tap **Dolby Atmos**, and tap  to turn the feature on and choose a sound mode.

Equalizer

Choose an audio preset that is customized to different genres of music, or manually change your audio settings.

1. From Settings, tap  **Sounds and vibration** > **Sound quality and effects**.
2. Tap **Equalizer** to choose a music genre, or tap **Advanced** or **Basic** to manually adjust the sound levels.



Headset audio options

Enhance the sound resolution of music and videos for a clearer listening experience. These features are only available with a headset connected.

- From Settings, tap  **Sounds and vibration** > **Sound quality and effects**, and tap an option to turn it on:
 - **Tube Amp Pro**: Simulates the warm tones of a tube amplifier.
 - **Concert hall**: Adds reverb for a unique hall effect.

Adapt sound

Customize the sound for each ear and enhance your listening experience.



1. From Settings, tap  **Sounds and vibration** > **Sound quality and effects** > **Adapt sound**.
 2. Tap the sound profile that fits you best, and tap  **Settings** to customize.
-  Tap **Add personalized sound profile** to take a hearing test and let your device identify the best sound for you.

Notifications

You can prioritize and streamline app alerts by changing which apps send notifications and how notifications alert you.



Customize app notifications

You can change notification settings for each app.

1. From Settings, tap  **Notifications**.
2. Tap an app for the following options:
 - : Receive notifications from this app.
 - **App icon badges**: Show a badge on the icon when there are notifications.
 - **Categories**: Configure notification options that are specific to this app.

Block app notifications

Block notifications for apps.

1. From Settings, tap  **Notifications**.
2. Tap  next to **App icon badges** to show or hide the number of notifications on the app icon.

Display

You can configure the screen brightness, timeout delay, font size, and many other display settings.

Screen off settings

You can customize when the screen turns off.

1. From Settings, tap  **Display**.
2. Tap an option to customize:
 - **Screen timeout:** Turn the screen off after a set amount of time.
 - **Screen saver:** Display colors or images after the screen has turned off or while charging.

 The prolonged display of non-moving images may result in degraded image quality or permanent afterimages. Make sure to turn off the screen when you are not using your device.



Screen brightness

You can set the screen brightness to adjust to lighting conditions or personal preference.

1. From Settings, tap  **Display**.
2. Customize options under Brightness:
 - Drag the **Brightness** slider to set a custom brightness level.
 - Tap **Outdoor mode** to increase the screen brightness for 15 minutes for greater visibility when outdoors.

One-handed mode

You can change the screen layout to accommodate operating your device with one hand.

1. From Settings, tap  **Advanced features** > **One-handed mode**.
2. Tap  to enable the following:
 - **Gesture:** Swipe up diagonally from either bottom corner to reduce the display size.
 - **Button:** Tap **Home** three times in quick succession to reduce the display size.

Device maintenance

View the status of your device's battery, storage, and memory. You can also automatically optimize your device's system resources.

Quick optimization

The quick optimization feature improves device performance through the following actions:



- Identifying apps that use excessive battery power and clearing unneeded items from memory.
- Deleting unnecessary files and closing apps running in the background.
- Scanning for malware.

To use the quick optimization feature:

1. From Settings, tap  **Device maintenance**.
2. Tap **Optimize now**.

Battery

View how battery power is used for your various device activities.

- From Settings, tap  **Device maintenance** > **Battery** for options:
 - **Battery usage:** View power usage by app and service.
 - **Power saving mode:** Select a power mode to extend battery life.
 - **App power monitor:** View power usage by app.
 - **Unmonitored apps:** Select apps to exclude from being put to sleep by the App power monitor.
 - **Always sleeping apps:** Select apps to put to sleep immediately when not being used.
 -  **More options** > **Advanced settings:** Configure advanced battery settings and notifications.

Storage and memory card

View the device memory and usage. You can also mount, unmount, or format an optional memory card (not included).

Device storage

Quickly optimize your device's memory, increasing available memory.

1. From Settings, tap  **Device maintenance** > **Storage**.
2. Tap **Clean now**.

Optimize your device's memory

Check the amount of available memory. You can close background apps and reduce the amount of memory you are using to speed up your device.

1. From Settings, tap  **Device maintenance** > **Memory**.
 - The used and available memory are shown.
2. To free up as much memory as possible, tap **Clean now** and follow the prompts.
 - The selected apps and services in the list will be closed.

Memory card

Once an optional microSD memory card (not included) has been installed in your device, the card memory is displayed in the Storage setting.

For more information, see [Install a SIM card and memory card](#) on page 7.

Mount a memory card

When you install an optional memory card, it is automatically mounted (connected to the device) and prepared for use. However, should you unmount the card without removing it from the device, you need to mount it before it can be accessed.

1. From Settings, tap **Device maintenance** > **Storage**.
2. Tap  **More options** > **Storage settings**.
3. Under **Portable storage**, tap your SD card, and then tap **Mount**.

Remove a memory card

 To prevent damage to information stored on the memory card, unmount the card before removing it from the device.

1. From Settings, tap **Device maintenance** > **Storage**.
2. Tap  **More options** > **Storage settings**.
3. Under **Portable storage**, tap your SD card, and then tap **Unmount**.
4. Remove your memory card from the device.

Format a memory card

 When formatting an SD card, you should back up your music and photo files that are stored on the card because formatting the SD card deletes **ALL** stored files.



1. From Settings, tap **Device maintenance** > **Storage**.
2. Tap  **More options** > **Storage settings**.
3. Under **Portable storage**, tap your SD card, tap **Format**, and then follow the prompts.

Language and input

Configure your device's language and input settings.

Change the device language

You can add languages to your list and organize them according to preference. If an app does not support your default language, then it will move to the next supported language in your list.

1. From Settings, tap  **General management** > **Language and input** > **Language**.
2. Tap  **Add language**, and select a language from the list.
3. Tap **Set as default** to change the device language.
 - To switch to another language on the list, drag  **Move** next to the desired language to the top of the list, and then tap **Done**.

Default keyboard

You can select a default keyboard for your device's menus and keyboards. Additional keyboards can be downloaded from the Google Play store.

1. From Settings, tap  **General management** > **Language and input**.
2. Tap **Default keyboard**, and select a keyboard.

Google Voice typing



Speak rather than type your text entries using Google voice typing.

1. From Settings, tap  **General management** > **Language and input**.
2. Tap **On-screen keyboard** > **Google voice typing**.
 - **Languages:** Select languages for Google voice typing.
 - **Voice Match:** Train Google Assistant to recognize your voice when you say "Ok Google".
 - **Hands-free:** Allow requests with the device locked.
 - **Speech output:** Select options for spoken feedback.
 - **Offline speech recognition:** Download and install speech recognition engines, allowing you to use voice input while not connected to the network.

- **Block offensive words:** Hide search results that contain offensive words.
- **Bluetooth headset:** Records audio through a Bluetooth headset, if available.

Manage on-screen keyboards

Enable or disable on-screen keyboards.

1. From Settings, tap  **General management** > **Language and input**.
2. Tap **On-screen keyboard** >  **Manage keyboards**.
3. Tap each keyboard to enable or disable.

Physical keyboards

Customize options when you have a physical keyboard connected to your device (sold separately).

1. From Settings, tap  **General management** > **Language and input**.
2. Tap **Physical keyboard**, and then choose an option:
 - **Show on-screen keyboard:** Show the on-screen keyboard while a physical keyboard is also being used.
 - **Keyboard shortcuts:** Show explanations of the keyboard shortcuts on the screen.



Show keyboard button

Show a button on the Navigation bar to quickly switch between keyboards.

1. From Settings, tap  **General management** > **Language and input**.
2. Tap **Show keyboard button** to enable this feature.

Text-to-speech

Configure your Text-to-Speech (TTS) options. TTS is used for various accessibility features, such as Voice Assistant.

- From Settings, tap  **General management** > **Language and input** > **Text-to-speech** for options:
 - **Preferred engine:** Choose either the Samsung or Google Text-to-speech engine. Tap  **Settings** for options.
 - **Use system language:** Set the default speech language.
 - **Speech rate:** Set the speed at which the text is spoken.
 - **Pitch:** Set the pitch of the speech.
 - **Play:** Tap to play a short demonstration of speech synthesis.
 - **Reset:** Reset the speech rate and pitch.

Pointer speed

Configure pointer speed for an optional mouse or trackpad (not included).

1. From Settings, tap  **General management** > **Language and input**.
2. Under **Pointer speed**, drag the slider to the right to go faster or to the left to go slower.

Date and time

By default, your device receives date and time information from the wireless network. Outside of network coverage, you can set the date and time manually.

- From Settings, tap  **General management** > **Date and time**. The following options are available:
 - **Automatic date and time:** Receive date and time updates from your wireless network. When Automatic date and time is disabled, the following options are available:
 - **Set date:** Enter the current date.
 - **Set time:** Enter the current time.
 - **Select time zone:** Choose a new time zone.
 - **Use 24-hour format:** Set the format for displaying time.

Report diagnostic information

You can send diagnostic information about your device to Samsung when you are having technical problems.

1. From Settings, tap  **General management** > **Report diagnostic information**.
2. Read and accept the consent information to enable this feature.

Reset

Reset device and network settings. You can also reset your device to its factory defaults.

Reset settings

You can reset your device to its factory default settings, which resets everything except the security, language, and account settings. Personal data is not affected.

1. From Settings, tap  **General management** > **Reset** > **Reset settings**.
2. Tap **Reset settings**, and confirm when prompted.

Reset network settings

You can reset Wi-Fi, mobile data, and Bluetooth settings with Reset network settings.

1. From Settings, tap  **General management** > **Reset** > **Reset network settings**.
2. Tap **Reset settings**, and confirm when prompted.

Factory data reset

You can reset your device to factory defaults, erasing all data from your device.

This action permanently erases ALL data from the device, including Google or other account settings, system and application data and settings, downloaded applications, as well as your music, photos, videos, and other files. Any data stored on an external SD card is not affected.

-  When you sign in to a Google Account on your device, Factory Reset Protection is activated. This protects your device in the event it is lost or stolen.

If you reset your device to factory default settings with the Factory Reset Protection (FRP) feature activated, you must enter the user name and password for a registered Google Account to regain access to the device. You will not be able to access the device without the correct credentials.

 If you reset your Google Account password, it can take 24 hours for the password reset to sync with all devices registered to the account.

Before resetting your device:



1. Verify that the information you want to keep has transferred to your storage area.
2. Log in to your Google Account and confirm your user name and password.

To reset your device:

1. From Settings, tap  **General management** > **Reset** > **Factory data reset**.
2. Tap **Reset** and follow the prompts to perform the reset.
3. When the device restarts, follow the prompts to set up your device.

Auto restart

Optimize your device by restarting it automatically at set times. Any unsaved data will be lost when the device restarts.

1. From Settings, tap  **General management** > **Reset** > **Auto restart**.
2. Tap  to activate Auto restart, and then set the following parameters:
 - **Time:** Set the time of day to restart your device.
 - **Day:** Select the day of the week to automatically restart your device.

Software update

Check for and install available software updates for your device.

- From Settings, tap  **Software update** for the following options:
 - **Check for updates:** Manually check for software updates.
 - **Continue update:** Resume an update that was interrupted.

Lock screen and security



You can secure your device and protect your data by setting a screen lock.

Screen lock types

You can choose from the following screen lock types that offer high, medium, or no security: Swipe, Pattern, PIN, Password, and None.

Set a secure screen lock

It is recommended that you secure your device using a secure screen lock (Pattern, PIN, or Password).

1. From Settings, tap  **Lock screen** > **Screen lock type** and tap a secure screen lock (Pattern, PIN, or Password).
2. Tap  to enable showing notifications on the lock screen. The following options are available:
 - **Hide content:** Enable to hide the content of notifications.
 - **Notification icons only:** Enable to hide notification details and show only the icon.
 - **Transparency:** Adjust the transparency of notifications.
 - **Auto-reverse text color:** Reverse the color of notification text automatically based on the background color.
3. Tap **Done** when finished.
4. Configure the following screen lock options:
 - **Smart Lock:** Unlock your device automatically when trusted locations or other devices have been detected. A secure screen lock is required for this feature.
 - **Secure lock settings:** Customize your secure lock settings. A secure screen lock is required for this feature.

Clock and information

You can configure features that appear on the Lock screen, like the clock and other useful information.

- From Settings, tap  **Lock screen** for the following options:
 - **Clock style:** Set the type and color of the clock on the Lock screen.
 - **Roaming clock:** Change to digital clocks showing both local and home time zones when roaming.
 - **FaceWidgets:** Enable widgets on the Lock screen to get quick access to useful information.
 - **Contact information:** Show your contact information, such as your phone number or email address.
 - **Notifications:** Select which notifications to display on the Lock screen.
 - **App shortcuts:** Select which apps to open from the Lock screen.

Google Play Protect

You can configure Google Play Protect to regularly check your apps and device for security risks and threats.

1. From Settings, tap  **Security** > **Google Play Protect**.
2. Tap options to customize security features.

Find My Mobile

You can protect your device from loss or theft by allowing your device to be locked, tracked online, and for your data to be deleted remotely. For more information, visit samsung.com/us/support/owners/app/find-my-mobile.

-  A Samsung account is required, and Google location service must be turned on in order to use Find My Mobile.

Turn on Find My Mobile

Before you can use the Find My Mobile feature, you must turn it on and customize the options.

1. From Settings, tap  **Security** > **Find My Mobile**.
2. Tap **Add account** and follow the prompts. The following options are available:
 - **Remote controls**: Turn on to access your device remotely.
 - **Google location service**: Turn on to enable Google location service to find your device.
 - **Send last location**: Allow your device to send its last location to the Find My Mobile server when the remaining battery charge falls below a certain level.

 To access your device remotely, visit findmymobile.samsung.com.

Security update

You can easily check the date of the last installed security software update and find out if newer updates are available.

- From Settings, tap  **Security** > **Security update** to see the latest security update installed and check if a newer update is available.

Install unknown apps



You can allow installation of unknown third-party apps from selected apps or sources.

 Installing unknown third-party apps could make your device and personal data more vulnerable to security risks.

1. From Settings, tap  **Security** > **Install unknown apps**.
2. Tap an app or source, and then tap **Allow from this source**.



Secure Folder

You can create a secure folder on your device to protect private content and apps from anyone who may be using your device.

-  You must sign in to your Samsung account, and use secured lock on your device to set up and use Secure Folder.
- From Settings, tap  **Security** > **Secure Folder** and follow the prompts to secure content on your device.



App permission monitor

Apps might access features of your device that you permit them to (like the camera, microphone, or location) when they are running in the background, not just when you are using the app. You can set your device to notify you when this happens.

1. From Settings, tap  **Security** > **App permission monitor**.
2. Tap  next to the apps you want to be notified about.
 - Tap an app to select which permissions you want to be notified about.

Secure startup

You can protect your device by requiring a PIN, pattern, or password when your phone is turned on.

-  A secure screen lock (Pattern, PIN, Password, or Fingerprints) is required to use Secure startup.
- From Settings, tap  **Security** > **Secure startup** and select an option.

Encrypt SD card

You can encrypt your optional memory card (not included) to protect its data. This only allows the SD card information to be accessed from your device with a password.

1. From Settings, tap  **Security** > **Encrypt SD card**.
2. Tap **Encrypt SD card** and follow the prompts to encrypt all data on your memory card.

- 💡 Performing a Factory data reset on your device prevents it from accessing an encrypted SD card. Before initiating a Factory data reset, make sure to decrypt the installed SD card first.

Decrypt SD card

You can decrypt an optional memory card (not included) if it was encrypted by this device. You may want to decrypt the memory card if you plan to use it with another device or before performing a Factory data reset.

1. From Settings, tap  **Security** > **Decrypt SD card**.
2. Tap **Decrypt SD card** and follow the prompts to decrypt all data on your memory card.

Factory data reset password

You can require a password to reset your device to factory default settings.

- From Settings, tap  **Security** > **Other security settings** > **Set up/change password** and enter a password.

Set up SIM card lock

You can set up a PIN to lock your SIM card, which prevents unauthorized use of your SIM card if someone attempts to use it another device.

- From Settings, tap  **Security** > **Other security settings** > **Set up SIM card lock** and follow the prompts.
 - Tap **Lock SIM card** to turn on the feature.
 - Tap **Change SIM card PIN** to create a new PIN.

View passwords

You can have characters displayed briefly in password fields as you type them.

- From Settings, tap  **Security** > **Other security settings** > **Make passwords visible** to turn on the feature.

Security update service

You can set your device to automatically check for security updates.

- From Settings, tap  **Security** > **Other security settings** for the following options:
 - **Security policy updates:** Check for security updates.
 - Automatic downloads can be limited to when your device is connected to a Wi-Fi network.
 - **Send security reports:** Use Wi-Fi to send security reports to Samsung for threat analysis.

Device administration

You can authorize security features and apps (like Find My Mobile) to have administrative access to your device.

1. From Settings, tap  **Security** > **Other security settings** > **Device admin apps**.
2. Tap an option to turn it on as a device administrator.

Credential storage

You can manage the trusted security certificates installed on your device, which verify the identity of servers for secure connections.

- From Settings, tap  **Security** > **Other security settings** for the following options:
 - **Storage type:** Select a storage location for credential contents.
 - **View security certificates:** Review the trusted CA certificates that are installed on your device.
 - **User certificates:** View user certificates that identify your device.
 - **Install from device storage:** Install a new certificate from storage.
 - **Clear credentials:** Erase credential contents from the device and reset the password.

Advanced security settings

You can use these options to configure advanced security settings to better protect your device.

- From Settings, tap  **Security** > **Other security settings**.
 - **Trust agents:** Allow trusted devices to perform selected actions when connected.
 - This option is only displayed when a lock screen is turned on. For more information, see **Set a secure screen lock** on page 117.
 - **Pin windows:** Pin an app on your device screen, which prevents access to other features of your device.
 - **Usage data access:** View which apps can access your device's usage history.
 - **Notification access:** View which apps can access notifications you receive on your device.
 - **Do not disturb permission:** View which apps have permission to change the Do not disturb settings.

Accounts

You can connect to and manage your accounts, including your Google Account, Samsung account, email, and social networking accounts.



Samsung Cloud

You can keep your data safe by backing up and restoring your device. You can also sync your data from multiple devices. For more information, visit samsung.com/us/support/owners/app/samsung-cloud.

1. From Settings, tap  **Cloud and accounts** > **Samsung Cloud**.
 - If a Samsung account has not been added, the screens explain how to create or sign in to your account.
2. Once a Samsung account is configured, you can view and manage items stored in the Samsung Cloud.

Add an account

You can add and sync all your email, social networking, and picture and video sharing accounts.

1. From Settings, tap  **Cloud and accounts** > **Accounts** >  **Add account**.
2. Tap one of the account types.
3. Follow the prompts to enter your credentials and set up the account.
 - Tap **Auto sync data** to enable automatic updates to your accounts.



Account settings

Each account has its own custom settings. You can configure common settings for all accounts of the same type. Account settings and available features vary between account types and service providers. Contact your service provider for more information on your account's settings.

1. From Settings, tap  **Cloud and accounts** > **Accounts** > **[Account type]**.
2. Tap an account to configure that account's sync settings.
3. Tap other available options for the account type.

Synchronize accounts

You can synchronize your calendar, contacts, and other types of accounts.

1. From Settings, tap  **Cloud and accounts** > **Accounts** > [Account type].
2. Tap an account to view the sync settings for that account.
3. Tap individual data items to sync.
4. Tap  **More options** > **Sync now** to synchronize the account.

Remove an account

You can remove accounts from your device.

1. From Settings, tap  **Cloud and accounts** > **Accounts** > [Account type].
2. Tap the account and then tap **Remove account**.

Backup and restore

You can configure your device to back up data to your personal accounts.

Google account

You can enable backup of your information to your Google account.

- From Settings, tap  **Cloud and accounts** > **Backup and restore** for options:
 - **Back up my data:** Enable back up of application data, Wi-Fi passwords, and other settings to Google servers.
 - **Backup account:** Select a Google Account to be used as your backup account.
 - **Automatic restore:** Enable automatic restoration of settings from Google servers.

External storage transfer

You can back up your data to an SD card or USB storage device, or restore backup data using Smart Switch. For more information, see **Transfer data from your old device** on page 13.

- From Settings, tap  **Cloud and accounts** > **Backup and restore** > **External storage transfer**.

Google settings

You can configure your device's Google settings. Available options depend on your Google account.

- From Settings, tap  **Google**, and select an option to customize.

Accessibility

There are accessibility settings for people who need help seeing, hearing or otherwise operating their device. Accessibility services are special features that make using the device easier for everyone. For more information about Accessibility for Samsung products, please contact us at accessibility@sea.samsung.com.

Vision

You can configure Accessibility features to assist with visual aspects of your device.

Contrast and color

You can adjust the colors and contrast of text and other screen elements for easier viewing.

- From Settings, tap  **Accessibility** > **Vision** and tap an option:
 - **High contrast fonts:** Adjust the color and outline of fonts to increase the contrast with the background.
 - **High contrast keyboard:** Adjust the size of the Samsung keyboard and change its colors to increase the contrast between the keys and the background.
 - **Show button shapes:** Show buttons with shaded backgrounds to make them stand out better against the wallpaper.
 - **Color inversion:** Reverse the display of colors from white text on a black background to black text on a white background.
 - **Color correction:** Adjust the color of the screen if you find it difficult to see some colors.
 - **Remove animations:** Remove certain screen effects if you have sensitivity to animation or screen movements.

Magnification and gestures

You can increase the size of supported screen elements and create shortcuts for accessibility features on your device.

- From Settings, tap  **Accessibility** > **Vision** and tap an option:
 - **Font:** Configure the screen zoom level and font size and style.
 - **Magnifier window:** Magnify content shown on the screen.
 - **Large mouse/touchpad pointer:** Use a large pointer for a connected mouse or touchpad (accessories not included).
 - **Magnification:** Use exaggerated gestures such as triple-tapping, double pinching, and dragging two fingers across the screen.
 - **Rapid key input:** Tap keys once to enter text.

Privacy

For added privacy, you can set your screen to remain off at all times.

- From Settings, tap  **Accessibility** > **Vision** and tap an option:
 - **Dark screen:** Keep the screen turned off at all times to protect your privacy.

Hearing

You can configure Accessibility features to assist with audial aspects of the device.

Sounds

You can adjust audio quality when using hearing aids or earphones.

- From Settings, tap  **Accessibility** > **Hearing** and tap an option:
 - **Mute all sounds:** Turn off all notifications and audio for privacy.
 - **Hearing aids:** Improve the sound quality of hearing aids.
 - **Left/right sound balance:** Use the slider to adjust the left and right balance when listening to audio in stereo.
 - **Mono audio:** Switch audio from stereo to mono when using one earphone.

Visual cues

You can receive visible notifications for certain sounds, use real-time texting when messaging, and watch closed captions when viewing multimedia.

- From Settings, tap  **Accessibility** > **Hearing** and tap an option:
 - **Real time text:** Activate real-time text (RTT) calling.
 - **Flash notification:** Set the camera light or screen to blink whenever you receive a notification.
 - **Samsung subtitles (CC):** Use Samsung subtitles with multimedia files when available.
 - **Google subtitles (CC):** Use Google subtitles with multimedia files when available.

Dexterity and interaction

You can configure Accessibility features to assist with limited dexterity when interacting with your device.

Alternate input

You can control your device using different kinds of inputs and controls.

- From Settings, tap  **Accessibility** > **Dexterity and interaction** and tap an option:
 - **Assistant menu:** Improve device accessibility for users with reduced dexterity.
 - **Click after pointer stops:** Automatically click on an item after the pointer stops over it.

Screen interactions

You can adjust your screen to be less sensitive to taps and touches.

- From Settings, tap  **Accessibility** > **Dexterity and interaction** and tap an option:
 - **Touch and hold delay:** Select a time interval for this action.
 - **Interaction control:** Customize areas of screen interactions, hardkeys, and the keyboard.

Accessibility services

You can customize additional accessibility features and services for your device.

 Additional accessibility apps may be downloaded from the Google Play store.

○ From Settings, tap  **Accessibility** and tap an option:

- **Text-to-speech:** Set your preferred text-to-speech (TTS) engine and options. For more information, see **Text-to-speech** on page 114.
- **Direction lock:** Unlock the screen by swiping in a series of directions.
- **Direct access:** Open your accessibility settings by pressing the Volume up key and the Power key together.
- **Accessibility shortcut:** Quickly turn on accessibility features using the Volume keys.
- **Notification reminder:** Beep at set intervals to remind you of any unread notifications.
- **Answering and ending calls:** Select shortcuts for answering and ending calls.
- **Single tap mode:** Dismiss or snooze alarms, calendar events, and timer alerts, and answer or reject incoming calls with a single tap.

 Other installed accessibility services may be listed and configured under Services section.

Other settings

Configure features on your device that make it easier to use.

Help

View the user manual on your device.

○ From Settings, tap  **Help**.



Device assistance app

Device assistance app helps you by gathering information from the screen currently shown.

1. From Settings, tap  **Advanced features** > **Device assistance app**.
2. Tap an option to customize:
 - **Device assistance app**: Select your default assistance app.
 - **Analyze on-screen text**: Analyze text shown on the screen to provide related content.
 - **Analyze on-screen images**: Take and analyze images of the screen.

Dual messenger

Use two separate accounts for the same app.

1. From Settings, tap  **Advanced features** > **Dual messenger**.
2. Tap  next to supported apps to enable the feature for each app.

About phone

View information about your device, including current status, legal information, hardware and software versions, and more.

1. From Settings, tap  **About phone**, and then view your phone number, model number, serial number, and IMEI information.
2. Tap additional items to view more information about your device.

Legal information

READ THIS INFORMATION BEFORE USING YOUR MOBILE DEVICE.

Arbitration Agreement - This Product is subject to a binding arbitration agreement between you and SAMSUNG ELECTRONICS AMERICA, INC. ("Samsung"). You can opt out of the agreement within 30 calendar days of the first consumer purchase by emailing optout@sea.samsung.com or calling 1-800-SAMSUNG (726-7864) and providing the applicable information. For complete terms and conditions that bind you and Samsung, refer to the "Arbitration Agreement" section of the Terms & Conditions, included with the Product.

Find legal information online

The full Arbitration Agreement, Standard Limited Warranty, End User License Agreement (EULA), and Health & Safety Information for your device are available online.

Arbitration Agreement, Standard Limited Warranty, and Health & Safety Information:

Phone:

- English: samsung.com/us/Legal/Phone-HSGuide
- Spanish: samsung.com/us/Legal/Phone-HSGuide-SP

Tablet:

- English: samsung.com/us/Legal/Tablet-HSGuide
- Spanish: samsung.com/us/Legal/Tablet-HSGuide-SP

End User License Agreement:

- English: samsung.com/us/Legal/SamsungLegal-EULA4
- Spanish: samsung.com/us/Legal/SamsungLegal-EULA4/#SPANISH

Find legal information on the mobile device

The full Arbitration Agreement, Standard Limited Warranty, End User License Agreement (EULA) and Health & Safety Information are also available on the device, in the Samsung legal section of Settings. The location depends on the device, and is usually in the “About device” or “About phone” section, for example:

- **Settings > About phone or About device or About tablet > Legal information > Samsung legal**
- Or, use the Search feature to search for “Legal”.

Intellectual property

All Intellectual Property, as defined below, owned by or which is otherwise the property of Samsung or its respective suppliers relating to the SAMSUNG mobile device, including but not limited to, accessories, parts, or software relating thereto (the “mobile device”), is proprietary to Samsung and protected under federal laws, state laws, and international treaty provisions. Intellectual Property includes, but is not limited to, inventions (patentable or unpatentable), patents, trade secrets, copyrights, software, computer programs, and related documentation and other works of authorship.

You may not infringe or otherwise violate the rights secured by the Intellectual Property. Moreover, you agree that you will not (and will not attempt to) modify, prepare derivative works of, reverse engineer, decompile, disassemble, or otherwise attempt to create source code from the software. No title to or ownership in the Intellectual Property is transferred to you. All applicable rights of the Intellectual Property shall remain with SAMSUNG and its suppliers.

Open source software

Some software components of this product, including but not limited to 'PowerTOP' and 'e2fsprogs', incorporate source code covered under GNU General Public License (GPL), GNU Lesser General Public License (LGPL), OpenSSL License, BSD License and other open source licenses. To obtain the source code covered under the open source licenses, please visit: opensource.samsung.com

Disclaimer of warranties; exclusion of liability

The information below explains that a user accepts this Product as sold, including the hardware and software components as created and packaged for sale. If the user changes these parameters through a unique modification, Samsung will not be held responsible for damages or issues that result from these end-user changes.

Except as set forth in the Standard Limited Warranty that accompanies the Product, the purchaser takes the product "as is", and Samsung makes no express or implied warranty of any kind whatsoever with respect to the Product, including but not limited to the:

- merchantability of the Product or its fitness for any particular purpose or use;
- design, condition or quality of the Product;
- performance of the Product;
- workmanship of the Product or the components contained therein; or
- compliance of the Product with the requirements of any law, rule, specification or contract pertaining thereto.

Nothing contained in the User Manual shall be construed to create an express or implied warranty of any kind whatsoever with respect to the Product. In addition, Samsung shall not be liable for any damages of any kind resulting from the purchase or use of the Product or arising from the breach of the express warranty, including incidental, special or consequential damages, or loss of anticipated profits or benefits.

Modification of software

Samsung is not liable for performance issues or incompatibilities caused by your editing of registry settings, or your modification of Operating System (OS) software.

Using custom OS software may cause your device and applications to work improperly. Your carrier may not permit users to download certain software, such as custom OS.

Notice from Cricket

Your device is designed to make it easy for you to access a wide variety of content. For your protection, we want you to be aware that some applications that you enable may involve the location of your device being shared. For applications available through Cricket, we offer privacy controls that let you decide how an application may use the location of your device and other devices on your account. However, the Cricket privacy tools do not apply to applications available outside of Cricket. Please review the terms and conditions and the associated privacy policy for each location-based service to learn how location information will be used and protected.

In addition, your Cricket device may be used to access the Internet and to download, and/or purchase goods, applications, and services from Cricket or elsewhere from third parties.

Cricket provides tools for you to control access to the Internet and certain Internet content. These controls may not be available for certain devices which bypass Cricket controls.

Samsung Knox

Samsung Knox is Samsung's security platform and is a mark for a Samsung device tested for security with enterprise use in mind. Additional licensing fee may be required. For more information about Knox, please refer to: samsung.com/us/knox.

Restricting children's access to your mobile device

Your device is not a toy. Do not allow children to play with it because they could hurt themselves and others, damage the device, or make calls that increase your device bill. Keep the device and all its parts and accessories out of the reach of small children.

Samsung Electronics America, Inc.

Address:

85 Challenger Road
Ridgefield Park
New Jersey 07660

Phone: 1-800-SAMSUNG (726-7864)

Internet: samsung.com

©2019 Samsung Electronics America, Inc. Samsung, Samsung Galaxy, Multi Window, and Smart Switch are all trademarks of Samsung Electronics Co., Ltd.

Other marks are the property of their respective owners.

Manufactured under license from Dolby Laboratories. Dolby, Dolby Atmos, and the double-D symbol are trademarks of Dolby Laboratories.

© 2019 Cricket Wireless LLC. All rights reserved. Cricket and the Cricket logo are registered trademarks under license to Cricket Wireless LLC.



Some multimedia (audio/video) files contain Digital Rights Management (DRM) technology to verify you have the right to use the files. Preloaded apps on your device may not be compatible with DRM-protected files.

Screen images are simulated. Appearance of device may vary.

The actual available capacity of the internal memory is less than the specified capacity because the operating system and default applications occupy part of the memory. The available capacity may change when you upgrade the device.

Please check with your service provider to verify qualifying services/features.