

SAMSUNG
Galaxy TabPro S

T A B L E T

User Manual

Please read this manual before operating your device
and keep it for future reference.

SAMSUNG

Legal Notices

WARNING! This product contains chemicals known to the State of California to cause cancer, birth defects, or other reproductive harm. For more information, please call 1-800-SAMSUNG (726-7864).

Intellectual Property

All Intellectual Property, as defined below, owned by or which is otherwise the property of Samsung or its respective suppliers relating to the SAMSUNG mobile device, including but not limited to, accessories, parts, or software relating thereto (the “mobile device”), is proprietary to Samsung and protected under federal laws, state laws, and international treaty provisions. Intellectual Property includes, but is not limited to, inventions (patentable or unpatentable), patents, trade secrets, copyrights, software, computer programs, and related documentation and other works of authorship. You may not infringe or otherwise violate the rights secured by the Intellectual Property. Moreover, you agree that you will not (and will not attempt to) modify, prepare derivative works of, reverse engineer, decompile, disassemble, or otherwise attempt to create source code from the software. No title to or ownership in the Intellectual Property is transferred to you. All applicable rights of the Intellectual Property shall remain with SAMSUNG and its suppliers.

Open Source Software

Some software components of this product incorporate source code covered under GNU General Public License (GPL), GNU Lesser General Public License (LGPL), OpenSSL License, BSD License and other open source licenses. To obtain the source code covered under the open source licenses, please visit: opensource.samsung.com

Disclaimer of Warranties; Exclusion of Liability

EXCEPT AS SET FORTH IN THE EXPRESS WARRANTY CONTAINED ON THE WARRANTY PAGE ENCLOSED WITH THE PRODUCT, THE PURCHASER TAKES THE PRODUCT “AS IS”, AND SAMSUNG MAKES NO EXPRESS OR IMPLIED WARRANTY OF ANY KIND WHATSOEVER WITH RESPECT TO THE PRODUCT, INCLUDING BUT NOT LIMITED TO THE MERCHANTABILITY OF THE PRODUCT OR ITS FITNESS FOR ANY PARTICULAR PURPOSE OR USE; THE DESIGN, CONDITION OR QUALITY OF THE PRODUCT; THE PERFORMANCE OF THE PRODUCT; THE WORKMANSHIP OF THE PRODUCT OR THE COMPONENTS CONTAINED THEREIN; OR COMPLIANCE OF THE PRODUCT WITH THE REQUIREMENTS OF ANY LAW, RULE, SPECIFICATION OR CONTRACT PERTAINING THERETO. NOTHING CONTAINED IN THE INSTRUCTION MANUAL SHALL BE CONSTRUED TO CREATE AN EXPRESS OR IMPLIED WARRANTY OF ANY KIND WHATSOEVER WITH RESPECT TO THE PRODUCT. IN ADDITION, SAMSUNG SHALL NOT BE LIABLE FOR ANY DAMAGES OF ANY KIND RESULTING FROM THE PURCHASE OR USE OF THE PRODUCT OR ARISING FROM THE BREACH OF THE EXPRESS WARRANTY, INCLUDING INCIDENTAL, SPECIAL OR CONSEQUENTIAL DAMAGES, OR LOSS OF ANTICIPATED PROFITS OR BENEFITS.

Modification of Software

SAMSUNG IS NOT LIABLE FOR PERFORMANCE ISSUES OR INCOMPATIBILITIES CAUSED BY YOUR EDITING OF REGISTRY SETTINGS, OR YOUR MODIFICATION OF OPERATING SYSTEM SOFTWARE.

USING CUSTOM OPERATING SYSTEM SOFTWARE MAY CAUSE YOUR DEVICE AND APPLICATIONS TO WORK IMPROPERLY. YOUR CARRIER MAY NOT PERMIT USERS TO DOWNLOAD CERTAIN SOFTWARE, SUCH AS CUSTOM OS.

Samsung Electronics America (SEA), Inc.

Address:

85 Challenger Road
Ridgefield Park,
New Jersey 07660

Phone:

1-800-SAMSUNG (726-7864)

Internet Address:

samsung.com

©2016 Samsung Electronics America, Inc.
Samsung, Samsung Galaxy, are all trademarks of
Samsung Electronics Co., Ltd.

Note: Screen images are simulated. Appearance of
device may vary.

Do you have questions about your Samsung Mobile Device?

For 24 hour information and assistance, we offer
a new FAQ/ARS System (Automated Response
System) at: samsung.com/us/support

The actual available capacity of the internal memory
is less than the specified capacity because the
operating system and default applications occupy
part of the memory. The available capacity may
change when you upgrade the device.

Nuance®, VSuite™, T9® Text Input, and the Nuance
logo are trademarks or registered trademarks of
Nuance Communications, Inc., or its affiliates in the
United States and/or other countries.

The Bluetooth® word mark, figure mark (stylized
“B Design”), and combination mark (Bluetooth word
mark and “B Design”) are registered trademarks and
are wholly owned by the Bluetooth SIG.

Wi-Fi is a registered trademark of the
Wireless Fidelity Alliance, Inc.

Microsoft is a registered trademark of the
Microsoft Corporation.

Legal Information

Important legal information can be accessed in
writing on the mobile device or at samsung.com

READ THIS INFORMATION BEFORE USING YOUR MOBILE DEVICE.

Samsung Limited Warranty - This product is
covered under the applicable Samsung Limited
Warranty **INCLUDING ITS DISPUTE RESOLUTION
PROCEDURE and your right to opt out of
arbitration within 30 calendar days of the first
consumer purchase. You may opt out by either
sending an email to optout@sea.samsung.com
with the subject line “Arbitration Opt-Out” or by
calling 1-800-SAMSUNG (726-7864).** For more
detailed procedures, please refer to the “Dispute
Resolution Procedures and Arbitration and Opt-Out”
section of the Limited Warranty.

Full written terms and detailed information about
the warranty and obtaining service are available on
the device at: **Settings > Extras > Galaxy Settings
> Legal information > Samsung legal** or you may
access the online version of the Health and Safety,
Warranty, and End User License Agreement for your
device at:

English

samsung.com/us/Legal/Tablet-HSGuide

Spanish

samsung.com/us/Legal/Tablet-HSGuide-SP

The online version of the **End User License
Agreement (EULA)** for your device can be found
online at:

samsung.com/us/Legal/SamsungLegal-EULA4

Table of Contents

Basics	1	Ease of Access	47
Read Me First.....	2	Privacy	48
Package Contents.....	3	Update and Security.....	49
Device Layout.....	4	Extras.....	50
Battery.....	7	Appendix	51
Turning the Device On and Off	9	Troubleshooting.....	52
Keyboard Cover.....	10	Windows Recovery Function	55
Touchscreen.....	13	Removing the Battery	56
Start Screen.....	15		
Lock Screen	20		
Action Center.....	21		
Search Box.....	22		
Entering Text	23		
Opening Apps.....	25		
Split Screen View	26		
Device and Data Management	27		
Applications	28		
Installing or Uninstalling Apps.....	29		
Scrap Box.....	30		
SideSync	31		
Samsung Update	36		
Samsung Recovery	37		
Online Support (S Services).....	38		
Settings	39		
Introduction	40		
System	41		
Devices.....	42		
Network and Internet.....	43		
Personalization	44		
Accounts.....	45		
Time and Language.....	46		

Basics

Learn about your mobile device hardware, assembly procedures, and how to get started using your new device.

Read Me First

Please read this manual before using the device to ensure safe and proper use.

- Descriptions are based on the device's default settings.
- Some content may differ from your device depending on the region, service provider, model specifications, or device's software.
- Content (high quality content) that requires high CPU and RAM usage will affect the overall performance of the device. Apps related to the content may not work properly depending on the device's specifications and the environment that it is used in.
- Samsung is not liable for performance issues caused by apps supplied by providers other than Samsung.
- Samsung is not liable for performance issues or incompatibilities caused by edited registry settings or modified operating system software. Attempting to customize the operating system may cause the device or apps to work improperly.
- Software, sound sources, wallpapers, images, and other media provided with this device are licensed for limited use. Extracting and using these materials for commercial or other purposes is an infringement of copyright laws. Users are entirely responsible for illegal use of media.
- Default apps that come with the device are subject to updates and may no longer be supported without prior notice. If you have questions about an app provided with the device, contact a Samsung Service Center. For user-installed apps, contact service providers.

- Modifying the device's operating system or installing softwares from unofficial sources may result in device malfunctions and data corruption or loss. These actions are violations of your Samsung license agreement and will void your warranty.

Warnings, Cautions, and Notes

Warning: Situations that could cause injury to yourself or others.

Caution: Situations that could cause damage to your device or other equipment.

Note: Notes, usage tips, or additional information.

Package Contents

Check the product box for the following items:

- Device
- Keyboard Cover
- Quick start guide
- USB charger/travel adapter

Notes:

- The items supplied with the device and any available accessories may vary depending on the region or service provider.
- The supplied items are designed only for this device and may not be compatible with other devices.
- Appearances and specifications are subject to change without prior notice.
- You can purchase additional accessories from your local Samsung retailer. Make sure they are compatible with the device before purchase.
- Use only Samsung-approved accessories. Using unapproved accessories may cause the performance problems and malfunctions that are not covered by the warranty.
- Availability of all accessories is subject to change depending entirely on manufacturing companies. For more information about available accessories, visit [samsung.com](https://www.samsung.com).

Device Layout

Front View

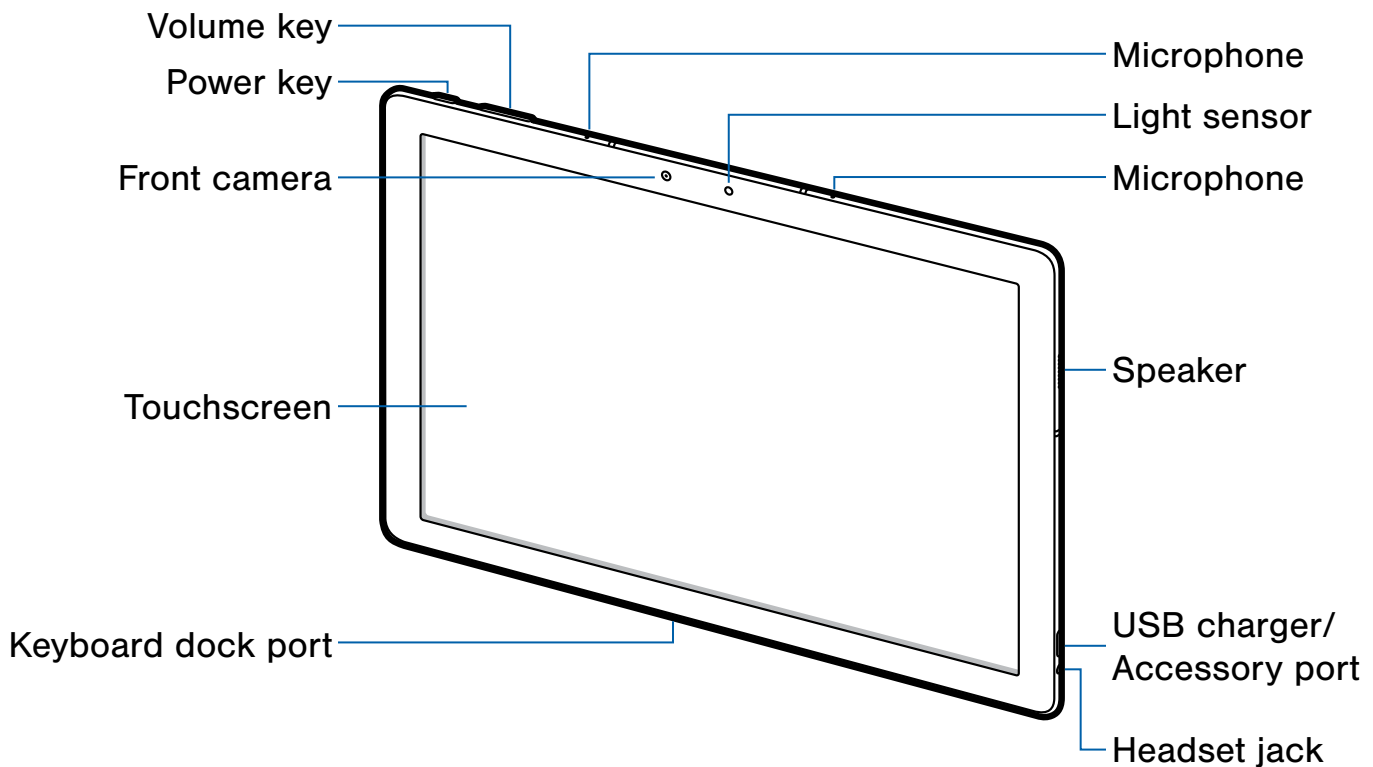

- **Microphone:** Record audio and detects voice commands.
- **Light sensor:** Adjust display based on ambient lighting.
- **Speaker:** Plays music and other sounds.
- **USB charger/Accessory port:** Connect the Charger/USB cable (included), and other optional accessories (not included).
- **Headset jack:** Connect an optional headset (not included).
- **Keyboard dock port:** Connect to the Keyboard Cover.
- **Touchscreen:** Touch to navigate the device and perform various actions.
- **Front camera:** Take self-portraits and record videos of yourself.
- **Power key:** Press and hold to turn the device on or off. Press to lock or wake up the screen.
- **Volume key:** Adjust the volume of your device's sounds.

Back View

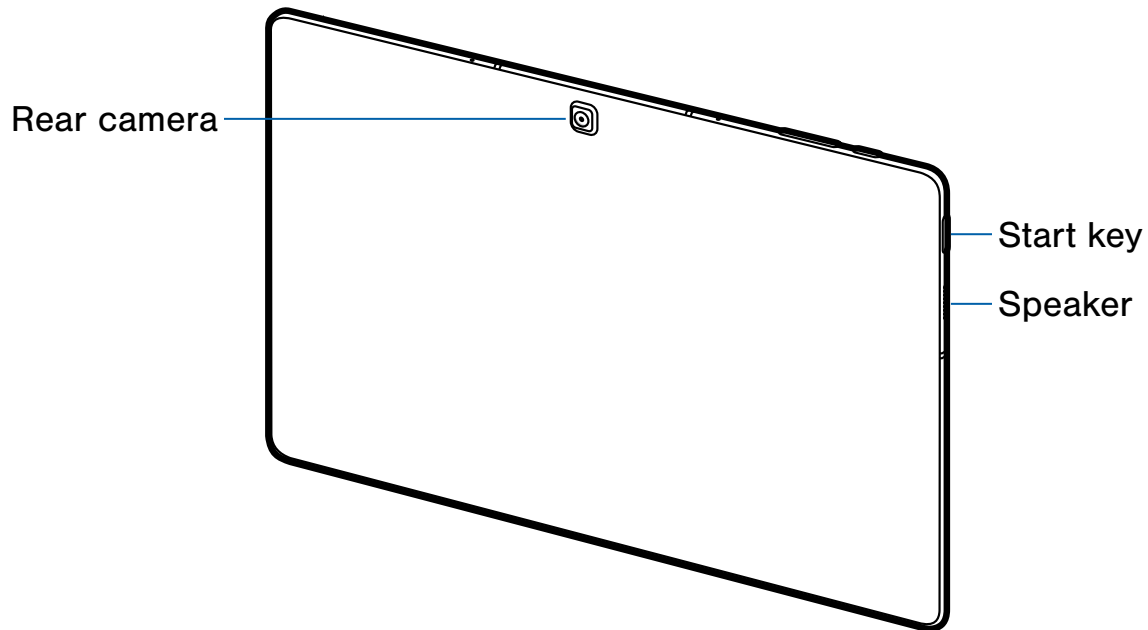

- **Start key:** Open the Start menu.
- **Speaker:** Plays music and other sounds.
- **Rear camera:** Take pictures and record videos.

Notes:

- Using a Samsung-approved screen protector is recommended. Unapproved screen protectors may cause the sensors to malfunction.
- Do not allow water to contact the touchscreen. The touchscreen may malfunction in humid conditions or when exposed to water.

Keyboard Cover

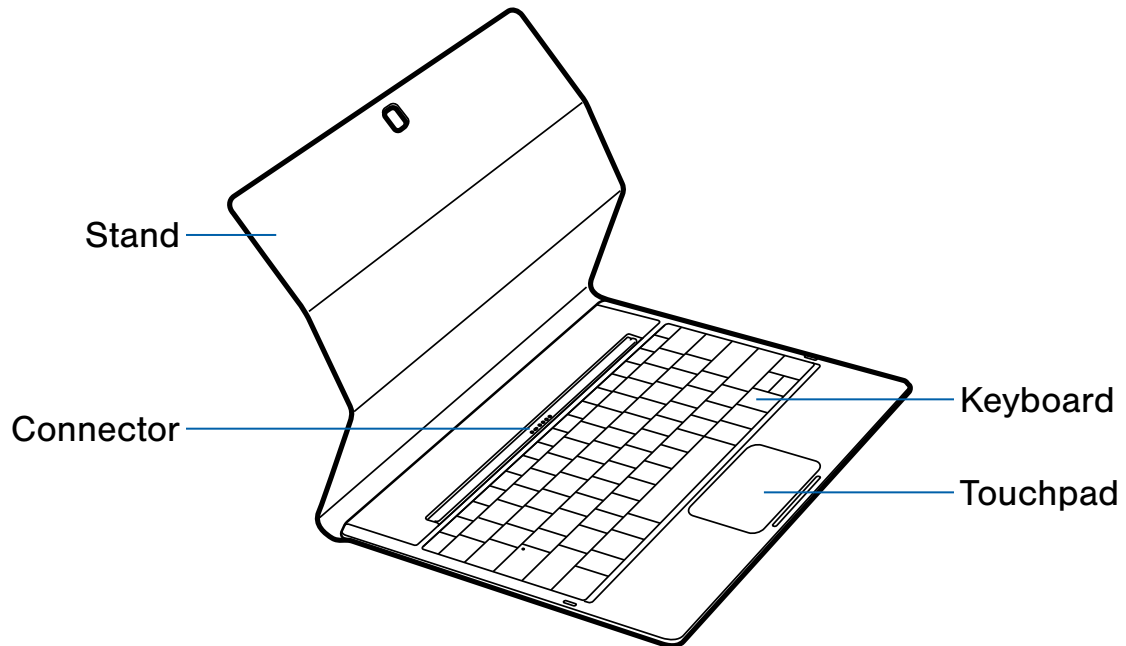

- **Keyboard:** Enter text with a full QWERTY keyboard.
- **Touchpad:** Control the onscreen cursor.
- **Connector:** Connect the Keyboard cover to the device.
- **Stand:** Fold to create a stand for the device.

Battery

Charging the Battery

Charge the battery before using it for the first time or when it has been unused for extended periods.

Important: Use only Samsung-approved chargers, batteries, and cables. Samsung accessories are designed to maximize battery life. Using other accessories may invalidate your warranty and may cause damage.

1. Connect the USB cable to the USB power adapter, and then plug the end of the USB cable into the USB charger/Accessory port.

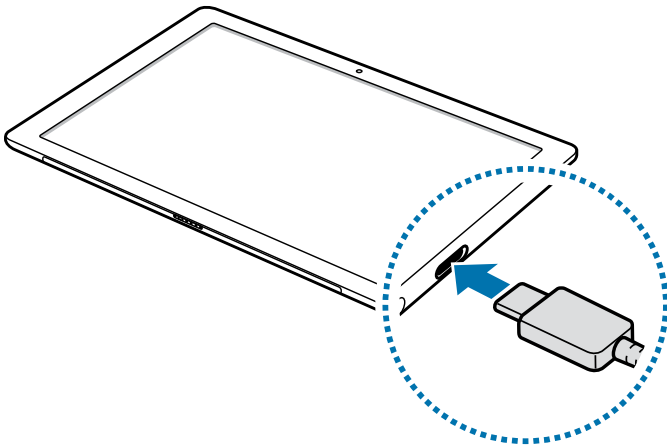

Caution: Connecting the charger improperly may cause serious damage to the device. Any damage caused by misuse is not covered by the warranty.

2. Plug the USB power adapter into an electric socket.
3. After fully charging, disconnect the device from the charger. First unplug the charger from the device, and then unplug it from the electric socket.

Note: Failure to unplug the wall charger before you remove the battery can cause damage to the device.

Viewing the Remaining Charging Time

- ▶ While charging, on the taskbar, tap **Start** > **Settings** > **System** > **Battery saver**.

Note: The actual charging time may vary depending on the status of your device and the charging conditions. The remaining charging time may not display when you charge the device in very cold or very hot conditions.

Reducing the Battery Consumption

Your device provides various options that help you conserve battery power.

- When you are not using the device, switch to sleep mode by pressing the Power key.
- Activate battery saver mode.
- Close unnecessary apps.
- Deactivate the Bluetooth feature when not in use.
- Deactivate the Wi-Fi feature when not in use.
- Deactivate auto-syncing of apps.
- Decrease the backlight time.
- Decrease the screen brightness.

Battery Charging Tips and Precautions

- When the battery power is low, the battery icon appears empty.
- If the battery is completely discharged, the device cannot be turned on immediately when the charger is connected. Allow a depleted battery to charge for a few minutes before turning on the device.
- If you use multiple apps at once, network apps, or apps that need a connection to another device, the battery will drain quickly. To avoid losing power during a data transfer, always use these apps after fully charging the battery.
- Using a power source other than the USB power adapter, such as a computer, may result in a slower charging speed due to a lower electric current.
- The device can be used while it is charging, but it may take longer to fully charge the battery.
- If the device receives an unstable power supply while charging, the touchscreen may not function. If this happens, unplug the charger from the device.
- While charging, the device and the charger may heat up. This is normal and should not affect the device's lifespan or performance. If the battery gets hotter than usual, the charger may stop charging.
- If the device is not charging properly, take the device and the charger to a Samsung Service Center.

Battery Saver

Save the battery power by limiting the device's functions.

- ▶ On the taskbar, tap  **Start > Settings > System > Battery saver**, and then tap the switch under **Battery saver is currently** to activate it.
 - To automatically activate battery saver mode when the remaining battery power reaches the preset level, tap **Battery saver settings** and select an option.

Turning the Device On and Off



When you turn on your device for the first time or after performing a data reset, follow the prompts to set up your device.

Note: Before turning on your device for the first time, you must connect the device to a power supply.

To turn on the device:

- ▶ Press and hold the **Power** key for a few seconds to turn on the device.

To turn off the device:

- ▶ Tap  **Start** > **Power** > **Shut down**. In **Tablet mode**, tap  **Power** > **Shut down**.

- or -

Press and hold the **Power** key until the locked screen appears, and then drag the locked screen downwards.

Note: Follow all posted warnings and directions from authorized personnel in areas where the use of wireless devices is restricted, such as airplanes and hospitals.

Restarting the Device

To restart the device:

- ▶ Tap  **Start** > **Power** > **Restart**. In **Tablet mode**, tap  **Power** > **Restart**.

If your device is frozen and unresponsive:

1. Press and hold the **Power** key for more than 10 seconds until the device turns off.
2. Press and hold the **Power** key again to restart it.

Keyboard Cover

Introduction

Connecting the device to the Keyboard Cover allows you to use a traditional keyboard and touchpad. The touchpad has two click buttons so you can use the touchpad like a mouse. You can also stand your device upright using the stand on the Keyboard Cover.

When you close the Keyboard Cover, your device will enter sleep mode. When you open the cover and set the device in position using the stand, the touchscreen will turn on.

To change the settings:

1. Touch and hold  **Start**, tap **Control Panel** > **Hardware and Sound** > **Power Options** > **Choose what closing the lid does**.
2. Configure the **When I close the lid:** settings.

Important: The device contains magnets. The American Heart Association (US) and the Medicines and Healthcare Products Regulatory Agency (UK) both warn that magnets can affect the operation of implanted pacemakers, cardioverters, defibrillators, insulin pumps or other electro medical devices (collectively, “Medical Device”) within the range of 15 cm (6 inches). If you are a user of any of these Medical Devices, **DO NOT USE THIS DEVICE UNLESS YOU HAVE CONSULTED WITH YOUR PHYSICIAN.**

Caution: Do not store your device near magnetic fields. Magnetic stripe cards, including credit cards, phone cards, passbooks, and boarding passes, may be damaged by magnetic fields.

Connecting the Keyboard Cover

1. Connect the keyboard dock port at the bottom of the device to the connector on the Keyboard Cover.
2. Attach the stand to the device, and then set the device in position.

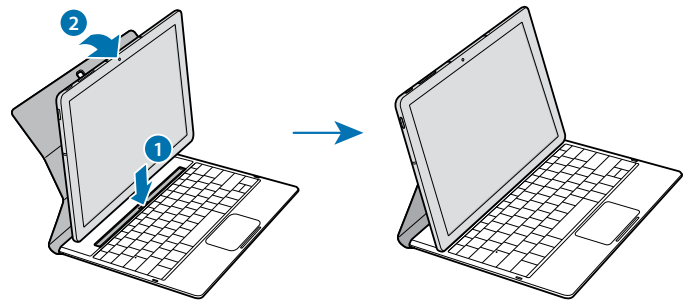

Note: Use care when connecting and removing the tablet from the keyboard case.

Hot Keys





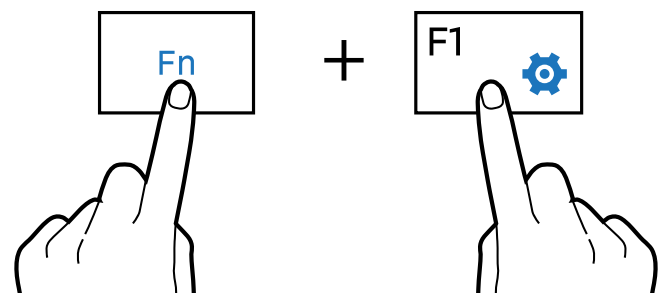







Use hot keys to easily access features and change settings, such as brightness and volume.

- To use hot keys, simultaneously press and hold the **Fn** key and press a **hot key**.



If you lock the Fn key, you can use hot keys without pressing the Fn key.

- To lock the Fn key, tap the **Fn Lock** key.

Key/Icon	Function
F1 	Launch Settings.
F2 	Adjust the brightness of the display.
F3 	
F4 	Switch between the LCD and an external display when an external display is connected to the device.
F5 	Lock the touchpad.
F6 	Mute or unmute the audio.
F7 	Adjust the volume.
F8 	
F9 	Open the search box. If Cortana is supported, Cortana will be activated.
F10 	Open the task view screen.
F11 	Enter full screen mode. This function may not be available depending on the app.
F12 	Activate or deactivate Airplane mode.
Ctrl 	Perform the right-click function.

Touchpad

Use the touchpad to move the cursor or select items. The left and right buttons of the touchpad function the same as the left and right buttons of a mouse.

Note: Use only your fingers on the touchpad.

Basic Touchpad Functions

Moving

To move the cursor, move your finger on the touchpad.

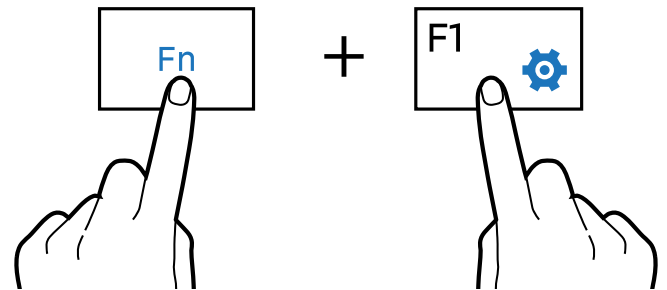

Clicking

Tap the touchpad or press the left-click button.

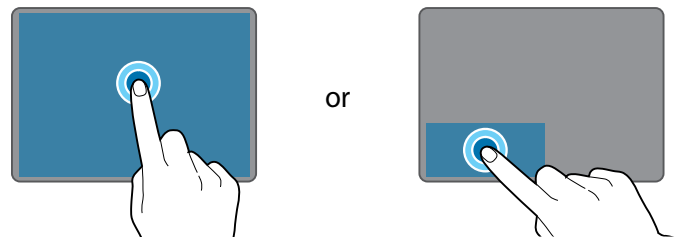

Double-Clicking

Double-tap the touchpad or press the left-click button twice.

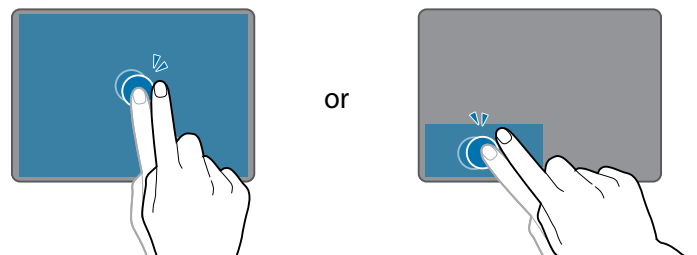

Right-Clicking

Press the right-click button to perform the right-click function.

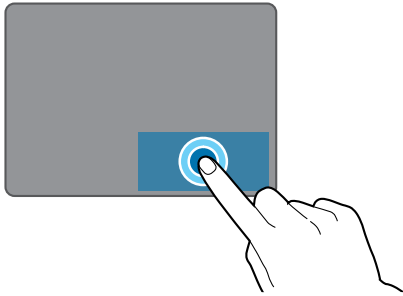

Dragging

To move an item, select and drag it to the target position while pressing and holding the left-click button.

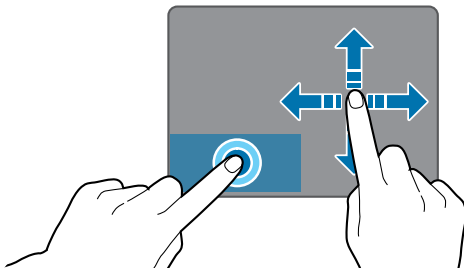

Additional Functions

Swiping

To scroll up, down, left, or right to a desired location, swipe with two fingers on the touchpad.

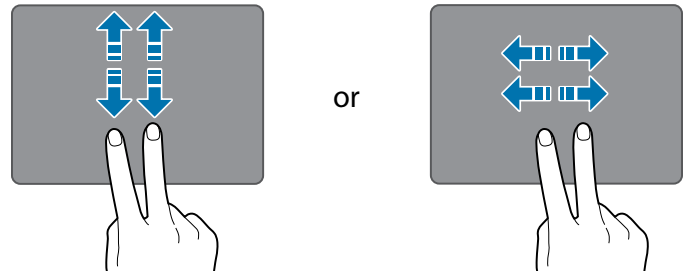

Spreading and Pinching

Spread two fingers apart on a webpage, map, or image to zoom in a part. Pinch to zoom out.

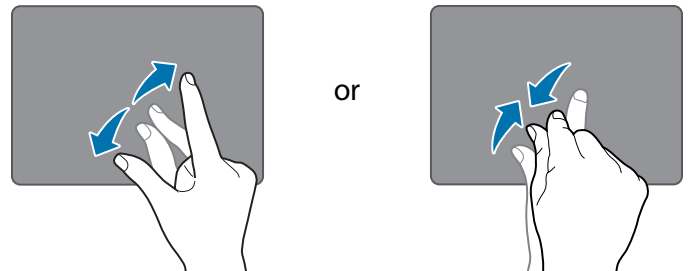

Configuring Touchpad Gestures

Configure touchpad gestures to use the touchpad more efficiently.

1. Tap **Start** > **Settings** > **Devices** > **Mouse & touchpad**.
2. Configure the settings under Touchpad.

Locking the Touchpad

- ▶ Press and hold the **Fn** key, and then press the **F5** key to lock the touchpad.

Touchscreen

Important:

- Do not allow the touchscreen to come into contact with other electrical devices. Electrostatic discharges can cause the touchscreen to malfunction.
- To avoid damaging the touchscreen, do not tap it with anything sharp or apply excessive pressure to it with your fingertips.

Note:

- The device may not recognize touch inputs close to the edges of the screen, which are outside of the touch input area.
- Leaving the touchscreen idle for extended periods may result in afterimages (screen burn-in) or ghosting. Turn off the touchscreen when you do not use the device.
- It is recommended to use fingers when you use the touchscreen.

Tap

To open an app, to select a menu item, to press an onscreen button, or to enter a character using the keyboard on the screen, tap it with your finger.

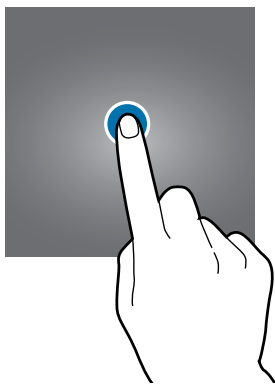

Touch and Hold

Touch and hold an item or the screen for more than 2 seconds to access available options.

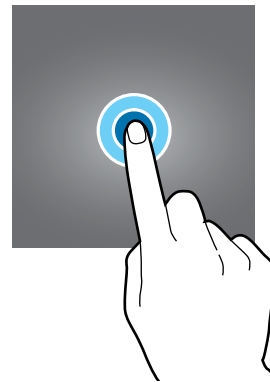

Drag

To move an item, touch and hold it and drag it to the target position.

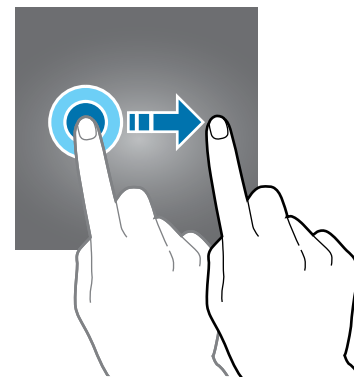

Double-Tap

Double-tap on a webpage or image to zoom in. Double-tap again to return.

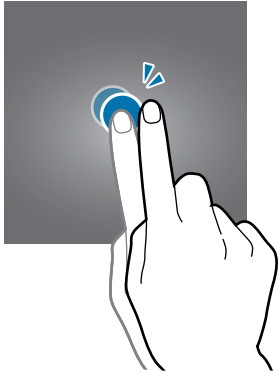

Spread and Pinch

Spread two fingers apart on a webpage, map, or image to zoom in a part. Pinch to zoom out.



or

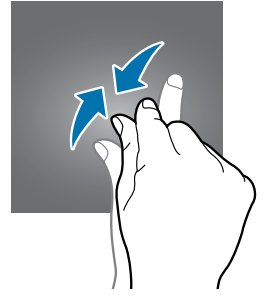

Swipe

Swipe to the left or right on the screen to scroll left or right. Swipe upwards or downwards to scroll through a webpage or a list of items.

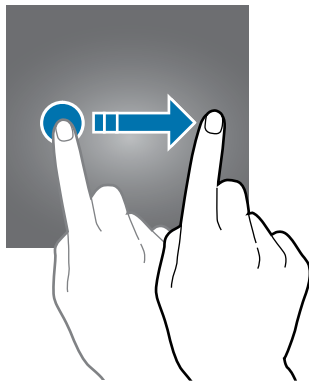

Start Screen

The Start screen is the starting point for accessing all of the device's features.

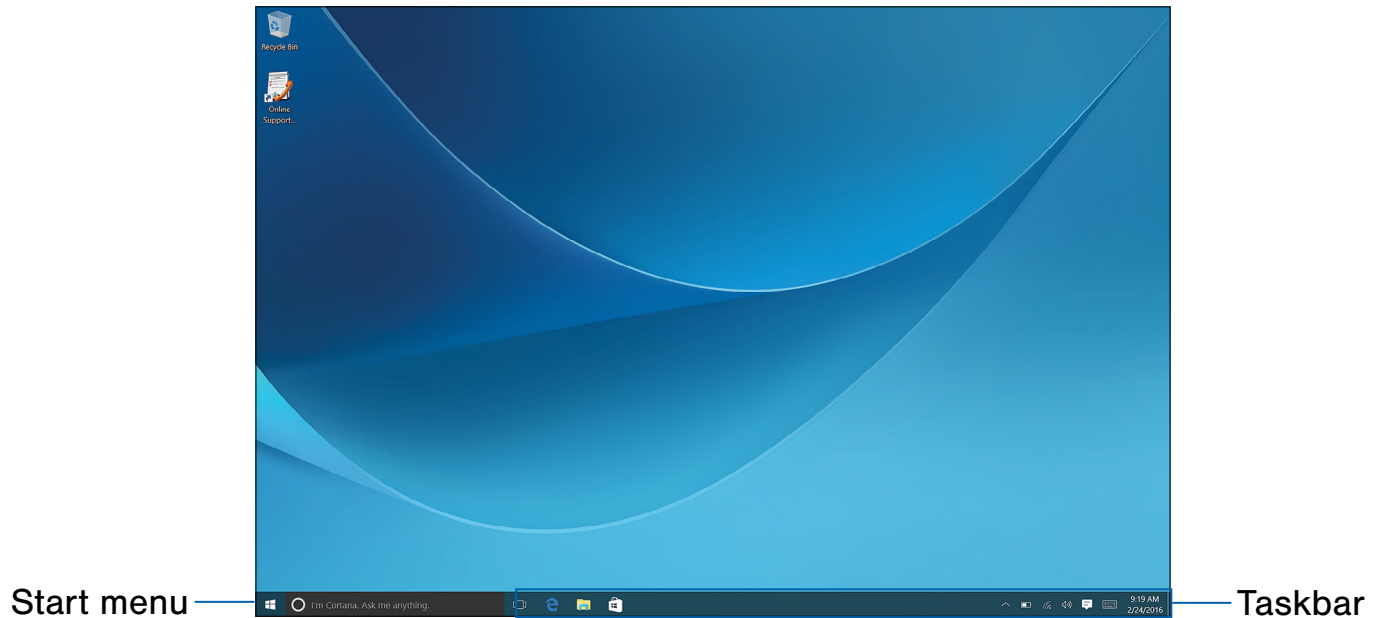

- **Taskbar:** Access system controls and notifications.
- **Start menu:** Access the Start menu and launch apps.

Moving and Removing an Item

To move an item:

- ▶ Touch and hold an item on the Start screen, and then drag it to a new location.

To remove an item:

- ▶ Touch and hold the item, and then tap **Unpin from taskbar**.

Taskbar

The bottom area of the screen is the taskbar. You can access the Start menu, launch the search box, view notification icons, and more on the taskbar.

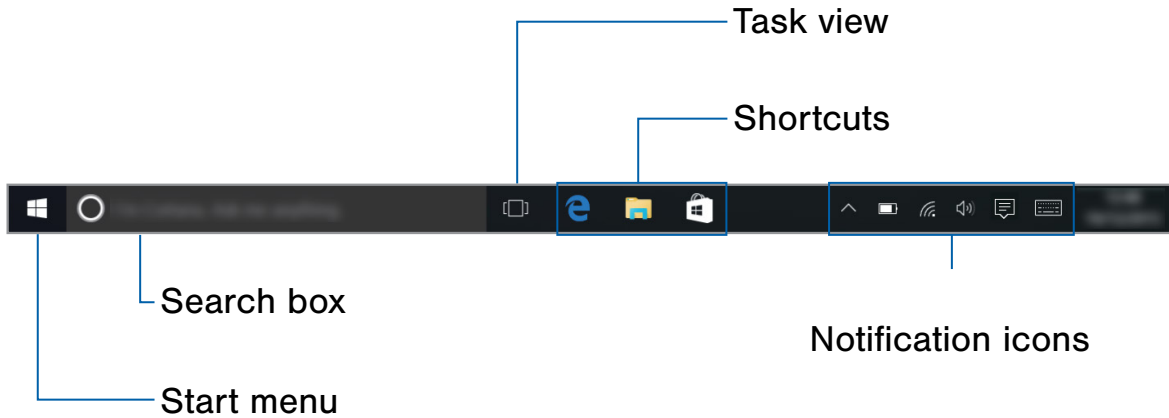

- **Task view:** View open applications as large tiles on the screen.
- **Shortcuts:** Display a running app in the foreground.
- **Notification icons:** View system notifications.
- **Search box:** Search the device using key words.
- **Start menu:** Access the Start menu and launch apps.

Managing Notification Icons

On the taskbar:

- ▶ Tap **Start > Settings > System > Notifications & actions > Select which icons appear on the taskbar**, and then select items to display in the notification area.

Managing Shortcuts

To add a shortcut:

- ▶ On the taskbar, tap **Start**, touch and hold an item, and then tap **More options > More > Pin to taskbar**.

To delete a shortcut:

- ▶ Touch and hold a shortcut, and then tap **Unpin from taskbar**.

To move a shortcut to another location:

- ▶ Drag it to a new location.

Start Menu



- **App tiles:** Apps display as tiles.
- **All apps:** Access a list of all apps on the device.
- **Power:** Tap to turn the device off or restart it.
- **Settings:** Customize your device settings.
- **File Explorer:** View frequently used files and folders.
- **Frequently used apps:** View frequently used apps.
- **Your account:** Access and customize your account.



From the Start menu, you can access frequently used apps, the **All apps** list, shortcuts to other locations on your device, and more.

On the taskbar:

- ▶ Tap  **Start** to open the Start menu.

Managing App Tiles

You can pin your favorite apps on the app tile area.

- To add more apps, tap **All apps**, touch and hold an app, and then drag it to the app tile area.
- To move a tile, touch and hold a tile, and then drag it to a new location.
- To adjust the size of a tile, touch and hold a tile, and then tap  **More options > Resize**.
- To delete a tile, touch and hold a tile, and then tap  **Unpin**.

Virtual Desktop

Virtual desktop allows you to work on various tasks simultaneously from multiple desktops. You can use different desktops for a variety of purposes.

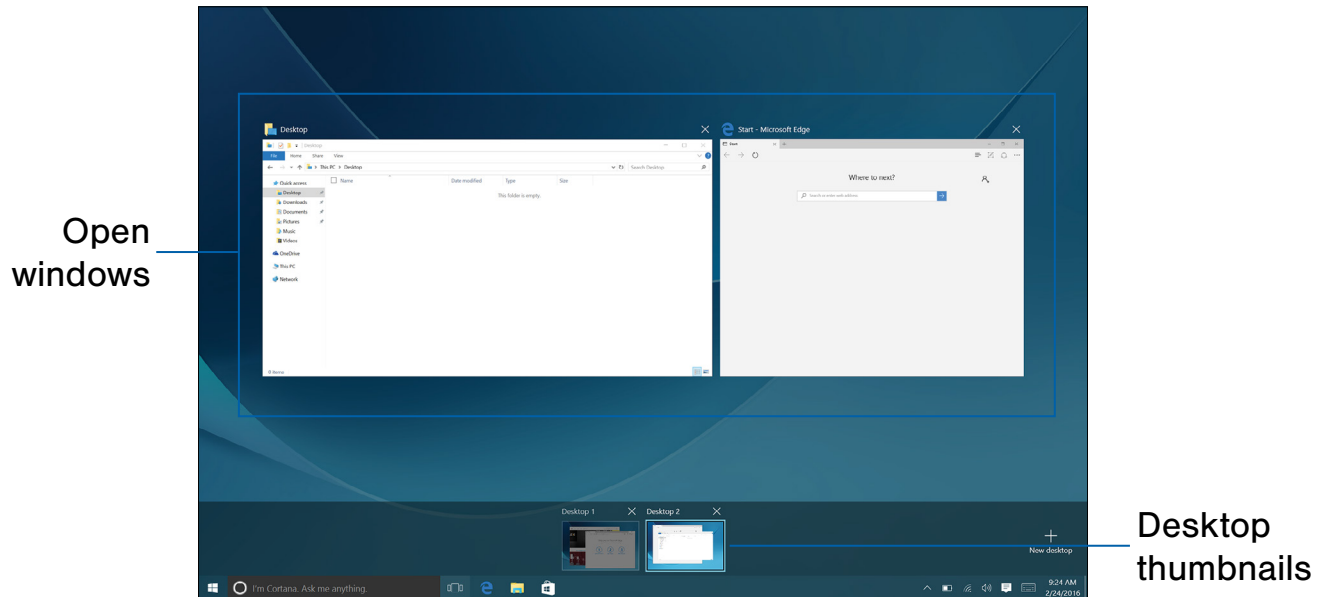

- **Desktop thumbnails:** Desktops that are available.
- **Open windows:** Currently open windows.

- ▶ On the taskbar, tap  **Task view**.
- or -
- Swipe from the left edge of the screen.

If you have added desktops, the desktop thumbnails will appear on the lower part of the screen.

- ▶ Select a thumbnail to activate the desktop.

Adding Desktops

- ▶ On the desktop thumbnails list, tap **New desktop**.

Deleting Desktops

- ▶ On the desktop thumbnails list, tap  **Delete** on a desktop.

Moving Windows to Another Desktop

1. On the desktop thumbnails list, touch and hold a thumbnail. The desktop's currently open windows appear above the thumbnails list.
2. Touch and hold a window to move, and then tap **Move to**.
3. Select a desktop to move the window.

Switching to Tablet Mode

You can switch between PC mode and tablet mode. In Tablet mode, the full Start menu screen will be the Start screen. Switching to tablet mode makes the device more touch-friendly.

To switch to tablet mode, on the taskbar:

▶ Tap  **Action center** > **Tablet mode**.

- or -

Swipe from the right edge of the screen towards the center of the screen, and then tap **Tablet mode**.

To return to PC mode:

▶ Tap **Tablet mode** again.

Lock Screen

Pressing the Power key turns off the screen and locks it. Also, the screen turns off and automatically locks if the device is not used for a specified period.

- ▶ To unlock the screen, press the **Power** key and drag the locked screen upwards.

You can change the way that you lock the screen to prevent others from accessing your personal information.

- ▶ On the taskbar, tap  **Start > Settings > Accounts > Sign-in options**, and then select a screen lock method. The device requires an unlock code whenever unlocking it.

Notes:

- If the unlock code is forgotten, take the device to a Samsung Service Center to reset it.
- You must add a password before you can use the other lock methods.

Password

Create your Microsoft account password.

- ▶ Tap **Add**, and enter a password, enter the password again to verify it, and then enter a password hint.

PIN

A PIN consists of numbers only.

- ▶ Tap **Add**, and enter a password, enter the password again to verify it, and then enter a password hint.

Picture Password

A picture password consists of circles, straight lines, and taps.

- ▶ Tap **Add**, and select an image and draw on the image to create gestures.

Pattern Log-In

To unlock the screen using a pattern, on the taskbar:

1. Tap  **Start > Settings > Extras > Galaxy Settings > Pattern Log-in**, and then tap **On/Off** to activate it.
2. Draw a pattern by connecting four dots or more, and then draw the pattern again to verify it.

Action Center

Using the Action Center

You can view new notifications from Windows and apps, and use quick action buttons. Quick action buttons allow you to easily adjust frequently used settings, such as activating Wi-Fi.

- ▶ To open the Action center panel, on the taskbar, tap  **Action center**.

- or -

Swipe from the right edge of the screen.

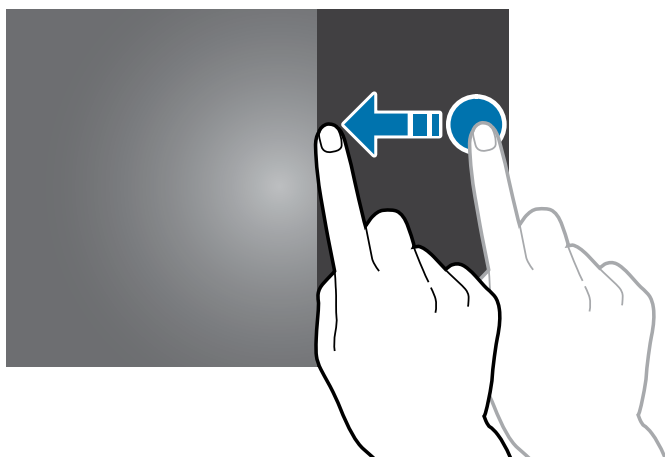

You can use the following functions on the Action center panel.

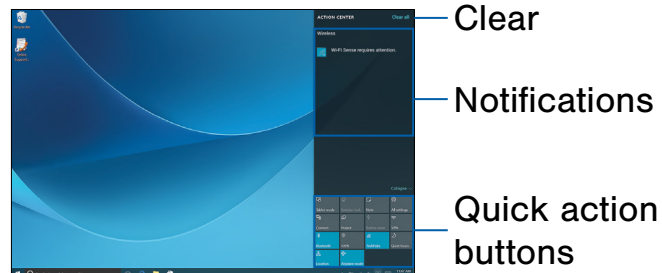

- **Clear:** Clear all notifications.
- **Notifications:** Tap a notification and perform various actions.
- **Quick action buttons:** Access common settings quickly from the Action center.

Using Quick Action Buttons

Tap quick action buttons to activate certain features.

To view more detailed settings:

- ▶ Touch and hold a button, and then tap **Go to settings**.

To change the top four buttons:

- ▶ On the taskbar, tap  **Start** > **Settings** > **System** > **Notifications & actions**, and then change quick actions under Choose your quick actions.

Search Box

Search for a wide variety of content on the device or web with a keyword.

- ▶ Tap the **search box** on the taskbar and enter a keyword in the search field.
 - To search for files, apps, settings, and more on your device and your OneDrive, tap **My stuff**.
 - To search for apps, images, topics and more in the Internet, tap **Web**.

Entering Text







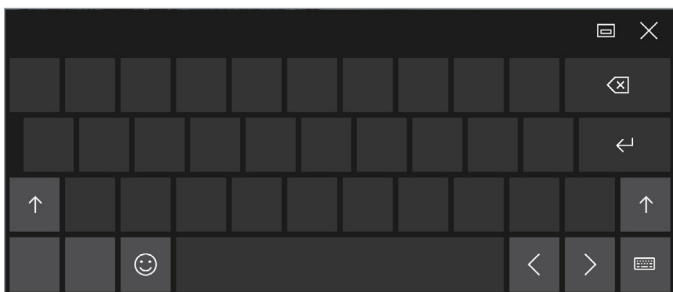

Using the Onscreen Keyboard

In tablet mode, the onscreen keyboard appears automatically when you enter text to send emails, create notes, and more.



- ▶ To use the onscreen keyboard in PC mode, on the taskbar, tap  **Keyboard**.

Note: Text entry is not supported in some languages. To enter text, you must change the input language to one of the supported languages.







Icon	Function
	Floating keyboard: Switch to the floating keyboard.
	Close: Close the keyboard.
	Return: Break to the next line.
	Keyboard options: Change the input language or the keyboard layout, or add input languages.
	Arrows: Move the cursor.
	Emoticons: Enter emoticons.
	Numbers and Punctuations: Enter numbers and punctuation marks.
	Shift: Enter uppercase. For all caps, tap it twice.
	Delete: Delete a preceding character.

Changing the Input Language

- ▶ Tap  **Keyboard** > **Language preferences** > **Add a language**, and then select a language to add.
 - When you add languages, you can select other input languages by tapping  **Keyboard**.

Additional Keyboard Functions

- ▶ Tap  **Keyboard** to use various functions.
 -  **Standard:** Switch to the standard keyboard.
 -  **Floating/Split:** Switch to the floating or split keyboard. You can move the keyboard to another location by dragging the keyboard.
 -  **Handwriting:** Switch to handwriting mode.

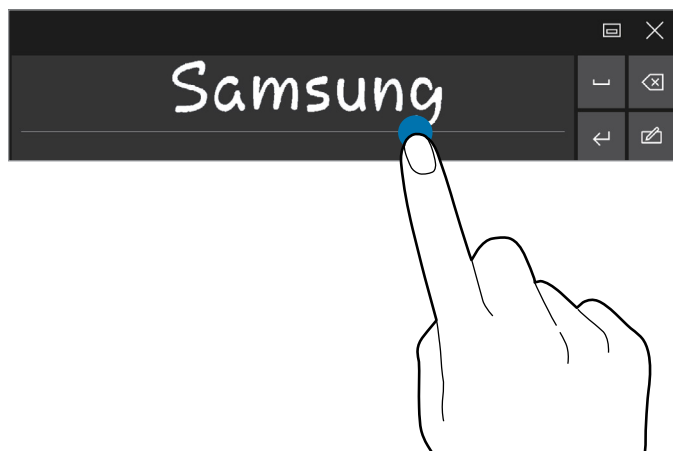

Note: This feature may not be available depending on the region or service provider.

Copying and Pasting

1. Drag your finger across text to select it.
2. Touch and hold the text to display the options.
3. Tap **Copy** or **Cut**. The selected text is copied to the clipboard.
4. Touch and hold where the text is to be inserted and tap **Paste**.

Using the Keyboard Cover

When your device is in PC mode and connected to the Keyboard Cover, you can enter text using the traditional keyboard. For more information, see [Keyboard Cover](#).

Opening Apps

To open an app:

- ▶ On the taskbar, tap  **Start > All apps**, and then select an app icon to open it.

- or -

To open an app from the task view screen, on the taskbar, tap  **Task view**, and then select a window.

To close an app:

- ▶ Tap  **Close** at the top of the app window to close it.

Split Screen View

In tablet mode, you can open two windows at the same time in the split screen view by selecting windows from the task view screen.

Note: Some apps may not support this feature.

1. On the taskbar, tap  **Task view** to view currently open apps.
- or -
Swipe from the left edge of the screen.
2. Touch and hold an app and select **Snap left** or **Snap right**.

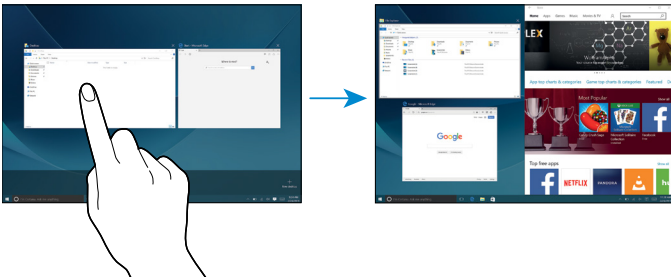

3. Select another app to launch.

Adjusting the Window Size

Drag the handle between the app windows left or right to adjust the size of the windows.

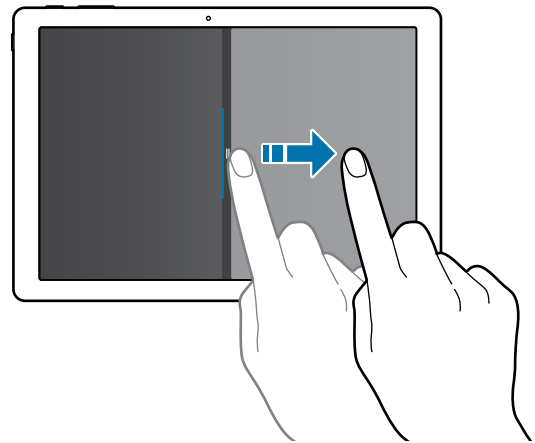

Device and Data Management

Transferring Data Between Devices

Move audio, video, image, or other types of files between your tablet and a mobile device.

Caution: Do not disconnect the USB cable from the device when you are transferring files. Doing so may cause data loss or device damage.

Note: The devices may not connect properly if they are connected via a USB hub. Directly connect devices via your device's USB charger/Accessory port.

1. Connect a mobile device to your tablet using the USB cable.
2. Transfer files between your tablet and the connected device.

Updating the Device

Keep your device up to date by downloading and installing updates, such as service packs and patches, for the operating system and other Microsoft apps.

The device is set to download and install updates automatically.

To check for available updates manually:

- ▶ On the taskbar, tap  **Start > Settings > Update & security > Windows Update > Check for updates.**

Samsung Update

Install and update Samsung apps, drivers, and more on the device easily.

- ▶ On the taskbar, tap  **Start > All apps > Samsung > Samsung Update.**
 - For more information, see [Samsung Update](#).

Backing Up and Restoring Data

Keep your personal information, app data, and settings safe on your device. You can back up your sensitive information using Samsung Recovery. For more information, see [Samsung Recovery](#).

Performing a Data Reset

Delete all settings and data on the device. Before performing a factory data reset, ensure you back up all important data stored on the device. For more information, see [Backing Up the Current System](#) and [Restoring to Factory Default](#).

Applications

Learn how to change the way apps display, use apps, and uninstall or disable apps.

Installing or Uninstalling Apps

Store

Purchase and download apps.

► On the taskbar, tap  **Store**.

- or -

On the taskbar, tap  **Start > Store**.

Notes:

- This app may not be available depending on the region or service provider.
- You can install apps provided by Samsung via Samsung Update.
- For service requests for apps provided by third-party providers, contact the provider. If you contact a Samsung Service Center, troubleshooting actions in response to service requests may have limitations depending on the app.

Installing Apps

Browse apps by category or tap the search field to search for a keyword.

- Select an app to view information about it.
- To download free apps, tap **Free**.
 - To purchase and download apps where charges apply, tap the price and follow the prompts.
 - To change the auto update settings, tap  **Your account > Settings**, and then tap the **Update apps automatically** switch to activate or deactivate it.

Uninstalling Apps





Note: Some apps cannot be uninstalled.

1. On the taskbar, tap  **Store > All apps**.
2. Touch and hold an app, and then tap **Uninstall**.
 - Some apps will automatically move to the Uninstall or change a program screen.
 - Touch and hold an app, tap **Uninstall** or **Uninstall/Change**, and then follow the prompts to uninstall the app.
3. Tap **Uninstall**.

Scrap Box





Capture a screenshot while using the device. You can share or edit captured images, view them as a slideshow, and more.

Capturing Screenshots

1. When there is content you want to capture, on the taskbar, tap  **Start** > **All apps** > **Scrap Box**.
2. Tap  **Capture**.
3. Drag a  **Circle** to resize the selection, and then tap **Done**.
 - To auto fit the frame around the content you want, tap **Auto-fit**.
 - To exit the selection, tap **Cancel**.
4. Use tools to edit the image and tap  **Save** to save it.

Managing Captured Images

On the Scrap Box screen, you can share images, upload them to OneDrive, or delete them.

1. Tap  **List** to view a list of the images you have saved.
2. Tap images, and then use the following options:
 -  **Share**: Share the images with others.
 -  **Upload**: Upload the images to OneDrive.
 -  **Delete**: Delete the images.

SideSync

Introduction

SideSync allows you to easily share your screen and data between Samsung Android smartphone and tablet. After you connect your devices, a virtual screen will appear on your tablet. You can check notifications, such as messages, from the dashboard or in pop-up windows.



Before You Start

The SideSync app must be installed on both devices that you want to connect.

- If SideSync is not installed, use one of the following methods to download and install it:
 - To download and install SideSync on your Samsung Android tablet or smartphone, search for SideSync in Galaxy Apps or Play Store. If your device does not support SideSync, you may not be able to find the app.
 - To download and install SideSync on your device, visit www.samsung.com/sidesync. On the webpage, you can also find the information about SideSync system requirements.
- To connect your smartphone and tablet, they must support Wi-Fi Direct.
- To wirelessly connect your smartphone and tablet, they must be connected to the same wireless access point.

Connecting to Smartphones

Connecting to a Smartphone via Wi-Fi Direct

1. Launch SideSync on both your tablet and smartphone.
2. Tap **Start** on both devices.
 - Both devices will scan each other and connect.
3. On your tablet, select your smartphone from the detected devices list.
4. On the smartphone, accept the connection request.
 - The dashboard will appear on your tablet.



Connecting Devices Automatically

If two devices have been previously connected, you can set them to reconnect automatically.

1. On the dashboard, tap **SideSync > More > Settings > Automatically Stat & Connect**.
2. Tap **Automatically connect to the device which has been connected before** to activate the auto connection feature.

Using the Dashboard

Launch frequently used apps or view notifications from your smartphone.

When you tap a notification, the related app or program will launch. The following is an image of the smartphone's dashboard on your tablet.

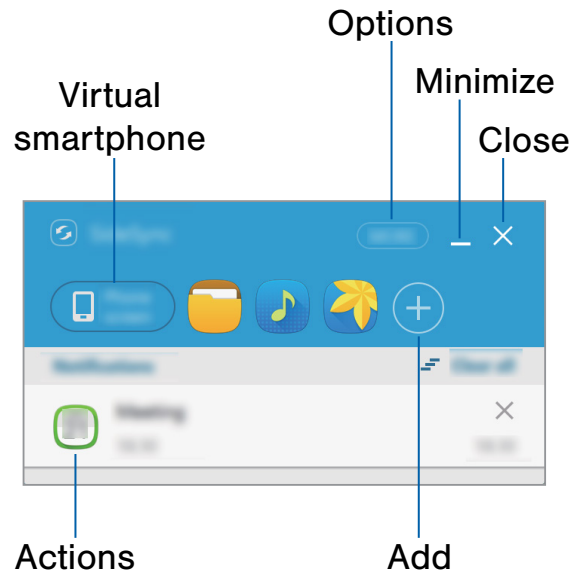

- **Options:** Access additional options.
- **Minimize:** Minimize the dashboard.
- **Close:** Close the dashboard.
- **Add:** Add more apps.
- **Actions:** Tap a notification and perform various actions.
- **Virtual smartphone:** Turn on the virtual smartphone screen.

You can rearrange or delete apps when you touch and hold an app icon.

Continuing Media Playback

You can pause music or videos on the connected device and continue playback on your tablet.

- ▶ On the dashboard, select the play button on the music controller or a video notification.
 - Playback will pause on your other device and start playing on your tablet.

Note: The connected device's music controller and a video notification will appear only when you play media files via the default music or video app.

Sharing a Webpage

You can open a webpage on the connected device and display it in the web browser of your tablet.

While browsing webpages on the connected device, a web access notification will appear on the dashboard.

- ▶ On the dashboard, select the notification.
 - The same webpage will appear on your tablet.

Using the Virtual Screen

SideSync mirrors a device's screen on another device. You can use a device's functions via the virtual screen.

- ▶ On the dashboard, tap **Phone screen**.

Notes:

- Some functions may not work through the virtual screen.
- The appearance and functions of the virtual screen may vary depending on the connected device.

The following is an image of the virtual smartphone screen on your tablet:



- ▶ Tap  **Options** to use the following options:
 - **Always on top:** Set the virtual screen to always stay on top.
 - **Rotate:** Rotate the screen.
 - **Window transparency:** Adjust the transparency level of the virtual screen.
 - **Capture:** Capture a screenshot.
 - **Enable Presentation mode:** Turn on the smartphone's screen to control it from both your tablet and smartphone. This feature may not be available depending on the connected device.
 - **Add to Favorites:** Add the current app to the dashboard.

To move the virtual screen:

- ▶ Tap and drag the top of the virtual screen to a new location.

To adjust the size of the virtual screen:

- ▶ Tap and drag the edge of the virtual screen.

Switching Between Screens

- ▶ To use your smartphone's actual screen, press the Power key on your smartphone.
 - The virtual screen turns off and the smartphone's screen turns on.
- ▶ To return to the virtual screen, tap the virtual smartphone screen on the tablet.
 - The actual screen turns off and the virtual screen turns on.

Note: You can view and control the virtual screen and the connected device's screen simultaneously. On the virtual screen, tap  **Options > Enable Presentation mode** to turn on the connected device's screen. This feature may not be available depending on the connected device.

Sharing Files and Clipboard

Copying files to your tablet

1. Tap **More > Edit** to enter edit mode on the virtual smartphone screen.
2. Tap files to copy.
3. Touch and hold the selected files, and then drag and drop them outside of the virtual screen.
 - The files will be copied to the intended location.

For example, when you move an image from your smartphone to an open Word document on your tablet, the image will be inserted into the Word document.

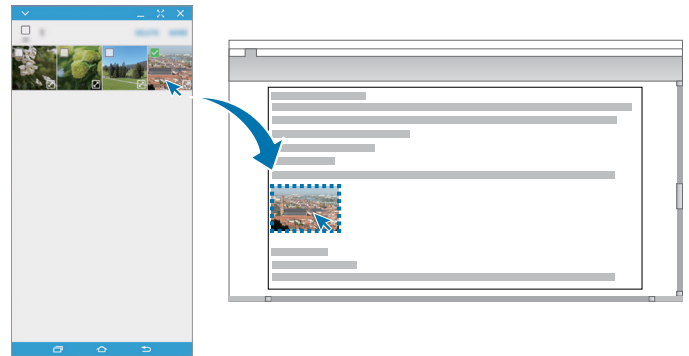

Copying Files to the Smartphone

- ▶ Select files on the tablet and drag them to the dashboard or the virtual smartphone screen.
 - The files will be saved in the SideSync folder.
 - While composing a message or an email on the virtual screen, the copied files will be attached to the message or email being composed.

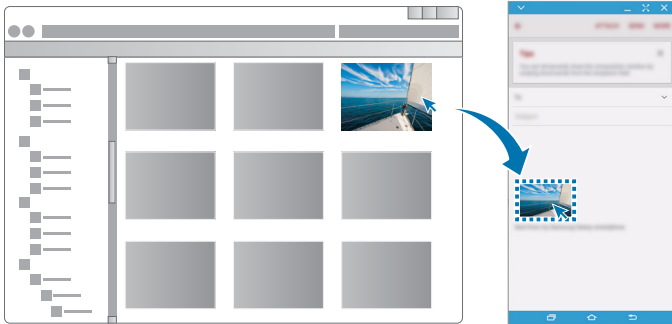

Note: When the smartphone's virtual screen and actual screen are turned on, you cannot share files.

Sharing Clipboard

You can conveniently copy and paste text between the connected devices via the clipboard sharing feature. Copy or cut text from the virtual screen and paste it into a text field outside of the virtual screen, or vice versa.

Sharing the Tablet's Keyboard and Touchpad

Use the smartphone's screen as a dual monitor and control it with your tablet's keyboard and touchpad.

1. On the dashboard, tap **More > Enable Keyboard and mouse sharing**.
 - If the virtual screen is open, it will disappear from your tablet's screen.
2. Move your finger to the left or right edge on your tablet's touchpad to move the cursor to your smartphone's screen.
 - The cursor will appear on your smartphone's screen.

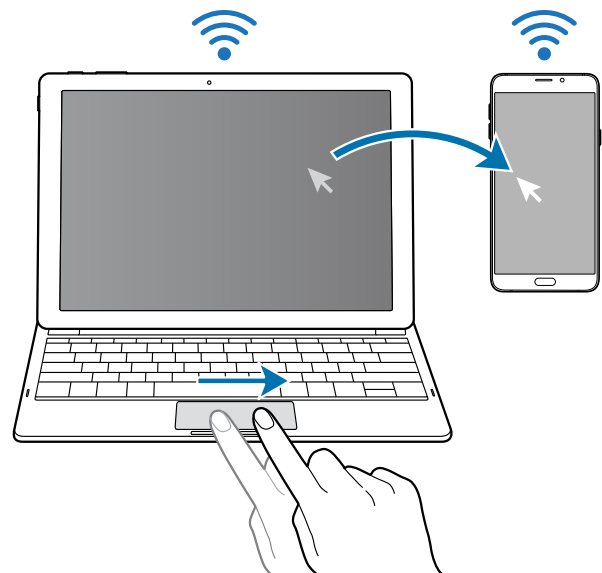

3. On the smartphone, use your tablet's keyboard and touchpad to perform actions, such as entering text, copying and pasting, and selecting items.
4. To control the tablet with the touchpad again, return the pointer to the tablet's screen.

Samsung Update

Install and update Samsung apps, drivers, and more on the device.

1. On the taskbar, tap  **Start > All apps > Samsung > Samsung Update.**
2. Tap **Find Model** to find your device.
- or -
Tap the **Search** field at the top of the screen and enter your model name.
3. Tap your model name and tap your device's OS version.
4. Select items to update and tap **Save**.

Samsung Recovery

Introduction

Back up your data and settings, and restore your device to a previously backed up point or to the factory default.

Note:

- To use this app, you must sign in to the device with an administrator account, or enter the administrator's password.
- When you restore your device, it will erase the data or apps saved after the selected backup point. Ensure you back up important data regularly.

Backing Up the Current System

Back up important data to an external storage device regularly to prevent restore.

1. Connect an external storage device.
2. On the taskbar, tap  **Start > All apps > Samsung > Samsung Recovery**.
3. Tap **Backup Management > New backup**.
4. Enter backup information and select the external storage device.
5. Tap **Recover**.
6. When the backup start window appears, tap **OK**.
7. When the backup complete window appears, tap **OK**.
 - When the backup is finished, the backup image will appear on the backup management screen.

Restoring the System

Restoring to Factory Default

Restore the device to its factory default settings. Before performing a factory data reset, ensure you back up all important data stored on the device.

- ▶ On the taskbar, tap  **Start > All apps > Samsung > Samsung Recovery > Factory image > Recover > Recover > OK**.

Restoring to a Backup Point

Select a backup point saved on an external storage device to restore the device to that point.

1. Connect the external storage device to your device.
2. On the taskbar, tap  **Start > All apps > Samsung > Samsung Recovery**.
3. Tap **Backup Management**, select a backup image, and then tap **Recover**.
4. Tap **Recover**.

Online Support (S Services)

This service allows you to chat with a technical engineer via the Internet and resolve problems on your device remotely.

This service may be limited after the expiration date.

1. On the taskbar, tap  **Start > All apps > Samsung > Online Support (S Service)**.
2. Tap **Online Support**.
3. Enter a question and tap **Request**.

Settings

Configure your device's connections and settings, add accounts, and customize Home screens, apps, and features.

Introduction

Customize settings for functions and apps. You can make your device more personalized by configuring various setting options.

- ▶ On the taskbar, tap  **Start** > **Settings**.
 - To search for settings by entering keywords, tap the **Search** field at the top of the screen.

System

Change the system settings.

- ▶ On the Settings screen, tap **System**:
 - **Display**: Change the display settings, such as the font size and the brightness of the display.
 - **Notifications & actions**: Select Quick action buttons to display on the action center panel and change the notification settings.
 - **Apps & features**: View and manage apps and features on the device.
 - **Multitasking**: Change settings for multitasking.
 - **Tablet mode**: Switch to tablet mode and change the related settings.
 - **Battery saver**: View battery power information and change the power saving options.
 - **Power & sleep**: Set the device's backlight timer. You can also set the Wi-Fi settings for when the device is in sleep mode.
 - **Storage**: View memory information for your device and select where new apps and data are saved by default.
 - The actual available capacity of the internal memory is less than the specified capacity because the operating system and default apps occupy part of the memory. The available capacity may change when you update the device.
 - **Offline maps**: Download maps to search for places and get directions offline and change settings for offline maps.
 - **Default apps**: Select a default setting for using apps.
 - **About**: Access device information and change the device name or other settings.

Devices

Change settings related to your connected devices.

- ▶ On the Settings screen, tap **Devices**:
 - **Printers & scanners**: Change setting to connect printers and scanners.
 - **Connected devices**: Add devices and change settings for metered connections.
 - **Bluetooth**: Activate or deactivate the Bluetooth feature. You can search for other Bluetooth devices and pair with them.
 - Samsung is not responsible for the loss, interception, or misuse of data sent or received via Bluetooth.
 - Always ensure that you share and receive data with devices that are trusted and properly secured. If there are obstacles between the devices, the operating distance may be reduced.
 - Some devices, especially those that are not tested or approved by the Bluetooth SIG, may be incompatible with your device.
 - Do not use the Bluetooth feature for illegal purposes (for example, pirating copies of files or illegally tapping communications for commercial purposes).
 - Samsung is not responsible for the repercussion of illegal use of the Bluetooth feature.
 - **Mouse & touchpad**: Change the mouse and touchpad settings.
 - **Typing**: Change the onscreen keyboard settings.
 - **AutoPlay**: Activate or deactivate the AutoPlay feature and change related settings.
 - **USB**: Set the device to notify you if there are issues when connecting to USB devices.

Network and Internet

Change the network and Internet settings.

- ▶ On the Settings screen, tap **Network & Internet**:
 - **Wi-Fi**: Activate the Wi-Fi feature to connect to a Wi-Fi network and change the related settings.
 - Turn off Wi-Fi to save the battery when not in use.
 - **Airplane mode**: Activate or deactivate Airplane mode. This disables all wireless functions on your device. You can use only non-network services.

Important: Make sure the device is turned off during takeoff and landing. After takeoff, you can use the device in Airplane mode if allowed by aircraft personnel.
 - **Data usage**: Keep track of your data usage amount.
 - **VPN**: Set up and connect to virtual private networks (VPNs).
 - **Dial-up**: Configure the dial-up settings.
 - **Proxy**: Configure the proxy settings.

Personalization

Change the display settings, such as a wallpaper, color, and theme.

- ▶ On the Settings screen, tap **Personalization**:
 - **Background**: Change the wallpaper and related settings.
 - **Colors**: Change the colors of the taskbar, items on the Start menu, and more.
 - **Lock screen**: Change the locked screen wallpaper and select items to show on the locked screen.
 - **Themes**: Select a theme to apply and change related settings.
 - **Start**: Change the settings related to the Start menu.

Accounts

Change the account settings.

- ▶ On the Settings screen, tap **Accounts**:
 - **Your email and accounts**: Add your Microsoft account and manage your other accounts.
 - **Sign-in options**: Change the device sign-in options. You can select a screen lock method to prevent others from accessing your personal information.
 - **Work access**: Add a work or school account to access to your organization's resources, such as apps and network.
 - **Family & other users**: Add additional accounts for your family members or other users to use the device with their own personalized settings.
 - **Sync your settings**: Change settings to sync your settings with other devices using your Microsoft account.

Time and Language

Change settings to control how the device displays the time and date, and select your country or region.

Note: If the battery remains fully discharged or is removed from the device, the time and date resets.

► On the Settings screen, tap **Time & language**:

- **Date & time:** Change the time and date settings.
- **Region & language:** Set your country or region, and add your display languages.
- **Speech:** Change the settings for the text-to-speech feature.

Ease of Access

Change settings to improve the device's accessibility.

- ▶ On the Settings screen, tap **Ease of Access**:
 - **Narrator**: Activate the screen reader and change the related settings. When you activate this feature, the device reads aloud all the elements on the screen, such as text and buttons.
 - **Magnifier**: Activate a magnifier and change the related settings. When you activate this feature you can zoom in on the screen to view a larger version of the content.
 - **High contrast**: Apply high contrast themes to the display to improve screen visibility.
 - **Closed captions**: Change the caption settings.
 - **Keyboard**: Change the onscreen keyboard settings.
 - **Mouse**: Change the pointer and mouse settings.
 - **Other options**: Change the additional accessibility settings.

Privacy

Change the privacy settings.

► On the Settings screen, tap **Privacy**:

- **General**: Change the general privacy settings.
- **Location**: Change settings for location information permissions.
- **Camera**: Activate or deactivate the camera feature. Select apps to allow them to use the camera feature.
- **Microphone**: Activate or deactivate the microphones. Select apps to allow them to use the microphones.
- **Speech, inking, & typing**: Set the device to collect personal information, such as contacts and recent calendar events. You can also manage your cloud settings.
- **Account info**: Set apps to access and use your account information.
- **Contacts**: Select apps to allow them to access your contacts.
- **Calendar**: Activate or deactivate the calendar app. Select apps to allow them to access the calendar app.
- **Call history**: Select apps to allow them to access your call logs.
- **Email**: Activate or deactivate the email app. Select apps to allow them to access the email app and send emails.
- **Messaging**: Activate or deactivate the messaging app. Select apps to allow them to access the messaging app and send messages.
- **Radios**: Change the settings to allow apps to use radios, such as Bluetooth.
- **Other devices**: Change the settings for external devices, such as wireless devices or hardware.
- **Feedback & diagnostics**: Set the frequency of Windows feedback and select an option to send the device's diagnostic and usage data to Microsoft.
- **Background apps**: Select apps to run in the background.

Update and Security

Change the Windows update, data backup, and device security settings.

- ▶ On the Settings screen, tap **Update & security**:
 - **Windows Update**: Check for available updates and update Windows to the latest version.
 - **Windows Defender**: Activate the Windows Defender feature to scan for malware. You can also set the device to send security problems to Microsoft automatically.
 - **Backup**: Backup your files using the File History feature.
 - **Recovery**: Reset the device or restart it using the advanced start-up feature.
 - **Activation**: View the Windows activation information. You can change your Windows product key.
 - **Find My Device**: Activate or deactivate the Find My Device feature to help locate the device when lost or stolen. Access the Microsoft webpage to track your device's last known location and control the device.
 - **For developers**: Change the development settings.

Extras

Change additional settings provided by Samsung.

- ▶ On the Settings screen, tap **Extras** > **Galaxy Settings**:
 - **Battery Life Extender**: Set the maximum battery charge level to extend the battery life.
 - **AMOLED**: Change the screen mode and the screen brightness timer.
 - **Pattern Log-in**: Set a pattern to use it as your screen lock method.
 - **Legal information**: View legal information for your device.
 - **Samsung legal**: View the Samsung legal information.
 - **Open source license**: View the open source license announcement.
 - **About device**: Access device information.

Appendix

Troubleshooting

Before contacting a Samsung Service Center, please attempt the following solutions. Some situations may not apply to your device.

When you turn on your device or while you are using the device, it prompts you to enter one of the following codes:

- Enter your screen lock Password, PIN, Picture password, or Pattern log in to unlock the screen.

Your device displays network or service error messages.

- When you are in areas with weak signals or poor reception, you may lose reception. Move to another area and try again. While moving, error messages may appear repeatedly.
- You cannot access some options without a subscription. For more information, contact your service provider.

Your device does not turn on.

- When the battery is completely discharged, your device will not turn on. Fully charge the battery before turning on the device.

The touchscreen responds slowly or improperly.

- If you attach a screen protector or optional accessories to the touchscreen, the touchscreen may not function properly.
- If you are wearing gloves, if your hands are not clean while touching the touchscreen, or if you tap the screen with sharp objects or your fingertips, the touchscreen may malfunction.
- The touchscreen may malfunction in humid conditions or when exposed to water.
- Restart your device to clear any temporary software bugs.

- Ensure that your device software is updated to the latest version.
- If the touchscreen is scratched or damaged, visit a Samsung Service Center.

Your device freezes or has fatal errors.

Try the following solutions. If the problem is still not resolved, contact a Samsung Service Center.

- **Restarting the device:** If your device freezes or hangs, you may need to close apps or turn off the device and turn it on again.
- **Forcing restart:** If your device is frozen and unresponsive, press and hold the Power key for more than 10 seconds until the device turns off. Then, press and hold the Power key again to restart it.
 - **Resetting the device:** If the methods above do not solve your problem, perform a factory data reset.

To perform a factory data reset:

- On the taskbar, tap  **Start > All apps > Samsung > Samsung Recovery > Factory image > Recover > Recover > Ok**. Before performing the factory data reset, remember to make backup copies of all important data stored in the device.

The Internet is often disconnected.

- Ensure that you are not blocking the device's internal antenna.
- When you are in areas with weak signals or poor reception, you may lose reception. You may have connectivity problems due to issues with the service provider's base station. Move to another area and try again.
- When using the device while moving, wireless network services may be disabled due to issues with the service provider's network.

The battery icon is empty.

- Your battery is low. Charge the battery.

The battery does not charge properly (for Samsung-approved chargers).

- Ensure that the charger is connected properly.
- Visit a Samsung Service Center and have the battery replaced.

The battery depletes faster than when first purchased.

- When you expose the device or the battery to very cold or very hot temperatures, the useful charge may be reduced.
- Battery consumption increases when you use messaging features or some apps, such as games or the Internet.
- The battery is consumable and the useful charge will get shorter over time.

Your device is hot to the touch.

- When you use apps that require more power or use apps on your device for an extended period of time, your device may feel hot to the touch. This is normal and should not affect your device's lifespan or performance.
- If the device becomes too hot, do not use the device or apps for a while. If the device continues to overheat, contact a Samsung Service Center.

Photo quality is poorer than the preview.

- The quality of your photos may vary, depending on the surroundings and the photography techniques you use.
- If you take photos in dark areas, at night, or indoors, image noise may occur or images may be out of focus.

Error messages appear when opening multimedia files.

If you receive error messages or multimedia files do not play when you open them on your device, try the following:

- Free some memory by transferring files to an external storage device or deleting files from your device.
- Ensure that the music file is not Digital Rights Management (DRM)-protected. If the file is DRM-protected, ensure that you have the appropriate license or key to play the file.
- Ensure that the file formats are supported by the device. If a file format is not supported, such as DivX or AC3, install an app that supports it. To confirm the file formats that your device supports, visit www.samsung.com.
- Your device supports photos and videos captured with the device. Photos and videos captured by other devices may not work properly.
- Your device supports multimedia files that are authorized by your network service provider or providers of additional services. Some content circulated on the Internet, such as ringtones, videos, or wallpapers, may not work properly.

Another Bluetooth device is not located.

- Ensure that the Bluetooth wireless feature is activated on your device.
- Ensure that the Bluetooth wireless feature is activated on the device you wish to connect to.
- Ensure that your device and the other Bluetooth device are within the maximum Bluetooth range (10 meters).

If the tips above do not solve the problem, contact a Samsung Service Center.

Your device cannot find your current location.

- GPS signals may be obstructed in some locations, such as indoors. Set the device to use Wi-Fi or a mobile network to find your current location in these situations.

Data stored in the device has been lost.

- Always make backup copies of all important data stored in the device. Otherwise, you cannot restore data if it is corrupted or lost. Samsung is not responsible for the loss of data stored on the device.

The touchscreen does not turn on when you open the Keyboard Cover.

- Ensure that your device connects to the Keyboard Cover, and the device is in correct position using the stand of the Keyboard Cover. For more information, see [Keyboard Cover](#).

A small gap appears around the outside of the device case.

- This gap is a necessary manufacturing feature and some minor rocking or vibration of parts may occur.
- Over time, friction between parts may cause this gap to expand slightly.

Windows Recovery Function

If the Samsung Recovery app is not supported, reinstall Windows using the Windows recovery function.

Important: Reinstalling Windows will erase all apps and data on the device. Back up important apps and data to an external storage device before reinstalling Windows.

Note: After Windows is reinstalled, you can install the required Samsung apps. On the taskbar, tap  **Start** > **All apps** > **Samsung** > **Samsung Update**.

1. On the taskbar, tap  **Start** > **Settings** > **Update & security** > **Recovery**.
2. Tap **Get started**.
3. Tap **Keep my files** or **Remove everything**.

Removing the Battery

The internal battery should not be removed by any party other than samsung-authorized service centers.

Removing the battery and accessing the internal components can damage the device and void the warranty.

- For your safety, you **must not attempt** to remove the battery. If the battery is not properly removed, it may lead to damage to the battery and device, cause personal injury, and/or result in the device being unsafe.
- Samsung does not accept liability for any damage or loss (whether in contract or tort, including negligence) which may arise from failure to precisely follow these warnings and instructions, other than death or personal injury caused by Samsung's negligence.