

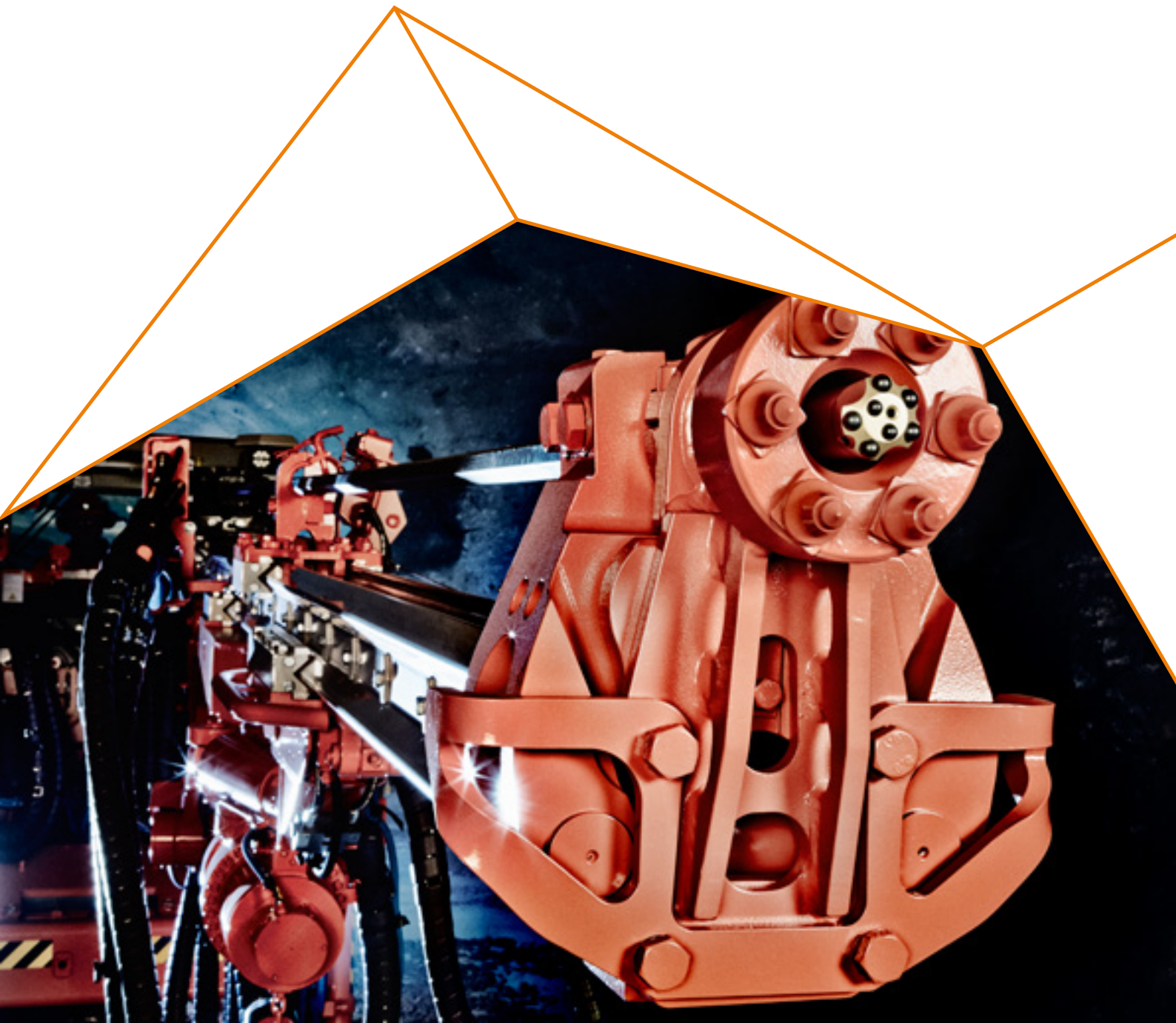

# SANDVIK TOP HAMMER ROCK DRILLING TOOLS



# PUTTING YOUR SAFETY FIRST

The mining industry continues to demand even higher levels of safety and productivity. In order to meet these requirements, we work continuously to develop even safer products, and to produce comprehensive manuals on the safe and effective use of our products.

## IT'S ALL ABOUT EVERYONE'S HEALTH

Helping you to ensure a safer workplace and healthier workforce is of the utmost importance to us. The well-being of any person coming into contact with our equipment is paramount. Therefore, we strive to identify and assess potential risk factors that could threaten the health of you and your employees.

All of the products in this catalogue are designed to meet safety requirements.

## BE AWARE OF ALL SAFETY PROCEDURES

We ask that you start by obeying all instructions given. Never work under an unsupported roof or close to potential pinch point locations. Beware of the potential hazards of a loose roof and ribs, and scale down roof and ribs prior to bolting. It is important to bolt early in the mining process – as soon as is safely and practically possible.

Safe work procedures should incorporate inspection before the machine operates, and also through regular monitoring based upon mining conditions, safety and hazard management systems. Workers should be provided with safety information, instruction and training on transportation, installation, operational care and disposal of drilling tools.

## DRESS RIGHT FROM HEAD TO TOE

You must wear appropriate personal protective equipment (PPE) at all times. This is what we strongly recommend, to help avoid injury:

- Safety helmet
- Hearing protection
- Safety glasses
- Protective high visibility clothing
- Respiratory protection
- Safety boots
- Any site-specific PPE as required

## MAKE A RISK ANALYSIS BEFORE YOU START

Pay attention to safety when planning all of your work. Before you start, always take your time to go through all operations. Identify any potential risks and take appropriate measures to avoid them. If necessary, seek expert advice on how to help minimize risks. Finally, make sure that you have the right resources to perform all tasks in the safest manner possible.

## "TAKE FIVE" TO IDENTIFY HAZARDS

A great safety tool to use before you start working is our app: "Sandvik Mining Take Five". The app consists of a simple, step-by-step checklist with five questions that you should ask yourself to identify potential hazards. The app is free to download for smartphones and tablets, both on the App Store and Google Play.









# HOW TO WORK WITH SAFETY IN MIND

## LIFTING PROCEDURES

Use the correct safe lifting practices while working with heavy items. Consider your body position, the awkwardness of the item and its weight. Are two people required for the job, or is a lifting device necessary?

## GRINDING OF BITS

Drill bits have cemented carbide buttons. Cemented carbide is made up of tungsten carbide and cobalt. Grinding buttons can produce dust and fumes containing dangerous substances that can be inhaled or swallowed, or which can come in contact with the skin or eyes. Do not breathe the dust. Wear protective gloves/protective clothing/eye protection. In case of inadequate ventilation, wear respiratory protection. In particular, avoid dry grinding. For more information see page 115.

## ASSEMBLY OF BITS

- Do not touch any equipment while it is rotating.
- Rod rotation must be stopped before the installation or removal of a drill bit.
- Follow site instructions for the isolation of rotation motors.
- Beware of pinch points between the bit and the rod.

## DRILLING WITH HANDHELD EQUIPMENT

Sandvik rock tools are designed and manufactured to the highest standards. A specific hazard exists with handheld drilling equipment, where if the drill rod breaks it can form an impalement hazard (if the broken drill steel protrudes from the hole it was drilling, while the driller is pushing towards it).





#### **DISASSEMBLY OF HOT BIT, ROD, COUPLING, SLEEVE, SHANKADAPTER AND INTEGRAL STEEL**

- Ensure that products have cooled down before disassembling.
- Never work on hot parts.
- Consider the appropriate hand protection (gloves) for the handling of warm parts.

#### **CLEANING OF RODS**

A particular hazard exists with cleaning rods if the rods contain explosives. Sandvik rock tools should never be used in a hole that has been filled with explosives.

#### **DEALING WITH WORN PARTS**

Worn parts should be removed and disposed of appropriately. Consider recycling any used drill bits. Please contact your local Sandvik Mining representative for support and further information regarding the recycling process.

#### **STORING**

All products should be stored in a dry place and in their original packaging until they are required for use.

#### **GENERAL**

The products in this catalog are designed for drilling holes in rock, and should only be used for this purpose.



Sandvik was founded in 1862 by Göran Fredrik Göransson, who was the first in the world to succeed in using the Bessemer method for steel production on an industrial scale.

# TOGETHER WE WILL TAKE YOUR BUSINESS FURTHER

For more than 150 years we have been committed to providing the highest-quality products and solutions to the mining industry. Our spirit and business ethics have remained unchanged, and developments within society and the industry have contributed to our innovative solutions.

---

**"Today, the hallmark of great work is innovation and technology. Being second best is not an option for us."**

Today, we continue to conduct business in close cooperation with you and other customers all over the world, with the promise of being a proactive and innovative partner.

We believe that we can make a difference to the successful running of your business. You need to get the best out of your equipment - with no compromise on quality, delivery time or service. With us as partners, we will create solutions that make your operation run as effectively as possible.

One thing is certain: our products and solutions will continue to meet the ever-growing needs of the mining industry, and your business.

# CONTENTS

---

HANDHELD AND SMALL HOLE DRILLING	23
FACEDRILLING AND BOLTING	35
BENCH DRILLING	51
LONG HOLE DRILLING	65
SHANK ADAPTERS	79
AUXILIARY TOOLS	95
GRINDING EQUIPMENT	99
INFORMATION AND BIT CLASSIFICATION GUIDE	115
INDEX	120
NOTES	125

---

# AT YOUR SERVICE, AROUND THE WORLD

## THE SANDVIK GROUP

Sandvik was established in 1862: today, it is a global industrial group with advanced products and world-leading positions in selected areas. In 2013, we had about 47,000 employees and sales of just over 87 billion SEK in more than 130 countries. Our operations are based on unique expertise in materials technology, and significant insight into customer processes. This combination has provided us with a world-leading position in three primary areas:

- Tools for metal cutting in cemented carbide and high-speed steel, as well as components in cemented carbide and other hard materials.
- Rock tools and equipment for the mining and construction industries.
- Products in advanced stainless materials, special alloys, metallic and ceramic resistance materials and process systems.

---

“We are a leading global supplier of rock tools and equipment, service and technical solutions for the mining industry. Our offering covers rock drilling, rock cutting, rock crushing, loading and hauling, and handling of materials.”

Our goal is to actively contribute to improving your productivity and, consequently, your profitability. Our products and services provide maximum value to you in terms of performance, quality, speed, safety, flexibility and – not least – total economy. Successful development is a result of our goal-oriented investment in research,

development and quality assurance. We invest over 3 billion SEK annually and have more than 2,700 employees working in these areas. Many of them are specialists with advanced educational backgrounds and skills.

Our long-term and consistent strategy is based on the interaction between a number of strength factors. This includes advanced and customer focused research and development activities, highly value-added products, integrated manufacturing, direct sales to customers, effective logistics systems, financial strength and a strong corporate culture. Additionally, the significance of Sandvik as an advanced knowledge company is becoming increasingly apparent. Information technology is concentrated upon areas that enhance customer benefits, improve productivity and strengthen profitability.

## SANDVIK MINING

We are a leading global supplier of rock tools and equipment, service, and technical solutions for the mining industry. Our offering covers rock drilling, rock cutting, rock crushing, loading and hauling and handling of materials. Additionally, we offer a complete assortment of rock drilling tools. In fact, we are the only producer of rock drilling tools with in-house steel and cemented carbide research, development and production facilities.

## OUR ORGANIZATION

Every product is preceded by extensive research and development, and backed with application expertise; a worldwide service network, offering on-site service, training and round-the-clock support. We have a tradition of localization and a conviction that there can be no substitute for direct service and direct contact with you. Our service-oriented, global organization is well developed and contains more than 3,500 service technicians located strategically around the world.





*Our worldwide business activities are conducted via representation in more than 130 countries.*



# WHICH INVENTION CAN SOLVE YOUR NEEDS?

We invest over 3 billion SEK each year in research and development: more than 2,700 of our employees are employed in this area. We have 8,000 active patents.

Through close customer collaboration, we develop products that are genuinely needed. We also study trends to ascertain what customer needs will be in the future. We are continuously working on unique solutions that help our customers to improve their productivity and safety.

A spirit of innovation and high involvement runs through every product. It is preceded by our extensive research and development. This is supported by a worldwide service network offering on-site service, training and round-the-clock support. We have technical service specialists strategically located around the world to provide help quickly – whenever you need it.

---

“The spirit of innovation and involvement runs through every product.”

Our focus and continuous development gives you the latest technical solutions for the most demanding rock conditions, and for the most powerful rock tools. Our products undergo extensive laboratory studies and are mercilessly tested in the field. Finally, they are all evaluated and refined to provide the highest grade of equipment quality - something that characterizes all our products.





# RECYCLING THAT PAYS OFF FOR YOU

**Environmental considerations are crucial in all of our operations, and never more so than when it comes to the recycling of cemented carbide.**

The global shortage of raw material has inspired us to create an extensive scrap-recycling program. We recognize today's increasing environmental concerns, and we are the only mining company that recycles both steel and cemented carbide.

In fact, we have been collecting and recycling both scrap and discarded drilling consumables for conversion back into basic raw materials for almost 10 years. A large number of customers have joined our recycling program during this period. One major reason for this is that we make it easy for them to recycle, by collecting scrap from their own premises.

All of our customer service centres are now set up to receive used cemented carbide-enhanced products. Our recycling plant in Chiplun, India complies with the most stringent environmental standards, and is certified to the ISO 14001 and OHSAS 18001 (ISO 45001) international standard.

## **WHAT WE OFFER:**

- Recycling of cemented carbide for customers worldwide
- Genuine recycling
- Cost recovery and reduced waste disposal for you
- Money received for worn tools can purchase new inserts or finance new tooling projects
- Consumables and tools from all manufacturers are accepted
- A win-win situation for all

Adopting sustainable business practices and handling them in the right way is a foundation that contributes across the entire business value chain.

The whole supply chain will be improved by incorporating recycling into the business process. For instance, our recycling process significantly reduces energy consumption to increase productivity, enhance business opportunities and cause less environmental damage.



# GIVING YOU STRENGTH

## NEW GENERATION OF CEMENTED CARBIDE

We develop our own production processes. This strengthens our technical capabilities to continually create even sharper tools that give you the strength to successfully master the toughest of challenges.

Research, development and production of key materials, such as cemented carbide, is an important part of our business.

An extensive programme of research has resulted in a new generation of carbide grades. These have a significantly stronger carbide matrix, and a perfect grain size configuration: meaning superior toughness and a high wear temperature resistance.

## THE TOUGH GRADE XT48 BIT

Through our new manufacturing techniques, we have created the new XT48 cemented carbide – just one example of our new generations of cemented carbide grades. The XT48 has increased density and a more homogenous structure. Consequently, it has led to the development of larger, stronger, and more stable and efficient tools.

Some characteristics of the XT48 BIT:

- Optimized cutting structure
- Ballistic or super spherical buttons
- Deep flushing grooves, with optimal positioning
- Optimized wing/head design

The gauge buttons of a drill bit are exposed to axial forces. Our former cemented carbides have always been able to handle that type of load with minimal risk of breakage.



When the bit wears, the load angle changes and the risk for button breakage increases. The new XT48 cemented carbide displays significantly higher levels of resistance to that type of failure.



## OWN, UNIQUE STEEL PRODUCTION

Our rolling mill for hollow drill steel is the most up- to-date in the world. The unique, fully automated mill is specially designed for manufacturing of this steel product. After rolling, the rods are turned to avoid decarburisation in the final rolling process. A long, straight centre hole is drilled

in the drill steel blank and a core is inserted. The blanks are hot-rolled into a round or hexagon-shape. Finally, a carefully controlled cooling process after rolling guarantees uniform mechanical properties. The core is then removed and the drill steel is ready for shipping.

# DRILL BITS THAT CAN HANDLE ANY SITUATION

The Sandvik GT60 bits are created in our unique engineering and manufacturing facility. As a result of this, we can tailor the characteristics of the bits to match almost any drilling conditions that we might face.

## SIX MAIN BENEFITS OF THE GT60:

1.

The steel in Sandvik GT60 rods is produced in one of the world's most advanced continuous casting plants. Almost 90 years of experience in rolling hollow bar steel means that we are uniquely able to produce steel with close tolerances and excellent material properties.

2.

The Sandvik GT60 system includes Sandvik button bits, to comply with all kinds of rock formations and drilling site conditions.

3.

The Sandvik GT60 system provides double the penetration rate and consumes half the energy of DTH drilling.

4.

The  $\varnothing$  60 mm rod cross-section is optimized for the high energy transfer of impact power in top hammer drilling of  $\varnothing$  92 to 152 mm holes. Compared with 51 mm rods, the 40% larger cross-section and 65% higher bending stiffness permit faster penetration rates and straighter holes.

5.

Sandvik GT60 is perfectly suited to automatic rod handling systems. Male and female (MF) threads minimize energy losses and simplify handling.

6.

Large flushing holes provide superior removal of cuttings and improve drilling performance. The exact centering of the hole during manufacture ensures uniform steel walls and consistent product performance.





# LESS HANDLING, MORE WORK

## HIGHER PRODUCTIVITY

Each +Range rod offers more meters drilled. Fewer rod changes ensures more time for drilling and less time spent replacing. The increased equipment utilization results in improved uptime of the drill rig, while reducing the overall cost of your drilling operation per blast hole.

## SUBSTANTIAL COST SAVINGS

An extended service life of 30% or more provides you with a lower cost per meter drilled. Since each drill rod offers more meters of use, fewer rods need to be kept in stock – and since fewer rods need to be handled, the associated cost is also reduced.

## REDUCED ENVIRONMENTAL IMPACT

Each rod's longer service life allows you to drill more per kilo of steel. Carbon footprints decrease from rock drill steel production to shipping and transportation on site, as well as after use. There is also a reduction in the total number of kilos of steel that need to be recycled.



## +RANGE ON LOCATION



**Customer:** High Point Opencast Mining Service

**Country:** South Africa

**Previous solution:** Sandvik GT60 standard

**New solution:** Sandvik GT60+

**Results:** High Point averages between 30 and 35 percent more service life with the new rods, resulting in a production increase of 10 to 15 percent.

**Quote:** "When we tested the GT60+ rods, we put the new ones on one machine and the old type on another machine. They were drilling next to each other so we could compare apples with apples, and that's how we discovered that with some of the best rods we got 13,800 metres out of the new GT60+ rods. That's more than double the average."

– Johan Coetzee, managing director of High Point Opencast Mining Service

**Customer:** Diesel Power Opencast Mining

**Country:** South Africa

**Previous solution:** Sandvik GT60 standard

**New solution:** Sandvik GT60+

**Results:** In two months of testing the new rods, Diesel Power has achieved major fuel savings, among other benefits, improving the contractor's carbon footprint.

**Quote:** "We haven't had breakages, and we have better threads. When we started using the +Range, our meters picked up. On a GT60+ drill rod we achieved as much as 24,907 metres. We drilled on a whole string of drill steel for that month."

– Erick Walker, senior drill and blast foreman at Diesel Power



# PROCESSES INVOLVED IN MAKING RODS

## CARBURISATION

- Case hardening in a furnace with carbon rich gas
- Increased carbon content in the outer layer hardens material

## INDUCTION SURFACE HARDENING (HF) + THREADS

- Hard, wear-resistant surface
- Improved fatigue strength
- Induction hardening of threads
- Rapidly heated and cooled



## SANDVIK ALPHA FEATURES AN ENTIRELY NEW THREAD DESIGN

The benefits of short threads on hexagonal drill rods include superior resistance to bending stresses, improved bit guidance and outstanding energy transfer. The sturdy thread is well supported inside the bit skirt, resulting in high precision collaring – even in complex rock formations and against uneven surfaces.



## MF-DESIGN GIVES STRAIGHTER HOLES

Male-Female (MF) drill rods provide a more rigid drill string than ones which use extension rods and couplings. This is due to a 50% reduction in thread play of the MF rod connections vs. coupling connections. Drilling with a stiffer drill string results in improved hole straightness, improved efficiency, and improved safety.

---

"If button failure is a problem in your rock formation, then you are certain to see an increase in bit life with Sandvik rock tools."



## HIGHER PENETRATION RATES, LOWER ENERGY CONSUMPTION

Great versatility, higher penetration rates, straighter holes, longer bit life and lower energy consumption. That's what you can expect from the Sandvik bits: an exceptionally versatile series of threaded button-bits ranging from 28 to 152 mm in diameter. The buttons

are made from proprietary grades of cemented carbide: Sandvik supplies all of the most useful and effective button shapes (spherical, conical or ballistic) and the required skirt designs (regular or retrac) in order to obtain the best bit for the rock formation in question.

---

## TWICE AS LONG SERVICE LIFE

The management at an Australian mine welcomed the news of higher productivity and lower costs. Sandvik Alpha drill bits give almost double the service life compared to drill bits used previously, which were notorious for button breakages. In a large-scale test, stoppages were down and productivity up: meanwhile, bit costs were cut by half.

## IMPROVED PERFORMANCE

In tests, Sandvik Alpha bits exceeded the mine average by 25% in Canada. This figure includes bit damage during uncoupling, but after corrections in procedures the bit performed at more than 50% above the mine's average when used on very hard and abrasive rock. The new bits could also be reground 5–7 times, compared to 3–4 as with the old standard.

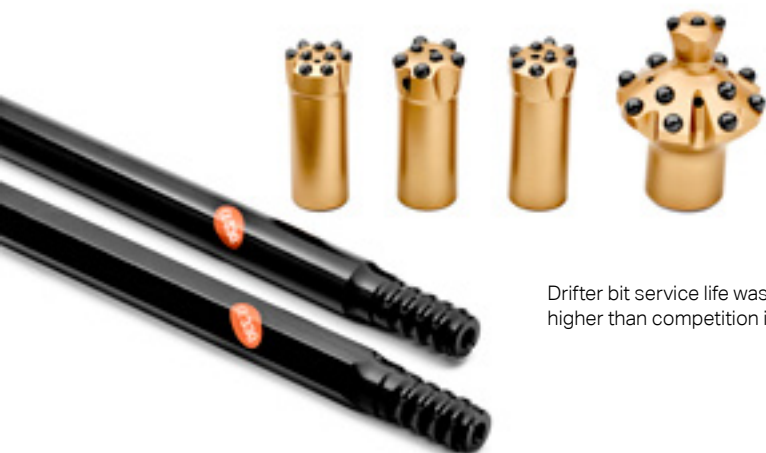

Drifter bit service life was proven to be at least 20% higher than competition in a Swedish mine.



# HOW TO TAKE CARE OF YOUR THREADS

## LUBRICATION

Thread grease reduces wear and helps in the uncoupling of rods. Replace the lid on the grease container after use. The grease must be protected from drilling dust, as left unprotected it will interact with this substance – and act as grinding compound instead of lubrication the next time it is used.

## THREAD WEAR

Drilling with worn threads carries a great risk of equipment downtime. When replacing drill rods, it is often more economical to replace the coupling as well. Mixing new and old threads can make the newer ones wear more quickly.

## BENT AND BLOCKED DRILL STEELS

Not all bent drill steels have to be discarded. They can often be straightened, either in the hole or with a straightening press.

Drill steels and rods' flushing holes can become blocked. Any blockage can normally be removed with the aid of a copper tube and water.

## TRANSPORTATION AND STORAGE

During transportation, bits and cemented components must be packed so as to prevent damage to the cemented carbide. Even though cemented carbide is very resistant to impact against other materials, it is easily damaged by collision with other components made of the same material.

## PREPARATION AND MAINTENANCE

Good drilling practice and correct machine settings are important for the service life of your drilling tools. Management and maintenance also play crucial roles in an efficient and profitable operation.

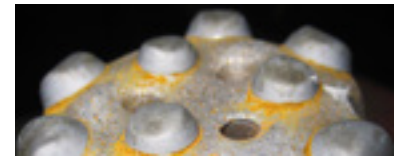
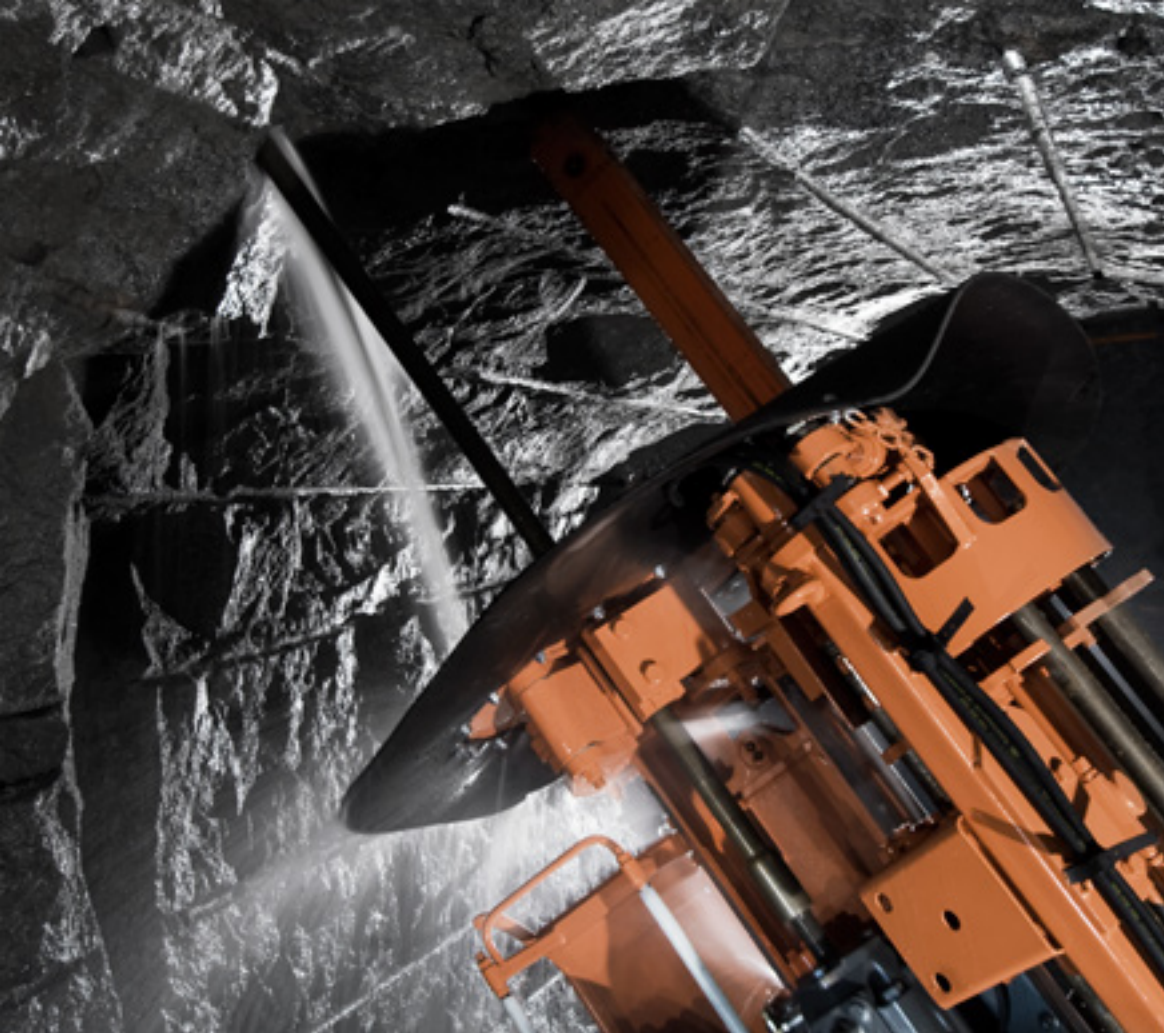

The height of the cemented carbide diminishes as wear progresses, resulting in it wearing flat.



Wear to the cemented carbide on the periphery of the bit is abnormally high, causing an "anti-taper" to develop which diminishes the clearance of the bit.



Here, the surface has become fatigued and developed microscopic cracks.

# CORRECT ACTIONS KEEP THE PACE AT ALL TIMES

Cemented carbide is one of the most successful composite engineering materials produced. Its unique combination of strength, hardness and toughness satisfies the most demanding applications – but working with such high stresses, inserts and buttons are more subject to wear.

## **BUTTON BITS SHOULD BE REGROUND WHEN PENETRATION RATES DROP, OR IF THE CEMENTED CARBIDE SHOWS SIGNS OF DAMAGE**

Fixed grinding routines bring with them good working practice. Bits for instance, should be examined and then reground after a specific number of holes, or at the end of a shift. Premature grinding is not necessarily uneconomical, since less carbide needs to be ground off. It is better to regrind than experience low productivity due to damage.

Proper grinding adds considerably to the service life of drill bits. Another equally important aspect of proper grinding is that it also enhances the performance of the entire drilling operation, particularly hole straightness.

Grinding should always be done in accordance with safety regulations. read more about our Health and Safety Information on page 115.

# HIGH PERFORMING RIGS WITH LOW OPERATIONAL COSTS

Our drilling equipment is known for its quality, reliability and high productivity. Every machine we make is designed to give the lowest possible cost per meter drilled and a low life-cycle cost. We offer an extremely wide choice of machines, ranging from robust hydraulically controlled to fully automated units that give extraordinary production rates and low total cost.



## TOP HAMMER DRILLS

Renowned for high penetration rates, reliability, fuel economy and low operating cost, Sandvik top hammer drills are diesel powered, self-contained and equipped with air compressors, dust collection systems and operator's cabins. They are designed for drilling 22 to 152 mm ( $\frac{3}{4}$  to 6") blastholes up to 30 meters deep.

Sandvik has invested in expanding the top hammer drilling application, in automation, in environmentally friendly systems and energy efficiency. The innovation brought into the market includes AutoMine Surface Drilling, automated drilling phases, data sharing, 3D navigation, i-controls and user interface and training simulation, to improve competitiveness and profitability.

The DPi range of heavy-duty top hammer rigs drill 89 to 152 mm diameter blastholes. High production rates,

hole quality and drilling economy combine for optimal performance. The DPi drills are designed to use 51 to 60 mm drill steel, which provide high bending resistance, enabling the use of maximum kinetic power for drilling straight holes fast without compromising rock tool service life.

The highest performance of the DX range of medium-heavy top hammer drills refers to power, versatility, operator comfort and reliability. The drilling capacity is boosted by the revolving superstructure, which allows the operator turn it 120° giving a drilling coverage of 18 m<sup>2</sup>. The drills are stable even in the roughest terrain. As the cabin turns with the superstructure, the operator has increased visibility.





### MINING JUMBOS

We offer a wide variety of face drills for smallscale mine development up to large-scale tunneling. Leading the way through the toughest conditions, Sandvik jumbos excel in productivity and outstanding reliability. Safety and ergonomics have been key elements in ensuring a comfortable working environment for the operators and service personnel.

Well-designed, modular structures and proven components keep our jumbos running. A combination of efficient rock drills, robust booms and advanced controls meet even the most challenging requirements. Customers heading for superior excavation quality can also choose a higher level of instrumentation.

### PRODUCTION DRILLS

Accuracy makes a world of difference in production drilling. Our longhole drill rigs minimize ore loss and dilution by drilling straight and accurate holes, up to 54 meters in length.

We've designed a comprehensive range of products for different mining methods and mining conditions: different boom types, carrier size classes and rock drill with right rock tool selection ensure optimum hole quality for any long-hole drilling application.

Automation capabilities of the production drill rigs vary based on your needs, from manual drilling to fan automation and tele-remote drilling as an option.

### LOW PROFILE DRILLS

Improved safety, productivity and minimized ore dilution are the benefits we also offer you in low reef mining applications. Sandvik 200L series drill rigs have been designed for low profile mining in working sections as low as 1.7 meters, with optimum drilling coverage and performance. They are typically used in tabular ore bodies such as platinum and chrome mines for development, rock support and production drilling.



### ROCK SUPPORT DRILLS

Our rock support drill rigs make underground excavations not only productive workplaces but also safer.

Advanced mechanized bolting cycles ensure reliability and integrity of every single bolt installation. The full bolting cycle can be conducted safely by one operator. Sandvik rock support drill rigs can handle all typical bolt dimensions and any type of commonly used bolts, including cable.

Maximum safety for your operator and productivity are the main guidelines in the development of the product family.



Mechanized low profile mining has been used for a number of years with great success on various mining sites, clearly increasing safety and productivity in the mines.

***We have a wide range of rigs available. Please contact your local representation for more information.***





# INCREASE SERVICE LIFE AND BOOST PRODUCTIVITY

Integral drill steels, tapered rods, drill bits and threaded rods are key for high productivity in all applications. Our drill steel has a high fatigue strength and toughness, and offers the high wear resistance that provides an efficient and economic drilling operation. The unique R23 rods and bits for extension drilling provide

the strongest thread in sizes ranging from 33 to 45 mm. For underground applications, we have fully carburized rods with superior wear resistance and service life. When working with us, you can expect consistently high quality, and maximum operational dependability when it comes to all small hole-drilling applications.

H19 (3/4) INTEGRAL DRILL STEELS	24
H22 (7/8") INTEGRAL DRILL STEELS	25
H22 TAPERED TOOLS, 12° TAPER	26
H22 TAPERED TOOLS, 11° TAPER	28
H22 TAPERED TOOLS, 7° TAPER	29
R22 (7/8") EXTENSION DRILLING TOOLS	30
R23 (29/32") EXTENSION DRILLING TOOLS	31
R25 (1") EXTENSION DRILLING TOOLS	32



# HANDHELD AND SMALL HOLE DRILLING

## H19 (3/4") INTEGRAL DRILL STEELS

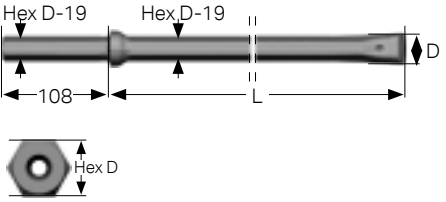
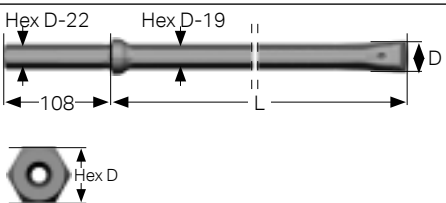
	DIMENSIONS					PART NO.	
	Series	L mm	ft	in	D mm		in
<b>Shank 19×108 mm (3/4"×4 1/4")</b>							
	21	400	1'	4"	29	19/64"	724-0429
	-	800	2'	7"	28	1 7/64"	724-0828
	-	1600	5'	3"	27	1 1/16"	724-1627
	-	2400	7'	10"	26	1 1/32"	724-2426
	24	600	2'	-	27	1 1/16"	724-0627
	-	1200	3'	11"	26	1 1/32"	724-1226
	Boulder-steel	400	1'	4"	24	15/16"	724-0424
	800	2'	7"	23	29/32"	724-0823	
<b>Shank 22×108 mm (7/8"×4 1/4")</b>							
		400	1'	4"	24	15/16"	728-0424
		400	1'	4"	29	1 9/64"	728-0429
		800	2'	7"	28	1 7/64"	728-0828
		1600	5'	3"	27	1 1/16"	728-1627

### BIT DIAMETER NOTES

All bit diameters are larger than the given dimensions in the catalog

**Cross bits:** Can be a maximum of +1 mm due to manufacturing tolerance

**Button bits:** Some bit designs can be a maximum +3 mm to compensate for fast diameter wear. The minimum diameter for all button bits is +1.5 mm above the given dimensions

*Keep in mind that a bit always gives a bigger hole than the stated bit diameter.*

# HANDHELD AND SMALL HOLE DRILLING





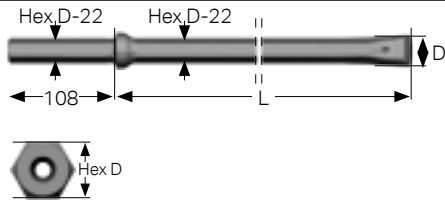

## H22 (7/8") INTEGRAL DRILL STEELS

Series	DIMENSIONS			D		PART NO.
	L mm	ft	in	mm	in	
<b>Shank 22×108 mm (7/8"×4 1/4")</b>						
11	800	2'	7"	34	1 11/32"	714-0834-65
	1600	5'	3"	33	1 19/64"	714-1633-65
	2400	7'	10"	32	1 1/4"	714-2432-65
	3200	10'	6"	31	1 7/32"	714-3231
	4000	13'	1"	30	1 3/16"	714-4030
	4800	15'	9"	29	1 9/64"	714-4829
	5600	18'	4"	28	1 7/64"	714-5628-50
	6400	21'	-	27	1 1/16"	714-6427-50
	7200	23'	8"	26	1 1/32"	714-7226-50
	12	800	2'	7"	40	1 37/64"
1600		5'	3"	39	1 17/32"	714-1639-65
2400		7'	10"	38	1 1/2"	714-2438-65
3200		10'	6"	37	1 29/64"	714-3237-65
4000		13'	1"	36	1 27/64"	714-4036-65
4800		15'	9"	35	1 3/8"	714-4835-65
5600		18'	4"	34	1 11/32"	714-5634-65
7200		23'	8"	32	1 1/4"	714-7232-65
13	400	1'	4"	34	1 11/32"	714-0434-65
	800	2'	7"	33	1 19/64"	714-0833-65
	1200	3'	11"	32	1 1/4"	714-1232-65
	1600	5'	3"	31	1 7/32"	714-1631
	2000	6'	7"	30	1 3/16"	714-2030
16	600	2'	-	35	1 3/8"	714-0635-65
	1200	3'	11"	34	1 11/32"	714-1234-65
	1800	5'	11"	33	1 19/64"	714-1833-65
	2400	7'	10"	32	1 1/4"	714-2432-65
17	600	2'	-	41	1 5/8"	714-0641-65
	1200	3'	11"	40	1 37/64"	714-1240-65
	1800	5'	11"	39	1 17/32"	714-1839-65
	2400	7'	10"	38	1 1/2"	714-2438-65
2000	6'	7"	33	1 19/64"	714-2033-65	
	8000	26'	3"	26	1 1/32"	714-8026-50
	8800	28'	11"	25	1"	714-8825-5005
	9600	31'	6"	25	1"	714-9625-5005
800	2'	7"	29	1 9/64"	714-0829	
	1600	5'	3"	28	1 7/64"	714-1628-50
	2400	7'	10"	27	1 1/16"	714-2427-50

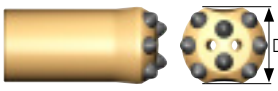

# HANDHELD AND SMALL HOLE DRILLING

## H22 TAPERED TOOLS, 12° TAPER

BITS	FLUSHING HOLE, MM		BUTTONS, MM		ANGLE	DIMENSIONS D		BIT CLASSIFICATION	PART NO.
	Front No Size	Gauge No Size	Front No Size	Gauge No Size		mm	in		
<b>Button bit</b> 	1×5	1×5	1×7	4×7	35°	28	1 1/8"	●	7795-6428-B48
	1×5	1×5	1×7	4×7	35°	30	1 3/16"	●	7795-6430-B48
<b>Button bit</b> 	2×4	1×4	2×7	5×7	40°	32	1 1/4"	●	7795-5232-B48
	2×4	1×4	2×7	5×8	40°	35	1 3/8"	●	7795-5235-B48
	2×4	1×4	2×7	5×9	40°	38	1 1/2"	●	7795-5238-B48
<b>Button bit</b> 	2×4	1×4	2×7	5×7	40°	33	1 9/64"	●	7770-5233-B48
	2×4	1×4	2×7	5×8	35°	35	1 3/8"	●	7770-5235-B48
<b>Button bit</b> 	1×4	1×6	2×7	5×7	35°	33	1 9/64"	●	7770-4433-B48
	1×5	1×5	2×7	5×7	35°	35	1 3/8"	●	7770-4435-B48
<b>Button bit</b> 	2×4	1×4	6×7	2×7	40°	33	1 9/64"	●	7770-5433-B48
<b>Cross bit</b> 	1×4	2×4	-	-	-	30	1 3/16"	●	7770-9030-42
	1×6	2×4.5	-	-	-	32	1 1/4"	●	7770-9032-42
	1×6	2×4.5	-	-	-	35	1 3/8"	●	7770-9035-42



# HANDHELD AND SMALL HOLE DRILLING

## H22 TAPERED TOOLS, 12° TAPER

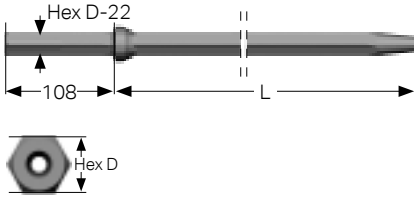
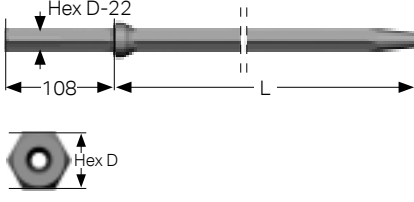
RODS	DIMENSIONS					PART NO.
	L			D		
	mm	ft	in	mm	in	
<b>Tapered rod, shank 22×108, carburized</b>						
	610	2'	-	22	7/8"	7870-6106-11
	1220	4'	-	22	7/8"	7870-6112-11
	1830	6'	-	22	7/8"	7870-6118-11
	2000	6'	7"	22	7/8"	7870-6120-11
	2440	8'	-	22	7/8"	7870-6124-11
	3050	10'	-	22	7/8"	7870-6131-11
	3200	10'	6"	22	7/8"	7870-6132-11
	3660	12'	-	22	7/8"	7870-6137-11
<b>Tapered rod, shank 22×108, HF-hardened – For surface drilling</b>						
	2440	8'	-	22	7/8"	7870-5124-11
	3200	10'	6"	22	7/8"	7870-5132-11
	4000	13'	1 1/2"	22	7/8"	7870-1140-11
	4400	14'	5"	22	7/8"	7870-1144-11
	4800	15'	9"	22	7/8"	7870-1148-11
	5600	18'	4 1/2"	22	7/8"	7870-1156-11
	6400	21'	-	22	7/8"	7870-1164-11
	7200	23'	7 1/2"	22	7/8"	7870-1172-11
	8000	26'	3"	22	7/8"	7870-1180-11
	8800	28'	10 1/2"	22	7/8"	7870-1188-11

# HANDHELD AND SMALL HOLE DRILLING

## H22 TAPERED TOOLS, 11° TAPER

BITS	FLUSHING HOLE, MM		BUTTONS, MM		ANGLE	DIMENSIONS D		BIT CLASSIFICATION	PART NO.
	Front No Size	Gauge No Size	Front No Size	Gauge No Size		mm	in		
	1×6	1×6	2×8	3×9	40°	38	1 1/2"	☉	7776-1938-B48
	1×6	1×6	2×8	3×9	40°	40	1 37/64"	☉	7776-1940-B48

	1×5	1×5	2×7	5×7	40°	32	1 1/4"	●	7776-4432-B48
	1×5	1×5	2×7	5×8	40°	35	1 3/8"	●	7776-4435-B48
	1×5	1×5	2×7	5×8	35°	36	1 7/16"	●	7776-4436-B48
	1×5	1×5	2×7	5×8	35°	38	1 1/2"	●	7776-4438-B48
	1×6	1×6	2×8	5×9	35°	40	1 37/64"	●	7776-4440-B48

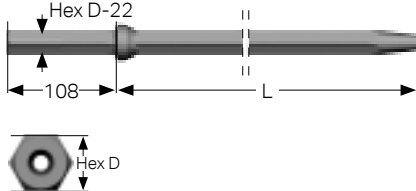
RODS	DIMENSIONS					PART NO.
	L			D		
	mm	ft	in	mm	in	
	610	2'	–	22	7/8"	7876-6106-11
	800	2'	7 1/2"	22	7/8"	7876-6108-11
	1220	4'	–	22	7/8"	7876-6112-11
	1600	5'	3"	22	7/8"	7876-6116-11
	1830	6'	–	22	7/8"	7876-6118-11
	2000	6'	7"	22	7/8"	7876-6120-11
	2440	8'	–	22	7/8"	7876-6124-11
	3050	10'	–	22	7/8"	7876-6131-11
	3600	11'	9 1/2"	22	7/8"	7876-6136-11

# HANDHELD AND SMALL HOLE DRILLING

## H22 TAPERED TOOLS, 7° TAPER

BITS	FLUSHING HOLE, MM		BUTTONS, MM		ANGLE	DIMENSIONS D		BIT CLASSIFICATION	PART NO.
	Front No Size	Gauge No Size	Front No Size	Gauge No Size		mm	in		
 Button bit	2×5	1×5	2×7	5×7	40°	32	1 1/4"	●	7788-5232-B48
	2×4	1×4	2×7	5×7	40°	33	1 9/64"	●	7788-5233-B48
	2×4	1×4	2×7	5×8	40°	35	1 3/8"	●	7788-5235-B48
	2×4	1×4	2×7	5×8	35°	38	1 1/2"	●	7788-5238-B48

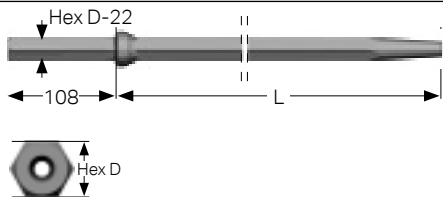
RODS	DIMENSIONS					PART NO.
	L			D		
	mm	ft	in	mm	in	
 Tapered rod, shank 22×108, carburized	2400	8'	–	22	7/8"	7888-6124-11
	3200	10'	6"	22	7/8"	7888-6132-11

## STONE WORKING TOOLS

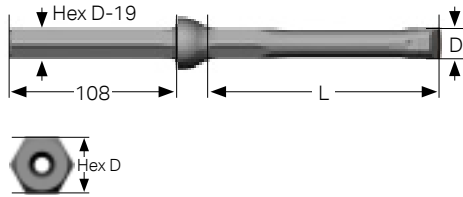
RODS	DIMENSIONS					PART NO.
	L	ft	in	D	in	
	mm			mm		
 Plug hole integral steel	150		6"	17	21/32"	721-1517
	160		6 1/4"	20	25/32"	721-1620
	200		7 7/8"	20	25/32"	721-2020
	240		9 29/64"	20	25/32"	721-2420
	280		11 1/32"	20	25/32"	721-2820
	310		11 1/4"	20	25/32"	721-3120
	160		6 1/4"	22	7/8"	721-1622
	190		7 1/2"	22	7/8"	721-1922



# HANDHELD AND SMALL HOLE DRILLING

## R22 (7/8") EXTENSION DRILLING TOOLS

CROSS BIT	FLUSHING HOLE, MM		BUTTONS, MM		ANGLE	DIMENSIONS D		BIT CLASSIFICATION	PART NO.
	Front No Size	Gauge No Size	Front No Size	Gauge No Size		mm	in		
	1	4.5	2	4.5	-	38	1 1/2"	●	7731-1038-42

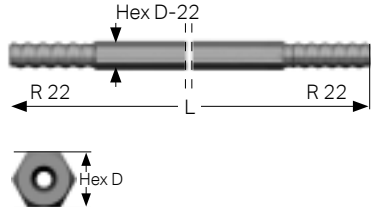
RODS	DIMENSIONS					PART NO.
	L mm	ft	in	D mm	in	
<b>Extension rod R22 – Hex 22 – R22</b> 	800	2'	7"	22	7/8"	7851-1308-20
	1200	3'	11"	22	7/8"	7851-1312-20
	1600	5'	3"	22	7/8"	7851-1316-20

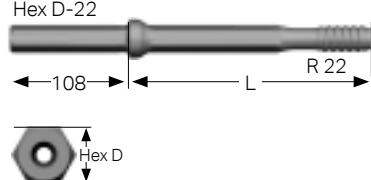
<b>Shank adapter/Shank rod, Hex 22 – R22</b> 	255	-	10 3/64"	22	7/8"	7801-6103-11
---	-----	---	----------	----	------	--------------

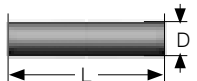
<b>Coupling sleeve, R22</b> 	140	-	5 1/2"	31	1 7/32"	7991-3331
--	-----	---	--------	----	---------	-----------

# HANDHELD AND SMALL HOLE DRILLING

## R23 (29/32") EXTENSION DRILLING TOOLS

BITS	FLUSHING HOLE, MM		BUTTONS, MM		ANGLE	DIMENSIONS D		BIT CLASSIFICATION	PART NO.
	Front No Size	Gauge No Size	Front No Size	Gauge No Size		mm	in		
	1×4	1×6	2×7	5×7	35°	33	1 5/16"	●	7737-4433-R48
	1×6	1×6	2×7	5×8	40°	35	1 3/8"	●	7737-5235-R48
	1×6	1×6	2×7	5×8	35°	38	1 1/2"	●	7737-5238A-R48
	1×6	1×6	2×8	5×9	35°	41	1 5/8"	●	7737-5241-R48

BITS	FLUSHING HOLE, MM		BUTTONS, MM		ANGLE	DIMENSIONS D		BIT CLASSIFICATION	PART NO.
	Front No Size	Gauge No Size	Front No Size	Gauge No Size		mm	in		
	3×5	-	3×8	6×9	30°	45	1 3/4"	●	7737-5345-R48

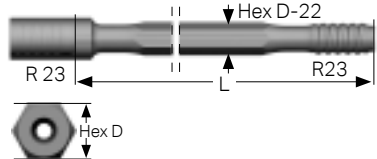
RODS	DIMENSIONS					PART NO.
	L			D		
	mm	ft	in	mm	in	
<b>MF-rod, R23 – Hex 22 – R23</b> 	2095	6'	10 1/2"	22	7/8"	7857-4821-20
	3050	10'	-	22	7/8"	7857-4831-20

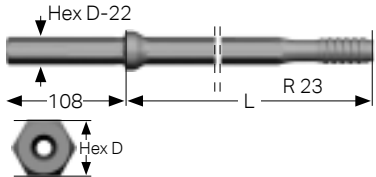

Female end  $\varnothing$  31 mm.

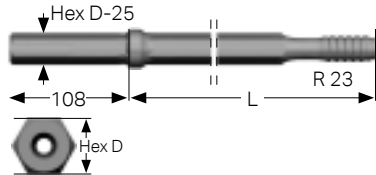
Shank adapter / Shank rod, Hex 22 – R23	DIMENSIONS					PART NO.
	L			D		
	mm	ft	in	mm	in	
	255	-	10 3/64"	22	7/8"	7807-6103-11
	800	2'	7"	22	7/8"	7807-6108-11
	1600	5'	3"	22	7/8"	7807-6116-11
	2400	8'	-	22	7/8"	7807-6124-11
	3200	10'	-	22	7/8"	7807-6132-11
	3600	11'	9 5/8"	22	7/8"	7807-6136-11

Shank adapter / Shankrod Hex 25 – R 23	DIMENSIONS					PART NO.
	L			D		
	mm	ft	in	mm	in	
	255	-	10 3/64"	25	1"	7807-7103-30

# HANDHELD AND SMALL HOLE DRILLING

## R25 (1") EXTENSION DRILLING TOOLS

BITS	FLUSHING HOLE, MM		BUTTONS, MM		ANGLE	DIMENSIONS D		BIT CLASSIFICATION	PART NO.
	Front No Size	Gauge No Size	Front No Size	Gauge No Size		mm	in		
<b>Button bit</b> 	1×4	1×6	2×7	5×8	35°	35	1 3/8"	●	7732-4435-S48 
	1×5	1×6	2×7	5×8	40°	35	1 3/8"	●	7732-5235-R48
	1×6	1×6	2×7	5×9	35°	38	1 1/2"	●	7732-5238-R48
	1×6	1×6	2×7	5×9	30°	38	1 1/2"	●	7732-5238-S48
	1×6	1×6	2×8	5×9	35°	41	1 5/8"	●	7732-5241-S48
<b>Button bit</b> 	3×4.5	–	3×8	6×9	40°	45	1 3/4"	●	7732-5345F-R48
	3×4	1×4	3×9	6×10	30°	48	1 7/8"	●	7732-5348A-S48

 For one-rod drilling.



# HANDHELD AND SMALL HOLE DRILLING

## R25 (1") EXTENSION DRILLING TOOLS

RODS	DIMENSIONS					PART NO.
	L			D		
	mm	ft	in	mm	in	
<b>Shank adapter / rod, Hex 22 × R25</b>						
	255	-	10 3/64"	22	7/8"	7802-6103-11
	800	2'	7"	22	7/8"	7802-6108-11
	1000	3'	3"	22	7/8"	7802-6110-11
<b>Shank adapter / rod, Hex 25 × R25</b>						
	2400	7'	10"	25	1"	7802-7124-30
	3735	12'	3"	25	1"	7802-71373-30
<b>MF-ROD, R25 – Hex 25 – R 25</b>						
	1220	4'	-	25	1"	7852-3112-20
	2100	6'	10"	25	1"	7852-3121-20
	3100	10'	2"	25	1"	7852-3131-20
<b>Extension rod, R25 – Hex 25 – R25</b>						
	915	3'	-	25	1"	7852-2309-20
	1220	4'	-	25	1"	7852-2312-20
	1525	5'	-	25	1"	7852-2315-20
	1830	6'	-	25	1"	7852-2318-20
	2435	8'	-	25	1"	7852-2324-20
	3050	10'	-	25	1"	7852-2331-20
<b>Coupling sleeve, R25</b>						
	160	-	6 1/4"	35	1 3/8"	7992-3335



# CONSTANTLY TAKING DRILLING TO A NEW LEVEL

Our engineers are perpetually engaged in upgrading our tool systems. Supported by our in-house manufacturing facilities, the results of their work speak for them-

selves; you and all other rock-drilling professionals constantly receive new solutions which enable you to work even more profitably.

## PRECISION ENGINEERING FOR STRAIGHTER DRILL HOLES WITH SANDVIK ALPHA

- Short thread design with sturdy guides well inside the bit skirt offers higher precision in collaring – even in complex rock formations and on uneven surfaces.
- Rigid drill string results in straighter holes, permitting optimum drilling patterns and a higher rate of advance.
- Exact collaring and straighter holes are prerequisites for productive drilling, with less over break and lower overall costs.
- Hexagonal rods in the tool system result in a rigid, integrated power pack drill string, and subsequently superior resistance to bending stresses. This gives improved bit guidance as well as perfect energy transfer.
- More efficient energy transmission, with minimal wear on all components in the drilling system.
- Short thread and robust guide improves service life on drifter rods – by at least +30% compared to R32 rods.

## NEW DESIGN PROVIDES TROUBLE FREE OPERATION

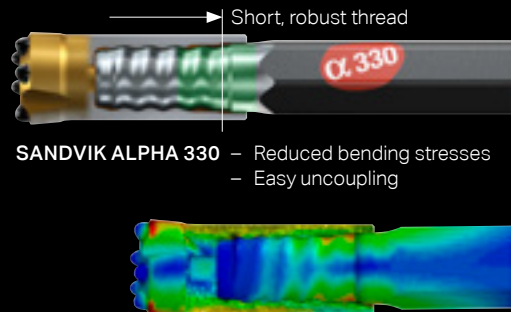



Advanced analysis has been used to simulate and locate critical bending stresses of various designs to arrive at an optimally dimensioned rod/bit connection.

R25 (1") BIT THREAD	36
R28 (1 1/8") BIT THREAD	38
R32 (1 1/4") BIT THREAD	39
SANDVIK ALPHA. α330 BIT THREAD	42
SANDVIK BITS	48

# FACEDRILLING AND BOLTING

## R25 (1") BIT THREAD

BITS	FLUSHING HOLE, MM		BUTTONS, MM		ANGLE	DIMENSIONS D		BIT CLASSIFICATION	PART NO.
	Front No Size	Gauge No Size	Front No Size	Gauge No Size		mm	in		
<b>Button bit, type 52</b>									
	1×4.5	1×6	2×7	5×7	45°	33	1 5/16"	●	7732-4433C-S48
	1×5	1×6	2×7	5×9	30°	35	1 3/8"	●	7732-4435-S48
	1×5	1×6	2×7	5×9	30°	37	7/16"	●	7732-4437C-S48
	1×5	1×6	2×7	5×8	40°	35	1 3/8"	○	7732-5235-R48
	1×6	1×6	2×7	5×9	35°	38	1 1/2"	○	7732-5238-R48
	1×6	1×6	2×7	5×9	30°	38	1 1/2"	●	7732-5238-S48
	1×6	1×6	2×8	5×9	35°	41	1 5/8"	●	7732-5241-S48
<b>Button bit, type 53</b>									
	3×4.5	–	3×8	6×9	40°	45	1 3/4"	○	7732-5345F-R48
	3×4	1×4	3×9	6×10	30°	48	1 7/8"	●	7732-5348A-S48
<b>Cross bit</b>									
	1×5	2×5				35	1 3/8"	●	7732-1435-42

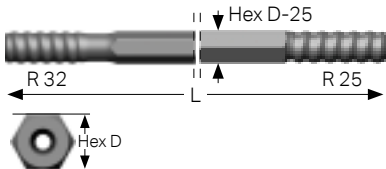
RODS	DIMENSIONS					PART NO.
	L			D		
	mm	ft	in	mm	in	
<b>Drifter rod, R32 – Hex 25 – R25</b>						
	1870	6'	1 5/8"	25	1"	7853-2418-20
	2175	7'	1 5/8"	25	1"	7853-2421-20
	2475	8'	1 1/2"	25	1"	7853-2424-20
	2630	8'	7 1/2"	25	1"	7853-2426-20
	2785	9'	1 5/8"	25	1"	7853-2427-20
	2935	9'	7 1/2"	25	1"	7853-2429-20
	3090	10'	1 5/8"	25	1"	7853-2431-20
	3340	10'	11 1/2"	25	1"	7853-2433-20
	3700	12'	1 5/8"	25	1"	7853-2437-20

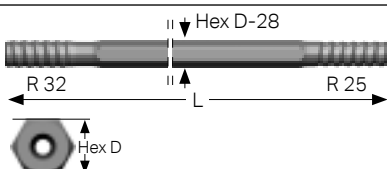
<b>Drifter rod, R32 – Hex 28 – R25</b>						
	2630	8'	7 1/2"	28	1 1/8"	7853-3026-20
	3090	10'	1 5/8"	28	1 1/8"	7853-3031-20

Flushing hole Ø 8.6 mm.

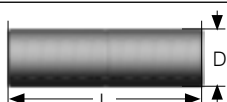
<b>Coupling sleeve, R32</b>						
	150	5 29/32"	44	1 47/64"	7993-3644	



# FACEDRILLING AND BOLTING

## R25 (1") REAMING TOOLS

	THREAD	DIMENSIONS					PART NO.
		L			D		
		mm	ft	in	mm	in	
Reaming tools for cut holes / Pilot adapter, 6° taper	R25	-	-	-	26	1 1/32"	7822-2526



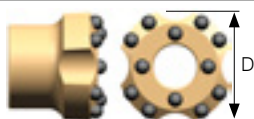

	BUTTONS, MM		ANGLE	DIMENSIONS D		PART NO.
	Front No Size	Gauge No Size		mm	in	
	Reaming tools for cut holes / Reaming bit, 6° taper	4×8		8×9	25°	
	4×10	8×10	30°	76	3"	7722-4876-S48
	6×10	8×12	35°	89	3 1/2"	7722-4889-S48



# FACEDRILLING AND BOLTING

## R28 (1 1/8") BIT THREAD

BITS	FLUSHING HOLE, MM		BUTTONS, MM		ANGLE	DIMENSIONS D		BIT CLASSIFICATION	PART NO.
	Front No Size	Gauge No Size	Front No Size	Gauge No Size		mm	in		
 Button bit, type 52	1×5	1×6	2×7	5×9	30°	37	7/16"	●	7739-5237-S48
	1×6	1×6	2×7	5×9	35°	38	1 1/2"	●	7739-5238-R48
	1×6	1×6	2×7	5×9	30°	38	1 1/2"	●	7739-5238-S48
	1×6	1×6	2×8	5×9	35°	41	1 5/8"	●	7739-5241-S48
	1×6	1×6	2×8	5×10	30°	43	1 11/16"	●	7739-5243-S48

REAMING TOOLS	THREAD	DIMENSIONS					PART NO.
		L			D		
		mm	ft	in	mm	in	
 Reaming tools for cut holes / Pilot adapter, 6° taper	R28	-	-	-	26	1 1/32"	7822-1526

	BUTTONS, MM		ANGLE	DIMENSIONS D		PART NO.
	Front No Size	Gauge No Size		mm	in	
 Reaming tools for cut holes / Reaming bit, 6° taper	4×8	8×9	25°	64	2 1/2"	7722-4864-S48
	4×10	8×10	30°	76	3"	7722-4876-S48
	6×10	8×12	35°	89	3 1/2"	7722-4889-S48

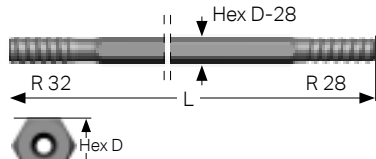



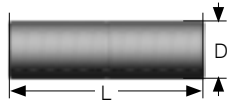

RODS	DIMENSIONS					PART NO.
	L			D		
	mm	ft	in	mm	in	
 Drifter rod, R32 - Hex 28 - R28	2475	8'	1 1/2"	28	1 1/8"	7853-7624-20
	2785	9'	1 5/8"	28	1 1/8"	7853-7627-20
	3090	10'	1 5/8"	28	1 1/8"	7853-7631-20
	3700	12'	1 5/8"	28	1 1/8"	7853-7637-20
	4305	14'	1 1/2"	28	1 1/8"	7853-7643-20

Flushing hole  $\varnothing$  8.8 mm.

COUPLING SLEEVE, R32	DIMENSIONS					PART NO.
	L	D				
	mm	in	mm	in	mm	
	150	5 29/32"	44	1 47/64"	7993-3644	

# FACEDRILLING AND BOLTING

## R32 (1 1/4") BIT THREAD

BITS	FLUSHING HOLE, MM		BUTTONS, MM		ANGLE	DIMENSIONS D		BIT CLASSIFICATION	PART NO.
	Front No Size	Gauge No Size	Front No Size	Gauge No Size		mm	in		
<b>Button bit, type 52</b>									
	1×6	1×6	2×8	5×9	35°	41	1 5/8"	●	7733-5241-S48
	1×5	2×6	2×9	5×10	35°	43	1 11/16"	●	7733-5243A-S48
	1×5	2×6	2×9	5×11	30°	45	1 3/4"	●	7733-5245A-S48
	1×6	2×7.5	2×9	5×11	35°	48	1 7/8"	●	7733-5248A-S48
	1×6	2×7.5	2×10	5×12	35°	51	2"	●	7733-5251A-S48
<b>Button bit, type 53/16</b>									
	3×4.5	1×4.5	3×8	6×9	30°	43	1 11/16"	○	7733-5343A-R48
	3×4.5	1×5	3×8	6×10	30°	45	1 3/4"	○	7733-5345A-R48
	3×4.5	1×5	3×8	6×10	25°	45	1 3/4"	●	7733-5345A-S48
	3×5	1×5	3×9	6×10	30°	48	1 7/8"	○	7733-5348A-R48
	3×5	1×5	3×9	6×10	30°	48	1 7/8"	●	7733-5348A-S48
	3×6	1×6	3×9	6×10	40°	51	2"	○	7733-1651A-R48
	3×6	1×6	3×9	6×10	35°	51	2"	●	7733-1651A-S48
	3×6	1×6	3×10	6×11	35°	57	2 1/4"	●	7733-1657A-S48
	3×7	-	3×11	6×12	30°	64	2 1/2"	●	7733-1664-S48
<b>Button bit, type 54</b>									
	2×6	2×6	2×9	6×9	40°	43	1 11/16"	○	7733-5443B-R48
	2×6	2×6	2×9	6×10	35°	45	1 3/4"	○	7733-5445B-R48
<b>Button bit, type 55</b>									
	3×5.5	1×5.5	3×9	6×9	40°	45	1 3/4"	○	7733-5545A-C60
	3×5.5	1×5.5	3×9	6×10	40°	48	1 7/8"	○	7733-5548A-C60
	3×6	1×6	3×9	6×10	40°	51	2"	○	7733-5551A-C60
<b>Button bit, type 18</b>									
	4×7	-	5×11	8×12	35°	76	3"	●	7733-1876-S48
<b>Cross bit</b>									
	1×5	4×6	-	-	-	45	1 3/4"	●	7733-1345A-42

# FACEDRILLING AND BOLTING

## R32 (1 1/4") BIT THREAD

RODS	DIMENSIONS					PART NO.	
	L			D			
	mm	ft	in	mm	in		
<b>Drifter rod, R38 – Hex 35 – R32</b>							
	3090	10'	1 5/8"	35	1 3/8"	7854-9631-20	
	3700	12'	1 5/8"	35	1 3/8"	7854-9637-20	
	4305	14'	1 1/2"	35	1 3/8"	7854-9643-20	
	4915	16'	1 1/2"	35	1 3/8"	7854-9649-20	
	5525	18'	1 1/2"	35	1 3/8"	7854-9655-20	
Flushing hole Ø 9.5 mm.							
<b>Drifter rod, R38 – Hex 32 – R32</b>							
	2475	8'	1 1/2"	32	1 1/4"	7854-8624-20	
	3090	10'	1 5/8"	32	1 1/4"	7854-8631-20	
	3700	12'	1 5/8"	32	1 1/4"	7854-8637-20	
	4305	14'	1 1/2"	32	1 1/4"	7854-8643-20	
	4915	16'	1 1/2"	32	1 1/4"	7854-8649-20	
Flushing hole Ø 9.6 mm.							
<b>Drifter rod, T38 – Hex 32 – R32</b>							
	3090	10'	1 5/8"	32	1 1/4"	7324-8631-20	
	3700	12'	1 5/8"	32	1 1/4"	7324-8637-20	
	4305	14'	1 1/2"	32	1 1/4"	7324-8643-20	
Flushing hole Ø 9.6 mm.							
<b>Drifter rod, T38 – Hex 35 – R32</b>							
	2475	8'	1 1/2"	35	1 3/8"	7324-9624-20	
	3090	10'	1 5/8"	35	1 3/8"	7324-9631-20	
	3700	12'	1 5/8"	35	1 3/8"	7324-9637-20	
	4305	14'	1 1/2"	35	1 3/8"	7324-9643-20	
	4915	16'	1 1/2"	35	1 3/8"	7324-9649-20	
	5525	18'	1 1/2"	35	1 3/8"	7324-9655-20	
	6135	20'	1 1/2"	35	1 3/8"	7324-9661-20	
	6440	21'	1 1/2"	35	1 3/8"	7324-9664-20	
Flushing hole Ø 9.5 mm.							
<b>MF Drifter rod, T38 – Hex 35 – R32</b>							
	3700	12'	1 1/2"	35	1 3/8"	7324-6537-20	
	4305	14'	1 1/2"	35	1 3/8"	7324-6543-20	
Flushing hole Ø 9.5 mm.							
<b>Coupling sleeve</b>							
	R38	170	–	6 3/4"	55	2 5/32"	7994-3655
	T38	191	–	7 1/2"	52	2"	7314-3652



# FACEDRILLING AND BOLTING

## R32 (1 1/4") REAMING TOOLS

PILOT ADAPTERS 6°, 12° TAPER	THREAD	DIMENSIONS					PART NO.
		L mm	ft	in	D mm	in	
Reaming tools for cut holes / Pilot adapter, 6° taper	R32	-	-	-	26	1 1/32"	7822-3526



Reaming tools for cut holes / Pilot adapter, 12° taper	R32	-	-	-	40	1 37/64"	7821-3440
--	-----	---	---	---	----	----------	-----------



REAMING BIT 6°, 12° TAPER	BUTTONS, MM		ANGLE	DIMENSIONS D		PART NO.
	Front No Size	Gauge No Size		mm	in	
Reaming tools for cut holes / Reaming bit, 6° taper	4×8	8×9	25°	64	2 1/2"	7722-4864-S48
	4×10	8×10	30°	76	3"	7722-4876-S48
	6×10	8×12	35°	89	3 1/2"	7722-4889-S48

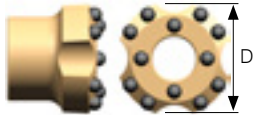

Reaming tools for cut holes / Reaming bit, 12° taper	4×10	8×12	35°	89	3 1/2"	7721-4889-S48
	4×13	8×13	35°	102	4"	7721-4802-S48
	8×13	8×13	35°	127	5"	7721-4827-S48

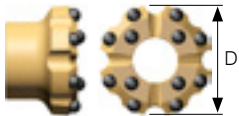









REAMING BIT	FLUSHING HOLE, MM		BUTTONS, MM		ANGLE	DIMENSIONS D		PART NO.
	Front No Size	Gauge No Size	Front No Size	Gauge No Size		mm	in	
Reaming tools for cut holes / Reaming bit, R32	4×6	-	3×10	12×13	35°	102	4"	7733-5602P-S48



# FACEDRILLING AND BOLTING

SANDVIK ALPHA.  $\alpha$ 330 BIT THREAD

BITS	FLUSHING HOLE, MM		BUTTONS, MM		ANGLE	DIMENSIONS D		BIT CLASSIFICATION	PART NO.
	Front No Size	Gauge No Size	Front No Size	Gauge No Size		mm	in		
<b>Button bit, type 52</b>									
	1×5	1×7.5	2×9	5×10	35°	43	1 11/16"	●	7767-5243A-S48
	1×5	1×7.5	2×9	5×11	30°	45	1 3/4"	●	7767-5245A-S48
	1×6	2×7.5	2×9	5×11	35°	48	1 7/8"	●	7767-5248A-S48
<b>Button bit, type 53/16</b>									
	3×4.5	1×4.5	3×8	6×9	30°	43	1 11/16"	●	7767-5343A-R48
	3×4.5	1×5	3×8	6×10	30°	45	1 3/4"	●	7767-5345A-R48
	3×4.5	1×5	3×8	6×10	25°	45	1 3/4"	●	7767-5345A-S48
	3×5	1×5	3×9	6×10	30°	48	1 7/8"	●	7767-5348A-R48
	3×5	1×5	3×9	6×10	30°	48	1 7/8"	●	7767-5348A-S48
	3×6	1×6	3×9	6×10	40°	51	2"	●	7767-1651A-R48
	3×6	1×6	3×9	6×10	35°	51	2"	●	7767-1651A-S48
	3×7	-	3×11	6×12	30°	64	2 1/2"	●	7767-1664-S48
<b>Button bit, type 54</b>									
	2×6	2×6	2×9	6×9	40°	43	1 11/16"	●	7767-5443B-R48
	2×6	2×6	2×9	6×10	35°	45	1 3/4"	●	7767-5445B-R48
<b>Button bit, type 55</b>									
	3×5.5	1×5.5	3×9	6×9	40°	45	1 3/4"	○	7767-5545A-C60
<b>Button bit, type 18</b>									
	4×7	-	1×6	8×11	35°	76	3"	●	7767-1876-S48
<b>Button bit, Retrac</b>									
	3×6	-	3×9	6×10	35°	51	2"	●	7767-4651A-S48
<b>Cross bit</b>									
	1×5	4×6				45	1 3/4"	●	7767-1345A-42

# FACEDRILLING AND BOLTING

SANDVIK ALPHA.  $\alpha$ 330 BIT THREAD

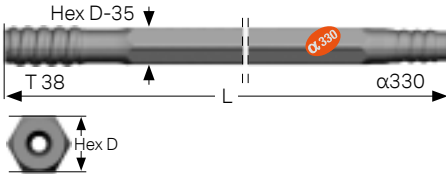
RODS	DIMENSIONS					PART NO.
	L mm	ft	in	D mm	in	
<b>Drifter rod, T38 – Hex 35 – <math>\alpha</math>330</b> 	2475	8'	1 1/2"	35	1 3/8"	7324-6724-20
	3090	10'	1 5/8"	35	1 3/8"	7324-6731-20
	3700	12'	1 5/8"	35	1 3/8"	7324-6737-20
	4305	14'	1 1/2"	35	1 3/8"	7324-6743-20
	4915	16'	1 1/2"	35	1 3/8"	7324-6749-20
	5525	18'	1 1/2"	35	1 3/8"	7324-6755-20

Flushing hole  $\varnothing$  9.5 mm.

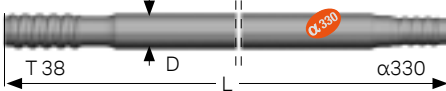
<b>Drifter rod, T38 – Round 39 – <math>\alpha</math>330</b> 	4915	16'	1 1/2"	39	1 1/2"	7324-7049-20
	5525	18'	1 1/2"	39	1 1/2"	7324-7055-20
	6135	20'	1 1/2"	39	1 1/2"	7324-7061-20
	6440	21'	1 1/2"	39	1 1/2"	7324-7064-20

Flushing hole  $\varnothing$  10.3 mm.

# DRIFTING AND TUNNELING

SANDVIK ALPHA.  $\alpha$ 330 BIT THREAD

COUPLING SLEEVES	DIMENSIONS					PART NO.
	L			D		
	mm	ft	in	mm	in	
Coupling sleeve, T38	191	-	7 1/2"	52	2"	7314-3652

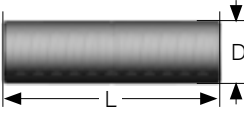

REAMING BIT	FLUSHING HOLE, MM		BUTTONS, MM		ANGLE	DIMENSIONS D		PART NO.
	Front No Size	Gauge No Size	Front No Size	Gauge No Size		mm	in	
Reaming tools for cut holes / Reaming bit, $\alpha$ 330	2×6	2×6	3×10	12×13	35°	102	4"	7767-5602P-S48



PILOT ADAPTER 12° TAPER	THREAD	DIMENSIONS					PART NO.
		L			D		
		mm	ft	in	mm	in	
Reaming tools for cut holes / Pilot adapter, 12° taper	$\alpha$ 330	-	-	-	40	1 37/64"	7821-6740





REAMING BIT 12° TAPER	BUTTONS, MM		ANGLE	DIMENSIONS D		PART NO.
	Front No Size	Gauge No Size		mm	in	
Reaming tools for cut holes / Reaming bit, 12° taper	4×10	8×12	35°	89	3 1/2"	7721-4889-S48
	4×13	8×13	35°	102	4"	7721-4802-S48
	8×13	8×13	35°	127	5"	7721-4827-S48





# DRIFTING AND TUNNELING

## R35 (1 3/8") BIT THREAD

BITS	FLUSHING HOLE, MM		BUTTONS, MM		ANGLE	DIMENSIONS D		BIT CLASSIFICATION	PART NO.
	Front No Size	Gauge No Size	Front No Size	Gauge No Size		mm	in		
<b>Button bit, type 53/16</b>									
	3x5	1x5	3x9	6x10	30°	48	1 7/8"	●	7738-5348A-R48
	3x5	1x5	3x9	6x10	30°	48	1 7/8"	●	7738-5348A-S48
	3x6	1x6	3x9	6x10	40°	51	2"	●	7738-1651A-R48
	3x6	1x6	3x9	6x10	35°	51	2"	●	7738-1651A-S48
<b>Cross bit</b>									
	1x5	2x7,5	-	-	-	48	1 7/8"	●	7738-1448-42

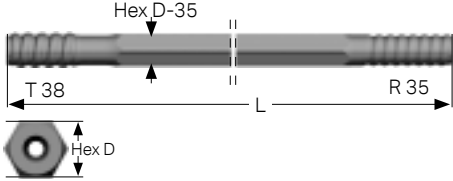
RODS	DIMENSIONS					PART NO.
	L			D		
	mm	ft	in	mm	in	
<b>Drifter rod, T38 – Hex 35 – R35</b>						
	4305	14'	1 1/2"	35	1 3/8"	7324-8543-20
	4915	16'	1 1/2"	35	1 3/8"	7324-8549-20
	5525	18'	1 1/2"	35	1 3/8"	7324-8555-20

Flushing hole Ø 9.5 mm.

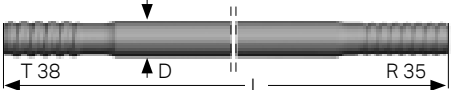
<b>Drifter rod, T38 – Round 39 – R35</b>						
	4305	14'	1 1/2"	39	1 1/2"	7324-7243-20
	4915	16'	1 1/2"	39	1 1/2"	7324-7249-20
	5525	18'	1 1/2"	39	1 1/2"	7324-7255-20
	6135	20'	1 1/2"	39	1 1/2"	7324-7261-20

Flushing hole Ø 14.5 mm.

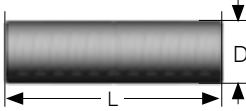
<b>Drifter rod, T38 – Round 39 – R35</b>						
	191	-	7 1/2"	52	2"	7314-3652

# FACEDRILLING AND BOLTING

## R35 (1 3/8") BIT THREAD

REAMING BIT	FLUSHING HOLE, MM		BUTTONS, MM		ANGLE	DIMENSIONS D		PART NO.
	Front No Size	Gauge No Size	Front No Size	Gauge No Size		mm	in	
Reaming tools for cut holes / Reaming bit, R35								
	2×6	2×6	3×10	12×13	35°	102	4"	7738-5602P-S48

PILOT ADAPTER 12° TAPER	THREAD	DIMENSIONS			D		PART NO.
		L mm	ft	in	mm	in	
Reaming tools for cut holes / Pilot adapter, 12° taper							
	R35	-	-	-	40	1 37/64"	7821-5440

REAMING BIT 12° TAPER	BUTTONS, MM		ANGLE	DIMENSIONS D		PART NO.
	Front No Size	Gauge No Size		mm	in	
Reaming tools for cut holes / Reaming bit, 12° taper						
	4×10	8×12	35°	89	3 1/2"	7721-4889-S48
	4×13	8×13	35°	102	4"	7721-4802-S48
	8×13	8×13	35°	127	5"	7721-4827-S48

# FACEDRILLING AND BOLTING

## SANDVIK EXTRA. R35 (1 3/8") BIT THREAD

BITS	FLUSHING HOLE, MM		BUTTONS, MM		ANGLE	DIMENSIONS D		BIT CLASSIFICATION	PART NO.
	Front No Size	Gauge No Size	Front No Size	Gauge No Size		mm	in		
 Button bit, Retrac R35	3×6	1×5	3×9	6×10	30°	54	2 1/5"	●	7738-4654A1-R48

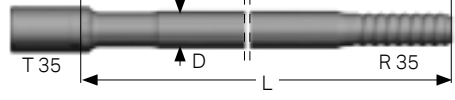
RODS	DIMENSIONS					PART NO.
	L mm	ft	in	D mm	in	
 Drifter rod, T35 – Round 39 – R35	4305	14'	1 1/2"	39	1 1/2"	7327-5243-20
	4915	16'	1 1/2"	39	1 1/2"	7327-5249-20
	5525	18'	1 1/2"	39	1 1/2"	7327-5255-20
	6135	20'	1 1/2"	39	1 1/2"	7327-5261-20

Flushing hole Ø 14.5 mm. Female end Ø 48.2 mm.

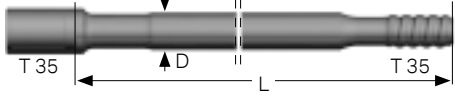
RODS	DIMENSIONS					PART NO.
	L mm	ft	in	D mm	in	
 Drifter Extension rod, T35 – Round 39 – T35	3050	10'	–	39	1 1/2"	7327-4731-20
	3660	12'	–	39	1 1/2"	7327-4737-20
	4265	14'	–	39	1 1/2"	7327-4743-20
	4875	16'	–	39	1 1/2"	7327-4749-20

Flushing hole Ø 14.5 mm. Female end Ø 48.2 mm.

# FACEDRILLING AND BOLTING

## SANDVIK DRIFTER BITS

### SANDVIK BITS FOR DRIFTING AND TUNNELING ARE AVAILABLE IN FOUR BASIC DESIGNS

---



#### TYPE 52

Designed for maximum bit life in hard and abrasive rock.

---



#### TYPE 53

All-round design with a good trade off between speed and bit life length for hard to medium hard rock.

---



#### TYPE 54

All-round design with high penetration rate for hard to medium hard rock.

---



#### TYPE 55

Designed for maximum penetration rate in softer and less abrasive rock formations.

---







# DRILLING SOLUTIONS THAT MAKE YOU EFFICIENT

We offer several types of specially designed drilling tools. These tools provide solutions that minimize hole deviation and optimize drilling patterns. The results

include improved hole-straightness, superior energy transmission and higher drilling efficiency.

Sandvik GT60 enables the drilling of holes from 92 mm to 152 mm in diameter. By using a GT60 tool system when drilling the typical T51 hole size (102 mm), hole straightness can be greatly improved – thanks to the much stiffer and more stable rod package. The Sandvik GT60 tools system also offers excellent energy transfer efficiency all the way from rock drill to hole bottom, reducing fuel costs and environmental impact. Increased energy transfer efficiency is key to achieve the best penetration rate possible from every drilling rig.

#### BENEFITS IN BENCH DRILLING:





- Lower total operating cost.
- Longer service life of drill steel components
- Less downtime, which means improved productivity.
- Improved safety and better blasting control.
- Less hole deviation and better-balanced fragmentation.
- Reduced consumption of explosives, which account for about half of all total drilling and blasting costs.

In addition, a drill string with Sandvik MF-rods offers stiffer connections than a string with separate coupling sleeves, due to the 50 % reduction in thread play.

R32 (1 1/4")	52
T35 (1 3/8")	54
T38 (1 1/2")	55
T45 (1 3/4")	57
T51 (2")	59
SANDVIK GT60	61

# BENCH DRILLING

R32 (1 1/4")

BITS	FLUSHING HOLE, MM		BUTTONS, MM		ANGLE	DIMENSIONS D		BIT CLASSIFICATION	PART NO.
	Front No Size	Gauge No Size	Front No Size	Gauge No Size		mm	in		
<b>Button bit, regular skirt</b>									
	3×6	1×6	3×9	6×10	40°	51	2"	●	7733-1651A-R48
	3×6	1×6	3×9	6×10	35°	51	2"	●	7733-1651A-S48
	3×6	1×6	3×10	6×11	35°	57	2 1/4"	●	7733-1657A-S48
	3×7	-	3×11	6×12	30°	64	2 1/2"	●	7733-1664-S48
	4×7	-	5×11	8×12	35°	76	3"	●	7733-1876-S48
	3×6	1×6	3×9	6×10	40°	51	2"	○	7733-5551A-C60
	3×6	1×6	3×10	6×10	40°	57	2 1/4"	○	7733-5557A-C60
	3×8	1×8	3×10	6×11	40°	64	2 1/2"	○	7733-5564A-C60
<b>Button bit, Retrac</b>									
	3×6	-	3×9	6×10	35°	51	2"	●	7733-4651-R48
	3×6	-	3×9	6×10	35°	51	2"	●	7733-4651-S48
	4×7	-	5×9	8×10	30°	64	3 1/2"	●	7733-4864-S48



# BENCH DRILLING

R32 (1 1/4")

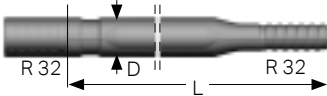
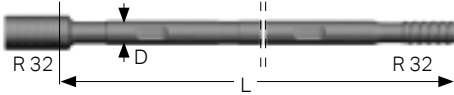
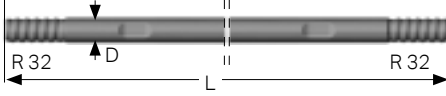
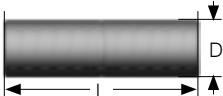
RODS	DIMENSIONS						PART NO.
	Bit dia. mm	L mm	ft	in	D mm	in	
<b>Guide tube</b>							
	51-64	1830	6'	-	46	1 3/4"	7953-4618-20
Female end Ø 46 mm.							
<b>MF-rod, R32 – round 32 – R32</b>							
		3050	10'	-	32	1 1/4"	7853-5131-20
		3660	12'	-	32	1 1/4"	7853-5137-20
Flushing hole Ø 9.2 mm. Wrench flat 25.4 mm. Female end Ø 45 mm.							
<b>Extension rod, R32 – round 32 – R32</b>							
		2440	8'	-	32	1 1/4"	7853-3324-30
		3050	10'	-	32	1 1/4"	7853-3331-30
		3660	12'	-	32	1 1/4"	7853-3337-30
Flushing hole Ø 11.7 mm. Wrench flat 25.4 mm.							
<b>Coupling sleeve R32</b>							
		150	-	5 29/32"	44	1 47/64"	7993-3644

HANDHELD AND  
SMALL HOLE DRILLING

FACEDRILLING  
AND BOLTING

BENCH DRILLING

LONG HOLE DRILLING

SHANK ADAPTERS



AUXILIARY TOOLS

GRINDING EQUIPMENT

INFORMATION AND BIT  
CLASSIFICATION GUIDE

# BENCH DRILLING

T35 (1 3/8")



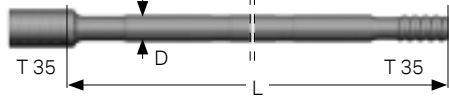







BITS	FLUSHING HOLE, MM		BUTTONS, MM		ANGLE	DIMENSIONS D		BIT CLASSIFICATION	PART NO.
	Front No Size	Gauge No Size	Front No Size	Gauge No Size		mm	in		
<b>Button bit, regular skirt</b> 	3×6	1×6	3×9	6×10	35°	54	2 1/8"	●	7517-1654A-S48
<b>Button bit, Retrac</b> 	3×6	-	3×9	6×10	35°	54	2 1/8"	●	7517-4654-R48
	3×7	-	3×10	6×11	35°	57	2 1/4"	●	7517-4657-R48

RODS	DIMENSIONS					PART NO.
	L			D		
	mm	ft	in	mm	in	
<b>MF-rod, T35 – round 39 – T35</b> 	3050	10'	-	39	1 1/2"	7327-4731-20
	3660	12'	-	39	1 1/2"	7327-4737-20

Female end Ø 48,2 mm. Flushing hole Ø 14,5 mm.

# BENCH DRILLING

T38 (1 1/2")

BITS	FLUSHING HOLE, MM		BUTTONS, MM		ANGLE	DIMENSIONS D		BIT CLASSIFICATION	PART NO.
	Front No Size	Gauge No Size	Front No Size	Gauge No Size		mm	in		
<b>Button bit, regular skirt</b>									
	3×7	1×7	3×9	6×11	35°	54	2 1/8"	●	7514-1654A-R48
	3×8	–	3×11	6×12	35°	64	2 1/2"	●	7514-1664-R48
	3×8	–	3×11	6×12	30°	64	2 1/2"	●	7514-1664-S48
	4×8	–	5×10	8×11	30°	70	2 3/4"	●	7514-1870-S48
	4×8	–	5×11	8×11	40°	76	3"	●	7514-1876-R48
	4×8	–	5×11	8×12	35°	76	3"	●	7514-1876-S48
	4×9	–	5×12	8×12	35°	89	3 1/2"	●	7514-1889-S48
	2×11	1×6	4×10	8×10	30°	64	2 1/2"	●	7514-2664A-S48
	2×11	1×6	6×10	8×11	35°	76	3"	●	7514-2676A-S48
	3×8	1×8	3×10	6×11	40°	64	2 1/2"	○	7514-5564A-C60
	4×8	1×8	4×10	8×11	40°	76	3"	○	7514-5576A-C60
<b>Button bit, Retrac</b>									
	3×8	–	3×11	6×12	35°	64	2 1/2"	●	7514-4664-R48
	3×8	–	3×11	6×12	30°	64	2 1/2"	●	7514-4664-S48
	4×8	–	5×9	8×10	35°	64	2 1/2"	●	7514-4864-R48
	4×8	–	5×10	8×11	30°	70	2 3/4"	●	7514-4870-S48
	4×8	–	5×11	8×11	35°	76	3"	●	7514-4876-R48
	4×8	–	5×11	8×12	35°	76	3"	●	7514-4876-S48
	3×8	1×8	4×11	6×12	40°	76	3"	○	7514-7576A-C60
	2×10	1×6	4×10	8×10	30°	64	2 1/2"	●	7514-7864A-S48
	2×11	1×6	6×10	8×11	35°	76	3"	●	7514-7876A-S48
	3×8	–	4×9	6×10	40°	64	2 1/2"	●	7514-7964-R48
	3×8	–	4×9	6×10	35°	64	2 1/2"	●	7514-7964-S48
	4×8	–	6×10	8×11	35°	76	3"	●	7514-7976-R48
	4×7	–	6×10	8×11	30°	76	3"	●	7514-7976-S48

HANDHELD AND SMALL HOLE DRILLING

FACEDRILLING AND BOLTING

BENCH DRILLING

LONG HOLE DRILLING

SHANK ADAPTERS



AUXILIARY TOOLS

GRINDING EQUIPMENT

INFORMATION AND BIT CLASSIFICATION GUIDE



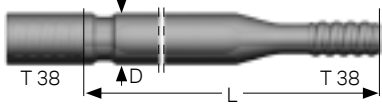
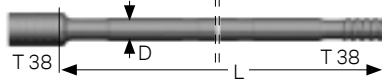
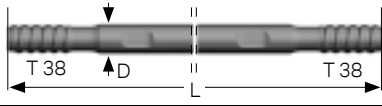
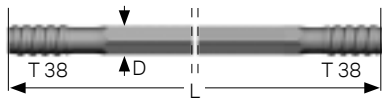

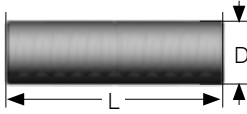





# BENCH DRILLING

## T38 (1 1/2")

RODS	DIMENSIONS						PART NO.
	Bit dia. mm	L mm	ft	in	D mm	in	
<b>Guide tube</b>							
	64-76	3660	12'	-	56	2 13/64"	7955-5637-20
Female end OD 56 mm.							
<b>MF-rod, T38 – round 39 – T38</b>							
	3050	10'	-	39	1 1/2"	7324-4731-70	
	3050	10'	-	39	1 1/2"	7324-4737-80	
	3660	12'	-	39	1 1/2"	7324-4737-70	
	3660	12'	-	39	1 1/2"	7324-4737-80	
	4265	14'	-	39	1 1/2"	7324-4743-70	
	4265	14'	-	39	1 1/2"	7324-4743-80	
Flushing hole Ø 14.5 mm. Female end OD 56 mm.							
<b>Extension rod, T38 – round 39 – T38</b>							
	3050	10'	-	39	1 1/2"	7324-4331C-30	
	3660	12'	-	39	1 1/2"	7324-4337C-30	
Flushing hole Ø 14.5 mm. Wrench flat 32 mm.							
<b>Light extension rod, T38 – Hex 32 – T38</b>							
	3050	10'	-	32	1 1/4"	7324-6931-20	
							
Flushing hole Ø 9.6 mm.							
<b>Coupling sleeve T38</b>							
	191	-	7 1/2"	55	2 5/32"	7314-3355	

# BENCH DRILLING

T45 (1 3/4")

BITS	FLUSHING HOLE, MM		BUTTONS, MM		ANGLE	DIMENSIONS D		BIT CLASSIFICATION	PART NO.
	Front No Size	Gauge No Size	Front No Size	Gauge No Size		mm	in		
<b>Button bit, regular skirt</b>									
	4x8	-	5x10	8x11	30°	70	2 3/4"	●	7515-1870-S48
	4x8	-	5x11	8x12	35°	76	3"	●	7515-1876-R48
	4x8	-	5x11	8x12	35°	76	3"	●	7515-1876-S48
	4x9	-	5x13	8x13	40°	89	3 1/2"	●	7515-1889-R48
	4x9	-	5x13	8x13	35°	89	3 1/2"	●	7515-1889-S48
	3x10	-	9x11	9x13	40°	102	4"	●	7515-1902-R48
	3x10	-	9x11	9x13	35°	102	4"	●	7515-1902-S48
	2x12	1x7.5	6x10	8x11	35°	76	3"	●	7515-2676A-S48
	3x10	1x7.5	6x10	9x11	35°	89	3 1/2"	●	7515-2689A-S48
	4x8	1x8	4x10	8x11	40°	76	3"	○	7515-5576A-C60
	3x10	1x10	2x11, 3x12	6x13	40°	89	3 1/2"	○	7515-5589A-C60
<b>Button bit, Retrac</b>									
	4x8	-	5x10	8x11	35°	70	2 3/4"	●	7515-4870-R48
	4x8	-	5x11	8x12	35°	76	3"	●	7515-4876-R48
	4x8	-	5x11	8x12	35°	76	3"	●	7515-4876-S48
	4x9	-	5x13	8x13	40°	89	3 1/2"	●	7515-4889-R48
	4x9	-	5x13	8x13	35°	89	3 1/2"	●	7515-4889-S48
	3x10	-	9x11	9x13	40°	102	4"	●	7515-4902-R48
	3x10	-	9x11	9x13	35°	102	4"	●	7515-4902-S48
	3x9	1x9	1x11, 3x11	6x12	40°	76	3"	○	7515-7576-C60
	3x10	1x10	2x11, 3x12	6x13	40°	89	3 1/2"	○	7515-7589A-C60
	2x11	1x6	6x10	8x11	35°	76	3"	●	7515-7876A-S48
	3x10	1x8	6x10	9x11	35°	89	3 1/2"	●	7515-7889A-S48
	4x9	-	3x11, 4x12	8x13	35°	102	4"	●	7515-7902-S48
	4x8	-	6x10	8x11	35°	76	3"	●	7515-7976-R48
	4x7	-	6x10	8x11	30°	76	3"	●	7515-7976-S48
	4x8	-	6x11	8x12	40°	89	3 1/2"	●	7515-7989-R48
	4x8	-	6x11	8x12	35°	89	3 1/2"	●	7515-7989-S48
	4x8	-	6x10	8x11	35°	76	3"	●	7515-8276-R48







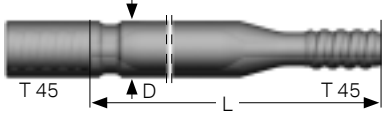
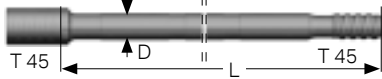
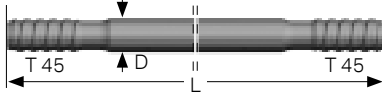
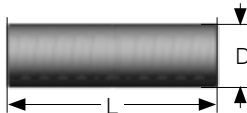

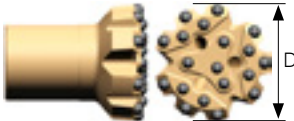

# BENCH DRILLING

## T45 (1 3/4")

RODS	DIMENSIONS						PART NO.
	Bit dia. mm	L mm	ft	in	D mm	in	
<b>Guide tube</b>							
	76-89	3660	12'	-	63	2 1/2"	7956-6337-70
	89-102	3660	12'	-	76	3"	7956-7637-70
Female end Ø 63 mm / 76 mm.							
<b>MF-rod, T45 – round 46 – T45</b>							
		3050	10'	-	46	1 1/2"	7325-7731-70
		3050	10'	-	46	1 1/2"	7325-7731-80
		3660	12'	-	46	1 1/2"	7325-7737-70
		3660	12'	-	46	1 1/2"	7325-7737-80
		4265	14'	-	46	1 1/2"	7325-7743-70
		4265	14'	-	46	1 1/2"	7325-7743-80
Flushing hole Ø 17 mm. Female end Ø 63 mm.							
<b>Extension rod, T45 – round 46 – T45</b>							
		3050	10'	-	46	1 3/4"	7325-7331C-30
		3660	12'	-	46	1 3/4"	7325-7337C-30
		4265	14'	-	46	1 3/4"	7325-7343C-30
Flushing hole Ø 17 mm.							
<b>Coupling sleeve T45</b>							
		210	-	8 1/8"	63	2 31/64"	7315-3663

# BENCH DRILLING

T51 (2")

BITS	FLUSHING HOLE, MM		BUTTONS, MM		ANGLE	DIMENSIONS D		BIT CLASSIFICATION	PART NO.
	Front No Size	Gauge No Size	Front No Size	Gauge No Size		mm	in		
<b>Button bit, regular skirt</b>									
	4×10	–	5×13	8×13	40°	89	3 1/2"	●	7516-1889-R48
	4×10	–	5×13	8×13	35°	89	3 1/2"	●	7516-1889-S48
	3×13	–	9×11	9×13	40°	102	4"	●	7516-1902-R48
	3×13	–	9×11	9×13	35°	102	4"	●	7516-1902-S48
	3×14	–	10×12	9×14	35°	115	4 1/2"	●	7516-1915-S48
	3×14	–	10×13	9×14	35°	127	5"	●	7516-1927-S48
	3×12	1×8	6×10	9×11	35°	89	3 1/2"	●	7516-2689A-S48
	3×12	1×8	6×12	9×12	35°	102	4"	●	7516-2602A-S48
	3×12	1×12	2×11, 3×12	6×13	40°	89	3 1/2"	○	7516-5589A-C60
	4×11	1×11	3×11, 4×12	8×13	40°	102	4"	○	7516-5502A-C60
<b>Button bit, Retrac</b>									
	4×10	–	5×13	8×13	40°	89	3 1/2"	●	7516-4889-R48
	4×10	–	5×13	8×13	35°	89	3 1/2"	●	7516-4889-S48
	3×13	–	9×11	9×13	40°	102	4"	●	7516-4902-R48
	3×13	–	9×11	9×13	35°	102	4"	●	7516-4902-S48
	3×14	–	10×12	9×14	40°	115	4 1/2"	●	7516-4915-R48
	3×14	–	10×12	9×14	35°	115	4 1/2"	●	7516-4915-S48
	3×14	–	10×13	9×14	35°	127	5"	●	7516-4927-S48
	3×12	1×12	2×11, 3×12	6×13	40°	89	3 1/2"	○	7516-7589A-C60
	3×11	1×11	3×11, 4×12	8×13	40°	102	4"	○	7516-7502A-C60
	3×12	1×8	6×10	9×11	35°	89	3 1/2"	●	7516-7889A-S48
	4×10	–	6×11	9×13	40°	102	3 1/2"	●	7516-7989-R48
	4×10	–	6×11	9×13	35°	102	3 1/2"	●	7516-7989-S48
	4×11	–	7×12	9×14	40°	115	4"	●	7516-7902-S48
	4×11	–	3×11, 4×12	8×13	40°	102	4"	●	7516-7902-R48
	4×10	–	3×12, 4×13	8×14	35°	115	4 1/2"	●	7516-7915-S48

HANDHELD AND SMALL HOLE DRILLING

FACEDRILLING AND BOLTING

BENCH DRILLING

LONG HOLE DRILLING

SHANK ADAPTERS

AUXILIARY TOOLS

GRINDING EQUIPMENT

INFORMATION AND BIT CLASSIFICATION GUIDE



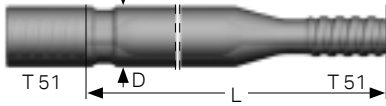
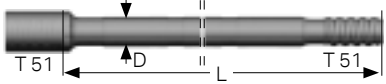
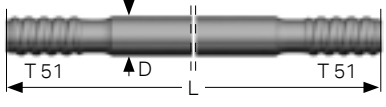
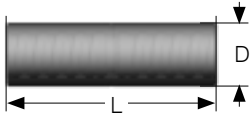

# BENCH DRILLING

## T51 (2")

RODS	DIMENSIONS						PART NO.
	Bit dia. mm	L mm	ft	in	D mm	in	
<b>Guide tube</b>							
	89-102	3660	12'	-	76	3"	7957-7637-70
	102-127	3660	12'	-	87	3 1/2"	7957-8737-70
Female end Ø 76 / 87 mm.							
<b>MF-rod, T51 – round 52 – T51</b>							
	3660	12'	-	52	2"	7326-5537-70	
	3660	12'	-	52	2"	7326-5537-80	
	4265	14'	-	52	2"	7326-5543-70	
	4265	14'	-	52	2"	7326-5543-80	
	5485	17'	11	52	2"	7326-5555-80	
	6095	20'	-	52	2"	7326-5561-70	
Flushing hole Ø 21,5 mm. Female end Ø 71 mm.							
<b>Extension rod, T51 – round 52 – T51</b>							
	3660	12'	-	52	2"	7326-5337C-30	
	4265	14'	-	52	2"	7326-5343C-30	
	6095	20'	-	52	2"	7326-5361C-30	
Flushing hole Ø 21.5 mm.							
<b>Coupling sleeve T51</b>							
	225	-	8 7/8"	71	2 51/64"	7316-3671	
	225	-	8 7/8"	76	3"	7316-3676	

# BENCH DRILLING

SANDVIK GT60

BITS	FLUSHING HOLE, MM		BUTTONS, MM		ANGLE	DIMENSIONS D		BIT CLASSIFICATION	PART NO.
	Front No Size	Gauge No Size	Front No Size	Gauge No Size		mm	in		
<b>Button bit, regular skirt</b>									
	4×11	–	6×12	8×14	35°	92	3 5/8"	●	7620-1892-S48
	4×11	–	6×12	8×14	35°	96	3 3/4"	●	7620-1896-S48
	3×14	–	9×11	9×13	35°	102	4"	●	7620-1902-S48
	3×14	–	10×12	9×14	40°	115	4 1/2"	●	7620-1915-R48
	3×14	–	10×12	9×14	35°	115	4 1/2"	●	7620-1915-S48
	3×14	–	10×14	9×16	35°	127	5"	●	7620-1927-S48
	3×14	–	10×14	9×16	35°	140	5 1/2"	●	7620-1940-S48
	3×14	–	12×14	9×16	35°	152	6"	●	7620-1952-S48
<b>Button bit, Retrac</b>									
	3×14	–	9×11	9×13	35°	102	4"	●	7620-4902-S48
	3×14	–	10×12	9×14	40°	115	4 1/2"	●	7620-4915-R48
	3×14	–	10×12	9×14	35°	115	4 1/2"	●	7620-4915-S48
	3×14	–	10×14	9×16	35°	127	5"	●	7620-4927-S48
	3×14	–	10×14	9×16	35°	140	5 1/2"	●	7620-4940-S48
	3×14	–	12×14	9×16	35°	152	6"	●	7620-4952-S48
	4×11	–	3×11, 4×12	8×13	35°	102	4"	●	7620-7902-S48
	4×11	–	3×12, 4×14	8×14	35°	115	4 1/2"	●	7620-7915-S48
	4×11	–	3×13, 4×14	8×14	35°	127	5"	●	7620-7927-S48
	4×12	–	4×14, 4×16	8×16	35°	140	5 1/2"	●	7620-7940-S48
	4×12	–	5×14, 4×16	8×16	35°	152	6"	●	7620-7952-S48
		2×14	–	9×12	9×12	40°	92	3 5/8"	●
2×14		–	9×12	9×12	35°	92	3 5/8"	●	7620-8792-S48
2×14		–	9×12	9×12	40°	96	3 3/4"	●	7620-8796-R48
2×14		–	9×12	9×12	35°	96	3 3/4"	●	7620-8796-S48
2×14		–	10×12	9×13	40°	102	4"	●	7620-8702-R48

HANDHELD AND SMALL HOLE DRILLING

FACEDRILLING AND BOLTING

BENCH DRILLING

LONG HOLE DRILLING

SHANK ADAPTERS

AUXILIARY TOOLS

GRINDING EQUIPMENT

INFORMATION AND BIT CLASSIFICATION GUIDE

# BENCH DRILLING

## SANDVIK GT60

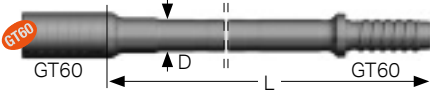
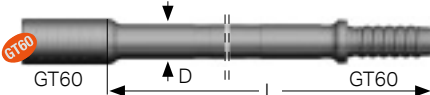
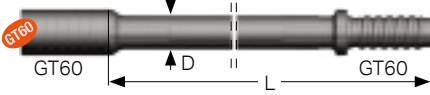
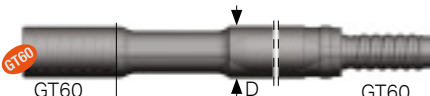
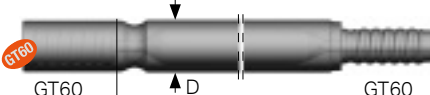
RODS	DIMENSIONS					PART NO.
	L mm	ft	in	D mm	in	
<b>MF-rod, GT60 – round 60 – GT60. For bits from 96 mm.</b>						
	3660	12'	–	60	2 3/8"	7610-1137-80
	4265	14'	–	60	2 3/8"	7610-1143-80
	5485	18'	–	60	2 3/8"	7610-1155-80
	6095	20'	–	60	2 3/8"	7610-1161-80
Female end Ø 85 mm. Flushing hole Ø 22.5 mm.						
	4265	14'	–	64	2 1/2"	7610-1243-80
	Female end Ø 85 mm. Flushing hole Ø 25 mm.					
<b>MF-rod, GT60 – round 60 – GT60. For 92–115 mm bits.</b>						
	4265	14'	–	60	2 3/8"	7610-1443-80
Female end Ø 82 mm. Flushing hole Ø 22.5 mm.						
<b>Pilot tube – GT60</b>						
	1600	5'	3'	87	3"	7640-8716-80
	4265	14'	–	87	3 1/2"	7640-8743-80
	5335	17'	6'	76	3"	7640-7653-80
Female end Ø 85 mm (82 mm on 76 mm tubes).						
<b>Drill tube</b>						
	4265	14'	–	87	3 1/2"	7660-8743-80
Always use with tube shank adapter 7600-6030-01 (HL1500, 1560) or 7600-6031-01 (HL1000, 1010).						











# THE POWER TO HANDLE ALL YOUR CHALLENGES

Production drilling is at the very heart of the mine. It is therefore critical that you choose products which can supply high levels of quality and reliability. Develop-

ments in underground mining are leading towards large-scale production with fewer sublevels, longer holes and more selective mining.

This naturally makes drilling accuracy more important than ever. Many factors can influence the straightness of the drill hole: rock and ore properties, the drilling method, the power and set-up of the drill rig, and the correct choice of drilling tools. In this context, a Sandvik MF rod string is a tolerant and forgiving tool system. In addition, it also delivers impressive hole straightness.

boosts your drilling performance by making operations simple and productivity secure at all times. In long-hole production drilling, the main advantage of our tube drilling system is the high rate of penetration: the straightness and quality of the drill-holes and the low total production cost.





With our unique in-house manufacturing facilities for producing, machining and tailoring steel, we are able to modify the metallurgical properties of all crucial Sandvik MF rod components. This is why all of our rod strings are given specific material characteristics in order to maximize wear, fatigue and corrosion resistance. Ultimately, this

Our hole diameters range between 76 and 115 mm. A correctly assembled tube string in a stable rig permits the accurate drilling of holes up to 60 meters. This is beneficial for your business. Hole deviation adversely affects profitability in the form of poor fragmentation, low ore recovery and ore dilution. Using our tools has been proven to reduce deviation by up to 40%.

R32 (1 1/4")	66
T35 (1 3/8")	68
T38 (1 1/2")	69
T45 (1 3/4")	71
T51 (2")	73
T45 (1 3/4") TUBE DRILLING TOOLS	75
ST58 (2 1/4") TUBE DRILLING TOOLS	76
ST68 (2 3/4") TUBE DRILLING TOOLS	77

# LONG HOLE DRILLING UNDERGROUND

R32 (1 1/4")

BITS	FLUSHING HOLE, MM		BUTTONS, MM		ANGLE	DIMENSIONS D		BIT CLASSIFICATION	PART NO.
	Front No Size	Gauge No Size	Front No Size	Gauge No Size		mm	in		
<b>Button bit, regular skirt</b>									
	3×6	1×6	3×9	6×10	40°	51	2"	●	7733-1651A-R48
	3×6	1×6	3×9	6×10	35°	51	2"	●	7733-1651A-S48
	3×6	1×6	3×10	6×11	35°	57	2 1/4"	●	7733-1657A-S48
	3×7	–	3×11	6×12	30°	64	2 1/2"	●	7733-1664-S48
	4×7	–	5×11	8×12	35°	76	3"	●	7733-1876-S48
	3×6	1×6	3×9	6×10	40°	51	2"	○	7733-5551A-C60
	3×6	1×6	3×10	6×10	40°	57	2 1/4"	○	7733-5557A-C60
	3×8	1×8	3×10	6×11	40°	64	2 1/2"	○	7733-5564A-C60
<b>Button bit, Retrac</b>									
	3×6	–	3×9	6×10	35°	51	2"	●	7733-4651-R48
	3×6	–	3×9	6×10	35°	51	2"	●	7733-4651-S48
	4×7	–	5×9	8×10	30°	64	3 1/2"	●	7733-4864-S48

# LONG HOLE DRILLING UNDERGROUND

R32 (1 1/4")

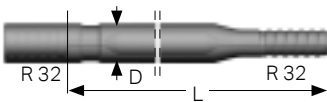
RODS	DIMENSIONS						PART NO.
	Bit dia.	L			D		
	mm	mm	ft	in	mm	in	
<b>Guide tube</b>							
	51-64	1830	6'	-	46	1 3/4"	7953-4618-20

Female end Ø 46 mm.

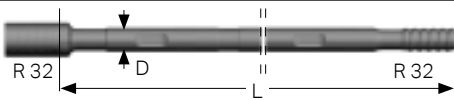
RODS	DIMENSIONS						PART NO.
	Bit dia.	L			D		
	mm	mm	ft	in	mm	in	
<b>MF-rod, R32 – round 32 – R32</b>							
		915	3'	-	32	1 1/4"	7853-5109-20
		1220	4'	-	32	1 1/4"	7853-5112-20
		1525	5'	-	32	1 1/4"	7853-5115-20
		1830	6'	-	32	1 1/4"	7853-5118-20

Flushing hole Ø 11.7 mm. Wrench flat 25.4 mm. Female end Ø 45 mm.

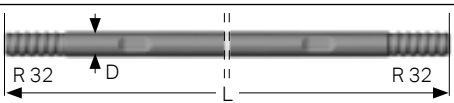
RODS	DIMENSIONS						PART NO.
	Bit dia.	L			D		
	mm	mm	ft	in	mm	in	
<b>Extension rod, R32 – round 32 – R32</b>							
		1220	4'	-	32	1 1/4"	7853-3312-20
		1525	5'	-	32	1 1/4"	7853-3315-20
		1830	6'	-	32	1 1/4"	7853-3318-20

Flushing hole Ø 11.7 mm. Wrench flat 25.4 mm.

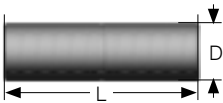
RODS	DIMENSIONS						PART NO.
	Bit dia.	L			D		
	mm	mm	ft	in	mm	in	
<b>Coupling sleeve R32</b>							
		150	-	5 29/32"	44	1 47/64"	7993-3644

PILOT ADAPTER	THREAD	DIMENSIONS				PART NO.	
		L			D		
		mm	ft	in	mm	in	
<b>Pilot adapter for reaming of 51 mm (2") pilot holes</b>							
	R32	-	-	-	47	1 7/8"	7823-3647

REAMING BIT	BUTTONS, MM	ANGLE	DIMENSIONS D		BIT CLASSIFICATION	PART NO.	
			Front No Size	Gauge No Size			mm
<b>Reaming bit</b>							
	4×12	8×12	35°	102	4"	-	7723-4802-S48
	4×12	8×12	35°	127	5"	-	7723-4827-S48

HANDHELD AND SMALL HOLE DRILLING

FACEDRILLING AND BOLTING

BENCH DRILLING

LONG HOLE DRILLING

SHANK ADAPTERS

AUXILIARY TOOLS

GRINDING EQUIPMENT

INFORMATION AND BIT CLASSIFICATION GUIDE



# LONG HOLE DRILLING UNDERGROUND

T35 (1 3/8")

BITS	FLUSHING HOLE, MM		BUTTONS, MM		ANGLE	DIMENSIONS D		BIT CLASSIFICATION	PART NO.
	Front No Size	Gauge No Size	Front No Size	Gauge No Size		mm	in		

**Button bit, regular skirt**



3×6	1×6	3×9	6×10	35°	54	2 1/8"	●	7517-1654A-S48
-----	-----	-----	------	-----	----	--------	---	----------------

**Button bit, Retrac**



3×6	-	3×9	6×10	35°	54	2 1/8"	●	7517-4654-R48
3×7	-	3×10	6×11	35°	57	2 1/4"	●	7517-4657-R48

**RODS**

**DIMENSIONS**

**PART NO.**



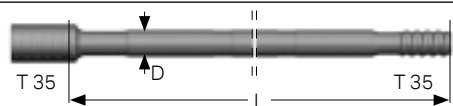





**MF-rod, T35 - Round 39 - T35**



L		D			PART NO.
mm	ft	in	mm	in	
1830	6'	-	39	1 1/2"	7327-4718-20

# LONG HOLE DRILLING UNDERGROUND

T38 (1 1/2")

BITS	FLUSHING HOLE, MM		BUTTONS, MM		ANGLE	DIMENSIONS D		BIT CLASSIFICATION	PART NO.
	Front No Size	Gauge No Size	Front No Size	Gauge No Size		mm	in		
<b>Button bit, regular skirt</b>									
	3x7	1x7	3x9	6x11	35°	54	2 1/8"	●	7514-1654A-R48
	3x8	-	3x11	6x12	35°	64	2 1/2"	●	7514-1664-R48
	3x8	-	3x11	6x12	30°	64	2 1/2"	●	7514-1664-S48
	4x8	-	5x10	8x11	30°	70	2 3/4"	●	7514-1870-S48
	4x8	-	5x11	8x11	40°	76	3"	●	7514-1876-R48
	4x8	-	5x11	8x12	35°	76	3"	●	7514-1876-S48
	4x9	-	5x12	8x12	35°	89	3 1/2"	●	7514-1889-S48
	2x11	1x6	4x10	8x10	30°	64	2 1/2"	●	7514-2664A-S48
	2x11	1x6	6x10	8x11	35°	76	3"	●	7514-2676A-S48
	3x8	1x8	3x10	6x11	40°	64	2 1/2"	○	7514-5564A-C60
	4x8	1x8	4x11	6x12	40°	76	3"	○	7514-5576A-C60
<b>Button bit, Retrac</b>									
	3x8	-	3x11	6x12	35°	64	2 1/2"	●	7514-4664-R48
	3x8	-	3x11	6x12	30°	64	2 1/2"	●	7514-4664-S48
	4x8	-	5x9	8x10	35°	64	2 1/2"	●	7514-4864-R48
	4x8	-	5x10	8x11	30°	70	2 3/4"	●	7514-4870-S48
	4x8	-	5x11	8x11	35°	76	3"	●	7514-4876-R48
	4x8	-	5x11	8x12	35°	76	3"	●	7514-4876-S48
	3x8	1x8	4x11	6x12	40°	76	3"	○	7514-7576A-C60
	2x10	1x6	4x10	8x10	30°	64	2 1/2"	●	7514-7864A-S48
	2x11	1x6	6x10	8x11	35°	76	3"	●	7514-7876A-S48
	3x8	-	4x9	6x10	40°	64	2 1/2"	●	7514-7964-R48
	3x8	-	4x9	6x10	35°	64	2 1/2"	●	7514-7964-S48
	4x8	-	6x10	8x11	35°	76	3"	●	7514-7976-R48
	4x7	-	6x10	8x11	30°	76	3"	●	7514-7976-S48
<b>Cross bit</b>									
	1x7.5	2x7.5	-	-	-	64	2 1/2"	-	7514-1464-11

HANDHELD AND SMALL HOLE DRILLING

FACEDRILLING AND BOLTING

BENCH DRILLING

LONG HOLE DRILLING

SHANK ADAPTERS

AUXILIARY TOOLS

GRINDING EQUIPMENT

INFORMATION AND BIT CLASSIFICATION GUIDE

# LONG HOLE DRILLING UNDERGROUND

## T38 (1 1/2")

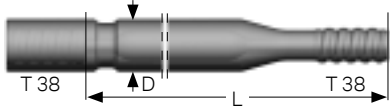
RODS	DIMENSIONS					PART NO.	
	Bit dia. mm	L mm	ft	in	D mm		in
<b>Guide tube</b> 	64-76	1830	6'	-	56	2 13/64"	7955-5618-20

Female end OD 56 mm.

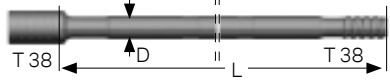
MF-rod, T38 – round 39 – T38	DIMENSIONS					PART NO.
	Bit dia. mm	L mm	ft	in	D mm	
	915	3'	-	39	1 1/2"	7324-4709C-20
	1220	4'	-	39	1 1/2"	7324-4712C-20
	1525	5'	-	39	1 1/2"	7324-4715C-20
	1830	6'	-	39	1 1/2"	7324-4718C-20







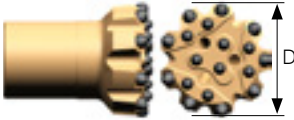

Flushing hole Ø 14.5 mm. Female end OD 56 mm.

PILOT ADAPTER	THREAD	DIMENSIONS				PART NO.	
		L mm	ft	in	D mm		in
<b>Pilot adapter for reaming of 51 mm (2") pilot holes</b> 	R38	-	-	-	47	1 7/8"	7823-2647

REAMER	BUTTONS, MM		ANGLE	DIMENSIONS D		BIT CLASSIFICATION	PART NO.
	Front No Size	Gauge No Size		mm	in		
<b>Reaming bit</b> 	4×12	8×12	35°	102	4"	-	7723-4802-S48
	4×12	8×12	35°	127	5"	-	7723-4827-S48

# LONG HOLE DRILLING UNDERGROUND

T45 (1 3/4")

BITS	FLUSHING HOLE, MM		BUTTONS, MM		ANGLE	DIMENSIONS D		BIT CLASSIFICATION	PART NO.
	Front No Size	Gauge No Size	Front No Size	Gauge No Size		mm	in		
<b>Button bit, regular skirt</b>									
	4x8	-	5x10	8x11	30°	70	2 3/4"	●	7515-1870-S48
	4x8	-	5x11	8x12	35°	76	3"	●	7515-1876-R48
	4x8	-	5x11	8x12	35°	76	3"	●	7515-1876-S48
	4x9	-	5x13	8x13	40°	89	3 1/2"	●	7515-1889-R48
	4x9	-	5x13	8x13	35°	89	3 1/2"	●	7515-1889-S48
	3x10	-	9x11	9x13	40°	102	4"	●	7515-1902-R48
	3x10	-	9x11	9x13	35°	102	4"	●	7515-1902-S48
	2x12	1x7.5	6x10	8x11	35°	76	3"	●	7515-2676A-S48
	3x10	1x7.5	6x10	9x11	35°	89	3 1/2"	●	7515-2689A-S48
	4x8	1x8	4x10	8x11	40°	76	3"	○	7515-5576A-C60
	3x10	1x10	2x11, 3x12	6x13	40°	89	3 1/2"	○	7515-5589A-C60
<b>Button bit, Retrac</b>									
	4x8	-	4x11	6x12	35°	70	2 3/4"	●	7515-4870-R48
	4x8	-	5x11	8x12	35°	76	3"	●	7515-4876-R48
	4x8	-	5x11	8x12	35°	76	3"	●	7515-4876-S48
	4x9	-	5x13	8x13	40°	89	3 1/2"	●	7515-4889-R48
	4x9	-	5x13	8x13	35°	89	3 1/2"	●	7515-4889-S48
	3x10	-	9x11	9x13	40°	102	4"	●	7515-4902-R48
	3x10	-	9x11	9x13	35°	102	4"	●	7515-4902-S48
	3x9	1x9	4x11, 3x11	6x12	40°	76	3"	○	7515-7576A-C60
	3x10	1x10	2x11, 3x12	6x13	40°	89	3 1/2"	○	7515-7589A-C60
	2x11	1x6	6x10	8x11	35°	76	3"	●	7515-7876A-S48
	3x10	1x8	6x10	9x11	35°	89	3 1/2"	●	7515-7889A-S48
	4x8	-	6x10	8x11	35°	76	3"	●	7515-8276-R48
	4x9	-	3x11, 4x12	8x13	35°	102	4"	●	7515-7902-S48
	4x8	-	6x10	8x11	35°	76	3"	●	7515-7976-R48
	4x7	-	6x10	8x11	30°	76	3"	●	7515-7976-S48
	4x8	-	6x11	8x12	40°	89	3 1/2"	●	7515-7989-R48
	4x8	-	6x11	8x12	35°	89	3 1/2"	●	7515-7989-S48

HANDHELD AND SMALL HOLE DRILLING

FACEDRILLING AND BOLTING

BENCH DRILLING

LONG HOLE DRILLING

SHANK ADAPTERS

AUXILIARY TOOLS

GRINDING EQUIPMENT

INFORMATION AND BIT CLASSIFICATION GUIDE

# LONG HOLE DRILLING UNDERGROUND

T45 (1 3/4")

BITS	FLUSHING HOLE, MM		BUTTONS, MM		ANGLE	DIMENSIONS D		BIT CLASSIFICATION	PART NO.
	Front No Size	Gauge No Size	Front No Size	Gauge No Size		mm	in		
			3×14	9×14	35°	127	5"	–	7515-5627-S48
			7×14	8×14	35°	152	6"	–	7515-5652-S48

Pilot diameter: 64 mm

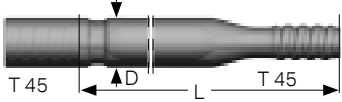
RODS	DIMENSIONS						PART NO.
	Bit dia. mm	L mm	ft	in	D mm	in	
	76-89	1830	6'	–	63	2 31/64"	7956-6318-21

Female end Ø 63 mm.

MF-rod, T45 – round 46 – T45

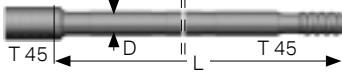





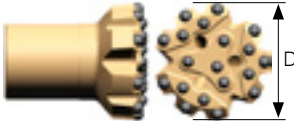

		1220	4'	–	46	1 3/4"	7325-7712C-20
		1525	5'	–	46	1 3/4"	7325-7715C-20
		1830	6'	–	46	1 3/4"	7325-7718C-20

Flushing hole Ø 17 mm. Female end Ø 63 mm.



# LONG HOLE DRILLING UNDERGROUND

T51 (2")

BITS	FLUSHING HOLE, MM		BUTTONS, MM		ANGLE	DIMENSIONS D		BIT CLASSIFICATION	PART NO.
	Front No Size	Gauge No Size	Front No Size	Gauge No Size		mm	in		
<b>Button bit, regular skirt</b>									
	4x10	-	5x13	8x13	40°	89	3 1/2"	●	7516-1889-R48
	4x10	-	5x13	8x13	35°	89	3 1/2"	●	7516-1889-S48
	3x13	-	9x11	9x13	40°	102	4"	●	7516-1902-R48
	3x13	-	9x11	9x13	35°	102	4"	●	7516-1902-S48
	3x14	-	10x12	9x14	35°	115	4 1/2"	●	7516-1915-S48
	3x14	-	10x13	9x14	35°	127	5"	●	7516-1927-S48
	3x12	1x8	6x10	9x11	35°	89	3 1/2"	●	7516-2689A-S48
	3x12	1x8	6x12	9x12	35°	102	4"	●	7516-2602A-S48
	3x12	1x12	2x11, 3x12	6x13	40°	89	3 1/2"	○	7516-5589A-C60
	4x11	1x11	3x11, 4x12	8x13	40°	102	4"	○	7516-5502A-C60
<b>Button bit, Retrac</b>									
	4x10	-	5x13	8x13	40°	89	3 1/2"	●	7516-4889-R48
	4x10	-	5x13	8x13	35°	89	3 1/2"	●	7516-4889-S48
	3x13	-	9x11	9x13	40°	102	4"	●	7516-4902-R48
	3x13	-	9x11	9x13	35°	102	4"	●	7516-4902-S48
	3x14	-	10x12	9x14	40°	115	4 1/2"	●	7516-4915-R48
	3x14	-	10x12	9x14	35°	115	4 1/2"	●	7516-4915-S48
	3x14	-	10x13	9x14	35°	127	5"	●	7516-4927-S48
	3x12	1x12	2x11, 3x12	6x13	40°	89	3 1/2"	○	7516-7589A-C60
	3x11	1x11	3x11, 4x12	8x13	40°	102	4"	○	7516-7502A-C60
	3x12	1x8	6x10	9x11	35°	89	3 1/2"	●	7516-7889A-S48
	4x10	-	6x11	9x13	40°	102	3 1/2"	●	7516-7989-R48
	4x10	-	6x11	9x13	35°	102	3 1/2"	●	7516-7989-S48
	4x11	-	7x12	9x14	40°	115	4"	●	7516-7902-S48
	4x11	-	3x11, 4x12	8x13	40°	102	4"	●	7516-7902-R48
	4x10	-	3x12, 4x13	8x14	35°	115	4 1/2"	●	7516-7915-S48
<b>Reaming bit</b>									
			7x14	8x14	35°	152	6"	-	7516-5652-S48

Pilot diameter: 64 mm.

# LONG HOLE DRILLING UNDERGROUND

## T51 (2")

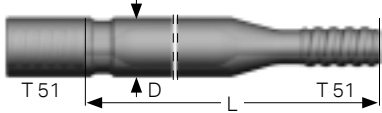
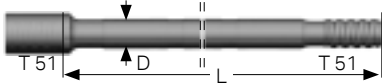
RODS	DIMENSIONS						PART NO.
	Bit dia. mm	L mm	ft	in	D mm	in	
<b>Guide tube</b>							
	89-102	1830	6'	-	76	3"	7957-7618-20
Female end Ø 76 mm.							
<b>MF-rod, T51 – round 52 – T51</b>							
		1525	5'	-	52	2"	7326-5515C-20
		1830	6'	-	52	2"	7326-5518C-20
Flushing hole Ø 21.5 mm. Female end Ø 71 mm.							

# LONG HOLE DRILLING UNDERGROUND

## T45 (1 3/4") TUBE DRILLING TOOLS

BITS	FLUSHING HOLE, MM		BUTTONS, MM		ANGLE	DIMENSIONS D		BIT CLASSIFICATION	PART NO.
	Front No Size	Gauge No Size	Front No Size	Gauge No Size		mm	in		
XDC, button bit	4x7.5	-	6x10	8x11	35°	76	3"	●	7525-8476-R65



TUBES	DIMENSIONS					PART NO.
	L mm	ft	in	D mm	in	
Drill tube, T45 – Round 65 – T45	1525	5'	-	65	2 1/2"	7985-6315-26
	1830	6'	-	65	2 1/2"	7985-6318-26

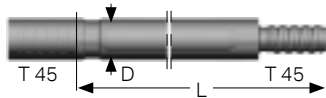

Flushing hole Ø 18 mm.

HANDHELD AND SMALL HOLE DRILLING

FACEDRILLING AND BOLTING

BENCH DRILLING

LONG HOLE DRILLING

SHANK ADAPTERS





AUXILIARY TOOLS

GRINDING EQUIPMENT

INFORMATION AND BIT CLASSIFICATION GUIDE

# LONG HOLE DRILLING UNDERGROUND

## ST58 (2 1/4") TUBE DRILLING TOOLS

BITS	FLUSHING HOLE, MM		BUTTONS, MM		ANGLE	DIMENSIONS D		BIT CLASSIFICATION	PART NO.
	Front No Size	Gauge No Size	Front No Size	Gauge No Size		mm	in		
<b>XDC, button bit</b>									
	4x10	-	6x12	8x12	35°	89	3 1/2"	●	7528-8489-R65
<b>XDC, button bit, guide retrac</b>									
	4x10	-	6x12	8x12	35°	89	3 1/2"	●	7528-7389-R65
<b>Button bit, Heavy Duty</b>									
	2x15	-	6x12	8x14	35°	89	3 1/2"	●	7528-6989-S65
<b>Reaming bit</b>									
			7x14	8x14	35°	152	6"	-	7528-5652-S65



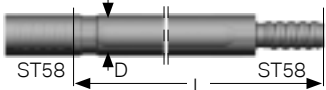

Pilot diameter 76 mm.

TUBES	DIMENSIONS					PART NO.
	L mm	L ft	in	D mm	in	
<b>Drill tube, ST58 – Round 76 – ST58</b>						
	1525	5'	-	76	3"	7378-7615-26
	1830	6'	-	76	3"	7378-7618-26

Flushing hole Ø 26 mm.

# LONG HOLE DRILLING UNDERGROUND

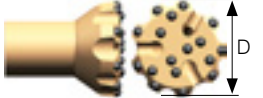
## ST68 (2 3/4") TUBE DRILLING TOOLS

BITS	FLUSHING HOLE, MM		BUTTONS, MM		ANGLE	DIMENSIONS D		BIT CLASSIFICATION	PART NO.
	Front No Size	Gauge No Size	Front No Size	Gauge No Size		mm	in		
<b>XDC, button bit</b> 	4×10	–	8×12	10×12	35°	102	4"	●	7529-8402-R65
	4×10	–	8×14	10×14	35°	115	4 1/2"	●	7529-8415-R65
<b>Button bit, Heavy Duty</b> 	2×15	–	5×14	8×16	35°	102	4"	●	7529-6902-S65
<b>XDC, button bit, guide retrac</b> 	4×10	–	8×12	10×12	35°	102	4"	●	7529-7302-R65
	4×10	–	8×14	10×14	35°	115	4 1/2"	●	7529-7315-R65
<b>Collaring bit</b> 	3×18	–	8×16	9×16	35°	152	6"	●	7529-6652-S48
<b>Reaming bit</b> 			3×16	9×16	35°	152	6"	–	7529-5652-S65
			4×14	16×14	35	204	8"	–	7529-5604A-S65

Pilot diameter 95 mm 7529-5652-S65.  
 Pilot diameter 137 mm 7529-5604A-S65.

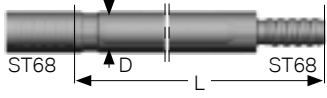
TUBES	DIMENSIONS					PART NO.
	L mm	ft	in	D mm	in	
<b>Drill tube, ST68 – Round 87 – ST68</b> 	1525	5'	–	87	3 1/2"	7379-8715-26
	1525	5'	–	87	3 1/2"	7379-8715-46 !
	1830	6'	–	87	3 1/2"	7379-8718-26
	1830	6'	–	87	3 1/2"	7379-8718-46 !

Flushing hole Ø 30 mm.

! Permanent back flow valve.



Internal flushing shank adapters use a water tube inside the rock drill. The tube fits into the end of the shank adapter and is sealed with an O-ring. This allows water to transfer from the rock drill to the shank adapter, which in turn allows it flow through the rest of the drill string.



Shank adapters with external flushing can be identified by machined slots in the center of the adapter. These slots are positioned between seals inside the flushing housing/head of the rock drill.



Hydraulic shanks generally have at least a 5 to 14-spline configuration. Pneumatic shanks tend to have internal or through-flushing. They can be identified by their lugs or 4-spline configuration.



# RELIABLE PERFORMANCE WHILE LOWERING COSTS

While every component in the drill string is crucial, the shank adapter must be engineered to transmit impact energy from the rock-drill piston – along with rotation torque – into the drill string with no losses. It must withstand and transmit up to 6300 blows per minute from the piston continually, and do so with great endurance and dependability.

With this in mind, we manufacture premium quality shank adapters for most brands of rock drills. We have yet more specially developed products that are not featured in this catalogue. Please visit our website or contact us directly to find out more, and to order the shank adapter that you need.

HEXAGONAL SHANK ADAPTERS	80
SANDVIK	81
ATLAS COPCO	86
BOART	89
FURUKAWA	90
GARDNER-DENVER, INGERSOLL-RAND & KLEMM	91
MONTABERT	92
SIG	93

# SHANK ADAPTERS

## HEXAGONAL SHANK ADAPTERS

	FLUSHING TUBE (MM)	THREAD	LENGTH (MM)	PART NO.
<b>For hexagonal bushing 22 × 108 mm</b>				
	4.5-5.0	R22	255	7801-6103-11
	4.5-5.0	R23	255	7807-6103-11
	4.5-5.0	R25	255	7802-6103-11
<b>For hexagonal bushing 25 × 108 mm</b>				
	4.5-5.0	R23	255	7807-7103-30
	4.5-5.0	R25	255	7802-7103-14
<b>For hexagonal bushing 25 × 159 mm</b>				
	8	R25	255	7802-7103-21

No packing. Not suitable for hydraulic machines with water flushing.

# SHANK ADAPTERS

SANDVIK

	APPLICATION	FLUSHING HOLE (MM)	THREAD	LENGTH (MM)	PART NO.
<b>HLX 1</b>					
	TU, BO	-	R23	235	7807-7570-01
	TU, BO	-	R25	255	7802-7567-01
	TU, BO	-	R23	255	7807-7567-01
	TU, BO	-	R28	255	7809-7567-01
<b>HL 300</b>					
	BE	-	R32	400	7803-7549-01
<b>HL 300S</b>					
	BO, TU	-	R32	245	7803-7547-01
<b>RD308/RD314/RD414</b>					
	UG	-	R32	205	7803-7663-01
	UG	-	T38	410	7304-7672-01
	UG	-	T35	410	7307-7672-01
	UG	-	R32	410	7803-7672-01
<b>L400, L410, L500, L510, L550</b>					
	BO, PD, TU	10	R32	380	7803-3602-30
<b>HLR 438L and HLR 438T</b>					
	BE, TU	12.7	R32	380	7803-4700-50
	BE, TU	12.7	T38	400	7304-4700-50
<b>HLR 438LS, 438TS, HL 538, HL538L, L550S</b>					
	BE, PD, TU	-	R32	450	7803-4700-01
	TU	-	R38	450	7804-4700-01
	BE, PD, TU	-	T38	455	7304-4700-01

! S = For underground drilling, T = Drill with stabilizer

HANDHELD AND SMALL HOLE DRILLING

FACEDRILLING AND BOLTING

BENCH DRILLING

LONG HOLE DRILLING

SHANK ADAPTERS

AUXILIARY TOOLS

GRINDING EQUIPMENT

INFORMATION AND BIT CLASSIFICATION GUIDE

# SHANK ADAPTERS

SANDVIK

	APPLICATION	FLUSHING HOLE (MM)	THREAD	LENGTH (MM)	PART NO.
<b>HLR 438LS, HL500-38/HL510-38, HL538L, L550S</b>					
	BE	-	R32	550	7803-7535-02
	BE	-	T35	550	7307-7535-02
	BE	-	T38	550	7304-7535-02
	BE	-	R38	550	7804-7535-02
<b>HL 500-45 / HL510-45</b>					
	BE	-	R32	550	7803-7557-01
	BE	-	T35	550	7307-7557-01
	BE	-	T38	550	7304-7557-01
	BE	-	T45	550	7305-7557-01
<b>HL 500 S-38 / 510 S-38 / 510 B / 510 LH</b>					
	PD, TU	-	R32	460	7803-7531-01
	TU	-	R38	460	7804-7531-01
	PD, TU	-	T38	460	7304-7531-01
	TU	-	R38	500	7804-7536-01
	PD, TU	-	T38	500	7304-7536-01
<b>HL 550 SUPER / HL560 SUPER / HL510 S-45</b>					
	TU	-	T35	460	7307-7566-01
	PD, TU	-	T35	550	7307-7557-01
	TU	-	R38	500	7804-7554-01
	TU	-	T38	500	7304-7554-01
<b>HLX 5 / HLX 5T</b>					
	TU	-	R32	500	7803-7585-01
	TU	-	T35	500	7307-7585-01
	TU	-	T38	500	7304-7585-01
	TU	-	R38	500	7804-7585-01
	BE	-	R32	575	7803-7586-01
	BE	-	T35	575	7307-7586-01
	BE	-	T38	575	7304-7586-01
	BE	-	T45	575	7305-7586-01
<b>HLX 5T</b>					
	TU	-	T38	720	7304-7668-01
	TU	-	T35	720	7307-7668-01
<b>HLX5 PE-45</b>					
	TU	-	R32	575	7803-7664-01
	TU	-	T38	575	7304-7664-01
	TU	-	T38	720	7304-7671-01
	TU	-	T35	720	7307-7671-01

! PE = For Power Extractor rock drill, S = For underground drilling, T = Drill with stabilizer

# SHANK ADAPTERS

SANDVIK

	APPLICATION	FLUSHING HOLE (MM)	THREAD	LENGTH (MM)	PART NO.
<b>RD520/RD525 – PE</b>					
	TU	–	T38	745	7304-7673-01
	TU	–	T35	745	7307-7673-01
<b>RD520/RD525</b>					
	TU	–	T38	525	7304-7669-01
	TU	–	T38	600	7304-7666-01
	TU	–	T35	600	7307-7666-01
	TU	–	T38	745	7304-7685-01
	TU	–	T35	745	7307-7685-01
<b>RD1635CF</b>					
	TU	–	GT60	760	7600-6025-12
	TU	–	GT60	760	7600-6030-15
<b>RD1635CF-80</b>					
	TU	–	ST68	630	7329-6034-15
<b>HL 600-45 / HL 600 S-45</b>					
	BE	–	T38	600	7304-7532-01
	Tubes, BE	–	T45	600	7305-7532-01
	TU, PD	–	T38	525	7304-7537-01
	TU, PD	–	T45	525	7305-7537-01
<b>HL 600-52</b>					
	BE	–	T45	650	7305-7551-01
	BE	–	T51	650	7306-7551-02
<b>HL 645</b>					
	BE	–	T45	600	7305-7541-02
<b>HL700/HL710-45/HL800T-45/HL810T-45/HF810T-45/HL650-45</b>					
	BE	–	T38	600	7304-7576-01
	BE	–	T45	600	7305-7576-01

**i** PE = For Power Extractor rock drill, S = For underground drilling, T = Drill with stabilizer

HANDHELD AND SMALL HOLE DRILLING

FACEDRILLING AND BOLTING

BENCH DRILLING

LONG HOLE DRILLING

SHANK ADAPTERS

AUXILIARY TOOLS

GRINDING EQUIPMENT

INFORMATION AND BIT CLASSIFICATION GUIDE

# SHANK ADAPTERS

SANDVIK

	APPLICATION	FLUSHING HOLE (MM)	THREAD	LENGTH (MM)	PART NO.	
	HL700/HL710-52/HL710PE-52/HL700LH/HL710S-52/HL710SPE-52/T45/HL650-52/HL800T-52/HL800T/PE-52/HL810T-52/HF810T-52	BE, PD	-	T38	600	7304-7577-02
		BE	-	T45	600	7305-7577-02
		BE	-	T51	600	7306-7577-03
	HL1000/HL 1010, HL1000S/HL 1010S-52	BE	-	T45	670	7305-6010-01
		BE	-	T51	670	7306-6010-02
		PD	-	T45	590	7305-6008-01
		PD	-	T51	590	7306-6008-01
	HL 1000-60/HL 1010-60	BE	-	T51	670	7306-6014-02
		BE	-	GT60	670	7600-6014-02
	HL 1000-80/HL 1010-80, Shoulder drive	BE	-	GT60	760	7600-6031-01
	HL1000/HL 1000S-80, HL1000-80/HL1010-80	PD	-	ST58	635	7328-6009-02
		PD	-	ST68	640	7329-6009-02
	HL1000PE-65, HL1010PE-65, HL1060T/PE-65, HL1500T/PE-65, HL1560T/PE-65	BE	-	T51	760	7306-6025-02
		BE	-	GT60	760	7600-6025-02
		BE	-	ST58	760	7358-6025-02
	HL1000/1500PE/1560HF	BE	-	GT60	670	7600-6025-05
	HL 1500-52/1500 T-52	BE	-	T51	710	7306-6021-02
	HL 1500-60/1500 T-60	BE	-	T51	760	7306-6022-02
		BE	-	GT60	760	7600-6022-03

! PE = For Power Extractor rock drill, S = For underground drilling, T = Drill with stabilizer



# SHANK ADAPTERS

SANDVIK

	APPLICATION	FLUSHING HOLE (MM)	THREAD	LENGTH (MM)	PART NO.
<b>HL 1500-80/1560T-80/HL1060T-80/HF1560, Shoulder drive</b>					
	BE	-	GT60	760	7600-6030-05
	BE	-	ST68	630	7329-6034-05
	PD	-	ST58	635	7328-6020-01
	PD	-	ST68	635	7329-6020-05
<b>HL 1500T/PE-90/HL1500ST/PE-90/ HL1560T/PE-90/HL1560ST/PE-90</b>					
	PD	-	ST58	635	7328-6035-01
	PD	-	ST68	635	7329-6035-05
	BE	-	GT60	760	7600-6032-05
<b>Hydrastar 200</b>					
	TU, BO	-	R32	351	7803-4703-01
<b>Hydrastar 200, 300 and X2</b>					
	TU	-	R32	485	7803-3590-03
	TU	-	R38	485	7804-3590-03
	TU	-	T38	485	7304-3590-03
<b>Hydrastar 350</b>					
	TU	-	R38	485	7804-3590-03
	BE	-	T38	500	7304-3591-01
<b>Toyo PR 220</b>					
	BE	14	R32	330	7803-7500-61
	BE	14	T38	446	7304-7500-60
<b>Toyo TH 501</b>					
	BE	11	T38	565	7304-7583-40
<b>Toyo TH800RP</b>					
	BE	-	T38	766	7304-7588-01

! PE = For Power Extractor rock drill, S = For underground drilling, T = Drill with stabilizer

HANDHELD AND SMALL HOLE DRILLING

FACEDRILLING AND BOLTING

BENCH DRILLING

LONG HOLE DRILLING

SHANK ADAPTERS

AUXILIARY TOOLS

GRINDING EQUIPMENT

INFORMATION AND BIT CLASSIFICATION GUIDE

# SHANK ADAPTERS

ATLAS COPCO

	APPLICATION	FLUSHING HOLE (MM)	THREAD	LENGTH (MM)	PART NO.
<b>Atlas Copco BBC 43, 44, 45 and 100</b> 	TU	10	R32	380	7803-3100-30
<b>Atlas Copco COP 1032 HD</b> 	TU, BO	-	R32	340	7803-3588-01
<b>Atlas Copco COP 1032 LE</b> 	BE, DS	-	R32	550	7803-3576-01
<b>Atlas Copco COP 1036/1038 HB</b> 	BE	-	T38	500	7304-3591-01
	BE	-	T45	500	7305-3591-01
<b>Atlas Copco COP 1038 HD/1238</b> 	TU	-	R32	485	7803-3590-03
	TU	-	R38	485	7804-3590-03
	TU	-	T38	485	7304-3590-03
<b>Atlas Copco COP 1038 HL</b> 	BE, PD	-	T38	575	7304-3593-01
	BE, PD	-	T45	575	7305-3593-01
<b>Atlas Copco COP 1132</b> 	PD	-	R32	410	7803-3581-02
	PD	-	R32	500	7803-3583-02

# SHANK ADAPTERS

ATLAS COPCO

	APPLICATION	FLUSHING HOLE (MM)	THREAD	LENGTH (MM)	PART NO.
<b>Atlas Copco COP 1238</b>					
	BE	-	T38	500	7304-3591-01
	TU	-	R38	485	7804-3590-03
	TU	-	T38	485	7304-3590-03
	BE	-	T45	500	7305-3591-01
	BE, PD	-	T38	575	7304-3593-01
	BE, PD	-	T38	575	7304-3550-01
	BE, PD	-	T45	575	7305-3593-01
<b>Atlas Copco COP 1432, COP 1532, COP 1440, COP 1838 HD/ME</b>					
	TU	-	R38	435	7804-3652-01
	TU	-	T35	435	7307-3652-01
	TU	-	T38	435	7304-3652-01
	TU	-	R32	435	7803-3652-01
	BO	-	R32	525	7803-3656-02
	BE	-	T35	525	7307-3656-01
	BO	-	T38	525	7304-3656-01
<b>Atlas Copco COP 1550, COP 1838 ME/ HE</b>					
	BE, PD	-	T38	525	7304-3655-01
	BE, PD	-	T45	525	7305-3655-01
	BE, PD	-	T51	525	7306-3655-02
<b>Atlas Copco COP 1550 EX, COP 1838 EX</b>					
	BE	-	T38	730	7304-3825-02
	BE	-	T45	730	7305-3826-02
<b>Atlas Copco COP 1838MUX/HUX</b>					
	BE, PD	-	T38	730	7304-3663-01
	BE, PD	-	T45	730	7305-3663-01

HANDHELD AND SMALL HOLE DRILLING

FACEDRILLING AND BOLTING

BENCH DRILLING

LONG HOLE DRILLING

SHANK ADAPTERS







AUXILIARY TOOLS

GRINDING EQUIPMENT

INFORMATION AND BIT CLASSIFICATION GUIDE

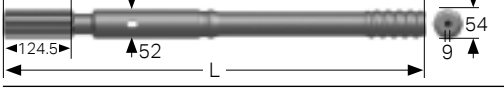
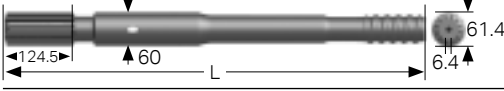
# SHANK ADAPTERS

ATLAS COPCO

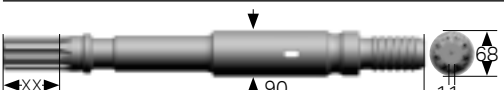
	APPLICATION	FLUSHING HOLE (MM)	THREAD	LENGTH (MM)	PART NO.
<b>Atlas Copco COP 1840 HE, COP 1850</b>					
	BE, PD	-	T35	565	7307-3690-01
	BE, PD	-	T38	565	7304-3690-02
	BE, PD	-	T45	565	7305-3690-02
	BE, PD	-	T51	565	7306-3690-03
<b>Atlas Copco COP 1850 SPEC</b>					
	BE, PD	-	T51	565	7306-3691-01
<b>Atlas Copco COP 2150, COP 2550</b>					
	BE	-	T51	770	7306-3692-01
<b>Atlas Copco COP 2160, COP 2560</b>					
	BE	-	T51	770	7306-3689-01
	BE	-	GT60	770	7600-3689-01
<b>Atlas Copco COP 2160EX/2560EX</b>					
	BE	-	T51	770	7306-3699-01
	BE	-	GT60	770	7600-3699-01
<b>Atlas Copco COP 3038</b>					
	TU	-	T45	435	7305-3667-01
	TU, PD	-	T35	525	7307-3671-01
<b>Atlas Copco COP 4050 ME</b>					
	PD	-	GT60	700	7600-3712-01
<b>Atlas Copco COP 4050 MUX</b>					
	PD	-	ST68	835	7329-3720-01
	PD	-	ST58	835	7328-3720-01

# SHANK ADAPTERS

## BOART

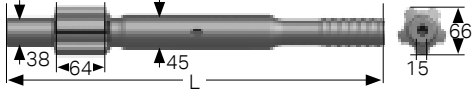
	APPLICATION	FLUSHING HOLE (MM)	THREAD	LENGTH (MM)	PART NO.
<b>Boart HD 125, HD 150, HD 160</b>					
	TU	-	R38	495	7804-4993-01
	TU	-	T38	495	7304-4993-01

HANDHELD AND SMALL HOLE DRILLING

FACEDRILLING AND BOLTING

BENCH DRILLING

LONG HOLE DRILLING

SHANK ADAPTERS

AUXILIARY TOOLS

GRINDING EQUIPMENT

INFORMATION AND BIT CLASSIFICATION GUIDE

# SHANK ADAPTERS

FURUKAWA

	APPLICATION	FLUSHING HOLE (MM)	THREAD	LENGTH (MM)	PART NO.
<b>Furukawa M 120 and PD 200</b>					
	BE	14	R32	330	7803-7500-61
	BE	14	T38	380	7304-7543-60
	BE	14	T38	446	7304-7500-60
<b>Furukawa PD 200R</b>					
	BE	14	T38	484	7304-7581-60
<b>Furukawa HD 609</b>					
	BE	-	T38	620	7304-4791-01
	BE	-	T38	690	7304-4780-01
	BE	-	T45	620	7305-4791-01
<b>Furukawa HD 612</b>					
	BE	-	T45	710	7305-7414-01
<b>Furukawa HD 709</b>					
	BE	-	T38	620	7304-7426-01
<b>Furukawa HD 712</b>					
	BE	-	T45	788	7305-7417-01
<b>Furukawa HD 715 RP</b>					
	BE	-	T35	885	7306-7424-01



# SHANK ADAPTERS

GARDNER-DENVER, INGERSOLL-RAND AND KLEMM

	APPLICATION	FLUSHING HOLE (MM)	THREAD	LENGTH (MM)	PART NO.
<b>Gardner-Denver PR 123</b>					
	TU, BE	14	R32	330	7803-7500-61
	TU, BE	14	R32	380	7803-7543-60
	TU, BE	14	T38	446	7304-7500-60
	TU, BE	14	T38	380	7304-7543-60
<b>Gardner-Denver HPR1H</b>					
	TU, BE	-	T45	745	7305-4883-01
<b>Gardner-Denver HPR2</b>					
	TU, BE	-	T51	916	7306-4885-02
<b>Ingersoll-Rand URD 475, URD 550, VL120, EVL 130, VL140 and F16</b>					
	BE	14	R32	330	7803-7500-61
	BE	14	R32	380	7803-7543-60
	BE	14	T38	380	7304-7543-60
	BE	14	T38	446	7304-7500-60
<b>Ingersoll-Rand YH 65, YH 80</b>					
	BE	19	T38	495	7304-7525-19
	BE	19	T45	500	7305-7525-19
<b>Ingersoll-Rand YH 80 A</b>					
	BE	19	T45	495	7305-7559-19
<b>Ingersoll-Rand YH 65 RP, YH 70 RP, YH 75 RP, YH 80 RP</b>					
	BE	19	T45	700	7305-7546-19
<b>Klemm 4053</b>					
	BE	-	R55	500	7805-6015 <sup>1)</sup> !
	BE	-	R55	500	7805-7015 <sup>2)</sup> !

! <sup>1)</sup> LH-Rotation  
<sup>2)</sup> RH-Rotation

HANDHELD AND SMALL HOLE DRILLING

FACEDRILLING AND BOLTING

BENCH DRILLING

LONG HOLE DRILLING

SHANK ADAPTERS





AUXILIARY TOOLS

GRINDING EQUIPMENT

INFORMATION AND BIT CLASSIFICATION GUIDE

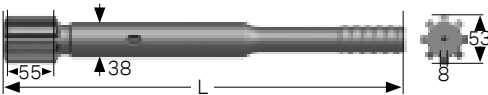
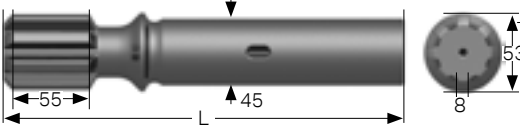
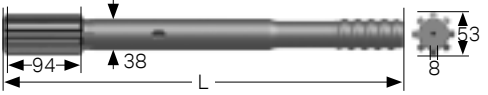
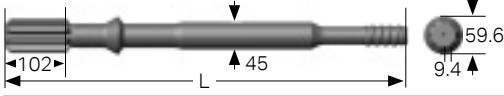
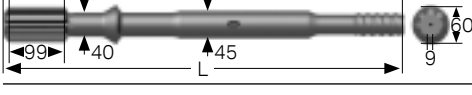
# SHANK ADAPTERS

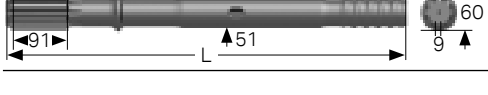
MONTABERT

	APPLICATION	FLUSHING HOLE (MM)	THREAD	LENGTH (MM)	PART NO.
<b>Montabert HC 40</b>					
	BE	-	R32	447	7803-4725-01
	BE	-	T38	447	7304-4725-01
<b>Montabert HC 40 (female)</b>					
	TU, BO	-	R32	270	7803-4726-01
<b>Montabert HC 80, HC 90, HC 105</b>					
	TU	-	R38	440	7804-4720-01
	TU	-	T38	440	7304-4720-01
	TU	-	R32	440	7803-4720-01
<b>Montabert HC 80R, HC 120R, HC 110RP</b>					
	BE	-	T35	670	7307-7544-01
<b>Montabert HC 80R, HC 105R, HC 107R, HC 108R, HC 109R</b>					
	BE	-	T38	670	7304-7544-01
<b>Montabert HC 80, HC 120</b>					
	BE	-	T45	490	7305-7520-01
<b>Montabert HC 120R, HC 150R, HC 155R, HC 158R</b>					
	BE	-	T51	670	7306-7528-02
<b>Montabert HC 200A</b>					
	BE	-	T51	840	7306-7530-02
	BE	-	GT60	840	7600-7530-02

# SHANK ADAPTERS

SIG

	APPLICATION	FLUSHING HOLE (MM)	THREAD	LENGTH (MM)	PART NO.
<p><b>SIG HBM 50, 100 and 120</b></p>	BO	-	R32	340	7803-3588-01
<p><b>SIG HBM 50, 100 and 120</b></p>	BE, DS	-	R32	550	7803-3576-01
<p><b>SIG 101</b></p>	BE	-	R32	500	7803-3591-01

HANDHELD AND SMALL HOLE DRILLING

FACEDRILLING AND BOLTING

BENCH DRILLING

LONG HOLE DRILLING

SHANK ADAPTERS

AUXILIARY TOOLS

GRINDING EQUIPMENT

INFORMATION AND BIT CLASSIFICATION GUIDE



# WHEN EVERY MINUTE COUNTS: "THE RIGHT TOOLS FOR THE RIGHT JOB"

Auxiliary tools are an important part of the drilling application. This is why we provide top grade tools in order to keep your process moving, and to avoid unnecessary and costly downtime. Our accessories for top hammer drilling tools are simple, practical additions. Their purpose is to



enable the tool system to be tailored to meet your different demands, in different applications and working environments. Furthermore, our auxiliary tools optimize your system providing higher productivity and reliability with lower operating costs and minimal environmental impact.

BIT ADAPTERS	96
REDUCTION COUPLINGS	96
WRENCHES / KNOCK-OFF TOOLS	96
FISHING TOOLS	97
THREAD GREASE	97

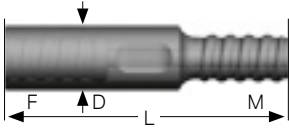
# AUXILIARY TOOLS

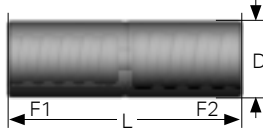
BIT ADAPTERS	WRENCH FLAT (mm)	THREADS		DIMENSIONS				PART NO.
		F (Female)	M (Male)	L (mm)	L (in)	D (mm)	D (in)	
	38	R25	R32	173	6 13/16"	45	1 3/4"	7832-3301
	38	R28	R32	230	9 1/16"	40	1 37/64"	7839-3301
	38	R32	R38	225	8 55/64"	45	1 49/64"	7833-4301
	38	R32	T38	225	8 55/64"	45	1 49/64"	7833-4401
	38	T35	T38	250	9 27/32"	48	1 7/8"	7337-4401
	44.5	R38	T38	245	9 21/32"	55	2 5/32"	7834-4401
	44.5	T38	R32	270	10 41/64"	57	2 1/4"	7334-3301
	44.5	T38	T45	285	11 7/32"	57	2 1/4"	7334-5401
	38	T45	T38	265	10 7/16"	63	2 31/64"	7335-4401
	44.5	T45	T51	285	11 7/32"	63	2 31/64"	7335-6401
	44.5	T51	T45	285	11 7/32"	71	2 51/64"	7336-5401

REDUCTION COUPLINGS	THREADS		DIMENSIONS				PART NO.
	F1	F2	L (mm)	L (in)	D (mm)	D (in)	
	R32	R28	165	6 1/2"	44	1 47/64"	7993-0444
	R32	R25	160	6 1/4"	43	1 11/16"	7993-2443
	R38	R32	170	6 3/4"	55	2 5/32"	7994-3455
	T38	R32	195	7 11/16"	55	2 5/32"	7314-3555
	T38	R38	185	7 9/32"	55	2 5/32"	7314-4455
	T38	T45	180		58	2 9/32"	7314-6258
	T38	T45	180	8 43/64"	61	2 13/32"	7314-6261
	T51	T45	218	8 19/32"	71	2 51/64"	7316-6271

KNOCK-OFF TOOLS		PART NO.
For Hex 22 and Hex 25		
	Pilot rods, type 7922-XXXX-XX	795-1469
For tapered bits		
	Hex 22	795-1467

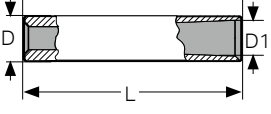

# AUXILIARY TOOLS

FISHING TOOLS	DIMENSIONS			Thread	PART NO.	
	D	D1	L			
<b>Fishing sleeve</b>						
	R32 round/Hex. rods/coupling sleeves	49	47.2	300	R32	795-1604A
	R38 round rods/coupling sleeves	60	–	353	R38	795-1605
	T35 round rods/coupling sleeves	52	50	284	T35	795-1613
	T38 round rods/coupling sleeves/MF-rods	61	58.2	353	T38	795-1607A
	T45 round rods/coupling sleeves/MF-rods	71	68	393	T45	795-1608
	T51 round rods/coupling sleeves/MF-rods	82	78.2	440	T51	795-1609A
	GT60 rods	92	87.5	450	GT60	795-2601

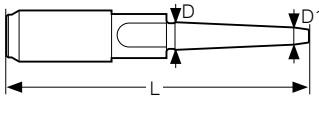
<b>Fishing pike</b>							
	R32 rods <sup>1)</sup>	19.4	4	280	R32	795-1606	!
	T38 rods <sup>2)</sup>	19.4	8	237	T38	795-1676	
	T45 rods <sup>2)</sup>	25	8	275	T45	795-1681	
	T51 rods <sup>2)</sup>	27	15	285	T51	795-1690	
	GT60 rods	50	19.6	500	GT60	795-2604	
	ST58 tubes Ø 76 <sup>2)</sup>	57	22	400	ST58	795-1699	
	ST68 tubes Ø 87 <sup>2)</sup>	71	35	431	ST68	795-2600	

- ! <sup>1)</sup> Without flushing hole  
<sup>2)</sup> With flushing hole

THREAD GREASE	DIMENSIONS			PART NO.	
	D (mm)	L (mm)	Weight (kg)		
<b>For integral drill steels and shank rods</b>					
	Can	215	170	4.5	795-1960
	Can	300	380	18	795-1961
	Tube	53/57	235	0.4	795-1962
	Low temp. Can	300	380	18	795-1963
	Barrel	610	870	240	795-1964



# REGULARLY GRINDING IMPROVES PRODUCTIVITY

By regrinding your drills regularly, you can increase the length of their service life between 5 and 10 times. We offer a complete range of grinders and grinding accessories, from small manual pneumatic grinders to stationary semi-automatic ones for the economical grinding of large volumes

of drill bits. Careful maintenance of the cemented carbide inserts in drilling tools improves almost all drilling parameters in rock drilling. In other words, you can make sure that you are always able to work as efficiently as possible.

INTEGRAL STEEL GRINDER RG100E	100
INTEGRAL STEEL GRINDER RG100H	101
INTEGRAL STEEL GRINDER RG100P	102
INTEGRAL STEEL AND CROSS GRINDER RG140P	103
BUTTON BIT GRINDER RG400	104
BUTTON BIT GRINDER RG410	105
BUTTON BIT GRINDER RG420E	106
BUTTON BIT GRINDER RG420H	107
BUTTON BIT GRINDER RG440	108
BUTTON BIT GRINDER RG460	109
BUTTON BIT GRINDER RG470	110
GRINDING WHEELS	111
GRINDING CUPS	113
GRINDING ACCESSORIES	114

# INTEGRAL STEEL GRINDER

RG100E

## GRINDING APPLICATIONS

Mobile, lightweight, electrical grinder. Intended for frontal and gauge grinding of chisel integral steels.

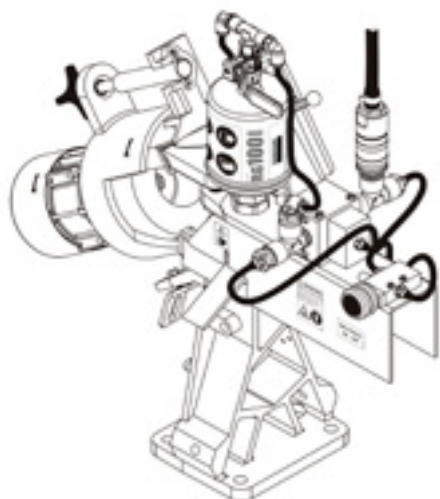

## TECHNICAL DATA

Air pressure	Max 8 bar
Air consumption	5–10 l/sec
Rated power (motor)	1.1 kW
Idling speed	2800 (50 Hz) r.p.m./ 3400 (60 Hz) r.p.m.
Hose connections:	
Air, air hose	9.5 mm (3/8")
Water, water hose	9.5 mm (3/8")
Dimensions: H × W × D	611 × 550 × 350 mm
Grinding wheel dimensions	127 × 546 × 321 mm
Weight inclusive of grinding wheel	21.5 kg
Cutting-edge radius	80 mm
Cutting-edge angle	110°

## PART. NO FOR MACHINES

Complete grinder, hydraulic powered 796-5320-XX\*  
\*For two last digits, see table below, under "Code"

## VOLTAGE/PHASE ALT.

Voltage	Phases	Hz	Code
220–240 V	1	50/60 Hz	50
380–420 V	3	50/60 Hz	52
220–240 V	3	50/60 Hz	59

## ACCESSORIES (INCLUDED IN MACHINE DELIVERY)

Grinding wheel for dry grinding	797-1227-15
Protective goggles	797-5771
T-hexagon wrench	797-5766-06

## ACCESSORIES (OPTIONAL)

Grinding wheel (dry grinding)	797-1227-15
Grinding wheel (wet grinding)	797-1227-10
Kit for grinding plug hole drill steels	797-5489-50
Mounting bracket (for drill rig)	797-5330-91
Support for integral steels	797-5330-92
Grinding template for chisel bit	795-1343
Grinding template for plug hole steels	795-1336

## RECOMMENDED LUBRICANTS

Grease, 0.42 kg cartridge 797-5773-22

## GRINDING WHEEL DIMENSIONS

D	= 127 mm
W	= 63 mm
d	= 32 mm
D1	= 80 mm
w	= 50 mm

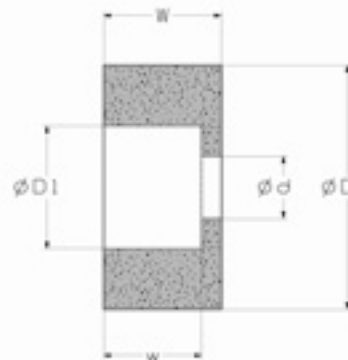

# INTEGRAL STEEL GRINDER

RG100H

## GRINDING APPLICATIONS

Mobile, lightweight, hydraulic grinder. Intended for frontal and gauge grinding of chisel integral steels.

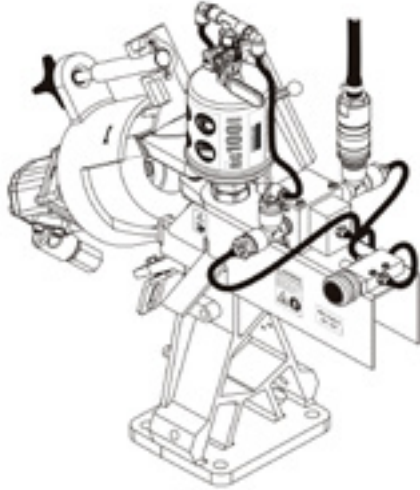

## TECHNICAL DATA

Hydraulic pressure	Max 200 bar/Min. 140 bar
Oil flow consumption	12 l/min
Air pressure	Max 8 bar
Air consumption	5–10 l/sec
Rated power (motor)	4 kW
Idling speed	3700 r.p.m.
Hose connections:	
Hydraulic, hydraulic hose	R 3/8" female thread
Air, air hose	9.5 mm (3/8")
Water, water hose	9.5 mm (3/8")
Dimensions: H × W × D	600 × 550 × 350 mm
Grinding wheel dimensions	127 × 63 × 32 mm
Weight inclusive of grinding wheel	15.5 kg
Cutting-edge radius	80 mm
Cutting-edge angle	110°

## PART. NO FOR MACHINES

Complete grinder, hydraulic powered 796-5330

## ACCESSORIES (INCLUDED IN MACHINE DELIVERY)

Grinding wheel for dry grinding 797-1227-15  
 Protective goggles 797-5771  
 T-hexagon wrench 797-5766-06

## ACCESSORIES (OPTIONAL)

Grinding wheel (dry grinding) 797-1227-15  
 Grinding wheel (wet grinding) 797-1227-10  
 Kit for grinding plug hole drill steels 797-5489-50  
 Mounting bracket (for drill rig) 797-5330-91  
 Support for integral steels 797-5330-92  
 Grinding template for chisel bit 795-1343  
 Grinding template for plug hole steels 795-1336

## RECOMMENDED LUBRICANTS

Grease, 0.42 kg cartridge 797-5773-22

## GRINDING WHEEL DIMENSIONS

D = 127 mm  
 W = 63 mm  
 d = 32 mm  
 D1 = 80 mm  
 w = 50 mm

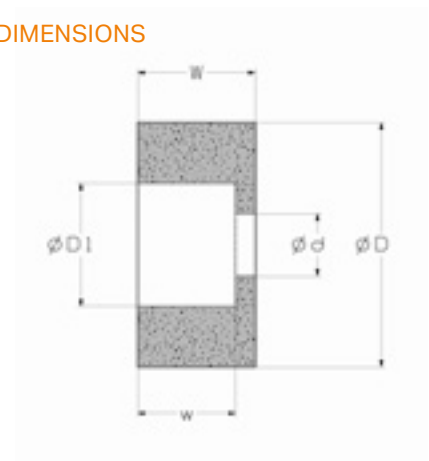

HANDHELD AND  
SMALL HOLE DRILLING

FACEDRILLING  
AND BOLTING

BENCH DRILLING

LONG HOLE DRILLING

SHANK ADAPTERS

AUXILIARY TOOLS

GRINDING EQUIPMENT

INFORMATION AND BIT  
CLASSIFICATION GUIDE



# INTEGRAL STEEL GRINDER

RG100P

## GRINDING APPLICATIONS

Mobile, lightweight, pneumatic grinder. Intended for frontal and gauge grinding of chisel integral steels.

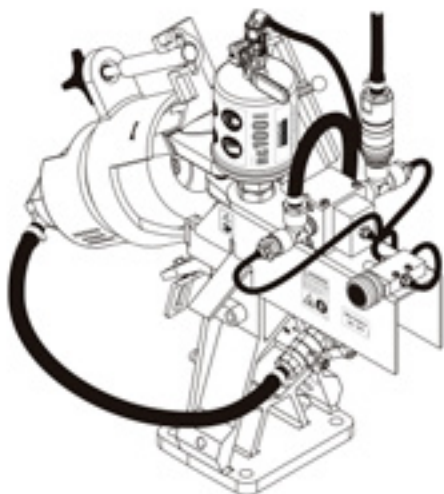

## TECHNICAL DATA

Air pressure	Max 8 bar/min 6 bar
Air consumption	40–60 l/sec
Rated power (motor)	1.7 kW
Idling speed	4900 r.p.m.
Hose connection:	
Air, air hose	12.5 mm (1/2")
Air or water hose for cooling	9.5 mm (3/8")
Dimensions: H × W × D	660 × 550 × 350 mm
Grinding wheel dimensions	127 × 63 × 32 mm
Weight inclusive of grinding wheel	18.5 kg
Cutting-edge radius	80 mm
Cutting-edge angle	110°

## PART. NO FOR MACHINES

Grinder, air powered 796-5300

## ACCESSORIES (INCLUDED IN MACHINE DELIVERY)

Grinding wheel for dry grinding 797-1227-15  
 Protective goggles 797-5771  
 T-hexagon wrench 797-5766-06  
 Support bracket 797-5289

## ACCESSORIES (OPTIONAL)

Grinding wheel (dry grinding) 797-1227-15  
 Grinding wheel (wet grinding) 797-1227-10  
 Kit for grinding plug hole drill steels 797-5489-50  
 In line oiler 797-5747-50  
 Mounting bracket (for drill rig) 797-5330-91  
 Support for integral steels 797-5330-92  
 Grinding template for chisel bit 795-1343  
 Grinding template for plug hole steels 795-1336

## RECOMMENDED LUBRICANTS

Air tool oil, 1 litre 797-5870-90  
 Grease, 0.42 kg cartridge 797-5773-22

## GRINDING WHEEL DIMENSIONS

D = 127 mm  
 W = 63 mm  
 d = 32 mm  
 D1 = 80 mm  
 w = 50 mm

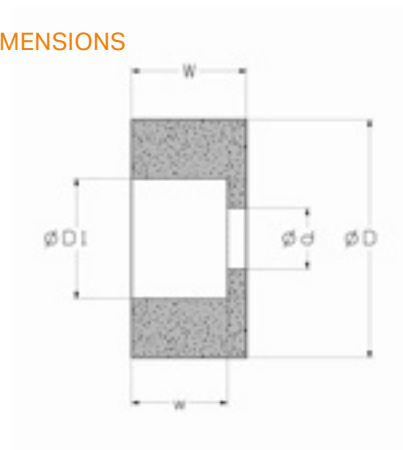



# INTEGRAL STEEL GRINDER AND CROSS GRINDER

RG140P

## GRINDING APPLICATIONS

Basic pneumatic grinder intended for frontal and gauge grinding of integral steels (with straight grinding wheel) or cross and X-bits (with angled grinding wheel). The machine is suitable for bit sizes: Integral steels, all diameters. Cross bits  $\varnothing$  33–43 mm.

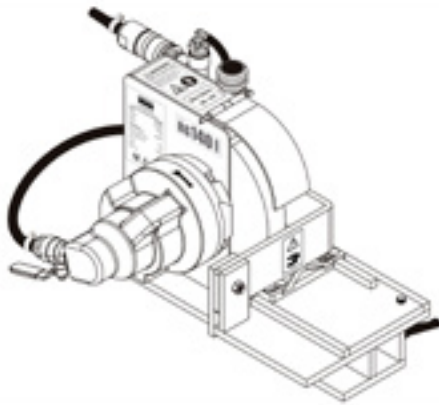

## TECHNICAL DATA

Air pressure	Max 8 bar/min 6 bar
Air consumption	40–60 l/sec
Rated power (motor)	1.7 kW
Idling speed	3000 r.p.m.
Hose connection:	
Air, air hose	12.5 mm (1/2")
Dimensions: H × W × D	505 × 276 × 326 mm
Grinding wheel dimensions:	
Grinding wheel, 132°	200 × 28 × 32 mm
Grinding wheel, straight	200 × 32 × 32 mm
Weight inclusive of grinding wheel	22 kg

## PART. NO FOR MACHINES

Grinder, air powered 796-3800

## ACCESSORIES (INCLUDED IN MACHINE DELIVERY)

Grinding wheel, for 90° cross bits  
(bit size:  $\varnothing$  33–43, for dry grinding) 797-1185-28\*

Grinding wheel dresser 796-1858

Protective goggles 797-5771

T-hexagon wrench 797-5766-06

Dressing template for 4-inserts  
(for 90° cross bits) 797-6035-06

## ACCESSORIES

### (NOT INCLUDED, TO BE ORDERED SEPARATELY)

Grinding wheel, straight for gauge grinding  
(for dry grinding) 797-1101-32\*\*

Grinding wheel, for 90° cross bits  
(bit size:  $\varnothing$  33–39, for dry grinding) 797-1101-25

## ACCESSORIES (OPTIONAL)

Spare rollers for wheel dresser 796-1867

In line oiler 797-5747-50

Mounting bracket (for drill rig) 797-5330-91

## RECOMMENDED LUBRICANTS

Air tool oil, 1 litre 797-5870-90

Grease, 0.42 kg cartridge 797-5773-22

## GRINDING WHEEL DIMENSIONS\*

D = 200 mm  
W = 28 mm  
d = 32 mm



## GRINDING WHEEL DIMENSIONS\*\*

D = 200 mm  
W = 32 mm  
d = 32 mm



# BUTTON BIT GRINDER

RG400

## GRINDING APPLICATIONS

Handheld, lightweight, lower-powered pneumatic grinder intended for all kinds of button bits with max button size of 10 mm.

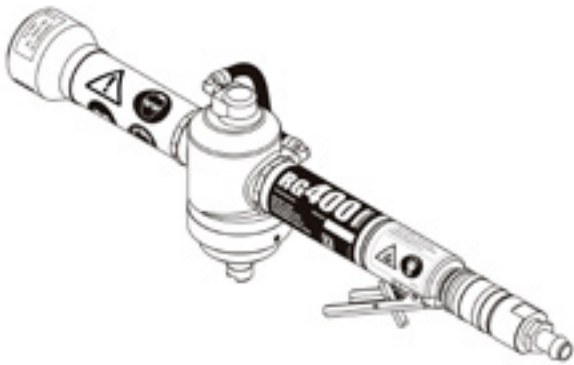

## TECHNICAL DATA

Air Supply pressure	Max 8 bar/min 6 bar
Air consumption	16–17 l/sec
Spindle speed	14000 r.p.m.
Flushing air pressure	Max. 6 bar
Flushing water pressure	Max. 6 bar
Water consumption	5–6 l/min
Hose connections:	
Air, air hose	12.5 mm (1/2")
Water, water hose	6.3 mm (1.4")
Dimensions: H×W×D	156×533×84 mm
Weight	2.9 kg

## PART. NO FOR MACHINES

Complete grinder 796-5116

## ACCESSORIES (INCLUDED IN MACHINE DELIVERY)

O-ring 797-5888-24  
Hose, 6/4 mm 797-5957-06  
Connector, 6-1/4" 797-5899-13  
Nylon packing, 1/4" 797-5934-13  
House Nipple, 1/4" –R1/4" 797-5777-13  
Plug 6, R9 6 mm 797-5769-06  
Screw (to remove damper) 797-5463-31  
Shock Absorber 797-5273-01

## ACCESSORIES (OPTIONAL)

Tools for O-ring replacement 797-5452  
In line oiler 797-5747-50  
Cooling/tank unit, complete 797-5488-85  
Grinding gauge for button up Ø 16 mm 795-1396  
Grinding cups see page 113

## RECOMMENDED LUBRICANTS

Air tool oil, 1 litre 797-5870-90

# BUTTON BIT GRINDER

RG410

## GRINDING APPLICATIONS

Handheld, lightweight, higher-powered pneumatic grinder intended for all kinds of button bits.

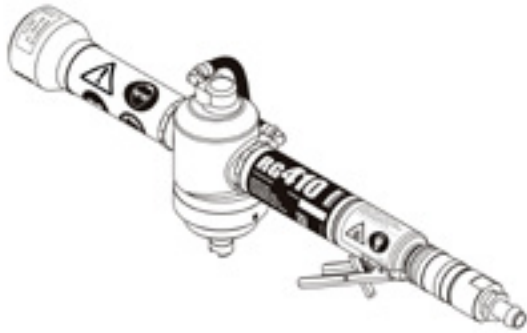

## TECHNICAL DATA

Air Supply pressure	Max 8 bar/min 6 bar
Air consumption	40–55 l/sec
Spindle speed	19000 r.p.m.
Flushing air pressure	Max. 6 bar
Flushing water pressure	Max. 6 bar
Water consumption	5–6 l/min
Hose connections:	
Air, air hose	12.5 mm (1/2")
Water, water hose	6.3 mm (1.4")
Dimensions: H×W×D	156×533×84 mm
Weight	2.9 kg

## PART. NO FOR MACHINES

Complete grinder 796-5100

## ACCESSORIES (INCLUDED IN MACHINE DELIVERY)

O-ring 797-5888-24  
Hose, 6/4 mm 797-5957-06  
Connector, 6-1/4" 797-5899-13  
Nylon packing, 1/4" 797-5934-13  
House Nipple, 1/4"-R1/4" 797-5777-13  
Plug 6, R9 6 mm 797-5769-06  
Screw (to remove damper) 797-5463-31  
Shock Absorber 797-5273-01

## ACCESSORIES (OPTIONAL)

Tools for O-ring replacement 797-5452  
In line oiler 797-5747-50  
Cooling/tank unit, complete 797-5488-85  
Grinding gauge for button up Ø 16 mm 795-1396  
Grinding cups see page 113

## RECOMMENDED LUBRICANTS

Air tool oil, 1 litre 797-5870-90

HANDHELD AND  
SMALL HOLE DRILLING

FACEDRILLING  
AND BOLTING

BENCH DRILLING

LONG HOLE DRILLING

SHANK ADAPTERS

AUXILIARY TOOLS

GRINDING EQUIPMENT

INFORMATION AND BIT  
CLASSIFICATION GUIDE

# BUTTON BIT GRINDER

RG420E

## GRINDING APPLICATIONS

Stationary electrical grinder for workshops, or to be mounted onto drill rigs. Intended for all kinds of button bits. Bit holder suitable for diameters of up to Ø 122 mm: Top hammer (TH) button bits (normal skirt) up to Ø 152 mm, TH button bits (retrac skirt) up to Ø 127 mm and down the hole button bits up to Ø 220 mm (max. shank Ø 110 mm and max. head length 110 mm).

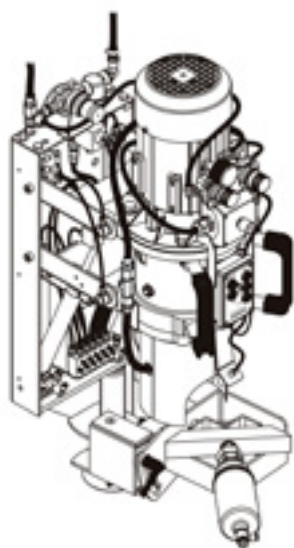

## TECHNICAL DATA

Air Supply pressure	Max 10 bar/min 6 bar
Air consumption	0.5–3 l/sec
Water Supply pressure	Max 8 bar/min 3.5 bar
Water consumption (cooling tank)	2–4 l/min
Water consumption (pump)	0.2–1 l/min
Coolant/flushing medium	Water
Rated power (motor)	1.5 kW
Air connection, air hose	9.5 mm (3/8")
Water connection, water hose	9.5 mm (3/8")
Dimensions: H×W×D	730×390×390 mm
Weight	45 kg

## PART. NO FOR MACHINES

Grinder	796-6210-XX*
Grinder with pump	796-6260-XX*
Grinder with cover	796-6215-XX*
Grinder with pump and cover	796-6265-XX*

\*For two last digits, see table below, under "Code"

## VOLTAGE/PHASE ALT.

Voltage	Phases	Hz	Code
220–240 V	1	50/60 Hz	50
380–420 V	3	50/60 Hz	52
220–240 V	3	50/60 Hz	59
440 V	3	60 Hz	63

## ACCESSORIES (INCLUDED IN MACHINE DELIVERY)

Bit insert	797-5502-26
O-ring for Grinding cup	797-5888-24
Assembly tools for O-ring replacement	797-5452
Lock plate	797-5502-39
Spindle tool 9 mm	797-5464-07
Grease gun	797-5870-20

## ACCESSORIES (OPTIONAL)

Grinding cups	see page 113
Bit Mandrels	797-5348-XX**
**23 = R23, 25 = R25, 28 = R28, 32 = R32, 33 = R33, 35 = R35, 38 = R28/T38, 45 = T45, 51 = T51, 58 = ST58, 60 = GT60, 68 = ST68	
Example: Bit mandrel R32 = 797-5348-32	

Grinding gauge for button up to Ø 16 mm	795-1396
---	----------

## SPARE PART KITS

Complete Grinding head (13000 r.p.m, including flushing head)	797-5130/1
All bearings, seals and screws for grinding head	797-5463-05
Outer Spindle (for Flushing head)	797-5464-02
Small kit for flushing head	797-5464-44
Big kit for flushing head	797-5464-59

## RECOMMENDED LUBRICANTS

Gear oil, 1 litre	797-5870-15
Air tool oil, 1 litre	797-5870-90
Grease, 0.42 kg cartridge	797-5773-22

# BUTTON BIT GRINDER

RG420H

## GRINDING APPLICATIONS

Stationary hydraulic grinder for workshops, or to be mounted onto drill rigs. Intended for all kinds of button bits. Bit holder holds diameters up to Ø 122 mm: Top hammer (TH) button bits (normal skirt) up to Ø 152 mm, TH button bits (retrac skirt) up to Ø 127 mm and down the hole button bits up to Ø 220 mm (max. shank Ø 110 mm and max. head length 110 mm).

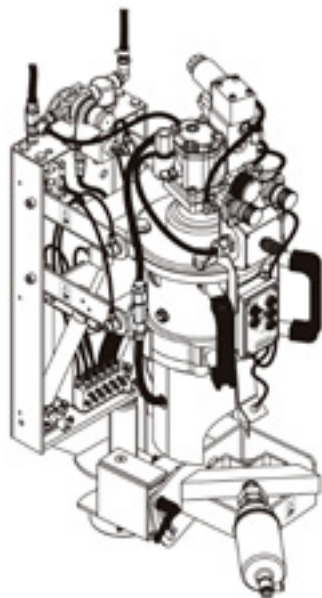

## PART. NO FOR MACHINES

Grinder	796-6230
Grinder with pump	796-6280
Grinder with cover	796-6235
Grinder with pump and cover	796-6285
Grinder with tank	796-6231
Grinder with tank and cover	796-6236

## ACCESSORIES (INCLUDED IN MACHINE DELIVERY)

Bit insert	797-5502-26
O-ring for Grinding cup	797-5888-24
Assembly tools for O-ring replacement	797-5452
Lock plate	797-5502-39
Spindle tool 9 mm	797-5464-07
Grease gun	797-5870-20

## ACCESSORIES (OPTIONAL)

Grinding cups	see page 113
Bit Mandrels	797-5348-XX**
**23 = R23, 25 = R25, 28 = R28, 32 = R32, 33 = R33,	
35 = R35, 38 = R28/T38, 45 = T45, 51 = T51,	
58 = ST58, 60 = GT60, 68 = ST68	
Example: Bit mandrel R32 = 797-5348-32	

Grinding gauge for button up to Ø 16 mm	795-1396
---	----------

## TECHNICAL DATA

Air Supply pressure	Max 10 bar/min 6 bar
Air consumption	0.5–3 l/sec
Water Supply pressure	Max 8 bar/min 3.5 bar
Water consumption (cooling tank)	2–4 l/min
Water consumption (pump)	0.2–1 l/min
Coolant/flushing medium	Water
Rated power (motor)	2.8–4 kW
Air connection, air hose	9.5 mm (3/8")
Water connection, water hose	9.5 mm (3/8")
Hydraulic connection, hydraulic hose	R3/8" female thread
Dimensions: H×W×D	730×390×390 mm
Weight	40 kg
Electricity supply	24V DC, 5A
Hydraulic Supply pressure	Max 200 bar/Min 140 bar
Hydraulic-oil flow	12 l/min

## SPARE PART KITS

Complete Grinding head (13000 r.p.m, including flushing head)	797-5130/1
All bearings, seals and screws for grinding head	797-5463-05
Outer Spindle (for Flushing head)	797-5464-02
Small kit for flushing head	797-5464-44
Big kit for flushing head	797-5464-59

## RECOMMENDED LUBRICANTS

Gear oil, 1 litre	797-5870-15
Air tool oil, 1 litre	797-5870-90
Grease, 0.42 kg cartridge	797-5773-22

# BUTTON BIT GRINDER

RG440

## GRINDING APPLICATIONS

Stationary electrical grinder for workshops. Intended for all top hammer (TH) button bits. Bit holder suitable for Bits with diameters of up to Ø 102 mm: TH button bits (normal skirt) up to Ø 152 mm, TH button bits (retrac skirt) up to Ø 102 mm.

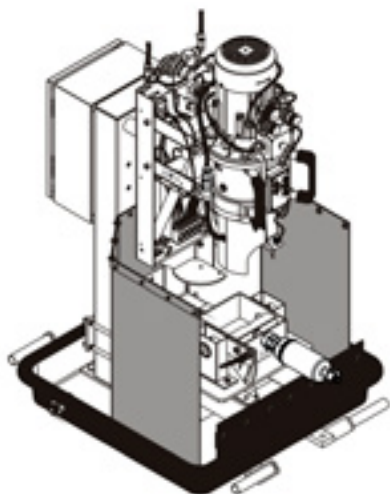

## TECHNICAL DATA

Air Supply pressure	Max 10 bar/min 6 bar
Air consumption	0.5–3 l/sec
Water Supply pressure	Max 8 bar/min 3 bar
Water consumption	0.2–1 l/min
Coolant/flushing medium	Water
Rated power (motor)	1.5 kW
Air connection, air hose	9.5 mm (3/8")
Water connection, water hose	9.5 mm (3/8")
Dimensions: H × W × D	750 × 670 × 795 mm
Weight	95 kg

## PART. NO FOR MACHINES

Grinder	796-6000-XX*
Grinder with pump	796-6050-XX*
Grinder with cover	796-6005-XX*
Grinder with pump and cover	796-6055-XX*

\*For two last digits, see table below, under "Code"

## VOLTAGE/PHASE ALT.

Voltage	Phases	Hz	Code
220–240 V	1	50/60 Hz	50
380–420 V	3	50/60 Hz	52
220–240 V	3	50/60 Hz	59
440 V	3	60 Hz	63

## ACCESSORIES (INCLUDED IN MACHINE DELIVERY)

T38/R38 Bit Mandrel	797-5348-38
O-ring for Grinding cup	797-5888-24
Assembly tools for O-ring replacement	797-5452
Lock plate	797-5502-39
Spindle tool 9 mm	797-5464-07
Grease gun	797-5870-20

## ACCESSORIES (OPTIONAL)

Grinding cups	see page 113
Bit Mandrels	797-5348-XX**
**23 = R23, 25 = R25, 28 = R28, 32 = R32, 33 = R33, 35 = R35, 38 = R28/T38, 45 = T45, 51 = T51, 58 = ST58, 60 = GT60, 68 = ST68	
Example: Bit mandrel R32 = 797-5348-32	

Grinding gauge for button up to Ø 16 mm	795-1396
---	----------

## SPARE PART KITS

Complete Grinding head (8000 r.p.m.) including flushing head non-lubrication	797-5140/1
All bearings, seals and screws for grinding head	797-5463-05
Outer Spindle (for flushing head)	797-5464-02
Small kit for flushing head	797-5464-44 <sup>1</sup>
	797-5464-45 <sup>2</sup>
Big kit for flushing head	797-5464-59 <sup>1</sup>
	797-5464-60 <sup>2</sup>
1 = Non lubrication	
2 = Lubrication	

## RECOMMENDED LUBRICANTS

Gear oil, 1 litre	797-5870-15
Air tool oil, 1 litre	797-5870-90
Grease, 0.42 kg cartridge	797-5773-22



# BUTTON BIT GRINDER

RG460

## GRINDING APPLICATIONS

Stationary electrical grinder for workshops. Intended for all down the hole (DTH) button bits. Bit holder suitable for diameters up to Ø 92 mm: DTH button bits up to Ø 200 mm (max. shank Ø 92 mm and max. head length 105 mm).

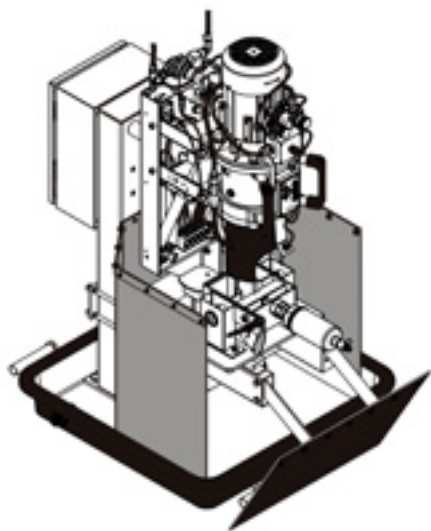

## TECHNICAL DATA

Air Supply pressure	Max 10 bar/min 6 bar
Air consumption	0.5–3 l/sec
Water Supply pressure	Max 8 bar/min 3 bar
Water consumption	0.2–1 l/min
Coolant/flushing medium	Water
Rated power (motor)	1.5 kW
Air connection, air hose	9.5 mm (3/8")
Water connection, water hose	9.5 mm (3/8")
Dimensions: H × W × D	990 × 670 × 795 mm
Weight	95 kg

## PART. NO FOR MACHINES

Grinder	796-6100-XX*
Grinder with pump	796-6150-XX*
Grinder with cover	796-6105-XX*
Grinder with pump and cover	796-6155-XX*

\*For two last digits, see table below, under "Code"

## VOLTAGE/PHASE ALT.

Voltage	Phases	Hz	Code
220–240 V	1	50/60 Hz	50
380–420 V	3	50/60 Hz	52
220–240 V	3	50/60 Hz	59
440 V	3	60 Hz	63

## ACCESSORIES (INCLUDED IN MACHINE DELIVERY)

T38/R38 Bit Mandrel	797-5348-38
O-ring for Grinding cup	797-5888-24
Assembly tools for O-ring replacement	797-5452
Lock plate	797-5502-39
Spindle tool 9 mm	797-5464-07
Grease gun	797-5870-20
Insert plate DTH, 3"	797-5503-73
Insert plate DTH, 4"	797-5503-74
Insert plate DTH, 5"	797-5503-75
Insert plate DTH, 6"	797-5503-76

## ACCESSORIES (OPTIONAL)

Grinding cups	see page 113
Grinding gauge for button up to Ø 16 mm	795-1396

## SPARE PART KITS

Complete Grinding head (8000 r.p.m. including flushing head non-lubrication)	797-5140/1
All bearings, seals and screws for grinding head	797-5463-05
Outer Spindle (for flushing head)	797-5464-02
Small kit for flushing head	797-5464-44 <sup>1</sup>
	797-5464-45 <sup>2</sup>
Big kit for flushing head	797-5464-59 <sup>1</sup>
	797-5464-60 <sup>2</sup>

1 = Non lubrication  
2 = Lubrication

## RECOMMENDED LUBRICANTS

Gear oil, 1 litre	797-5870-15
Air tool oil, 1 litre	797-5870-90
Grease, 0.42 kg cartridge	797-5773-22

# BUTTON BIT GRINDER

RG470

## GRINDING APPLICATIONS

Highly efficient stationary electrical grinder for workshops. Intended for all button bits. Top Hammer (TH) bits Ø 28 mm (bit length > 65 mm) up to Ø 152 mm, and down the hole (DTH) bits Ø 90 mm up to Ø 270 mm.

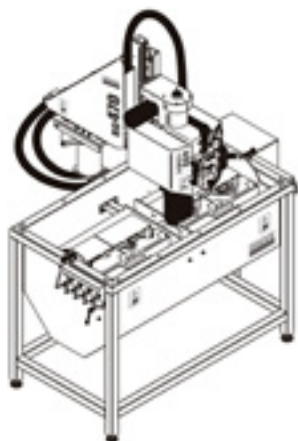

## TECHNICAL DATA

Air Supply pressure	Max 10 bar/min 6 bar
Air consumption	0.5–2 l/sec
Water Supply pressure	Max 8 bar/min 3.5 bar
Water consumption	1 l/min
Coolant/flushing medium	Water
Rated power (grinding motor)	3 kW
Air connection, air hose	9.5 mm (3/8")
Water connection, water hose	9.5 mm (3/8")
Dimensions: H × W × D	2000 × 1600 × 1100 mm
Weight	320 kg

## PART. NO FOR MACHINES

Grinder 796-6700-XX\*

\*For two last digits, see table below, under "Code".

Note! Drill Bit support are not included in grinder.

Parts must be ordered separately.

## VOLTAGE/PHASE ALT.

Voltage	Phases	Hz	Code
380–420 V	3	50/60 Hz	52
220–240 V	3	50/60 Hz	59

## ACCESSORIES (INCLUDED IN MACHINE DELIVERY)

O-ring for Grinding cup	797-5888-24
Assembly tools for O-ring replacement	797-5452
Spindle tool 9 mm	797-5464-17
Grease gun	797-5870-07

## ACCESSORIES (NOT INCLUDED, TO BE ORDERED SEPARATELY)

Drill Bit support, appr. skirt Ø = 30–75 mm	797-5552-19*
Drill Bit support, appr. skirt Ø = 75–120 mm	797-5552-14**
Drill Bit support, appr. skirt Ø = 120–150 mm	797-5552-25***

## ACCESSORIES (OPTIONAL)

Grinding cups	see page 113
Grinding gauge for button up to Ø 16 mm	795-1396

## SPARE PART KITS

Outer Spindle (for flushing head)	797-5464-02
Small kit for flushing head	797-5464-44 <sup>1</sup>
	797-5464-45 <sup>2</sup>
Big kit for flushing head	797-5464-59 <sup>1</sup>
	797-5464-60 <sup>2</sup>

1 = Non lubrication

2 = Lubrication

## RECOMMENDED LUBRICANTS

Air tool oil, 1 litre	797-5870-90
Grease, 0.42 kg cartridge	797-5773-22



# GRINDING WHEELS

## GRINDING WHEELS FOR RG100P, RG100H, RG120P AND RG120E

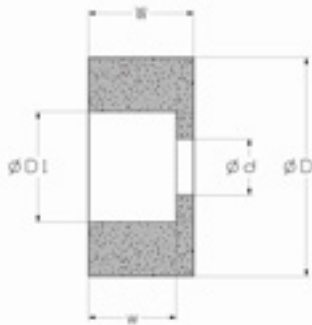

### GRINDING WHEEL FOR RG100

D	W	d	D1	w	COMMENT	PART.NO
127	63	32	80	50	dry or wet grinding	797-1227-15
127	63	32	80	50	wet grinding	797-1227-10

### GRINDING WHEEL FOR RG120

D	W	d	D1	w	Comment	part.no
150	83	63.5	100	64	wet grinding	797-1252-10

## GRINDING WHEELS FOR SECOROC: JUNIOR AND SENIOR, ATLAS COPCO: TEROC 1500/1501

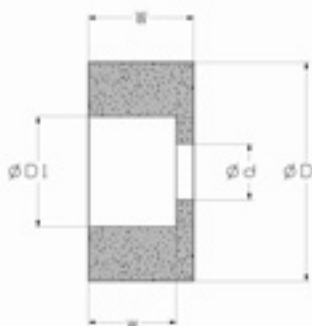

### SECOROC: JUNIOR AND SENIOR, ATLAS COPCO: TEROC 1500/1501

D	W	d	D1	w	COMMENT	PART.NO
200	102	32	150	80	wet grinding	797-1250-10

# GRINDING WHEELS

## GRINDING WHEELS FOR RG300, RG320, RG340 AND RG360

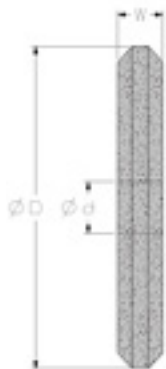

BIT INSERT ANGLE	BIT Ø, MM	WHEEL ANGLE	D	W	d	COMMENT	PART.NO
90°, Cross bits	33–35	132°	300	23	32	wet grinding	797-1190-23
90°, Cross bits	43–45	132°	300	29	32	wet grinding	797-1190-29
90°, Cross bits	48–51	132°	300	32	32	wet grinding	797-1190-32

## GRINDING WHEELS FOR RG140

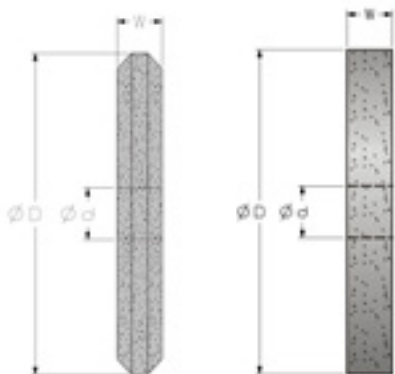

BIT INSERT ANGLE	BIT Ø, MM	WHEEL ANGLE	D	W	d	COMMENT	PART.NO
90°, Cross bits	33–39	132°	200	25	32	dry grinding	797-1101-25
90°, Cross bits	33–43	132°	200	28	32	dry grinding	797-1185-28
Straight wheel for gauge grinding			200	32	32	dry grinding	797-1101-32

# GRINDING CUPS

GRINDING CUPS FOR RG400, RG410, RG420, RG440, RG460 AND RG470 GRINDERS

## SANCUP SUPER (S)

Grinding cups for redressing spherical (and super-spherical) buttons. Shank  $\varnothing$  9 mm.

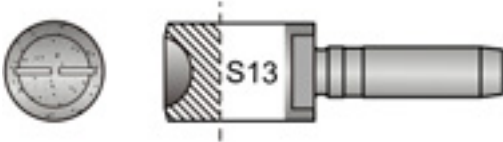

\* = straight water flushing slots



\*\* = three water flushing slots

FOR BUTTON SIZE	PART. NO
7 mm	797-5400-07*
8 mm	797-5400-08*
9 mm	797-5400-09*
10 mm	797-5400-10*
11 mm	797-5400-11*
12 mm	797-5400-12**
13 mm	797-5400-13**
14 mm	797-5400-14**
16 mm	797-5400-16**
18 mm	797-5400-18**

## SANCUP SUPER (B)

Grinding cups for redressing ballistic (and semi-ballistic and Robust-ballistic) buttons. Shank  $\varnothing$  9 mm.

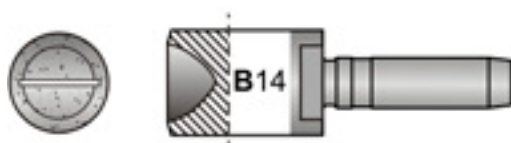

\* = straight water flushing slots



\*\* = three water flushing slots

FOR BUTTON SIZE	PART. NO
7 mm	797-5295-07*
8 mm	797-5295-08*
9 mm	797-5295-09*
10 mm	797-5295-10*
11 mm	797-5295-11**
12 mm	797-5295-12**
13 mm	797-5295-13**
14 mm	797-5295-14**
16 mm	797-5295-16**
18 mm	797-5295-18**

# GRINDING ACCESSORIES

## WHEEL DRESSER

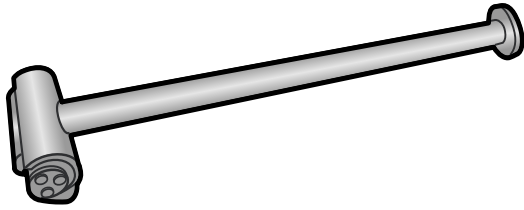

<sup>1)</sup> Included in a complete unit.

DESCRIPTION	PART. NO
Wheel dresser, complete	796-1858
Shaft (1 pcs) <sup>1)</sup>	796-1862
Bearing bushing (2 pcs) <sup>1)</sup>	796-1863
Screw (6 pcs) <sup>1)</sup>	796-1865
Cover (2 pcs) <sup>1)</sup>	796-1866
1 set of dresser rollers <sup>1)</sup>	796-1867

## GRINDING TEMPLATES

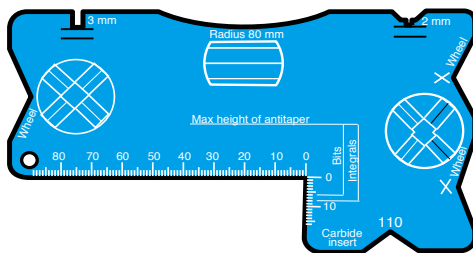

For integrals with cross bit/For cross and X-bits with diameter up to 115 mm/For integrals with chisel bit and motor drill steels.

DESCRIPTION	PART. NO
Grinding template	795-1343

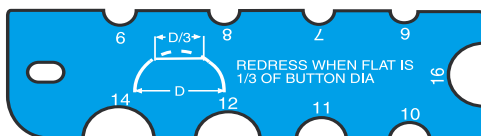

For buttons up to 16 mm.

DESCRIPTION	PART. NO
Grinding template	795-1396



# IMPORTANT HEALTH AND SAFETY INFORMATION

## MATERIAL COMPOSITION

Most hardmetal products contain tungsten carbide and cobalt.

## ROUTES OF EXPOSURE

Grinding or heating hardmetal blanks or hardmetal products will produce dust or fumes with dangerous ingredients that can be inhaled or swallowed, or which might come in contact with the skin or eyes.

## ACUTE TOXICITY

The dust is toxic by inhalation. Inhalation may cause irritation and inflammation in the airways. Skin contact can cause irritation and rash. Sensitized people may experience an allergic reaction.

## CHRONIC TOXICITY

Repeated inhalation of aerosols containing cobalt may cause obstruction in the airways. Prolonged inhalation of increased concentrations may cause lung fibrosis or lung cancer.

Cobalt is a potent skin sensitizer. Repeated or prolonged contact can cause sensitization.

## CLASSIFICATION

- Following hazard classification according to GHS/CLP applies to the hardmetal powder ( $3\% \leq \text{Co} < 10\%$ ):
- Acute Inhalation 3, H331: Toxic if inhaled.
- Carcinogenicity 1B, H350i: May cause cancer by inhalation.
- Repr. 2, H361f: Suspected of damaging fertility.
- STOT RE 1, H372: Causes damage to lungs through prolonged or repeated exposure through inhalation.
- Resp. Sens. 1B, H334: May cause allergy or asthma symptoms or breathing difficulties if inhaled.
- Skin Sens.1, H317: May cause an allergic skin reaction.
- Aquatic Acute 1, H400: Very toxic to aquatic life.
- Aquatic Chronic 2, H411: Toxic to aquatic life, with long lasting effects.

## PRECAUTIONARY STATEMENTS

- Do not breathe the dust.
- Wear protective gloves/protective clothing/eye protection.
- In case of inadequate ventilation, wear respiratory protection.
- Avoid release into the environment.

**IF INHALED:** If breathing is difficult, remove the victim to fresh air and keep them at rest in a position comfortable for breathing. If they are experiencing respiratory symptoms: Call a POISON CENTER or doctor/physician.

# BIT CLASSIFICATION – SYMBOL EXPLANATION



1. These bits are designed to give maximum penetration rate. They tend to work best in soft to medium hard (up to 150 MPa) and non-abrasive rock formations.

3. These bits offer a balance between penetration rate and bit service life. They will give fast drilling speed, while still delivering a good rock tools economy in a wide range of rock Conditions.

5. These bits are optimized towards giving best possible rock tools economy through a long service life. This is especially true and important in hard and abrasive rock formations (above 20% silica).

## CODE KEY INTEGRAL DRILL STEELS

7XX-YYZZ-QQ

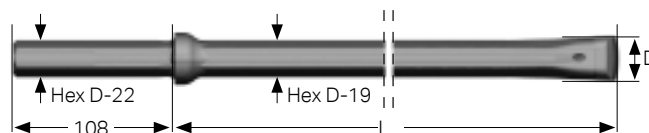

MAIN CODE 7XX	SUB CODE YYZZ	3:RD CODE GROUP QQ
714 = 22×108 shank, Hex 22 chisel	YY = effective length in dm ZZ = bit diameter in mm	50 = insert height 17 mm 65 = insert height 19 mm
724 = 19×108 shank, Hex 19 chisel	YY = effective length in dm ZZ = bit diameter in mm	
728 = 22×108 shank, Hex 19 chisel	YY = effective length in dm ZZ = bit diameter in mm	

## CODE KEY TAPERED BITS

7XXX-YYZZ-QQ



MAIN CODE 7XX	SUB CODE YYZZ	3:RD CODE GROUP QQ
7770 = 12 deg Long skirt	YY = 19, 3 gauge buttons	(Q) = S spherical buttons
7776 = 11 deg	YY = 44/52 Normal, 5 gauge buttons	(Q) = B ballistic buttons
7788 = 7 deg	YY = 54, 6 gauge buttons	
7795 = 12 deg Short skirt	YY = 64 Normal, 4 gauge buttons	QQ = 42 CC-grade 442 (inserts)
	YY = 90 Cross bit HD	QQ = 48 CC-grade XT48 (buttons)
	ZZ = Bit diameter in mm	

## CODE KEY TAPERED RODS

7XXX-YYZZ-QQ

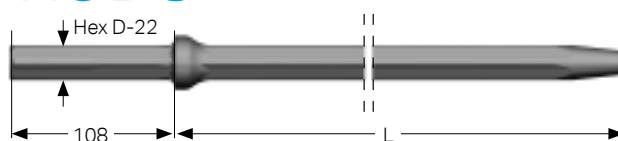

MAIN CODE 7XXX	SUB CODE YYZZ	3:RD CODE GROUP QQ
7870 = 12 deg	YY = 11 HF hardened, Sanbar 20	11 = no packing
7876 = 11 deg	YY = 51 HF hardened, Sanbar 61	
7888 = 7 deg	YY = 61 Carburized, Sanbar 64	
	ZZ = approximate length in dm	

# CODE KEY EXTENSION RODS

7XXX-YYZZ-QQ

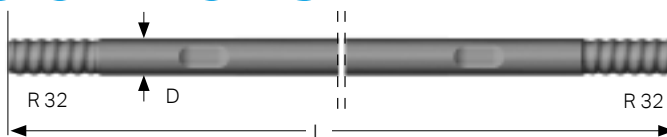

MAIN CODE 7XXX	SUB CODE YYZZ	3:RD CODE GROUP QQ
7851 = R22	YY = 13 Hex 22	20 = Carburized
7852 = R25	YY = 23 Hex 25	30 = HF-hardened
7853 = R32	YY = 33 Round 33	
7854 = R38	YY = 43 Round 39	
7857 = R23	ZZ = approximate length in dm	
7324 = T38	YY = 43 Round 39	20 = Carburized
7325 = T45	YY = 73 Round 46	30 = HF-hardened
7326 = T51	YY = 53 Round 52	
	ZZ = approximate length in dm	

# CODE KEY MF RODS

7XXX-YYZZ-QQ

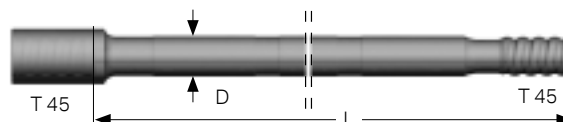

MAIN CODE 7XXX	SUB CODE YYZZ	3:RD CODE GROUP QQ
7853 = R32	YY = 48 Hex 22	20 = Carburized
7857 = R23	YY = 51 Round 32	
	ZZ = approximate length in dm	
7324 = T38	YY = 47 Round 39	20 = Carburized
7325 = T45	YY = 77 Round 46	70 = Sandvik Tough
7326 = T51	YY = 55 Round 52	
7327 = T35	YY = 11 Round 60	
7610 = GT60	YY = 14 Round 60, for 92 mm bits	
	ZZ = approximate length in dm	

# CODE KEY DRIFTER RODS

7XXX-YYZZ-Q

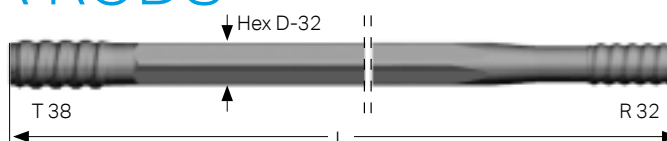

MAIN CODE 7XXX	SUBCODE YY	3:RD CODE GROUP Q
ZZ = approximate length in dm		
Code	Steel Section	Bit thread
7853 = R32 shank end	24 Hex 25	R25 20 = Carburized
7854 = R38 shank end	30 Hex 28	R25
7324 = T38 shank end	76 Hex 28	R28
7327 = T35 shank end	87 Hex 32	R28
	65 MF-drifter Hex 35	R32
	86 Hex 32	R32
	96 Hex 35	R32
	67 Hex 35	α330
	70 Round 39	α330
	72 Round 39	R35
	85 Hex 35	R35
	52 MF-drifter Round 39	R35

HANDHELD AND SMALL HOLE DRILLING

FACEDRILLING AND BOLTING

BENCH DRILLING

LONG HOLE DRILLING

SHANK ADAPTERS

AUXILIARY TOOLS

GRINDING EQUIPMENT

INFORMATION AND BIT CLASSIFICATION GUIDE

# CODE KEY SHANK RODS AND SHANK ADAPTERS

7XXX-YYZZ-QQ

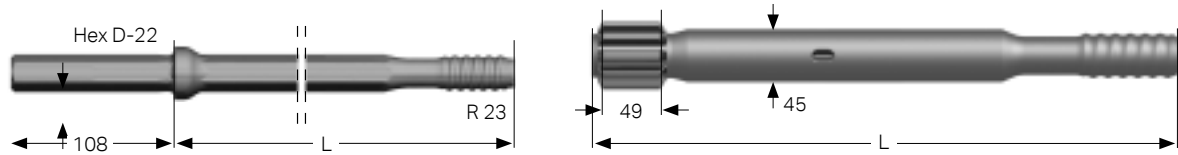

MAIN CODE 7XXX	SUB CODE YYZZ	3:RD CODE GROUP QQ
7801 = R22	Shank rods:	Shank rods:
7802 = R25	YY = 61 Hex 22	11 = shank H22×108, no packing
7803 = R32	YY = 71 Hex 25	21 = shank H25×159, no packing
7804 = R38	ZZ = approximate length in dm	30 = shank H25×108, no packing
7807 = R23		
7814 = α250		Shank adapters:
7304 = T38		01, 02, 03, 05 = separate flushing
7305 = T45		19 = 19 mm packing
7306 = T51		23 = 23 mm packing
7307 = T35		30 = 10 mm packing
7328 = ST58		40 = 11 mm packing
7329 = ST68		50 = 12,7 mm packing
7600 = GT60		60/61 = 14 mm packing
		80 = 16 mm packing

# CODE KEY DRIFTER BITS

7XXX-YYZZ-(Q)QQ

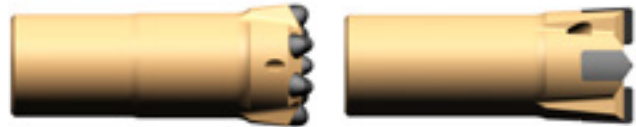

MAIN CODE 7XXX	SUB CODE YYZZ	3:RD CODE GROUP QQ
7731 = R22	YY = 10 Cross bit Normal	(Q) = S spherical buttons
7732 = R25	YY = 13/14 Cross bit HD	(Q) = R ballistic buttons
7733 = R32	YY = 16 Normal bit with 6 gauge buttons	(Q) = C conical buttons
7737 = R23	YY = 44 Normal bit 5 gauge buttons	
7738 = R35	YY = 52 HD bit 5 gauge buttons	QQ = 11 CC-grade 411 (inserts)
7739 = R28	YY = 53 Normal bit 6 gauge buttons	QQ = 42 CC-grade 442 (inserts)
7764 = α250	YY = 54 Normal bit 6 gauge buttons	QQ = 48 CC-grade XT48 (buttons)
7767 = α330		QQ = 55 CC-grade DP55 (buttons)
	ZZ = Bit diameter in mm	QQ = 65 CC-grade DP65 (buttons)

# CODE KEY BIG THREADED BITS

7XXX – YYZZ – (Q) QQ



MAIN CODE 7XXX	SUB CODE YYZZ	3:RD CODE GROUP QQ
7734 = R38	YY = 16 HD bit 6 gauge buttons	(Q) = S spherical buttons
7514 = T38	YY = 18 HD bit 8 gauge buttons	(Q) = R ballistic buttons
7515 = T45	YY = 19 HD bit 9 gauge buttons	
7516 = T51	YY = 26 Button bit Normal	QQ = 11 CC-grade 411 (inserts)
7517 = T35	YY = 38 Button bit HD	QQ = 42 CC-grade 442 (inserts)
7620 = GT60	YY = 40 HD X-bit	QQ = 48 CC-grade XT48 (buttons)
	YY = 46 HD retrac bit 6 gauge buttons	QQ = 55 CC-grade DP55 (buttons)
	YY = 48 HD retrac bit 8 gauge buttons	QQ = 65 CC-grade DP65 (buttons)
	YY = 49 HD retrac bit 9 gauge buttons	
	YY = 78 Retrac bit with buttons	
ZZ = Bit diameter in mm		

# CODE KEY COUPLINGS

7XXX – YYZZ

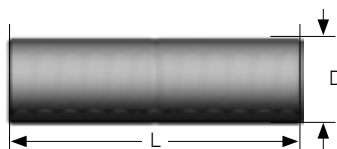

MAIN CODE 7XXX	SUB CODE YYZZ
7991 = R22	YY = 04 R28 adapter thread
7992 = R25	YY = 20 Tough hardened, same thread both ends
7993 = R32	YY = 24 R25 adapter thread
7994 = R38	YY = 33 Tough hardened, same thread both ends
7314 = T38	YY = 34/35 R32 adapter thread
7315 = T45	YY = 36 Carburized, same thread both ends
7316 = T51	YY = 44 R38 adapter thread
7317 = T35	YY = 52 T38 adapter thread
	YY = 62 T45 adapter thread
ZZ = Outer diameter in mm	

# CODE KEY BIT ADAPTERS

7XXX – YY01

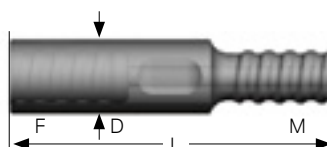

MAIN CODE 7XXX	SUB CODE YYZZ
7832 = R25 internal thread	YY = 33 R32 external thread
7833 = R32 internal thread	YY = 43 R38 external thread
7834 = R38 internal thread	YY = 44 T38 external thread
7837 = R23 internal thread	YY = 54 T45 external thread
7839 = R28 internal thread	YY = 64 T51 external thread
7334 = T38 internal thread	
7335 = T45 internal thread	
7336 = T51 internal thread	
7337 = T35 internal thread	

HANDHELD AND SMALL HOLE DRILLING

FACEDRILLING AND BOLTING

BENCH DRILLING

LONG HOLE DRILLING

SHANK ADAPTERS

AUXILIARY TOOLS

GRINDING EQUIPMENT

INFORMATION AND BIT CLASSIFICATION GUIDE

# NUMERICAL INDEX WITH WEIGHT TABLE

Partno.	Weight (kg)	Page	Partno.	Weight (kg)	Page	Partno.	Weight (kg)	Page
714-0434-65	1.8	25	728-0424	1.4	24	7305-3667-01	4.5	88
714-0635-65	2.5	25	728-0429	1.4	24	7305-3690-02	6.9	88
714-0641-65	2.5	25	728-0828	2.3	24	7305-3826-02	10	87
714-0829	3.0	25	728-1627	3.9	24	7305-4791-01	6.3	90
714-0833-65	3.0	25	7304-3550-01	5.4	87	7305-4883-01	8.7	91
714-0834-65	3.0	25	7304-3590-03	4.1	85, 86, 87	7305-6008-01	8.9	84
714-0840-65	3.1	25	7304-3591-01	4.8	85, 86, 87	7305-6010-01	9.7	84
714-1232-65	4.3	25	7304-3593-01	4.7	86, 87	7305-7414-01	8.9	90
714-1234-65	4.3	25	7304-3652-01	3.8	87	7305-7417-01	9.5	90
714-1240-65	4.3	25	7304-3655-01	6.2	87	7305-7520-01	5.6	92
714-1628-50	5.4	25	7304-3656-01	4.5	87	7305-7525-19	5.5	91
714-1631	5.5	25	7304-3663-01	9.6	87	7305-7532-01	3.3	83
714-1633-65	5.5	25	7304-3690-02	6.7	88	7305-7537-01	5.8	83
714-1639-65	5.5	25	7304-3825-02	9.9	87	7305-7541-02	6.9	83
714-1833-65	6.1	25	7304-4700-01	4.0	81	7305-7546-19	7.8	91
714-1839-65	6.1	25	7304-4700-50	3.3	81	7305-7551-01	7.6	83
714-2030	6.5	25	7304-4720-01	3.8	92	7305-7557-01	5.9	82
714-2033-65	6.6	25	7304-4725-01	3.6	92	7305-7559-19	6.1	91
714-2427-50	7.9	25	7304-4780-01	6.4	90	7305-7576-01	7.2	83
714-2432-65	7.9	25	7304-4791-01	6.0	90	7305-7577-02	8.7	84
714-2438-65	7.9	25	7304-4993-01	5.5	89	7305-7586-01	6.2	82
714-3231	10	25	7304-7426-01	6.3	90	7306-3655-02	6.8	87
714-3237-65	10	25	7304-7500-60	4.0	85, 90, 91	7306-3689-01	11	88
714-4030	13	25	7304-7525-19	5.4	91	7306-3690-03	7.2	88
714-4036-65	13	25	7304-7531-01	4.0	82	7306-3691-01	7.0	88
714-4829	15	25	7304-7532-01	5.9	83	7306-3692-01	9.5	88
714-4835-65	15	25	7304-7535-02	4.6	82	7306-3699-01	14	88
714-5628-50	18	25	7304-7536-01	4.3	82	7306-4885-02	14	91
714-5634-65	18	25	7304-7537-01	5.5	83	7306-6008-01	9.3	84
714-6427-50	20	25	7304-7543-60	3.6	90, 91	7306-6010-02	10	84
714-6433-65	20	25	7304-7544-01	7.3	92	7306-6014-02	12	84
714-7226-50	23	25	7304-7554-01	5.3	82	7306-6021-02	11	84
714-7232-65	23	25	7304-7557-01	5.6	82	7306-6022-02	13	84
714-8026-50	25	25	7304-7576-01	6.9	83	7306-6025-02	16	84
714-8825-5005	27	25	7304-7577-02	8.6	84	7306-7424-01	15	90
714-9625-5005	30	25	7304-7581-60	5.2	90	7306-7528-02	8.9	92
721-1517	0.6	29	7304-7583-40	5.8	85	7306-7530-02	16	92
721-1620	0.7	29	7304-7585-01	5.3	82	7306-7551-02	8.1	83
721-1622	0.7	29	7304-7586-01	5.7	82	7306-7577-03	8.8	84
721-1922	0.8	29	7304-7588-01	8.8	85	7307-3652-01	3.7	87
721-2020	0.8	29	7304-7664-01	6.4	82	7307-3656-01	4.2	87
721-2420	0.8	29	7304-7666-01	6.5	83	7307-3671-01	4.9	88
721-2820	0.9	29	7304-7668-01	7.0	82	7307-3690-01	6.9	88
721-3120	1.0	29	7304-7669-01	5.6	83	7307-7535-02	4.5	82
724-0424	1.3	24	7304-7671-01	7.7	82	7307-7544-01	7.1	92
724-0429	1.3	24	7304-7672-01	3.5	81	7307-7557-01	5.6	82
724-0627	1.7	24	7304-7673-01	7.9	83	7307-7566-01	4.9	82
724-0823	2.1	24	7304-7685-01	7.5	83	7307-7585-01	5.3	82
724-0828	2.2	24	7305-3591-01	5.1	86, 87	7307-7586-01	5.6	82
724-1226	3.0	24	7305-3593-01	5.8	86, 87	7307-7666-01	6.5	83
724-1627	5.0	24	7305-3655-01	6.5	87	7307-7668-01	7.0	82
724-2426	5.7	24	7305-3663-01	9.9	87	7307-7671-01	7.4	82

# NUMERICAL INDEX WITH WEIGHT TABLE

Partno.	Weight (kg)	Page	Partno.	Weight (kg)	Page	Partno.	Weight (kg)	Page
7307-7672-01	4.0	81	7325-7343C-30	47	58	7379-8718-46	48	77
7307-7673-01	7.0	83	7325-7712C-20	14	72	7514-1464-11	2.1	69
7307-7685-01	7.0	83	7325-7715C-20	18	72	7514-1654A-R48	1.0	55, 69
7314-3355	1.9	56	7325-7718C-20	21	72	7514-1664-R48	1.7	55, 69
7314-3652	1.6	40, 44, 45	7325-7731-70	35	58	7514-1664-S48	1.5	55, 69
7315-3663	2.7	58	7325-7731-80	35	58	7514-1870-S48	1.9	55, 69
7316-3671	3.6	60	7325-7737-70	41	58	7514-1876-R48	2.3	55, 69
7316-3676	4.6	60	7325-7737-80	41	58	7514-1876-S48	2.1	55, 69
7324-4331C-30	24	56	7325-7743-70	48	58	7514-1889-S48	3.0	55, 69
7324-4337C-30	29	56	7325-7743-80	48	58	7514-2664A-S48	1.7	55, 69
7324-4709C-20	8.1	70	7326-5337C-30	50	60	7514-2676A-S48	2.3	55, 69
7324-4712C-20	11	70	7326-5343C-30	56	60	7514-4664-R48	1.9	55, 69
7324-4715C-20	12	70	7326-5361C-30	85	60	7514-4664-S48	1.9	55, 69
7324-4718C-20	15	70	7326-5515C-20	23	74	7514-4864-R48	2.0	55, 69
7324-4731-70	25	56	7326-5518C-20	27	74	7514-4870-S48	2.7	55, 69
7324-4737-70	30	56	7326-5537-70	50	60	7514-4876-R48	3.5	55, 69
7324-4737-80	30	56	7326-5537-80	50	60	7514-4876-S48	3.5	55, 69
7324-4743-70	36	56	7326-5543-70	57	60	7514-5564A-C60	1.4	55, 69
7324-4743-80	36	56	7326-5543-80	57	60	7514-5576A-C60	2.5	55, 69
7324-6537-20	29	40	7326-5555-80	72	60	7514-7576A-C60	3.5	55, 69
7324-6543-20	34	40	7326-5561-70	87	60	7514-7864A-S48	2.2	55, 69
7324-6724-20	18	43	7327-4718-20	16	68	7514-7876A-S48	3.0	55, 69
7324-6731-20	25	43	7327-4731-20	25	47, 54	7514-7964-R48	2.0	55, 69
7324-6737-20	29	43	7327-4737-20	32	47, 54	7514-7964-S48	2.2	55, 69
7324-6743-20	32	43	7327-4743-20	35	47	7514-7976-R48	3.5	55, 69
7324-6749-20	39	43	7327-4749-20	40	47	7514-7976-S48	3.5	55, 69
7324-6755-20	44	43	7327-5243-20	35	47	7515-1870-S48	2.3	57, 71
7324-6931-20	18	56	7327-5249-20	40	47	7515-1876-R48	2.4	57, 71
7324-7049-20	44	43	7327-5255-20	45	47	7515-1876-S48	2.5	57, 71
7324-7055-20	49	43	7327-5261-20	50	47	7515-1889-R48	3.1	57, 71
7324-7061-20	57	43	7328-3720-01	26	88	7515-1889-S48	3.2	57, 71
7324-7064-20	57	43	7328-6009-02	17	84	7515-1902-R48	4.0	57, 71
7324-7243-20	35	45	7328-6020-01	17	85	7515-1902-S48	4.0	57, 71
7324-7249-20	40	45	7328-6035-01	22	85	7515-2676A-S48	2.5	57, 71
7324-7255-20	45	45	7329-3720-01	27	88	7515-2689A-S48	3.1	57, 71
7324-7261-20	49	45	7329-6009-02	17	84	7515-4870-R48	2.7	57, 71
7324-8543-20	34	45	7329-6020-05	18	85	7515-4876-R48	3.0	57, 71
7324-8549-20	37	45	7329-6034-05	17	85	7515-4876-S48	3.0	57, 71
7324-8555-20	42	45	7329-6034-15	17	83	7515-4889-R48	4.4	57, 71
7324-8631-20	24	40	7329-6035-05	22	85	7515-4889-S48	4.8	57, 71
7324-8637-20	26	40	7334-3301	2.6	96	7515-4902-R48	6.9	57, 71
7324-8643-20	28	40	7334-5401	3.3	96	7515-4902-S48	6.8	57, 71
7324-9624-20	19	40	7335-4401	2.9	96	7515-5576A-C60	2.2	57, 71
7324-9631-20	24	40	7335-6401	3.7	96	7515-5589A-C60	3.1	57, 71
7324-9637-20	28	40	7336-5401	3.8	96	7515-5627-S48	6.9	72
7324-9643-20	32	40	7337-4401	1.9	96	7515-5652-S48	9.3	72
7324-9649-20	37	40	7358-6025-02	17	84	7515-7576A-C60	3.0	57, 71
7324-9655-20	42	40	7378-7615-26	33	76	7515-7589A-C60	4.3	57
7324-9661-20	44	40	7378-7618-26	41	76	7515-7876A-S48	3.0	57, 71
7324-9664-20	46	40	7379-8715-26	40	77	7515-7889A-S48	4.4	57, 71
7325-7331C-30	33	58	7379-8715-46	40	77	7515-7902-S48	6.2	57, 71
7325-7337C-30	40	58	7379-8718-26	47	77	7515-7976-R48	3.1	57, 71

HANDHELD AND SMALL HOLE DRILLING

FACEDRILLING AND BOLTING

BENCH DRILLING

LONG HOLE DRILLING

SHANK ADAPTERS

AUXILIARY TOOLS

GRINDING EQUIPMENT

INFORMATION AND BIT CLASSIFICATION GUIDE



# NUMERICAL INDEX WITH WEIGHT TABLE

Partno.	Weight (kg)	Page	Partno.	Weight (kg)	Page	Partno.	Weight (kg)	Page
7515-7976-S48	3.1	57, 71	7600-6025-05	17	84	7732-4435-S48	0.4	32, 36
7515-7989-R48	4.5	57, 71	7600-6025-12	17	83	7732-4437C-S48	0.5	36
7515-7989-S48	4.5	57, 71	7600-6030-05	21	85	7732-5235-R48	0.4	32, 36
7515-8276-R48	3.2	57, 71	7600-6030-15	21	83	7732-5238-R48	0.5	32, 36
7516-1889-R48	3.6	59, 73	7600-6031-01	21	84	7732-5238-S48	0.5	32, 36
7516-1889-S48	3.7	59, 73	7600-6032-05	25	85	7732-5241-S48	0.5	32, 36
7516-1902-R48	4.6	59, 73	7600-7530-02	17	92	7732-5345F-R48	0.7	32, 36
7516-1902-S48	4.5	59, 73	7610-1137-80	73	62	7732-5348A-S48	0.7	32, 36
7516-1915-S48	6.0	59, 73	7610-1143-80	86	62	7733-1345A-42	0.8	39
7516-1927-S48	6.8	59, 73	7610-1155-80	107	62	7733-1651A-R48	1.0	39, 52, 66
7516-2602A-S48	4.3	59, 73	7610-1161-80	120	62	7733-1651A-S48	0.9	39, 52, 66
7516-2689A-S48	3.6	59, 73	7610-1243-80	92	62	7733-1657A-S48	1.2	39, 52, 66
7516-4889-R48	4.3	59, 73	7610-1443-80	84	62	7733-1664-S48	1.7	39, 52, 66
7516-4889-S48	4.5	59, 73	7620-1892-S48	5.2	61	7733-1876-S48	1.8	39, 52, 66
7516-4902-R48	6.3	59, 73	7620-1896-S48	5.3	61	7733-4651-R48	1.2	52, 66
7516-4902-S48	6.3	59, 73	7620-1902-S48	6.5	61	7733-4651-S48	1.2	52, 66
7516-4915-R48	8.4	59, 73	7620-1915-R48	7.3	61	7733-4864-S48	2.4	52, 66
7516-4915-S48	8.3	59, 73	7620-1915-S48	7.6	61	7733-5241-S48	0.7	39
7516-4927-S48	11	59, 73	7620-1927-S48	9.0	61	7733-5243A-S48	0.7	39
7516-5502A-C60	4.0	59, 73	7620-1940-S48	13	61	7733-5245A-S48	0.8	39
7516-5589A-C60	3.6	59, 73	7620-1952-S48	14	61	7733-5248A-S48	0.9	39
7516-5652-S48	9.3	73	7620-4902-S48	7.6	61	7733-5251A-S48	1.0	39
7516-7502A-C60	6.3	59, 73	7620-4915-R48	9.4	61	7733-5343A-R48	0.7	39
7516-7589A-C60	4.3	59, 73	7620-4915-S48	9.8	61	7733-5345A-R48	0.8	39
7516-7889A-S48	4.4	59, 73	7620-4927-S48	13	61	7733-5345A-S48	0.8	39
7516-7902-R48	5.7	59, 73	7620-4940-S48	16	61	7733-5348A-R48	0.9	39
7516-7902-S48	5.8	59, 73	7620-4952-S48	19	61	7733-5348A-S48	0.9	39
7516-7915-S48	8.3	59, 73	7620-7902-S48	7.6	61	7733-5443B-R48	0.7	39
7516-7989-R48	4.3	59, 73	7620-7915-S48	9.6	61	7733-5445B-R48	0.8	39
7516-7989-S48	4.3	59, 73	7620-7927-S48	13	61	7733-5545A-C60	0.6	39
7517-1654A-S48	1.0	54, 68	7620-7940-S48	14	61	7733-5548A-C60	0.8	39
7517-4654-R48	1.3	54, 68	7620-7952-S48	16	61	7733-5551A-C60	0.8	39, 52, 66
7517-4657-R48	1.5	54, 68	7620-8702-R48	8.0	61	7733-5557A-C60	1.1	52, 66
7525-8476-R65	3.4	75	7620-8792-R48	6.1	61	7733-5564A-C60	1.3	52, 66
7528-5652-S65	11	76	7620-8792-S48	6.1	61	7733-5602P-S48	3.2	41
7528-6989-S65	4.5	76	7620-8796-R48	7.0	61	7737-4433-R48	0.4	31
7528-7389-R65	4.5	76	7620-8796-S48	6.2	61	7737-5235-R48	0.4	31
7528-8489-R65	4.0	76	7640-7653-80	112	62	7737-5238A-R48	0.4	31
7529-5604A-S65	30	77	7640-8716-80	39	62	7737-5241-R48	0.5	31
7529-5652-S65	11	77	7640-8743-80	106	62	7737-5345-R48	0.5	31
7529-6652-S48	9.0	77	7660-8743-80	104	62	7738-1448-42	1.0	45
7529-6902-S65	5.2	77	7721-4802-S48	2.1	41, 44, 46	7738-1651A-R48	1.0	45
7529-7302-R65	5.7	77	7721-4827-S48	3.6	41, 44, 46	7738-1651A-S48	0.9	45
7529-7315-R65	8.2	77	7721-4889-S48	1.5	41, 44, 46	7738-4654A1-R48	1.3	47
7529-8402-R65	5.3	77	7722-4864-S48	0.9	37, 38, 41	7738-5348A-R48	1.0	45
7529-8415-R65	5.9	77	7722-4876-S48	1.3	37, 38, 41	7738-5348A-S48	1.0	45
7600-3689-01	11	88	7722-4889-S48	1.7	37, 38, 41	7738-5602P-S48	2.7	46
7600-3699-01	14	88	7723-4802-S48	3.6	67, 70	7739-5237-S48	0.5	38
7600-3712-01	15	88	7723-4827-S48	5.2	67, 70	7739-5238-R48	0.6	38
7600-6014-02	13	84	7731-1038-42	0.5	30	7739-5238-S48	0.6	38
7600-6022-03	15	84	7732-1435-42	0.5	36	7739-5241-S48	0.6	38
7600-6025-02	17	84	7732-4433C-S48	0.4	36	7739-5243-S48	0.7	38

# NUMERICAL INDEX WITH WEIGHT TABLE

Partno.	Weight (kg)	Page	Partno.	Weight (kg)	Page	Partno.	Weight (kg)	Page
7767-1345A-42	0.8	42	7803-3576-01	4.8	86, 93	7821-5440	2.7	46
7767-1651A-R48	1.0	42	7803-3581-02	2.5	86	7821-6740	2.7	44
7767-1651A-S48	1.0	42	7803-3583-02	3.0	86	7822-1526	1.9	38
7767-1664-S48	1.6	42	7803-3588-01	3.4	86, 93	7822-2526	1.3	37
7767-1876-S48	1.7	42	7803-3590-03	3.9	85	7822-3526	1.5	41
7767-4651A-S48	1.1	42	7803-3590-03	3.9	86	7823-2647	4.6	70
7767-5243A-S48	0.7	42	7803-3591-01	4.1	93	7823-3647	4.4	67
7767-5245A-S48	0.8	42	7803-3602-30	2.1	81	7832-3301	1.2	96
7767-5248A-S48	0.8	42	7803-3652-01	3.7	87	7833-4301	1.8	96
7767-5343A-R48	0.7	42	7803-3656-02	4.1	87	7833-4401	1.9	96
7767-5345A-R48	0.8	42	7803-4700-01	3.7	81	7834-4401	2.3	96
7767-5345A-S48	0.9	42	7803-4700-50	2.7	81	7839-3301	1.4	96
7767-5348A-R48	0.9	42	7803-4703-01	3.7	85	7851-1308-20	2.4	30
7767-5348A-S48	0.9	42	7803-4720-01	3.8	92	7851-1312-20	3.6	30
7767-5443B-R48	0.7	42	7803-4725-01	3.3	92	7851-1316-20	3.8	30
7767-5445B-R48	0.8	42	7803-4726-01	2.8	92	7852-2309-20	3.6	33
7767-5545A-C60	0.8	42	7803-7500-61	3.0	85, 90, 91	7852-2312-20	4.6	33
7767-5602P-S48	3.0	44	7803-7531-01	3.9	82	7852-2315-20	5.7	33
7770-4433-B48	0.3	26	7803-7535-02	4.2	82	7852-2318-20	6.9	33
7770-4435-B48	0.3	26	7803-7543-60	4.1	91	7852-2324-20	9.0	33
7770-5233-B48	0.2	26	7803-7547-01	2.6	81	7852-2331-20	12	33
7770-5235-B48	0.3	26	7803-7549-01	2.6	81	7852-3112-20	5.7	33
7770-5433-B48	0.2	26	7803-7557-01	5.4	82	7852-3121-20	10	33
7770-9030-42	0.3	26	7803-7585-01	5.1	82	7852-3131-20	6.4	33
7770-9032-42	0.3	26	7803-7586-01	5.4	82	7853-2418-20	6.9	36
7770-9035-42	0.4	26	7803-7663-01	2.0	81	7853-2421-20	8.4	36
7776-1938-B48	0.2	28	7803-7664-01	5.7	82	7853-2424-20	9.5	36
7776-1940-B48	0.3	28	7803-7672-01	3.2	81	7853-2426-20	10	36
7776-4432-B48	0.3	28	7804-3590-03	4.1	85, 86, 87	7853-2427-20	11	36
7776-4435-B48	0.3	28	7804-3652-01	3.9	87	7853-2429-20	16	36
7776-4436-B48	0.2	28	7804-4700-01	4.1	81	7853-2431-20	12	36
7776-4438-B48	0.3	28	7804-4720-01	3.9	92	7853-2433-20	12	36
7776-4440-B48	0.3	28	7804-4993-01	5.5	89	7853-2437-20	14	36
7788-5232-B48	0.3	29	7804-7531-01	4.2	82	7853-3026-20	14	36
7788-5233-B48	0.3	29	7804-7535-02	4.5	82	7853-3031-20	16	36
7788-5235-B48	0.4	29	7804-7536-01	4.4	82	7853-3312-20	6.3	67
7788-5238-B48	0.3	29	7804-7554-01	5.2	82	7853-3315-20	8.0	67
7795-5232-B48	0.2	26	7804-7585-01	5.3	82	7853-3318-20	9.8	67
7795-5235-B48	0.3	26	7805-6015	10	91	7853-3324-30	13	53
7795-5238-B48	0.3	26	7805-7015	10	91	7853-3331-30	16	53
7795-6428-B48	0.2	26	7807-6103-11	1.1	31	7853-3337-30	20	53
7795-6430-B48	0.2	26	7807-6103-11	1.1	80	7853-5109-20	5.5	67
7801-6103-11	1.1	30, 80	7807-6108-11	3.0	31	7853-5112-20	7.5	67
7802-6103-11	1.1	33, 80	7807-6116-11	5.0	31	7853-5115-20	9.1	67
7802-6108-11	2.8	33	7807-6124-11	7.7	31	7853-5118-20	11	67
7802-6110-11	3.5	33	7807-6132-11	12	31	7853-5131-20	18	53
7802-7103-14	1.4	80	7807-6136-11	13	31	7853-5137-20	21	53
7802-7103-21	1.6	80	7807-7103-30	1.3	31, 80	7853-7624-20	12	38
7802-7124-30	13	33	7807-7567-01	1.0	81	7853-7627-20	14	38
7802-71373-30	20	33	7807-7570-01	0.9	81	7853-7631-20	15	38
7802-7567-01	1.0	81	7809-7567-01	1.2	81	7853-7637-20	20	38
7803-3100-30	2.0	86	7821-3440	2.8	41	7853-7643-20	21	38

HANDHELD AND SMALL HOLE DRILLING

FACEDRILLING AND BOLTING

BENCH DRILLING

LONG HOLE DRILLING

SHANK ADAPTERS

AUXILIARY TOOLS

GRINDING EQUIPMENT

INFORMATION AND BIT CLASSIFICATION GUIDE

# NUMERICAL INDEX WITH WEIGHT TABLE

Partno.	Weight (kg)	Page	Partno.	Weight (kg)	Page	Partno.	Weight (kg)	Page
7854-8624-20	16	40	795-1690	2.0	97	797-5400-14	0.1	113
7854-8631-20	20	40	795-1699	4.9	97	797-5400-16	0.1	113
7854-8637-20	24	40	795-1960	4.9	97	797-5400-18	0.1	113
7854-8643-20	27	40	795-1961	18	97	7985-6315-26	28	75
7854-8649-20	31	40	795-1962	0.6	97	7985-6318-26	32	75
7854-9631-20	24	40	795-1963	18	97	7991-3331	0.4	30
7854-9637-20	28	40	795-1964	240	97	7992-3335	0.7	33
7854-9643-20	34	40	795-2600	6.6	97	7993-3644	0.9	36, 38, 53, 67
7854-9649-20	37	40	795-2601	10	97	7994-3655	1.7	40
7854-9655-20	42	40	795-2604	10	97			
7857-4821-20	6.4	31	7953-4618-20	16	53, 67			
7857-4831-20	10	31	7955-5618-20	24	70			
7870-1140-11	13	27	7955-5637-20	48	56			
7870-1144-11	14	27	7956-6318-21	24	72			
7870-1148-11	15	27	7956-6337-70	46	58			
7870-1156-11	18	27	7956-7637-70	78	58			
7870-1164-11	20	27	7957-7618-20	40	74			
7870-1172-11	23	27	7957-7637-70	76	60			
7870-1180-11	25	27	7957-8737-70	89	60			
7870-1188-11	27	27	796-1858	1.6	114			
7870-5124-11	7.9	27	796-1862	0.05	114			
7870-5132-11	10	27	796-1863	0.02	114			
7870-6106-11	2.2	27	796-1865	0.2	114			
7870-6112-11	4.1	27	796-1866	1.0	114			
7870-6118-11	6.0	27	796-1867	0.3	114			
7870-6120-11	6.5	27	797-1101-25	1.4	112			
7870-6124-11	8.0	27	797-1101-32	1.7	112			
7870-6131-11	9.5	27	797-1185-28	1.6	112			
7870-6132-11	10	27	797-1190-23	3.3	112			
7870-6137-11	11	27	797-1190-29	4.1	112			
7876-6106-11	2.2	28	797-1190-32	4.5	112			
7876-6108-11	2.7	28	797-1227-10	1.1	111			
7876-6112-11	4.1	28	797-1227-15	1.0	111			
7876-6116-11	5.0	28	797-1250-10	3.4	111			
7876-6118-11	5.9	28	797-1252-10	1.8	111			
7876-6120-11	6.4	28	797-5295-07	0.04	113			
7876-6124-11	8.0	28	797-5295-08	0.04	113			
7876-6131-11	9.6	28	797-5295-09	0.1	113			
7876-6136-11	11	28	797-5295-10	0.1	113			
7888-6124-11	7.6	29	797-5295-11	0.1	113			
7888-6132-11	10	29	797-5295-12	0.1	113			
795-1343	0.02	114	797-5295-13	0.1	113			
795-1396	0.01	114	797-5295-14	0.1	113			
795-1604A	1.9	97	797-5295-16	0.1	113			
795-1605	3.9	97	797-5295-18	0.1	113			
795-1606	0.6	97	797-5400-07	0.04	113			
795-1607A	3.9	97	797-5400-08	0.04	113			
795-1608	6.0	97	797-5400-09	0.1	113			
795-1609A	8.4	97	797-5400-10	0.1	113			
795-1613	1.7	97	797-5400-11	0.1	113			
795-1676	0.9	97	797-5400-12	0.1	113			
795-1681	1.5	97	797-5400-13	0.1	113			







