

“SAS SUPER 100/180”, “SAS ISOLATOR”, “DUO SAS 360”, “DUO SAS ISOLATOR”

INSTRUCTIONS MANUAL



*Carefully read this Manual before operating your instrument.
This document is the property of VWR International PBI srl Milan
It may not be duplicated or distributed without the owner's authorisation*

REFERENCES

FDA – 1987 Guideline on Sterile Drug Products produced by Aseptic Process

ACGIH – Guideline for the Assessment of Bioaerosol in the Indoor Environment

ASTM – Draft Protocol – Committee D22.05.06

USP 23-NF 18 8th Supplement 1116 (May 1998) – Microbiological Evaluation of Clean Rooms and other Controlled Environments

EU Guide for GMP – Manufacture of Sterile Medicinal Products Control of Medicines and Inspection

CEN/TC 243 Norms for Clean Room Technology

For any further information please contact:

United States



11333 Woodglen Drive
Rockville MD 20852 Telephone

Telephone: 301-231-7400

Fax: 301-231-7277

E-mail: BioInfo@Biosci-Intl.com

United Kingdom



7 & 8 Launton Business Centre
Murdock Road
Bicester OX26 4XB

Telephone: +44 (0) 1869 355 500

Fax: +44 (0) 1869 355 545

E-mail: sales@cherwell-labs.co.uk

Rev.9 September 2012

INSTRUCTIONS MANUAL

READ CAREFULLY THIS HANDBOOK

SAFETY INSTRUCTIONS

- Use the device **just for the indicated purposes**.
- **The Device must be correctly used according to this instructions manual, before starting any operation.**
- **Replace immediately any electrical cable when damaged;** never use a damaged or worn electrical cable.
- **Always disconnect the charger before:**
 - A. Repairing or maintenance; these operations must be carried out by qualified staff;
 - B. Keep the unit clean;
- **Use original spare parts and accessories for any replacement;**
- **Do not use this device in the presence of explosive gas.**

GENERAL CAUTION



CAUTION

Be aware that the voltage and frequency of the electrical system are compatible with the electrical requirements of the battery charger.



CAUTION

Never use a non-OEM charger to charge the air sampler. Use of improper charger may damage the unit.

SUMMARY

Main Index

SUMMARY.....	3
SECTION 1 - BRIEF INSTRUCTIONS.....	5
1.1. Brief instructions for SAS Super 100 / 180 and SAS Isolator	5
1.2. Brief operating instructions for DUO SAS Super 360 - DUO SAS Isolator.....	5
SECTION 2 - INTRODUCTION.....	6
2.1. Principle of Surface Air System.....	6
2.2. The basic idea.....	6
2.3. The practical use of contact plates.....	7
2.4. SAS models available.....	7
SECTION 3 - FIRST OPERATIONS.....	9
3.1. Preliminary inspection.....	9
3.2. “55 mm Contact Plates” Holder Adjustment.....	10
3.3. “84 mm Maxi-Contact Plates”.....	10
3.4. Volume of agar in each plate.....	10
3.5. Tripod installation (optional).....	11
3.6. List of menu and utility sub-menu.....	11
SECTION 4 - OPERATIONS AND MENUS.....	12
4.1. Operations.....	12
4.2. Start with the same air volume as the previous sample	12
4.3. “Standard mode” function.....	13
4.4. “User mode” function.....	13
4.5. “Program mode” function.....	14
4.6. “Delay mode” function.....	15
4.7. “Multimode” function.....	15
4.7.1. Start a multimode sampling cycle.....	16
4.8. “Utility mode” function.....	17
4.8.1. “Set time”.....	17
4.8.2. “Mode”.....	17
4.8.3. “Set autoswitch”.....	18
4.8.4. “Print”.....	18
4.8.5. “Display record”.....	18
4.8.6. “Clear record”.....	19
4.8.7. “Language”.....	19
4.8.8. “Identify”.....	19
4.8.9. “Sampling Site”.....	20
4.8.10. “Calibration due” OPTIONAL FEATURE.....	20
4.9. List of all system message.....	21
4.10. Accessories.....	21
4.10.1. Battery charger.....	21
4.10.2. Remote control.....	22
4.10.3. SAS Software.....	22
4.10.4. SAS Printer.....	22
SECTION 5 – MAINTENANCE.....	23
5.1. Air Sampler Disinfection.....	23
5.2. Validation and Calibration.....	23
5.3. Performance routine monitoring.....	24
5.4. Battery replacement.....	24
5.5. Troubleshooting.....	25

SECTION 6 – SAMPLING PROCEDURE.....	26
6.1. Contact Plate handling.....	26
6.2. Use of the air sampler in Clean Areas.....	26
6.3. Contact Plates preparation.....	27
6.4. Adjustable “Contact Plate” holders.....	27
6.5. Sampling time required for different air volumes.....	27
6.5. Total Bacterial Count and/or micro-organisms identification by dilution.....	28
6.6. Multi Point Sampling with several independent air samplers.....	28
6.7. Final operations.....	29
6.8. Calculation of results.....	29
6.8.1. Colony Forming Units per 1000 litres of air.....	29
6.9. Data recording.....	32
SECTION 7 - SPECIFICATIONS.....	33
7.1. Specifications.....	33
7.2. SAS Components Description.....	34
7.3. Automatic switch off.....	35
SECTION 8 - ACCESSORIES.....	36
8.2. SAS Model.....	36
8.2. Accessories and spare part list.....	36
8.2. Control and Validation Systems.....	36
SECTION 9 – IDENTIFICATION SHEET.....	37
SECTION 10 – SAS ISOLATOR.....	38

SECTION 1 - BRIEF INSTRUCTIONS

1.1. Brief instructions for SAS Super 100 / 180 and SAS Isolator

The air flow is displayed after the automatic presentation every time the instrument is switched on.

Press ON/OFF switch.

Press START button to sample the same air volume of the last sampling cycle.

To change the air volume, use the arrow buttons and select “Standard Mode” from menu.

Refer to the instruction manual to change settings.

Press ENTER to confirm selection.

Press arrows for menu selection to modify other pre-set parameters:



Press ENTER to reach the sub-menu of the chosen parameter.

Refer to instruction manual to change settings.

Press ON/OFF switch at the end of sampling operations.

Press “CLEAR” each time you need to end an action. Then the unit will come back to the initial configuration.

1.2. Brief operating instructions for DUO SAS Super 360 - DUO SAS Isolator

Press the ON/OFF switch (black button).

When the display will show the message SELECT HEAD, press ENTER.

Press “UP” or “Down” arrows to select the “LEFT HEAD” or the “RIGHT HEAD” or “LEFT+RIGHT HEAD”.

Press ENTER to confirm selection.

Press START button to sample the same air volume as the last sampling time.

To change the volume of air or other parameters, follow the given instructions for SAS Super 100 and SAS Super 180.

SECTION 2 - INTRODUCTION

2.1. Principle of Surface Air System

The Surface Air System (SAS) encompasses several models which use the same principle.

Air is aspirated at a fixed speed for variable time through a head which has been machined with a series of small holes of a special design. The resulting laminar air flow is directed onto the agar surface of a “RODAC Plate” (or a Petri dish) containing medium for the microbiological analysis. When the selected sampling cycle is completed, the plate is removed and incubated. The organisms are then visible to the naked eye and can be counted for the assessment of the contamination level.

2.2. The basic idea

The key features of the Surface Air System (SAS) are:

- A. To use a simple and inexpensive “Contact Plate” (“SURFAIR PLATE”, “RODAC”) for surface, hands or air control. These plates are very well known and easily available. They can be purchased ready poured with different media.
- B. To sample a known volume of air for a variable time to provide a range of sampling volumes.
- C. To aspirate air in a laminar flow pattern with sufficient velocity to impact organisms onto an agar surface.
- D. To accumulate data on the level of hygiene in each environment so that fluctuation can be monitored.
- E. To take advantage of advanced electronics for more reliable results in different operating conditions.
- F. To have the flexibility to choose between 55 mm Contact Plates, 84 mm Maxi Contact Plates or 90 mm Standard Petri Dishes.
- G. To apply cGLP and cGMP to air sampling operations.
- H. To organize sequential sampling to obtain a more representative sample under actual operating conditions.

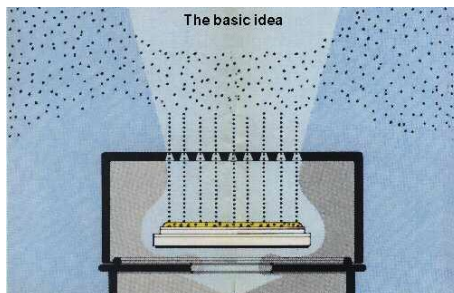

2.3. The practical use of contact plates

THE PRACTICAL USE OF “CONTACT PLATES” FOR AIR CONTROL SAS SUPER FLOW SCHEME

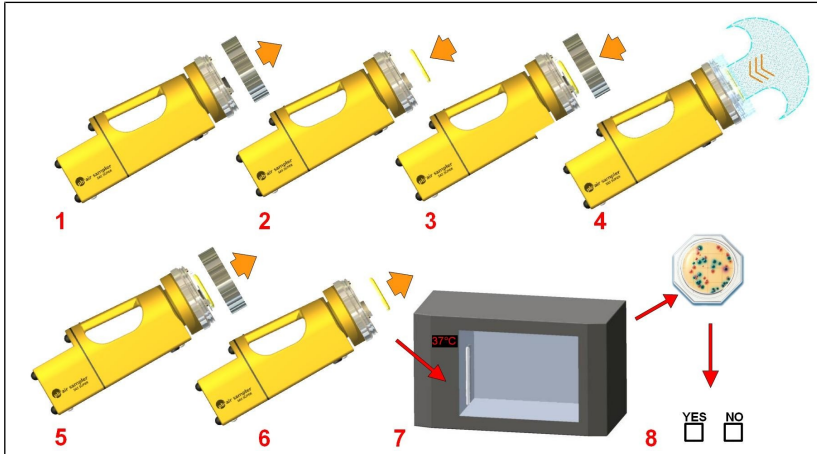

1. Remove the aspirating head.
2. Insert an identified, closed and prepared Contact Plate and remove plate lid.
3. Place the aspirating head back onto the sampler.
4. Select the required air volume and start the unit. The air flow is directed onto the agar surface of the Contact Plate.
5. At the end of the cycle, remove the aspirating head.
6. Close and remove the Contact Plate.
7. Incubate the Contact Plate
8. Count the colonies, record the results on the microbiological air sampling report and analyse the results.

2.4. SAS models available

2.4.1. SAS SUPER 100 and SAS SUPER 180:



Two instruments for two different applications.

The two air samplers have the same performances; the only difference between them is the airflow aspiration rate:

SAS SUPER 100 = 100 litres of air per minute

SAS SUPER 180 = 180 litres of air per minute.

The SAS SUPER 180 is appropriate for use in Clean Rooms and other applications demanding low sampling times. In Clean Rooms, for example, it is important to test a larger volumes of air, because the microbial air contamination is very low.

The SAS SUPER 180 reduces the required time to obtain a sample with an important saving of time.

Both SAS SUPER 100 and SAS SUPER 180 are identified by the “SAS SUPER” logo on the right side of the instrument.

The SAS SUPER 180 air sampler is recognizable by the SAS SUPER 180 logo that appears on the display when the operator turns on the unit.

2.4.2. DUO SAS SUPER 360:

The instrument is based on the SAS Super 100/180 model, but it includes two heads that can work alone or together



2.4.3. SAS ISOLATOR

Critical air monitoring in isolator and barrier environments

It consists of a programmable unit which remains outside the controlled area and an independent sampling head which uses RODAC Contact Plates or Standard 90 mm Petri dishes. See Section 10.



2.4.4. DUO SAS SUPER 360:

The instrument is based on the SAS Super Isolator model, but it includes two heads that can work alone or together



SECTION 3 - FIRST OPERATIONS

3.1. PRELIMINARY INSPECTION

The apparatus is subject to specific quality tests before shipment and it is carefully packed to avoid possible damage during transit. However, a visible check should be carried out as soon as possible to determine any transit damage. This must be reported immediately. The following procedures should be followed to check that the unit is working properly.

The battery pack of the instrument must be charged for at least 14 hours before running the test.

SAS SUPER 100, SAS SUPER 180 AND SAS ISOLATOR

After the ON/OFF button is pressed an automatic visual presentation will be displayed.

In the following displays, the characters “XX” indicates numerical figures.

INTERNATIONAL
PBI

S/N 10-D-XXXX
Rev. 5.XX-XXXX

PRESS ARROW FOR
NEW MENU SELECT

* S.SAS 100 L. *

ID 0000
SITE AAAA

START FOR XXX
MM/DD/YY - HH:MM

Push the START button to start a sampling cycle with the displayed volume of air.

[XX] → XXX
MM/DD/YY - HH:MM

The motor will run until the figures in brackets reach the same figure displayed to the right and then it will stop. During the sampling the two red leds are flashing (*see position 9 and 20 in the picture of section 7*).

DUO SAS Super 360 - DUO SAS Isolator

After the ON/OFF button is pressed, an automatic visual presentation appears. In the following display, the entry of “XX” indicates numerical figures.

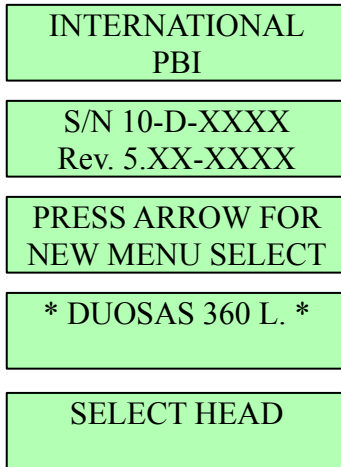

Select the desired head by “UP” or “DOWN” arrows and press ENTER
Push the START button to start a sampling cycle with the displayed volume of air.

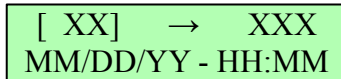

The motor will run until the figures in brackets reach the same figure as displayed to the right and then it will stop. During the sampling the two red LEDs are flashing (*see position 9 and 20 in the pictures in Section 7*).

3.2. “55 mm CONTACT PLATES” HOLDER ADJUSTMENT

The Contact Plate holders can be adjusted (using an allen screw) in case the available plates slightly differ in diameter from the standard 55 mm Contact Plate (see the figure in the Chapter 6.4).

3.3. “84 mm MAXI-CONTACT PLATES”

If high fungal contamination is expected in the sampled air, Maxi-Contact Plates are suggested. This is because moulds tend to spread and consequently make counting difficult after incubation.

The “84 mm Maxi-Contact Plates” are inserted into the SAS SUPER 100 or SAS SUPER 180 using a special adaptor (Cat.n. 19123). For more details see Application Note N. 89.

3.4. Volume of agar in each plate

For a correct sampling efficiency, it is important to respect the plate agar medium volume as recommended by the air sampler supplier (e.g. 16-18 ml of agar medium in 55mm contact plate) to obtain the correct impact of air on the agar surface.

3.5. Tripod installation (optional)

The SAS can be fixed to a table tripod or a floor tripod. The threaded connection is located under the unit, between the two front feet. When not in use, the screw is protected by a threaded plug.

3.6. List of menu and utility sub-menu

MENU	DESCRIPTION
START FOR XXX	This message indicates the air sampler is ready to sample the volume shown
STANDARD MODE	With this function the air sampler can be set to select one of 8 fixed standard sampling volumes
USER MODE	With this function the air sampler can be set to select one of 8 programmable sampling volumes
PROGRAM MODE	With this function you can to modify the 8 programmable sampling volumes
DELAY MODE	With this function the air sampler can be set to start after a programmable delay
MULTI MODE	With this function the air sampler can be programmed to extend the total sampling time using “sequential interval time” sampling
UTILITY MODE	This function led to the following Sub-Menu:
	<i>SET TIME</i> To adjust date and time
	<i>SAMPLING SITE</i> To identify the sampling point
	<i>IDENTIFY</i> To identify the operator’s name
	<i>LANGUAGE</i> To display text in different languages
	<i>CLEAR RECORD</i> To clear the recorded sampling data
MENU'	DESCRIPTION
	<i>DISPLAY RECORD</i> To show the recorded sampling data
	<i>PRINT</i> To export the recorded sampling data
	<i>AUTO SWITCH OFF</i> To disconnect the automatic switch off when the “Infrared Remote” is used
	<i>MODE</i> To select the aspiration mode between single and multiple
	<i>CALIBRATION DUE</i> To check the calibration due date

SECTION 4 - OPERATIONS AND MENUS

4.1. Operations

Push the Main switch (black button) to switch on the unit.

The Main switch (black button) must be pushed twice to switch on the unit if the automatic switch off timer operated when last used.

Press “CLEAR” at any time to return to the initial “START FOR” main screen.

The air sampler is provided with eight fixed air volumes (“Standard Mode”) stored in the memory and eight programmable air volumes (“User Mode”) selectable by the operator.

The selection of the volume is made by pressing the “▲” or “▼” buttons when the program is in the relevant sub-menu.

The following volumes of air are suggested:

- Contaminated areas (communities, processing rooms, etc.) 10-200 litres of air
- Normal areas (laboratory benches, houses, etc.) 200-500 litres of air
- Sterile or high risk areas (clean rooms, operating theatres, etc.) 500-1000 litres of air.

4.2. Start with the same air volume as the previous sample

SAS SUPER 100, SAS SUPER 180 & SAS ISOLATOR

Switch on the SAS with the black on/off switch, after the initial presentation the main screen will be displayed

START FOR XXX
MM/DD/YY - HH:MM

Push the START button to start a sampling cycle with the displayed volume of air.

[XX] → XXX
MM/DD/YY - HH:MM

DUO SAS SUPER 360 - DUO SAS Isolator

Switch on the SAS with the black on/off switch, after the initial presentation the head selection screen will be displayed

SELECT HEAD

Select the desired head by “▲” or “▼” arrows and press ENTER, the main screen will be displayed

START FOR XXX
MM/DD/YY - HH:MM

Push the START button to start a sampling cycle with the displayed volume of air.

[XX] → XXX
MM/DD/YY - HH:MM

4.3. “Standard mode” function

The *Standard mode* function allows the operator to select a sampling volume from a list of eight standard volumes.

Switch on the instrument and wait until the main screen is displayed:

START FOR XXX
MM/DD/YY - HH:MM

Press the “▼” or “▲” button to reach the

STANDARD MODE
MM/DD/YY - HH:MM

Press the “ENTER” button, now you can scroll the eight sampling volume. The selectable volumes are 10, 20, 30, 50, 100, 200, 500, 1000 liters).

S.PROG XXXX
MM/DD/YY - HH:MM

Once the desired sampling volume has been reached press the “ENTER” button to confirm. The instrument is now ready to sample the selected volume of air.

Press the “START” button to begin the sampling cycle

START FOR XXX
MM/DD/YY - HH:MM

4.4. “User mode” function

If the operator wish to use volumes other than the standards volumes, up to 8 additional volumes can be programmed into the unit.

The user-selectable volumes can be selected form the *User Mode*, while the selectable volumes can be modified using the *Program mode* function describe in the next paragraph

Switch on the instrument and wait until the main screen is displayed:

START FOR XXX
MM/DD/YY - HH:MM

Press the “▼” or “▲” button to reach the

USER MODE
MM/DD/YY - HH:MM

Press the “ENTER” button, now you can scroll the eight sampling volumes user-defined.

S.PROG XXXX
MM/DD/YY - HH:MM

Once the desired sampling volume has been reached press the “ENTER” button to confirm.
The instrument is now ready to sample the selected volume of air.
Press the “START” button to begin the sampling cycle

START FOR XXX
MM/DD/YY - HH:MM

The total number of available “*USER MODE*” programs is eight.
The maximum volume of air for each sampling cycle is 1999 litres.

4.5. “Program mode” function

Using this procedure, it is possible to memorise up to eight different volumes (from 1 to 1999 litres of air).
(See chapter 4.4.).
Switch on the instrument and wait until the main screen is displayed:

START FOR XXX
MM/DD/YY - HH:MM

Press the “▼” or “▲” button to reach the

PROGRAM MODE
MM/DD/YY - HH:MM

Press the “ENTER” button, now you can scroll the eight user-selectable sampling volumes.

S.PROG XXXX
MM/DD/YY - HH:MM

Once the sampling volume to be modified has been reached, press the “ENTER” button to confirm.

The display will show the old volume and the new volume.

XXX → 0000
MM/DD/YY - HH:MM

Press the “▼” or “▲” button to select the first digit and press “ENTER” to confirm

XXX → X000
MM/DD/YY - HH:MM

Press the “▼” or “▲” button to select the second digit and press “ENTER” to confirm
Repeat the previous step until the last digit, when the last digit is confirmed, the new volume will be memorized and added to the list of eight user-selectable volume. If you want to start a sampling cycle with the new value you have to enter the *User mode* and select it by using the procedure described in paragraph 4.3

4.6. “Delay mode” function

With this function it is possible to delay the beginning of the sampling cycle. If a delay has been selected, the sampling cycle will begin after the selected delay time. Switch on the instrument and wait until the main screen is displayed:

```
START FOR   XXX
MM/DD/YY - HH:MM
```

Press the “▼” or “▲” button to reach the

```
DELAY MODE
MM/DD/YY - HH:MM
```

Press the “ENTER” button, the delay time is displayed

```
DELAY 01 MIN
MM/DD/YY - HH:MM
```

Select the desired delay time with the “▼” or “▲” button. The selectable delay values are 1, 2, 3, 5, 10 or 20 minutes. Press “ENTER” button to confirm.

When a delay has been selected, after the “START” button has been pressed, a delay warning message will be displayed

```
**  D E L A Y  **
```

4.7. “Multimode” function

This program is very useful for extending the time of sampling with the purpose of obtaining a more representative environmental sample “in actual operating conditions”. The total air volume to be sampled is aspirated with two or more sub-volume aspirations (E.g.:1000 litres in ten runs of 100 litres at five minute intervals).

Before entering the *MULTI MODE* you should therefore decide:

- (a) total volume of air to be sampled onto the Contact Plate;
- (b) number of runs;
- (c) interval time between runs.

See Application Note N.95 for more details.

Switch on the instrument and wait until the main screen is displayed:

```
START FOR   XXX
MM/DD/YY - HH:MM
```

Press the “▼” or “▲” button to reach the

```
MULTI MODE
MM/DD/YY - HH:MM
```

Press the “ENTER” button, the interval time is displayed

INTERVAL TIME
05 MIN

Select the desired interval time between runs with the “▼” or “▲” button. The selectable interval values are 5, 10, 15, 20, 25, 30, or 60 minutes.

Press “ENTER” button to confirm the interval time, the numbers of runs is displayed

NUMBER OF RUNS
20 NC

Select the desired number of cycles with the “▼” or “▲” button. The selectable values are 2, 3, 4, 5, 6, 7, 8, 9, 10, 15 or 20 runs.

Press “ENTER” button to confirm the number of runs, the single run volume is displayed

SINGLE RUN VOL.
XXXX

Select the desired digit with the “▼” or “▲” button then press the “ENTER” button to skip to next digit. When all the digits have been selected the total volume is displayed

TOT. L. XXXX

Press “ENTER” button to confirm.

NOTE:

Before running the multimode sampling, set the aspirating mode to MULTIMODE (see paragraph 4.8.2)

4.7.1. Start a multimode sampling cycle

Before running the multimode sampling, set the aspirating mode to MULTIMODE (see chapter 4.8.2) .

When the sampler aspiration mode is set to MULTIMODE, the main display will show alternately the number of cycles and the volume of each cycle:

START FOR
MM/DD/YY - HH:MM

NC 02x1000 L.
MM/DD/YY - HH:MM

Press the “START” button to run the multiple sampling, the display will show the aspirating volume in the first row and the residual number of the cycle in the second row:

[XX] → XXX
- 02 CYCLES

At the end of the run, during the interval, the number of “residual cycles” (runs) that are remaining are shown on the display:

- 02 CYCLES
** D E L A Y **

4.8. “Utility mode” function

With this function it is possible to modify all the settings of the air sampler. The UTILITY MODE is divided into ten sub-menus:

Set time; Mode; Set Autoswitch; Print; Display Record; Clear Record; Language; Identify; Sampling site; Calibration due.

Always start from UTILITY MODE to reach one of these SUB-MENU. Switch on the instrument and wait until the main screen is displayed:

START FOR XXX
MM/DD/YY - HH:MM

Press the “▼” or “▲” button to reach the

UTILITY MODE
MM/DD/YY - HH:MM

Press the “ENTER” button, the first sub-menu is listed:

4.8.1. “Set time”

From the UTILITY MODE select the “SET TIME” function
This option is used to program day, month, year and time of the day.

SET TIME
MM/DD/YY - HH:MM

Press ENTER and “▲” or “▼” button to change month
Press ENTER and “▲” or “▼” button to change day
Press ENTER and “▲” or “▼” button to change year
Press ENTER and “▲” or “▼” button to change hours
Press ENTER and “▲” or “▼” button to change minutes
Press ENTER to confirm and exit

4.8.2. “Mode”

From the UTILITY MODE select the “MODE” function
This option is used to select the aspirating mode between the SINGLE MODE and MULTIMODE

MODE
MM/DD/YY - HH:MM

Press ENTER and “▲” or “▼” button to change between SINGLE MODE and MULTIMODE

MULTI MODE
MM/DD/YY - HH:MM

SINGLE MODE
MM/DD/YY - HH:MM

Select the desired aspirating mode and press ENTER to confirm and exit.
This setting will be stored in memory even after the instrument is switched off.

4.8.3. “Set autoswitch”

To save battery consumption the SAS automatically switches off after 4 minutes. The *Set autoswitch* option is used to enable or disable the automatic switch off.

From the UTILITY MODE select the “SET AUTOSWITCH” function

SET AUTOSWITCH
MM/DD/YY - HH:MM

Press ENTER and “▲” or “▼” button to change between the two options

AUTOSWITCH ON
MM/DD/YY - HH:MM

AUTOSWITCH OFF
MM/DD/YY - HH:MM

Select the desired options and press ENTER to confirm and exit.
This setting will be lost after the instrument is switched off.

4.8.4. “Print”

The SAS can be connected with a RS232 cable to the SAS printer (cod. 89960) or to a Personal Computer with the SAS Software (cod. 89996). This function is used to start the data transfer from the SAS to the external device.

From the UTILITY MODE select the “PRINT” function

PRINT
MM/DD/YY - HH:MM

Press ENTER to start sending the data, the display will show:

SENDING DATA

For more information see the printer or software user manual.

4.8.5. “Display record”

The last 99 samples are memorized in the file “DISPLAY RECORD”. Each sample is identified in chronological order and shows the date, time, operator, site and volume of air sampled.

From the UTILITY MODE select the “Display record” function.

DISPLAY RECORD
MM/DD/YY - HH:MM

Press ENTER to see the memorized values

001 MM/DD HH:MM
ID. /SITE VOL. OP

The following parameter are recorded:

Progressive number; Month and Day; Time; Identification / Site; Sampling Volume; Option

If there is no data stored in memory the display will show

```
* * * * *
* * * * *
```

4.8.6. "Clear record"

This option is used to delete all the data memorized in the "DISPLAY RECORD". Before starting this procedure, please be certain that existing data is not required or that it has been downloaded. From the UTILITY MODE select the "Clear record" function.

```
CLEAR RECORD
MM/DD/YY - HH:MM
```

Press ENTER to delete all the stored data, the display will show the resetting status

```
RESETTING...
▶▶▶▶
```

4.8.7. "Language"

The text of the Menus may be selected choosing from different languages. From the UTILITY MODE select the "LANGUAGE" function

```
LANGUAGE
MM/DD/YY - HH:MM
```

Press ENTER to list all the available languages,

```
ENGLISH
```

Use the "▲" or "▼" button to select the desired language and press ENTER to confirm.

There are six available languages:

English, French, Spanish, German, Portuguese and Italian

4.8.8. "Identify"

This option is used to identify the operator. This should be changed if different operators uses the sampler and especially if the data is to be printed.

From the UTILITY MODE select the "IDENTIFY" function.

```
IDENTIFY
MM/DD/YY - HH:MM
```

Press ENTER to modify the identification code

IDENTIFY
XXXX

Select the desired character with the “▲” or “▼” button and confirm with ENTER
Select the next desired characters and confirm them by pressing ENTER
The selected value is stored in the memory and it will be kept also after the instrument has been switched off.

4.8.9. “Sampling Site”

The site identification should be changed for samples taken at different sites especially if the results are to be printed.
From the UTILITY MODE select the “SAMPLING SITE” function.

SAMPLING SITE
MM/DD/YY - HH:MM

Press ENTER to modify the sampling site

SAMPLING SITE
XXXX

Select the desired character with the “▲” or “▼” button and confirm with ENTER
Select the next desired characters and confirm them by pressing ENTER
The selected value is stored in the memory and it will be kept also after the instrument has been switched off.

4.8.10. “Calibration due” OPTIONAL FEATURE

The SAS air sampler can be equipped with a calibration reminder feature. With this function the user can see when the next calibration should be performed.
From the UTILITY MODE select the “CALIBRATION DUE” function.

CALIBRATION DUE
MM/DD/YY - HH:MM

Press ENTER to see the next calibration date:

NEXT CAL
MM/YYYY

The display show the month in which the calibration should be performed.
One month before the calibration due, the SAS will display the following warning message:

CALIBRATION DUE
MM/YYYY

When this message is displayed, press ENTER to acknowledge.

When the calibration has expired, the SAS will display the following warning message:

CAL EXPIRED

When this message is displayed, press ENTER to acknowledge.
 The calibration timer can be reset only by a qualified technician.

4.9. List of all system message

Besides the messages described in the previous paragraph, the following messages can be displayed:

LOW BATTERY	The battery of the instrument must be recharged
MOTOR ERROR	Motor not working or not connected
- OFF	The instrument is switching off
NEXT CAL	The calibration due is approaching
CAL EXPIRED	The calibration due is expired

4.10. Accessories

4.10.1. Battery charger

When the message LOW BATTERY is flashing, the air sampler must be recharged.

1. Switch off the unit.
2. Connect the smaller plug of the battery charger to the battery socket on the SAS SUPER 100 or SAS SUPER 180.
3. Connect the battery charger to the main supply (220-240 or 110 Volts): verify that the LEDS on the charger are lit correctly (see label on charger).
4. The air sampler is recharged after 14 hours using the normal battery charger “Revit“ (Cat. 19248).
5. When the green led of the battery charger is lit, disconnect the charger from the mains supply.
6. At the end of operation, disconnect the battery charger plug from the socket of the air sampler.

NOTES

- a) The correct metal hydrate battery charger must be used to charge the SAS !
- b) If the air sampler has not been used for several weeks, check the battery status!
- c) This battery pack, using the SAS SUPER 100 sampler, should provide approximately 5-7 hours of sampling time. (50% less in SAS SUPER 180).
- d) Before using for the first time, or after a storage time of one month or more, charge battery for 14 hours. If you do not reach the rated battery capacity during initial use, repeat the 14 hours charge process.
- e) Battery performance will degrade if the SAS is used in an out of specs environment.
- f) The Metal Hydrate battery has a self-discharge rate and, without use, will lose about 2% of its charge per day.
- g) To prevent injury or burns, do not allow metal objects to contact or short circuit the battery terminals.
- h) The Metal Hydrate battery may explode if disposed in fire.

4.10.2. Remote control

The SAS microbiological air samplers can be used with an optional Infrared Remote Control (cod. 18950). With the remote it is possible to start the sampling cycle from distance. When the remote control is going to be used, the autoswitch-off timer must be disabled following the procedure described in the paragraph 4.8.3. The automatic switch off option will be re-activated by switching off the air sampler with the Main Switch (black button).
When the auto switch off option is disabled, remember to switch off the instrument after use to save the battery.

4.10.3. SAS Software

The SAS microbiological air samplers can be used with an optional Software (cod. 89996). With the SAS Software it is possible to download the sampling information to a PC through the RS-232 SAS cable (cod. 26025). The data can be stored in the PC, printed and exported in xls or pdf format.

4.10.4. SAS Printer

The SAS microbiological air samplers can be used with an optional printer (cod. 89960). With the SAS printer it is possible to print the sampling information directly to the SAS printer.

SECTION 5 – MAINTENANCE

5.1. Air Sampler Disinfection

The SAS SUPER 100, SAS SUPER 180, DUO SAS 360, SAS Isolator, DUO SAS Isolator do not require special care and maintenance procedures.

- Do not subject the air sampler to sudden shock.
- Clean the air sampler with a soft damp cloth and a mild detergent. Do not use harsh abrasives.
- Do not submerge in water; do not pour or spray water directly on the air sampler.
- Do not use acetone or other volatile solvents for cleaning.
- Do not use chlorine or fluorine-based products to disinfect the stainless steel head.

- Body of the Sampler

The plastic body of the unit can be wiped with a mild chemical agent and disinfected with alcohol wipe or swab.

- Contact Plate Housing Head

The unit complete with the sampling head can be disinfected using a disinfecting aerosol (e.g.: Isopropyl alcohol sterile spray cod. 18223) held at about 30 cm from the head when the fan is running. 30 seconds are sufficient to disinfect the air path.

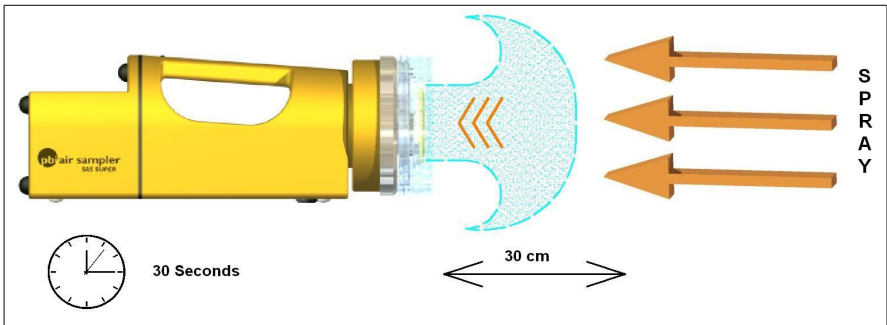

- Cover of the Head

The sampling head with its protective plastic lid should be autoclaved at a minimum temperature of 121°C for at least 15 min, following the good sterilization practice. Alternatively, the sampling head can be sanitised by treating the inside and outside surfaces with a disinfecting alcohol wipe or swab.

5.2. Validation and Calibration

The motor speed and consequently the air flow are related to the electrical power supply, motor bearing conditions, etc. It is therefore suggested that the unit should be validated at least every six/twelve months.

The validation of the air flow rate should be done by a certified anemometer in a wind tunnel.

This type of certification may be performed by the manufacturer or an official distributor.

When an Official Calibration is requested, a certified anemometer must be used to meet the required traceability characteristics (i.e. FDA inspections require a Calibration Certificate that is traceable to know standard such as the NIST).

5.3. Performance routine monitoring

The SAS SUPER 100, SAS SUPER 180, DUO SAS SUPER 360, SAS Isolator, DUO SAS Isolator should be checked monthly / bimonthly (depending on how often they are used) using the “Pyramid” units to monitor that they are working correctly and their performances has not been affected by bad handling or damage.

NOTE: The “Pyramid” is to be used for internal validation only (i.e. to verify the correct working conditions of the air sampler).

5.4. Battery replacement

1. Take out the three caps (Position 1) from the lower part of the control panel.
2. Unscrew the three fixing screws (Position 2) that fix the control block.
3. Slide the control block (Position 3) from the instrument body (Position 6).

Caution: disconnect battery pack immediately

4. Disconnect the two pin connectors (Position 4) from the battery.
5. Take out the old battery, replace it with a new one, and connect the new battery.
6. Reassemble the control block to the instrument body in the reverse order. Be sure the rubber sealing ring (Position 5) is correctly positioned.

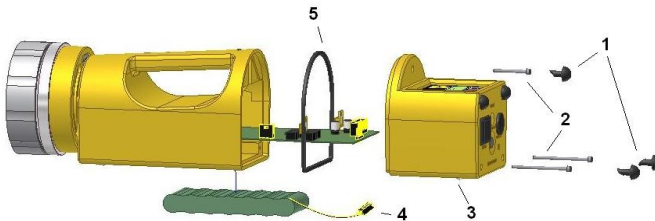

5.5. Troubleshooting

PROBLEM	SUGGESTED ACTION
Unit does not start	<ul style="list-style-type: none"> - Push ON/OFF switch (black button) The ON/OFF main switch must be pushed twice to switch on the unit if the automatic switch off operated at the end of the last cycle - Recharge battery - Check the battery charger - Replace battery.
Battery discharges after few minutes working	<ul style="list-style-type: none"> - Recharge battery - Check the battery charger - Replace the charger
“LOW BATTERY” message	<ul style="list-style-type: none"> - Recharge battery
Infrared remote switch doesn't switch on the unit	<ul style="list-style-type: none"> - Replace infrared remote battery
Microbiological media is dehydrated after sampling	<ul style="list-style-type: none"> - Control expiration date of media and that the agar is not dehydrated before sampling

SECTION 6 – SAMPLING PROCEDURE

6.1. Contact Plate handling

- Disinfect the cover of the air sampler at the beginning of each sampling program treating the inside and the outside part with a disinfecting alcohol wipe or swab.
- The cover with its protective plastic lid can be autoclaved at 121°C for 15 minutes. If this procedure is to be repeated regularly, a s/s head is recommended. It is therefore useful to have available several heads ready to use. Alternatively, the unit can be sanitised using a disinfecting aerosol at about 30 cm from the head when the fan is running. Thirty seconds are sufficient to disinfect the air path.
- Remove the cover of the air sampler by unscrewing it, holding the edge of the cover. Avoid touching the inside and outside of the drilled area.
- Insert a closed filled “Contact Plate” into the retaining slots and then remove its lid. Avoid contamination from droplets and aerosol infection.
- Replace the sampling head and start the air aspiration cycle. At the end of the cycle, unscrew the sampling head, replace the “Contact Plate” lid and remove the “Contact Plate”.
- Be sure each “Contact Plate” is identified with the appropriate sample data.
- Incubate the “Contact Plate” for the specified time at the appropriate temperature.
- At the end of incubation count the number of visible organisms (C.F.U.) and relate this number to the volume of air sampled.

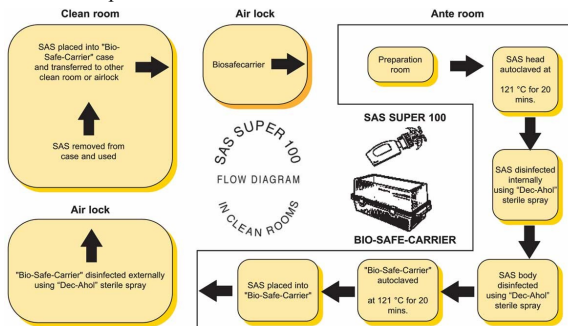

6.2. Use of the air sampler in Clean Areas

The sampling head should be autoclaved and the body of the unit wiped with a mild chemical agent.

Note.

The air sampler is a scientific instrument and its surface should be disinfected using an aerosol and not a liquid!

The unit should be protected with a sterile bag and then transferred into the Clean Area.

It is important to wear sterile gloves when handling the “Contact Plates” and the head of the air sampler to prevent bacteriological contamination.

Use double packed, gamma irradiated “Contact Plates” to avoid possible clean environment contamination.

For more details see Application Notes N.15, 31, 55, 63, 68, 83, 95, 99.

6.3. Contact Plates preparation

It is important that the volume of media dispensed into a “Contact Plate” is constant for the type of plate used. An excess volume can create a convex surface that is too high and which may touch the inside of the sampler head. An insufficient volume will create a concave surface, unsuitable for representative colony growth using SAS System.

The volume of agar in a “55 mm Contact Plate” should be 16-18 ml and in a ”84 mm Maxi-Contact Plate” 24-26 ml.

For more details see Application Note N.78.

6.4. Adjustable “Contact Plate” holders

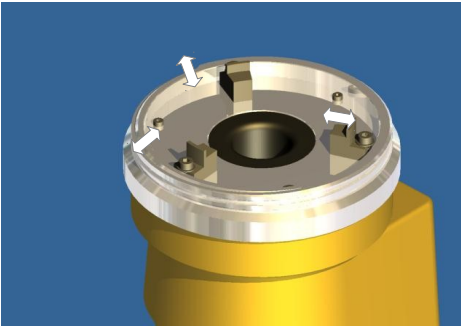

The SAS SUPER 100/180, DUO SAS 360, SAS ISOLATOR, DUO SAS Isolator air samplers are designed for use with standard “Contact Plates”. The plate holders are adjustable to allow different brands of Contact Plate to be fitted.

Adjustable plate holders in the sampler head allow the operator to use contact plates from many sources without concern for slight differences in plate size.

6.5. Sampling time required for different air volumes

SAS SUPER 100

SAS SUPER 180

LITRES OF AIR	TIME REQUIRED	LITRES OF AIR	TIME REQUIRED
50	30 seconds	90	30 seconds
100	1 minutes	180	1 minute
200	2 minutes	360	2 minutes
300	3 minutes	540	3 minutes
400	4 minutes	720	4 minutes
500	5 minutes	900	5 minutes
600	6 minutes	1000	5 minutes 30 seconds
700	7 minutes		
800	8 minutes		
900	9 minutes		
1000	10 minutes		

6.5. Total Bacterial Count and/or micro-organisms identification by dilution

In normal conditions, if sampling is correctly performed, the colonies are easily counted and collected for identification on the agar surface of the Contact Plate. If very high colony count is expected, if inhibitors are expected in the air being sampled or if the micro-organisms are to be incubated at different temperatures, the dilution method should be applied.

The total amount of agar of the Contact Plate is aseptically transferred to a Stomacher bag, sterile diluent is added and the Stomacher treatment is applied for one minute. The usual plating technique and/or identification procedures are applied to the processed diluent.

6.6. Multi Point Sampling with several independent air samplers

A progressive simultaneous operation monitoring in a closed environment can be organised using several SAS Super 100 air samplers programmed with different starting delay times and sequential interval steps.

The air samplers can be positioned on a different walls using a support arm (cat. n. 19834) to allow 45°C inclination. At the end of operation, the air samplers are collected for Contact Plate transfer and / data export to paper by printer or PC.

This type of organisation allows:

- (a) to reduce staff labour involved in sampling;
- (b) to reduce microbial contamination risk because the enclosed environment is monitored “in operation”;
- (c) to obtain complete written report on air sampling.

AREA	Position	SAS s/n	Single Air Volume	Total Air Volume	Sub Sample number	Sampling interval	Start delay
A	A1	1.210	-	1.000	-	-	5
	A2	1.211	200	1.000	5	30	-
	A3	1.213	250	1.000	4	30	-
B	B1	1.214	250	1.000	4	30	-
	B2	1.215	200	1.000	5	30	-
C	C1	1.216	-	1.000	-	-	20

- (a) Air sampler SAS SUPER 100 Serial Number 1210 was positioned in AREA A on site A1 and programmed for a total air volume of 1000 litres in one run, starting after 5 minutes from the switching on of the instrument.
- (b) Air sampler SAS SUPER 100 Serial Number 1211 was positioned in AREA A on site A2 and programmed for a total air volume of 1000 litres in five times (200 litres during each run) with interval times of 30 minutes.
- (c) Air sampler SAS SUPER 100 Serial Number 1213 was positioned in AREA A on site A3 and programmed for a total air volume of 1000 litres in four times (250 litres during each run) with interval times of 30 minutes.
- (d) Air sampler SAS SUPER 100 Serial Number 1214 was positioned in AREA B on site B1 and programmed for a total air volume of 1000 litres in four times (250 litres during each run) with interval times of 30 minutes.
- (e) Air sampler SAS SUPER 100 Serial Number 1215 was positioned in AREA B on site B2 and programmed for a total air volume of 1000 litres in five times (200 litres during each run) with interval times of 30 minutes.

- (f) Air sampler SAS SUPER 100 Serial Number 1216 was positioned in AREA C on site C1 and programmed for a total air volume of 1000 litres in one run, starting after 20 minutes from the switching on of the instrument.

6.7. Final operations

Switch off the ON/OFF Main switch (black button).

The unit will switch off automatically after 4/5 minutes, if the “switchg off option” has not been disabled for Infrared Remote Control use.

6.8. Calculation of results

6.8.1. Colony Forming Units per 1000 litres of air

The number of organisms counted on the surface of the “Contact Plate” must first be corrected for the statistical possibility of multiples particles passing through the same hole. The statistical formula is taken from work by J. Maker. Correction Tables are given below for both the 55 mm standard Contact head, the 84 mm Maxi-Contact head and the Petri head. The probable count (Pr) is then used to calculate the Colony Forming Unit (CFU) per cubic metre of air sampled.

**CORRECTION TABLE TO ADJUST COLONY COUNTS FROM A 219-HOLE IMPACTOR USING
55 mm CONTACT PLATES OR 90 mm PETRI PLATES**

Coloni es r	MPN Pr	Coloni es r	MPN Pr	Coloni es r	MPN Pr	Coloni es r	MPN Pr	Coloni es r	MPN Pr	Coloni es r	MPN Pr
1	1	38	42	75	92	112	156	149	249	186	412
2	2	39	43	76	93	113	158	150	252	187	418
3	3	40	44	77	95	114	160	151	255	188	425
4	4	41	45	78	96	115	162	152	258	189	432
5	5	42	46	79	98	116	165	153	261	190	439
6	6	43	48	80	99	117	167	154	265	191	447
7	7	44	49	81	101	118	169	155	268	192	455
8	8	45	50	82	102	119	171	156	271	193	463
9	9	46	51	83	104	120	173	157	275	194	471
10	10	47	53	84	106	121	176	158	278	195	480
11	11	48	54	85	107	122	178	159	282	196	489
12	12	49	55	86	109	123	180	160	286	197	499
13	13	50	57	87	110	124	182	161	289	198	508
14	14	51	58	88	112	125	185	162	293	199	519
15	15	52	59	89	114	126	187	163	297	200	530
16	17	53	60	90	116	127	189	164	301	201	542
17	18	54	62	91	117	128	192	165	305	202	554
18	19	55	63	92	119	129	194	166	309	203	567
19	20	56	64	93	121	130	196	167	313	204	580
20	21	57	66	94	122	131	199	168	317	205	595
21	22	58	67	95	124	132	201	169	322	206	611
22	23	59	69	96	126	133	204	170	326	207	627
23	24	60	70	97	128	134	206	171	331	208	646
24	25	61	71	98	130	135	209	172	335	209	666
25	26	62	73	99	131	136	212	173	340	210	687
26	28	63	74	100	133	137	214	174	344	211	712
27	29	64	76	101	135	138	217	175	349	212	739
28	30	65	77	102	137	139	220	176	354	213	770
29	31	66	78	103	139	140	222	177	359	214	807
30	32	67	80	104	141	141	225	178	365	215	851
31	33	68	81	105	142	142	228	179	370	216	905
32	34	69	83	106	144	143	231	180	375	217	978
33	36	70	84	107	146	144	234	181	381	218	1088
34	37	71	86	108	148	145	237	182	387	219	1307
35	38	72	87	109	150	146	240	183	393		
36	39	73	88	110	152	147	243	184	399		
37	40	74	90	111	154	148	246	185	405		

r = colony forming units counted
Pr = probable count

**CORRECTION TABLE TO ADJUST COLONY COUNTS FROM A 401-HOLE IMPACTOR USING
55 mm CONTACT PLATES OR 90 mm PETRI PLATES**

Coloni es r	MPN Pr	Coloni es r	MPN Pr	Coloni es r	MPN Pr	Coloni es r	MPN Pr	Coloni es r	MPN Pr	Coloni es r	MPN Pr
1	1	41	43	81	90	121	144	161	206	201	278
2	2	42	44	82	92	122	145	162	207	202	280
3	3	43	45	83	93	123	147	163	209	203	282
4	4	44	47	84	94	124	148	164	211	204	284
5	5	45	48	85	95	125	150	165	212	205	287
6	6	46	49	86	97	126	151	166	214	206	289
7	7	47	50	87	98	127	152	167	216	207	291
8	8	48	51	88	99	128	154	168	217	208	293
9	9	49	52	89	100	129	155	169	219	209	295
10	10	50	53	90	102	130	157	170	221	210	297
11	11	51	54	91	103	131	158	171	223	211	299
12	12	52	56	92	104	132	160	172	224	212	301
13	13	53	57	93	106	133	161	173	226	213	303
14	14	54	58	94	107	134	163	174	228	214	305
15	15	55	59	95	108	135	164	175	230	215	307
16	16	56	60	96	110	136	166	176	231	216	310
17	17	57	61	97	111	137	167	177	233	217	312
18	18	58	63	98	112	138	169	178	235	218	314
19	19	59	64	99	114	139	170	179	237	219	316
20	20	60	65	100	115	140	172	180	239	220	318
21	22	61	66	101	116	141	173	181	240	221	321
22	23	62	67	102	118	142	175	182	242	222	323
23	24	63	68	103	119	143	177	183	244	223	325
24	25	64	70	104	120	144	178	184	246	224	327
25	26	65	71	105	122	145	180	185	248	225	330
26	27	66	72	106	123	146	181	186	250	226	332
27	28	67	73	107	124	147	183	187	251	227	334
28	29	68	74	108	126	148	184	188	253	228	336
29	30	69	76	109	127	149	186	189	255	229	339
30	31	70	77	110	128	150	188	190	257	230	341
31	32	71	78	111	130	151	189	191	259	231	343
32	33	72	79	112	131	152	191	192	261	232	346
33	34	73	80	113	133	153	192	193	263	233	348
34	35	74	82	114	134	154	194	194	265	234	351
35	37	75	83	115	135	155	196	195	267	235	353
36	38	76	84	116	137	156	197	196	269	236	355
37	39	77	85	117	138	157	199	197	271	237	358
38	40	78	87	118	140	158	201	198	272	238	360
39	41	79	88	119	141	159	202	199	274	239	363
40	42	80	89	120	142	160	204	200	276	240	365

Example of calculation of results

$$X = \frac{Pr * 1000}{V}$$

Where:

- V = Volume of sampled air = 200 litres of air
- r = Colony Forming Units counted on “ 55 mm Contact Plates” = 67
- Pr = Probable count obtained by positive hole correction = 80
- x = Colony Forming Units per 1000 litres (= 1 cubic metre) of air

$$X = \frac{80 * 1000}{200} \quad 400 \text{ CFU per 1000 litres of air (1000 litres=1m}^3\text{)}$$

To express the final result in CFU/ft³ multiply the CFU/m³ value by 0,02832

6.9. Data recording

All data related to instrument identification, operator’s name, sampling site, date and hour of sampling, type of media, CFU may be reported on the specific software “*SAS software*” .

SECTION 7 - SPECIFICATIONS

7.1. Specifications

Principle:	Air-borne micro-organisms are collected on microbiological agar by impaction produced by aspiration.	
Nominal Air Flow Rate:	SAS SUPER 100 = 100 litres of air per minute SAS SUPER 180 = 180 litres of air per minute SAS ISOLATOR = 100 or 180 litres of air per minute DUO SAS 360 - DUO SAS Isolator = 180 litres of air per minute (each head)	
Range of Air Sample Volume:	10, 20, 30, 50, 100, 200, 500, 1000 litres are permanently memorised (Standard Mode); up to eight other volumes can be selected and memorised by the operator (User Mode). Maximum volume of air per cycle is 1999 litres.	
Voltage:	8,4 Volts – 2700 mAh	
Temperature Working Range:	from +4°C to +40°C	
Humidity Working Range:	from 0 to 80% RH	
Battery Pack:	Rechargeable Nickel Metal Hydride (without memory effect).	
Battery Autonomy:	Aspiration of more than 40.000 litres of air	
Motor:	6 Volts, 2,8 Watts	
Size:	105x110x290 mm	
Weight:	1750 g	
Construction:	Aspirating Head:	Aluminum or stainless steel
	Motorfan:	PPO Noryl
	Housing:	Polyurethane resin

Sampling Efficiency:

The SAS SUPER 100, in a controlled environment, with aerosol of known particle size is suitable to collect micro-organisms down to 1 microns in size.

Considering the normal range of environmental micro-organisms is between 4 and 20 microns, the SAS SUPER 100 is suitable for all normal air monitoring testing (V.LACH – Journal of Hospital Infection, 1985, 6, 102-107). This condition is obtained using the standard 219 holes aspirating head.

If, for special applications or research, it is necessary to collect micro-organisms to a size of 1 micron, the 401 holes special aspirating head should be used.

This head has smaller holes to increase the velocity of particles and achieve a 100% capture efficiency on particles down to 1 micron in size.

Acoustic signal:

An acoustic signal alerts the operator when air sampling is completed.

3,0 Volts Flat Battery:

Date and hours are activated, even when air sampler is switched off, by a 3,0 V flat battery.

The instrument should be switched on during the 3,0 V flat battery replacement, to avoid loosing date and hours.

7.2. SAS Components Description

SAS Super 100 / SAS Super 180 / SAS Isolator Contact Plate Chamber

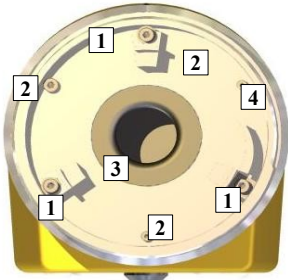

1. Adjustable holders to accommodate “Contact Plates” of different diameters
2. Screws not to be touched by the operator
3. Motor Fan
4. Contact Plate fixing spring

SAS Super 100 / SAS Super 180 / SAS Isolator Upper Panel

5. Feet for sampling in upright position
6. ON/OFF switch (black button)
7. Printer connection
8. Battery charger connection
9. Flashing LED during air sampling
10. Instrument Serial Number
11. CE mark

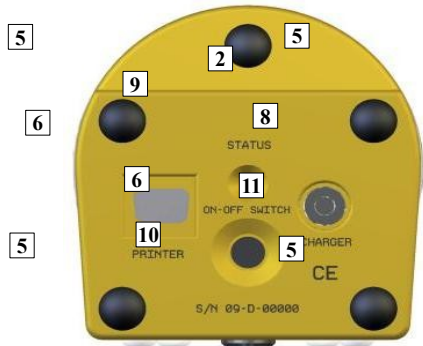

SAS Super 100 / SAS Super 180 / SAS Isolator Front Control Panel

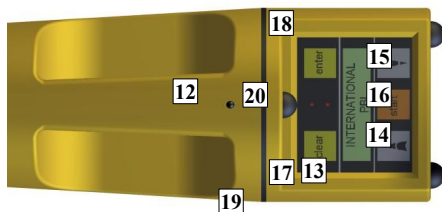

12. Infrared sensor for remote control
13. Back lit alpha-numeric visual display
14. “▲” button
15. “▼” button
16. “START” button
17. “CLEAR” button
18. “ENTER” button
19. Rubber gasket
20. Flashing LED during air sampling

SAS Super 100 / SAS Super180 / SAS Isolator Bottom Panel

- 22. Protecting screw cap for tripod connection
- 23. Instrument Brief Instructions
- 24. Gasket
- 25. Instrument feet



7.3. Automatic switch off

The instrument will automatically switch off after 4/5 minutes to save the battery.

The ON/OFF switch (black button) must be pushed twice to switch on the unit to start a cycle if the automatic switch off has operated.

SECTION 8 - ACCESSORIES

8.2. SAS Model

Cat.n. 18198-B	SAS Super 100 Contact
Cat.n. 19121-B	SAS Super 180 Contact
Cat.n. 90716	SAS Super 100 Petri
Cat.n. 90717	SAS Super 180 Petri
Cat.n. 43216-B	SAS Super Isolator 100 Contact
Cat.n. 43217-B	SAS Super Isolator 180 Contact
Cat.n. 43218-B	SAS Super Isolator 100 Petri
Cat.n. 43219-B	SAS Super Isolator 180 Petri
Cat.n. 24584-A	DUO SAS Super 360 Contact
Cat.n. 90718	DUO SAS Super 360 Petri
Cat.n. 91746	DUO SAS Super 360 Isolator Contact
Cat.n. 91796	DUO SAS Super 360 Isolator Petri

8.2. Accessories and spare part list

Cat.n. 15931	55 mm aluminium certified drilled head
Cat.n. 15503	55 mm stainless steel certified drilled head
Cat.n. 19123	84 mm aluminium certified drilled head + adaptor for Maxi Contact Plate
Cat.n. 19117	90 mm aluminium standard Petri dish head + adaptor
Cat.n. 19119	90 mm stainless steel standard Petri dish head + adaptor
Cat.n. 70003	Autoclavable plastic cover for sampling head
Cat.n. 5214	Table tripod
Cat.n. 5215	Floor tripod
Cat.n. 89722	Fixed stainless steel tripod
Cat.n. 90724	Extendible stainless steel tripod
Cat.n. 91213	Stainless steel stand
Cat.n. 19248	Normal battery charger (110 Volt)
Cat.n. 86603	Fast battery charger (220 Volt)
Cat.n. 20153	Aluminium carrying case for SAS Super 100/180
Cat.n. 18143	Soft carrying case for SAS Super 100/180
Cat.n. 86751	Aluminium carrying case for DUOSAS
Cat.n. 25094	Soft carrying case for DUOSAS
Cat.n. 18950	Infrared remote control
Cat.n. 18200	“IN OUT MH” Battery pack
Cat.n. 89960	“SAS Printer” Printer to be connected to SAS Super 100
Cat.n. 20093	Installation Qualification manual
Cat.n. 20094	Operational Qualification manual

8.2. Control and Validation Systems

Cat.n. 86666	Pyramid
--------------	---------

SECTION 9 – IDENTIFICATION SHEET

AIR SAMPLER IDENTIFICATION SHEET ACCORDING TO ISO EN 17025

According to the Document ISO EN17025, to apply the current Good Laboratory Practice, it is necessary to identify each instrument with a specific sheet. An example is here reported.

ISO EN 17025 Instrument Identification Sheet

Form n.	XXXX
Date	XXXX
Company / Institute	XXXX
Laboratory	XXXX
Name of Instrument	Microbiological Air Sampler
Model	SAS SUPER 100
Serial Number	XXXX
Name of Producer	VWR Internaitonal PBI srl
Name of Distributor	XXXX
Condition at the moment of arrival	(X) new; (x) used; (x) reconditioned
Date of Arrival	/ /
Date of initial use	/ /
Usual collocation	Room XXXX
Servicing details	See servicing POS
Instrument to be calibrated	(X) Yes; (X) No
Periodic Calibration	(X) monthly; (X) quarterly; (X) Yearly
Instrument to be validated	(X) Yes; (X) No
Periodic Validation	(X) half year; (X) yearly

SECTION 10 – SAS ISOLATOR

SAS SUPER ISOLATOR SCHEMATIC

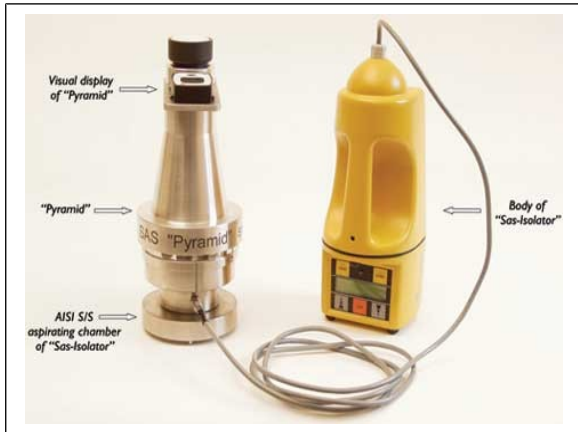
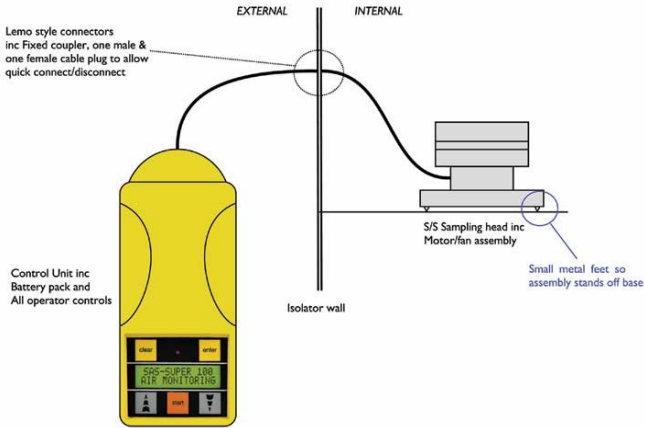

WARRANTY

WARRANTY CONDITIONS

VWR International PBI srl warrants this product to be free of defects in materials and functionality

The repairs will be carried out by VWR International PBI srl or by authorized dealers as follows:

- Faulty components free replacement
The labour is always at customer's expense
- The equipment will be sent at buyer's expenses and risk and the return will be ex-works
- This warranty does not apply to damages resulting from tampering, abnormal use and installation and does not cover transport damages
- VWR International PBI srl shall not be liable for any commercial damages, whether incidental, consequential or otherwise derived from the use of instruments

ATTENTION

TO OUR NEW CUSTOMER

As a user of our equipment you are covered for a 12 months guarantee for all spare parts as a result of mechanical failure of the machine during normal use. In order to provide you with first class service, it is essential for us to know all your references and which equipment you have. We kindly ask you therefore to fill in the attached guarantee and return the card to us by first class mail.

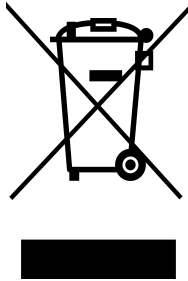

USER INFORMATIONS

The disposal of electrical devices is regulated within the European Community by national regulations based on European Directive 2002/95/EC, 2002/96/EC and 2003/108/EC pertaining to waste of electrical and electronic equipment (WEEE)

The crossed-out wheeled bin logo labelled on the equipment or on its packaging means that this product must be disposed separately from the other waste.

Because disposal regulation may differ from country to country.
For further informations please contact your supplier.