

# SAT PHYSICS SUBJECT TEST 2

TEST 2

Your responses to the Physics Subject Test questions should be filled in on Test 2 of your answer sheet (at the back of the book).

## PHYSICS SUBJECT TEST 2

75 Questions • Time limit = 1 hour • You may NOT use a calculator.

### Part A

**Directions:** Each set of lettered choices below refers to the numbered questions immediately following it. Select the one letter choice that best answers each question or best fits each statement, and then fill in the corresponding oval on the answer sheet. *A choice may be used once, more than once, or not at all in each set.*

#### Questions 1-5

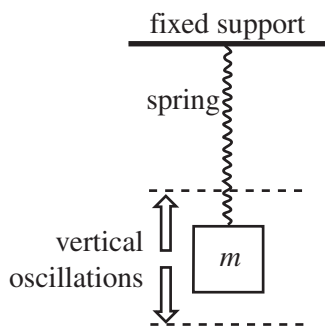

A block of mass  $m$  undergoing simple harmonic motion. Frictional forces are negligible and can be ignored. Questions 1-5 relate to the following quantities:

- (A) Amplitude
- (B) Frequency
- (C) Period
- (D) Position of block
- (E) Total mechanical energy of the block

1. Once the motion is underway, which quantity does NOT remain constant?
2. Which quantity is inversely proportional to the square root of the block's mass?
3. Which quantity would always be greater if the block oscillated with a smaller force constant?
4. The maximum speed of the block is proportional to what quantity?
5. The graph of which quantity (versus time) would look like a sine wave?

#### Questions 6-9

- (A) Alpha decay
- (B)  $\beta^-$  decay
- (C)  $\beta^+$  decay
- (D) Electron capture
- (E) Gamma decay

6. Which type of decay would cause the number of neutrons in the nucleus to decrease by 1 ?
7. In which type of decay is the identity of the nucleus unchanged?
8. Which type of decay ejects the heaviest particle?
9. Which type of decay would cause the atomic number of the nucleus to increase?

GO ON TO THE NEXT PAGE

PHYSICS SUBJECT TEST 2—Continued

Questions 10-12

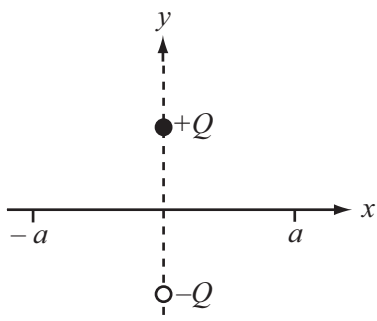

An electric dipole, a pair of equal but opposite charges. Two isolated point charges are fixed in the positions shown on the  $y$  axis; the positive charge is located at the point  $(0, b)$  and the negative charge is located at the point  $(0, -b)$ . Questions 10-12 relate to the graphs labeled (A) through (E) that appear below.

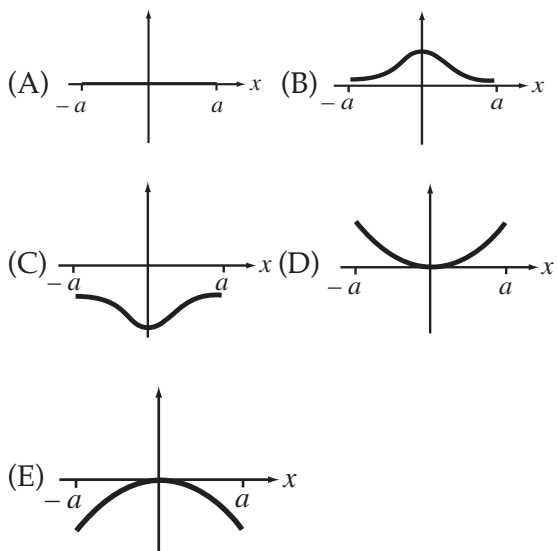

10. Which graph best depicts the electric field magnitude along the  $x$  axis, from  $x = -a$  to  $x = a$  ?
11. Which graph best illustrates the electric potential along the  $x$  axis, from  $x = -a$  to  $x = a$  ?
12. If a negative charge,  $-q$ , were moved along the  $x$  axis from  $x = -a$  to  $x = a$ , which graph best depicts the magnitude of the electric force it would feel during this motion?

GO ON TO THE NEXT PAGE

## PHYSICS SUBJECT TEST 2—Continued

### Part B

**Directions:** Each of the questions or incomplete statements below is followed by five suggested answers or completions. Select the one that is best in each case and then fill in the corresponding oval on the answer sheet.

13. Two people, one of mass 100 kg and the other of mass 50 kg, stand facing each other on an ice-covered (essentially frictionless) pond. If the heavier person pushes on the lighter one with a force  $F$ , then

- (A) the force felt by the heavier person is  $-\frac{1}{2}F$   
 (B) the force felt by the heavier person is  $-2F$   
 (C) the magnitude of the acceleration of the lighter person will be  $\frac{1}{2}$  of the magnitude of the acceleration of the heavier person  
 (D) the magnitude of the acceleration of the lighter person will be twice the magnitude of the acceleration of the heavier person  
 (E) None of the above

14. Each of the following particles is projected with the same speed into a uniform magnetic field  $B$  such that the particle's initial velocity is perpendicular to  $B$ . Which one would move in a circular path with the largest radius?

- (A) Proton  
 (B) Beta particle  
 (C) Alpha particle  
 (D) Electron  
 (E) Positron

15. Which of the following best describes the magnetic field lines created by a long, straight, current-carrying wire?

- (A) Rays that emanate from the wire  
 (B) Circles centered on the wire  
 (C) Lines parallel to the wire  
 (D) Lines perpendicular to the wire  
 (E) Noncircular ellipses centered on the wire

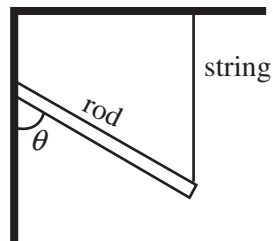

16. If the rod is uniform and has mass  $m$ , what is the tension in the supporting string?

- (A)  $\frac{(mg \sin \theta)}{2}$   
 (B)  $\frac{mg \sin}{2}$   
 (C)  $\frac{(mg \cos \theta)}{2}$   
 (D)  $\frac{mg}{2}$   
 (E)  $mg$

17. A lightweight toy car crashes head-on into a heavier toy truck. Which of the following statements is true as a result of the collision?

- I. The car will experience a greater impulse than the truck.  
 II. The car will experience a greater change in momentum than the truck.  
 III. The magnitude of the acceleration experienced by the car will be greater than that experienced by the truck.

- (A) I and II only  
 (B) II only  
 (C) III only  
 (D) II and III only  
 (E) I, II, and III

GO ON TO THE NEXT PAGE

## PHYSICS SUBJECT TEST 2—Continued

### Questions 18-19

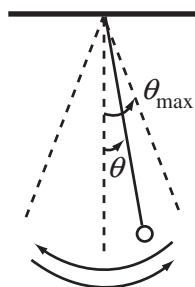

A simple pendulum, composed of a bob of mass  $m$  connected to the end of a massless rod, executes simple harmonic motion as it swings through small angles of oscillation. The largest angle the pendulum makes with the vertical is denoted by  $\theta_{\max}$ . Frictional effects are negligible and can be ignored, and the pendulum is near the surface of the earth, where  $g = 9.8 \text{ m/s}^2$ .

18. Which one of the following statements is true?
- (A) At  $\theta = 0$ , the tangential acceleration is 0.
  - (B) At  $\theta = \theta_{\max}$ , the tangential acceleration is 0.
  - (C) At  $\theta = 0$ , the speed is 0.
  - (D) At  $\theta = 0$ , the restoring force is maximized.
  - (E) At  $\theta = \theta_{\max}$ , the speed is maximized.
19. Knowing which one of the following would enable you to calculate the length of the pendulum?
- (A) The mass of the bob
  - (B) The period of the oscillations
  - (C) The tangential acceleration at  $\theta = 0$
  - (D) The maximum speed of the bob
  - (E) The acceleration at  $\theta = \theta_{\max}$

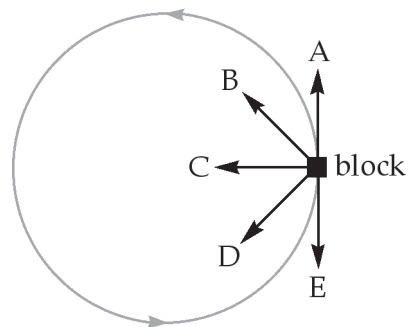

20. A block is moving counter-clockwise in a circular path on a flat table. If the speed of the block is increasing at the moment it is at the position shown, which one of the five arrows best illustrates the direction of the acceleration on the block?
- (A) A
  - (B) B
  - (C) C
  - (D) D
  - (E) E
21. If a particle of charge  $-0.2 \text{ mC}$  were placed at a certain location within an electric field, the magnitude of the electric force it would feel is  $1 \text{ N}$ . What is the magnitude of the electric field at this location? ( $1 \text{ mC} = 10^{-3} \text{ C}$ )
- (A)  $2,000 \text{ N/C}$
  - (B)  $5,000 \text{ N/C}$
  - (C)  $20,000 \text{ N/C}$
  - (D)  $50,000 \text{ N/C}$
  - (E)  $500,000 \text{ N/C}$

GO ON TO THE NEXT PAGE

## PHYSICS SUBJECT TEST 2—Continued

22. Traveling at an initial speed of  $1.5 \times 10^6$  m/s, a proton enters a region of constant magnetic field,  $B$ , of magnitude 1.0 tesla. If the proton's initial velocity vector makes an angle of  $30^\circ$  with the direction of  $B$ , compute the proton's speed 4 seconds after entering the magnetic field.

(A)  $5.0 \times 10^5$  m/s  
(B)  $7.5 \times 10^5$  m/s  
(C)  $1.5 \times 10^6$  m/s  
(D)  $3.0 \times 10^6$  m/s  
(E)  $6.0 \times 10^6$  m/s

23. An object of mass 2 kg increases in speed from 2 m/s to 4 m/s in 3 s. What was the total work performed on the object during this time interval?

(A) 4 J  
(B) 6 J  
(C) 12 J  
(D) 24 J  
(E) 36 J

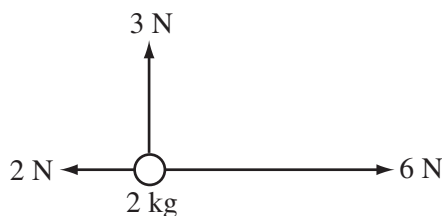

24. The figure above shows the forces acting on an object of mass 2 kg. What is the object's acceleration?

(A)  $2 \text{ m/s}^2$   
(B)  $2.5 \text{ m/s}^2$   
(C)  $3 \text{ m/s}^2$   
(D)  $3.5 \text{ m/s}^2$   
(E)  $4 \text{ m/s}^2$

25. Two traveling waves of equal frequency, one of amplitude 4 cm and the other of amplitude 6 cm, superimpose in a single medium. Which of the following best describes the amplitude,  $A$ , of the resultant wave?

(A)  $2 \text{ cm} \leq A \leq 10 \text{ cm}$   
(B)  $A = 5 \text{ cm}$   
(C)  $A = 10 \text{ cm}$   
(D)  $10 \text{ cm} \leq A \leq 12 \text{ cm}$   
(E)  $12 \text{ cm} \leq A \leq 24 \text{ cm}$

26. A uniform bar is lying on a flat table. Besides the gravitational and normal forces (which cancel), the bar is acted upon by exactly two other forces,  $F_1$  and  $F_2$ , which are parallel to the surface of the table. If the net force on the rod is zero, then which one of the following is true?

(A) The net torque on the bar must also be zero.  
(B) The bar can accelerate translationally if  $F_1$  and  $F_2$  are not applied at the same point.  
(C) The net torque will be zero if  $F_1$  and  $F_2$  are applied at the same point.  
(D) The bar cannot accelerate translationally or rotationally.  
(E) None of the above

GO ON TO THE NEXT PAGE 

PHYSICS SUBJECT TEST 2—Continued

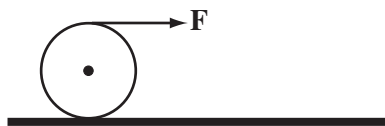

27. A uniform cylinder, initially at rest on a frictionless, horizontal surface, is pulled by a constant force  $F$  from time  $t = 0$  to time  $t = T$ . From time  $t = T$  on, this force is removed. Which of the following graphs best illustrates the speed,  $v$ , of the cylinder's center of mass from  $t = 0$  to  $t = 2T$ ?

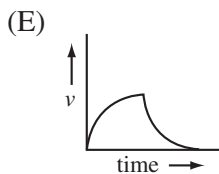
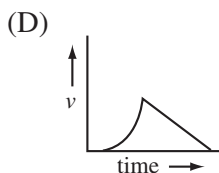
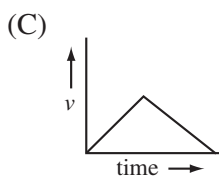
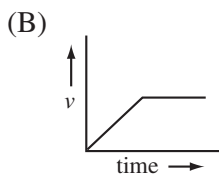
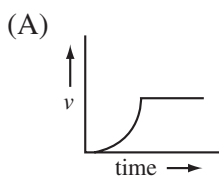

Questions 28-30

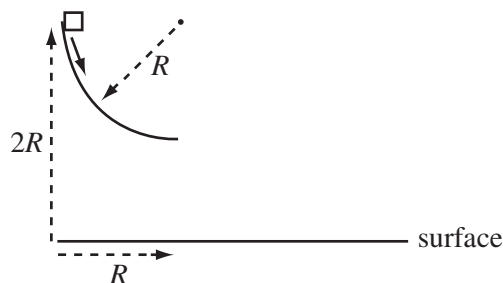

A small box slides down a frictionless track in the shape of a quarter-circle of radius  $R$ . The box starts from rest at the top of the track, a height equal to  $2R$  above a horizontal surface. At the moment the box leaves the bottom of the track, a ball of the same mass as the box is dropped from the same height at the bottom of the track.

28. How fast is the box moving when it reaches the end of the track?
- (A)  $v = \sqrt{gR}$   
 (B)  $v = \sqrt{2gR}$   
 (C)  $v = \sqrt{\pi gR}$   
 (D)  $v = \sqrt{2\pi gR}$   
 (E)  $v = \pi\sqrt{2gR}$
29. Which of the following quantities must decrease as the box slides down the track?
- (A) The normal force on the box  
 (B) The net force on the box  
 (C) The kinetic energy of the box  
 (D) The potential energy of the box  
 (E) The total mechanical energy (kinetic + potential) of the box

GO ON TO THE NEXT PAGE

## PHYSICS SUBJECT TEST 2—Continued

30. Once the box leaves the bottom of the slide, which of the following statements best describes the motions of the box and the ball?
- (A) The ball hits the floor at the same time as the box.
  - (B) The ball hits the floor before the box does.
  - (C) The ball hits the floor after the box does.
  - (D) The acceleration of the box is greater than the acceleration of the ball.
  - (E) The acceleration of the ball is greater than the acceleration of the box.

31. An ellipsoid-shaped conductor is negatively charged. Which one of the following diagrams best illustrates the charge distribution and electric field lines?

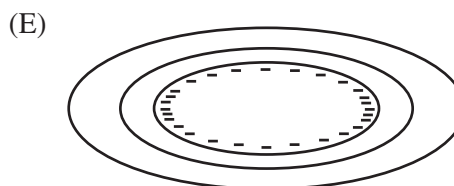
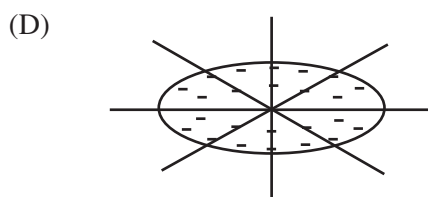
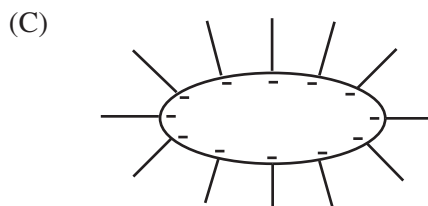
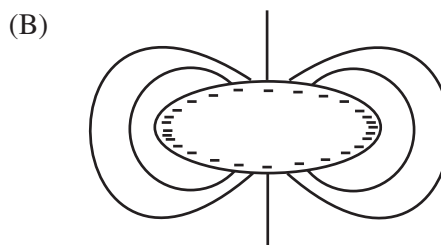
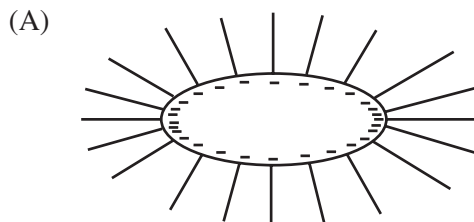

GO ON TO THE NEXT PAGE



PHYSICS SUBJECT TEST 2—Continued

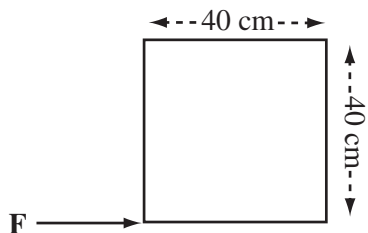

32. The figure above shows a square metal plate of side length 40 cm and uniform density, lying flat on a table. A force  $F$  of magnitude 10 N is applied at one of the corners, parallel to one of the sides, as shown. What's the torque produced by  $F$  relative to the center of the square?
- (A) 0 N-m  
 (B) 1.0 N-m  
 (C) 1.4 N-m  
 (D) 2.0 N-m  
 (E) 4.0 N-m
33. A mover, exerting a steady force of 200 N, pushes a box of mass 50 kg across a flat wooden floor. If the velocity of the box does not change while he pushes, what is the coefficient of kinetic friction between the box and the floor?
- (A) 0.2  
 (B) 0.4  
 (C) 0.5  
 (D) 0.6  
 (E) 0.8
34. What principle is the basis for the transmission of light through glass (fiber optic) cables, allowing the signal to be sent even if the cable is bent?
- (A) Photoelectric effect  
 (B) Uncertainty principle  
 (C) Light diffraction  
 (D) Light polarization  
 (E) Total internal reflection

35. A student is monitoring the pressure and absolute temperature in a container of fixed volume filled with an ideal gas as the gas is heated. Which of the following graphs best illustrates the relationship between the pressure ( $P$ ) and absolute temperature ( $T$ ) of the gas, assuming that none of the gas escapes from the container?

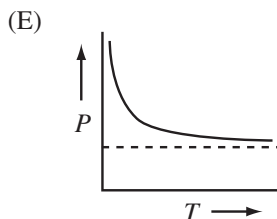
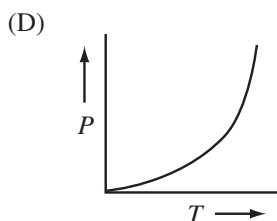
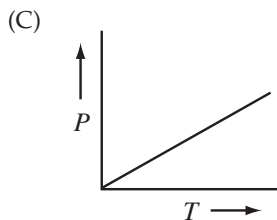
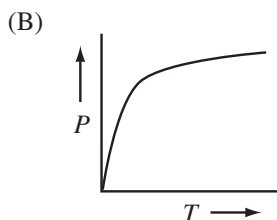
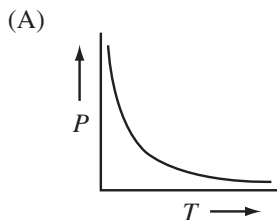

GO ON TO THE NEXT PAGE

## PHYSICS SUBJECT TEST 2—Continued

36. Of the following types of waves, which type travels at the greatest speed through vacuum?
- (A) Radio waves
  - (B) Microwaves
  - (C) Ultraviolet light
  - (D) X-rays
  - (E) None of the above; all these waves would travel at the same speed.
37. What would happen to the electrostatic force between a pair of charged particles if both charges were doubled and the distance between them were also doubled?
- (A) It would decrease by a factor of 4.
  - (B) It would decrease by a factor of 2.
  - (C) It would remain unchanged.
  - (D) It would increase by a factor of 2.
  - (E) It would increase by a factor of 4.
38. As a bat flies at a constant speed of  $0.04V$  toward a large tree trunk (where  $V$  denotes the speed of sound), the bat emits an ultrasonic pulse. The pulse is reflected off the tree and returns to the bat, which can detect and analyze the returning signal. If the returning signal has a frequency of 61 kHz, at approximately what frequency did the bat emit the original ultrasonic pulse?
- (A) 56 kHz
  - (B) 62 kHz
  - (C) 68 kHz
  - (D) 74 kHz
  - (E) 78 kHz
39. During practice, an athlete runs in a straight line from point X to point Y, and then back along the same path from Y to X. If she runs at a constant speed of 3 m/s from X to Y, and then at a constant speed of 6 m/s from Y to X, what is her average speed for the entire run?
- (A) 3.5 m/s
  - (B) 4 m/s
  - (C) 4.5 m/s
  - (D) 5 m/s
  - (E) 5.5 m/s
40. A sky diver jumps from an airplane. After “free falling” for a while, she opens her parachute and her descent speed begins to decrease. While her descent speed decreases, let  $F$  denote the magnitude of the gravitational force on the sky diver and let  $D$  denote the magnitude of the upward force of air resistance (drag). Which of the following is then true?
- (A)  $F > D$
  - (B)  $F < D$
  - (C)  $F + D < \text{weight of the sky diver}$
  - (D)  $F - D > \text{weight of the sky diver}$
  - (E)  $F - D > 0$

GO ON TO THE NEXT PAGE 

PHYSICS SUBJECT TEST 2—Continued

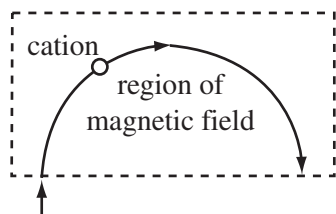

41. The figure above shows a cation (a positive ion—that is, an atom that has lost one or more electrons) entering a mass spectrometer, which contains a region with a uniform magnetic field, **B**. Once in the magnetic field, the cation moves in a semicircular path in the direction indicated. What is the direction of **B** ?
- (A) Upward in the plane of the page  
 (B) To the left in the plane of the page  
 (C) To the right in the plane of the page  
 (D) Out of the plane of the page  
 (E) Into the plane of the page
42. A traveling wave has a frequency of 6.0 Hz, an amplitude of 0.2 m, and a wavelength of 0.5 m. What is its wave speed?
- (A) 0.1 m/s  
 (B) 0.6 m/s  
 (C) 1.2 m/s  
 (D) 2.4 m/s  
 (E) 3.0 m/s

Questions 43-45

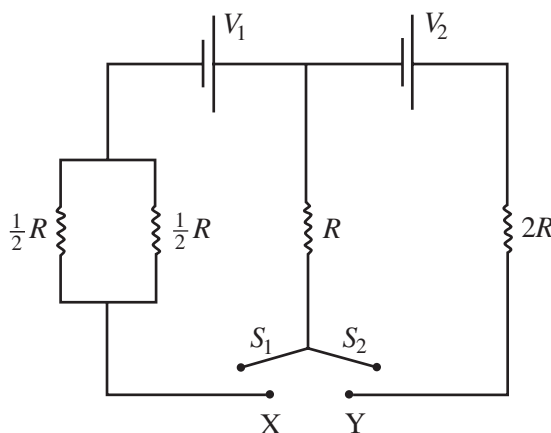

The circuit shown contains two switches:  $S_1$ , which can connect to point X, and  $S_2$ , which can connect to point Y.

43. If switch  $S_1$  is left in the position shown in the figure but switch  $S_2$  is connected to point Y, what is the current through the resistor  $R$  ?
- (A)  $\frac{V_2}{3R}$   
 (B)  $\frac{V_2}{R}$   
 (C)  $\frac{3V_2}{2R}$   
 (D)  $\frac{V_1 + V_2}{3R}$   
 (E)  $\frac{V_1 - V_2}{R}$

GO ON TO THE NEXT PAGE

## PHYSICS SUBJECT TEST 2—Continued

44. If switch  $S_2$  is left in the position shown in the diagram, but switch  $S_1$  is connected to point X, what is the current through the resistor  $R$  ?
- (A)  $\frac{V_1}{4R}$   
 (B)  $\frac{V_1}{2R}$   
 (C)  $\frac{4V_1}{5R}$   
 (D)  $\frac{5V_1}{4R}$   
 (E)  $\frac{(V_1 + V_2)}{2R}$
45. If both switches are left in the positions shown in the diagram, what is the current through the resistor  $R$  ?
- (A) 0  
 (B)  $\frac{2(V_1 + V_2)}{11R}$   
 (C)  $\frac{4(V_1 + V_2)}{13R}$   
 (D)  $\frac{2(V_1 + V_2)}{5R}$   
 (E)  $\frac{6(V_1 + V_2)}{7R}$
46. What does the second law of thermodynamics say should happen to an isolated, ordered system?
- (A) Heat will flow into the system.  
 (B) Heat will flow out of the system.  
 (C) Work will be done by the system.  
 (D) Work will be done on the system.  
 (E) The entropy within the system will increase.
47. The potential difference between the plates of a charged, parallel-plate capacitor is equal to  $X$  volts. If the amount of charge on the POSITIVE plate is equal to  $Y$  coulombs, what is the capacitance (in farads)?
- (A)  $\frac{X}{2Y}$   
 (B)  $\frac{Y}{2X}$   
 (C)  $\frac{Y}{X}$   
 (D)  $\frac{2Y}{X}$   
 (E)  $\frac{2X}{Y}$
48. A car, starting from rest, accelerates uniformly at  $4 \text{ m/s}^2$  along a straight track. How far will it travel in 6 s ?
- (A) 24 m  
 (B) 48 m  
 (C) 64 m  
 (D) 72 m  
 (E) 144 m
49. An object is executing uniform circular motion. Which of the following quantities remain(s) constant during the object's motion?
- (A) Velocity and acceleration  
 (B) Speed and velocity  
 (C) Speed and acceleration  
 (D) Acceleration only  
 (E) Speed only

**GO ON TO THE NEXT PAGE**

## PHYSICS SUBJECT TEST 2—Continued

### Questions 50-53

In the diagram accompanying each question, representative light rays from an illuminated object (labeled “O” in the diagrams) interact with an optical device (or devices): a mirror, a lens, or a combination of both. In each case, identify the optical device(s)—from among the choices below—that is/are most likely in the dotted box.

- (A) Plane mirror
- (B) Converging lens
- (C) Diverging lens
- (D) Plane mirror and a converging lens
- (E) Plane mirror and a diverging lens

50.

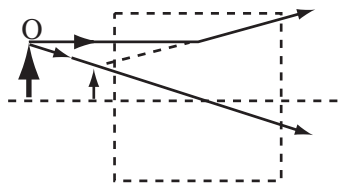

51.

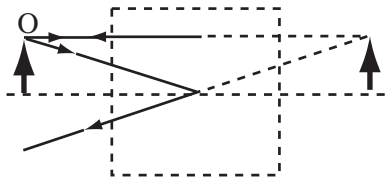

52.

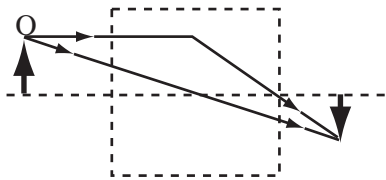

53.

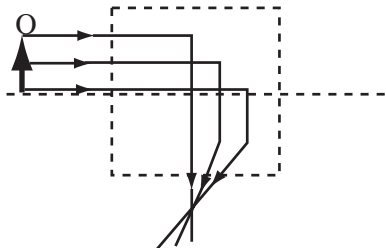

54. A superconductor is

- (A) a device used to study the collisions of subatomic particles that have been accelerated to near light speeds
- (B) a hollow, doughnut-shaped device containing a strong magnetic field for confinement of very high temperature plasmas
- (C) an element used to generate high-energy coherent laser light
- (D) an element whose supercooled vapor fills a cloud chamber to detect the tracks of charged particles when they initiate condensation of the vapor
- (E) an element or alloy whose electrical resistivity vanishes when cooled to extremely low temperatures

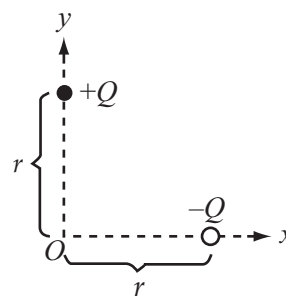

55. Two equal but opposite point charges are fixed in position on the  $x$  and  $y$  axes, as shown in the figure above. Which of the following arrows best illustrates the direction of the resulting electric field at the origin,  $O$ ?

- (A)
- (B)
- (C)
- (D)
- (E)

**GO ON TO THE NEXT PAGE**

## PHYSICS SUBJECT TEST 2—Continued

56. The planet Jupiter is 5 times farther from the sun than the earth, and the mass of Jupiter is 300 times the mass of the earth. If  $F_J$  is the strength of the gravitational force exerted by the sun on Jupiter, and  $F_E$  is the strength of the gravitational force exerted by the sun on the earth, what's the value of the ratio  $\frac{F_J}{F_E}$ ?
- (A)  $\frac{1}{60}$   
 (B)  $\frac{1}{12}$   
 (C) 8  
 (D) 12  
 (E) 60
57. Consider a double-slit interference experiment using yellow light of wavelength  $\lambda$ , with the slits labeled  $S_1$  and  $S_2$ . If  $P$  is the center of a dark fringe on the screen on which the resulting diffraction pattern is projected, which of the following equations relating  $S_1P$  and  $S_2P$ , the distances from slits  $S_1$  and  $S_2$ , respectively, to the point  $P$  could be true?
- (A)  $S_1P - S_2P = \frac{1}{2}\lambda$   
 (B)  $S_1P - S_2P = \lambda$   
 (C)  $S_1P - S_2P = 2\lambda$   
 (D)  $S_1P - S_2P = 3\lambda$   
 (E)  $S_1P = S_2P$
58. A pair of tuning forks produce sound waves that travel through the air. The frequency of the sound waves produced by the first tuning fork is 440 Hz, and the frequency of the sound waves produced by the second tuning fork is 880 Hz. If  $v_1$  denotes the speed of the sound waves produced by the first tuning fork and  $v_2$  denotes the speed of the sound waves produced by the second tuning fork, then
- (A)  $v_1 = 2v_2$   
 (B)  $v_1 = 4v_2$   
 (C)  $v_1 = v_2$   
 (D)  $v_2 = 2v_1$   
 (E)  $v_2 = 4v_1$
59. A block of aluminum and a block of iron each absorb the same amount of heat, and both blocks remain solid. The mass of the aluminum block is twice the mass of the iron block. If the specific heat of aluminum is twice the specific heat of iron, then
- (A) the increase in temperature of the aluminum block is twice the increase in temperature of the iron block  
 (B) the increase in temperature of the aluminum block is four times the increase in temperature of the iron block  
 (C) the increase in temperature of the aluminum block is the same as increase in temperature of the iron block  
 (D) the increase in temperature of the iron block is twice the increase in temperature of the aluminum block  
 (E) the increase in temperature of the iron block is four times the increase in temperature of the aluminum block

**GO ON TO THE NEXT PAGE** 

## PHYSICS SUBJECT TEST 2—*Continued*

60. If a container contains a mixture of two ideal gases (of different molecular masses) at thermal equilibrium, which of the following is true?
- (A) The average kinetic energy of the molecules of the lighter gas is less than the average kinetic energy of the molecules of the heavier gas.
  - (B) The average kinetic energy of the molecules of the lighter gas is greater than the average kinetic energy of the molecules of the heavier gas.
  - (C) The average speed of the molecules of the lighter gas is less than the average speed of the molecules of the heavier gas.
  - (D) The average speed of the molecules of the lighter gas is equal to the average speed of the molecules of the heavier gas.
  - (E) The average speed of the molecules of the lighter gas is greater than the average speed of the molecules of the heavier gas.
61. A vertically polarized plane wave (an AM radio wave) is emitted by a radio antenna and travels across flat ground. Which of the following could describe the direction of the magnetic field component of the wave?
- (A) Parallel to the ground and perpendicular to the direction of propagation
  - (B) Perpendicular to the ground and to the direction of propagation
  - (C) Parallel to the ground and to the direction of propagation
  - (D) Perpendicular to the ground and parallel to the direction of propagation
  - (E) Parallel to the electric field component of the wave
62. Which of the following best describes the relationship between the frequency and amplitude of a sound wave?
- (A) Frequency is proportional to amplitude.
  - (B) Frequency is proportional to the square of the amplitude.
  - (C) Frequency is inversely proportional to amplitude.
  - (D) Frequency is inversely proportional to the square of the amplitude.
  - (E) Frequency and amplitude are independent.
63. An atom whose nucleus contains 17 protons and 20 neutrons is a chlorine atom. Which of the following describes the composition of the nucleus of an isotope of chlorine?
- (A) 20 protons, 17 neutrons
  - (B) 19 protons, 18 neutrons
  - (C) 18 protons, 18 neutrons
  - (D) 17 protons, 19 neutrons
  - (E) 16 protons, 20 neutrons
64. When a projectile moving in a parabolic path reaches its highest point above the ground,
- (A) its velocity is instantaneously zero
  - (B) its acceleration is instantaneously zero
  - (C) its weight balances the force of air resistance
  - (D) the net force it feels is instantaneously zero
  - (E) None of the above

**GO ON TO THE NEXT PAGE** 

## PHYSICS SUBJECT TEST 2—Continued

### Questions 65-66

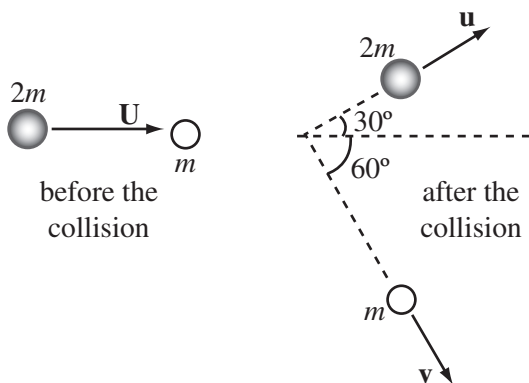

An object of mass  $2m$  moving with velocity  $\mathbf{U}$  strikes an object of mass  $m$  initially at rest. After the collision, the objects move away with velocities  $\mathbf{u}$  and  $\mathbf{v}$ , as shown.

65. Which one of the following equations correctly relates  $u$  and  $v$ ?
- (A)  $2u \cos 30^\circ = v \cos 60^\circ$   
 (B)  $u \cos 30^\circ = 2v \cos 60^\circ$   
 (C)  $2u \sin 30^\circ = v \sin 60^\circ$   
 (D)  $u \sin 30^\circ = 2v \sin 60^\circ$   
 (E)  $u \sin 30^\circ = v \cos 60^\circ$
66. If the collision is elastic, then
- (A)  $U^2 = u^2 - \frac{1}{2}v^2$   
 (B)  $U^2 = u^2 + \frac{1}{2}v^2$   
 (C)  $U = u - \frac{1}{2}v$   
 (D)  $U = u + \frac{1}{2}v$   
 (E)  $(U - u)^2 = \frac{1}{2}v^2$
67. The acceleration due to gravity on the moon is  $1/6$  of its value on Earth. If an object weighs 20 N on the moon, what is its mass on Earth?
- (A) 2 kg  
 (B) 7.2 kg  
 (C) 12 kg  
 (D) 60 kg  
 (E) 72 kg
68. The electric field strength at a point some distance away from a source charge does NOT depend on
- (A) the magnitude of the source charge.  
 (B) the sign of the source charge.  
 (C) the distance from the source charge.  
 (D) the nature of the medium surrounding the source charge.  
 (E) None of the above

GO ON TO THE NEXT PAGE



## PHYSICS SUBJECT TEST 2—Continued

69. Which of the following equations best states the relationship between a material's coefficient of volume expansion due to heating,  $\beta$ , and its coefficient of linear expansion,  $\alpha$ ?

(A)  $\beta = \alpha$   
(B)  $\beta = 3\alpha$   
(C)  $\beta = \alpha + \alpha^2$   
(D)  $\beta = \alpha^3$   
(E)  $\beta = 3\alpha^3$

70. The ends of a long, taut tightrope are attached to two platforms. A tightrope artist walks along the tightrope and, upon reaching the middle, stops. Someone standing on one of the platforms grabs the rope near one end and sends a transverse wave pulse down the rope. When the pulse reaches the tightrope walker, he briefly rises upward, and the wave passes. This illustrates the fact that the wave transports

(A) momentum  
(B) mass  
(C) weight  
(D) wavelength  
(E) density

### Questions 71-72

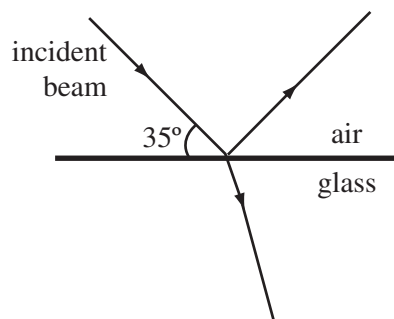

Note: The figure is not drawn to scale.

The figure above shows a beam of light striking the surface of a piece of glass from the air.

71. If the reflected beam and refracted beam are perpendicular to each other, what is the index of refraction of the glass?
- (A)  $\sin 55^\circ$   
(B)  $1/\sin 55^\circ$   
(C)  $1/\sin 35^\circ$   
(D)  $\sin 55^\circ/\sin 35^\circ$   
(E)  $\sin 35^\circ/\sin 55^\circ$
72. Let  $n$  denote the index of refraction of the glass. If the incident light has a frequency of  $f$  when traveling through the air, what is the wavelength of the light when it travels through the glass?
- (A)  $fc/n$   
(B)  $n/fc$   
(C)  $cf$   
(D)  $ncl/f$   
(E)  $c/nf$

**GO ON TO THE NEXT PAGE** 

## PHYSICS SUBJECT TEST 2—*Continued*

73. An electron that accelerates from a point near a collection of negative source charges toward a point near a collection of positive source charges experiences
- (A) a decrease in electrical potential energy as it moves toward a region at a lower electric potential
  - (B) a decrease in electrical potential energy as it moves toward a region at a higher electric potential
  - (C) an increase in electrical potential energy as it moves toward a region at a lower electric potential
  - (D) an increase in electrical potential energy as it moves toward a region at a higher electric potential
  - (E) no change in electrical potential energy
74. As the air around the base of a candle flame is heated, it rises and is replaced by cooler air. This illustrates what type of heat transfer?
- (A) Conduction
  - (B) Convection
  - (C) Radiation
  - (D) Diffraction
  - (E) Latent heat
75. Five identical spaceships take off from Planet X, and each passes by Planet Y at a constant speed on its way to Planet Z. A science station on Planet Y observes them passing by. The spaceship traveling at which of the following speeds would be observed to have the greatest length?
- (A)  $6 \times 10^7$  m/s
  - (B)  $9 \times 10^7$  m/s
  - (C)  $1 \times 10^8$  m/s
  - (D)  $1.5 \times 10^8$  m/s
  - (E)  $2 \times 10^8$  m/s

# STOP

**If you finish before time is called, you may check your work on this test only.  
Do not turn to any other test in this book.**