



SC On-line UPS

User's Manual Tower Models 700VA to 3kVA, 120Vac

Proprietary: The information contained herein is proprietary to Falcon Electric, Inc. and shall not be reproduced or disclosed in whole or in part or used for any reason except when such user possesses direct, written authorization from Falcon Electric, Inc.

The statements contained herein are based on good faith assumptions and provided for general information purposes only. These statements do not constitute an offer, promise, warranty or guarantee of performance. Actual results may vary depending on certain events or conditions. This document should not be used or relied upon for any purpose other than that intended by Falcon Electric, Inc.

© 2016 Falcon® Electric, Inc. All rights reserved.

All other brand names and trademarks are the property of their respective owners.

The information stated in this document is subject to change without notice.

Falcon®, Falcon® Electric and UPS logos are registered trademarks of Falcon Electric, Inc.
OM480041 SC1-3K_T 120V_12-12-16 REV.NR

Table of Contents

1. Safety and Storage Instructions	2
1.1 Safety	2
1.2 Storage.....	3
2. Product Introduction	4
2.1 General Characteristics	4
2.2 Special Features	5
3. UPS Functional Descriptions.....	6
3.1 Front Panel Display.....	6
3.2 Rear Panel	11
3.3 Communication Port	12
4. Installation and Operation	13
4.1 Unpacking	13
4.2 Installation Location	14
4.3 Operation	15
5. UPS System Architecture and Operating Modes	29
6. Maintenance Guide	30
6.1 Troubleshooting	30
6.2 Error Code Definitions.....	33
6.3 Maintenance.....	33
7. Communication Software	34
7.1 Hardware Setup	34
7.2 Software Installation.....	34
8. Optional Communication Cards	35
8.1 R2E (second RS-232) card.....	35
8.2 USE (USB) card	35
8.3 DCE (Dry Contact) card	36
8.4 SNMP Cards	37
9. Falcon Electric Service	38
9.1 Contact Information.....	38
10. Warranty	39

Safety and Storage Instructions

1.1 Safety

SAVE THESE INSTRUCTIONS: This manual contains instructions that should be followed during installation and maintenance of the UPS and Batteries.

1. **WARNING:** Risk of electric shock. Do not remove cover. No user serviceable parts inside. Refer servicing to qualified service personnel.
2. Avoid spilling liquids or allowing foreign objects to fall into the UPS as it will cause damage, possibly subject users to electric shock, and invalidate your warranty.
3. The UPS must be installed in a clean, indoor environment, free from moisture, flammable gasses, fumes or corrosive substances.
4. This UPS is equipped with an EMI filter. To prevent potential leakage current hazards, ensure that the AC mains supply is securely grounded.
5. This UPS is designed to be installed and commissioned in a controlled environment as follows:
 - Operating temperature 0°C to 40°C (32°F to 104°F) and 10% to 90% relative humidity. High ambient temperature significantly reduces battery life.
 - Avoid direct sunlight.
 - Do not install the UPS in a flammable or otherwise hazardous environment.
 - Avoid vibration and areas subject to physical impact.
 - The maximum UPS output load (in watts) must never exceed that shown on the UPS rating label. NEVER CONNECT equipment that could overload the UPS or demand half-wave rectification from the UPS output, for example: electric drills, vacuum pumps, or hair dryers.
6. To prevent overheating of the UPS, keep all ventilation openings free from obstruction. Do not place anything on top of the UPS. Keep the UPS rear panel at least 8 inches away from the wall or other obstructions.
7. Install the UPS in a well ventilated area, ideally exchanging 2.9 cubic feet of air per minute, because the chemical reaction during battery charging causes trace gas production.
8. If the product emits a strange noise or smell, immediately stop using the product and contact Falcon Electric for service or repair.
9. Always switch off the UPS and disconnect the batteries when relocating the UPS. Be aware that, even when disconnected, charged batteries present a risk of electric shock.
10. The UPS should be recharged every 2-3 months if unused. When installed and being used, the batteries will be automatically recharged.

11. Ensure that the input voltage to the UPS is within the specified range. Use a certified input power cable with the correct plugs and sockets for the system voltage.
12. CAUTION: Risk of Energy Hazard, 12V, 9 Ampere-hour batteries. Before replacing batteries, remove conductive jewelry such as chains, wrist watches and rings. High energy through conductive materials could cause severe burns.
13. CAUTION: Do not dispose of batteries in a fire. They may explode.
14. CAUTION: Do not open or mutilate batteries. Released material is harmful to the skin and eyes. It may be toxic.
15. Servicing of batteries should be performed or supervised by personnel knowledgeable about batteries and the required precautions.
16. CAUTION: A battery can present a risk of electrical shock and short circuit current. The following precautions should be observed when working on batteries:
 - a) Remove watches, rings or other metal objects
 - b) Use tools with insulated handles
 - c) Wear rubber gloves and boots
 - d) Do not lay tools or metal parts on top of the batteries
 - e) Disconnect charging source prior to connecting or disconnecting battery terminals.
 - f) Determine if battery is inadvertently grounded. If inadvertently grounded, remove source from ground. Contact with any part of a grounded battery can result in electrical shock. The likelihood of such shock can be reduced if such grounds are removed during installation or maintenance.

1.2 Storage

If the UPS is unused for an extended period of time, it must be stored in a moderate climate. The batteries should be charged for 12 hours every 3 months by connecting the UPS to the utility supply. Repeat this procedure every 2 months if the storage ambient temperature is above 25°C (77°F).

Product Introduction

2.1 General Characteristics

1. True On-Line technology continuously supplies your critical device with stable, regulated, transient-free, pure sine wave AC power.
2. High-efficiency PWM sine-wave topology yields excellent overall performance.
3. The high crest factor of the inverter can handle high inrush current loads without the need to upgrade the power rating.
4. User-friendly plug-and-play design allows hassle-free installation.
5. Built-in maintenance-free, sealed batteries minimize the need for after-sales service.
6. To protect the unit from overloading, the UPS will automatically switch to bypass mode in 30 seconds if loading is above 105% of rated capacity. It will automatically switch back to inverter mode once the overload condition ceases.
7. Should the output become short-circuited, the UPS puts the system in standby mode, provides visible and audible alarms, and cuts the output supply automatically until the short circuit situation is resolved manually.

2.2 Special Features

1. Our High Frequency Transformer-less technology and slim profile, tower form factor enables the UPS to be integrated into environments with space constraints.
2. This UPS is equipped with fully digital control logic for greater functionality and enhanced power protection. Digital signal processing (DSP) also provides the UPS with powerful communication capability, which simplifies remote control and monitoring.
3. Our wide input voltage tolerance of 90-150Vac allows under-voltage or over-voltage correction without unnecessary battery drain and helps extend battery life.
4. Our DC-start function ensures the start-up of the UPS even during power outages.
5. Our smart battery management system maximizes overall battery life.
6. Our Active Power Factor Correction control function constantly maintains the UPS input power factor at > 0.9 for superb energy efficiency.
7. Our Selectable Bypass input voltage tolerance (sensitivity low / high) prevents under or over-voltage being supplied to the loads in bypass mode. The selectable voltage ranges are (i) Bypass Sensitivity Low: $\pm 15\%$ of available output voltage setting and (ii) Bypass Sensitivity High: $\pm 10\%$ of available output voltage setting. For example, if the output voltage setting is 120V the Bypass Sensitivity Low range is 120Vac $\pm 15\%$, i.e., 102 - 138 Vac.
8. The UPS provides numerous configurable output voltages to match various system voltage requirements.
9. The UPS is designed to comply with various stringent international standards for electromagnetic interference compatibility (EMC).







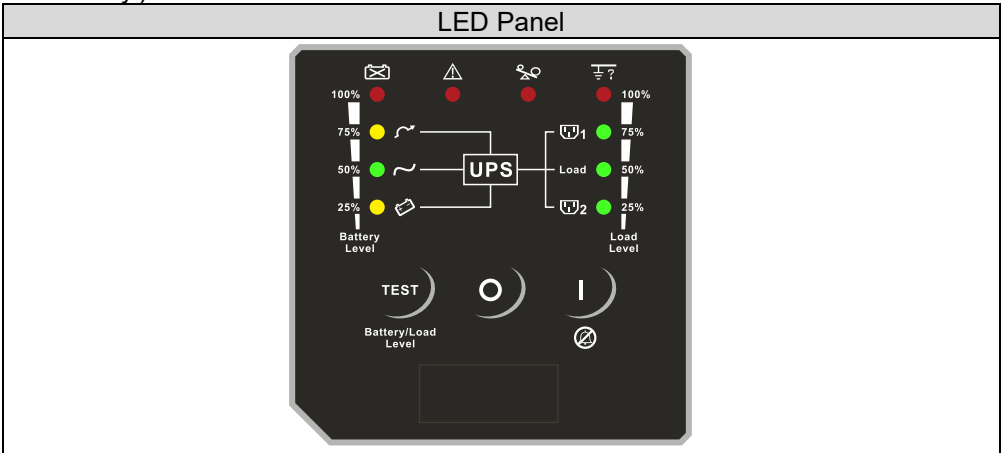

UPS Functional Descriptions

3.1 Front Panel Display

3.1.1 SC UPS< Tower Type > LED Panel (Optional, Contact Falcon Electric for availability.)





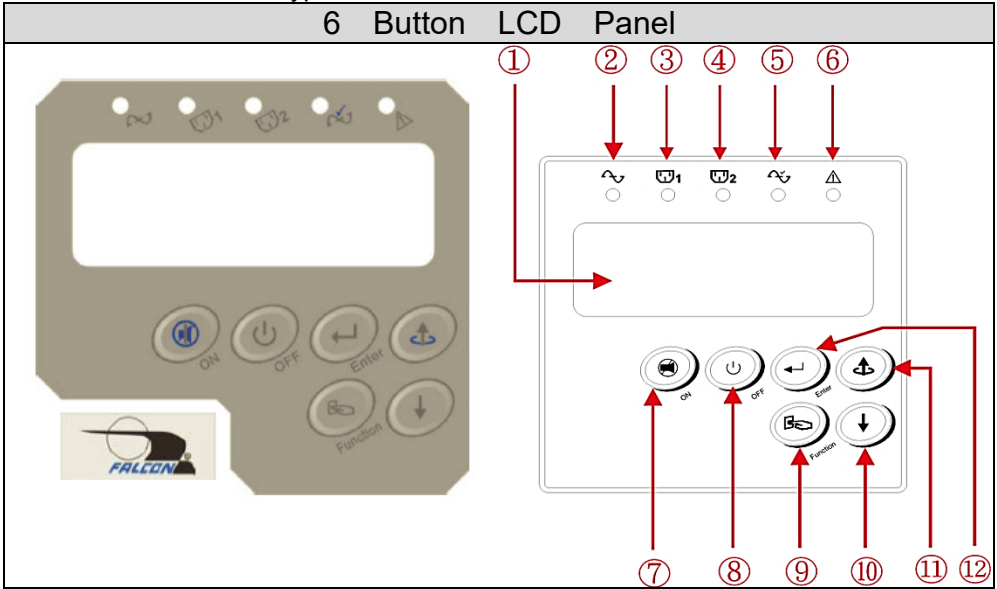

Control Key	Symbol	Description
ON (Alarm Silence)		a. UPS Power-On Switch (Press and hold until the buzzer beeps.) b. Alarm silence c. Error Code Display Function Mode. After an alarm, press to mute the alarm buzzer and show an Error Code. (Do not hold for > 1 second.)
OFF		UPS Power-Off Switch (Press and hold until the buzzer beeps.)
Self-Test		a. Commands the UPS to perform a battery self-test. (Press and hold until the buzzer beeps.) b. Battery and Load Display Function Mode (Do not hold for > 1 second.)
⊙ Manual Bypass		Press the "ON" key and "Self-Test" key simultaneously for 3 seconds to transfer from "Inverter to Bypass" (The bypass LED will continuously blink and the buzzer will beep intermittently.) or "Bypass to Inverter" when the UPS is in online mode and the Bypass Voltage Window is Normal.

LED Indicator	Symbol	Description
Normal Mode LED		<ol style="list-style-type: none"> 1. Solid indicates normal utility voltage. Blinking indicates insufficient utility voltage for the full load. Off indicates abnormal utility voltage. 2. In Battery and Load Function Mode, indicates battery capacity is 50%.
Battery Mode LED		<ol style="list-style-type: none"> 1. Indicates load supplied by battery power. 2. In Battery and Load Function Mode, indicates battery capacity is 25%.
Bypass Mode LED		<ol style="list-style-type: none"> 1. Indicates load supplied by bypass. 2. In Battery and Load Function Mode, indicates battery capacity is 75%.
Battery low / fault LED		<ol style="list-style-type: none"> 1. Indicates low battery power or faulty battery bank. 2. In Battery and Load Function Mode, indicates battery capacity is 100%.
Fault LED		<ol style="list-style-type: none"> 1. Solid indicates fault or abnormal condition. 2. Blinking indicates LED Panel in Error Code Function Mode.
Overload LED		<ol style="list-style-type: none"> 1. Indicates UPS is overloaded. 2. In Error Code Function Mode, indicates Error Code 16.
Site wiring fault LED		<ol style="list-style-type: none"> 1. Indicates reversed polarity or high neutral-ground voltage. 2. In Battery and Load Function Mode, indicates load capacity is 100%. 3. In Error Code Function Mode, indicates Error Code 8.
Outlet 1 LED		<ol style="list-style-type: none"> 1. Indicates UPS Outlets 1 are enabled and ready to supply loads. (This function is optional.) 2. In Battery and Load Function Mode, indicates load capacity is 75%. 3. In Error Code Function Mode, indicates Error Code 4.
Load LED	Load	<ol style="list-style-type: none"> 1. Indicates UPS outlets are enabled and ready to supply loads. 2. In Battery and Load Function Mode, indicates load capacity is 50%. 3. In Error Code Function Mode, indicates Error Code 2.
Outlet 2 LED		<ol style="list-style-type: none"> 1. Indicates UPS Outlets 2 are enabled and ready to supply loads. (This function is optional.) 2. In Battery and Load Function Mode, indicates load capacity is 25%. 3. In Error Code Function Mode, indicates Error Code 1.

3.1.2 SC UPS< Tower Type > LCD Panel



Item	Sign	Description
①		LCD Display
②		Green LED steadily lights up to indicate that the utility input voltage is within the operating window (90Vac~150Vac); the LED flashes to indicate that the utility input voltage is within the acceptable window (60Vac~90Vac).
③④		Green LED lights up to indicate there is an output available at Programmable Outlet 1 & Programmable Outlet 2.
⑤		Amber LED lights up to indicate the Bypass Input is normal or continuously blinks when UPS is in bypass mode.
⑥		UPS Fault LED
⑦		UPS On / Alarm Silence
⑧		UPS Inverter output off

⑨		Special functions log in/out
⑩		Go to next page
⑪		Go to previous page or change the setting of the UPS.
⑫		Apply UPS setting change

© Manual Bypass: To transfer in and out of bypass mode, verify the UPS is in online mode, and then press "⑦UPS On" and "⑪Previous Page" buttons simultaneously for approximately 3 seconds. The bypass LED and audible alarm will activate approximately every 2 seconds indicating the UPS is in bypass mode. Battery back-up is not available while the UPS is in bypass mode.

3.1.3 LCD Description

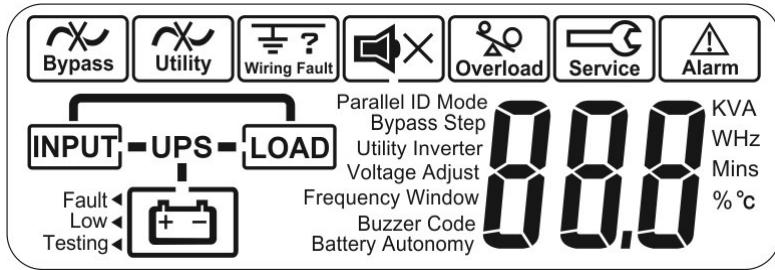

Item	Icon	Description
1		Bypass Input Abnormal, UPS fails to transfer to bypass, Bypass Abnormal at ECO mode
2		Utility Input Abnormal
3		Site Wiring Fault
4		Buzzer Silent
5		UPS Overload
6		Service Mode (Disabled)
7		UPS Fault Alarm
8		UPS Flow Chart
9		3-Digit Measurement Display
10		Indicates the item to be measured
11	Fault ◀	Battery Abnormal
12	Low ◀	Battery Low
13	Testing ◀	Indicates Battery Self-test

3.2 Rear Panel

SC UPS, 120Vac

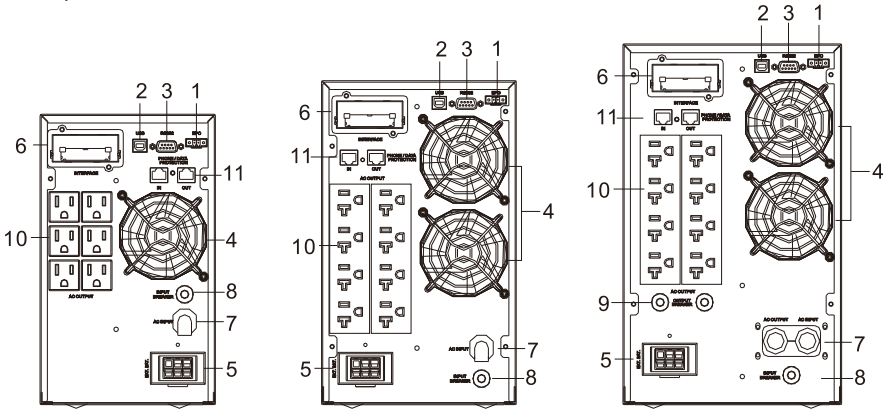

700VA / 1kVA / 1.5kVA

2kVA

3kVA

1. Emergency Power Off (EPO)
2. USB port
3. RS-232 port
4. Fan
5. External battery connector
6. Slot for optional communication cards
7. AC input power line cord
8. Utility input circuit breaker
9. Output circuit breaker for 2 outlets
10. Programmable Output Receptacles
11. Communication Surge Protection

3.3 Communication Port

The UPS is equipped with a true RS-232 communication port to provide communication with bundled UPS monitoring software for remote monitoring of the UPS. In addition, there are six optional interface cards available to meet various communication needs: USB, EPO, DCE (dry contact relay card), R2E, USE, and an SNMP / HTTP card. (Please reference Chapter 8.) The software bundled with the UPS is compatible with many operating systems, including Windows XP / Vista / 2008 / 7 / 8, Novell, NetWare, UNIX, Linux 2.6.x, Mac OS X v10.5 Leopard, and Mac OS X v10.6 Snow Leopard. Please contact Falcon Electric for suitable software. All communication ports including optional cards can be active and used simultaneously to monitor the UPS status. However, only one communication interface (the one with the highest priority) can control the UPS at a time. The priorities of these communication interfaces are listed below (highest priority first).

- 1) EPO input port
- 2) Optional interface card
- 3) USB
- 4) RJ11/RJ45 Communication surge protection
- 5) RS-232

3.3.1 True RS-232

The RS-232 interface must be configured as follows:

Baud Rate	2400 bps
Data Length	8 bits
Stop Bit	1
Parity	None

Pin Assignments:

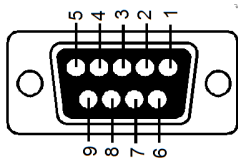

- Pin 3: RS-232 Rx
- Pin 2: RS-232 Tx
- Pin 5: Ground

3.3.2 EPO / ROO

Pin Assignments: Short pins 1-2 to activate remote shutdown while on battery mode.



Function setting :

1. EPO NC → Shutdown UPS
2. EPO NO → Shutdown UPS (Default)
3. ROO NC → Start-up UPS
4. ROO NO → Start-up UPS

Installation and Operation

Please read the Safety and Storage Instructions (pages 2 and 3) before installing the UPS.

4.1 Unpacking

Inspect the UPS upon receipt. The packaging is robust, but accidents and damage may still occur during shipment. Notify the forwarder and Falcon Electric if there is damage.

The packaging is recyclable and reusable.

1. After removing the packing foam, please be careful handling the UPS while it is still in the plastic bag. The plastic is slippery, and the UPS could fall and cause an injury.
2. Check for the following standard package contents, in addition to the UPS itself.
 - A. User's Manual (CD)**
 - B. UPSilon Monitoring Software CD**
 - C. USB Cable**

4.2 Installation Location

The UPS is heavy. Select a location sturdy enough to support the UPS weight.

To ensure proper operation and maximize UPS life, position the UPS according to the following requirements:

1. Keep at least 8 inches of clearance beyond the rear panel of the UPS.
2. Do not block the air flow to the ventilation louvers of the unit.
3. Ensure that the installation site is free from excessive dust and the ambient temperature and humidity are within the specified limits.
4. Do not place the UPS in a dusty or corrosive environment or near any flammable objects.
5. This UPS is not designed for outdoor use.

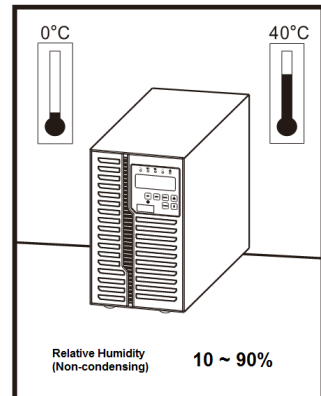
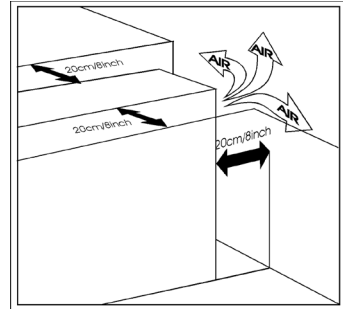

4.3 Operation

4.3.1 Using the LED Panel (Optional, contact Falcon Electric for availability.)

4.3.1.1 Start-up in Normal AC Mode

1. Verify the AC mains outlet is properly grounded.
2. Ensure that the utility voltage matches the input voltage window of the UPS.
3. Connect the UPS main power cord into the utility AC power source receptacle.
4. Switch on the AC power source. All of the LEDs on the front panel display will flash once after 5 seconds. At the same time, the fan will start operating.



5. Press and hold the ON button  for approximately 1 second to start the UPS. The buzzer will beep and the LED indicators "AC", "U1", "U2" and "Load" will illuminate after 1-5 seconds. The start-up procedure is now complete and the UPS outlets are ready to supply power to the load.
6. It is advisable to perform a battery mode test before connecting the loads to the UPS to ensure that the batteries are working properly. To do this, switch off the AC power source when the UPS is on. The AC LED on the front panel will turn off, the Battery LED will illuminate, and the buzzer will activate, indicating that the UPS is in Battery Mode. Connect a non-critical load to the UPS outlets to confirm that the batteries are supplying power. Repeat the test by switching the AC power on and off to ensure that the UPS is functioning properly.

4.3.1.2 Start-up in Battery Mode (cold-start)

This UPS can be switched on without the presence of an AC power source.



1. Press and hold the ON button  until the buzzer beeps. Release and then within the next 10 seconds, press and hold the same button a second time. The UPS will perform its start-up procedure. The LEDs "Battery", "U1", "U2" and "Load" will illuminate after 1-5 seconds, and the buzzer will pulsate to indicate successful power-on.

Note: Ensure that the UPS batteries are pre-charged for at least 4 hours by simply connecting the AC power cord to the utility receptacle.

4.3.1.3 Shutdown

1. Shutdown in AC Mode

Press and hold the OFF button  for 5 seconds until the buzzer beeps. The UPS will cut the power supply to the outlets. The ventilating fans will continue to operate. Switch off the AC power source. The ventilating fans will stop. The UPS is now completely shut down.





2. Shutdown in DC Mode

Press and hold the OFF button  for 5 seconds until the buzzer beeps. The UPS will cut the power supply to the outlets. The LEDs will turn off, and the ventilating fans will stop after 10 seconds. The UPS is now completely shut down.

4.3.1.4 Battery Self-test in AC Mode

After the UPS has been successfully started in AC mode, press and hold the



Self-Test button  for 5 seconds until the buzzer beeps. The  LED will illuminate to indicate that the self-test is in progress. When the self-test is completed the UPS will return to AC mode. If there were no faults or abnormal conditions then the LED indicators  and  LEDs will turn off.





Note: The main function of self-test is to run a discharge test on the batteries to check condition.

4.3.2 LCD Panel

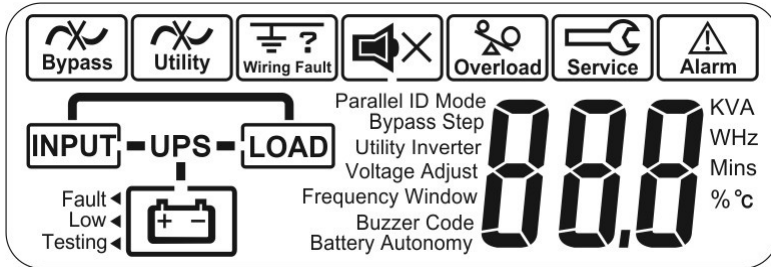
4.3.2.1 Start-up in Normal AC Mode

1. Verify the AC mains outlet is properly grounded.
2. Ensure the voltage rating of power source is within the UPS specification.
3. Plug in UPS to the AC source.
4. After 5 seconds, the UPS will detect AC power and then initialize. LED / LCD indicators will all be lit and dim once, then the fan will start spinning.



5. Press the UPS the On button and hold until 2 beeps are heard. The UPS will switch to online mode within 5 seconds. LCD display will be shown as listed in figure-A and then figure-B sequentially. LEDs  will light up to indicate that the Utility and the Bypass are normal. And then " , " , "  LED remain lit during figure-B LCD display.

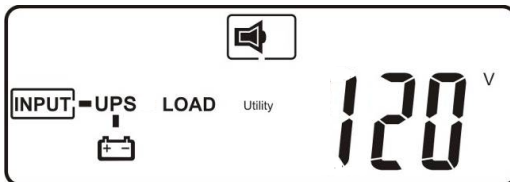

A

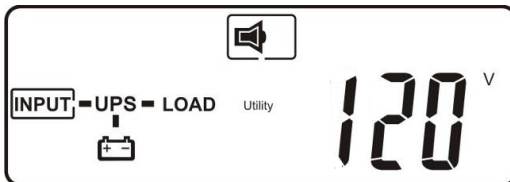

B



NOTE When you see figure-B, the start-up procedure is finished. If it is a newly installed unit, ensure that the UPS is in online mode for at least 4 hours for full recharge before the first backup test.

6. Back-up test: Unplug the power cord or switch off power source to simulate power failure condition. Green LED indicator  will be dimmed and amber LED "", " will be lit. Intermittent audible alarm will be heard and LCD display shows as below figure-C:

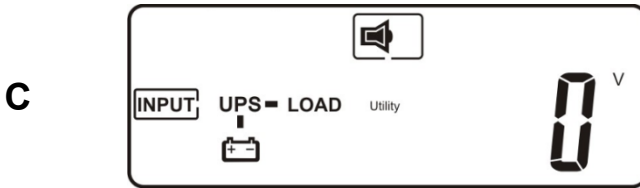



4.3.2.2 DC Start (Cold-start)

1. Ensure the internal battery is available or external battery is

connected to UPS. Press and hold UPS On  button for 3 seconds until 2 beeps are heard, release button and press UPS On



button for 3 more seconds until 2 beeps are heard again to confirm cold-start procedure. If the second button confirmation isn't finished within 10 seconds after first 2 beeps, the UPS will not cold-start and will shut off after 10 seconds.

2. Five seconds after cold-starting, amber LED "", " will be lit, intermittent audible alarm will be heard and LCD will show sequentially as shown below in figure-D and figure-E:

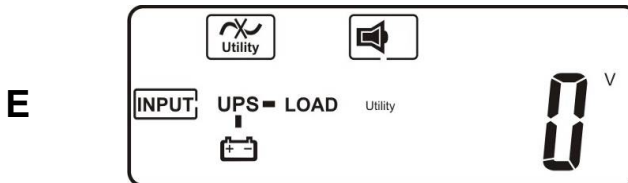
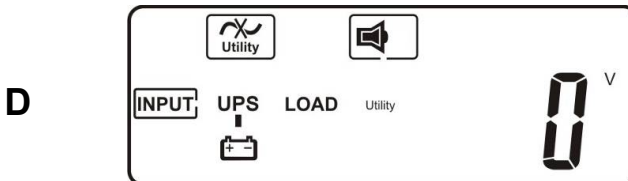

4.3.2.3 LCD Measurements

1. UPS measurements can be checked after the UPS has started by pressing the



Next Page button. The display sequence is shown below in figures F through M, respectively.

F

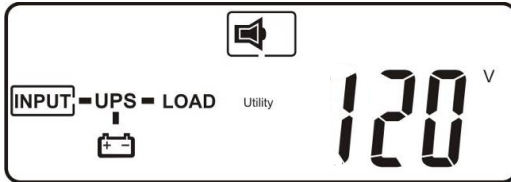

G

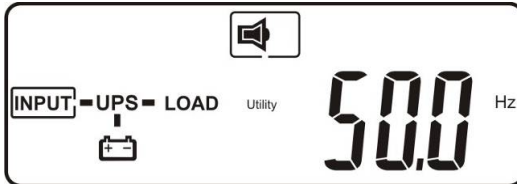

H

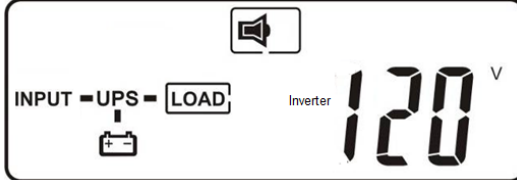

I

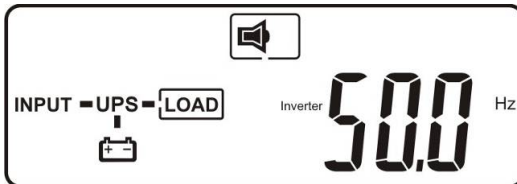

J



K

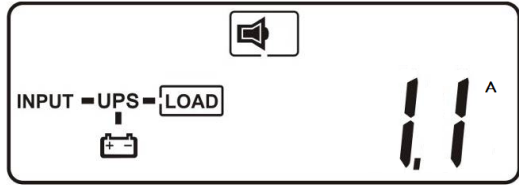

L



M

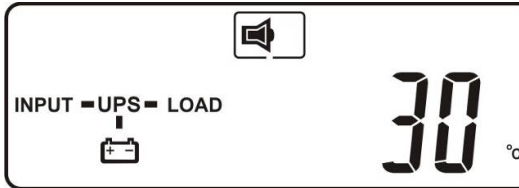

4.3.2.4 UPS Fault Condition

UPS may lock itself up if there was a critical, abnormal or failure condition. The UPS will trigger the fault alarm and corresponding error code. Sample error code shown below. (Figure N)

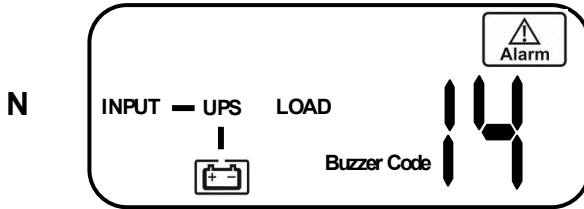

The procedure to release the UPS from locked-up status is as follows:

1. Check and record the error code.
2. Reference sections 6.1 and 6.2 for troubleshooting and error codes. If the problem persists, contact Falcon Electric for further assistance.



3. Press the Off button and hold for 5 seconds until 2 beeps are heard.
4. Unplug AC input power cord or turn off AC mains power source switch.
5. After the UPS completely shuts off, the UPS can be restarted to clear fault condition.

4.3.2.5 UPS Default Settings and Special Function Execution



After the UPS completely starts up, press the Function button to change the LCD display to figure Q1.

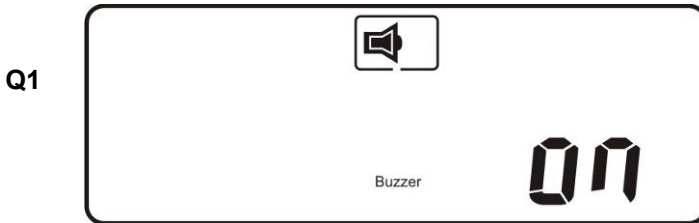

Buzzer "On"

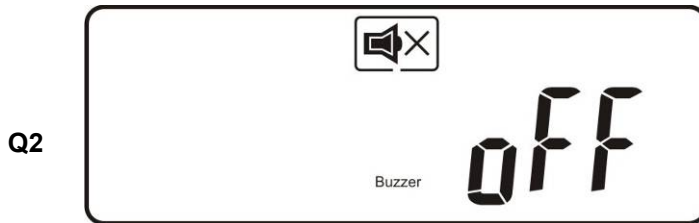

Buzzer "Off"

Press the Next Page  button to scroll through the UPS settings. The LCD will display in sequence: figure Q1 (buzzer) → figure R1 (Self-test) → figure S1 (Bypass Voltage Windows) → figure T (Output Frequency Synchronization Window) → figure U (Inverter Output Voltage) → figure V1 (UPS Operation Mode) → figure W (Inverter Voltage Adjust).



Self-test is not "On".



Self-test is "On"

S1

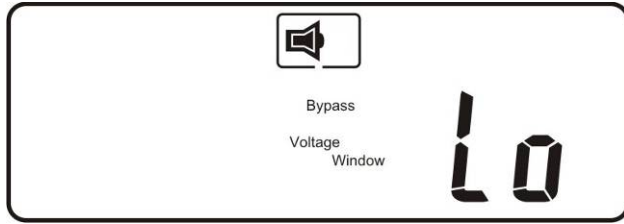

Bypass Voltage is adjusted to low range. (15% of UPS output setting)

S2

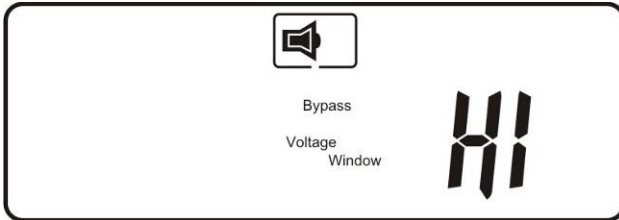

Bypass Voltage is adjusted to high range. (10% of UPS output setting)

T

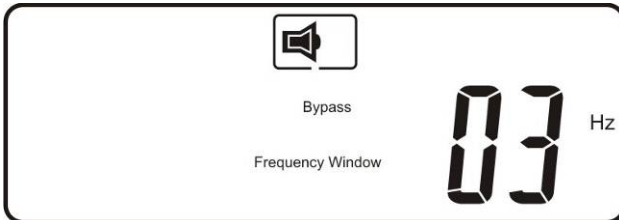

Frequency Window is ± 3 Hz. (± 3 Hz or ± 1 Hz)

U

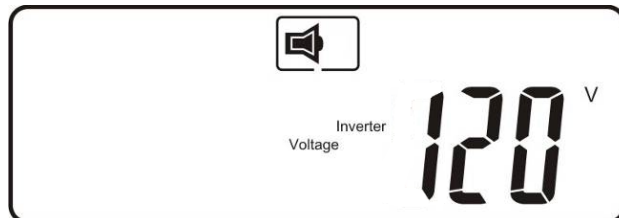

Inverter Output Voltage (100, 110, 115, 120 or 127Vac)

V1

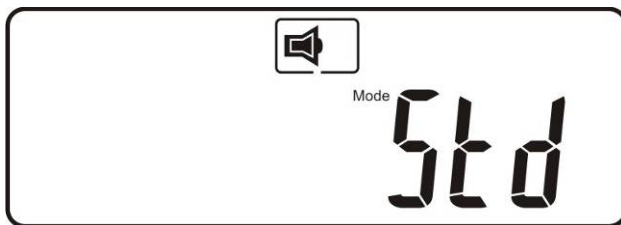

The UPS is operating in "Standard Mode". (50 / 60Hz, Auto-tracking)

V2

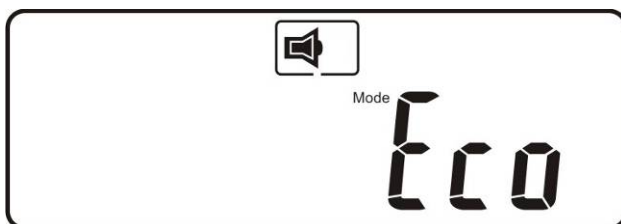

The UPS is operating in "Eco mode".

V3

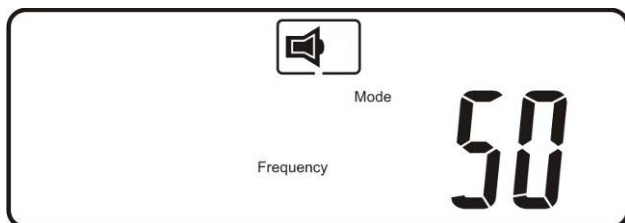

The UPS is operating in "Constant Voltage / Constant Frequency, 50 Hz mode".

V4

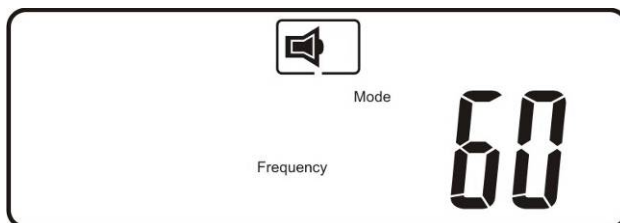

The UPS is operating in "Constant Voltage / Constant Frequency, 60 Hz mode".

W

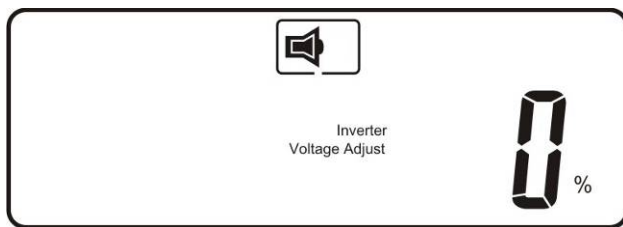

Output Voltage Adjustment (-3%, -2%, -1%, 0%, +1%, +2%, +3%)



4.3.2.6 Press the Previous Page button to execute special functions. The functions include buzzer ON (as shown in figure Q1), buzzer OFF (as shown in figure Q2), and self-test OFF (as shown in figure R1) or self-test ON (as shown in figure R2). When set, the UPS will execute the battery test for 10 seconds.

4.3.3 UPS Default and Optional Settings



4.3.3.1 Verify the UPS is in Standby. Press the On button and Next Page



buttons simultaneously for approximately 3 seconds. The buzzer will sound twice and the LCD will display figure Q1, indicating that the UPS is in setting mode.

4.3.3.2 To scroll through the options, use the Next Page button.



4.3.3.3 Except for Buzzer (figures Q1 and Q2) and Self-test (figures R1 and R2) all of the other default settings may be changed by pressing the Previous



Page button.

4.3.3.4 Figures S1 and S2 indicate the bypass input acceptable window which follows the inverter output voltage. For example, if the output voltage setting is 120Vac the Bypass Sensitivity Low range is 120Vac \pm 15%, i.e., 102 - 138 Vac.

4.3.3.5 Figure T indicates the bypass frequency window of the Inverter Output. The acceptable setting values are \pm 3 Hz and \pm 1 Hz.

4.3.3.6 Figure U indicates the acceptable Inverter Output Voltage. Possible values are 100, 110, 115, 120, or 127 Vac.

4.3.3.7 Figures V1, V2, V3 and V4 indicate the operation modes of the UPS. Possible values are Online (STD) mode, Eco (Economical) mode, fixed 50 Hz Output, and fixed 60 Hz Output.

4.3.3.8 Figure W indicates the adjustment of the Inverter Output, which may be set to 0%, +1%, -1%, +2%, -2%, +3%, or -3%.

4.3.3.9 After changing settings you must scroll to the “End” screen (figure X) and



then press the Enter button to save all of your changes.

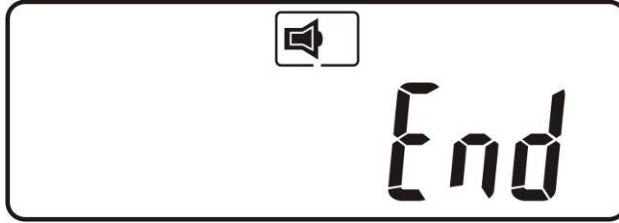

X





4.3.3.10 Turn off the AC power and restart the UPS.

4.3.3.11 Once the UPS is in online mode, the changes will take effect.

4.3.3.12 Turn UPS off

1. Online mode (AC input available) : Press the Off  button and hold until 2 beeps are heard. The UPS output will shut off. The UPS will stay in standby mode, fan(s) will keep spinning and the battery will remain recharging if AC input is still available; otherwise it will shut down completely.
2. Backup mode (AC input not available): Press the Off  button and hold until 2 beeps are heard. The UPS output will shut off. Ten seconds later, the fan will stop spinning and UPS will shut down completely.

4.3.3.13 Battery Self-test (Online mode only)

Verify the UPS is in online mode. Press the function  button then press the Next Page  button once to select testing. Press the Previous Page  button to begin battery self-test which will last about 10 seconds then switch back to normal operation. If the batteries are in poor condition, the battery fault alarm / error code will activate.

4.3.4 Beep Codes

The following table contains common UPS status and beep codes.

UPS Status	Beep Code
UPS fault, Inverter shut down. All functions inhibited.	Long continuous beep
Control keypad error	Long continuous beep
UPS fault, loads continue to be supplied via Inverter or Bypass.	Single beep every 2 seconds
In battery mode	Single beep once per second
Battery low	Quick and short successive beeps
Confirm RS-232 port receiving	Two quick and short beeps
Service mode verified	One quick and short beep

UPS System Architecture and Operating Modes

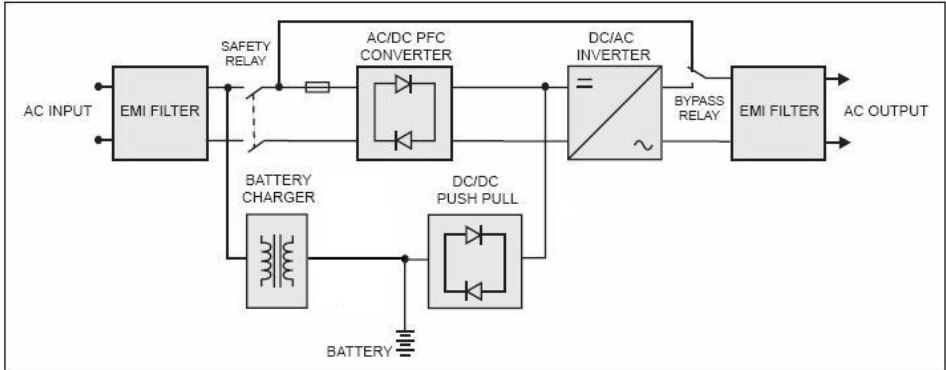









Figure 4.1

Figure 4.1 illustrates the True On-Line Double Conversion architecture of the UPS system. The major modules consist of:

- 1) AC-to-DC power converter (rectifier) with PFC control circuit
- 2) DC-to-AC high frequency inverter
- 3) Intelligent battery charger
- 4) Bank of stationary, maintenance-free batteries
- 5) DC-to-DC push/pull converter control circuit
- 6) Static bypass
- 7) Input and output EMI filters





The table below provides a summary of the UPS operating modes under various utility AC power source and battery conditions.

Utility Condition	UPS Operating Mode	LEDs
Normal (Online)	UPS detects AC power in approximately 5 seconds, LEDs on the panel will blink and fans will start. Press the ON button  for 1-5 seconds. The UPS starts up normally.	 ,  ,  LEDs will be lit.
Abnormal (under / over-voltage or absent)	Rectifier and charger stop operating. Battery discharges via DC-DC boost circuit and powers the inverter. Loads continue to receive power from Inverter. Alarm buzzer beeps every two seconds.	 LED off. The  will be shown on display.
Utility abnormal / absent, or battery voltage low	Rectifier and charger stop operating. Battery discharges via DC-DC boost circuit and powers the inverter. Alarm buzzer beeps quickly, indicating battery power low and the output will be shutting down.	 LED off. The  and low battery indication will be shown on display.

Maintenance Guide

6.1 Troubleshooting

6.1.1 If the UPS malfunctions during operation please check that all lines are connected properly and that the utility specifications are correct. Reference the table below for solutions. Should the problem persist, please contact Falcon Electric for assistance.

Situation	Check Items	Solution
Fault  LED Read the error code (see page 35) displayed by the LCD and verify the fault.	1. Er05,Er39 	1. Check for proper battery connection. Measure battery voltage to ensure that batteries are charged. Recharge batteries for 8 hours if necessary. Simulate utility outage to verify that UPS is able to provide DC backup. Otherwise, contact Falcon Electric.
	2. Overload 	2. Disconnect some non-critical loads from the UPS output until the overload ceases. Check if there is any short circuit between cables due to broken cable insulation. Replace the cables if necessary.
	3. Er11 (UPS over-temperature)	3. Remove any objects obstructing the ventilation louvers. Verify that the cooling fans are working properly. Contact Falcon Electric for replacement parts and accessories.
	4. Site wiring / Ground fault 	4. Check if the "L" and "N" phases of the utility AC source have been incorrectly wired or if the ground-neutral voltage exceeds the limits.
	5. Er14 (Fan failure)	5. Verify that the ventilation fans are functioning properly. Do not attempt to replace the fans yourself. Contact Falcon Electric for service or repair.
	6. Other error codes	6. Contact Falcon Electric for further assistance.

UPS fails to provide specified battery backup time.		If the backup time remains unsatisfactory after 8 hours of charging contact Falcon Electric for battery replacement.
UPS indicates normal operation, but there is no output to the load.	Check that all power cords are properly connected.	If the problem persists contact Falcon Electric for technical assistance.
The UPS switches into battery mode and then back into utility mode when a connected device is turned on, or the UPS switches back and forth between battery and utility modes.	<ol style="list-style-type: none"> 1. A faulty power strip is connected to the UPS. 2. See if there is any damage to the utility wall receptacle or if the cord plug is faulty. 	<ol style="list-style-type: none"> 1. Do not use the power strip. 2. Replace the wall receptacle / cord plug.
Strange noise or smell		Immediately shut down the whole system. Disconnect the power from the UPS and contact Falcon Electric for service.
UPS is unable to provide backup power.		Check that the battery connectors are fully engaged. Allow the batteries to recharge if they are weak. If the problem persists after recharging, replace the batteries. If the problem still persists, contact Falcon Electric for technical assistance.

6.1.2 Error Codes (LED Models)

When the Fault LED \triangle is lit, press the ON button I , briefly to check the error code. The error codes 1, 2, 4, 8, and 16 are represented by the 4 bar LEDs 25%, 50%, 75%, and 100%, and the Overload LED I . Each LED represents a number as shown in the figure below. For example, the figure below shows the 25%, 50%, and 100% bar LEDs lit. The error code is therefore $8 + 2 + 1 = 11$, or Er11, which indicates that the UPS is in over-temperature condition.

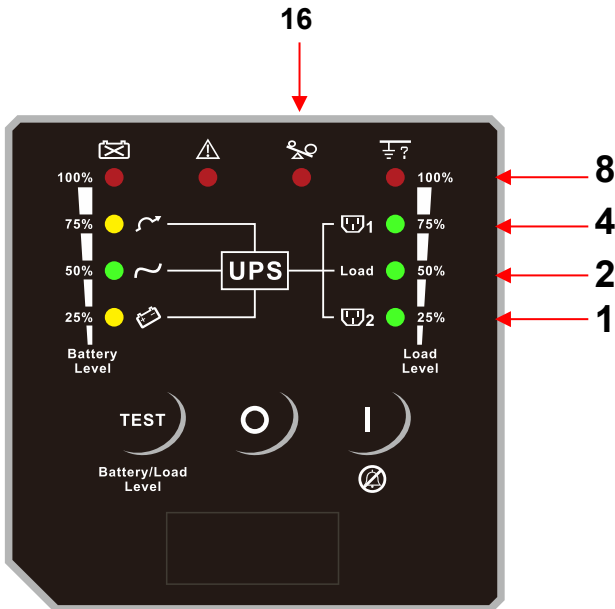

6.1.3 Error Codes (LCD Models)

If the UPS is in abnormal condition, the alarm icon  will light up and trigger the audible alarm. The LCD screen will show information of the condition and error code. Please reference section 6.1 for troubleshooting

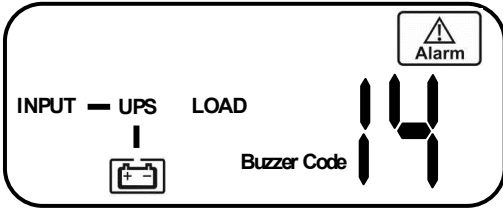

6.2 Error Code Definitions

Code	Definition
Er05	Battery weak or faulty
Er06	Output short-circuit detected
Er07	EPO mode activated
Er11	UPS over-temperature
Er12	Inverter overload
Er14	Fan Failure
Er39	Battery not present at start up or utility input voltage is below 90Vac.
Er28	Overload / Bypass condition

6.3 Maintenance

1. Clean dust from the ventilation louvers and fan guards on the rear panel.
2. Turn off the UPS and wipe the casing with a damp cloth. Be careful to avoid getting water in the UPS.
3. Periodically perform a battery self-test. (Reference section 4.3.3.13) Be sure you have saved your data in any open computer applications before you proceed with this battery test.

Communication Software

7.1 Hardware Setup

1. Decide whether to use RS-232 communication or USB communication. (For optional interface cards please refer to Chapter 8.)
2. Connect a male RS-232 connector or a USB cable* to the UPS communication port. Connect the female RS-232 connector or the other end of the USB cable to the computer.

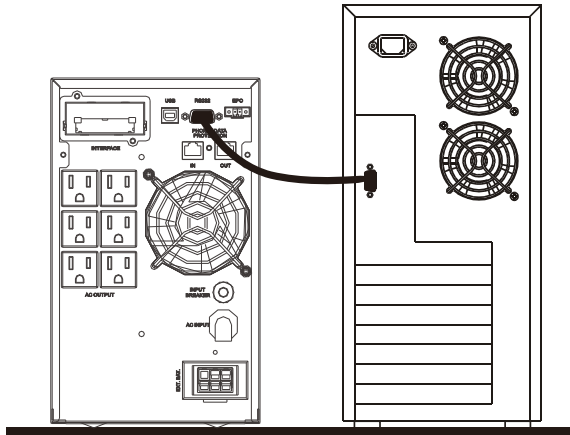

***Note: USB cable is supplied.**

7.2 Software Installation

Please refer to the software user's manual.

Optional Communication Cards

8.1 R2E (Second RS-232) Card



8.1.1 CN1 is for RS-232 DB9.

8.1.2 For interface settings and pin assignments please refer to section 1).

8.1.3 Installation Location: Communication Option Slot

8.2 USE (USB) card



8.2.1 CN1 is for USB.

8.2.2 For the communication protocol definition please refer to section 8.4.2.

8.2.3 Installation Location: Communication Option Slot

8.3 DCE (Dry Contact) card

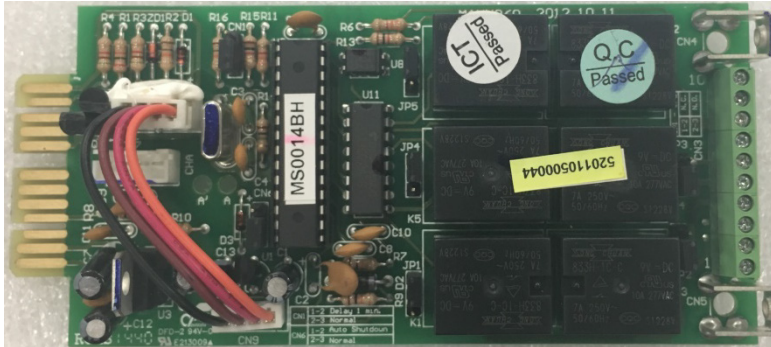

8.3.1 Pin assignments of 10-Pin terminal:

1	2	3	4	4	5	6	7	8	9	10
---	---	---	---	---	---	---	---	---	---	----

- 1 → UPS on Bypass (Normally Open)
- 2 → Utility Abnormal (Normally Open)
- 3 → Utility Normal (Normally Closed)
- 4 → Inverter On (Normally Open)
- 5 → Low Battery (Normally Open)
- 6 → Battery Fault (Normally Open)
- 7 → UPS Alarm (Normally Open)
- 8 → Common
- 9 → Shutdown UPS Positive (+) signal
- 10 → Shutdown UPS Negative (-) signal

8.3.2 To activate the remote shutdown function during a power loss, apply 6-25VDC to pins 9 (+) and 10 (-) for 5 seconds and the UPS will shut down.

8.3.3 The capacity of each relay contact is 40 VDC/25 mA.

8.3.4 Installation Location: Communication Option Slot

8.3.5 Flexible signal output for N.C. (Normally Closed) or N.O. (Normally Open) contact by shorting pins 1-2 or pins 2-3 from JP1-5

8.3.6 The shutdown function will be enabled 1 minute after power loss occurs if pins 1-2 of both CN1 and CN6 are shorted. Otherwise, the shutdown function can be enabled only by pins 9-10 of CN3 if pins 2-3 of both CN1 and CN6 are shorted.

8.4 SNMP Cards

8.4.1 Megatec SNMP card

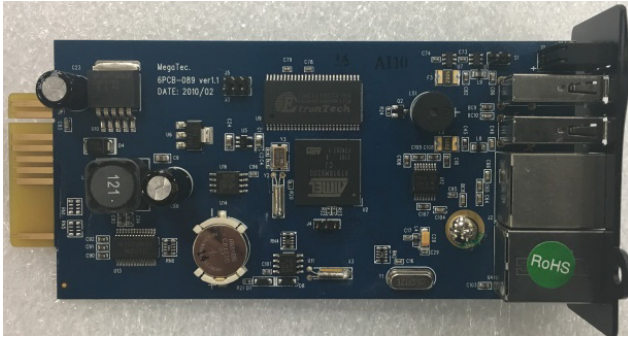

8.4.1.1 For installation, please refer to the user's manual that was included with the card.

8.4.1.2 Installation Location: Communication Option Slot

8.4.2 USB Designations

The USB communication protocol definition is listed below:

1. Complies with USB version 1.0, 1.5 Mbps.
2. Complies with USB HID version 1.0.
3. Pin Assignments:

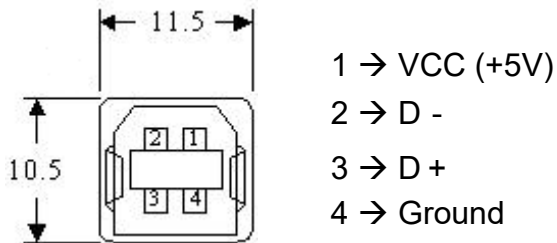

* For USHA, SNMP / HTTP Card information, please contact Falcon Electric.

Falcon Electric Service

9.1 Contact Information

In the event your SC UPS requires service or should any other technical support be required, write, call, fax or email Falcon Service.

Falcon Electric Inc.
5116 Azusa Canyon Road
Irwindale, CA. 91706

Service 800-842-6940
Voice 626-962-7770
Fax 626-962-6850
Email: service@falconups.com
www.falconups.com

Warranty

Two-Year Limited Warranty: Falcon warrants that this product will be free from defects in materials and workmanship for a period of two years from the date of shipment within the 50 states and Canada (Domestic). The warranty is limited to one year for all other destinations (International).

Procedures: Any defective product must be returned to Falcon. No product can be returned without first obtaining a Return Material Authorization (RMA) number from Falcon. Falcon will repair, replace or refund the purchaser price, at Falcon's sole discretion, for any defective product that is returned to Falcon with an RMA number. For defective product sold domestically, as defined above, returned within 30 days of shipment, Falcon will pay for the shipping costs to and from its service center. For a defective product returned after 30 days but within 90 days of shipment, Falcon will only pay for shipping costs in sending the new or repaired product back to the end-user. For a defective product returned more than 90 days after shipment, all shipping costs will be borne by the end-user. Falcon will not pay any shipping costs sold internationally, as described above.

Exclusions: This limited warranty does not cover damage caused by: (i) improper installation, misuse or neglect; (ii) unauthorized repairs or modifications or use of unauthorized parts; (iii) acts or events outside of Falcon's control, such as fire, accidents, impacts; (iv) normal wear and tear, such as cleaning and replacement of batteries.

The warranty is null and void if: (i) the product is used in conjunction with life support equipment; (ii) The factory seal is broken or shows signs of tampering; or (iii) the battery is allowed to discharge below the minimum battery cut-off point. To prevent this discharge, remove the battery fuse, switch the battery disconnect to the "off" position or disconnect the batteries when the unit is to be stored without the AC power being supplied to the UPS for more than two days. The battery must be recharged every four to six months when not in use. This limited warranty is not transferable.

Limitations: In no event is Falcon responsible for any special, indirect, secondary or consequential damages, such as personal injury, damage to property, loss of data, lost profits, etc. In no event will Falcon's liability under this limited warranty exceed the purchase price paid for the product in question.

Disclaimers: The limited warranties set forth in this document are the only warranties that apply to Falcon's products. All other warranties are expressly disclaimed, including any implied warranties of merchantability or fitness for a particular purpose. This warranty gives you specific legal rights, and you may have other legal rights that vary from state to state.

