

System Overview

SCADA System SIMATIC WinCC

The scalable and open SCADA system for maximum plant transparency and productivity

[siemens.com/wincc-v7](https://www.siemens.com/wincc-v7)

Overview

A standard, that fits

SIMATIC WinCC® is a scalable process visualization system (SCADA) that is graduated by price and performance, with efficient functions for controlling automated processes.

With SIMATIC WinCC, “perfect process visualization” stands for complete operating and monitoring functionality under Windows for all industry segments – ranging from simple single-user systems through to distributed multi-user systems with redundant servers and the structure of a cross-site solution including Web clients.

One of the special features of WinCC is its total openness. It can be readily used in combination with standard and user programs, creating HMI solutions which precisely meet practical requirements.

WinCC is a modern system with an attractive user interface for use in the world of the office and manufacture, offering mature and reliable operation and efficient configuration.

It is scalable for simple and complex tasks. Together with the integrated process database, WinCC represents the information exchange for cross-company, vertical integration and thanks to Plant Intelligence provides much more transparency in production.



➤ Video “WinCC”

Content

> Added Value

- > Efficiency in Engineering
- > Efficiency in Runtime
- > Scalability
- > Innovation
- > Openness

> Packages

> WinCC Options

- > WinCC Audit
- > WinCC/Calendar Scheduler and Event Notifier
- > WinCC/ChangeControl
- > WinCC/Connectivity Pack and Connectivity Station
- > WinCC/DataMonitor
- > WinCC/IndustrialDataBridge
- > SIMATIC Information Server
- > WinCC/ODK (Open Development Kit)
- > WinCC/Performance Monitor
- > WinCC/ProAgent
- > SIMATIC Process Historian
- > WinCC/Redundancy
- > WinCC/Server
- > WinCC/SES
- > WinCC/TeleControl
- > WinCC/User Archives
- > WinCC/Web Navigator
- > WinCC/WebUX

> Operating systems and hardware requirements

> Contact

Added Value

The added value of SIMATIC SCADA systems



As the key to greater productivity, SIMATIC SCADA systems combine efficient engineering with powerful archiving and maximum data security. They form a solid foundation for efficient operational management and intelligent production analyses.

> [More about Efficiency in Engineering](#)

> [More about Efficiency in Runtime](#)



We offer stationary or mobile solutions to meet growing demands – with guaranteed security. To accomplish this, we draw upon more than 15 years of SCADA expertise in all industries. Whatever your requirements are, no matter how large or small – we have the right answer.

> [More information](#)



With mobile SCADA solutions, you can learn more anywhere and at any time – even with existing tablet or smartphone hardware.

The use of multi-touch gestures in an industrial environment opens.

> [More information](#)



Special requests can be easily implemented thanks to the support of international standards as well as system-specific script and programming interfaces.

> [More information](#)



WinCC Specialists are at your service as qualified solution providers worldwide. These certified and centrally audited partners realize your individual SCADA project, also with distributed client-server architectures involving redundancy or with applications involving energy data management systems.



➤ [Video "SIMATIC SCADA systems"](#)

Efficiency in Engineering

Intelligent tools for efficient engineering

Due to the permanently increasing level of automation and the related complexity of the plants the cost – and time – pressure is increasing because of the international competition. One response to this pressure has to be efficient engineering on the SCADA layer.

SIMATIC WinCC supports short Time-to-Market when building new plants and achieves a minimum of downtime when doing plant modifications because of its efficient engineering tools.

Efficient processing of mass data

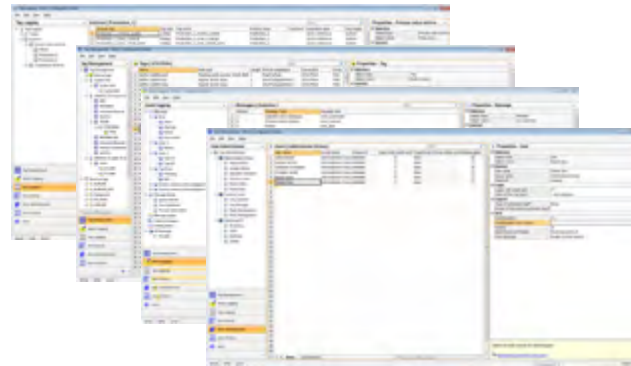

By the integration of stand-alone editors for alarm logging, tag logging, text library, user administrator, user archive and the acoustic alarm into the Configuration Studio the mass data engineering got again much more efficient.

It is possible to open each single editor separately which makes it very easy to exchange data between these editors. Of course the usual operating functionality of Excel is still valid. When doing project work in a team it is of course possible for multiple project engineers to open the single editors in parallel.

Tags and the optimized communication to the S7 PLCs

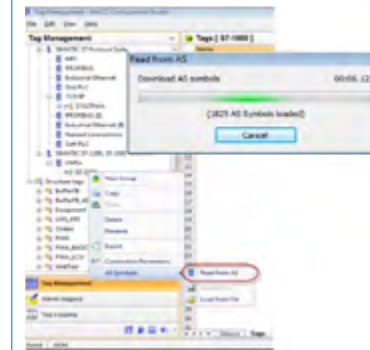

Resulting from the integration into the SIMATIC Manager of the S7-300/400 PLCs it is possible to take and align all variable connections as symbols and all AS messages automatically. In combination with the actual S7-1200 and S7-1500 PLCs the transfer of the AS Symbols out of a connected PLC into the WinCC project is much faster. This reduces the time for the parameterizing of the communication dramatically and that's why the risk of potential faults decreases. It is also possible to automatically take over the AS messages of a S7-1500 into WinCC.

Support of native drivers for PROFIBUS FMS and PROFIBUS DP, Allen Bradley, Modicon and Mitsubishi. With the help of the integrated OPC-client it is also possible to connect to any 3rd-party system.

Ready for worldwide applications

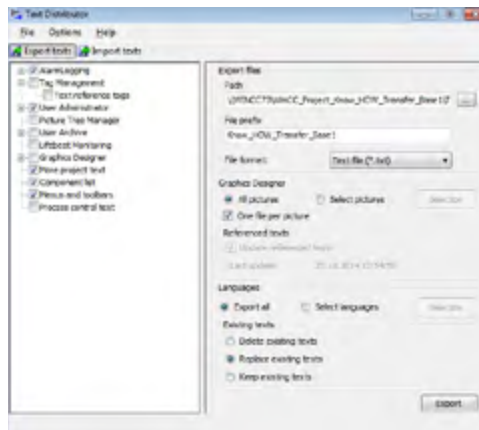

The administration and implementation of the messages for the destination countries is clearly arranged and therefore efficient to manage. The use of UNICODE makes the implementation of global applications very easy. By the utilization of the TextLibrary it is possible to export all (or subsets of the) texts used in WinCC. Vice versa it is of course possible to import all these texts after they are translated to any language.

The appropriate operator language is independent regardless of the language of the installed operating system. Every operator can individually choose the language of the displayed texts. For example it is possible to display messages simultaneously using different languages when working in international teams.

Efficient diagnosis in the engineering using the cross-reference list

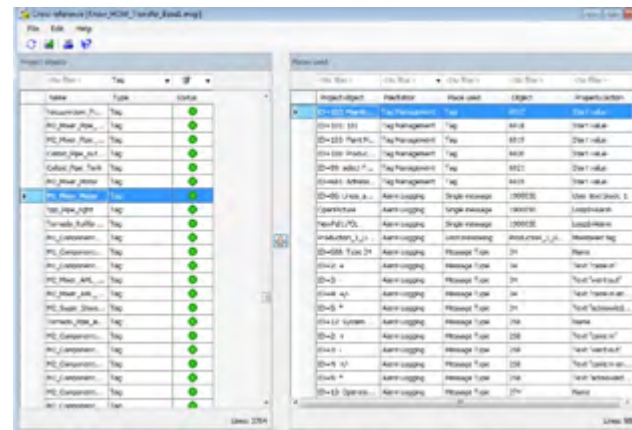

Resulting from the integration of the cross-reference editor it is on one hand possible to locate very fast the places where a special variable is used for example in case of troubleshooting. On the other hand it is possible to release non used variables to align the license costs optimal to the actual project.

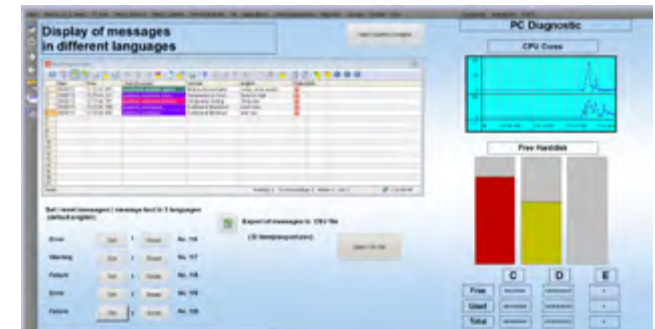

Fig.: Messages in different languages

Integrated user administration including SIMATIC Logon

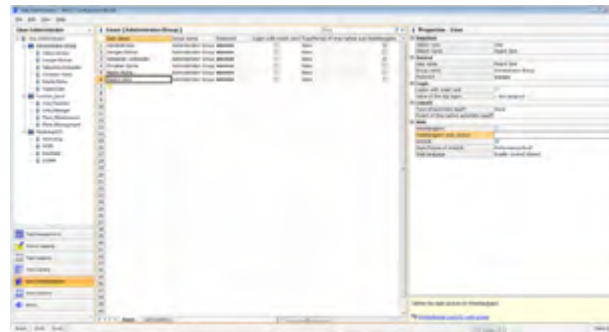
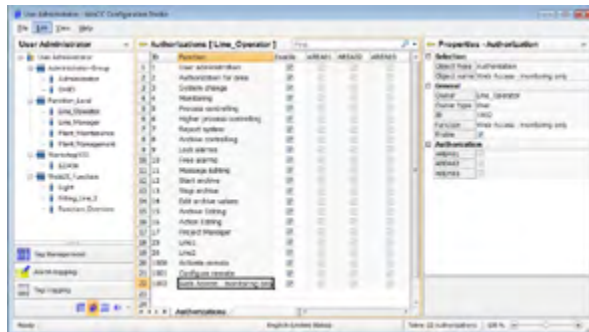

Fig.: WinCC user administrator

Using the WinCC User Administration you consistently can assign and check the access rights of the users regardless if it is a local access or if the access is web based. For up to 128 user groups with up to 128 single users each the access rights for WinCC functions can be administered. In total it is possible to assign 999 different permissions.

The user management with SIMATIC Logon which is a part of the basic system is integrated into the security system as well as into the user administration of Windows. Therefore it also covers the extended FDA safety requirements.

SIMATIC Logon supports a plant wide user management and protects against unauthorized data manipulations.

Using a configuration tool there are several setting options possible:

- Language- and environment settings (Domain / Workgroup)
- Login device: Keyboard/ Chip card Reader / other devices

That's why it is possible for users to login and to logout using their native language via keyboard. But it is also possible to login using a chip card where name, domain and password is saved in encrypted form.

Efficient graphics system



The modern graphics system of WinCC supports the work of a project engineer as well by the use of standardized preconfigured picture components as when creating user definable picture components and faceplates. The use of these components enables the project developer to create his own at any time reusable company specific project standards which results in a much shorter Time-to-Market for the project.

Global settings which can be done in the graphics system enable the project engineers to implement once defined company standards in a WinCC project and to apply these timesaving to all picture objects which have the same attributes. It is also possible to export these settings and to import them again to any other WinCC project.

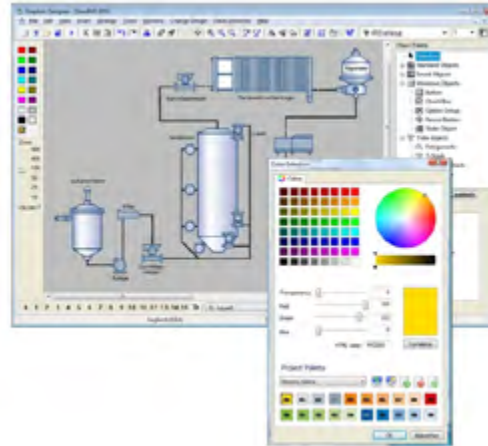

On one hand this possibility supports the in-house standardizing in an efficient way and on the other hand it provides the opportunity that several project engineers can work on huge applications simultaneously in accordance with the company standards. When creating images it is of course possible to do Direct2D (soft shadows) and to integrate SVG – files.

Instead of using discrete colors the color palette is working with color indexes. This enables the user to realize customer-specific designs in a very simple way. If for example a customer wants to change the color from red to orange he only has to assign the color orange to the index for the color red. While changing this, the color of all red objects having the same index changes to orange.

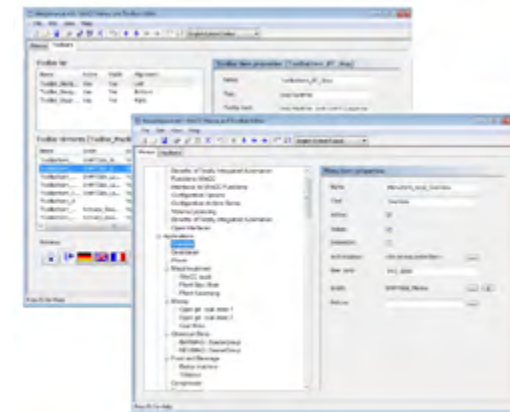

Applying modular design makes it simple to create and to centrally manage custom specific faceplates. Changes are automatically applied to all points where the faceplate is utilized. For example efficient operation is possible by the use of application specific menus and toolbars. It is possible as usual in Windows to either fix them or to leave them movable.

The project engineers are able to adapt the Menus and Toolbars to their individual needs by using the integrated 'Menus and Toolbars Editor'. This makes configuring even more efficient.

Libraries and wizards accelerate make the setup of projects easier. Therefore they reduce the error rate dramatically.

Efficiency in Runtime

Efficient operations management – the WinCC Runtime functionality



Manufacturing processes are becoming more and more complex against a background of ever increasing quality requirements coupled with fast product changes and frequent modifications. To ensure the highest possible productivity at the same time, it has to be possible to make prompt, target-oriented decisions regarding process optimization at all levels of a company. This requires an integrated flow of information across all operating levels and locations.

SIMATIC WinCC provides you with high transparency and the basis for process optimization. The intelligent use of information improves the processes in the company for a fast return on investment. This reduces costs, avoids waste, improves the utilization of production facilities and ultimately guarantees better efficiency and cost effectiveness for the company.

Ready for worldwide use

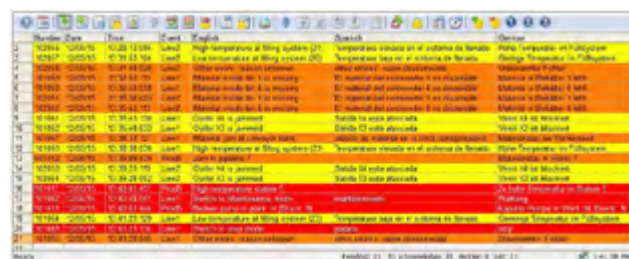
The image shows a screenshot of a WinCC interface displaying a multi-language data table. The table has columns for 'Message', 'Date', 'Time', 'Unit', 'Status', 'Search', and 'Cancel'. The data is presented in multiple languages, including English and German, demonstrating the software's ability to support different languages simultaneously. The table contains various status messages and their corresponding dates and times.

WinCC allows you to implement display languages in a simple and cost-effective manner. Thanks to UNICODE support, the display language can be changed at any time during operation. This is independent of the language set in the operating system. This means that it is possible to display multiple languages parallel to each other, such as message texts in European and Asian languages.

This makes commissioning considerably easier in international teams.

Integrated Monitoring Client



The WinCC/WebUX option is supplied with the WinCC system and differentiates between Monitoring and Operate clients. With the installation of the basic system as WinCC/WebUX server, ONE Monitor client is available at no additional cost.

This allows you to display your plant information using smartphones, tablets, PCs and other mobile devices that support a HTML 5 capable browser. No installation is required on the client side in order, for example, to display important product data for quality assurance or key production figures for the management.

Additional Monitoring and Operate clients for remote operation can be added at any time by means of appropriate licensing.

High-performance data archiving

Historical process information is stored in WinCC process value archives. Process values and messages are archived in the integrated, high-performance MS SQL server database, and memory requirements are optimized through powerful, loss-free compression functions.

You can configure 512 archive tags in the WinCC basic system. In the final configuration, this archiving can be extended to up to 80,000 variables per server by using power packs. The frequency of the archiving (cyclic, event-driven) can be configured for each value and, if required, additional compression can be configured with the swinging door algorithm.

In addition to automatic archiving, with the corresponding authorization, it is possible to insert values manually into the archive or to change archive values.

This is required for laboratory values, for example, in some industries. For reasons of traceability, such values are marked as "manually changed" and the process documented by an operation message.

To reduce the amount of data for long-term archiving, data can be further compressed. For this purpose, the maximum, minimum or (weighted) mean, the total or the difference are calculated for configurable time periods (such as day, month, year) and stored in compressed archives.

In addition to the archiving on a WinCC server, central, optionally redundant long-term archiving can also be implemented using the SIMATIC Process Historian option.

Efficient analysis of process values (Trends)

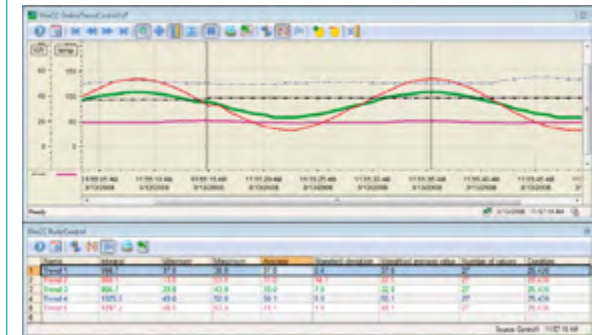

Efficient controls are integrated into WinCC process pictures for the display of current or historical data. Process values can be displayed as a table or analyzed using a trend display.

The display is either predefined or can be adjusted individually by the operator, if authorized. Numerous means of representation guarantee the best possible overview.

The freely configurable toolbar functions also provide the option of integrating project-specific functions.

f(x) trends, e.g. pressure/temperature, can also be displayed in addition to the time- and value-based representation.

Efficient analysis of messages

	Integral	Minimum	Maximum	Average	Standard deviation	(Weighted average value)	Number of values	Duration
1	5362.7	5.8	126.0	64.5	26.0	64.5	217	1:48:000
2	3964.3	24.0	190.8	63.8	26.1	63.8	217	1:48:000
3	7233.0	151.0	136.8	67.2	13.3	67.2	217	1:48:000
4	16448.3	17.6	166.0	96.8	44.8	96.7	217	1:48:000

In combination with the Ruler Controls, there is also the option of performing statistical calculations online without the need for programming. The relevant statistics – maximum and minimum value, average value, (weighted) mean, integral and total – are displayed without delay for a time range selected in the Trend Control.

1	Date	Time	Number	Status	Type	English
1	19.05.15	09:17:53	101002	Hi	Alarm High	Switch to Maintenance mode
2	19.05.15	09:18:32	102053	Hi	Warning Low	Outlet 14 is jammed
3	19.05.15	09:18:32	102053	Hi	Warning Low	Outlet 14 is jammed
4	19.05.15	09:18:32	101064	Hi	Warning High	Low temperature at Mill system (2)
5	19.05.15	09:18:32	101064	Hi	Warning High	Low temperature at Mill system (2)
6	19.05.15	09:18:37	101001	Hi	Alarm High	Switch to stop mode
7	19.05.15	09:18:37	101001	Hi	Alarm High	Switch to stop mode
8	19.05.15	09:18:37	102054	Hi	Warning Low	Outlet 13 is jammed
9	19.05.15	09:18:37	102053	Hi	Warning Low	Outlet 14 is jammed
10	19.05.15	09:18:37	102054	Hi	Warning Low	Outlet 13 is jammed
11	19.05.15	09:18:37	101055	Hi	Warning	Other errors, manual unknown
12	19.05.15	09:18:37	101054	Hi	Warning High	Low temperature at Mill system (2)
13	19.05.15	09:18:37	101054	Hi	Warning High	Low temperature at Mill system (2)
14	19.05.15	09:18:37	101054	Hi	Warning High	Low temperature at Mill system (2)
15	19.05.15	09:18:37	101002	Hi	Alarm High	Switch to Maintenance mode
16	19.05.15	09:18:37	101003	Hi	Alarm High	Switch to stop mode

The messages are displayed on the screen via the freely configurable WinCC Alarm Control. Here, the display of the message information can be adapted precisely to the requirements of the operator. The settings made can be saved in user-specific or global templates.

WinCC Alarm Control for the display of current/historical messages based on the contents of the individual message blocks can be filtered, selected and sorted, for example chronologically, by priority or by fault location, in the display. The contents can then be exported directly as CSV file or printed out as report. A freely definable toolbar function also offers a maximum degree of flexibility. For examples, project-specific functions can be integrated. To maintain an overview when there is a large numbers of incoming messages, unimportant operating messages

Number	Frequency	Average	Average # of	Average # of
101001	170	11.026	17.672	1.41410
101002	221	8.200	0.000	0.000
101003	170	11.026	17.672	1.41410
101004	221	8.200	0.000	0.000
101005	170	8.200	0.000	0.000
101011	170	11.026	17.672	1.41410
101012	170	11.026	17.672	1.41410
101013	170	11.026	17.672	1.41410
101014	170	11.026	17.672	1.41410
101015	170	11.026	17.672	1.41410
101016	170	11.026	17.672	1.41410
101017	170	11.026	17.672	1.41410
101018	170	11.026	17.672	1.41410
101019	170	11.026	17.672	1.41410
101020	170	11.026	17.672	1.41410
101021	170	11.026	17.672	1.41410
101022	170	11.026	17.672	1.41410
101023	170	11.026	17.672	1.41410
101024	170	11.026	17.672	1.41410
101025	170	11.026	17.672	1.41410
101026	170	11.026	17.672	1.41410
101027	170	11.026	17.672	1.41410
101028	170	11.026	17.672	1.41410
101029	170	11.026	17.672	1.41410
101030	170	11.026	17.672	1.41410

can be suppressed from the screen display via an alarm hiding function. The hidden messages are then archived in the background.

Numerous integrated statistics functions allow a comprehensive analysis of process states. The message hit list shows how long certain messages were pending on average and in total (message duration) and similarly the average and the total acknowledgment time. Of course, the messages can be filtered here by relevant events, message locations and time intervals. This indicates quickly where critical points and bottlenecks in the production are located. To sort the messages in the message display for an evaluation, you can simply select the column heading and the required sorting criterion (for example, "Frequency, descending").

Efficient Web-based reporting



The SIMATIC Information Server can be used to create target-group-oriented reports and evaluations using historical WinCC and Process Historian data on the basis of Microsoft Reporting Services.

The reports created are available as Web-based dashboards or on tablets and can be automatically forwarded as emails. Through add-ins, transparent data access is also possible with MS Word, MS Excel or MS PowerPoint.

➤ Video "Process Historian"

➤ Video "Information Server"

Efficient analyses of production processes



Weak points in production processes can be located and potential for optimization identified using the WinCC/Performance Monitor. Plant-specific key performance indicators (KPIs), such as overall equipment efficiency (OEE), are calculated and analyzed directly in the WinCC system. Conclusions about efficiency can be derived by comparing the time states of machinery or equipment in the Gantt chart. Key performance indicators such as day, shift or product can be compared directly with each other using Performance Control. Additional associations, such as quality per supplier, can be shown by linking context values. Target-group-oriented analysis reports can also be created Web-based with the SIMATIC Information Server.

➤ Video "WinCC/PerformanceMonitor"

Efficient management of data records (recipes)

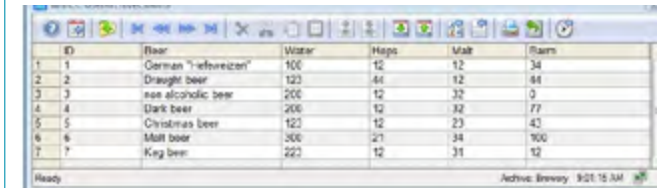
The screenshot shows a data table with columns for 'ID', 'Beer', 'Water', 'Hops', 'Malt', and 'Rum'. The rows represent different beer recipes. The status bar at the bottom indicates 'Ready' and 'Active: Brewery 9:01:15 AM'.

With WinCC/User Archives, related data, such as machine parameter assignments or production data, is grouped together in user archives. Such archives are characterized by a fixed data structure that is predefined during the configuration.

The individual parameters can be specified by the operator in runtime or directly exchanged with the automation partners (for example, a SIMATIC S7 controller). The data records can be further processed with other tools (such as MS Excel) via the import/export function.

Traceability in production processes

WinCC/Audit is used to provide end-to-end traceability of operator activities in operation and to record project changes during the engineering phase by means of project versioning and audit trails. All change data is recorded in a tamper-proof database - the so-called Audit Trail – and displayed using the Audit Viewer. The use of WinCC/Audit helps machine manufacturers and plant operators to simultaneously reduce the expenditure for fulfilling the requirements according to 21 CFF Part 11 and EU 178/2002.

Efficient energy data management



Increasing energy costs worldwide are becoming a big challenge for companies – and thus also a key factor in a company's success and in safeguarding jobs. Rising energy prices and an increased public awareness of environmental issues mean that effective energy management is contributing more and more to the success of companies and thus to safeguarding the continued existence of companies. Improved energy controlling and the reduction of power costs are among the main challenges faced by companies. Industrial companies continue to battle against a lack of transparency in their infrastructure processes, against changing cost centers, heterogeneous system environments and a costly power reporting.

[↗ Video "SIMATIC B.Data"](#)

Calendar- and event-based functionality

The two calendar options expand WinCC with calendar-based functionality. Joint calendar control is hereby used to plan times or validity periods.

Time-linked actions can be triggered with the WinCC/Calendar Scheduler.

The WinCC/EventNotifier sends notifications depending on the occurrence of certain events in the WinCC message system.

Efficient process diagnostics

WinCC/ProAgent allows targeted process diagnostics for machinery and plants. Through the integration in the world of SIMATIC process diagnostics, ProAgent offers an integrated solution based on STEP 7, engineering tools and S7 controllers.

Scalability

From single-user system to web-based solution for all technologies and industries

To be able to meet growing requirements, the visualization must be expandable at any time without causing technology incompatibilities or requiring completely new configurations.

Investment protection is a top priority.

SIMATIC WinCC provides the required integrated scalability, from the small single-user solution to the client/server solution and operator stations on the web. Redundancy solutions for highest availability and security can be built up as well.

In addition to scalable configurations, WinCC options and AddOns offer customer-fit extensions for technological and industry specific solutions.

Client-server solutions

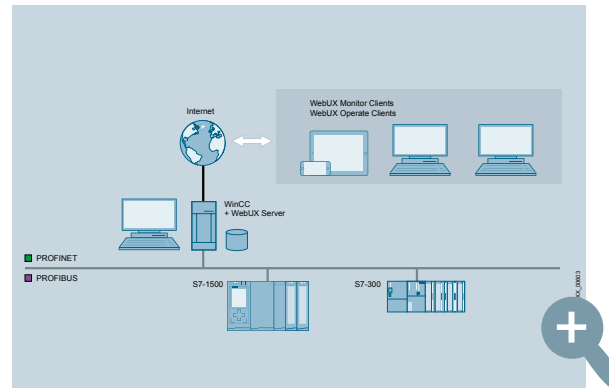

Depending on requirements, a WinCC single-user system can be expanded into a high-performance client/server system. In this way, several coordinated operator control and monitoring stations can be operated together with networked automation systems.

Redundant server solutions

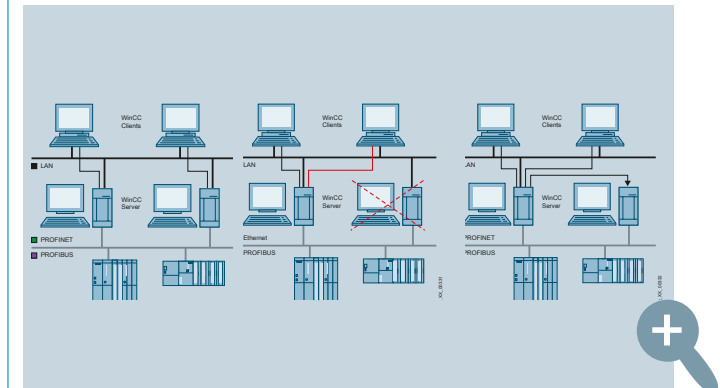

The WinCC/Redundancy option gives the user the opportunity to operate two linked WinCC server PCs in parallel, in order to monitor each other. On the failure of one of the servers, the second server assumes control of the entire system. When the failed server resumes operation, the contents of all message and process value archives are copied back to the restored server. The automatic switch to the redundancy partner within the framework of WinCC/Redundancy is not only carried out in the case of a failed server, but also in the case of a faulty process communication.

Web solutions

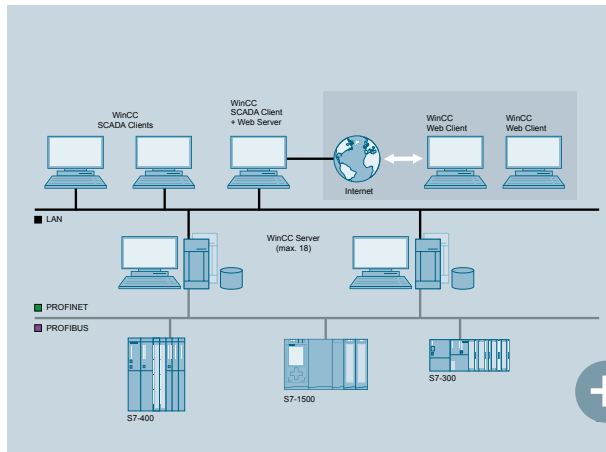

WinCC/WebUX offers flexible operator control and monitoring of plant processes via the Internet or an intranet, especially using mobile devices (tablet PCs or smartphones). All devices with HTML5-capable browser are supported.

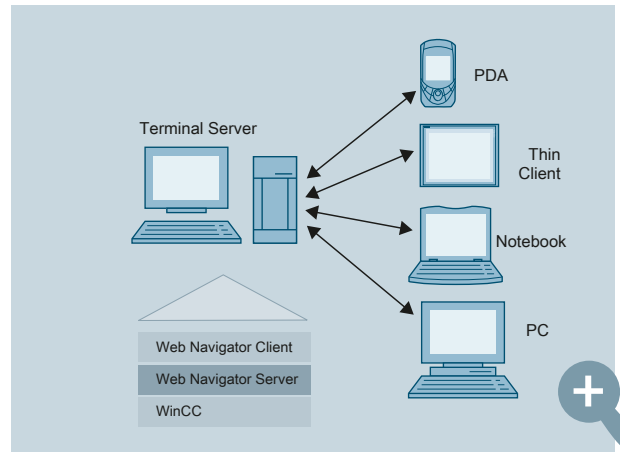

WinCC/Web Navigator allows integrated operator control and monitoring of plants via the Internet or intranet without having to make changes to the WinCC project. Thin client solutions support the use of PCs and even rugged on-site devices and mobile PDAs.

Web-based reporting

SIMATIC Information Server supports the creation of target group-oriented reports and analyses of historical WinCC data on the basis of Microsoft Reporting Services.

The reports created are always available on Web-based user interfaces and can be automatically distributed by email.

Transparent data access is also provided by MS Word, MS Excel and MS Powerpoint.

Central archive server solution

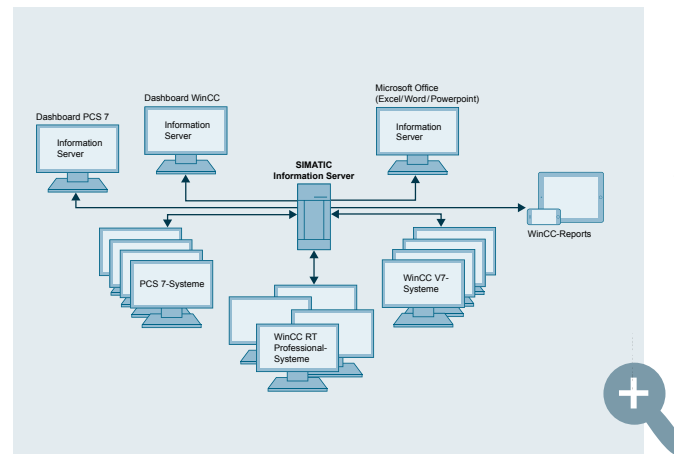

SIMATIC Information Server supports the creation of target group-oriented reports and analyses of historical WinCC data on the basis of Microsoft Reporting Services. The reports created are always available on Web-based user interfaces and can be automatically distributed by email.

Transparent data access is also provided by MS Word, MS Excel and MS Powerpoint.

SIMATIC Process Historian provides high-performance long-term archiving functionality for perfect integration into the SCADA System WinCC: Process data and messages can be written to central archives in real-time mode, without additional engineering efforts.

The data in a central long term archive can be provided by several WinCC systems. You can use standard WinCC functions to analyze them or employ the SIMATIC Information Server for further processing.

SIMATIC Process Historian replaces the previous WinCC/ CentralArchiveServer option.

Performance Analysis

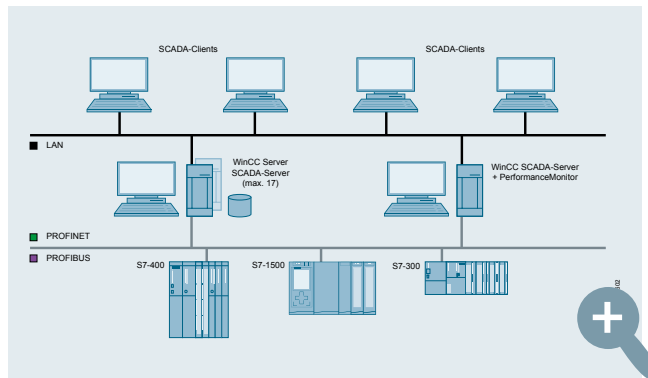

Using the WinCC/PerformanceMonitor shows weak points of production and to suitable optimization potential can be derived.

Therefore, plant-specific key figures (KPIs) for individual devices, machines, or entire production lines can be calculated and analyzed in machine or line-oriented production plants.

The required formulas e.g. for calculate of OEE, are configured in WinCC and directly linked to process values. It is possible to link KPIs with context data to get further correlations e.g. quality for each supplier.

WinCC provides table-, performance- and gantt controls to analyze performance indicators- also using WinCC/ WebNavigator. Target group-oriented reports and analyses are always available on Web-based user interfaces using the SIMATIC Information Server option.

Solutions for all industries and technologies

WinCC/SES manages and controls sequential processes e.g. for dosing, mixing, material handling.

Distributed over one or multiple production units, production processes are organized in a simple and flexibly manner. The combination of automated processes and manual adaptations simplifies the handling of natural resources (e.g. in food and beverage industries).

The WinCC/Telecontrol system is the cost-effective solution for monitoring and controlling widely distributed processes in systems of any size and in any industry.

Therefore, it flexibly integrates remote terminal units into the central process visualization system of the entire plant via a WAN (Wide Area Network). It supports the three most important international telecontrol protocols IEC 60870-5 101/104, DNP V3 (serial or TCP/IP), and SINAUT ST7 (serial or TCP/IP).

The diverse network topologies and transmission protocols allow a flexible configuration according to individual requirements.

Related products Software for Energy Management

SIMATIC B.Data

allows users to implement an optimized and cost-effective operational energy management in the areas of controlling, planning and energy procurement.

> [More about SIMATIC B.Data](#)

SIMATIC powerrate

ensures transparency in energy consumption from the infeed to the load. Energy data is continuously collected, archived and further processed.

> [More about SIMATIC powerrate](#)

SIMATIC B.Data*/Energy Manager PRO

> [More about SIMATIC B.Data/
Energy Manager PRO*](#)

* SIMATIC Energy Manager PRO is the proposed successor of SIMATIC B.Data

Innovation

Future proof due to innovative solutions



➤ Video "WinCC/WebUX V7.3"

Mobile SCADA providing exactly the information the user needs

The WinCC/WebUX takes account of the increasing calls of the users to mobile view and control processes via the internet and the intranet.

Using such a flexible access to gain plant data extends the classical control room as it is today. Depending on the application area it is possible to monitor only as well as to control the process.

Because of the individual access to process data using the mobile Scada the user will be informed

- fast
- cheap
- target oriented

about all the data of a plant which is important for him.

Web-based reporting system for historical plant data

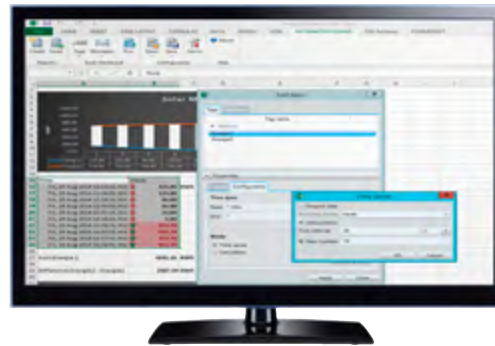

➤ Video "SIMATIC Information Server"

SIMATIC Information Server is a comprehensive reporting system for analyzing archived data. Based on the Microsoft SQL Server Reporting Services it provides interactive reporting services in the form of Web-based analyses. The reports created are always available on Web-based user interfaces and can be automatically distributed by email. Transparent data access is also provided by MS Word, MS Excel and MS PowerPoint using Add-ins.

Consistent reporting system for:

- SIMATIC Process Historian 2014
- WinCC (V7.0 SP3 or higher) and WinCC/ PerformanceMonitor option package
- WinCC (TIA Portal) RT Professional (V13 SP1 or higher)
- PCS7 (V8.0 or higher) and SIMATIC Batch

Transparency at any time in any place from process to management level.

Intuitive operation with 2-finger multi-touch gestures



➤ Video "SIMATIC IPC Multi-touch"

State-of-the-art, innovative operational concepts with multi-touch gestures are rapidly gaining significance in the industrial environment. The gestures that users know from consumer devices are particularly useful for more simple and intuitive operation of complex production plants.

SIMATIC WinCC V7.3 accordingly supports two-finger operation. You can implement functionality such as zoom or wiping, for example, for screen navigation and panning. SIMATIC HMI WinCC V7.2 also supports two-hand operation that can be used, for example, as enable function for setpoint input.

Openness

Using standards for easy integration

SIMATIC WinCC all times stands for a high level of openness and integration capability because it is consequently based on standard technologies and software tools.

Starting with its first version SIMATIC WinCC relies on the market leader in the operating system area. It doesn't matter if you use Microsoft Windows 2008/2012 Server, Windows 7 or Windows 8.1 you can track updates in the operating system. At last for you that offers additionally investment security.

The powerful SQL Server 2008 R2 SP1 (32 Bit) is integrated within the WinCC basis system. Using open interfaces helps you to automatize the engineering as well as the runtime and the access to archive data.

Individual adjustments

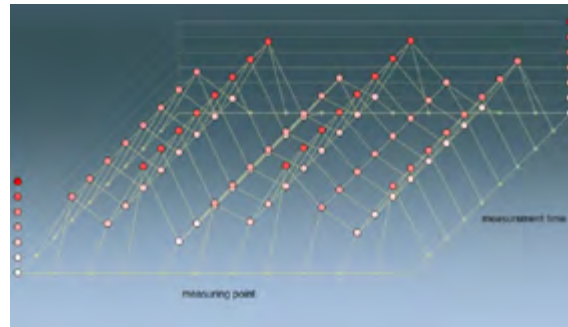

Extensions of the runtime system

Using WinCC it is possible to realize connections and dynamic sequences without programming only by the use of standard dialogues. To realize more complex functions it is possible at any time to write scripts using VB or ANSI-C. Examples for such scripts are the conversion of values or the automatic start of reports or of individual messages.

When programming VB scripts you are supported by the use of a proprietary, comfortable editor with debugging support.

When using scripts you have full access to the properties of all WinCC graphical objects and to the controls as well as to the object model of WinCC and the applications of other manufacturers.

Enhancements of the engineering system

Furthermore the comfortable configuration tool Visual Basic for Applications (VBA) is integrated in the WinCC Graphics Designer. This is very helpful for writing custom specific enhancements including debugging. By using this functionality engineers and users can make full use of their Visual Basic-knowledge. VBA can be used to realize own standards, to handle recurring tasks, to create menu entries or configuration dialogues. This saves time and money.

Open programming interfaces



The WinCC function modules are exposed using interfaces which allow access to the data and the functions of the configuration environment as well as to the runtime system itself.

Using this interface you are able to apply WinCC-projecting functionality and runtime functions to your scripts or to write autonomous applications with direct access to the WinCC system.

The WinCC/Open Development Kit (ODK) describes the open interfaces which are provided as C-Application Programming Interface (C-API). Starting with WinCC V7.2 the ancient option WinCC/IndustrialX is included in ODK. Also numerous additional ActiveX-elements and a configuration toolset containing Visual Basic Templates is included for the simple creation of ActiveX-Controls. The development of individual controls supports the creation of industry- and technological functions as protected and standardized modules. This reusable controls shorten your time-to-market and protect your know-how. Besides of the integration of ActiveX-Controls using the WinCC Media Control (.NET Framework 3.5 & 4.0 Container) the integration of user specific XAML and .NET controls is also supported.

Bidirectional information flow from shop-floor to top-floor

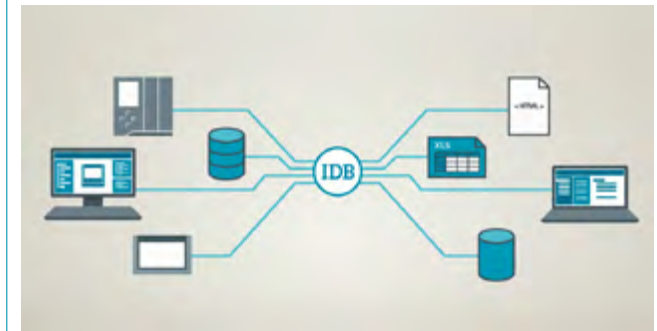

➤ Video "WinCC/IndustrialDataBridge"

The WinCC/IndustrialDataBridge is using standard interfaces (e.g. OPC,OLE-DB, SQL) to connect the automation level with the IT – world and to guarantee a bidirectional information flow.

Using the WinCC/IndustrialDataBridge (short IDB) it is possible to exchange data between systems of different producers without having deep knowledge about their interfaces and the associated data formats. Using the efficient configuration tool of the IDB it is possible to configure the various data connections which avoids mistakes.

It is possible to apply the WinCC/IndustrialDataBridge as a system service. It is possible to use this stand-alone solution independent of the SCADA system.

By choosing the integration into the WinCC system the transparent user administration in combination with the WinCC/IDB control guarantees the monitoring of the data connection to the WinCC screens also via Web.

Cross vendor communication using OPC (OLE for Process Control)

OPC is used as a communication standard for a secure and authentic data exchange between applications within the industrial automation environment. It describes a series of specifications which are used manufacturer independent as an interface between different clients and servers as well as between different servers only. These include amongst other topics direct access to real-time data, the monitoring of messages and events as well as access to historical data.

Originally the OPC standard only was available on Windows operating systems. This standard was developed from OLE (Object linking and embedding) for Process Control. The new OPC UA spec which was introduced in 2009 describes a real universal connection. This standard is based on a secure, simple technology-independent platform which is future-assured and scalable as well as expandable for all challenges of the different company levels.

SIMATIC WinCC offers by default: an OPC DA-client 2.05a/V3.0 providing access to process data e.g. to connect the system to third-party PLCs or -systems.

WinCC/Connectivity Pack and WinCC/Connectivity Station

The Connectivity options open a series of additional communication possibilities using WinCC OLE-DB Provider OPC.

The option package WinCC/Connectivity Pack every time is used in combination with a WinCC system. The WinCC/ConnectivityStation is used with autarchic PCs (without WinCC installation).

- **WinCC OLE-DB Provider**

For direct access to process values and message archives. It is possible to write individual applications using WinCC OLE DB to get access to the databases. For the communication with the WinCC OLE DB-Provider ADO DB /ADO.NET can be used within applications, which for example are build using Visual Basic, VBScript or VB.NET

- **OPC XML DA 1.01-Client**

Web based and platform-independent access to process values for example to integrate third-party PLCs or -systems

- **OPC UA Client 1.02**

Access to process data according to the OPC Unified-Architecture specification

- **OPC HDA 1.20-Server (Historical Data Access)**

Access to historical data of WinCC for example to share the data for your own proprietary reporting system

- **OPC A&E 1.10-Server**

Forwarding of WinCC process alarms and events

- **OPC XML DA 1.0-Server**

Platform independent data exchange via web between WinCC and Office-applications, ERP/PPS-systems (e.g. SAP/R3) or Business-to-Business-portals

- **OPC UA Server 1.02**

Transfer of process values, archive data and messages of WinCC under the terms of the OPC UA specification 1.02. In addition to that a separate licensed OPC UA Server for the connection to the SIMATIC Process Historian is available

Packages

WinCC complete package/runtime package



The WinCC system software is available in two basic variants:

- WinCC complete package (RC: license for runtime and configuring)
- WinCC runtime package (RT: runtime license)

Both packages are available with 128, 512, 2k, 8k, 64k, 100k, 150k or 256k PowerTags. PowerPacks allow an increase in the number of usable Power-Tags. Thus, WinCC also grows when your application grows.

Only process tags that are connected to the controller or other data sources via a WinCC communication channel are designated as PowerTags. The WinCC basic system already allows up to 512 archive tags to be configured, as WinCC includes a Microsoft SQL Server licenses. In the final capacity stage, Archive PowerPacks enable the expansion to up 80,000 tags each server.

SIMATIC WinCC offers a configuration user interface in English, German, French, Spanish, and Italian, Chinese (simplified and traditional), Japanese and Korean.

There are special Asian WinCC versions available which are additionally protected by a hardware dongle. Software packaging and licenses are following the same scaling as the European version.

SIMATIC SCADA and SIMATIC IPCs



The SIMATIC SCADA systems and SIMATIC Industrial PCs together form a high-performance and reliable platform for the acquisition, evaluation, and visualization of data. The harmonized and certified total package of hardware and software offers the highest quality in all industries.

[↗ More information](#)

Update Service and Special licenses

WinCC Comprehensive Support (Software Update Service)

The Software-Update Service for WinCC comprises the Updates and Upgrades of the WinCC basic software as well as the WinCC Options. Therefor and because of additional information included in each delivery we called it WinCC/Comprehensive Support.

[↗ More about Update Service](#)

Trainer Packages

In the context of the program Siemens Cooperates with Education you can purchase trainer packages at special conditions.

[↗ More about Siemens Automation cooperates with education](#)

Virtualization

To reduce the administration and maintenance effort, the automation world is turning increasingly to virtualization and the opportunity it provides to decouple applications from hardware. This enables centralized management and further simplifies backing up and restoring the system environment. Client environments can be installed once and distributed among one or two virtualization servers using virtual sessions (instances).

SIMATIC WinCC Options

Expanding your WinCC basic system



➤ Video "SIMATIC WinCC V7.4 – Presentation at Hanover fair 2016"

Get SIMATIC WinCC tailored to your requirements. WinCC options are evidence of the modular expandability and the universal application of WinCC which is the core for a whole range of different applications. The WinCC option packages are produced in the context of WinCC development. As the basic WinCC software they are supported by the technical advisory service and the central hotline.



SIMATIC WinCC/Audit

Tracing operator inputs and project changes

Description

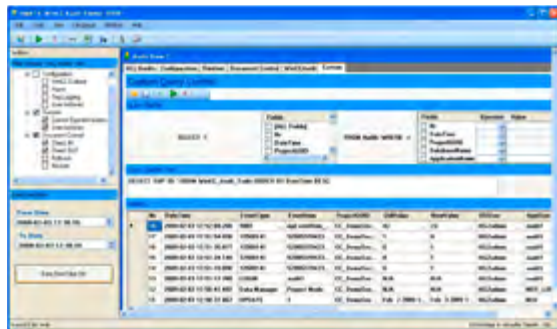

WinCC/Audit is for monitoring changes in operator activities in runtime operation as well as for recording project changes at the engineering stage. The system records all the change data in a secure database known as the Audit Trail. You can view the Audit Trail using the Audit Viewer.

This means that using WinCC/Audit provides continuous traceability of both operator activities and changes to projects and, at the same time, also helps machine tool builders and plant operators to reduce the amount of engineering time and effort involved in complying with the requirements of 21 CFR Part 11 and EU 178/2002. The engineering measures that are necessary for making validation easier are documented in a white paper.

Benefits

- Reliable recording of operator actions and project changes in Audit Trails
- Project versioning and document control
- Compliant with the requirements of the FDA (Food and Drug Administration)
- Reduced engineering effort to comply with 21 CFR Part 11 & EU 178/2002

Design and functions

Monitoring runtime operation

In runtime operation the system records the following in the audit trail:

- Operating activities carried out,
- Activities within the scope of central user management using SIMATIC Logon
- Starting and changing recipes

Apart from this, plant operators can individually record specific events by means of an audit entry function:

- Operation of pushbuttons and sliders
- Record Pressing of a key

Audit Trail database and Audit Viewer

The Audit Trail database stores all the change data that is subject to document control; this includes user actions, configuration changes and other changes. Components of Audit Trails include:

- Date and time of the change
- Project ID, PC and database name
- Old value and the new one
- User name
- Event/function
- Comment/reason for change

The system visualizes the Audit Trail data by means of the Audit Viewer. Operators use filters to selectively set the desired view of the Audit Trail data and they can export this data to an Excel file. The Audit Trail data is stored securely on a tamper-proof basis and this means that you cannot change or delete it.

This means that WinCC/Audit meets the FDA requirements of 21 CFR Part 11 in this respect too.

Design and functions

Tracking project changes

Monitoring project changes is possible with WinCC/Audit and with the option package WinCC/ChangeControl as well. In this connection, WinCC differentiates between configuration changes that affect the WinCC database, e.g. changes in Tag Management or creating a user group and configuration changes that are limited to changes to files, what is known as document control. Document control involves process pictures, scripts and log layouts and customer-specific documents. This means that WinCC/Audit can monitor all these documents or files for changes, create intermediate versions or retrieve them using a rollback function. The entire monitoring process can be activated very easily and conveniently. This means that in the case of plant standstills, for example, plant engineers and operators can quickly and easily comprehend the changes that have been made to the plant. This supports trouble-shooting and reduces plant downtimes.

Project Name	User	Date	Version	Comment
1 Webboard1	siemens	03.04.2015 11:06:03	0.1.0.0	Startup
2 Webboard1	siemens	03.04.2015 14:45:37	0.2.0.0	Ready for Audit
3 Webboard1	siemens	03.04.2015 14:47:29	0.3.0.0	Config Audit
4 Webboard1	siemens	03.04.2015 15:17:18	0.4.0.0	Admin user
5 Webboard1	siemens	03.04.2015 16:42:20	0.5.0.0	Setup Navigation
6				
7				
8				
9				
10				
11				
12				
13				

Using a project versioning tool

- WinCC projects can be archived, restored and deleted
- WinCC data including the project database, project files (e.g. screens, reports, scripts) and user documents can be archived
- Activities of the project versioning tool can be recorded

In this way all changes made to a plant beginning from the production start and continuing throughout the entire life cycle can be recorded and – using defined versions – be documented.

WinCC/Calendar Scheduler and WinCC/Event Notifier

Working with calendar functions

Description

The Calendar Options supplement WinCC with calendar-based functions. A common calendar control supports the planning of schedules and of validity periods. You can use the Calendar Scheduler to trigger time-based actions; the Event Notifier sends messages depending on specific events in the WinCC message system.

Benefits

- Simple and reliable scheduling of events and actions
- User-friendly HMI in the style of Microsoft Office
- Easy to send important messages to a defined group of people at a defined time by email or text message
- Guaranteed comprehensibility:
- Events and actions are logged and displayed in the WinCC alarm logging

Design and functions

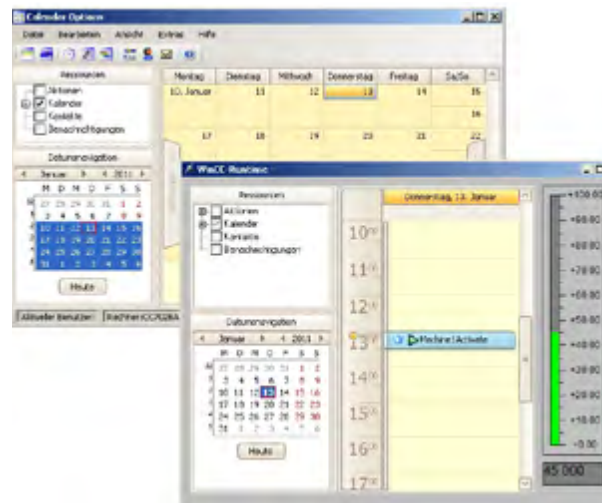

WinCC/Calendar Scheduler

The Calendar Scheduler supplements WinCC by a calendar-based HMI in the style of Microsoft Office. It includes editors with which events and associated actions can be configured and managed. The planned events and actions can be connected directly to WinCC tags or global scripts. In order to control the plant process, several calendars, events and associated actions can be created, filtered, edited and managed. For example, the action editor can be used to execute program scripts. The editor supports events and interruptions which occur regularly, e.g. holidays or maintenance work.

Multi-level user privileges protect the scheduling from unauthorized access. The message system logs and displays every action carried out. This guarantees comprehensibility of the corresponding events.

Design and functions



WinCC/Event Notifier

You can use the Event Notifier to set which people in a defined time period are notified about specific events. The events are associated with messages in the WinCC message system. Contacts can even be selected as potential messaging targets from the WinCC user administration during runtime. The messages can be sent via email or via a provider gateway as text message(SMS) to a mobile phone.

If multiple groups of people are defined for messaging in the same time frame, different escalation times (i.e. delay time before messaging) can be realized. This means that group 2 is only messaged if none of the people "on-site" or the previously messaged people have responded within the configured escalation time. When someone reacts to the triggering event, all persons messaged receive an acknowledgment.

Calendar Control is configured in the Graphics Designer and can be dynamized with all WinCC standard mechanisms such as tag connection, VBS, C, direct connections or dynamic dialogs in WinCC.



WinCC/ChangeControl

Tracing of project changes

Description

Monitoring project changes is possible with WinCC/Audit and with the option package WinCC/ChangeControl as well. In this connection, WinCC differentiates between configuration changes that affect the WinCC database, e.g. changes in Tag Management or creating a user group and configuration changes that are limited to changes to files, what is known as document control. Document control involves process pictures, scripts and log layouts and customer-specific documents. This means that WinCC/Change Control can monitor all these documents or files for changes, create intermediate versions or retrieve them using a rollback function. The entire monitoring process can be activated very easily and conveniently. This means that in the case of plant standstills, for example, plant engineers and operators can quickly and easily comprehend the changes that have been made to the plant. This supports trouble-shooting and reduces plant downtimes.

Benefits

- Project versioning and document control
- Compliant with the requirements of the Food and Drug Administration (FDA)
- Reduced engineering effort to comply with 21 CFR Part 11 & EU 178/200

Design and functions

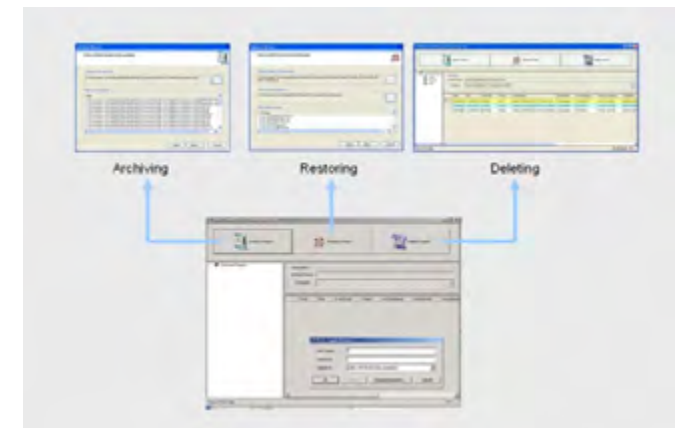

Using a project versioning tool

- WinCC projects can be archived, restored and deleted
- WinCC data including the project database, project files (e.g. screens, reports, scripts) and user documents can be archived
- Activities of the project versioning tool can be recorded

In this way all changes made to a plant beginning from the production start and continuing throughout the entire life cycle can be recorded and – using defined versions – be documented.

WinCC/Connectivity Pack and Connectivity Station

Access to WinCC using OPC & WinCC OLE-DB

Description

In WinCC, non-proprietary communication in the field of automation has always been very important.

WinCC has as standard an integrated OPC DA 3.0 server (Data Access) that gives you access to all the online values in the system and, on the other hand, can as a client read data from another application - across the Web too. The WinCC/ Connectivity Pack offers additional options.

This means that the system can transfer pre-processed process and production data to higher level systems for information conditioning (e.g. Manufacturing Execution Systems, Enterprise Resource Planning systems or office packages, e.g. Microsoft Excel, Microsoft Access, etc.).

Benefits

- Simple IT and business integration by means of standard interface
- Access to online and historical data from any computers you like via standard interfaces. (OPC XML DA, OPC HDA, OPC A&E, WinCC OLE-DB)
- Further processing or analysis of data using separate tools is possible

Design and functions

Access to messages and historical data via OP /WinCC OLE-DB

The WinCC/Connectivity Pack includes the OPC HDA 1.1 (Historical Data Access) and OPC A&E 1.0 (Alarm & Events) servers for accessing historical data of the WinCC archive system or for transferring/acknowledging messages. As an OPC XML DA 1.0 server, WinCC can even send data on a cross-platform basis across the Web to PPS/MES systems; in the opposite direction, it can take OPC XML DA client order or recipe data. As an HDA server WinCC makes available historical data from the WinCC archive system to other applications. The OPC client (e.g. a reporting tool) can specify the start and end times of a time interval and thus selectively request the data to be transferred. Apart from this, the client can request already conditioned data from the HDA server, i.e. actively trigger data compression before the data is transferred. The OPC HDA server can also be used in redundant configurations.

Design and functions

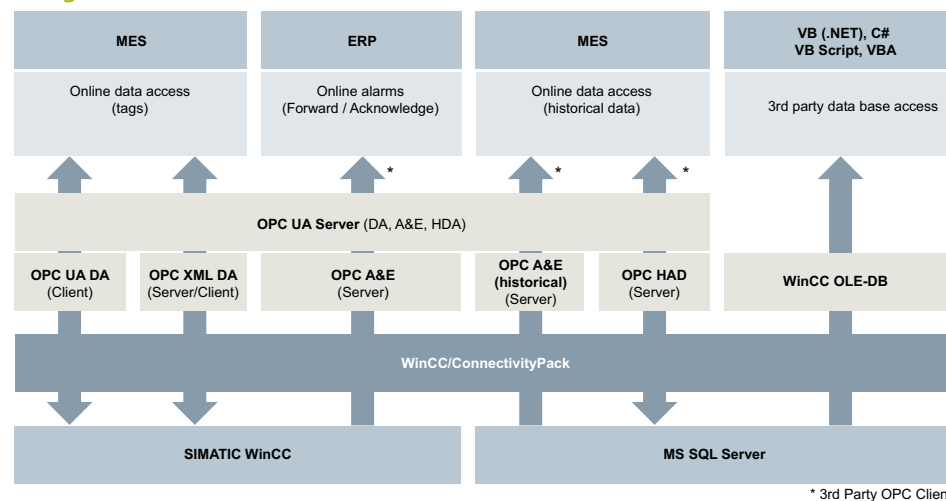

In OPC A&E, the system displays a WinCC message as an alarm and, together with all the ancillary process values, passes it on to any subscribers on the production or company management levels. Due to the filter mechanisms and subscriptions, the system only transfers selected, changed data. It is, of course, also possible to carry out acknowledgement at the MES or ERP level.

The WinCC OLE-DB Provider makes it possible to directly access the archive data that WinCC stored in the Microsoft SQL Server database (alarms, process values, user data). In this connection, you can even use statistic functions. From a WinCC multi-client, a transparent process data access via the OLE DB is now also possible to redundant WinCC systems and distributed configurations with central archive server. For the addressing, only the symbolic computer name is needed.

WinCC/ConnectivityStation

If process visualization is not needed at a station, you can use this WinCC option package to configure any Windows computer you like as a connectivity station with access to WinCC via OPC and WinCC OLE-DB without needing a WinCC installation to do so.

Client Access Licenses (CAL)

To directly access current WinCC data via OPC DA, you do not need a separate license. You always need WinCC/CAL whenever you want to access WinCC data across the interfaces of the options WinCC/Connectivity Pack and WinCC/IndustrialDataBridge from any computer which has not installed (and licensed) neither the basic WinCC system nor a WinCC option.

If desired, the WinCC/CAL pro Processor License even provides access for all the computers in your configuration to the interfaces of the Connectivity Pack or allows them to use the IndustrialDataBridge.

Fig.: WinCC/ConnectivityPack:
Access to WinCC via OPC &
WinCC OLE-DB

WinCC/DataMonitor

Visualizing processes, analyzing and distributing data

Description



The WinCC/DataMonitor is an important component for plant intelligence applications in combination with the process visualization system WinCC.

The DataMonitor is used for the display, analysis, interpretation and distribution of current process states and historical data from the process database. With the DataMonitor, WinCC process data can thus be made available to all functional levels in the enterprise via the Web.

Benefits

- Displaying and analyzing current process status conditions and historical data on office PCs using standard tools like Microsoft's Internet Explorer or Microsoft Excel
- No additional time and effort for configuration, since you can directly use pictures from the WinCC project
- Evaluation via centrally administrated templates for detailed analyses of company processes (e.g. reports, statistics)
- Creating event- or time-controlled reports
- Information from the process can be grouped on an individual basis at runtime (information portal) and distributed to different people by e-mail
- User administration with user groups and individual access rights (read, write, create of WebCenter pages)

Design and functions

Powerful tools for the depiction and interpretation of current process states and historical data (measured values, messages, user data) from the process database enable the production to be efficiently monitored and analyzed as well as reports to be created and distributed to the appropriate persons. For the display, a DataMonitor client can be set up on any office PC. The data provider – a WinCC/ Web Navigator server or a WinCC/DataMonitor server– is installable on any WinCC single-user system, WinCC server or WinCC client.

The DataMonitor and its tools

For visualization and analyzing the WinCC/DataMonitor comprises several internet capable tools that support all common security features like Login/Password, firewalls and encrypting procedures.

- Process Screens Purely for monitoring purposes of WinCC process screens
- Trends & Alarms Display and analysis of archived process values and alarms in trends or tabular form
- Excel Workbooks Display of archived process values in an Excel table for the analysis and storage on the Web or as print template for reports
- Published Reports Generation of time-controlled or event-controlled reports in Excel format or as Portable Data File (PDF)
- WebCenter Central information portal for the access to WinCC data via user-specific views, clearly arranged Web-Center pages due to user-groups with individual rights for reading, writing or creating web-center pages.

Design and functions

Process screens

The function Process Screens is used purely for monitoring purposes and for the navigation across WinCC process screens with the MS Internet Explorer as a so-called "viewonly client" with an adjustable cursor. In doing so, the WinCC/DataMonitor employs the same mechanisms as the WinCC/Web Navigator, e.g. for the communication, the user administration, the display of screens.

Trends and Alarms

Trends and Alarms is a tool for displaying and analyzing archived WinCC process values and alarms. A predefined page already contains the displays for the process value table, the corresponding trends, the alarm table and the alarm hit list with the associated operator functions. Also included are the statistics functions from WinCC for process value patterns and alarms (e.g. average, standard deviation, variance). Tables only have to be linked with the desired WinCC archive data (measured values or alarms). Chosen data can also be exported to a CSV file and be processed further at a later time (e.g. compression).

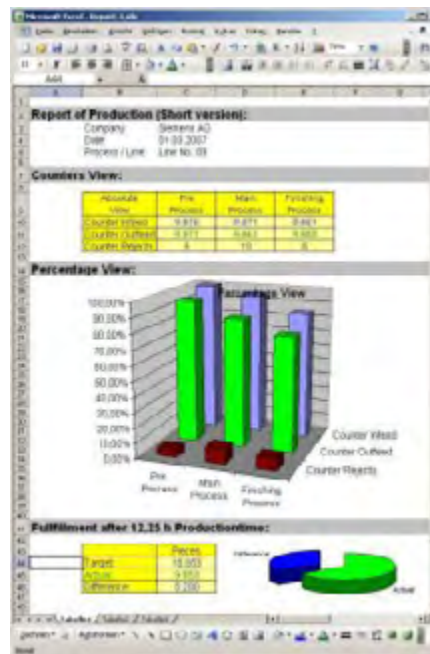

Fig.: Excel Workbooks

Excel Workbooks

The Excel Workbooks are a reporting tool for the display of alarms and current or archived process values in an Excel table. The data can then be analyzed via Excel functions and also be graphically formatted and summarized in a report. Once Excel workbooks have been created, they can be published and made available to the Intranet/ Internet, or be used as templates for reports to be automatically generated. Reports can also be generated offline and stored locally as a customer specific analysis.

Published Reports

Published Reports automatically generate print jobs from WinCC reports and prepared Excel workbooks. The reports are started time-controlled (e.g. at the end of a shift) or event-controlled (e.g. upon the change of a WinCC tag) and can be distributed by e-mail. Reports created by Excel are saved as XLS file. The corresponding file created by the WinCC Report Designer is stored in PDF format, and can be further processed and analyzed afterwards.

Design and functions

WebCenter

The WebCenter is the central information portal for the access to WinCC data via the Intranet or Internet.

Here, users with corresponding user rights can compile WinCC process data, alarms and process screens for any number of screen views for various groups of persons. By means of these views, WinCC data can be compared, analyzed, interpreted and if necessary also exported over absolute or relative time periods. When analyzing historical data, the connection or disconnection of swapped archives is possible via commands.

In a WebCenter page, the user can configure and save own screen views made from WebParts. WebParts are process value tables, trends, statistics displays, timesteps (for the clear depiction of precompressed values), and alarm tables (incl. hit list), as well as a display for graphics, links, and favorites. WinCC process screens can be integrated into the WebCenter without installation work using the WebPart Process Screens.

This allows various information from the plant to be generated in an understandable form for different user groups, corresponding to the function areas of a company, e.g. for Quality Assurance (e.g. tables and trend diagrams with operating figures), the plant operator (e.g. pie charts with piece counters) or the service personnel (e.g. trends with temperature characteristics).

Selectable licensing

The licensing takes place sever-based, i.e. is made at the Web Navigator server or DataMonitor server. Depending on the selected license, the DataMonitor software package for the DataMonitor server contains up to 50 client licenses. The number of client licenses denotes the maximum number of clients that can be active at the same time, whereas in principle, any number of clients can be connected. For upgrading the number of simultaneously active clients, Powerpacks are offered.

WinCC/IndustrialDataBridge

Flow of information between production (WinCC) and the IT world

Description

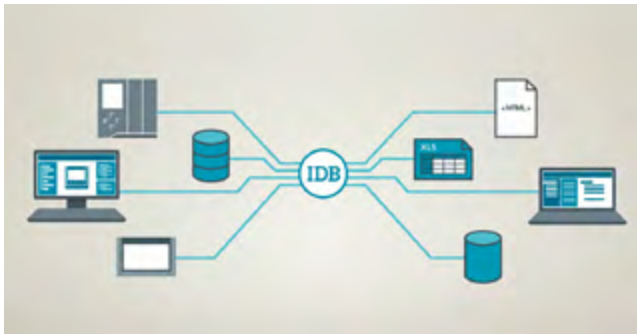

[Video WinCC/IndustrialDataBridge](#)

WinCC/IndustrialDataBridge uses standard interfaces to link the automation level (controls) to the IT world and to ensure a flow of information in both directions.

Systems from different manufacturers can be integrated by using a variety of standard interfaces (e.g., OPC, OLE-DB, SQL). The easy configuration (without programming) saves time and prevents errors. The integration into the WinCC system and its user administration as well as the alternative use as system service guarantee the security of the transmission.

Benefits

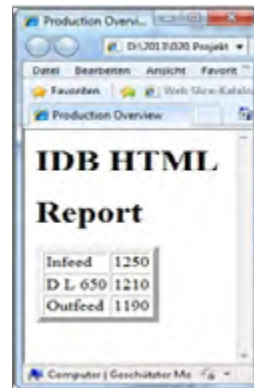

- Connection of WinCC to databases and IT systems
- Support of standard interfaces (such as OPC, SQL, ODBC, OLE-DB, Office formats) means there is no restriction to specific vendors
- High-performance, bidirectional data exchange between different systems
- Runtime administration of data connections in WinCC (also via Web) or via independent application running as system service
- Visualization of information on HTML-pages
- Fast and reliable due to configuration instead of programming (errors are prevented)

Design and functions

IndustrialDataBridge exchanges data between automation systems from different manufacturers.

- Coupling of SCADA and control systems from different manufacturers by means of the OPC interface
- Central information hub for parallel access to one or more WinCC systems
- Cyclic data archiving can be implemented via the OPC Data Access, WinAC ODK or Send/Receive data sources and the SQL database data target

Description

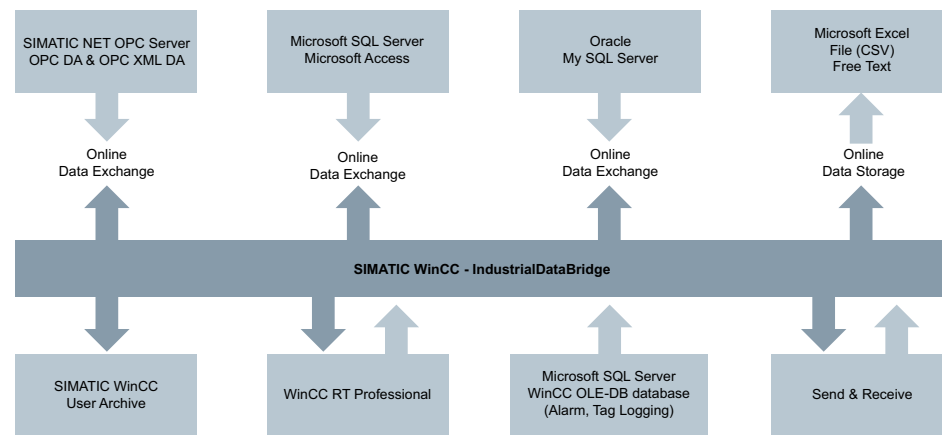

Data sources and destinations inside IndustrialDataBridge

Provider (data sources)	Consumer (data destinations)
	csv, txt
	MS Excel 2003, 2007, 2010, 2013
MS Access 2003, 2007, 2010, 2013	MS Access 2003, 2007, 2010, 2013
MS SQL Server 2005, 2008, 2008R2, 2012	MS SQL Server 2005, 2008, 2008R2, 2012
My SQL 3.5, 5.1, 5.5, 5.6	My SQL 3.5, 5.1, 5.5, 5.6
Oracle 8i, 10g, 11g, 12c release 2	Oracle 8i, 10g, 11g, 12c release 2
OPC Data Access 3.0	
OPC XML 1.0	OPC Data Access 3.0
OPC XML 1.0	
	IDB OPC Server
Send/Receive	Send/Receive
WinCC V7.2, V7.3 (via OLE DB)	
WinCC UserArchives V7.2, V7.3	WinCC UserArchives V7.2, V7.3
WinCC RT Professional V13 SP1 (via OLE DB)	WinCC RT Professional V13 SP1 (via OLE DB)
	Configurable TXT/ HTML

Design and functions

Flexible switching between applications

Application scenarios:

- Reading/writing of WinCC data from/to Office formats such as MS Excel or MS Access
- Reading/writing of WinCC data from/to databases
- With a database as a data source, central recipes can be transferred directly into WinCC UserArchive or a controller, for example
- Event-driven reports, e.g., automatic shift report in CSV files at end of shift (relevant messages and process values per shift). The name of the file can be assigned as required.ext

IndustrialDataBridge makes a connection between the source and destination interface and transfers the data as follows

- depending on a change in value
- after a configurable time has expired
- or if a specific event occurs
- Individual data or data blocks (>,<,inside where...) are transferred

The data exchange can be bidirectional via up to 32 data connections. Depending on the volume of data, licenses are available with 128, 512, 2k and 10k tags.



Start as system service for unmanned servers in computer centers or IDB integrated in WinCC user interface incl. run-time administration of connections.

SIMATIC Information Server

Description



The SIMATIC Information Server gives you transparent access to plant information at any time. Historical plant data can be simply compiled in web-based dashboards or reports without programming knowledge. This ensures comprehensive access to plant information for each target group in the company (managers, quality assurance, maintenance) at all time.

Benefits



➤ Video "SIMATIC Information Server"

- Full transparency of historical WinCC data (WinCC Archive and SIMATIC Process Historian)
- Uniform and independent of version for different data sources
- Efficient, web-based analysis through clearly structured dashboards and automated reports
- Process information can be compiled online during runtime
- Quick generation of standard reports through prepared templates
- Individual reports based on the Microsoft Reporting Services
- Cyclic activation of reports based on demands or events and forwarded by email, if necessary
- Simple analysis with MS Office through integration in MS Word, MS Excel or MS PowerPoint
- Plant information at any time – from any location: Web-based analyses also on mobile devices

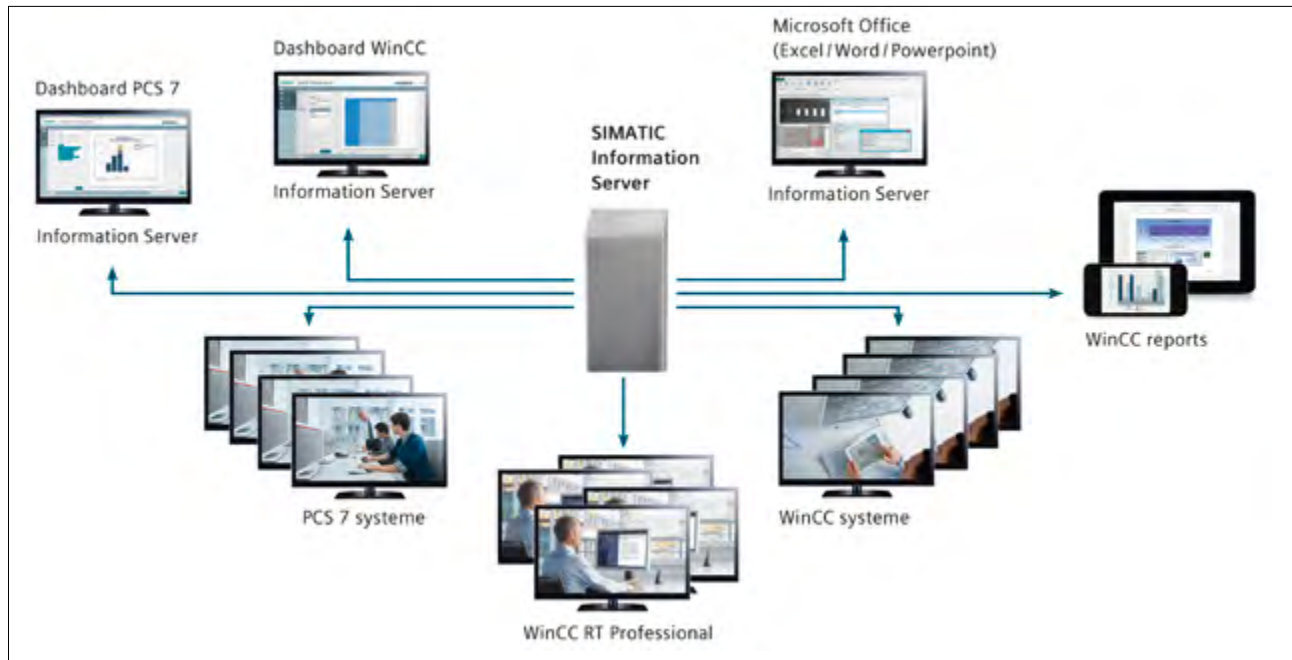

Existing knowledge can be optimally reused thanks to the integrated analysis of data from different sources with only one reporting tool. Comprehensive analyses with a uniform look and feel create transparency and show weak points. Necessary optimization measures can be developed quickly and efficiently to increase plant productivity and availability.

The SIMATIC Information Server is installed on a separate PC or on a WinCC single-user station, WinCC server or WinCC client.

Licenses

- The SIMATIC Information Server basic license gives access to one data source for up to three clients
- The number of simultaneous client access operations can be incremented at any time using Information Server client access licenses
- Additional data sources can be integrated at any time using additive data source licenses

Design and functions

The integrated reporting system, based on the Microsoft SQL Server Reporting Services, creates and manages dashboards and reports interactively and makes them available on the web at any time. Integration in Microsoft Word, Excel or PowerPoint also lets you access historical data using the tools you know from the Office environment.

By making the SIMATIC Information Server available for a variety of products, it can be used for any WinCC system even across different versions. The SIMATIC Information Server is also used as a reporting system for the SIMATIC Process Historian.

WinCC/ODK (Open Development Kit)

Including former option WinCC/IndustrialX

Description

Would you like to considerably expand the functionality of WinCC for a sector-specific application? Do you want to integrate your own data in WinCC tools, e.g. the reporting and logging system?

The WinCC options package Open Development Kit WinCC/ODK specifies open programming interfaces, which you can use to gain access to data and functions of the WinCC configuration and runtime system. The interfaces are designed as C-Application Programming Interface (C-API). Programming examples show the use of C# and VB.NET with WinCC /ODK.

Starting with WinCC V7.2 the former option WinCC/IndustrialX is part of the Open Development Kit.

WinCC/IndustrialX is an option that further simplifies the solving of a visualization task by standardization of user-specific objects. No separate display object is required any more for each motor, pump, valve, etc., instead objects of the same type are standardized. Engineering become more cost-efficient, if functions and displays can be used repeatedly.

Benefits

- Individual system expansions via an open standard programming language (C++, C#, VB.NET)
- Access to data and functions of the WinCC configuration and runtime system
- Development of your own applications and add-ons for the WinCC basic system
- Easy creation using configuration wizards
- Fast-track starting due to the use of standards: ActiveX technology, creation using Visual Basic
- Central creation and modification of object representations of the same type (type-coding) saves you time and money
- Configuration of intelligent, vertical market and technology-specific objects (graphic representation and logical processing) with expertise protection
- Can be used on a diverse basis: in WinCC pictures and other Windows applications (e.g. Internet Explorer, Excel)

Design and functions

For example, ODK functions can be used

- to generate a message
- to determine the value of a tag
- to change the object properties in a screen
- to export a database table

IndustrialX employs the ActiveX technology for the process visualization. Configuration wizards make the creation of your own standard displays easy. IndustrialX controls are flexible and can be tailored to meet the requirements of the most varied applications, for example specific for applications in the chemical, glass or paper manufacturing industries. IndustrialX offers code templates for easy linking customerspecific ActiveX controls to WinCC data sources that are themselves suitable for use on Web Navigator clients.

Design and functions



Quick and easy to configure

Using the IndustrialX Control Designer, you create one IndustrialX control for process objects of the same type, e.g. for several motors. Linking is carried out of the individual data of a data record e.g. the target value, actual value, temperature and operating mode. Once you have created the IndustrialX control, you can integrate it into pictures as often as you like.

At integration, you only need to specify the name of the data record. At runtime, each integration of the IndustrialX Control then automatically works with the data of the assigned data record. Each time the IndustrialX Control is used, you do not need to spend time and effort on linking the individual data.

Carry out modifications on a central basis

If you have a lot of IndustrialX Controls, which are already integrated in process pictures, you can easily change them later. Such changes are made once at a central location and can affect the graphic representation as well as the processing logic. All the changes affect all the IndustrialX controls in all the process pictures that have already been configured. If, for example, there are 47 motors of the same type in a plant that are visualized in 13 different process pictures using IndustrialX controls, you only need to make the changes once at a central location. These changes are then effective everywhere. This obviates the need to carry out time-consuming, errorprone changes at 47 different locations!

Rapid processing, know-how protected

IndustrialX controls are composed of compiled Visual Basic code that guarantees fast, effective processing. The technological know-how that you invested in creating your controls can - if necessary - be protected from copying if the source code is not supplied.

In the delivery kit for WinCC/ODK there is a CD-ROM with several examples and a voucher for a one-day training session and expanded support via a telephone hotline.

ODK functions are also employed by the WinCC Competence Centers and WinCC Specialists for the development of technology and industry-specific WinCC Add-Ons.

WinCC/PerformanceMonitor

Production analysis and optimization on the basis of individual key performance indicators

Description



➤ Video "SIMATIC WinCC/PerformanceMonitor"

With the WinCC/PerformanceMonitor, plant-specific key figures for individual devices, machines, or entire production lines can be calculated and analyzed in machine or line-oriented production plants.

- OEE – Overall Equipment Efficiency
- MTBF – Mean Time Between Failures
- MRT – Mean Repair Time
- and further Key Performance Indicators (KPI)

The production equipment can be defined individually depending on the specific plant.

The option WinCC/Downtime Monitor which was used in a comparable area of application will no longer be released for WinCC V7.2 and higher.

Area of application



Management and quality assurance

- Complete transparency for all machines as basis for optimizing the plant's productivity:
- Logging of downtimes, localization of causes and reasons for downtimes, and monitoring of equipment efficiency
- Basis for decision making based on performance indicators
- Reports of the InformationServer available worldwide and target-group-oriented for each user
- Identification of production interrelationships by combining key figures with associated values such as material used

Maintenance and repair

- Minimum training period and simple configuration due to the integration into the SCADA System
- Standardization of new systems by defining control-based status information to calculate key figures
- Individual, targeted analysis through plant-specific key figures via Intra- or Internet
- Adding additional plant performance indicators out of existing process data during the on-going operation
- Weak point analysis in production processes and detection of undesirable process behavior
- Cause analysis through examination of the basis for calculation "drilldown to operands"
- Identification of events that lead to cost-intensive failures

Line management and system operators

- Analysis of performance indicators can be displayed as table, Performance- or Gantt chart also in the WinCC/ WebNavigator
- Subsequent correction of archived input values
- Continuous information at the operator interface through integration in the WinCC user interface
- Flexible calculation of the performance indicators using different time frames (cyclic, interval or event-driven)
- Quick identification of weak points in the process through cyclical key figure calculation

Benefits



Using the WinCCPerformanceMonitor makes it possible to show the weak points of the production and to derive suitable optimization potential.

- Flexible – Individual calculation of plant specific performance indicators within SIMATIC WinCC
- Reaching the goal quickly – because of the integration in WinCC short configuration- and training period
- Setting up correlations - recognizing performance indicators within the content e.g. quality per vendor
- Being optimally informed – Analysing of the performance indicators and displaying them as bar- or Gantt – diagram or as a table also using the Web
- Viewing everything at any time – Target–group oriented analysis reports using the SIMATIC Information Server
- Extendable – Adding of performance indicators within existing plants without any loss of production

Design and functions



Fault analyses provide information about the frequency and duration of machine or plant downtimes. Corresponding display instruments can be effortlessly integrated in WinCC process pictures.

The determined data gives information on the effectiveness of individual machines and of entire production plants. The transparency of the data allows for a quick response and countermeasures in the event of faults, which increases the availability of the machine.

- Structuring of the production plant into individual equipment units as central components for evaluations (equipment efficiency)
- Applicable for single machines as well as for complete plants

- Simple integration into existing plants which are controlled by WinCC
- Calculation of the operands via freely definable formulas from preconfigured WinCC tags
- Cyclical or event-driven calculation of key figures based on archived operands
- Combination of key figures for associated values, e.g. material used, produces production contexts
- If needed, key figures can be written to WinCC tags (for example, trend display of the key value)

All of the analysis results are integrated in the form of controls in WinCC screens. Performance- Gantt- and table views are available in WinCC- process pictures but also using the WinCC/WebNavigator. A distinction is made between several different display instruments:

- Bar chart for analysis of key figures and their associated values.
- Determination of causes (drilldown) by displaying the input values (operands)
- Tabular display of all operands (input values)
- Gantt chart for time-based operands

Design and functions

Web-based, user-specific reports with the SIMATIC Information Server

- Optimizing of the overall plant productivity based on the full transparency of the machinery
- Recognizing the production-oriented contexts by combining of performance indicators with associated values, e.g. used materials
- Calculation of downtimes and recognizing their reasons
- Analysis of weak points within production processes

The basic package consists of the configuration environment, the runtime controls (bars, Gantt chart, table) and the license to archive 30 values. The archived values (operands, context) form the basis for the analysis.

If more values must be archived they can be increased in steps of 30, 100, 300 or 1000 archive values (additive).

If you now optimize your plant you can benefit from the WinCC Analyze and Starter Package which is available up to the 09/30/2015. This package consists of the base packages of the WinCC/PerformanceMonitor V7.3 and the SIMATIC Information Server 2014.

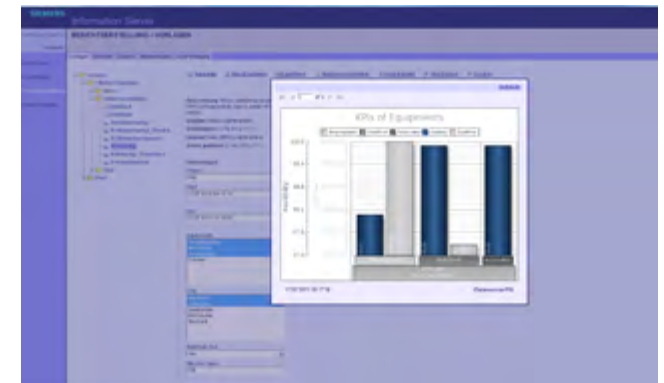

Fig.: Web-based report with SIMATIC Information Server

WinCC/ProAgent

Increased availability due to process diagnostics

Description

Increased productivity is being achieved more and more by cutting costs. In this context, the focus is increasingly on maintenance. The emphasis here is on rectifying faults as quickly and efficiently as possible. Ideally, the operating personnel should also perform part of the maintenance tasks. The operating personnel are on-site, they are familiar with the procedures and can intervene quickly. This saves time and reduces costs. It is precisely here that ProAgent can assist operating personnel in identifying faults quickly, particularly in the automotive and machine tool industries.

Benefits

- Component of Totally Integrated Automation: Increases productivity, minimizes engineering outlay, reduces lifecycle costs
- Support for troubleshooting, increased machine and plant availability, shorter downtimes
- No additional configuration costs for the diagnostics functionality due to automatic generation of the diagnostics-related parts for the controller and HMI
- Frees up controller capacity with regard to memory requirements and program execution time
- No special knowledge required to operate

Design and functions

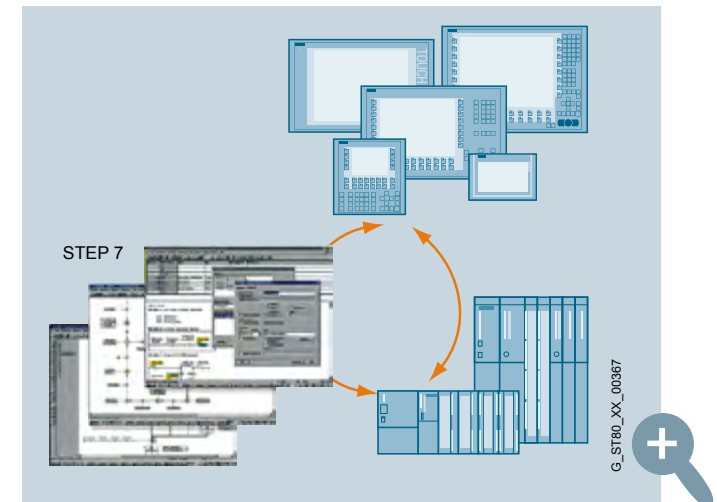

In the event of a process fault, process error diagnostics with SIMATIC ProAgent will provide information about the location and cause of that fault and support personnel with troubleshooting. The ProAgent solution has been optimized specifically for use with SIMATIC S7-300/S7-400 and SIMATIC WinAC. It can be used in combination with the S7-PDIAG, S7-GRAPH STEP 7 engineering tools. The ProAgent option package features standard displays that are updated with process-specific data during runtime.

Design and functions

Standard views instead of configuration

ProAgent is available for various devices and software platforms from the SIMATIC HMI range: Panels and Multi Panels, WinCC flexible and WinCC. ProAgent contains standard views, which are attuned to the requirements of the process error diagnosis of a plant or machine. During configuration, the data that is relevant to process error diagnostics such as symbols, comments and alarm texts are saved in a standardized data management system. During runtime, the standard screens are then filled with process-specific data.

For SIMATIC WinCC, ProAgent directly accesses the engineering data and imports it into the WinCC project. The ProAgent standard screens needed for the diagnostics mode are automatically created in WinCC. ProAgent and STEP 7 engineering tools represent a standardized diagnostics concept for SIMATIC S7. No additional configuration overhead for the WinCC application is thus required for the diagnostics functionality. The standard views are: alarm view, unit overview, diagnostics detailed view, motion view and the sequencer operating display.

Functional scope

- Context-sensitive diagnostics initiation due to process error message
- Output of the operands with symbols and comment
- Switch-over capability between LAD, STL and signal list
- Supporting fault rectification by means of direct process access when using the motion view
- Output of the faulty operands directly in the alarm including address, symbol and comment
- Consistency test in runtime: Inconsistent diagnostics units are marked with icons. This permits quick locating of faults regarding configured data in the commissioning phase
- Direct, unit-related entry point in the diagnostics view from user displays (by using ProAgent functions)
- Unit or alarm-related entry to STEP 7, e.g. LAD/STL/FBD editor, S7-GRAPH, HW CONFIG upon system error messages, is supported fully automatically
- S7-GRAPH OCX for the graphical display of step sequences (overview display)

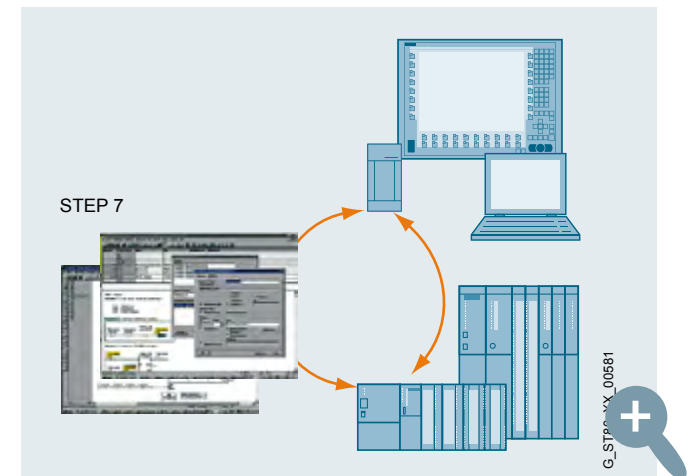

Fig.: WinCC/ProAgent: process error diagnostics

SIMATIC Process Historian

Description



The SIMATIC Process Historian is a real-time database for a variety of products and versions that serves as central data interface to the company management level. It serves as central long-term archive for any amount of process data and messages from different data sources.

Archiving in a high-performance SQL database in combination with efficient data compression mechanisms ensures that critical data will be available at any time in the future while using very little memory.

Central archiving of company data facilitates fast decision making on the basis of secured data. Full transparency is ensured by the SIMATIC Information Server.

SIMATIC Process Historian replaces the previous WinCC/CentralArchiveServer option.

Benefits

- Central interface to the corporate management level
- Real-time archive for any amount of production and MES data for the entire plant
- Version independence of the data sources
- “One-click” configuration for easily scalable data volume
- Maximum access speed using minimal memory through intelligent compression algorithms
- Security through redundancy, disaster recovery and Store & Forward mechanisms
- Openness through OPC UA server
- Full transparency of Historian data with the SIMATIC Information Server

Design and functions

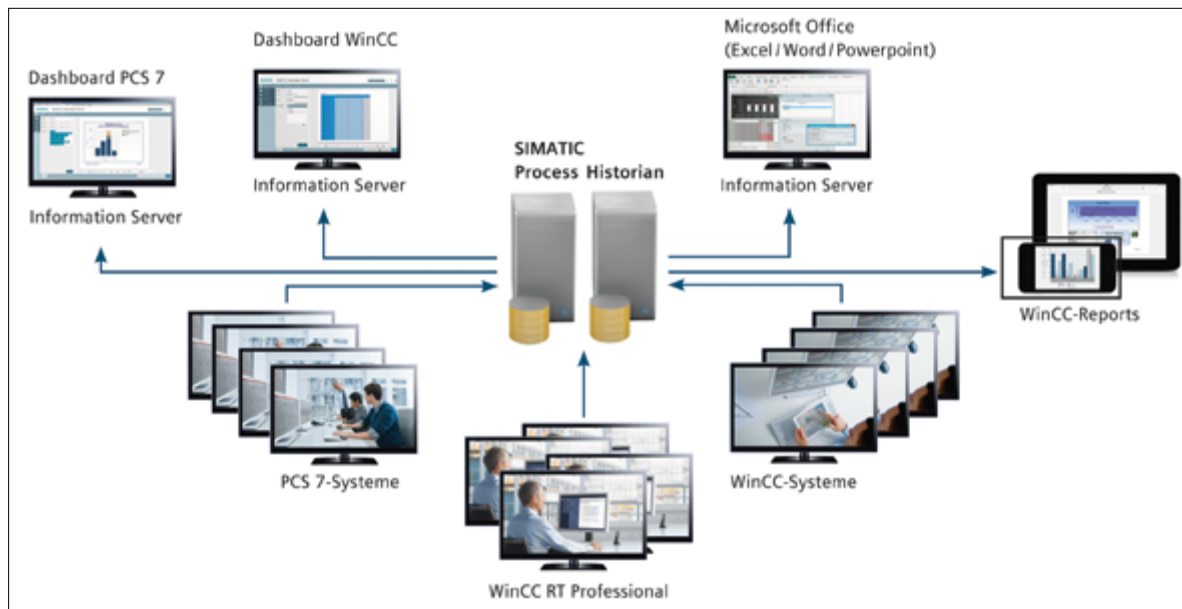

➤ Video "SIMATIC Process Historian"

The SIMATIC Process Historian is scalable and collects and archives any amount of data, independent of version, from different systems. SIMATIC Process Historian, which

is scalable thanks to its seamless integration in WinCC, including redundant configurations, meets the strictest security requirements with minimal administration.

Security

Data security is essential when using a Historian. The SIMATIC Process Historian offers a series of security mechanisms and therefore ensures that plant data can be reliably archived. Any potential failures are usually prevented by using a redundant Historian in combination with the installation of RAID systems. Loss of data due to problems in the network connection between the plant and Historian is prevented by using the "Store & Forward" mechanism. If a complete system breakdown nevertheless occurred, the database can be completely recovered through backup (disaster recovery).

Openness

SIMATIC Process Historian offers an OPC UA Server interface for connection to any IT or MES system.

Licenses

- The SIMATIC Process Historian supports the archiving of any amount of data
- The archive data is licensed at the data source, for example, in WinCC systems
- The redundancy package is required for the redundant Process Historian
- The OPC UA interface needs a separate license

WinCC/Redundancy

Increasing system availability

Description

Increasing system availability due to redundancy in the case of applications with WinCC is possible by using

- redundant servers,
- redundant communications paths
- and highly available controllers.

The WinCC/Redundancy option gives the user the opportunity to operate two linked WinCC single-user systems or server PCs in parallel, in order to monitor each other. For both redundancy partner servers you need one of the two redundancy licenses that are supplied with the option package. On the failure of one of the servers, the second server assumes control of the entire system. When the failed server resumes operation, the contents of all message and process value archives are copied back to the restored server. All in all, this results in significantly higher levels of system availability.

Benefits

- Increased system availability with continuous data integrity
- Automatic switching in the case of a server failure or communications failure with the server
- Continuous operation and visualization due to automatic switching of the clients to the intact server
- Automatic matching of all the archives, alarm information and internal variables in the background after eliminating the disturbance

Design and functions

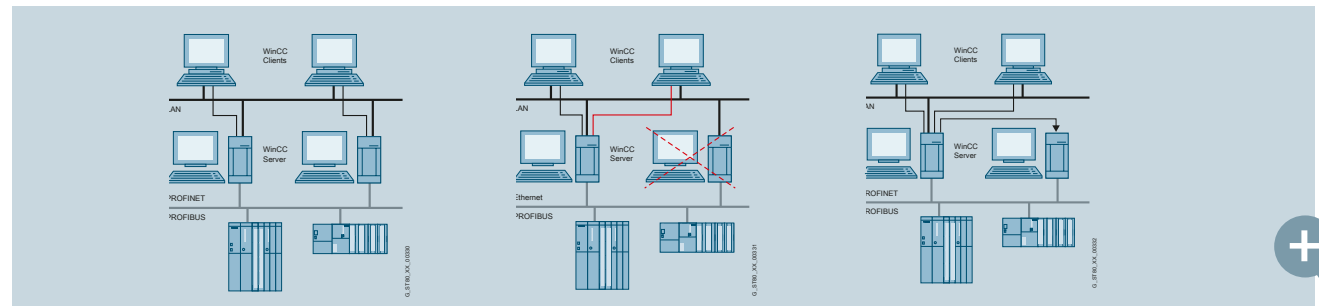

In a normal situation, two WinCC stations or process data servers operate completely in parallel, i.e. each station has its own process connection and its own data archives. If either of the WinCC stations fails, the other one takes over archiving of messages, process and user data. This guarantees constant data integrity. In clientserver operation, the system automatically switches clients from the failed server to the redundant machine. This guarantees continuous visualization and operation of the plant at each operator station. When the failed server starts up again, the system automatically matches in the background all the process values, messages (incl. statuses, acknowledgements, lists and comments) and data from the user archive for the down period (without influencing online operation) – this means that two stations are available again that have the same data.

Additional increase in system availability

In addition to using the WinCC/Redundancy option for running two servers in parallel, it is possible in a WinCC application to also implement redundant communication channels to the SIMATIC S7 controller. You do this by installing two communication modules and implementing duplicate communication paths (communication software S7-RED-CONNECT needed). By using H-series SIMATIC S7 controllers, you can, if required, additionally increase availability at the control level. By combining system solutions, you can create a security concept that meets even the most demanding requirements.

WinCC/Server

Setup of client/server systems

Description

A multi-user system is used whenever the same process is to be monitored at several operator stations. When the Option is used, several operator control and monitoring stations are coordinated to operate together with networked automation systems. The server supplies the connected clients with process and archive data, messages, pictures and logs. The result of an operator action at one operator station, for example, changing a value or message acknowledgment, is immediately available to all other operator stations.

Benefits

Integrated scalability from the single-user system to the client/server solution
Economic solution for SCADA applications with higher complexity
Configuration of distributed operator stations with little effort
Configuration of distributed client/server systems with up to 18 WinCC servers.
Clients provide access to all servers in the system
Configuration of clients as remote Web servers
Low-cost configuration on the client.

Design and functions

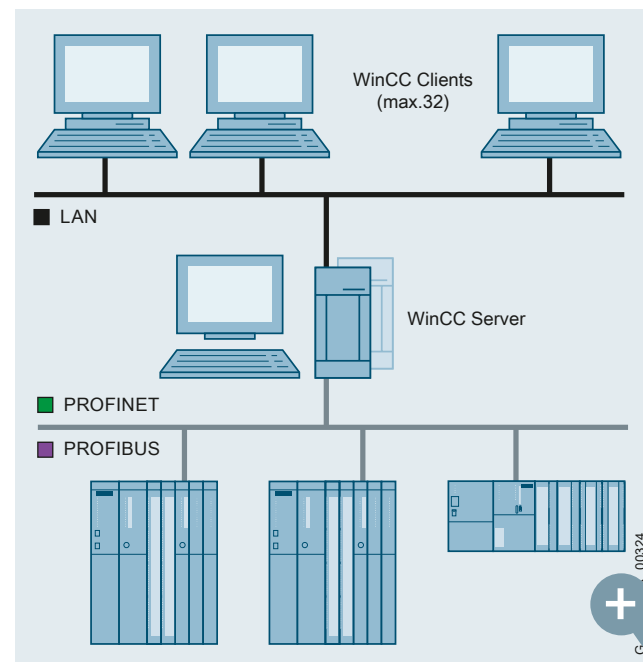

Fig.: Simple client/server configuration

The server establishes the connection to the automation system, handles the communication and coordination of the clients, and performs all archiving in the integrated Microsoft SQL database. WinCC clients access the configuration data of the server directly. Access rights are used to define the functions or plant sections that are available to a user on an operator station. The configured authorizations are user-related, not computer-related. They therefore work with all operator stations with the same login.

Licenses

The following licenses are required for configuring a multi-user system:

- WinCC Server license on the server in addition to a WinCC RT license
- One WinCC Client license on each client

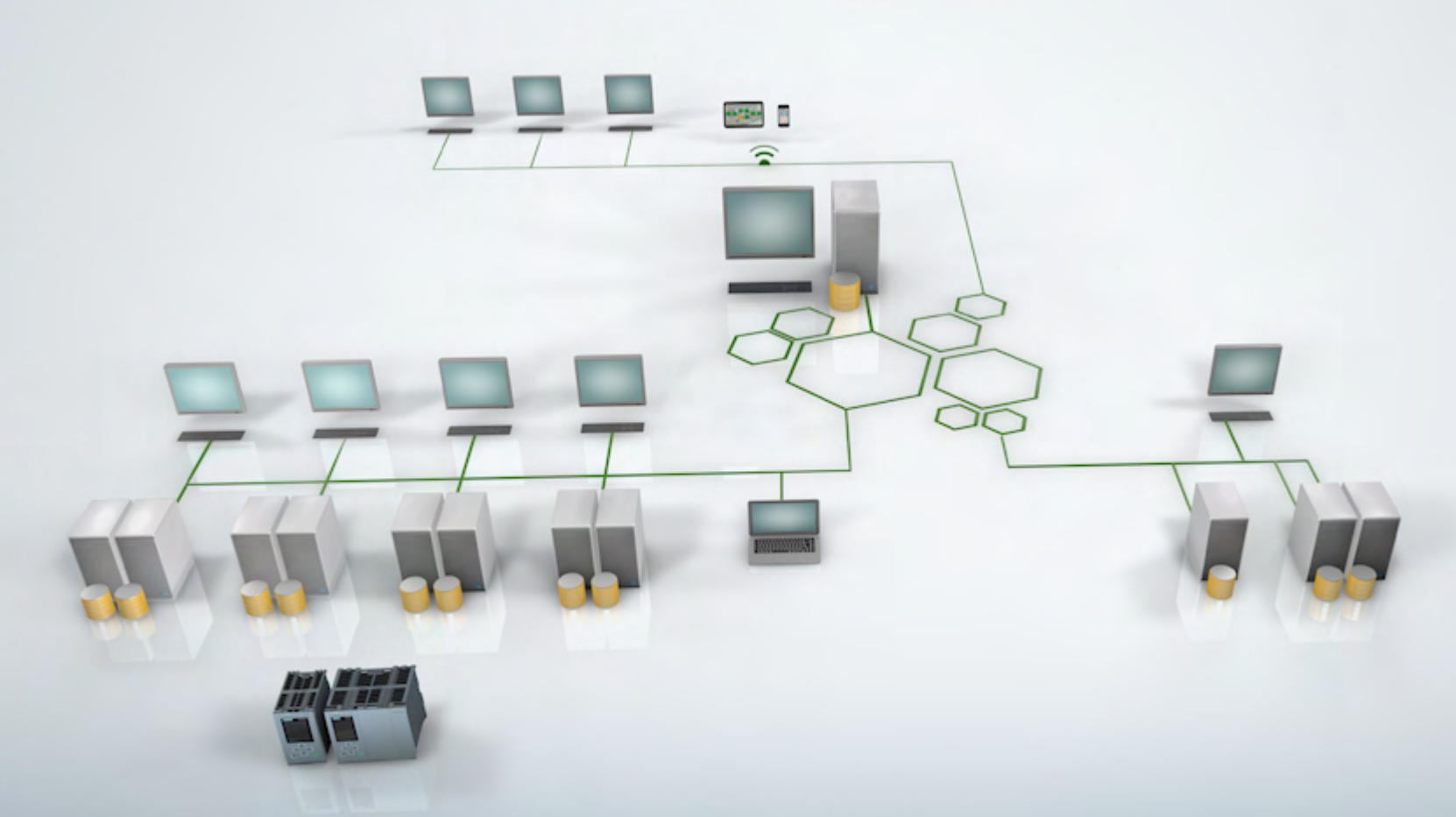

WinCC/SES

Scalable SCADA functionality for sequence based processes

Description



WinCC/SES (Sequence Execution System) is a WinCC option designed for the sequence control of recipe- and sequence based processes like mixing processes in the food and beverage production. Using predefined visualization templates and function blocks a very high level of engineering efficiency can be achieved. That's why plant designers as well as plant engineers can save as well engineering time as also test- and commissioning time.

Area of application

WinCC/SES is designed to use in manufacturing facilities where dosing, mixing as well as material handling is very important. In such plants the raw materials which are stored in tanks, silos or vessels have to be combined in the right order with reactors and processing machines. – This has to work with several processing steps up to the final product. The plant operator has to define the production steps within his production unit. He also has to set the production parameters like the set points and he has to define the production flow using sequences.

Benefits

- Minimized engineering effort because of standardization
- Quality intensification due to efficient operational management
- Flexible production paths are possible leading to a consistent load within the production processes
- Fine adjustment of the production processes while the behavior of the natural resources drift
- Real-time behavior because the single steps are processed in the PLC
- High availability
- Low training- and operational costs

Design and function

A high system availability and fast reaction time are typical for the WinCC/SES module because of the fact that the sequences are processed on the PLC and not on the PC. That is the reason why on one hand real-time behavior is achieved because of the much faster cycle time of the PLCs. On the other hand it also increases the failure-safety because if the batch has started it is still processed even if the PC crashes. After production start the SES control displays all steps and production parameters like set points and actual values as well as the actual state of the production step in a very clear and transparent manner. Due to that fact for an operator it is possible to adjust production processes very fast during normal operation for example by changing the sequence of the steps manually. This for example can be necessary if the quality of the natural resources varies or if it is necessary to change the order of the steps to reach flexible paths through the production process.

WinCC/TeleControl

Integration of remote terminal units in central process visualization

Description

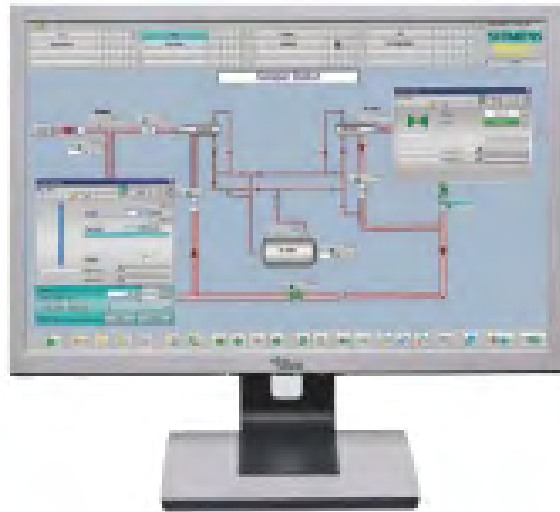

SIMATIC WinCC/TeleControl flexibly integrates remote terminal units into the central process visualization system of the entire plant via a WAN (Wide Area Network). SIMATIC WinCC/TeleControl supports the three most important international telecontrol protocols IEC 60870-5 101/104, DNP V3 (serial or TCP/IP), and SINAUT ST7 (serial or TCP/IP). The diverse supported network topologies and transmission protocols allow a flexible configuration according to individual requirements.

The software can be individually adapted to the requirements of a plant. The uniform user interface for local and remote processes minimizes the risk of errors. Less time is required for training of employees because the same SIMATIC WinCC process visualization system is used for telecontrol and for the actual process visualization.

Area of application

Widely spread plants especially in the industries:

Water/Waste water

- Water wells, pumping stations, Shut-off slides in water supply mains and irrigation systems
- Rain overflow basins and lifting stations in sewage networks
- Elevated tanks

Oil and gas industry

- Compressor-, pressure control-, transition- and measuring stations in gas networks
- Pumping stations and gate valves in oil pipelines

Benefits

- Installation, commissioning and maintenance costs can be reduced considerably
- Worldwide use and support of international telecontrol protocols (SINAUT ST7, IEC 60870, DNP3)
- Flexible configurations to match individual requirements
- High availability and data security due to redundancy concepts
- Cost-efficient due to optimized data transmission
- The uniform user interface for local and remote processes minimizes expenditure and the probability of errors
- Remote programming with SIMATIC S7-RTUs

Design and functions

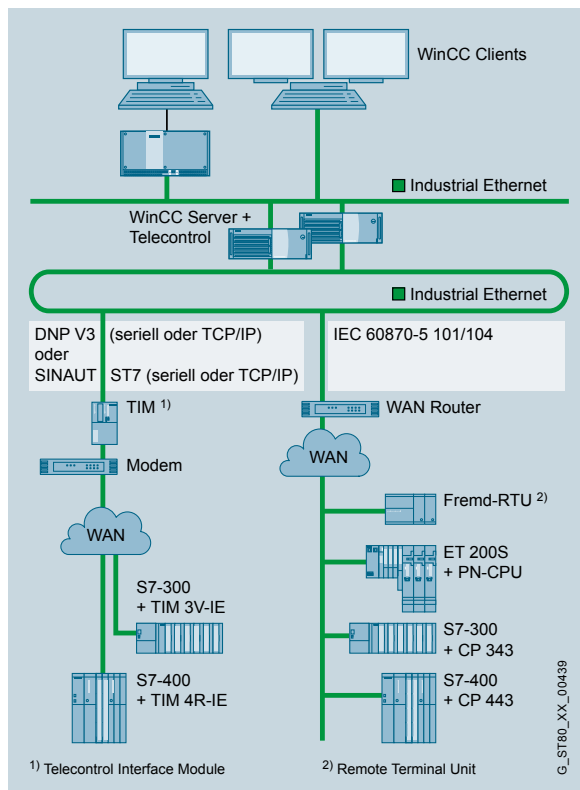

WinCC/TeleControl (for WinCC V7.0 SP2) supports the following preferred remote terminal units for distributed automation on-site:

- Controller integrated in ET 200S (Modbus, IEC 870-5-101/104 telecontrol protocols); for cost-sensitiv applications
- Controllers S7-300/S7-300F (SINAUT ST7, DNP3, Modbus, IEC 870-5-101/104 telecontrol protocols); for extremely flexible configurations
- Redundant controllers S7-400H/S7-400FH (IEC 870-5-101/104 and DNP3 telecontrol protocols) for higher requirements e.g on data security
- Third party stations with telecontrol protocols Modbus, IEC 870-5-101 and IEC 870-5-104 (depending on station type)

WinCC/Telecontrol (for WinCC V7.0 SP2) can be individually adapted to the requirements of a plant.

- Support of communication media with
 - serial interface, e.g., dedicated lines, dial-up connections (analog, ISDN)
 - radio transmission devices (standard, spread spectrum modulation), microwave and GSM
 - TCP/IP based WANs e.g., DSL, GPRS or Ethernet wireless networks
- Network topologies – point-to-point, multidrop (multi-user mode) and hierarchical network structures
- Cost-efficient due to reduced data volume by using event-driven communication mechanisms
 - Time synchronization of RTUs and correct time stamping of data
- Prevention of data losses in case of communication failures
- Redundancy for communication connections and servers

WinCC/User Archives

Managing data sets

Description

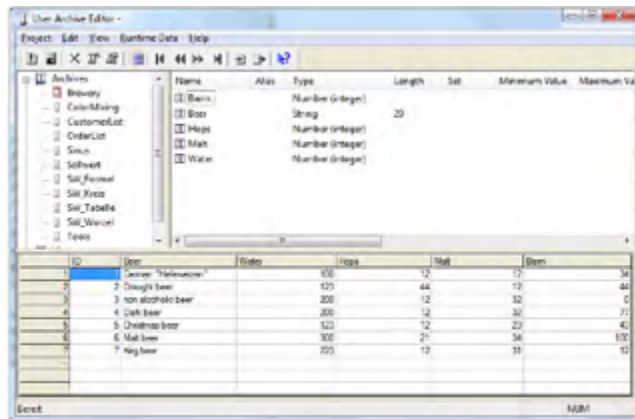

Fig.: User Archive Editor

The WinCC/User Archives option allows the application of User Archives, in which related data is stored in data records.

WinCC and its automation partners (e.g. a SIMATIC S7 PLC) can write to these data records and exchange them among one another if required.

Benefits

- Storing and managing of any user data in data sets
- Flexible display via WinCC User Archive Control, with optional table and form view
- Easy connecting of data set fields to the process via direct tag connection
- Import/export functions for further processing with other tools (e.g. Microsoft Excel)

Design and functions

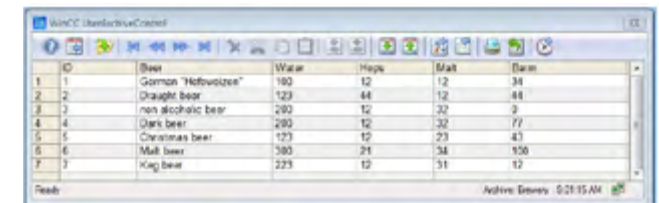

Fig.: WinCC/User Archives Runtime Control

An operator, for example, can enter parameter sets (the operating parameters of a machine) in WinCC, store them in the user archive and forward them to the automation level as needed. On the other hand, an automation system can continuously acquire production parameters during a shift and send them to WinCC at the end of the shift. Further application examples are the acquisition of batch data, the specification of production parameters or the administration of storage management data.

WinCC user archives are conveniently created in a separate editor and preallocated with data. Special ActiveX Controls, which are integrated in the object palette of WinCC Graphics Designer, are used to display data from the user archives during runtime. These controls can also run on the WebNavigator in an Internet environment. The coupling of data sets and fields from user archives to the process is easily done via direct tag connection.

WinCC/Web Navigator

Operator control and monitoring via the web

Description



The WinCC/Web Navigator allows you to perform operator control and monitoring of your plant via the Internet or an in-house intranet without the need for changes to the WinCC project. In addition to the typical use in WANs (Wide Area Networks), low-cost applications can also be implemented. Examples of these are solutions in the water/wastewater industry with highly decentralized structure or applications with sporadic access to process information (building management). In addition to this, Web clients can also be used as normal operator stations on the LAN.

Benefits

- Parallel web-based operator control and monitoring (MS Internet Explorer)
- Integrated configuration and user administration/access authorizations
- User-specific functionalities, e.g. language, plant (unit) view
- Fast update rates (e.g. after value change, picture change)
- Minimum maintenance costs thanks to centralized software administration
- High Internet security standards
- Remote monitoring using the secure WinCC Web Viewer application
- Flexible thin client solutions for a variety of platforms (PC, on-site panel, mobile PDA)
- Efficient remote diagnostics with WebDiagnostics server/client
- Increased security and availability due to separation of WinCC and Web server
- Maximum availability and performance thanks to Web server farms (load balancing)

Design and functions

For WinCC single-user systems or WinCC server/client systems, web-based solutions can be implemented with the WebNavigator. Operator control and monitoring of a WinCC project via the Internet or an intranet is possible from any Windows computers, which are referred to as WebNavigator clients. Only MS Internet Explorer is required on the client side. Simultaneous access to multiple Web servers and thus to multiple plants is even possible if this is started multiple times or its multi-tabbing functionality is used.

Security concept made to order

All Web operator stations are integrated into the user administration of the system. Authorization levels govern whether an operator can simply monitor the plant (view only) or has partial or full authorization for operator control and monitoring. Every login and logout can be traced via system events. For applications with very strict security requirements, logout after a user-defined time span is just as important as the ability to disable key combinations when it comes to security. Furthermore, the WebNavigator supports all commonly used IT security mechanisms such as routers, firewalls, proxy servers, SSL encryption and VPN technologies.

Thin client solutions

Inexpensive but lower-performance Windows PCs, rugged on-site devices (e.g. SIMATIC Thin Clients) and mobile clients (PDA – Personal Digital Assistant) can be connected via thin client solutions with Microsoft Terminal Services. Only minimum requirements are placed on the hardware here because the entire application, i.e. including the WebNavigator client, runs on the terminal server.

Siemens offers rugged SIMATIC Industrial Thin Clients as operator terminals with high-resolution wide screen touch displays. These are optimally suited for use in harsh industrial environments.



Fig.: WebNavigator Client

Flexible remote diagnostics

The WebDiagnostics client was designed for maintenance and service of widely distributed plants. In this case, the Web licensing is made for a diagnostic client locally on a service computer instead of on the system servers. Through the diagnostic client, the service technician has secure access to any number of plants that have a WebNavigator server.

Dedicated Web server and Web server farms with load balancing

The WinCC Web Server can also be configured on a WinCC (SCADA) client for even more security and availability.

Advantages of this solution:

- Increased security and availability due to separation of the system server and Web server
- Comprehensive Web solutions for multiple or redundant WinCC servers
- Web server farms allow the number of Web clients to be increased as needed
- Higher performance through load balancing
- Automatic switchover of the Web clients in the event a server fails

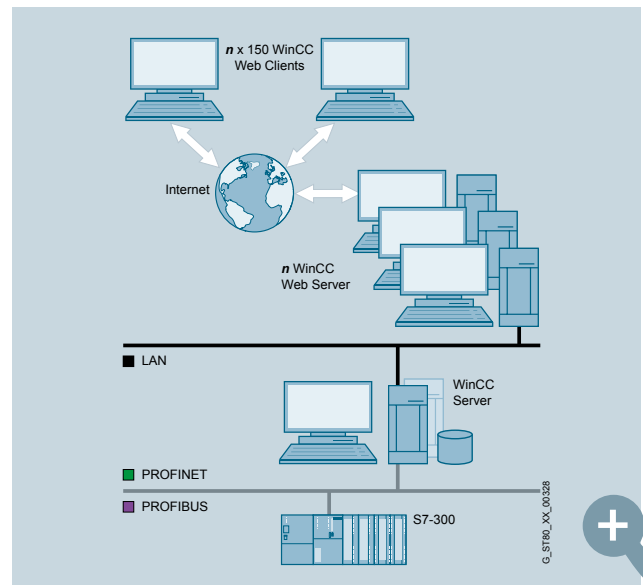

Licenses

- A (server-based) license is required for the WebNavigator. This is a graduated license based on the number of simultaneous Web client accesses, which can be incremented at any time using additive Web client licenses
- The WebNavigator client software can be installed as many times as required without the need for a license
- A (client-based) license is required for the WebNavigator diagnostics. This provides access to all Web servers with WebNavigator server WebNavigator diagnostic server license
- Dedicated Web server on a WinCC client with full-featured WinCC RT 128 license
- Web server in a "Web server farm" on a WinCC client also with full-featured WinCC RT 128 and additional load balancing license

WinCC/WebUX

Mobile SCADA over the World Wide Web (www)

Description



WinCC/WebUX was developed for use on smartphones, tablets, PCs and other mobile devices that support an HTML 5 capable browser. No installation on the client end is required for using WebUX.

This flexible access to process and plant data expands the control center that is the standard today; it also gives users the option to purely monitor or operate depending on the area of application.

Individual access to production data gives users

- fast
- cost-effective
- target-specific

information on all relevant data of a plant.

Benefits



- Mobile operator control and monitoring worldwide with all commercially available mobile devices, free selection of devices and browsers
- Worldwide, flexible online access around the clock, 365 days a year
- Secure communication over HTTPS und SSL certificates
- Integrated user administration with user-specific access authorizations for monitoring (Monitor client) or operating (Operate client)
- No installation or maintenance of the terminal devices (clients)
- Short time to market because time-consuming additional configuration is not necessary
- Consistent look and feel
- No entry costs since a Monitoring client is included in the WinCC basic package
- The WinCC server version and version of the mobile clients do not have to be the same

➤ Video "SIMATIC WinCC /WebUX V7.3"

Design and functions



WinCC/WebUX can be used independent of the industry, for example, in Service for acknowledging alarm messages, in Quality Assurance for monitoring important production data, or in Management for viewing key production figures whenever required.

WinCC/WebUX thus meets the constantly growing demands by users to monitor processes remotely over the Internet or intranet and be able to intervene, if necessary.

The WinCC/WebUX option is supplied with the WinCC basic system. No additional installation is required on the client devices, because the option is a pure browser application.

WinCC/WebUX provides a secure solution for mobile operator control and monitoring of the automation system independent of device and browser.

The WinCC/WebUX and WinCC/WebNavigator options complement one other and can be used at the same time.

Licenses

- A (server-based) license is required to use the WebNavigator server. This is a graduated license based on the number of simultaneous Web access operations and can be incremented at any time
- We distinguish between Monitor and Operate clients for licensing purposes
- Flexible number of clients thanks to additive licenses (floating client)
- The WinCC/WebUX and WinCC/WebNavigator licenses can be combined, if necessary
- The WinCC server version and version of the mobile clients do not have to be the same
- One free Monitor client in the WinCC system

Operating systems and hardware requirements

SIMATIC WinCC

The system requirements differ depending on the type of the WinCC installation and the used operating system. We strongly recommend to use 64 Bit operating systems. The 32 Bit operating systems may be used for compatibility reasons within already existing configurations.

In conjunction with an Embedded SIMATIC IPC system Windows Embedded Standard 7 may be used when mentioned in the requirement tables below.

Single-User-System Standalone

Operating systems	
Windows 7 Professional/Enterprise/Ultimate SP 1 (32 Bit)	
Windows 7 Professional/Enterprise/Ultimate SP 1 (64 Bit)	
Windows Embedded Standard 7 SP1 (32 Bit) (only SIMATIC IPC)	
Windows Embedded Standard 7 SP1 (64 Bit) (only SIMATIC IPC)	
Windows 8.1 Professional/Enterprise (32 Bit)	
Windows 8.1 Professional/Enterprise (64 Bit)	
Windows 10 (64 BIT)	
Windows Server 2008 Standard Edition R2 SP1 (64 Bit)	
Windows Server 2012 Standard Edition R2 (64 Bit)	
Recommended Hardware with 32 Bit OS	
Processor	Intel® Core™ i3 3.5 GHz*
RAM	3 GB
Recommended Hardware with 64 Bit OS	
Processor	Intel® Core™ i3 3.5 GHz*
RAM	8 GB

* In combination with options, more powerful systems may be required

Multi-User-System Server*

Operating systems	
Windows 7 Professional/Enterprise/Ultimate SP 1 (32 Bit)**	
Windows 7 Professional/Enterprise/Ultimate SP 1 (64 Bit)**	
Windows 8.1 Professional/Enterprise (32 Bit)**	
Windows 8.1 Professional/Enterprise (64 Bit)**	
Windows 10 (64 BIT)**	
Windows Server 2008 Standard Edition R2 SP1 (64 Bit)	
Windows Server 2012 Standard Edition R2 (64 Bit)	
Recommended Hardware with 32 Bit OS	
Processor	Intel® Core™ i5 2.4 GHz***
RAM	3 GB
Recommended Hardware with 64 Bit OS	
Processor	Intel® Core™ i5 2.4 GHz***
RAM	8 GB

* All servers in a multi-user-system have to use the same edition of the Operating system.

** When using a Workstation operating system a maximum of 3 clients can connect to the server

*** In combination with options, more powerful systems may be required

Multi-User-System Client

Operating systems	
Windows 7 Professional/Enterprise/Ultimate SP 1 (32 Bit)	
Windows 7 Professional/Enterprise/Ultimate SP 1 (64 Bit)	
Windows 8.1 Professional/Enterprise (32 Bit)	
Windows 8.1 Professional/Enterprise (64 Bit)	
Windows 10 (64 BIT)	
Windows Server 2008 Standard Edition R2 SP1 (64 Bit)	
Windows Server 2012 Standard Edition R2 (64 Bit)	
Recommended Hardware with 32 Bit OS	
Processor	Intel® Core™ i3 3.5 GHz*
RAM	3 GB
Recommended Hardware with 64 Bit OS	
Processor	Intel® Core™ i3 3.5 GHz*
RAM	8 GB

* In combination with options, more powerful systems may be required

Multi-User-System Client without project

Operating systems	
Windows 7 Professional/Enterprise/Ultimate SP 1 (32 Bit)	
Windows 7 Professional/Enterprise/Ultimate SP 1 (64 Bit)	
Windows Embedded Standard 7 SP1 (32 Bit) (only SIMATIC IPC)	
Windows Embedded Standard 7 SP1 (64 Bit) (only SIMATIC IPC)	
Windows 8.1 Professional/Enterprise (32 Bit)	
Windows 8.1 Professional/Enterprise (64 Bit)	
Windows 10 (64 BIT)	
Windows Server 2008 Standard Edition R2 SP1 (64 Bit)	
Windows Server 2012 Standard Edition R2 (64 Bit)	
Recommended Hardware with 32 Bit OS	
Processor	Intel® Core™ i3 3.0 GHz*
RAM	3 GB
Recommended Hardware with 64 Bit OS	
Processor	Intel® Core™ i3 3.0 GHz*
RAM	4 GB

* In combination with options, more powerful systems may be required

System options Web Server

Operating systems	
Windows 7 Professional/Enterprise/Ultimate SP 1 (32 Bit)	
Windows 7 Professional/Enterprise/Ultimate SP 1 (64 Bit)	
Windows 8.1 Professional/Enterprise (32 Bit)	
Windows 8.1 Professional/Enterprise (64 Bit)	
Windows 10 (64 BIT)	
Windows Server 2008 Standard Edition R2 SP1 (64 Bit)	
Windows Server 2012 Standard Edition R2 (64 Bit)	
Recommended Hardware with 32 Bit OS	
Processor	Intel® Core™ i5 2.4 GHz*
RAM	3 GB
Recommended Hardware with 64 Bit OS	
Processor	Intel® Core™ i5 2.4 GHz*
RAM	8 GB

* In combination with options, more powerful systems may be required

System Options Web Client

Operating systems	
Windows 7 Professional/Enterprise/Ultimate SP 1 (32 Bit)	
Windows 7 Professional/Enterprise/Ultimate SP 1 (64 Bit)	
Windows Embedded Standard 7 SP1 (32 Bit) (only SIMATIC IPC)	
Windows Embedded Standard 7 SP1 (64 Bit) (only SIMATIC IPC)	
Windows 8.1 Professional/Enterprise (32 Bit)	
Windows 8.1 Professional/Enterprise (64 Bit)	
Windows 10 (64 BIT)	
Windows Server 2008 Standard Edition R2 SP1 (64 Bit)	
Windows Server 2012 Standard Edition R2 (64 Bit)	
Recommended Hardware with 32 Bit OS	
Processor	Intel® Dual Core™ AMD Athlon 64*
RAM	3 GB
Recommended Hardware with 64 Bit OS	
Processor	Intel® Dual Core™ AMD Athlon 64*
RAM	4 GB

In combination with options, more powerful systems may be required

Central Archive Server based on SIMATIC Process Historian

Operating system

Windows Server 2012 R2 (64-Bit)

Hardware requirements

Depending on the requirements concerning quantity frameworks the recommended hardware configuration for a central archive solution based on SIMATIC Information Server differs.

We have listed three example configurations (small, medium and large quantity frameworks) in the system manual for the administration of SIMATIC Process Historian.

- System Manual

[↗ More information](#)

Virtualization

The following virtualization systems have been tested

- Microsoft Hyper-V 2012 R2
- VM Ware ESXi 5.5

Prerequisite

The performance of the virtual machine has to meet the requirements of a WinCC client system.



Find out more:

[siemens.com/wincc-V7](https://www.siemens.com/wincc-V7)

**Learn everything about
SIMATIC WinCC**

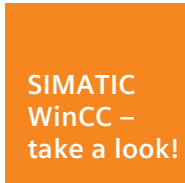

Follow us on:

twitter.com/siemensindustry

youtube.com/siemens

Published by
Siemens AG 2016

Digital Factory
Factory Automation
P.O.Box 48 48
90026 Nuremberg, Germany

Article NO.: DFFA-I10077-00-7600
iPDF

Subject to changes and errors.

The information given in this document only contains general descriptions and/or performance features which may not always specifically reflect those described, or which may undergo modification in the course of further development of the products. The requested performance features are binding only when they are expressly agreed upon in the concluded contract.





