

## YK-X Series

Product Lineup

YK-TW	Orbit type
YK-XG/YK-X	Completely beltless model <sup>Note</sup>
YK-XE	Low cost high performance model
YK-XGS	Wall mount/inverse model
YK-XGP	Dust-proof & drip-proof model

Note. Except for YK1200X

# SCARA ROBOTS

Arm length of 120 mm to 1200 mm, full-selection of lineup is top in the world. Completely beltless structure pursues the features of SCARA robots to their utmost limits.



Low cost high performance model  
YK400XE-4

### History of 40 years

The first YAMAHA robots were SCARA robots. Since the first SCARA robot called "CAME" was produced in 1979, some 40 years of SCARA robot innovations have continually appeared. These SCARA robots have undergone countless modifications in an ever changing marketplace and amassed a hefty record of successful products making them an essential part of the YAMAHA robot lineup.



1979  
<YK7000>

# Comprehensive line of YAMAHA SCARA robots

## Orbit type

P.494

- Arm length 350 mm / 500 mm
- Maximum payload 5 kg



## Low cost high performance model

P.507

- Arm length 400 mm to 710 mm
- Maximum payload 4 kg to 10 kg



## Extra small type

P.498

- Arm length 120 mm to 220 mm
- Maximum payload 1 kg

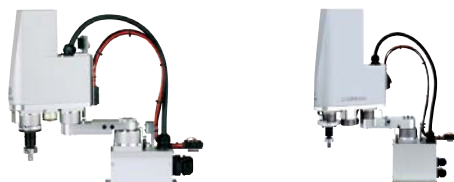

## Large type

P.519

- Arm length 700 mm to 1200 mm
- Maximum payload 10 kg to 50 kg

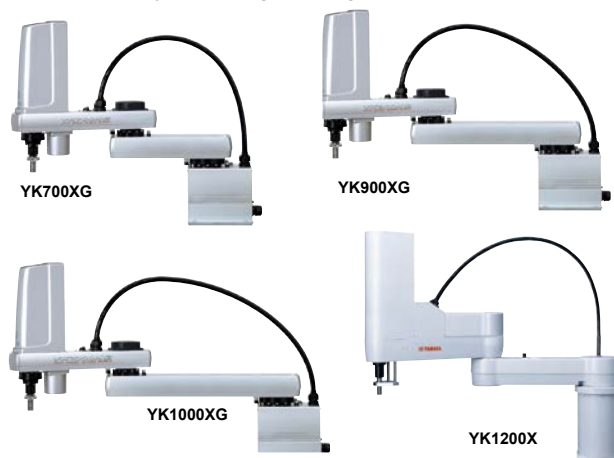

## Small type

P.503

- Arm length 250 mm to 400 mm
- Maximum payload 5 kg



## Wall mount/inverse model

P.526

YK300XGS to YK1000XGS



- Wall mount type  
Type where the robot body is installed in the wall.
- Inverse type  
Type where the wall mount type is installed upside down.

## Medium type

P.510

- Arm length 500 mm to 600 mm
- Maximum payload 5 kg to 20 kg

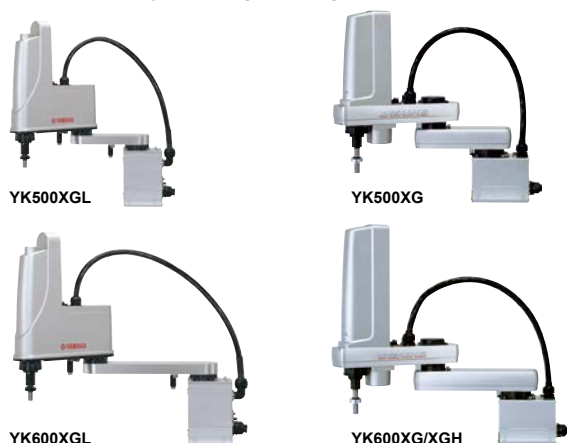

## Dust-proof & drip-proof model

P.536



Plays active part in the working environment with a large amount of water or dust (protection class equivalent to IP65).

- Please consult YAMAHA for anti-droplet protection for fluids other than water.

## YK-TW Orbit type

### YK-TW POINT 1

#### Layout design freedom

**User: We want a smaller equipment footprint.**

**YK-TW can move anywhere through the full  $\phi$  1000 mm <sup>Note 2</sup> work envelope.**

Featuring a ceiling-mount configuration with a wide arm rotation angle, the YK-TW can access any point within the full  $\phi$  1000 mm downward range. This eliminates all motion-related restrictions with regard to pallet and conveyor placement operations, while dramatically reducing the equipment footprint.

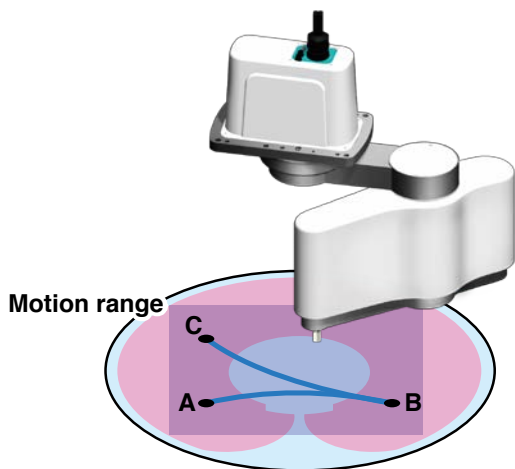

Orbit type SCARA robot

Standard type SCARA robot

### YK-TW POINT 2

#### Higher productivity

**User: We need to reduce cycle time.**

**Standard cycle time of 0.29 secs. <sup>Note 2</sup>**

Y-axis (arm 2) passes beneath the X-axis (arm 1) and it has a horizontal articulated structure, allowing it to move along the optimal path between points. Moreover, the optimized weight balance of the internal components reduces the cycle time by 36 % as compared to previous models.

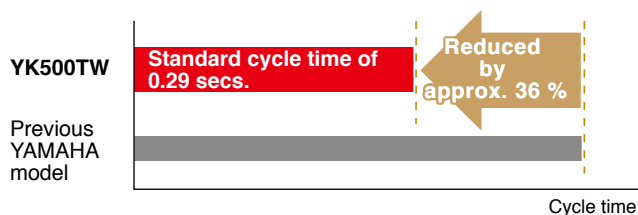

The standard cycle time for moving a 1-kg load horizontally 300 mm and up/down 25 mm is shortened by approximately 36 % compared to existing YAMAHA models.

### YK-TW POINT 3

#### High quality

**User: We want a high precision assembly system.**

**YK-TW offers a repeated positioning accuracy of  $\pm 0.01$  mm <sup>Note 1</sup> (XY axes).**

Higher repeated positioning accuracy than that offered by a parallel-link robot. This was accomplished by optimizing the robot's weight balance through an extensive re-design of its internal construction. The lightweight yet highly rigid arm has also been fitted with optimally tuned motors to enable high accuracy positioning.

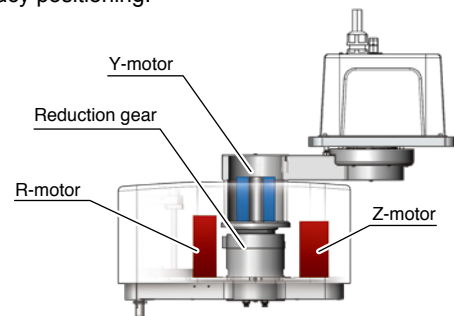

#### Hollow construction

Y-motor and reduction gear feature a hollow construction which allows them to be housed inside the harness arm.

**360° Rotation.**

#### Optimized rotation center of gravity moment

Weight balance was optimized by placing the R-motor and Z-motor at the left and right sides respectively.

**Reduced inertia enables high-speed motion.**

### YK-TW POINT 4

#### Suitable for a wide range of applications

**User: We need to move heavy workpieces at high speeds.**

**YK-TW handles payloads up to 5 kg.**

Handles loads up to 5 kg. Also accommodates arm-end tools which tend to be heavy, making it highly adaptable to various applications.

### YK-TW POINT 5

#### Smaller equipment footprint

**User: We want to reduce the height of our equipment.**

**YK-TW offers both a lower height and a smaller footprint.**

YK-TW height is only 392 mm. This compact size enables more freedom in the equipment layout design.

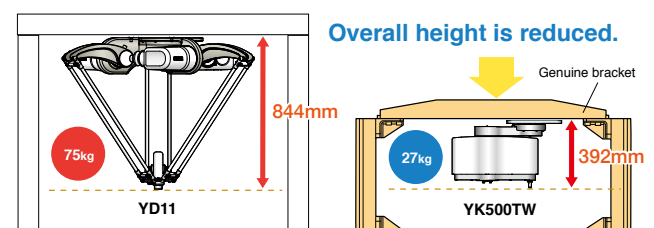

Note 1. Applies to the YK350TW Note 2. Applies to the YK500TW

## YK-TW POINT 6

### Easy installation

User: Parallel-link robots require large frames which complicates installation...

YK-TW has a total height of only 392 mm, and weighs only 27 kg.

Lower inertia = Lighter frame



## YK-TW POINT 7

### Reduce the number of steps

User: Preparing the frame is extra work.

We can optionally provide a dedicated frame for the YK-TW.

With no need for complex calculations of strength, startup steps can be reduced.

Note. For details on dimensions and price, please contact Yamaha.

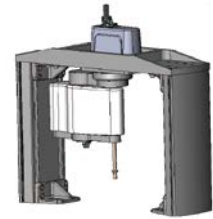

## YK-TW POINT 8

### Ideal for narrow space applications

User: We need to install in limited space, such as between equipment.

Minimum installation width 492mm <sup>Note 1</sup>

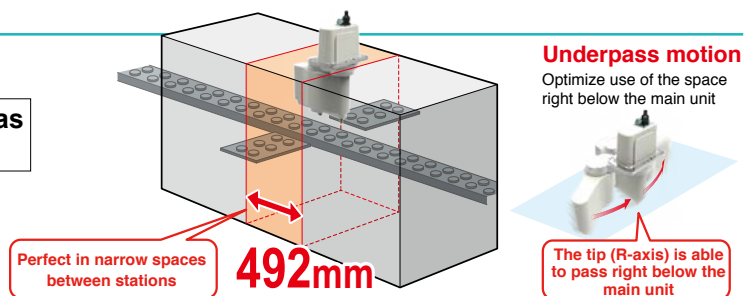

## YK-XG Completely beltless type

### Integral structure designed for optimal operation

Note. The following shows an example of YK500XG.

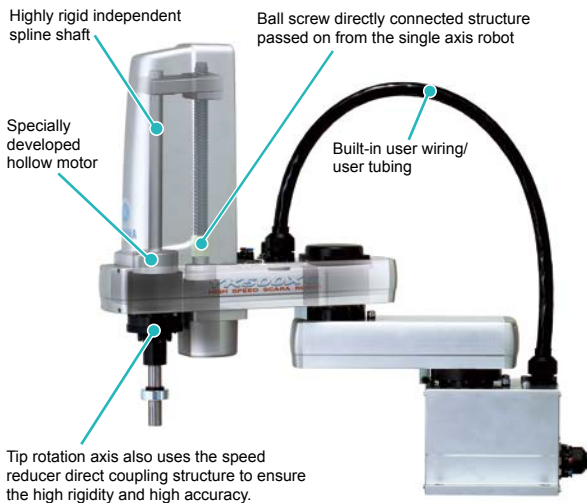

## YK-XG POINT 1

### Completely beltless structure

A completely beltless structure was achieved using a ZR-axis direct coupling structure. This completely beltless structure greatly reduces waste motion. This structure also maintains high accuracy for an extended period of time. Additionally, this structure ensures maintenance-free operation for an extended period of time without worrying about belt breakage, elongation, or secular deterioration (except for Orbit type and large type).

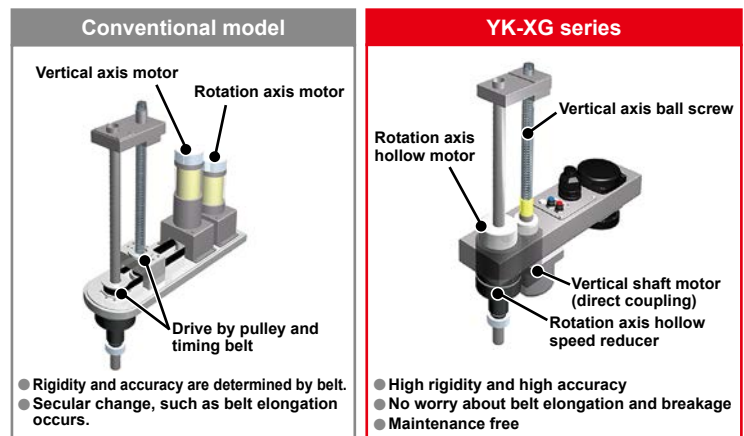

## YK-XG POINT 2

### High speed

The standard cycle time is fast. Additionally, YAMAHA also places special emphasis on the tact time in the practical working area. The speed reduction ratio or maximum motor RPM was reviewed to greatly improve the maximum speed. This contributes to improvement of the tact time.

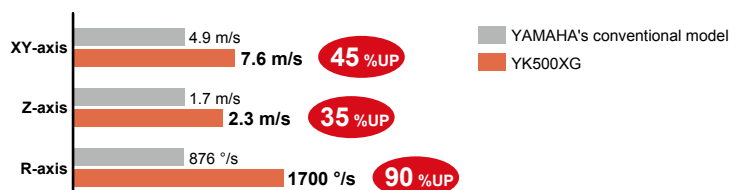

YK-XG POINT 3

Resolver is used for position detector.

As the resolver uses a simple and rigid structure without using electronic components and optical elements, it features high environment resistance and low failure ratio. Detection problems due to electronic component breakdown, dew condensation on or oil sticking to the disk that may occur in optical encoders do not occur in the resolver due to its structure. Additionally, as the absolute specifications and incremental specifications use the same mechanical specifications and common controller, the specifications can be changed only by setting parameters. Furthermore, even when the absolute battery is consumed completely, the robot can still operate as the incremental specifications. So, even if a trouble occurs, the line stop is not needed to ensure the safe production line. The backup circuit has been completely renovated and now has a backup period of one year in the non-energizing state.

Note. The resolver has a simple structure without using electronic components. So, the resolver is highly resistant to low and high temperatures, impacts, electrical noise, dust particles, and oil, etc., and is used in automobiles, trains, and aircrafts that particularly require the reliability.

**Optical encoder**



- Optical type
- Electronic components are required and structure is complicated.
- Electronic component malfunction, or dew condensation on or oily content sticking to disk may occur easily.

▼

**Detection failure**

**Resolver**



- Magnetic type
- Simple structure only with iron core and winding has less potential failure factors.
- Immune to shock and electric noise.

▼

**High reliability**

YK-XG POINT 4

Excellent maintenance ability

The covers of YAMAHA SCARA robot YK-XG series can be removed forward or upward. The cover is separated from the cable, so the maintenance work is easy. Additionally, the grease replacement of the speed reducer needs many steps to disassemble the gear and may cause positional deviation. However, since the speed reducer of the YAMAHA SCARA robot uses long-life grease, the grease replacement is not needed.

YK-XG POINT 5

Surprising R-axis tolerable moment of inertia

The SCARA robot performance cannot be expressed only by the standard cycle time. In actual operating environments, there are various workpieces, such as heavy workpiece or workpiece with large offset. At this time, since the robot with low R-axis tolerable moment of inertia needs to decrease the speed during operation, the cycle time decreases greatly. All YAMAHA SCARA robot YK-XG types have the tip rotation axis directly coupled to the speed reducer. Since the R-axis tolerable moment of inertia is very high when compared to a general structure in which the moment of inertia is transmitted by a belt after decelerating, the robot can operate at a high speed even with workpieces that have been offset.

**YK120XG**  
(R-axis tolerable moment of inertia: 0.1 kgfcm<sup>2</sup>)

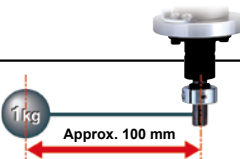

When the tip load weight is 1 kg, it is possible to operate at approx. 100 mm offset.

R-axis tolerable moment of inertia: Comparison between YK120XG and other company's model

When the offset from the R-axis to the center of gravity of the load is large, the inertia becomes large and the acceleration during operation is restricted. The R-axis tolerable moment of inertia of YAMAHA XG series is exceedingly large when compared to other company's SCARA robots in the similar class, so it can operate at a high speed even in the offset state.

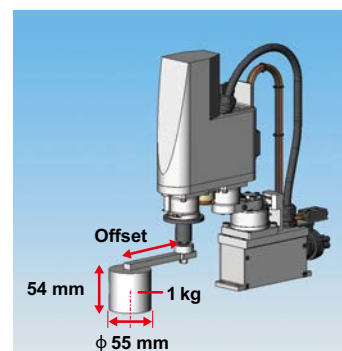

When the load weight is 1 kg (refer to the right in the figure.)

Offset (mm)	Inertia (kgfcm <sup>2</sup> )	Operation	
		YK120XG	Company A
0	0.0039	○	○
45	0.025	○	×
97	0.1	○	×

○: Operable    ×: Out of catalog value tolerance range

◆ R-axis tolerable moment of inertia: YK120XG..... 0.1 kgfcm<sup>2</sup>

Company A..... 0.0039 kgfcm<sup>2</sup>

## YK-XG POINT 6

### Compact

As the cable layout is changed, the cable height becomes lower than the main body cover. Additionally, use of extruded material base and motor with low overall height achieves the lowest overall height in the same class.

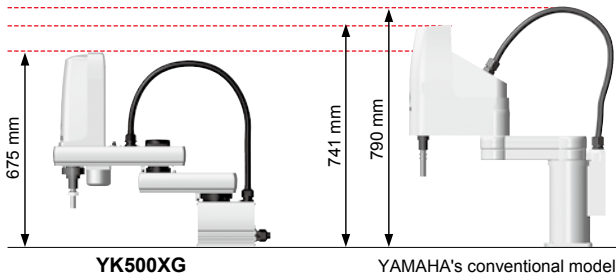

## YK-XG POINT 7

### Hollow shaft and tool flange options are selectable.

Hollow shaft that allows easy wiring to the tip tool and tool flange for tool mounting are provided as options.



Hollow shaft option convenient for routing of air tubes and harness wires

Note. YK250XG to YK400XG  
YK500XGL/YK600XGL



Tool flange option for easy mounting of a tool to the tip

Note. YK250XG to YK1000XG

## YK-XG POINT 8

### Zone control (= Optimal acceleration/deceleration automatic setting) function

In the SCARA robot, the load applied to the motor and speed reducer in the arm folded state greatly differs from that in the arm extended state. YAMAHA SCARA robot **automatically selects** optimal acceleration and deceleration from the arm postures at operation start and operation end. Therefore, the robot does not exceed the tolerance value of **the motor peak torque** or **speed reducer allowable peak torque** only by entering the initial payload. So, full power can be extracted from the motor whenever needed and high acceleration/ deceleration are maintained.

#### For X-axis of YK500XG

The torque in the arm folded state is 5 or more times different from that in the arm extended state.

**This may greatly affect the service life, vibration during operation, and controllability.**

If the motor torque exceeds the peak value

→ **This may adversely affect the controllability and mechanical vibration, etc.**

If the torque exceeds the tolerable peak torque value of the speed reducer

→ **This may cause early breakage or shorten the service life extremely.**

**Robot stops at a desired position accurately to ensure long service life.**

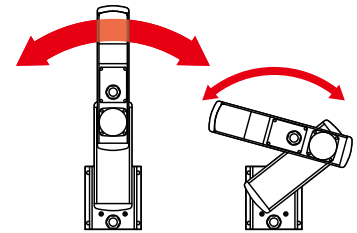

## YK-XE Low cost high performance model

### YK-XE POINT 1

#### Both the high operation performance and low-price are provided.

Both the high operation performance and low-price are provided.  
Production equipment with high cost performance can be constructed.



**YK400XE-4** Note 1

Note 1. YK400XE-4-S-150-3L-RCX340-4-N-NS-4



**YK510XE-10** Note 2

Note 2. YK510XE-10-200-3L-RCX340-4-N-NS-4



**YK610XE-10** Note 3

Note 3. YK610XE-10-200-3L-RCX340-4-N-NS-4



**YK710XE-10** Note 4

Note 4. YK710XE-10-200-3L-RCX340-4-N-NS-4

### YK-XE POINT 2

#### Improved User Interface

Enhanced size and numbers of air tubes and user I/O for end effectors.

Tubes and wires are positioned for easy layout and reduced risk of disconnection.

(YK510XE-10, YK610XE-10, YK710XE-10)

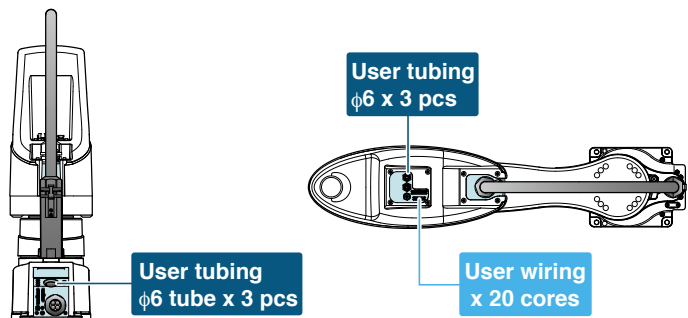

Note. YK400XE-4 provides the user wiring x 10 cores and the User tubing  $\phi 4$  x 3 pcs.

### YK-XE POINT 3

#### Option specifications

#### Through-shaft and through-cap have been added.

"Through-shaft" or "through-cap" option for wiring and tubing that is convenient to run the air tubing and wiring can be selected. The wiring and tubing routes can be investigated easily without designing and manufacturing a stay for installing the wiring and tubing. In addition, by passing the wiring and tubing through the inside of the main body, worries about wire breakage or disconnection are reduced during operation. (Only through-shaft is available in YK400XE-4.)



### YK-XE POINT 4

#### Option specifications

#### Brake release switch is selectable.

In the emergency stop state, the Z-axis brake is released and the Z-axis can be moved up or down while the brake release switch is held down. Releasing the switch applies the brake to the Z-axis. This improves the convenience during installation adjustment.

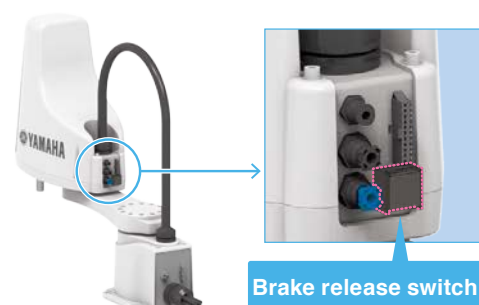

### Drop-In upgrade by common platform design

The installation position of the YK400XE-4 is fully compatible with that of the conventional model YK400XR. This ensures easy replacement work.

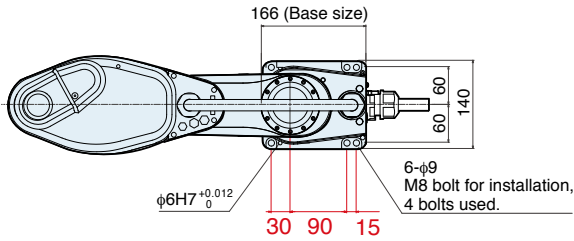

Previous YAMAHA model YK400XR

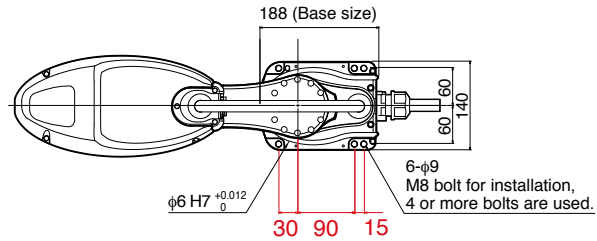

YK400XE-4

### YK-XGS Wall mount/inverse model

#### Hanging type is renewed. Completely beltless structure and high rigidity

As the conventional hanging type is changed to the wall mount type, the flexibility of the system design is improved. The production equipment can be downsized. Additionally, as an inverse type that allows upward operation is also added to the product lineup, the flexibility of the working direction is widened. Furthermore, use of a completely beltless structure achieves a maximum payload of 20 kg and a R-axis tolerable moment of inertia of 1 kgm<sup>2</sup>Note that are the top in the class. A large hand can also be installed. So, this robot is suitable for heavy load work.

Note. YK700XGS to YK1000XGS



### YK-XGP Dust-proof & drip-proof model

#### Up/down bellows structure improves the dust-proof and drip-proof performance.

The dust-proof and drip-proof type that can be operated even in a work environment where water or particle dust scatters was renewed to a completely beltless structure. The belt does not deteriorate and poor environment resistance is improved. Additionally, an up/down bellows structure is used to improve the dust-proof and drip-proof performance.

Note. YK250XGP to YK600XGLP



#### Protection class equivalent to IP65 (IEC60529)

Seals are added to the joints to maintain the dust-proof and drip-proof performance without air purging. The robot conforms to the protection class equivalent to IP65 (IEC60529).

**IP 65** — Class of protection against invasion of water: 5  
 Water injected from any direction does not affect adversely.  
 The standard pressure of the injected water is 30 KPa (30 KN/m<sup>2</sup>, 0.3 kgf/cm).  
 The injection speed is 12.5 liters/min. and the injection time is 3 min.  
 Note. The water injected under conditions exceeding those shown above may enter the unit.

— Class of protection against solid objects: 6  
 No invasion of particle dust.

#### Dust-proof and drip-proof connector for user wiring is provided as standard.



YK250XGP to 600XGLP (arm part)



YK250XGP to 600XGLP (base part)



Model/Type	Model	Arm length (mm)	Maximum payload (kg)	Standard cycle time (sec.) <sup>Note 1</sup>	Page	
Orbit type	YK350TW	350	5.0	0.32	P.494	
	YK500TW	500	5.0 (4.0) <sup>Note 3</sup>	0.29	P.496	
Standard	Extra small type	YK120XG	120	1.0	0.33	P.498
		YK150XG	150	1.0	0.33	P.499
		YK180XG	180	1.0	0.33	P.500
		YK180X	180	1.0	0.39	P.501
		YK220X	220	1.0	0.42	P.502
		Small type	YK250XG	250	5.0 (4.0) <sup>Note 3</sup>	0.43
	YK350XG		350	5.0 (4.0) <sup>Note 3</sup>	0.44	P.505
	YK400XE-4		400	4.0 (3.0) <sup>Note 3</sup>	0.41	P.507
	YK400XG		400	5.0 (4.0) <sup>Note 3</sup>	0.45	P.508
	Medium type	YK500XGL	500	5.0 (4.0) <sup>Note 3</sup>	0.48	P.510
		YK500XG	500	10.0	0.42	P.512
		YK510XE-10	510	10.0 (9.0) <sup>Note 3</sup>	0.38	P.513
		YK600XGL	600	5.0 (4.0) <sup>Note 3</sup>	0.54	P.514
		YK600XG	600	10.0	0.43	P.516
		YK610XE-10	610	10.0 (9.0) <sup>Note 3</sup>	0.39	P.517
		YK600XGH	600	20.0 (19.0) <sup>Note 3</sup>	0.47	P.518
	Large type	YK700XGL	700	10.0 (9.0) <sup>Note 3</sup>	0.50	P.519
		YK710XE-10	710	10.0 (9.0) <sup>Note 3</sup>	0.42	P.520
		YK700XG	700	20.0 (19.0) <sup>Note 3</sup>	0.42	P.521
		YK800XG	800	20.0 (19.0) <sup>Note 3</sup>	0.48	P.522
YK900XG		900	20.0 (19.0) <sup>Note 3</sup>	0.49	P.523	
YK1000XG		1000	20.0 (19.0) <sup>Note 3</sup>	0.49	P.524	
Wall mount/inverse model	YK1200X	1200	50.0	0.91	P.525	
	YK300XGS <sup>Note 2</sup>	300	5.0 (4.0) <sup>Note 3</sup>	0.49	P.526	
	YK400XGS <sup>Note 2</sup>	400	5.0 (4.0) <sup>Note 3</sup>	0.49	P.528	
	YK500XGS	500	10.0	0.45	P.530	
	YK600XGS	600	10.0	0.46	P.531	
	YK700XGS	700	20.0	0.42	P.532	
	YK800XGS	800	20.0	0.48	P.533	
	YK900XGS	900	20.0	0.49	P.534	
Dust-proof & drip-proof model	YK1000XGS	1000	20.0	0.49	P.535	
	YK250XGP	250	4.0	0.50	P.536	
	YK350XGP	350	4.0	0.52	P.538	
	YK400XGP	400	4.0	0.50	P.540	
	YK500XGLP	500	4.0	0.66	P.542	
	YK500XGP	500	10.0	0.55	P.544	
	YK600XGLP	600	4.0	0.71	P.545	
	YK600XGP	600	10.0	0.56	P.547	
	YK600XGHP	600	18.0	0.57	P.548	
	YK700XGP	700	20.0	0.52	P.549	
	YK800XGP	800	20.0	0.58	P.550	
	YK900XGP	900	20.0	0.59	P.551	
YK1000XGP	1000	20.0	0.59	P.552		

Note 1. The standard cycle time is measured under the following conditions.

- During back and forth movement 25mm vertically and 100mm horizontally (extra small type)
- During back and forth movement 25mm vertically and 300mm horizontally (small type / medium type / large type)

Note 2 The YK300XGS and YK400XGS are custom-order products. For details about the delivery time, please contact YAMAHA.

Note 3. For the option specifications (tool flange mount type and user wiring/tubing through spline type), the maximum payload becomes the value in ( ).