

 SCHOLASTIC



SUPPORTS  
NEXT GENERATION  
SCIENCE STANDARDS

# STEM LESSON PLAN



TEACHING GUIDE

UNIT 1: **AERODYNAMICS**

UNIT 2: **ENERGY** **NEW!**

# Dear Teacher,

## Science is all around us!

STEM is serious business on a NASCAR racetrack, where racecars can reach speeds of more than 200 miles per hour! The **NASCAR Acceleration Nation** program brings STEM skills alive in the classroom with two units full of fun, hands-on experiments that teach students in grades 5–7 about key scientific principles.

- **UNIT 1—Aerodynamics:** Three interactive lessons about the key aerodynamic principles of **drag, downforce, and drafting**
- **UNIT 2—Energy:** Three engaging lessons that demonstrate how **potential energy, kinetic energy,** and **friction** influence the world around us

Ready to teach your students all about the science of speed? Buckle up, and let's go!



### CONTENTS

#### THREE Ds OF SPEED

Learning Outcomes.....	<b>1</b>
Pre-Assessment.....	<b>2</b>

#### LESSON 1: DRAG

Drag Lesson Plan.....	<b>3</b>
Assembly Sheet A.....	<b>4</b>
Drag Activity Sheet.....	<b>5</b>
Resource Sheet A.....	<b>6</b>
Resource Sheet B.....	<b>7</b>

#### LESSON 2: DOWNFORCE

Downforce Lesson Plan.....	<b>8</b>
Assembly Sheet B.....	<b>9</b>
Downforce Activity Sheet.....	<b>10</b>
Resource Sheet C.....	<b>11</b>

#### LESSON 3: DRAFTING

Drafting Lesson Plan.....	<b>12</b>
Drafting Activity Sheet.....	<b>13</b>
Post-Assessment.....	<b>14</b>
Core Concepts and Skills Spotlight .....	<b>15</b>

#### ENERGY OF NASCAR

Learning Outcomes.....	<b>16</b>
Pre-Assessment.....	<b>17</b>

#### LESSON 1: POTENTIAL ENERGY

Potential Energy Lesson Plan.....	<b>18</b>
Potential Energy Activity Sheet A.....	<b>19</b>
Potential Energy Activity Sheet B.....	<b>20</b>

#### LESSON 2: KINETIC ENERGY

Kinetic Energy Lesson Plan.....	<b>21</b>
Kinetic Energy Activity Sheet.....	<b>22</b>

#### LESSON 3: FRICTION AND ENERGY

Friction and Energy Lesson Plan.....	<b>23</b>
Friction and Energy Activity Sheet....	<b>24</b>
Post-Assessment.....	<b>25</b>
Core Concepts and Skills Spotlight .....	<b>back cover</b>

Visit [scholastic.com/nascarspeed](http://scholastic.com/nascarspeed) for digital versions of these **NASCAR Acceleration Nation** classroom materials.

# UNIT 1

## THREE DS OF SPEED

**DRAG • DOWNFORCE • DRAFTING**

### ★ **NASCAR THREE DS OF SPEED LEARNING OUTCOMES** ★

#### **LESSON 1: DRAG START YOUR ENGINES**

At the end of Lesson 1, students will be able to:

1. Define the science of aerodynamics
2. Explain how drag influences moving objects
3. Identify elements of a racecar that create drag

#### **LESSON 2: DOWNFORCE UNDER PRESSURE**

At the end of Lesson 2, students will be able to:

1. Explain how air pressure influences moving objects
2. Identify how the speed of air determines the amount of pressure moving air exerts
3. Determine which combinations of air pressure create downforce and lift

#### **LESSON 3: DRAFTING GAME CHANGER**

At the end of Lesson 3, students will be able to:

1. Define the strategy of drafting
2. Explain how aerodynamics principles help drafting cars move faster

**BEFORE YOU BEGIN:** Have students complete the pre-assessment.

**PRE-ASSESSMENT ANSWER KEY:** 1. C; 2. B; 3. A; 4. C; 5. A; 6. A; 7. A; 8. B; 9. E; 10. D



NAME: \_\_\_\_\_

# ***DO YOU KNOW THE SCIENCE OF SPEED?***

**This unit is about aerodynamics and how it influences force, momentum, and speed.**

Share what you know about the science of speed.

**1** What does the science of aerodynamics study?

- A** The weight of objects
- B** The speed and flight of objects
- C** The movement of air
- D** The sound of air

**2** What are three key aerodynamics principles?

- A** Drag, height, and acceleration
- B** Drag, downforce, and drafting
- C** Acceleration, downforce, and motion
- D** Acceleration, height, and motion

**3** What word describes a force that slows an object when air pushes against it?

- A** Drag                      **C** Drafting
- B** Downforce              **D** Deceleration

**4** What aerodynamics force is used to create both lift and downforce?

- A** Air speed              **C** Both A and B
- B** Air pressure          **D** Neither A nor B

**5** True or false? Downforce is caused by the combination of high air pressure pushing against the top of an object and low air pressure beneath an object.

- A** True                      **B** False

**6** True or false? Downforce is the opposite of lift.

- A** True                      **B** False

**7** True or false? Drafting is a driving strategy that improves speed.

- A** True                      **B** False

**8** Drafting happens when:

- A** Two or more racecars accelerate next to each other with inches between them.
- B** Two or more racecars line up, one behind the other, with inches between them.
- C** Two or more racecars tap the bumpers of the cars in front of them.
- D** None of the above

**9** The goal of adaptations to NASCAR racecars is:

- A** To prevent racecars from flipping over or lifting.
- B** To provide more downforce to improve tire traction.
- C** To force high-pressure air over the car to make sure it “sticks” to the track.
- D** To create more contact between the tires and the tracks.
- E** All of the above

**10** Why is the science of aerodynamics important to racing?

- A** Aerodynamics helps improve the safety of the racecars, keeping them on the track.
- B** Aerodynamics enhances the speed of the racecars, helping drivers zoom past the competition.
- C** Aerodynamics helps improve the performance of the cars, keeping them running smoothly and consistently.
- D** All of the above

# LESSON PLAN 1: DRAG

## START YOUR ENGINES

**TIME REQUIRED:** 1½ hours, plus time for optional extension activity

**MATERIALS:** Recycled or reused paper (2 sheets), racecar templates (1 per student), card stock (1 sheet per student), scissors, tape, markers, round hard candies with a hole in the middle (4 per student), index cards (1 per student), ruler, plastic straw (1 per student) *Note: Test that the straws fit in the holes of the candies before the lesson. After the Drag activity, save the leftover piece of straw and the card stock for Lesson 2.*

**ACTIVITY AND RESOURCE SHEETS:** Assembly Sheet A, Drag Activity Sheet, Resource Sheet A, Resource Sheet B.

Download additional sheets as needed at [scholastic.com/nascarspeed](http://scholastic.com/nascarspeed).

**VIDEOS:** View the *Start Your Engines* and *What Is Drag?* videos at [scholastic.com/nascarspeed](http://scholastic.com/nascarspeed).

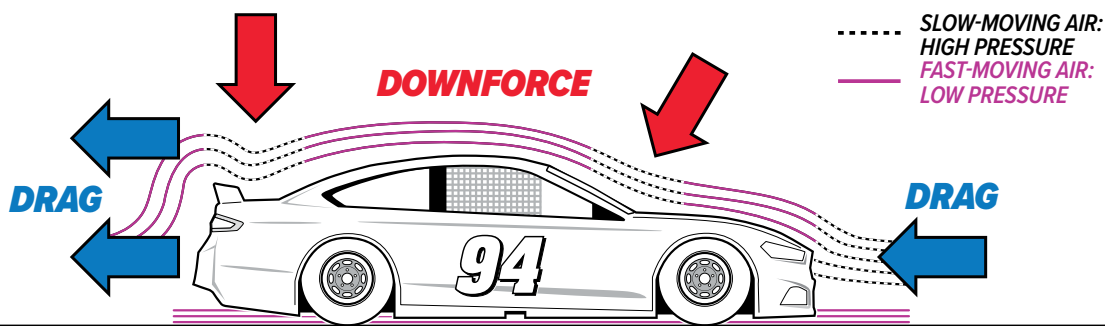

**Central question:**  
*What is the science of aerodynamics?*

Introduce **aerodynamics**—the study of the movement of air, specifically how it flows around objects such as cars and airplanes. Explain that NASCAR engineers study aerodynamics to improve the speed and safety of racecars.

#### Video Connection

Complete the unit introduction by showing students the *Start Your Engines* video at [scholastic.com/nascarspeed](http://scholastic.com/nascarspeed).



**Central question:**  
*How does the science of aerodynamics work?*

1. Call on three volunteers. Have one student drop a flat sheet of paper from about three feet up, while another times how long it takes to hit the floor.
2. Have the third volunteer crumple the paper into a ball and repeat the experiment. Ask students to explain what happened. Note that the object's shape affected how it moved through the air. The flat sheet of paper met resistance and moved slowly. Crumpling the paper into a ball reduced its surface area and caused it to drop more quickly to the ground.

3. Explain that aerodynamics doesn't apply only to objects. Ask students if they can think of sports in which people might bend to give their bodies less surface area or spread their bodies to make more surface area. You may show images of downhill skiers and speed skaters (smaller surface area); skydivers and hang gliders (larger surface area). Ask: *Why might speed be desired in some sports and moving more slowly be desired in others?*



**Central question:**  
*What is drag?*

1. Point out that NASCAR engineers not only make cars superfast—they also make them safer. Explain that **drag**, or air resistance, is a force that occurs when air pushes against an object as it moves, slowing it down.

#### Video Connection

Show students the *What Is Drag?* video at [scholastic.com/nascarspeed](http://scholastic.com/nascarspeed).

2. Pair students into pit crews of two. Hand out the car templates, *Assembly Sheet A*, and the *Drag Activity Sheet*. Have students assemble the cars and complete the experiment. Emphasize that the candies are only to be used as wheels and should not be eaten. You can print out more car templates as

needed using the template provided at [scholastic.com/nascarspeed](http://scholastic.com/nascarspeed).

3. Hand out *Resource Sheet A* to support groups in answering the Conclusion questions. To wrap up, explain that, much like the index card in the experiment, the spoilers on NASCAR racecars create drag to slow them down and make them safer to operate.



**Central question:**  
*How does a racecar's design make it more aerodynamic?*

#### PIT CREW CHALLENGE (OPTIONAL)

1. Give each group a copy of *Resource Sheet B*. Instruct students to read the introduction, then mark three areas where air moves slowly around the car with an "H" for high pressure; and mark three areas where air moves quickly around the car with an "L" for low pressure.

#### ANSWER KEY:

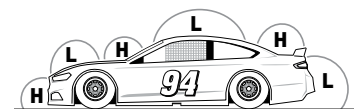

2. To wrap up, challenge each group to write an explanation of how one of the features labeled on *Resource Sheet A* increases or decreases drag.

# BUILD A RACECAR

## GATHER YOUR MATERIALS:

Car template, plastic straw, scissors, ruler, four round candies with holes in their centers, tape, markers



**BEFORE YOU BEGIN:** Color or personalize your racecar.

### STEP 1:

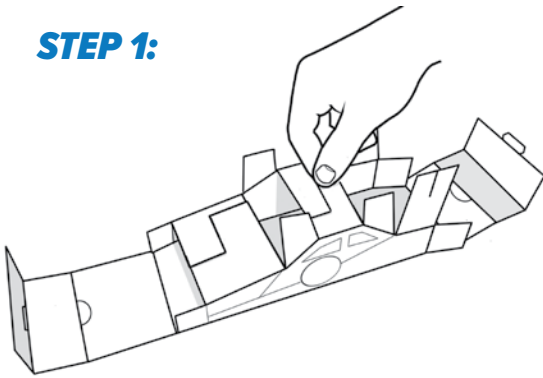

Flip the car over. Fold up the sides and connect the tabs using the split ends.

### STEP 2:

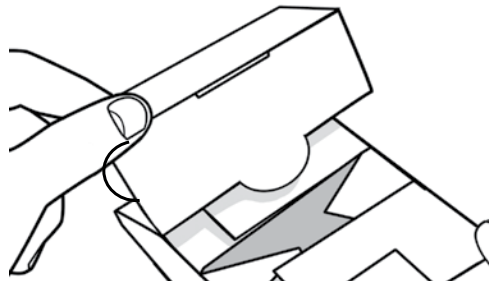

Fold up the front and the back of the car to cover all the tabs. Secure the hood and trunk by tucking the semicircles into the front and back openings.

### STEP 3:

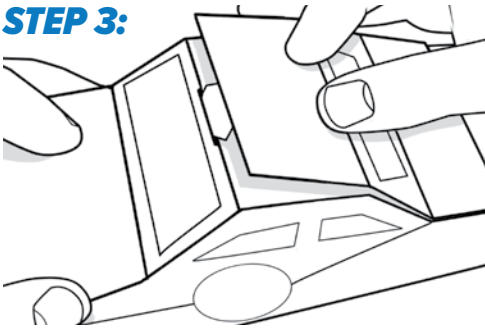

Connect the front and back of the car by sliding the top tab into the top slot. Reinforce the roof of your car with tape.

### STEP 4:

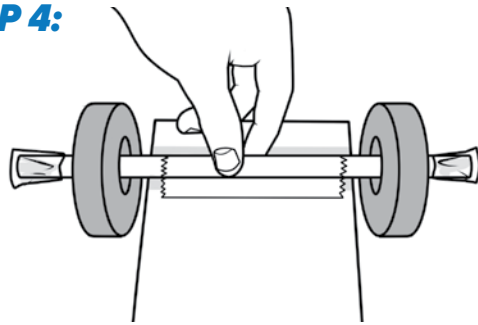

Cut two 3-inch pieces from the plastic straw. *(Note: Save the final piece of straw for the Lesson 2 experiment.)* Flip the car over and tape the straw pieces along the guidelines on the bottom of the car.

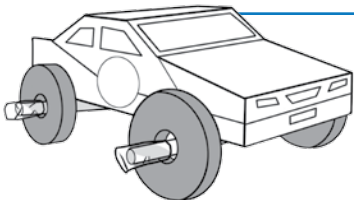

## COMPLETE YOUR CAR:

Thread a candy over each straw end. Fold a small piece of tape over the end of each straw to keep the candies in place. *(Note: The tape shouldn't prevent the candies from spinning.)* **Now your car is ready to roll.**

NAME \_\_\_\_\_

# START YOUR ENGINES

## What limits how fast a racecar can go?

One factor is **drag**—a slowing force created when air pushes against an object. Try this activity to test how drag affects motion.

### PROCEDURE:

- 1 Fold up both edges of a sheet of card stock. Lift one end of the card stock onto a stack of books to form a ramp.
- 2 Place your car at the top of your ramp so that it rolls forward. Measure the distance it travels. Repeat for a second test run. Record both results.
- 3 Tape an index card to the back of your car so that it sticks up above the car's roof. Repeat Step 2 again for two more test runs. Record the results of both runs.

## GATHER YOUR MATERIALS:

Completed car, ruler, tape, index card, card stock



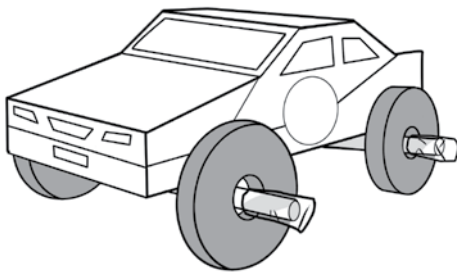

**DISTANCE TRAVELED  
RACECAR WITHOUT INDEX CARD**

Test Run 1	Test Run 2

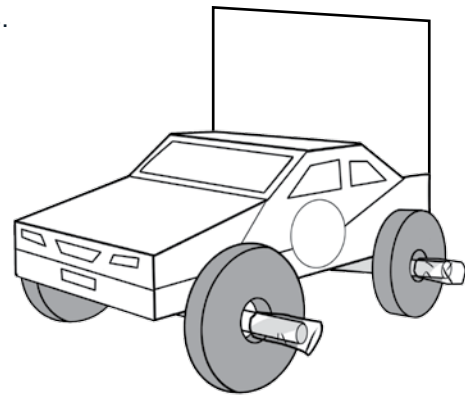

**DISTANCE TRAVELED  
RACECAR WITH INDEX CARD**

Test Run 1	Test Run 2

### CONCLUSIONS:

Answer these questions on a separate sheet of paper.

- 1 Which car went farther? Explain why you think this happened.
- 2 How did adding the index card affect the car's drag?
- 3 Why might NASCAR engineers modify racecars to create the type of drag your racecar experienced? Look at the *Racecar Adaptations* sheet for clues.

# RESOURCE SHEET A

# RACECAR ADAPTATIONS

Each racing season, NASCAR sets rules that determine the shape and weight of its cars. Check out some NASCAR racecar features and learn how they influence safety, speed, and racing aerodynamics.

1

## SPOILER

This device traps high-pressure air, creating downforce to provide more rear-tire traction. It also increases drag to prevent racecars from traveling at unsafe speeds.

2

## ROOF STRIPS

These thin rails run along the roof edges to disrupt airflow and cut down on unwanted lift.

3

## ROOF FLAPS

These spring open if the car starts to slide or spin. They disturb air moving over the car, reducing lift so the car doesn't go airborne.

4

## SKIRTING

Edging around the bottom of the car prevents high-pressure air from moving under the vehicle and creating unwanted lift. If the car starts to slide sideways, the skirting lessens the chance of the car rolling over or flying off the track.

5

## TIRES

Treadless tires make more contact with the ground, increasing traction.

6

## SPLITTER

This flat strip runs parallel to the ground underneath the front bumper. Air accelerates more quickly under the splitter, leading to a low-pressure area that helps suck the car downward toward the track.

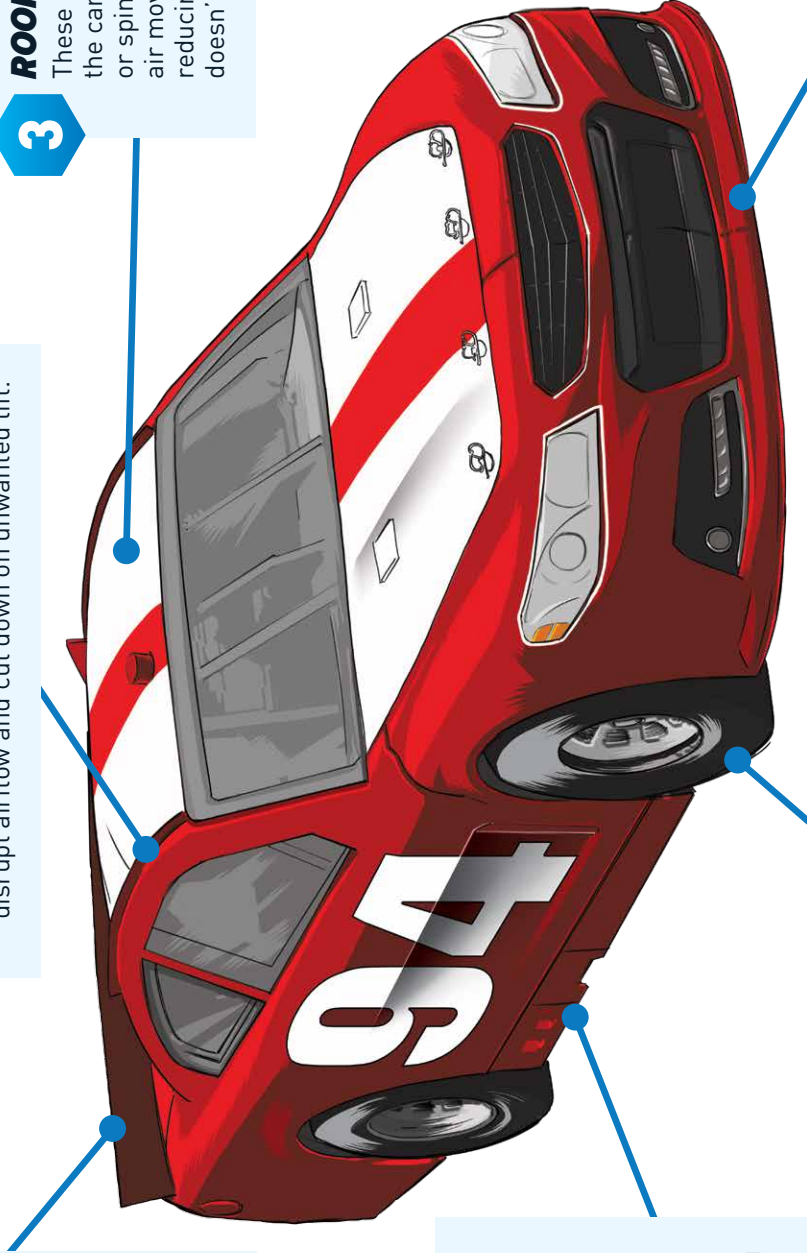



RESOURCE SHEET B

# RACECAR AIRFLOW

The way air flows around a NASCAR racecar determines how much pressure the car is under. Pressure is measured by PSI, which means pounds per square inch. Areas that allow the air to flow quickly experience low pressure. Areas where the air gets trapped and flows slowly experience high pressure.

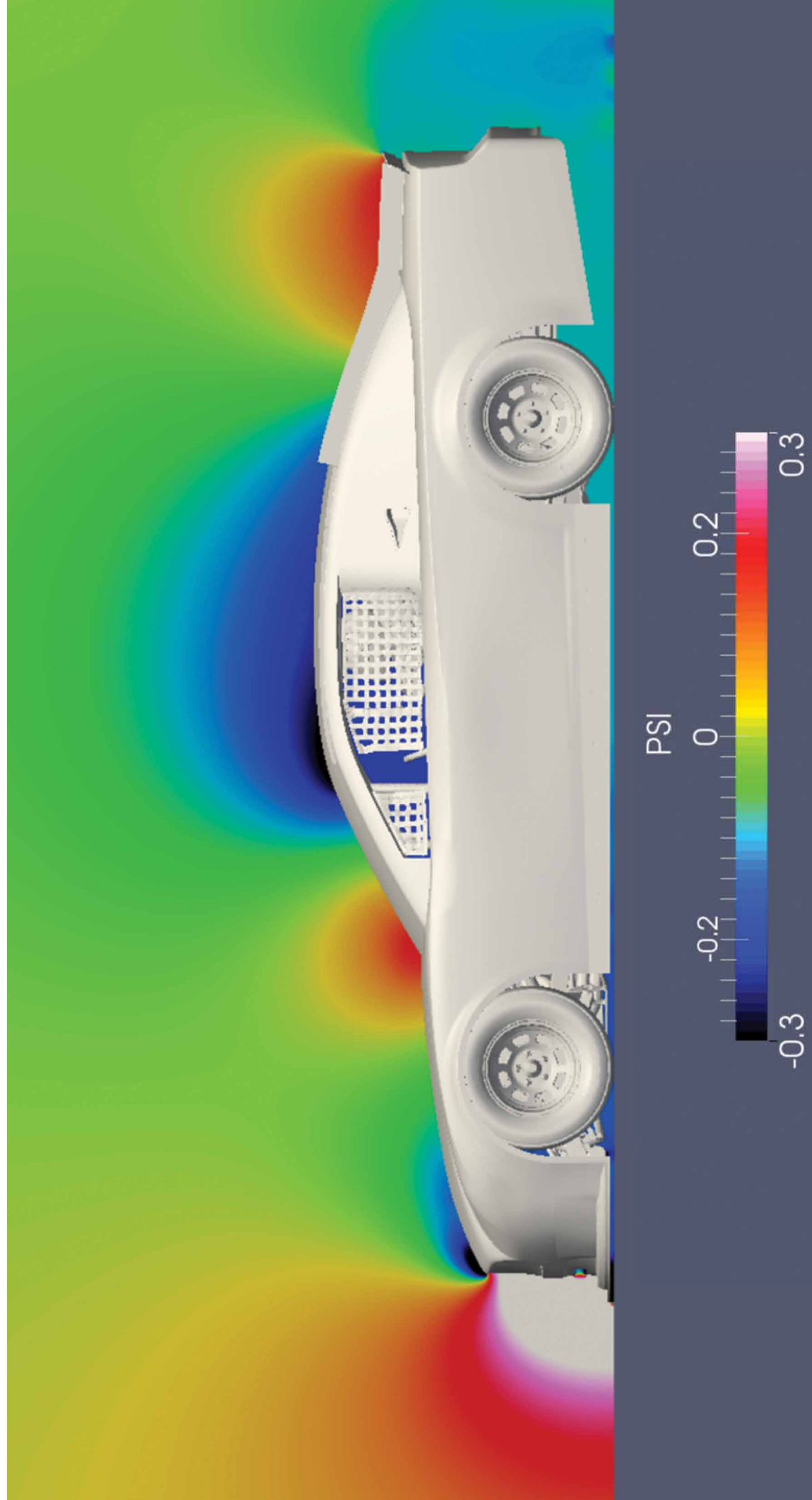

Use the color bar above to identify the areas of the car that experience the highest pressure and the lowest pressure.

# LESSON PLAN 2: DOWNFORCE UNDER PRESSURE

**TIME REQUIRED:** 45 minutes, plus optional extension activity

**MATERIALS:** Recycled or reused paper (1 sheet per student), straws (1 per student), spools (1 per student), index cards (1 per student), card stock (1 sheet per student), rulers, scissors, pencils, markers, completed cars. *Note: Students will need one whole straw, plus the piece of straw left over from Lesson 1. Students will reuse the card stock from Lesson 1.*

**ACTIVITY AND RESOURCE SHEETS:** Assembly Sheet B, Downforce Activity Sheet, Resource Sheet A, Resource Sheet C (optional). [Download additional sheets as needed at scholastic.com/nascarspeed.](http://scholastic.com/nascarspeed)



**Central question:**  
*How are the aerodynamics of racing and flight similar?*

1. Explain that because NASCAR racecars can reach speeds of more than 200 miles per hour, they rely on air pressure and special racecar adaptations to stick to the track. Air pressure—a key element of aerodynamics—is a force caused by the weight of air molecules pushing against an object's surface.
2. Fast-moving air causes low air pressure, and slow-moving air creates high air pressure. **Downforce** is created when high pressure pushes down on an object from above and there is low pressure below. **Lift**—the opposite of downforce—is created when there is low pressure above an object and high pressure below.
3. Downforce pushes NASCAR racecars downward so they stay on the track. Lift pushes the wings of airplanes upward so that the planes fly.



**Central question:**  
*How does air pressure cause an object to rise or fall?*

1. To demonstrate how air pressure works, have each student hold the short end of a sheet of paper with his or her hands pointing up. The paper should curve down over the back of his or her hands. Tell the students to blow forcefully over the curve of the paper. What happens? (*Faster-moving air over the top of the paper creates lower pressure above in contrast to higher pressure below. That creates lift, causing the paper to rise.*)

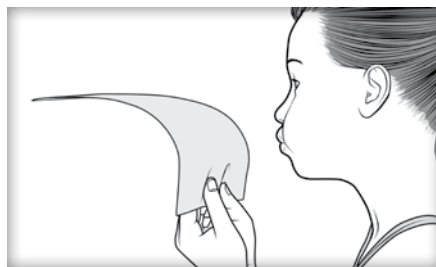

2. Next, have students fold 1-inch flaps along the two shorter edges of the paper. Have them turn the paper over and fold two more 1-inch flaps along those same edges. Finally, have them sit the paper on a tabletop so that there is a gap between the paper and the table. Ask them to blow forcefully through the gap. What happens? (*Faster-moving air below the paper creates an area of low pressure. The high pressure above pushes downward, creating downforce and causing the paper to sag.*)

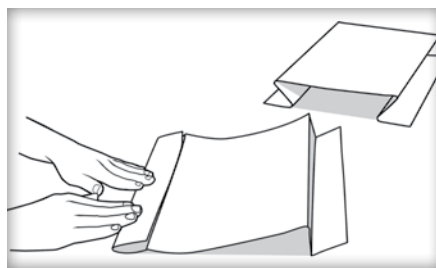

**Central question:**  
*What is the relationship between air speed and air pressure?*

1. Pass out *Assembly Sheet B*, the *Downforce Activity Sheet*, and experiment materials. Have pit crews complete the experiment. If students have trouble, make sure the straws

are not taped at an angle and the top of the spool is completely covered.

2. After groups complete the Conclusion questions, challenge them to think of other objects that rely on lift or downforce to operate. (*Answers: Experiment: fast/low; slow/high; low/fast; high/slow; low/high/lift. Racecar: slow/high; fast/low; high/slow; low/fast; high/low/downforce.*)



**Central question:**  
*How do racecar modifications influence downforce on the vehicle?*

## **PIT CREW CHALLENGE (OPTIONAL)**

1. Pass out copies of *Resource Sheet A*. Point out the racecar's splitter and skirting. Explain that these adaptations enhance the car's downforce by directing fast-moving air underneath it (splitter) and preventing slow-moving air from slipping underneath its sides (skirting).
2. Pass out card stock, scissors, and the completed cars from Lesson 1. Have pit crews use *Resource Sheet A* to guide them in adding spoilers, splitters, and other features to their cars. After they have adapted their racecars, ask students to write two or three paragraphs explaining:
  - how the speed of airflow creates air pressure, drag, and downforce
  - how a racecar's spoiler increases drag and creates downforce
  - how a racecar's splitter and skirting help keep the car on the track

You may choose to share *Resource Sheet C* with students for a visual illustration of where racecars experience air pressure.

# PRESSURE-TEST SPOOL

## GATHER YOUR MATERIALS:

Spool, plastic straw, scissors, ruler, index card, tape, hole punch



### STEP 1:

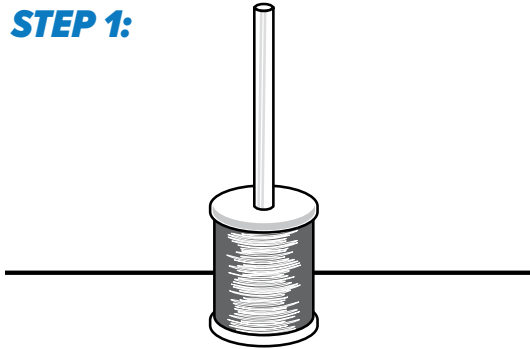

Place the spool on a flat surface and insert the leftover straw from the racecar experiments into the center hole. Tape the straw to the top of the spool. Make sure that any openings on the top of the spool are completely covered.

### STEP 2:

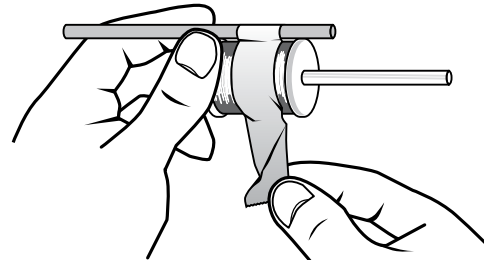

Cut a straw in half. Hold the spool sideways. Align one half of the straw to the side of the spool and tape it in place so that the straw sticks out from the bottom of the spool.

### STEP 3:

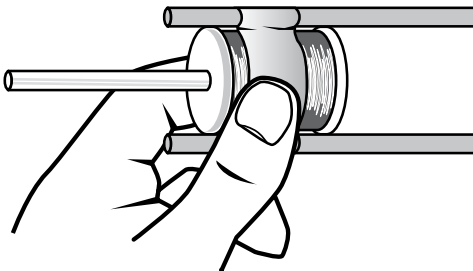

Flip the spool over and tape the second straw in place.

### STEP 4:

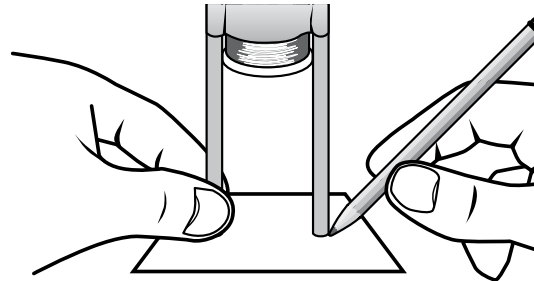

Cut a 2-inch-by-2-inch square from the index card. Stand the spool over the cut card and trace the shape of the straws on the card.

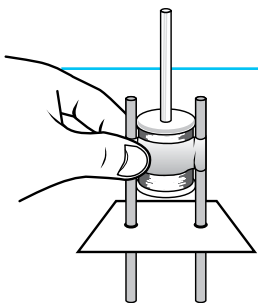

## COMPLETE YOUR PRESSURE TESTER:

Punch two holes in the card where you have marked them. The holes must be larger than the straws to allow the card to easily slide down the straws when you're not holding it in place. Thread the paper onto the straws. Make the holes larger as needed.  
**Your pressure-test spool is now complete!**

NAME \_\_\_\_\_

# UNDER PRESSURE

## How do NASCAR racecars stay on the track?

Racecars are designed to force air to flow faster underneath them than over the top. The low pressure below the car sucks it down toward the track. At the same time, high air pressure pushes down on the car from above. Try this experiment to demonstrate how air pressure shifts can cause an object to stick to a surface.

**GATHER YOUR MATERIALS:**  
Completed pressure-test spool with index card

### PROCEDURE:

- 1 Thread the index card on the straws and hold it against the bottom of the spool.
- 2 Blow strongly through the straw and let go of the card. How long can you keep the card suspended?

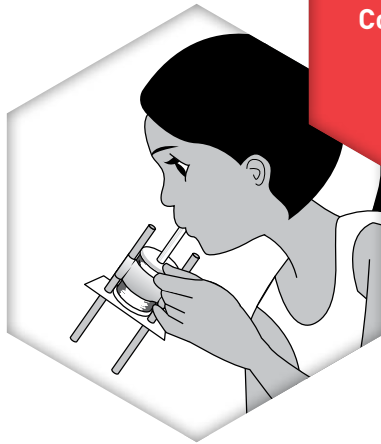

### CONCLUSIONS:

**Lift or downforce?** Fill in the blanks below to explain how fast- and slow-moving air create low and high air pressure, which lead to lift or downforce on an object.

#### EXPERIMENT

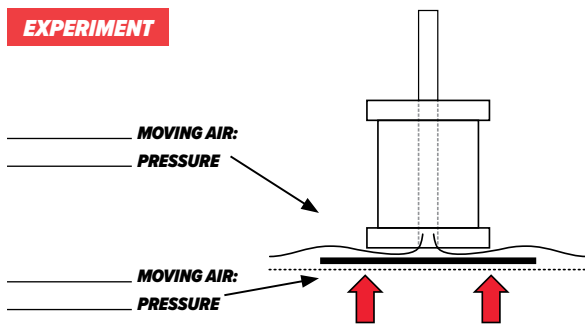

The \_\_\_\_\_ air pressure above the card was caused by \_\_\_\_\_ moving air. The \_\_\_\_\_ air pressure below the card was caused by \_\_\_\_\_ moving air. The combination of \_\_\_\_\_ air pressure above and \_\_\_\_\_ air pressure below creates \_\_\_\_\_.

#### RACECAR

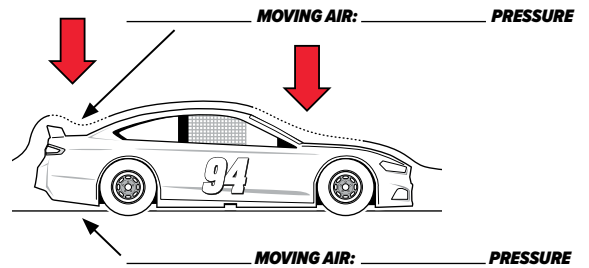

The \_\_\_\_\_ air pressure pushing downward above the front and back of the car is caused by \_\_\_\_\_ moving air. The \_\_\_\_\_ air pressure below the car is caused by \_\_\_\_\_ moving air. The combination of \_\_\_\_\_ air pressure above and \_\_\_\_\_ air pressure below creates \_\_\_\_\_.



RESOURCE SHEET C

# A FOCUS ON AIR PRESSURE

Take a look at the image below to discover exactly where a NASCAR racecar experiences pressure. The areas of high PSI are the areas of the racecar that receive the most downforce. As the higher amounts of pounds per square inch push down on the racecar, it experiences more traction and sticks to the track.

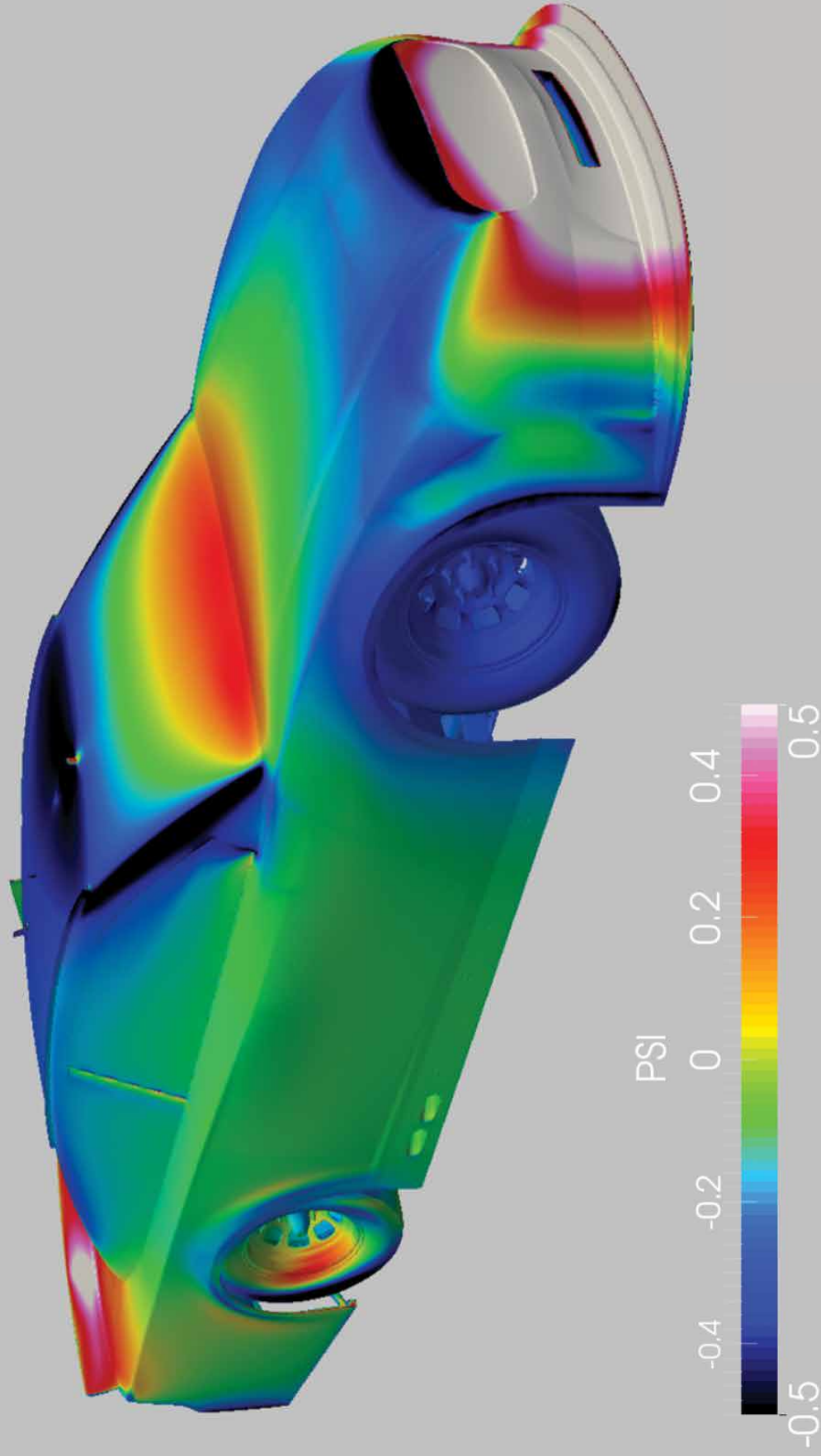

# LESSON PLAN 3: DRAFTING

## GAME CHANGER

**TIME REQUIRED:** 40 minutes

**MATERIALS:** Recycled or reused drawing paper, poster board or butcher paper, tape, scissors, markers

**ACTIVITY AND RESOURCE SHEETS:** Lesson Plan 3 (to project Drafting diagram), Drafting Activity Sheet, Resource Sheet A.

**Download additional sheets as needed at [scholastic.com/nascarspeed](http://scholastic.com/nascarspeed).**

**VIDEO:** View the *The Art of Drafting* video at [scholastic.com/nascarspeed](http://scholastic.com/nascarspeed).

### DRAFTING STAGE 1:

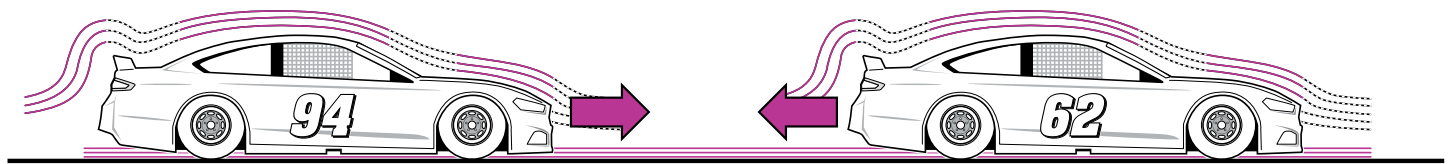

Low pressure between the cars pulls the trailing car forward

### DRAFTING STAGE 2:

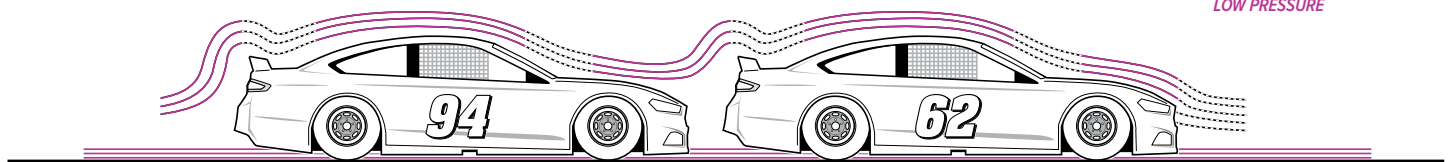

Both cars go faster



**Central question:**  
**What is drafting?**

- In addition to the NASCAR racecar adaptations we've discussed, drivers use a technique called **drafting** to gain a boost in speed on the track. Drafting is a driving strategy where racecars improve the performance of their vehicles by closely lining up one behind the other.

#### Video Connection

Show students the drafting video at: [scholastic.com/nascarspeed](http://scholastic.com/nascarspeed).

- Explain that the science behind drafting relies on **Bernoulli's principle**. When racecars draft, the leading car blocks the air, creating an area of low pressure behind it. The low pressure pulls the trailing car forward toward the leading car. This pushes the high-pressure air over the lead car's spoiler, reducing its drag. The result allows both

cars to go a few miles per hour faster. Project the above diagram to demonstrate the aerodynamics of drafting to students.

- Hand out the *Drafting Activity Sheet*, where students will read a passage about the history of drafting, followed by questions to assess their reading comprehension. (Answers: 1. C; 2. A; 3. D; 4. It looks like two or more cars trailing each other with just inches between them; 5. "The more cars that are grouped in a drafting formation, the faster they all will go.")



**Central question:**  
**How does drafting help cars travel faster?**

#### PIT CREW CHALLENGE

- Provide pit crews with poster board or butcher paper, tape, scissors, markers, and *Resource Sheet A*.

- Instruct them to draw and cut out racecars to make a poster that includes:
  - a racetrack with three or more racecars
  - examples of drag, downforce, and drafting
  - arrows that show how air pressure acts on racecars
  - labels demonstrating spoilers, splitters, and other adaptations

**AFTER THE UNIT:** Once you have finished all three lessons, have students complete the post-assessment and compare their responses to the pre-assessment.

**POST-ASSESSMENT ANSWER KEY:**  
1. B; 2. D; 3. A; 4. C; 5. B; 6. A; 7. B;  
8. B; 9. D; 10. A

NAME \_\_\_\_\_

# GAME CHANGER

**Winning a NASCAR race requires more than a super-speedy car.** Drivers also use a strategy called **drafting** to get ahead on the track. Read the passage below to learn about the technique's accidental discovery. Then answer the questions on the right.

## THE DISCOVERY OF DRAFTING



In 1960, racecar driver Junior Johnson was gearing up for the second ever Daytona 500 race. But he realized he had a problem. His car was much slower than those of the top contenders in the race.

During a practice run, Johnson noticed that when he pulled up close behind a faster car his vehicle sped up, too. By the final lap of his run, he'd built up enough speed to overtake the other car. Johnson had discovered drafting.

Drafting occurs when a car lines up right behind the car in front of it, with just inches between their bumpers. Leading cars block the flow of air, creating an area of low pressure behind them. This area acts like a vacuum, sucking the trailing cars forward. The trailing cars push high-pressure air over the leading cars' spoilers, reducing their drag and also giving them a boost. The more cars that are grouped in a drafting formation, the faster they all will go.

Using the drafting tactic, Johnson won the Daytona 500 even though his car wasn't the fastest on the track. Today, drafting is a common strategy in NASCAR races.

**1 What was the central idea of the text?**

- A** Drafting is a common strategy used in NASCAR races.
- B** Drafting was first used by accident.
- C** By driving close behind other cars, racecars can move faster.
- D** A car doesn't have to be the fastest to win a race.

**2 The purpose of the third paragraph is to:**

- A** Explain the science of how drafting works.
- B** Describe the first time that drafting was used in NASCAR.
- C** Detail how drafting has changed in the last 40 years.
- D** List the pros and cons of drafting.

**3 What is a synonym for the word *tactic*?**

- A** ability                      **C** idea
- B** formation                 **D** strategy

**4 Describe what a drafting formation looks like.**

---



---

**5 Which statement in the text supports the idea that multiple drivers can benefit from drafting?**

---



---

NAME: \_\_\_\_\_

## **WHAT DID YOU LEARN ABOUT THE SCIENCE OF SPEED?**

**You just completed a unit about aerodynamics and its influence on an object's speed.**  
Share what you have learned about aerodynamics.

**1 The science of aerodynamics studies:**

- A** How fast a car or plane can move.
- B** The movement of air.
- C** How objects can change the air.
- D** The weight of objects.

**2 What are three key aerodynamics principles?**

- A** Drag, distance, and downforce
- B** Drafting, distance, and drag
- C** Drag, downforce, and dynamics
- D** Drag, downforce, and drafting

**3 Drag occurs when:**

- A** Air pushes against an object.
- B** Air enters an object.
- C** Air avoids an object.
- D** None of the above

**4 Downforce is created when:**

- A** Fast-moving air moves above an object and slow-moving air moves below it.
- B** Low-pressure air moves above an object and high-pressure air moves below it.
- C** High-pressure air moves above an object and low-pressure air moves below it.
- D** None of the above

**5 True or false? Fast-moving air creates high air pressure.**

- A** True
- B** False

**6 True or false? When two cars draft, the area of low pressure behind the first car sucks the second car forward, causing it to move even faster.**

- A** True
- B** False

**7 True or false? Drafting is caused by aerodynamics adaptations to racecars.**

- A** True
- B** False

**8 The flaps on racecars that create drag:**

- A** Help the cars move faster.
- B** Slow the cars down to better control their speed.
- C** Help cars increase speed during drafting.
- D** All of the above

**9 Downforce is important to NASCAR racecars because:**

- A** It helps the cars move faster.
- B** It makes it safer to speed around turns.
- C** It helps cars "stick" to the track.
- D** All of the above

**10 In the world of NASCAR racing aerodynamics, engineers:**

- A** Create car adaptations that help improve the safety and speed of racecars.
- B** Design helmets that help the drivers focus better when driving.
- C** Invent car adaptations that make the cars heavier and safer.
- D** Develop adaptations that enhance the communication between the car and the driver.



# CORE CONCEPTS AND SKILLS SPOTLIGHT

## NEXT GENERATION SCIENCE STANDARDS

**Three Ds of Speed** covers overarching concepts and skills relevant to a range of science principles that can be easily applied to your state's science standards.

### DISCIPLINARY CORE IDEAS: PHYSICAL SCIENCE

#### Matter and Its Interactions

- ▶ A model showing that gases are made from matter particles that are too small to see and are moving freely around in space can explain many observations, including the inflation and shape of a balloon and the effects of air on larger particles or objects.

**Related Standard:**

Develop a model to describe that matter is made of particles too small to be seen.

#### Motion and Stability: Forces and Interactions

- ▶ The sum of an object is determined by the sum of the forces acting on it; if the total force on the object is not zero, its motion will change. For any given object a larger force causes a larger change in motion.

**Related Standard:**

Plan an investigation to provide evidence that the change in an object's motion depends on the sum of the forces on the object and the mass of the object.

### SCIENCE AND ENGINEERING PRACTICES

#### Planning and Carrying Out Investigations

- ▶ Conduct an investigation and/or evaluate and/or revise the experimental design to produce data to serve as the basis for evidence that meets the goals of the investigation.

#### Developing and Using Models

- ▶ Develop and/or use a model to predict and/or describe phenomena.

#### Constructing Explanations and Designing Solutions

- ▶ Construct an explanation using models or representations.

#### Engaging in Argument From Evidence

- ▶ Construct, use, and/or present an oral and written argument supported by empirical evidence and scientific reasoning to support or refute an explanation or a model for a phenomenon or a solution to a problem.

#### Obtaining, Evaluating, and Communicating Information

- ▶ Communicate scientific and/or technical information (e.g., about a proposed object, tool, process, system) in writing and/or through oral presentations.

Source: NGSS Lead States. 2013. *Next Generation Science Standards: For States, By States*. Washington, DC: The National Academies Press.



## UNIT 2

# ENERGY AND NASCAR

**POTENTIAL ENERGY • KINETIC ENERGY  
FRICTION & ENERGY**

### ★ **NASCAR ENERGY UNIT LEARNING OUTCOMES** ★

#### **LESSON 1: POTENTIAL ENERGY HIDDEN ENERGY**

At the end of Lesson 1, students will be able to:

1. Define potential energy.
2. List the four main types of potential energy.
3. Identify forces that influence potential energy.

#### **LESSON 2: KINETIC ENERGY ENERGY IN MOTION**

At the end of Lesson 2, students will be able to:

1. Define kinetic energy.
2. Identify forces that influence kinetic energy.
3. Describe the relationship between potential and kinetic energy.

#### **LESSON 3: FRICTION AND ENERGY A DYNAMIC DUO**

At the end of Lesson 3, students will be able to:

1. Define friction.
2. Describe the relationship between friction and speed.
3. Describe the relationship between friction and racecar safety.

**BEFORE YOU BEGIN:** Have students complete the pre-assessment. Save the pre-assessments until the end of the unit to measure the growth in student knowledge.

**PRE-ASSESSMENT ANSWER KEY:** 1. C; 2. B; 3. D; 4. B; 5. A; 6. A; 7. C; 8. D; 9. D; 10. D

NAME: \_\_\_\_\_

## **WHAT DO YOU KNOW ABOUT ENERGY?**

**This unit is all about energy.** Share what you know about how energy works.

**1 What is potential energy?**

- A** How fast an object can move
- B** The force that makes an object move
- C** The unused energy stored in an unmoving object
- D** All of the above

**2 The potential energy of a car at the top of a ramp is affected by:**

- A** The car's shape.
- B** The height of the ramp.
- C** The car's speed.
- D** The length of the ramp

**3 The force of gravity \_\_\_\_\_**

- A** pushes objects away from Earth.
- B** slows objects down.
- C** causes objects to be pulled in two different directions.
- D** pulls objects downward toward Earth.

**4 True or false? Two objects with the same mass sitting at different heights have the same potential energy.**

- A** True                      **B** False

**5 What is kinetic energy?**

- A** The energy of an object in motion
- B** The energy in machines
- C** The energy stored in unmoving objects
- D** None of the above

**6 True or false? You can influence an object's kinetic energy by changing its mass.**

- A** True                      **B** False

**7 What are two factors in kinetic energy?**

- A** Height and gravity
- B** Gravity and speed
- C** Speed and mass
- D** Mass and height

**8 What is friction?**

- A** An oppositional force
- B** The resistance that one surface experiences when moving over another
- C** The pull of gravity
- D** Both A and B
- E** None of the above

**9 What type of energy is created when two surfaces rub against each other?**

- A** Light
- B** Heat
- C** Sound
- D** All of the above

**10 Why are the rules of energy important to racing?**

- A** Because potential and kinetic energy help determine how quickly a racecar will go
- B** Because potential and kinetic energy help determine how much fuel a racecar will need to complete a race
- C** Because adjusting the factors that contribute to potential and kinetic energy can help a racecar go faster
- D** All of the above

# LESSON PLAN 1: POTENTIAL ENERGY

## HIDDEN ENERGY

**TIME REQUIRED:** 1 hour

**MATERIALS:** Small marble, large marble, Ping-Pong ball, golf ball, large pan, flour, yardstick

**ACTIVITY AND RESOURCE SHEETS:** Potential Energy Activity Sheets A and B



**Central question:**  
*What is potential energy?*

1. Introduce the concept of potential energy—energy that is stored due to an object’s position or condition. Explain that the word “potential” means having the ability to do something. Therefore, potential energy is energy that has not yet been used.
2. To illustrate the concept of potential energy, ask students to imagine a racecar sitting on the top of a steep banking. (See the Build section of Lesson 2: Kinetic Energy for a description of racetrack bankings.) Tell students that in this position the car is loaded with a specific type of potential energy, called **gravitational potential energy**. Explain that when an object, like a racecar, is far above the ground, a force called **gravity** pulls it downward toward Earth’s surface.



**Central question:**  
*What affects the amount of potential energy an object has?*

1. Explain that the potential energy of an object is measured by its ability to exert a specific amount of force for a particular distance. There are three factors that determine how much **gravitational potential energy** an object has: gravity, height, and mass. Gravity is constant, but differences in an object’s mass and height can increase or decrease the amount of potential energy the object has.
2. To demonstrate, set a small marble on the floor of your classroom. Ask students if the marble has potential energy in its current state. (No, because there’s no distance for gravity to pull it toward Earth.) Raise the marble about one foot in the air. Ask whether the ball now has any potential energy. (Yes.)

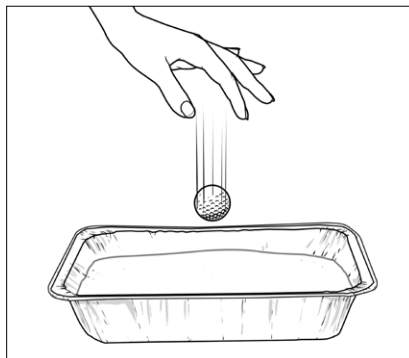

3. Drop the marble into a large pan filled with a few inches of flour. Gently remove it from the pan, and have a volunteer measure the width of the impact crater left in the flour. Climb on a chair and drop the marble from a height of about seven feet. Measure the new impact crater. Repeat the experiment with the large marble, the Ping-Pong ball, and the golf ball. Have students take notes throughout the experiment. After the demonstration is complete, ask them to draw conclusions about how mass and height impact the amount of potential energy an object has.



**Central question:**  
*What types of potential energy exist?*

1. Hand out *Potential Energy Activity Sheet A*. Tell students that gravitational potential energy is just one type of potential energy. Have them complete the activity to learn about three other forms.
2. Now that students understand potential energy’s different forms, have them imagine a racecar sitting in position on the starting grid before the start of a NASCAR race. Ask: *What forms of potential energy might the car have before it starts moving?*
3. Explain that cars use **electric potential energy** to operate. When a driver starts

the car, the battery releases a jolt of electricity to power parts inside the car. The fuel in the car’s gas tank holds **chemical potential energy**. When the fuel burns, it undergoes a chemical reaction that unleashes energy to power the car’s engine and propel the vehicle around the track. Batteries are unique because they hold energy in chemical form, but they release electric energy! (Fun fact: NASCAR racecars use Sunoco Green E15 as fuel. Just like a car, the human body relies on chemical potential energy stored in another type of fuel—food. By breaking down food, our bodies get the energy they need to survive.)

4. Describe how a racecar also has a suspension system between its wheels and its base. This system contains flexible springs that store **elastic potential energy**. This type of energy—also called mechanical energy—is energy stored in an object due to its tension. When the car hits a bump in the road, the springs absorb the impact by compressing. Then they stretch to release the stored energy, pushing the tire back against the road. This helps prevent the car’s wheels from losing their grip on the track.



**Central question:**  
*How do we identify the different types of potential energy around us?*

Divide students into groups, and hand out *Potential Energy Activity Sheet B*. Tell students to study the scenes on the sheet and search for examples of potential energy. See which group can identify the most objects with stored energy. Answers: **Chemical:** snacks in box in stands, gas, battery, racecar, blimp; **Gravitational:** tire raised, food raised overhead, man holding flag, man climbing ladder; **Electric:** lamppost, lights in the viewing boxes, television camera; **Elastic:** muscles, tires, air compressor.



NAME \_\_\_\_\_

# POTENTIAL ALL AROUND US

**DIRECTIONS:** Read about four types of potential energy in the chart below. Then write down as many examples of each that you can think of. One is already done for you.

**GRAVITATIONAL:** energy stored in an object due to its height.

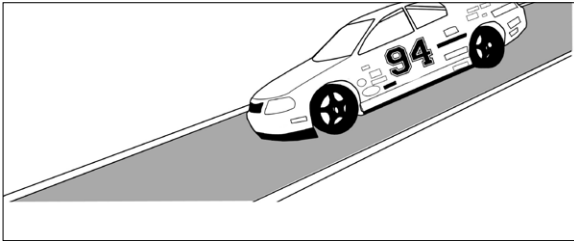

**UNITS OF MEASURE:** joules

**Examples:** a racecar coming off a bank,

\_\_\_\_\_

\_\_\_\_\_

\_\_\_\_\_

**CHEMICAL:** energy stored in chemicals.

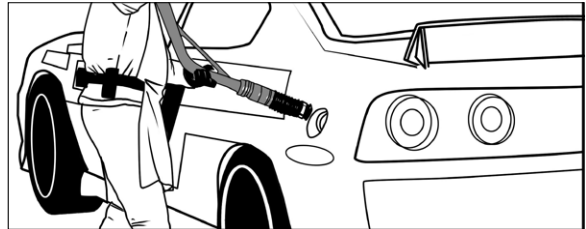

**UNITS OF MEASURE:** calories (food), joules, horsepower-hours (vehicles)

**Examples:** burning fuel inside a racecar's engine, \_\_\_\_\_

\_\_\_\_\_

\_\_\_\_\_

**ELASTIC:** energy stored in an object that can be stretched or squeezed.



**UNITS OF MEASURE:** joules

**Examples:** the springs that make up a racecar's suspension system, \_\_\_\_\_

\_\_\_\_\_

\_\_\_\_\_

\_\_\_\_\_

**ELECTRIC:** energy stored as electricity.

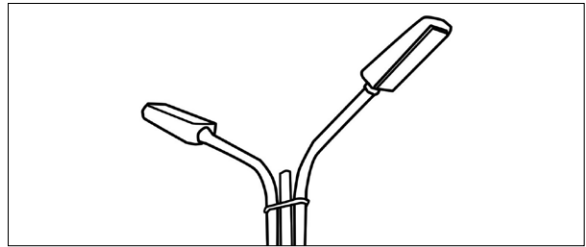

**UNITS OF MEASURE:** volts

**Examples:** the wires in a lamppost, \_\_\_\_\_

\_\_\_\_\_

\_\_\_\_\_

\_\_\_\_\_

# A DAY AT A NASCAR RACE

**DIRECTIONS:** A day at the racetrack is full of potential energy. Look at the scenes below on race day and find examples of the four main types of potential energy. How many examples can you find?

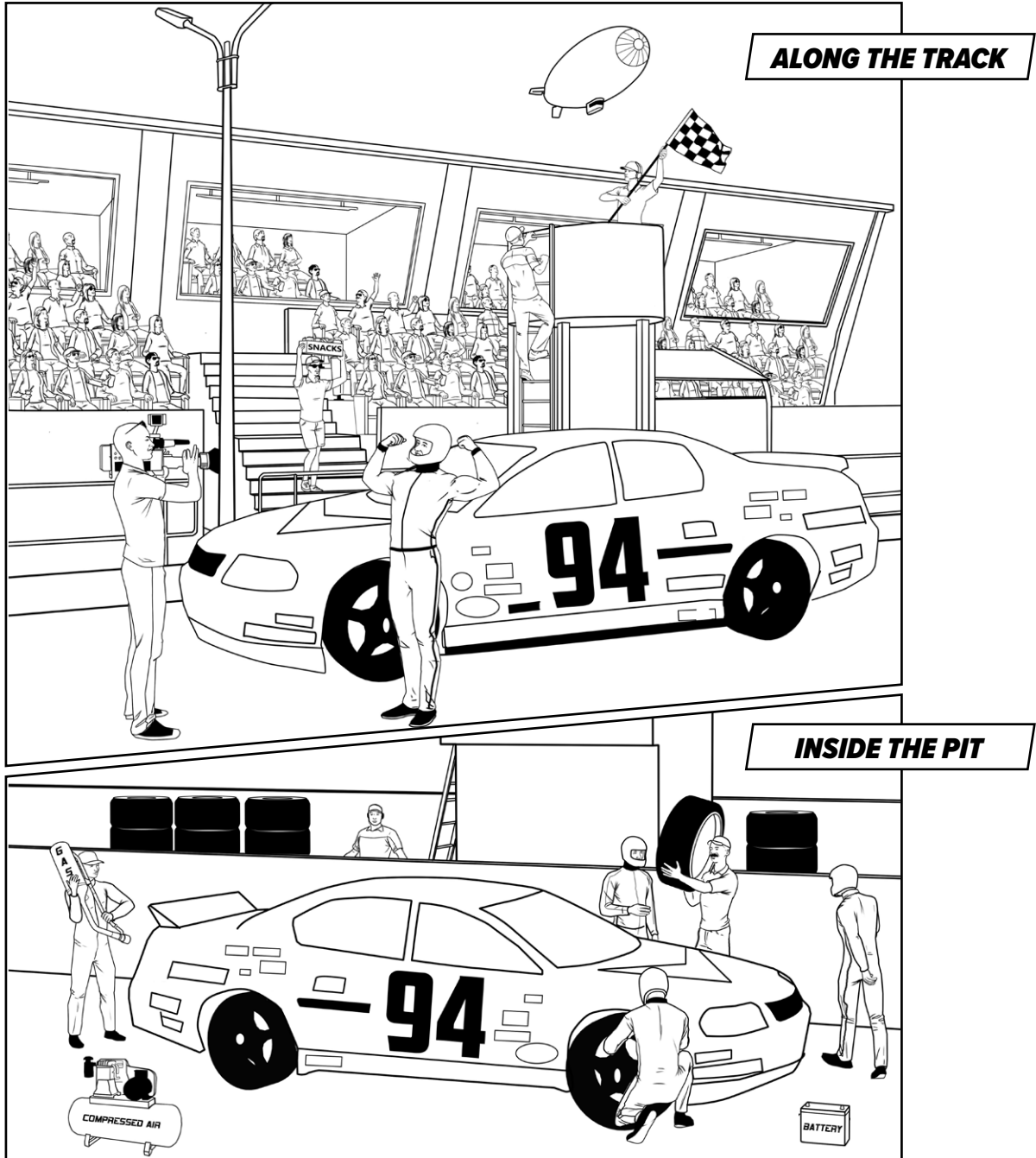

- 1 Chemical: \_\_\_\_\_
- 2 Gravitational: \_\_\_\_\_
- 3 Electric: \_\_\_\_\_
- 4 Elastic: \_\_\_\_\_

# LESSON PLAN 2: KINETIC ENERGY

## ENERGY IN MOTION

**TIME REQUIRED:** 1 hour

**MATERIALS:** String, heavy and light objects (such as a pencil and a pack of index cards), paper cup, masking tape, ruler, textbooks, cardboard, toy car or completed car from the **Three Ds of Speed**

**ACTIVITY SHEETS:** Kinetic Energy Activity Sheet



**Central question:**  
*What is kinetic energy?*

Have students consider what happens to potential energy when it's released from its stored state. Explain that energy can't be created or destroyed, but it does change from one form to another. Potential energy is often converted into another type of energy called kinetic energy. Kinetic energy is the energy of motion. Kinetic energy can also transform back into potential energy. For example, you'd use kinetic energy to lift a ball to the top of a ramp. That energy would be stored in the ball as potential energy.



**Central question:**  
*What factors affect kinetic energy?*

1. Explain that there are two factors that affect how much kinetic energy a moving object will have: mass and speed. Have students complete this demonstration to learn how mass influences an object's kinetic energy.
2. Select a light object (such as a pencil) and a heavy object (such as a pack of index cards). Tie a string around each object, leaving a three-foot-long piece attached. Have a student volunteer hold the light object in his or her right hand three feet above the ground. He or she should hold the other end of the string in his or her left hand so it is stretched horizontally. Have another student place a paper cup on the floor just under the first student's left hand, and mark the spot on the floor with a piece of masking tape. Tell the first student to let go of the object so it swings and collides with the paper cup (this may take a few tries to hit the cup). Have your other volunteer measure the distance the paper cup

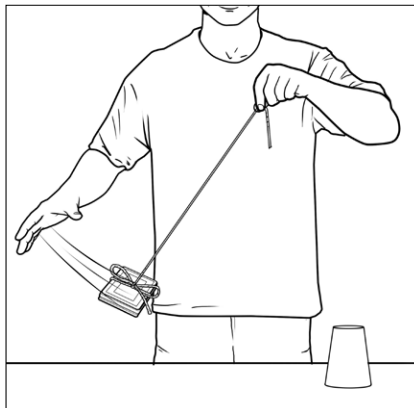

moved after the swinging object struck it.

3. Repeat the process with the heavier object. Students will observe that the heavier object made more of an impact than the lighter one, moving the cup farther away. This is because the heavier object had a greater kinetic energy.



**Central question:**  
*How can potential energy become kinetic energy?*

1. Reveal that racecars don't just go forward and side to side as they pass each other on the racetrack, they also go up! NASCAR racetracks aren't completely flat. On turns, the tracks are actually tilted. The highest racetrack banking is tilted a steep 33 degrees at the Talladega Super Speedway.
2. Racetrack bankings help drivers maintain grip as they whip around corners. The steeper bankings also create more potential energy in the racecars because the cars are raised higher in the air. When drivers come off a banking and onto the flat portion of the track, they have more speed as the potential energy transforms into kinetic energy.
3. Explain that NASCAR engineers

consider the height of a racetrack's banking when considering how cars will perform. Remind students that three factors affect how much gravitational potential energy the racecar has at the top of a racetrack's banking: the height of the banking, the car's mass, and the force of gravity. Given the fact that mass impacts kinetic energy, all racecars must weigh 3,300 pounds (without a driver). Having identical masses makes sure the cars are competitively equal. NASCAR enforces these rules by inspecting each car before and after each race. (If you have not explored aerodynamics with your class, refer to the **Three Ds of Speed** unit to learn how NASCAR drivers and engineers use science to create more speed on the track.)

4. Tell students they will team up to test how potential energy turns into kinetic energy. Hand out the *Kinetic Energy Activity Sheet* and the experiment materials. After groups have completed the experiment, have them present their results and discuss as a class.



**Central question:**  
*How does kinetic energy influence NASCAR engineers' choices?*

Explain that NASCAR engineers spend a lot of time thinking about kinetic energy for both racecar performance and safety. Divide students into teams, and tell them to put on their make-believe "engineer caps." They'll need to imagine all the parts of a NASCAR race from start to finish—that includes designing cars and tracks, installing safety protections for drivers and fans, understanding how vehicles will perform while racing and when making pit stops, and even things that could possibly go wrong during a competition. Have students create a list of the roles kinetic energy plays in each stage of racing.

NAME \_\_\_\_\_

# RAMP IT UP

## DIRECTIONS:

Try this experiment to see how changing a car's potential energy changes its kinetic energy.

**PREDICT:** Will a car racing down a ramp travel a shorter or greater distance if you raise the ramp's height? \_\_\_\_\_

\_\_\_\_\_

\_\_\_\_\_

\_\_\_\_\_

## GATHER YOUR MATERIALS:

Books, cardboard, toy car or completed car from the Three Ds of Speed, tape, ruler

## PROCEDURE:

- 1 Use books and cardboard to make a ramp. Use tape to secure both ends of the ramp to the books and floor.
- 2 Measure the height of the ramp. Record the height under "Run 1" in the table below.
- 3 Place your car at the top of the ramp. Release the car. Once it stops moving, use the ruler to measure how far it rolled from the end of the ramp.
- 4 Add two textbooks to raise the height of your ramp. Then repeat steps two and three.

## DATA:

	Ramp Height	Distance Car Rolled
Run 1		
Run 2		

## CONCLUSIONS:

Answer these questions on a separate sheet of paper.

- 1 What happened when you raised the height of the ramp? Was your prediction correct?
- 2 Did raising the ramp's height give the car more or less potential energy? Explain your answer.
- 3 Did the car in Run 1 or 2 end up with more kinetic energy? How could you tell?

# LESSON PLAN 3: FRICTION AND ENERGY

## A DYNAMIC DUO

**TIME REQUIRED:** 1 hour

**MATERIALS:** Cardboard, toy car or completed car from the **Three Ds of Speed**, tape measure or rulers, tape, books, various surfaces (such as tinfoil, fine sandpaper, rough sandpaper, waxed paper, carpet)

**ACTIVITY SHEET:** Friction and Energy Activity Sheet



**Central question:**  
*How are kinetic energy and friction related?*

1. Ask students to define friction—the resistance that one surface experiences when moving over another. For example, as a spinning tire rolls over a racetrack, the tire's surface catches against the road, creating friction that improves traction and helps racecars gain speed and increase grip. Grip, which is another word for friction, helps racecars stay on the track, even when navigating turns at high speeds.

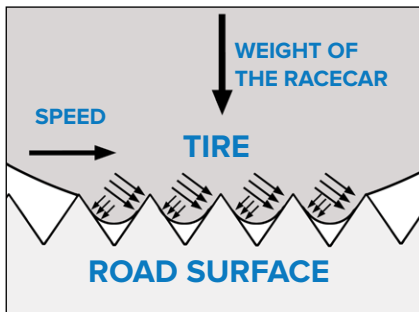

2. At NASCAR, car tires, the racecar's aerodynamics, and the surface of the roads are all fine-tuned to make sure the racecars make solid contact with the ground. NASCAR tires are smoother than the tires on everyday vehicles. This allows more surface area on the tire to be in contact with the track. This smooth surface area provides greater grip at higher speeds, keeping racecars safe on the track. In addition, NASCAR tracks are made of specific surfaces, such as asphalt or concrete, which help tire friction and performance. Rougher surfaces increase friction, while smoother surfaces allow objects to slide more easily over them.

3. While friction can increase safety in racecars, it can cause problems, too. Due to a racecar's high speed, there is a lot of friction where the tires rub against the road. The friction takes some of the racecar's kinetic energy and converts it into heat energy. As a result, the racecar's tires become very hot and can eventually fall apart. This is why racecar teams change tires multiple times during a race.



**Central question:**  
*What type of energy is created by friction?*

1. Demonstrate how friction is heat energy by having students rub their hands together. Point out that the more vigorously they rub them, the warmer their hands will become. Any two surfaces that rub together will create heat.
2. Point out that friction depends on a force pushing two surfaces together. For example, when you rub your hands together, the more force you apply, the more friction and heat you will create. If there is no force, there is no contact; therefore, there is no friction.



**Central question:**  
*What types of surfaces create the most friction?*

1. Distribute the *Friction and Energy Activity Sheet* and tell students that they will build a high-friction racetrack to demonstrate the effects of friction on a rolling car. Point out that any contact between atoms or molecules that are moving against each other will create friction.

Rough surfaces have more matter exposed than smooth surfaces—more nooks and crannies—and this can create more available spots for possible friction.

2. After the discussion, have students create a cause-and-effect chart that analyzes the impact of friction on their experiment and explain the effects of friction on kinetic energy.



**Central question:**  
*How can we diminish friction?*

Explain that racecar engineers study friction to improve the speed of racecars. They work to diminish friction so the cars can move quickly, but they don't want to get rid of friction altogether, because friction allows the cars to slow down and stop. Divide students into problem-solving teams and give them the task of brainstorming ways to remove friction from their daily lives. Their lists should include sources of friction around them and an explanation of how removing that friction would make their lives better. If they need idea prompts, share this list of everyday items that experience friction: car tires, skateboard wheels, train tracks, revolving doors, zippers. Have groups present their recommendations to the class.

**AFTER THE UNIT:** Once you have finished all three lessons, have students complete the post-assessment and compare their responses to the pre-assessment.

**POST-ASSESSMENT ANSWER KEY:**  
1. B; 2. D; 3. D; 4. B; 5. B; 6. C; 7. A; 8. A; 9. B; 10. D



NAME \_\_\_\_\_

# THE FORCE OF FRICTION

**Friction helps a racecar's tires better grip the track,** allowing it to surge ahead at high speeds. But friction can work against objects too, slowing them down.

Friction is the resistance that happens between surfaces that are moving against each other. You can't often see friction, but it's all around us. Use this experiment to create friction, measure it, and analyze its impacts.

## PROCEDURE:

- 1 Build a simple incline to roll your car down. Put one end of your cardboard on a stack of books. In front of the ramp, clear a racetrack for the car to travel. Curl the bottom of the ramp, so the car's impact with the floor is as gentle as possible.
- 2 For your first test run, place your car at the top of the ramp and release the car. When it stops rolling, measure how far it traveled across the floor from the bottom of the ramp. Record your data in the chart on the right.
- 3 Before your next test run, list the surfaces you will test on the blanks in the chart. Then place the first surface you will test at the bottom of your ramp. Release your car from the top of your ramp. Measure how far the car travels when it rolls over your first surface. Follow these same steps to test your two other surfaces. Record all your data.

**GATHER YOUR MATERIALS:**

Cardboard, toy car, completed car from the Three Ds of Speed, ruler, tape, books, three different surfaces such as sandpaper, tinfoil, and carpet



DATA:	
Surface	Distance
Floor	
Surface 1 _____	
Surface 2 _____	
Surface 3 _____	

## CONCLUSIONS:

Answer these questions on a separate sheet of paper.

- 1 What causes friction? Which surfaces caused the most friction and which surfaces caused the least friction?
- 2 How did you witness friction in this experiment? What piece of data was evidence of friction?
- 3 In your own words, summarize how friction affects a moving object's kinetic energy.

NAME: \_\_\_\_\_

## WHAT DID YOU LEARN ABOUT HOW ENERGY WORKS?

Share what you know about the influence of energy on the objects in the world around us.

- 1** The energy stored in an object due to its position or condition is known as \_\_\_\_\_.

  - A** Kinetic energy
  - B** Potential energy
  - C** Friction
  - D** All of the above
- 2** Mass, gravity, and height are the variables that shape \_\_\_\_\_.

  - A** Speed
  - B** Friction
  - C** Kinetic energy
  - D** Potential energy
- 3** Increasing an object's \_\_\_\_\_ will increase its potential energy.

  - A** Girth
  - B** Force
  - C** Width
  - D** Mass
- 4** Imagine two objects of the same mass sitting on a bookshelf. If you take one of them and move it to a lower shelf, you have \_\_\_\_\_.

  - A** Increased its potential energy
  - B** Decreased its potential energy
  - C** Caused no change in its potential energy
  - D** Removed all energy from the object
- 5** The energy of an object in motion is known as \_\_\_\_\_.

  - A** Potential energy
  - B** Kinetic energy
  - C** Mechanical energy
  - D** Nuclear energy
- 6** Speed and \_\_\_\_\_ are the factors that affect kinetic energy.

  - A** Height
  - B** Gravity
  - C** Mass
  - D** Temperature
- 7** True or false? Imagine a delivery truck is driving down the road and suddenly it loses half of its load. The truck's kinetic energy has decreased.

**A** True                      **B** False
- 8** The resistance that occurs when one surface rubs against another is called \_\_\_\_\_.

  - A** Friction
  - B** Free energy
  - C** Gravity
  - D** Acceleration
- 9** A racecar's brake rotors often glow red because friction generates \_\_\_\_\_.

  - A** Kinetic energy
  - B** Heat
  - C** Potential energy
  - D** Acceleration
- 10** Knowing about potential and kinetic energy helps racecar engineers \_\_\_\_\_.

  - A** Understand how the two are related
  - B** Design cars that go faster
  - C** Reduce the effects of friction
  - D** All of the above

# CORE CONCEPTS AND SKILLS SPOTLIGHT

## NEXT GENERATION SCIENCE STANDARDS

**Energy and NASCAR** covers overarching concepts and skills relevant to a range of science principles that can be easily applied to your state's science standards.

### DISCIPLINARY CORE IDEAS: PHYSICAL SCIENCE

#### Motion and Stability: Forces and Interactions

- ▶ The gravitational force of Earth acting on an object near Earth's surface pulls that object toward the planet's center.

**Related Standard:**

Support an argument that the gravitational force exerted by Earth on objects is directed down.

- ▶ The sum of an object is determined by the sum of the forces acting on it; if the total force on the object is not zero, its motion will change. For any given object, a larger force causes a larger change in motion.

**Related Standard:**

Plan an investigation to provide evidence that the change in an object's motion depends on the sum of the forces on the object and the mass of the object.

#### Energy

- ▶ Motion energy is properly called kinetic energy; it is proportional to the mass of the moving object and grows with the square of its speed.

**Related Standard:**

Construct and interpret graphical displays of data to describe the relationship of kinetic energy to the mass of an object and to the speed of an object.

- ▶ A system of objects may also contain stored (potential) energy, depending on their relative positions.

**Related Standard:**

Develop a model to describe that when the arrangement of objects interacting at a distance changes, different amounts of potential energy are stored in the system.

### SCIENCE AND ENGINEERING PRACTICES

#### Planning and Carrying Out Investigations

- ▶ Plan and conduct an investigation collaboratively to produce data to serve as the basis for evidence, using fair tests in which variables are controlled and the number of trials considered.
- ▶ Make observations and/or measurements to produce data to serve as the basis for evidence for an explanation of a phenomenon or test a design solution.

#### Engaging in Argument From Evidence

- ▶ Construct, use, and/or present an oral and written argument supported by empirical evidence and scientific reasoning to support or refute an explanation or a model for a phenomenon or a solution to a problem.

#### Constructing Explanations and Designing Solutions

- ▶ Construct an explanation of observed relationships.

#### Obtaining, Evaluating, and Communicating Information

- ▶ Communicate scientific and/or technical information orally and/or in written formats, including various forms of media as well as tables, diagrams, and charts.

Source: NGSS Lead States. 2013. *Next Generation Science Standards: For States, By States*. Washington, DC: The National Academies Press.