





Screw Gears

SN Screw Gears	SUN Stainless Steel Screw Gears	AN Screw Gears	PN Plastic Screw Gears
 <p>J Series</p> <p>Precision: N9 Material: S45C</p>	 <p>Precision: N9 Material: SUS303</p>	 <p>Precision: N9 Material: CAC702 (A1BC2)</p>	 <p>Precision: N9 Material: MC901</p>
m1 ~ 4 Page 344	m1 ~ 3 Page 348	m1 ~ 3 Page 350	m1 ~ 3 Page 352

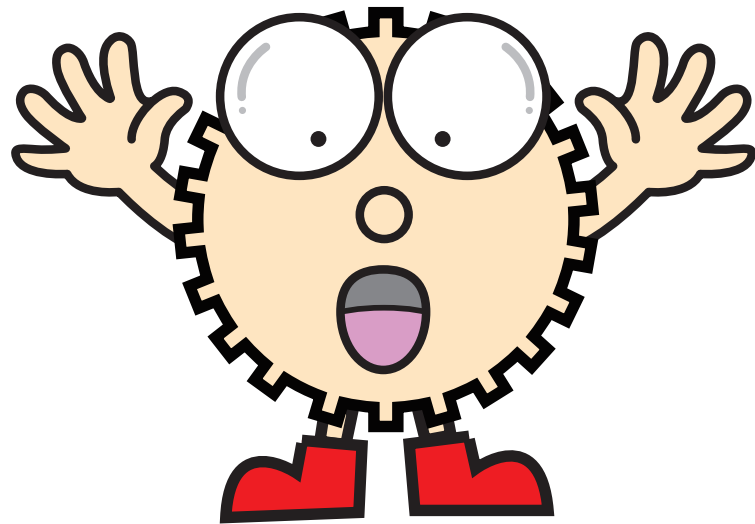

Catalog Number of KHK Stock Gears

The Catalog Number for KHK stock gears is based on the simple formula listed below. Please order KHK gears by specifying the Catalog Numbers.

(Example) Screw Gears

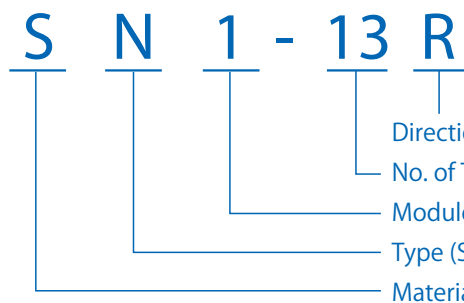

Material

S	S45C
SU	Stainless Steel
A	CAC702
P	MC901

Type

N	Screw Gears
---	-------------

- Spur Gears
- Helical Gears
- Internal Gears
- Racks
- CP Racks & Pinions
- Miter Gears
- Bevel Gears
- Screw Gears
- Worm Gear Pairs
- Bevel Gearboxes
- Other Products

Features

KHK stock screw gears come in four materials, S45C, SUS303, CAC702 (old JIS A ℓ BC2) and MC nylon, in modules 1~4 and numbers of teeth from 10 to 30.

Catalog Number	Module	Material	Heat Treatment	Tooth Surface Finish	Precision JIS B 1702-1:1998	Secondary Operations	Features
SN	1 to 4	S45C	—	Cut	N9	○	Popular screw gears. Additionally, gear tooth induction hardening secondary operations can be performed. J Series products are also available.
SUN	1 to 3	SUS303	—	Cut	N9	○	Suitable for food machinery due to SUS303's rust-resistant qualities.
AN	1 to 4	CAC702 (A ℓ BC2)	—	Cut	N9	○	Aluminum bronze made products have excellent wear resistance.
PN	1 to 3	MC901	—	Cut	N9	○	Light-weight products made of MC Nylon can be used without lubrication.

○ Possible △ Partly possible × Not possible

Application Examples

KHK stock screw gears are used in various labor-saving machines including feeding devices.

■ Design example of feeding device (not a design for machinery or a device in actual use)

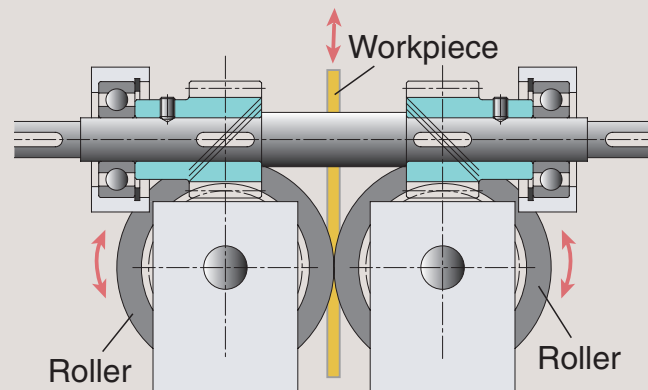

Rotate the rollers in reverse with one input shaft and move the pinched workpiece vertically

Selection Hints

Please select the most suitable products by carefully considering the characteristics of items and contents of the product tables. Since screw gears come in right- or left-hand helix, make sure to include the letter "R" or "L" in the catalog number when you order.

1. Caution in Selecting the Mating Gears

Screw gears are used for offset shafts. Whether the shafts are paralleled offset or skewed offset depends on the helix directions of the mating gears.

Direction of shaft	Arrangement of helix hands
Skewed Axes	RH-RH or LH-LH
Parallel Axes	RH-LH

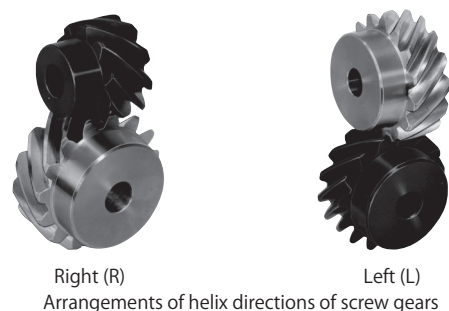

Right (R) Left (L)
Arrangements of helix directions of screw gears

2. Caution in Selecting Gears Based on Gear Strength

The allowable surface strengths listed in the product pages were derived using the Niemann formula as reference values. (Used with skewed axes)

There is a paucity of data on the strength of screw gears. The values of constant K_0 used in the calculations, which depend on the material of the mating gears, are our estimates. The mathematic expression below shows the Niemann formula to determine allowable tangential force F_t (kgf) and allowable torque T (kgf·m) on a basic circle.

$$F_t = 1.43 d_1^2 f_z K_s$$

$$T = \frac{F_t d_1}{2000}$$

Here, d_1 : standard pitch diameter of pinion (mm)
 f_z : coefficient based on no. of teeth combination
 K_s : coefficient based on materials and sliding speed

$$K_s = K_0 \frac{2}{2 + V_s}$$

Here, K_0 : coefficient based on material selection
 V_s : sliding speed (m/s)

$$V_s = \frac{\pi n d_1}{60000 \cos \beta}$$

Here, n : rotational speed (rpm)
 β : helix angle (45°)

■ f_z value

Z ₂ \ Z ₁	10	13	15	20	26	30
10	1.538					
13	2.005	1.538				
15	2.279	1.786	1.538			
20	2.963	2.329	2.053	1.538		
26	3.695	2.963	2.588	2.005	1.538	
30	4.161	3.350	2.963	2.279	1.786	1.538

■ Setting values depending on usage conditions

Catalog Number	Mating gear	K_0 value	Maximum allowable sliding speed m/s	No. of teeth of mating gears	Rotational Speed
SN	SN	0.0030	2.5	Same no. of teeth	100 rpm
SUN	SN	0.0030 Note 1	2.5 Note 1		
AN	SN	0.0050	5		
PN	SN	0.0030 Note 1 (0.0021)	2.5 Note 1 (1.0)		

[NOTE 1] K_0 values and the maximum allowable sliding speed of SUN & PN products are set by KHK. Screw gears are basically used with lubrication. When using PN products without lubrication, the parenthetical values shown in the table are applied.

Application Hints

In order to use KHK stock screw gears safely, read the Application Hints carefully before proceeding. Please refer to Page 26 for "Cautions on Handling" and Page 27 for "Cautions on Starting".

1. Cautions on Performing Secondary Operations

- If re boring, it is important to pay special attention to locating the center in order to avoid runout.
- The reference datum for gear cutting is the bore. Therefore, use the bore for locating the center. If it is too difficult to do for small bores, the alternative is to use one spot on the bore and the runout of the side surface.
- If reworking using scroll chucks, we recommend the use of new or re bored jaws for improved precision. Please exercise caution not to crush the teeth by applying too much pressure. Any scarring will cause noise during operation.

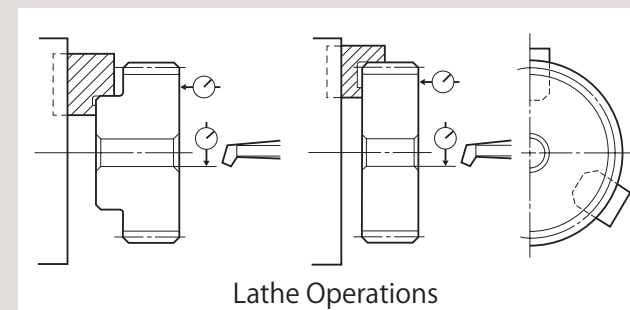

Lathe Operations

- The maximum bore size is dictated by the requirement that the strength of the hub is to be higher than that of the gear teeth. The maximum bore size should be 60% to 70% of the hub diameter (or tooth root diameter), and 50% to 60% for keyway applied modifications.
- In order to avoid stress concentration, round the keyway corners.

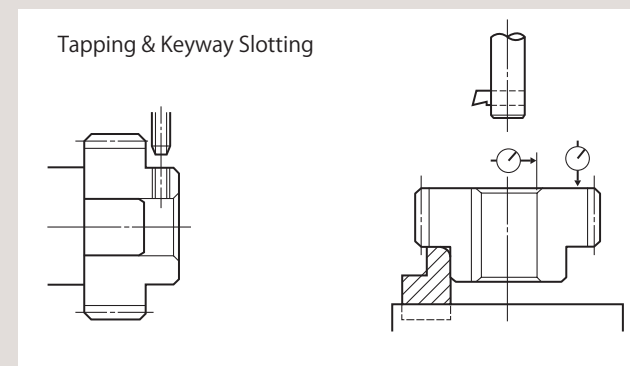

Tapping & Keyway Slotting

2. Points of Caution during Assembly

- KHK stock screw gears are designed to give the proper normal direction backlash when assembled using the center distance given by the formula below with a tolerance of H7 to H8. The amount of backlash is given in the product table for each gear.

$$a = \frac{d_1 + d_2}{2}$$

Where
 a : Center distance
 d_1 : Pitch diameter of pinion
 d_2 : Pitch diameter of gear

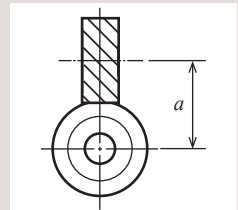

- Total Length Tolerance for Screw Gears

Total Length (mm)	Tolerance
30 or less	0 - 0.10
31 to 100	0 - 0.15

[NOTE] PN Plastic Screw Gears are excluded.

- Due to the helix of screw gears, they produce axial thrust forces. The bearings must be selected properly to be able to handle these thrust forces. The directions of thrust change with the direction of helix and the direction of rotation as illustrated below.

■ Direction of rotation and thrust force

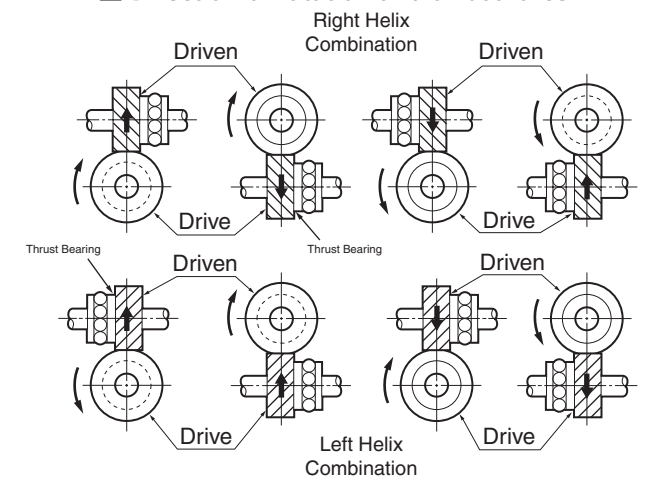

[NOTE] For parallel shaft applications, see the Application Hints for KHK Helical Gears (Page 167).

KHK considers safety a priority in the use of our products.

When handling, adding secondary operations, assembling, and operating KHK products, please be aware of the following issues in order to prevent accidents.

⚠ Warning: Precautions for preventing physical and property damage

- When using KHK products, follow relevant safety regulations (Occupational Safety and Health Regulations, etc.).
- Pay attention to the following items when installing, removing, or performing maintenance and inspection of the product.
 - Turn off the power switch.
 - Do not reach or crawl under the product.
 - Wear appropriate clothing and protective equipment for the work.

⚠ Caution Cautions in Preventing Accidents

- Before using a KHK product, read the precautions in the catalog carefully in order to use it correctly.
- Avoid use in environments that may adversely affect the product.
- Our products are manufactured under a superior quality control system based on the ISO9000 quality management system; if you notice any malfunctions upon purchasing a product, please contact the supplier.



Specifications	
Precision grade	JIS grade N9 (JIS B1702-1: 1998)
Reference section of gear	Normal plane
Gear teeth	Standard full depth
Normal pressure angle	20°
Helix angle	45°
Material	S45C
Heat Treatment	—
Surface treatment	Black oxide coating

* The precision grade of J Series products is equivalent to the value shown in the table.

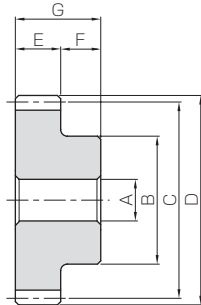

S1

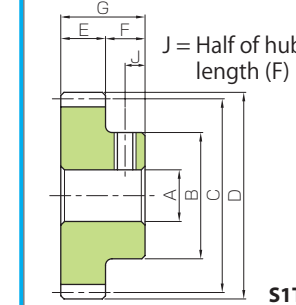

S1T

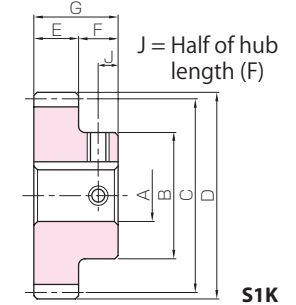

S1K



To order J Series products, please specify: **Catalog No. + J + BORE.**

Catalog Number	Module	No. of teeth	Direction of spiral	Shape	Bore		Pitch dia.	Outside dia.	Face width	Hub width	Total Length	Allowable torque (N·m)	Allowable torque (kgf·m)	Backlash (mm)	Weight (kg)							
					A-H7	B																
SN1-13R SN1-13L	m1	13	R	S1	6	15	18.38	20.38	10	10	20	0.19	0.019	0.08~0.18	0.030							
SN1-15R SN1-15L			L			18										21.21	23.21	0.29	0.029			
SN1-20R SN1-20L		20	R		8	25	28.28	30.28				0.66	0.068									
SN1-26R SN1-26L			L			30	36.77	38.77				1.42	0.14									
SN1-30R SN1-30L		30	R		10	35	42.43	44.43				2.14	0.22									
SN1-26R SN1-26L			L			35	42.43	44.43				2.14	0.22									
SN1.5-10R SN1.5-10L	m1.5	10	R	S1	8	16	21.21	24.21	15	10	25	0.29	0.029	0.10~0.22	0.048							
SN1.5-13R SN1.5-13L			L			23	27.58	30.58								0.62	0.063					
SN1.5-15R SN1.5-15L		15	R		10	25	31.82	34.82				0.93	0.095									
SN1.5-20R SN1.5-20L			L			30	42.43	45.43				2.14	0.22									
SN1.5-26R SN1.5-26L		26	R		12	40	55.15	58.15				4.51	0.46									
SN1.5-30R SN1.5-30L			L			45	63.64	66.64				6.75	0.69									
SN2-10R SN2-10L		m2	10		R	S1	12	22				28.28	32.28			20	15	35	0.66	0.068	0.10~0.22	0.11
SN2-13R SN2-13L					L			30				36.77	40.77									
SN2-15R SN2-15L	15		R	15	35		42.43	46.43	2.14	0.22												
SN2-20R SN2-20L			L		45		56.57	60.57	4.84	0.49												
SN2-26R SN2-26L	26		R	20	60		73.54	77.54	10.1	1.03												
SN2-30R SN2-30L			L		65		84.85	88.85	15.0	1.53												

- [Caution on Product Characteristics]
- When mating screw gears are made of the same material, they may cause abrasion and scoring. It is recommended to mate screw gears composed of different materials.
 - The allowable torques shown in the table are calculated values according to the assumed usage conditions. Please see Page 342 for more details.
 - The backlash values shown in the table are the theoretical values for the backlash in the normal direction of a pair of identical gears in mesh.
 - For offset shaft applications, match a RH with a RH, or LH with a LH, to make a set of screw gears. For parallel shaft applications, mesh opposite hands (RH and LH) of helical gear sets. Please see Page 342 for more details.
 - If the bore diameter is less than $\phi 4$, the bore tolerance class is H8. If the bore diameter is $\phi 5$ or $\phi 6$, and the hole length (total length) exceeds 3 times the diameter, then the class is also H8.
- [Caution on Secondary Operations]
- Please read "Cautions on Performing Secondary Operations" (Page 343) when performing modifications and/or secondary operations for safety concerns. KHK Quick-Mod Gears, the KHK system for quick modification of KHK stock gears, is also available.
 - Avoid performing secondary operations that narrow the tooth width, as it affects precision and strength.

Bore H7	* The product shapes of J Series items are identified by background color.																			
	6	8	10	12	14	15	16	17	18	19	20	22	25	28	30	32	35			
Keyway Js9	—		4x1.8				5x2.3				6x2.8				8x3.3				10x3.3	
Screw size	—		4x1.8				5x2.3				6x2.8				8x3.3				10x3.3	
Catalog Number	M4	M5	M4				M5				M6				M8					
SN1-13R J BORE	S1T																			
SN1-13L J BORE	S1T																			
SN1-15R J BORE	S1T	S1T																		
SN1-15L J BORE	S1T	S1T																		
SN1-20R J BORE		S1T	S1K	S1K																
SN1-20L J BORE		S1T	S1K	S1K																
SN1-26R J BORE			S1K	S1K	S1K	S1K	S1K	S1K												
SN1-26L J BORE			S1K	S1K	S1K	S1K	S1K	S1K												
SN1-30R J BORE			S1K	S1K	S1K	S1K	S1K	S1K	S1K	S1K										
SN1-30L J BORE			S1K	S1K	S1K	S1K	S1K	S1K	S1K	S1K										
SN1.5-10R J BORE		S1T																		
SN1.5-10L J BORE		S1T																		
SN1.5-13R J BORE			S1K																	
SN1.5-13L J BORE			S1K																	
SN1.5-15R J BORE			S1K	S1K																
SN1.5-15L J BORE			S1K	S1K																
SN1.5-20R J BORE				S1K	S1K	S1K	S1K	S1K												
SN1.5-20L J BORE				S1K	S1K	S1K	S1K	S1K												
SN1.5-26R J BORE				S1K	S1K	S1K	S1K	S1K	S1K	S1K										
SN1.5-26L J BORE				S1K	S1K	S1K	S1K	S1K	S1K	S1K										
SN1.5-30R J BORE				S1K	S1K	S1K	S1K	S1K	S1K	S1K	S1K									
SN1.5-30L J BORE				S1K	S1K	S1K	S1K	S1K	S1K	S1K	S1K									
SN2-10R J BORE			S1K																	
SN2-10L J BORE			S1K																	
SN2-13R J BORE			S1K	S1K	S1K	S1K	S1K													
SN2-13L J BORE			S1K	S1K	S1K	S1K	S1K													
SN2-15R J BORE			S1K	S1K	S1K	S1K	S1K	S1K	S1K											
SN2-15L J BORE			S1K	S1K	S1K	S1K	S1K	S1K	S1K											
SN2-20R J BORE					S1K	S1K	S1K	S1K	S1K	S1K										
SN2-20L J BORE					S1K	S1K	S1K	S1K	S1K	S1K										
SN2-26R J BORE											S1K	S1K	S1K	S1K	S1K	S1K	S1K			
SN2-26L J BORE											S1K	S1K	S1K	S1K	S1K	S1K	S1K			
SN2-30R J BORE											S1K	S1K	S1K	S1K	S1K	S1K	S1K			
SN2-30L J BORE											S1K	S1K	S1K	S1K	S1K	S1K	S1K			

- [Caution on J series]
- As available-on-request products, these require a lead-time for shipping within 2 working days (excludes the day ordered), after placing an order.
 - Number of products we can process for one order is 1 to 20 units. For quantities of 21 or more pieces, we need to quote price and lead time.
 - Keyways are made according to JIS B1301 standards, Js9 tolerance.
 - Certain products which would otherwise have a very long tapped hole are counterbored to reduce the length of the tap. For details, please see the KHK Web Catalog.
 - Areas of products which have been re-worked will not be black oxide coated.
 - For products having a tapped hole, a set screw is included.
 - When using S1T set screws for fastening gears to a shaft, only use this method for applications with light load usage. For secure fastening, please use dowel pins in combination.



Specifications	
Precision grade	JIS grade N9 (JIS B1702-1:1998)
Reference section of gear	Normal plane
Gear teeth	Standard full depth
Normal pressure angle	20°
Helix angle	45°
Material	S45C
Heat Treatment	—
Surface treatment	Black oxide coating

* The precision grade of J Series products is equivalent to the value shown in the table.

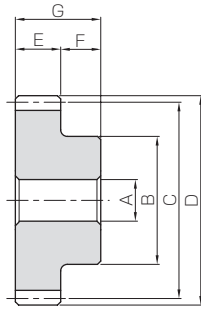

S1

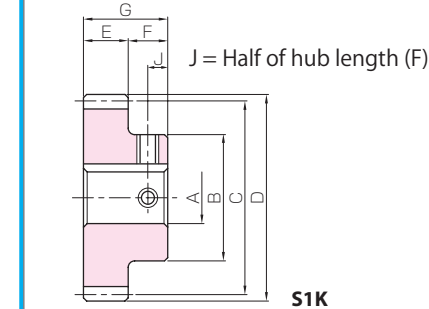

S1K



To order J Series products, please specify: **Catalog No. + J + BORE.**

Catalog Number	Module	No. of teeth	Direction of spiral	Shape	Bore		Pitch dia.	Outside dia.	Face width	Hub width	Total Length	Allowable torque (N·m)	Allowable torque (kgf·m)	Backlash (mm)	Weight (kg)									
					A-H7	B																		
SN2.5-10R SN2.5-10L	m2.5	10	R L	S1	12	26	35.36	40.36	22	16	38	1.27	0.13	0.12~0.24	0.20									
SN2.5-13R SN2.5-13L		13	R L		15	35	45.96	50.96																
SN2.5-15R SN2.5-15L		15	R L		40	53.03	58.03																	
SN2.5-20R SN2.5-20L		20	R L		60	70.71	75.71																	
SN2.5-26R SN2.5-26L		26	R L		70	91.92	96.92																	
SN2.5-30R SN2.5-30L		30	R L		80	106.07	111.07																	
SN3-10R SN3-10L		m3	10		R L	S1	15	34								42.43	48.43	25	18	43	2.14	0.22	0.12~0.26	0.35
SN3-13R SN3-13L			13		R L		45	55.15								61.15								
SN3-15R SN3-15L	15		R L	50	63.64		69.64																	
SN3-20R SN3-20L	20		R L	60	84.85		90.85																	
SN3-26R SN3-26L	26		R L	80	110.31		116.31																	
SN3-30R SN3-30L	30		R L	90	127.28		133.28																	
SN4-10R SN4-10L	m4		10	R L	S1		20	45	56.57	64.57	30	20	50	4.84	0.49	0.16~0.34	0.72							
SN4-13R SN4-13L			13	R L			60	73.54	81.54															
SN4-15R SN4-15L		15	R L	70		84.85	92.85																	
SN4-20R SN4-20L		20	R L	90		113.14	121.14																	
SN4-26R SN4-26L		26	R L	100		147.08	155.08																	
SN4-30R SN4-30L		30	R L	110		169.71	177.71																	

- [Caution on Product Characteristics]
- When mating screw gears are made of the same material, they may cause abrasion and scoring. It is recommended to mate screw gears composed of different materials.
 - The allowable torques shown in the table are calculated values according to the assumed usage conditions. Please see Page 342 for more details.
 - The backlash values shown in the table are the theoretical values for the backlash in the normal direction of a pair of identical gears in mesh.
 - For offset shaft applications, match a RH with a RH, or LH with a LH, to make a set of screw gears. For parallel shaft applications, mesh opposite hands (RH and LH) of helical gear sets. Please see Page 342 for more details.
 - If the bore diameter is less than $\phi 4$, the bore tolerance class is H8. If the bore diameter is $\phi 5$ or $\phi 6$, and the hole length (total length) exceeds 3 times the diameter, then the class is also H8.

- [Caution on Secondary Operations]
- Please read "Cautions on Performing Secondary Operations" (Page 343) when performing modifications and/or secondary operations for safety concerns. KHK Quick-Mod Gears, the KHK system for quick modification of KHK stock gears, is also available.
 - Avoid performing secondary operations that narrow the tooth width, as it affects precision and strength.

Bore H7	* The product shapes of J Series items are identified by background color.																	
	12	15	16	17	18	19	20	22	25	28	30	32	35	40	45	50		
Keyway Js9	4x1.8																	
Screw size	5x2.3				6x2.8				8x3.3				10x3.3		12x3.3		14x3.8	
Catalog Number	M4				M5				M6				M8		M10			
SN2.5-10R J BORE	S1K																	
SN2.5-10L J BORE	S1K																	
SN2.5-13R J BORE		S1K	S1K	S1K	S1K	S1K												
SN2.5-13L J BORE		S1K	S1K	S1K	S1K	S1K												
SN2.5-15R J BORE		S1K	S1K	S1K	S1K	S1K	S1K	S1K										
SN2.5-15L J BORE		S1K	S1K	S1K	S1K	S1K	S1K	S1K										
SN2.5-20R J BORE						S1K	S1K	S1K	S1K	S1K	S1K	S1K	S1K					
SN2.5-20L J BORE						S1K	S1K	S1K	S1K	S1K	S1K	S1K	S1K					
SN2.5-26R J BORE						S1K	S1K	S1K	S1K	S1K	S1K	S1K	S1K	S1K				
SN2.5-26L J BORE						S1K	S1K	S1K	S1K	S1K	S1K	S1K	S1K	S1K				
SN2.5-30R J BORE						S1K	S1K	S1K	S1K	S1K	S1K	S1K	S1K	S1K	S1K			
SN2.5-30L J BORE						S1K	S1K	S1K	S1K	S1K	S1K	S1K	S1K	S1K	S1K			
SN3-10R J BORE		S1K	S1K	S1K														
SN3-10L J BORE		S1K	S1K	S1K														
SN3-13R J BORE						S1K	S1K	S1K										
SN3-13L J BORE						S1K	S1K	S1K										
SN3-15R J BORE						S1K	S1K	S1K	S1K	S1K								
SN3-15L J BORE						S1K	S1K	S1K	S1K	S1K								
SN3-20R J BORE						S1K	S1K	S1K	S1K	S1K	S1K	S1K	S1K					
SN3-20L J BORE						S1K	S1K	S1K	S1K	S1K	S1K	S1K	S1K					
SN3-26R J BORE						S1K	S1K	S1K	S1K	S1K	S1K	S1K	S1K	S1K	S1K			
SN3-26L J BORE						S1K	S1K	S1K	S1K	S1K	S1K	S1K	S1K	S1K	S1K			
SN3-30R J BORE						S1K	S1K	S1K	S1K	S1K	S1K	S1K	S1K	S1K	S1K	S1K		
SN3-30L J BORE						S1K	S1K	S1K	S1K	S1K	S1K	S1K	S1K	S1K	S1K	S1K		
SN4-10R J BORE						S1K	S1K											
SN4-10L J BORE						S1K	S1K											
SN4-13R J BORE						S1K	S1K	S1K	S1K	S1K	S1K	S1K						
SN4-13L J BORE						S1K	S1K	S1K	S1K	S1K	S1K	S1K						
SN4-15R J BORE						S1K	S1K	S1K	S1K	S1K	S1K	S1K	S1K					
SN4-15L J BORE						S1K	S1K	S1K	S1K	S1K	S1K	S1K	S1K					
SN4-20R J BORE						S1K	S1K	S1K	S1K	S1K	S1K	S1K	S1K	S1K	S1K	S1K		
SN4-20L J BORE						S1K	S1K	S1K	S1K	S1K	S1K	S1K	S1K	S1K	S1K	S1K		
SN4-26R J BORE						S1K	S1K	S1K	S1K	S1K	S1K	S1K	S1K	S1K	S1K	S1K		
SN4-26L J BORE						S1K	S1K	S1K	S1K	S1K	S1K	S1K	S1K	S1K	S1K	S1K		
SN4-30R J BORE						S1K	S1K	S1K	S1K	S1K	S1K	S1K	S1K	S1K	S1K	S1K		
SN4-30L J BORE						S1K	S1K	S1K	S1K	S1K	S1K	S1K	S1K	S1K	S1K	S1K		

- [Caution on J series]
- As available-on-request products, these require a lead-time for shipping within 2 working days (excludes the day ordered), after placing an order.
 - Number of products we can process for one order is 1 to 20 units. For quantities of 21 or more pieces, we need to quote price and lead time.
 - Keyways are made according to JIS B1301 standards, Js9 tolerance.
 - Certain products which would otherwise have a very long tapped hole are counterbored to reduce the length of the tap. For details, please see the KHK Web Catalog.
 - Areas of products which have been re-worked will not be black oxide coated.
 - For products having a tapped hole, a set screw is included.

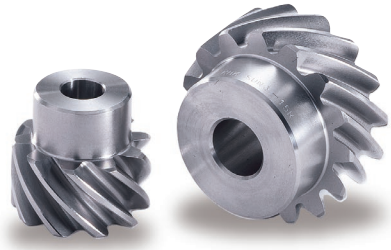

Specifications	
Precision grade	JIS grade N9 (JIS B1702-1: 1998)
Reference section of gear	Normal plane
Gear teeth	Standard full depth
Normal pressure angle	20°
Helix angle	45°
Material	SUS303
Heat Treatment	—

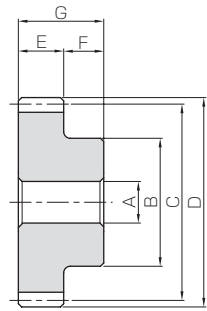

S1

Catalog Number	Module	No. of teeth	Direction of spiral	Shape	Bore		Pitch dia.	Outside dia.	Face width		Hub width	Total Length		
					A _{H7}	B			C	D			E	F
SUN1-13R SUN1-13L	m1	13	R L	S1	6	15	18.38	20.38	10	10	20			
SUN1-15R SUN1-15L		15	R L									18	21.21	23.21
SUN1-20R SUN1-20L		20	R L									25	28.28	30.28
SUN1.5-10R SUN1.5-10L	m1.5	10	R L	S1	8	16	21.21	24.21	15	10	25			
SUN1.5-13R SUN1.5-13L		13	R L									23	27.58	30.58
SUN1.5-15R SUN1.5-15L		15	R L									25	31.82	34.82
SUN1.5-20R SUN1.5-20L		20	R L									30	42.43	45.43
SUN2-10R SUN2-10L	m2	10	R L	S1	12	22	28.28	32.28	20	15	35			
SUN2-13R SUN2-13L		13	R L									30	36.77	40.77
SUN2-15R SUN2-15L		15	R L									35	42.43	46.43
SUN2-20R SUN2-20L		20	R L									45	56.57	60.57
SUN2.5-10R SUN2.5-10L	m2.5	10	R L	S1	12	26	35.36	40.36	22	16	38			
SUN2.5-13R SUN2.5-13L		13	R L									35	45.96	50.96
SUN2.5-15R SUN2.5-15L		15	R L									40	53.03	58.03
SUN2.5-20R SUN2.5-20L		20	R L									60	70.71	75.71
SUN3-10R SUN3-10L	m3	10	R L	S1	15	34	42.43	48.43	25	18	43			
SUN3-13R SUN3-13L		13	R L									45	55.15	61.15
SUN3-15R SUN3-15L		15	R L									50	63.64	69.64
SUN3-20R SUN3-20L		20	R L									60	84.85	90.85

- [Caution on Product Characteristics]
- When mating screw gears are made of the same material, they may cause abrasion and scoring. It is recommended to mate screw gears composed of different materials.
 - The allowable torques shown in the table are calculated values according to the assumed usage conditions. Please see Page 342 for more details.
 - The backlash values shown in the table are the theoretical values for the backlash in the normal direction of a pair of identical gears in mesh.
 - For offset shaft applications, match a RH with a RH, or LH with a LH, to make a set of screw gears. For parallel shaft applications, mesh opposite hands (RH and LH) of helical gear sets. Please see Page 342 for more details.
 - If the bore diameter is less than $\phi 4$, the bore tolerance class is H8. If the bore diameter is $\phi 5$ or $\phi 6$, and the hole length (total length) exceeds 3 times the diameter, then the class is also H8.

Allowable torque (N-m)		Allowable torque (kgf-m)		Backlash (mm)	Weight (kg)	Catalog Number
Bending strength	Surface durability	Bending strength	Surface durability			
—	0.19	—	0.019	0.08~0.18	0.030	SUN1-13R SUN1-13L
	0.29		0.029		0.043	SUN1-15R SUN1-15L
	0.66		0.068		0.079	SUN1-20R SUN1-20L
—	0.29	—	0.029	0.10~0.22	0.047	SUN1.5-10R SUN1.5-10L
	0.62		0.063		0.087	SUN1.5-13R SUN1.5-13L
	0.93		0.095		0.12	SUN1.5-15R SUN1.5-15L
	2.14		0.22		0.20	SUN1.5-20R SUN1.5-20L
—	0.66	—	0.068	0.12~0.26	0.11	SUN2-10R SUN2-10L
	1.42		0.14		0.22	SUN2-13R SUN2-13L
	2.14		0.22		0.30	SUN2-15R SUN2-15L
	4.84		0.49		0.53	SUN2-20R SUN2-20L
—	1.27	—	0.13	0.14~0.28	0.20	SUN2.5-10R SUN2.5-10L
	2.68		0.27		0.35	SUN2.5-13R SUN2.5-13L
	4.03		0.41		0.48	SUN2.5-15R SUN2.5-15L
	9.07		0.92		0.93	SUN2.5-20R SUN2.5-20L
—	2.14	—	0.22	0.14~0.32	0.34	SUN3-10R SUN3-10L
	4.51		0.46		0.58	SUN3-13R SUN3-13L
	6.75		0.69		0.79	SUN3-15R SUN3-15L
	15.04		1.53		1.39	SUN3-20R SUN3-20L

- [Caution on Secondary Operations]
- Please read "Cautions on Performing Secondary Operations" (Page 343) when performing modifications and/or secondary operations for safety concerns. KHK Quick-Mod Gears, the KHK system for quick modification of KHK stock gears, is also available.
 - Avoid performing secondary operations that narrow the tooth width, as it affects precision and strength.



Specifications	
Precision grade	JIS grade N9 (JIS B1702-1: 1998)
Reference section of gear	Normal plane
Gear teeth	Standard full depth
Normal pressure angle	20°
Helix angle	45°
Material	CAC702 (old JIS display Al BC2)
Heat Treatment	—

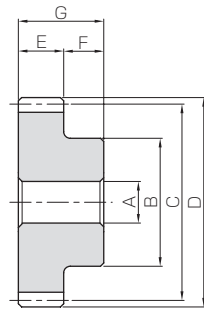

S1

Catalog Number	Module	No. of teeth	Direction of spiral	Shape	Bore		Pitch dia.	Outside dia.	Face width	Hub width	Total Length			
					A _{H7}	B								
AN1-13R AN1-13L	m1	13	R L	S1	6	15	18.38	20.38	10	10	20			
AN1-15R AN1-15L		15	R L									8	16	21.21
AN1.5-10R AN1.5-10L	m1.5	10	R L	S1	10	23	27.58	30.58	15	10	25			
AN1.5-13R AN1.5-13L		13	R L									25	31.82	34.82
AN1.5-15R AN1.5-15L		15	R L											
AN2-10R AN2-10L	m2	10	R L	S1	12	22	28.28	32.28	20	15	35			
AN2-13R AN2-13L		13	R L											
AN2-15R AN2-15L		15	R L											
AN2.5-10R AN2.5-10L	m2.5	10	R L	S1	15	26	35.36	40.36	22	16	38			
AN2.5-13R AN2.5-13L		13	R L											
AN2.5-15R AN2.5-15L		15	R L											
AN3-10R AN3-10L	m3	10	R L	S1	20	34	42.43	48.43	25	18	43			
AN3-13R AN3-13L		13	R L											
AN3-15R AN3-15L		15	R L											

Allowable torque (N·m)		Allowable torque (kgf·m)		Backlash (mm)	Weight (kg)	Catalog Number
Bending strength	Surface durability	Bending strength	Surface durability			
—	0.31	—	0.032	0.08~0.18	0.029	AN1-13R AN1-13L
—	0.48	—	0.049		0.042	AN1-15R AN1-15L
—	0.48	—	0.049	0.08~0.20	0.046	AN1.5-10R AN1.5-10L
—	1.03	—	0.10		0.10~0.22	0.085
—	1.55	—	0.16	0.11		AN1.5-15R AN1.5-15L
—	1.10	—	0.11	0.10~0.22	0.11	AN2-10R AN2-10L
—	2.36	—	0.24		0.12~0.26	0.21
—	3.56	—	0.36	0.29		AN2-15R AN2-15L
—	2.11	—	0.22	0.12~0.24	0.20	AN2.5-10R AN2.5-10L
—	4.47	—	0.46		0.14~0.28	0.34
—	6.72	—	0.69	0.47		AN2.5-15R AN2.5-15L
—	3.56	—	0.36	0.12~0.26	0.34	AN3-10R AN3-10L
—	7.51	—	0.77		0.14~0.32	0.57
—	11.3	—	1.15	0.77		AN3-15R AN3-15L

- [Caution on Product Characteristics]
- ① When mating screw gears are made of the same material, they may cause abrasion and scoring. It is recommended to mate screw gears composed of different materials.
 - ② The allowable torques shown in the table are calculated values according to the assumed usage conditions. Please see Page 342 for more details.
 - ③ The backlash values shown in the table are the theoretical values for the backlash in the normal direction of a pair of identical gears in mesh.
 - ④ For offset shaft applications, match a RH with a RH, or LH with a LH, to make a set of screw gears. For parallel shaft applications, mesh opposite hands (RH and LH) of helical gear sets. Please see Page 342 for more details.
 - ⑤ If the bore diameter is less than $\phi 4$, the bore tolerance class is H8. If the bore diameter is $\phi 5$ or $\phi 6$, and the hole length (total length) exceeds 3 times the diameter, then the class is also H8.

- [Caution on Secondary Operations]
- ① Please read "Cautions on Performing Secondary Operations" (Page 343) when performing modifications and/or secondary operations for safety concerns. KHK Quick-Mod Gears, the KHK system for quick modification of KHK stock gears, is also available.
 - ② Avoid performing secondary operations that narrow the tooth width, as it affects precision and strength.

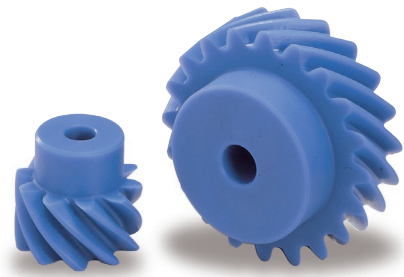

Specifications	
Precision grade	JIS grade N9 (JIS B1702-1:1998)
Reference section of gear	Normal plane
Gear teeth	Standard full depth
Normal pressure angle	20°
Helix angle	45°
Material	MC901
Heat Treatment	—

* The precision grade of these products is equivalent to the value shown in the table.

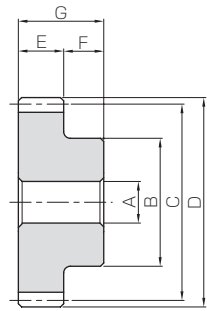

S1

Catalog Number	Module	No. of teeth	Direction of spiral	Shape	Bore	Hub dia.	Pitch dia.	Outside dia.	Face width	Hub width	Total Length
					A	B	C	D	E	F	G
PN1-13R PN1-13L	m1	13	R L	S1	6	15	18.38	20.38	10	10	20
PN1-15R PN1-15L		15	R L			18	21.21	23.21			
PN1-20R PN1-20L		20	R L			25	28.28	30.28			
PN1.5-10R PN1.5-10L	m1.5	10	R L	S1	6	16	21.21	24.21	15	10	25
PN1.5-13R PN1.5-13L		13	R L			23	27.58	30.58			
PN1.5-15R PN1.5-15L		15	R L			25	31.82	34.82			
PN1.5-20R PN1.5-20L		20	R L			30	42.43	45.43			
PN2-10R PN2-10L	m2	10	R L	S1	10	22	28.28	32.28	20	15	35
PN2-13R PN2-13L		13	R L			30	36.77	40.77			
PN2-15R PN2-15L		15	R L			35	42.43	46.43			
PN2-20R PN2-20L		20	R L			45	56.57	60.57			
PN2.5-10R PN2.5-10L	m2.5	10	R L	S1	10	26	35.36	40.36	22	16	38
PN2.5-13R PN2.5-13L		13	R L			35	45.96	50.96			
PN2.5-15R PN2.5-15L		15	R L			40	53.03	58.03			
PN2.5-20R PN2.5-20L		20	R L			60	70.71	75.71			
PN3-10R PN3-10L	m3	10	R L	S1	12	34	42.43	48.43	25	18	43
PN3-13R PN3-13L		13	R L			45	55.15	61.15			
PN3-15R PN3-15L		15	R L			50	63.64	69.64			
PN3-20R PN3-20L		20	R L			60	84.85	90.85			

Bending strength	Allowable torque (N-m)		Allowable torque (kgf-m)		Backlash (mm)	Weight (kg)	Catalog Number
	Surface durability	Bending strength	Surface durability	Bending strength			
—	0.19	—	0.019	—	0.18~0.32	0.0045	PN1-13R PN1-13L
	0.29		0.029		0.20~0.34	0.0064	PN1-15R PN1-15L
	0.66		0.068		0.012	PN1-20R PN1-20L	
—	0.29	—	0.029	—	0~0.38	0.0077	PN1.5-10R PN1.5-10L
	0.62		0.063			0.014	PN1.5-13R PN1.5-13L
	0.93		0.095			0.018	PN1.5-15R PN1.5-15L
	2.14		0.22			0.031	PN1.5-20R PN1.5-20L
—	0.66	—	0.068	—	0~0.42	0.018	PN2-10R PN2-10L
	1.42		0.14			0.034	PN2-13R PN2-13L
	2.14		0.22			0.046	PN2-15R PN2-15L
	4.84		0.49			0.081	PN2-20R PN2-20L
—	1.27	—	0.13	—	0~0.44	0.031	PN2.5-10R PN2.5-10L
	2.68		0.27			0.055	PN2.5-13R PN2.5-13L
	4.03		0.41			0.075	PN2.5-15R PN2.5-15L
	9.07		0.92			0.15	PN2.5-20R PN2.5-20L
—	2.14	—	0.22	—	0~0.52	0.054	PN3-10R PN3-10L
	4.51		0.46			0.094	PN3-13R PN3-13L
	6.75		0.69			0.12	PN3-15R PN3-15L
	15.0		1.53			0.21	PN3-20R PN3-20L

- [Caution on Product Characteristics]
- ① Significant variations in temperature or humidity can cause dimensional changes in plastic gears, including bore size (H8 when produced), tooth diameter, and backlash. Please see the section "Design of Plastic Gears" in our separate technical reference book. (Page 100).
 - ② When mating screw gears are made of the same material, they may cause abrasion and scoring. It is recommended to mate screw gears composed of different materials.
 - ③ The allowable torque shown in the table are calculated values according to the assumed usage conditions. Please see Page 342 for more details.
 - ④ The backlash values shown in the table are the theoretical values for the backlash in the normal direction of a pair of identical gears in mesh.
 - ⑤ For offset shaft applications, match a RH with a RH, or LH with a LH, to make a set of screw gears. For parallel shaft applications, mesh opposite hands (RH and LH) of helical gear sets. Please see Page 342 for more details.

- [Caution on Secondary Operations]
- ① Please read "Cautions on Performing Secondary Operations" (Page 343) when performing modifications and/or secondary operations for safety concerns. KHK Quick-Mod Gears, the KHK system for quick modification of KHK stock gears, is also available.
 - ② Avoid performing secondary operations that narrow the tooth width, as it affects precision and strength.
 - ③ Plastic gears are susceptible to the effects of temperature and moisture. Dimensional changes may occur while performing secondary operations and during post-machining operations.

* In regard to MC Nylon gears, other materials are available for plastic gears, including Ultra High Molecular Weight Polyethylene (U-PE), which has excellent abrasion resistance and resin conforming to the Plastic Implementation Measure (PIM). A single piece order is acceptable and will be produced as a custom-made gear. Please see Page 16 for more details on quotations and orders.



GCU-N Screw Gear Kit



Installation : Nonparallel and non-intersecting gears

Gear Type : Screw Gears

Gears : SN2.5-10R

PN2.5-10R

Gear Ratio : 1

Weight : Approx. 1kg

Screw Gears are helical gears used in nonparallel and nonintersecting situations. Applications include devices like conveyers with light loads.

*** This is not a gear box for actual use to transmit power. Please use only as representations of gear systems.**

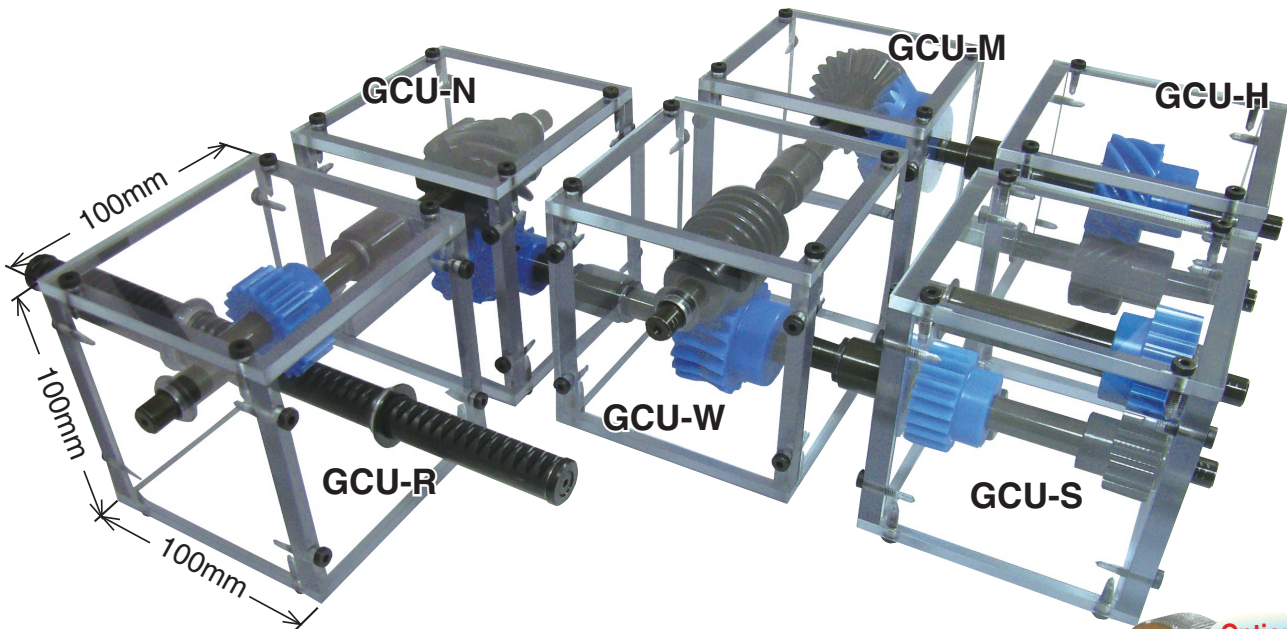

Please see Page 438 for more details.



- Spur Gears
- Helical Gears
- Internal Gears
- Racks
- CP Racks & Pinions
- Miter Gears
- Bevel Gears
- Screw Gears
- Worm Gear Pairs
- Bevel Gearboxes
- Other Products