



Service Data

SD-01-690

BENDIX® BA-921® COMPRESSOR

DESCRIPTION

The function of the air compressor is to provide and maintain air under pressure to operate devices in air brake systems. The Bendix® BA-921® compressor is a single-cylinder reciprocating compressor with a rated displacement of 15.8 cubic feet per minute at 1250 RPM.

The compressor consists of a water-cooled cylinder head assembly and an integral air-cooled crankcase assembly.

The cylinder head assembly is made up of the cylinder head, cooling plate and valve plate assembly and uses two sealing gaskets. Depending on the application, the cylinder head and cooling plate may be aluminum or cast iron. The cylinder head contains air and water ports as well as an unloader assembly. A cooling plate is located between the cylinder head and valve plate assemblies and assists in cooling.

The valve plate assembly consists of brazed steel plates which have valve openings and passages for air and engine coolant to flow into and out of the cylinder head. The compressor's discharge valves are part of the valve plate assembly. The inlet reed valve/gasket is installed between the valve plate assembly and the top of the crankcase.

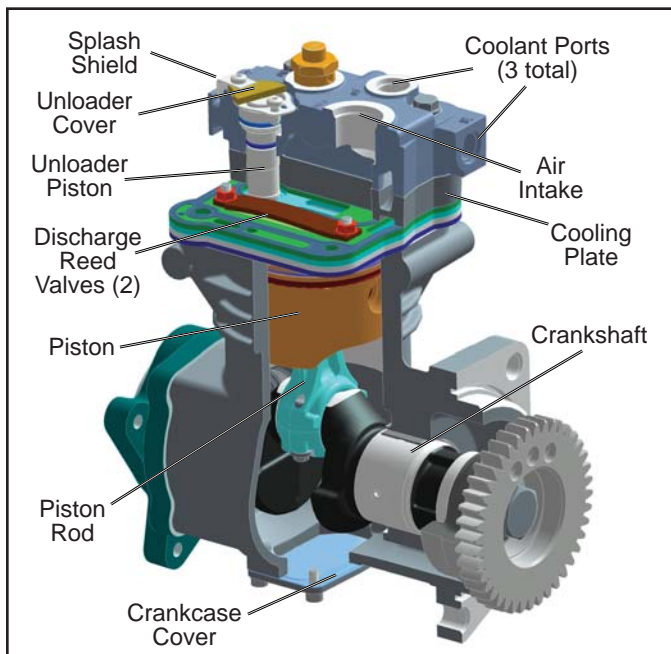

FIGURE 1 - BENDIX® BA-921® COMPRESSOR (CUT-AWAY)

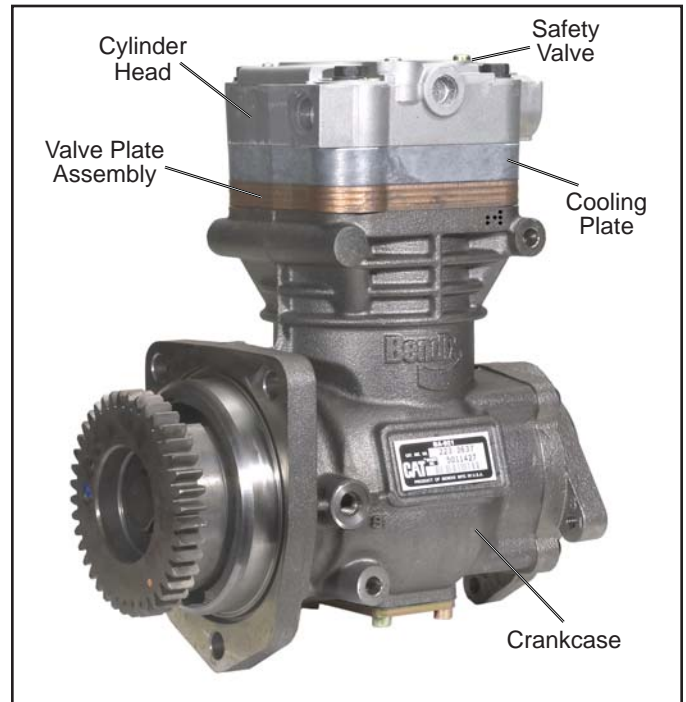

FIGURE 2 - BENDIX® BA-921® COMPRESSOR

The cast iron crankcase houses the piston assembly, connecting rod, crankshaft and related bearings.

All Bendix® BA-921® compressors are equipped with a safety valve to protect the compressor head in the event of, for example, a discharge line blockage downstream of the compressor. Excessive air pressure will cause the safety valve to unseat, release air pressure and give an audible alert to the operator. The safety valve is installed in the cylinder head safety valve port, directly connected to the cylinder head discharge port.

The crankcase cover located at the bottom of the crankcase is stamped with information identifying the compressor model, customer piece number, Bendix piece number and serial number. See Figures 2 and 3.

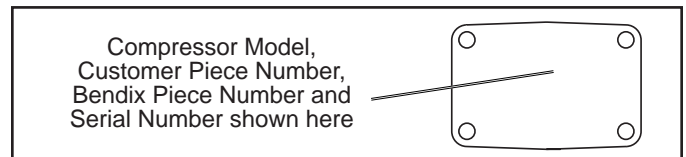

FIGURE 3 - CRANKCASE BASE COVER

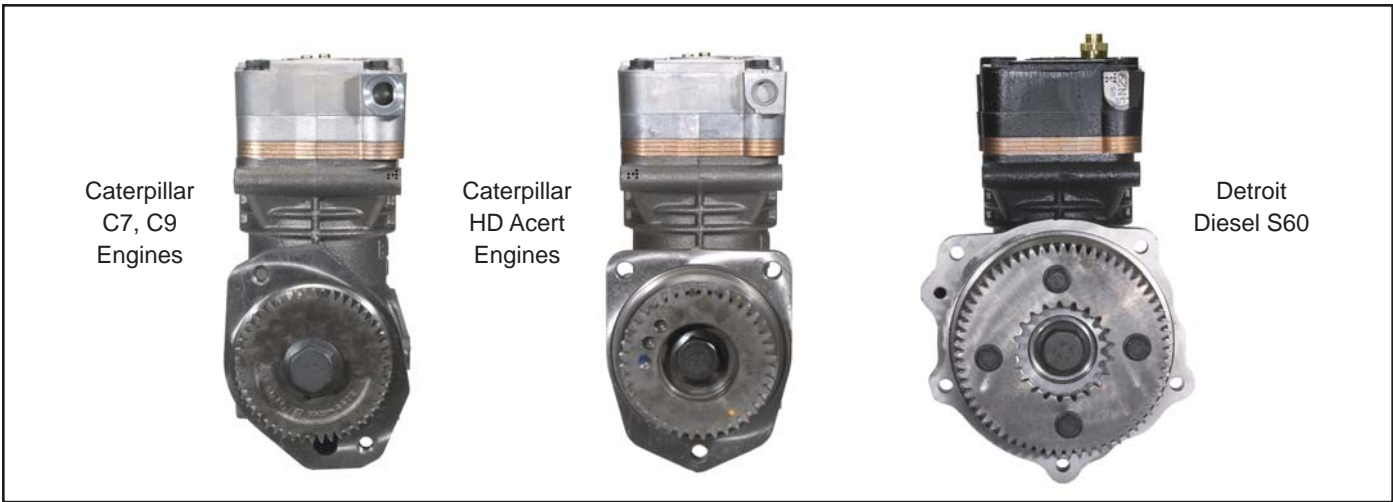

FIGURE 4 - TYPICAL COMPRESSOR DRIVE FLANGES

OPERATION

The compressor is driven by the vehicle's engine and functions continuously while the engine is in operation. Actual compression of air is controlled by the compressor unloading mechanism operating in conjunction with a governor.

AIR INTAKE (LOADED)

Just as the piston begins the down stroke, (a position known as top dead center, or TDC), the vacuum created in the cylinder bore above the piston causes the inlet reed valve to flex open. Atmospheric air (in naturally aspirated applications) or pressurized air (in turbocharged applications) flows through the open inlet valve and fills the cylinder bore above the piston. See Figure 5.

AIR COMPRESSION (LOADED)

When the piston reaches the bottom of the stroke, (a position known as bottom dead center, or BDC), the inlet reed valve closes. Air above the piston is trapped by the closed inlet reed valve and is compressed as the piston moves upwards. When air in the cylinder bore reaches a pressure greater than that of the system pressure, the discharge reed valves open and allow air to flow into the discharge line and air brake system.

At the same time air flows into the hollow center of the unloader piston through an opening in the end of the piston. Compressed air acts on the interior surfaces of the unloader piston and, along with the unloader piston spring, holds the unloader piston in the down position, against its seat on the valve plate. See Figure 7.

NON-COMPRESSON OF AIR (UNLOADED)

When air pressure in the supply reservoir reaches the cutout setting of the governor, the governor delivers system air to the compressor unloader port. Air entering the unloader port acts on the unloader piston causing the

piston to move upwards, away from its seat on the valve plate assembly. When the unloader piston is unseated an

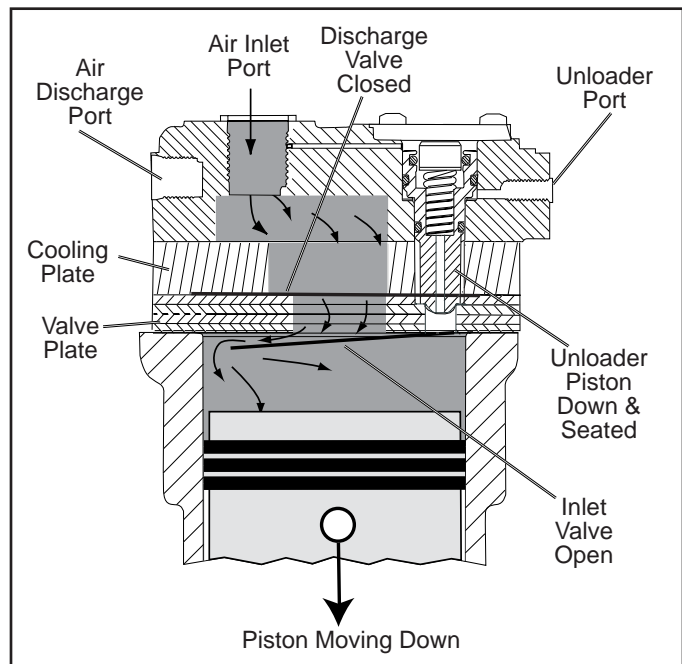

FIGURE 5 - OPERATION - LOADED (INTAKE)

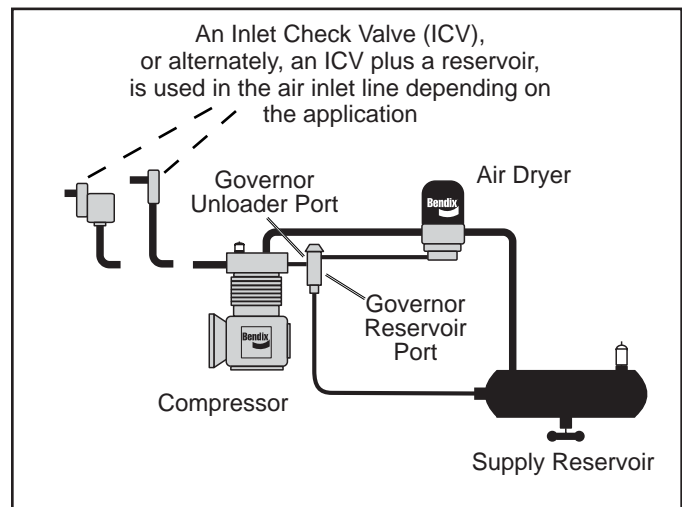

FIGURE 6 - BA-921® COMPRESSOR UNLOADER SYSTEM

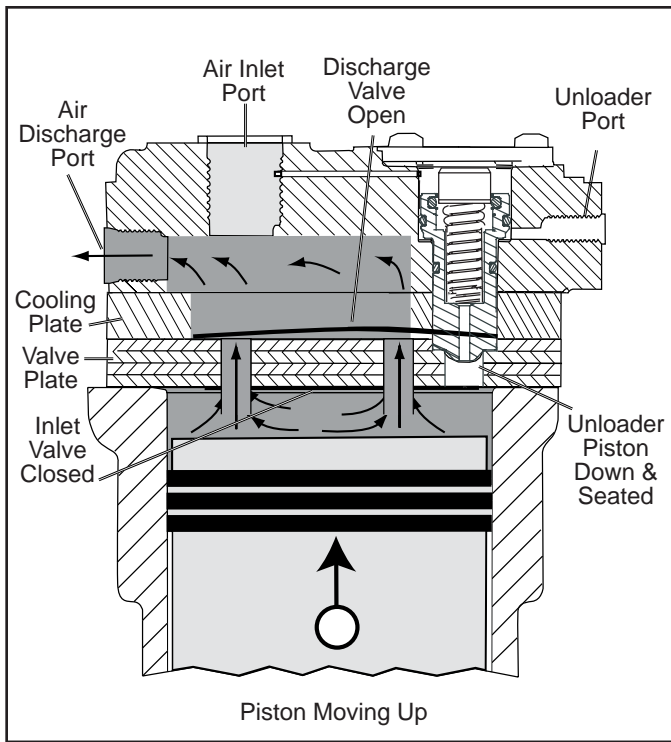

FIGURE 7 - OPERATION - LOADED (COMPRESSION)

air passageway is opened between the cylinder bore and the air inlet cavity in the cylinder head.

As the piston moves from bottom dead center (BDC) to top dead center (TDC) air in the cylinder bore flows past the unseated unloader piston, into the cylinder head inlet cavity and out the inlet port. To prevent the air from flowing back into the engine air induction system, an inlet check valve (ICV) is installed upstream of the air compressor inlet port. The location of the device and the way it is plumbed into the compressor air induction system is unique to the specific engine and the type of air induction (naturally aspirated or boosted air) the compressor uses. These air induction systems will be explained in further detail in the "Air Induction" section on page 4. On the piston down stroke (TDC to BDC) air flows in the reverse direction, from the inlet cavity past the unseated unloader piston and inlet reed valve, and into the cylinder bore.

LUBRICATION

The vehicle's engine provides a continuous supply of oil to the compressor. Oil is routed from the engine to the compressor's oil inlet. An oil passage in the crankshaft routes pressurized oil to the precision sleeve main bearings and to the connecting rod bearings. Spray lubrication of the cylinder bores, connecting rod wrist pin bushings, and ball type main bearings is obtained as oil is forced out around the crankshaft journals by engine oil pressure. Oil then falls to the bottom of the compressor crankcase and is returned to the engine through drain holes in the compressor mounting flange.

Lubrication for Caterpillar C11 and C13 engine applications

Bendix® BA-921® compressor - for Caterpillar C11 and C13 engine installations only - use an "oil jet" that sprays oil under the piston for purposes of cooling. This oil jet is part of a special crankcase cover that is used only on the BA-921® compressor for CAT C11 and C13 engine installations (see Figure 14).

This design slightly alters the flow of oil for lubrication. The oil supply line from the engine is directly connected to the back side of the special crankcase over. The oil flows in parallel through a passageway in the crankcase cover and through the oil jet to spray oil under pressure up onto the underneath of the piston for cooling. At the same time, oil flows out of the opposite end of the special crankcase cover, through a fitting and a metal tube and second fitting into the oil supply port of the compressor. At this point oil flows in a similar manner as in the first paragraph of this section.

COOLING

Bendix® BA-921® compressors are cooled by air flowing through the engine compartment as it passes the compressor's cast-in cooling fins and by the flow of engine coolant through the cylinder head. Coolant supplied by the engine cooling system passes through connecting lines into the cylinder head and passes through internal passages in the cylinder head, cooling plate and valve plate assembly and returns to the engine. Figure 9 illustrates the various approved coolant flow connections. Proper cooling is important in minimizing discharge air temperatures - see the tabulated technical data on page 14 of this manual for specific requirements.

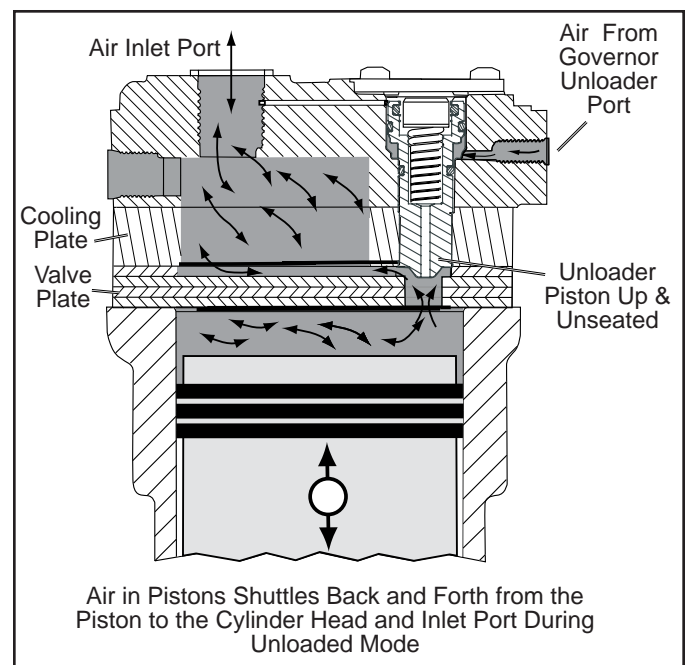

FIGURE 8 - OPERATION - UNLOADED

AIR INDUCTION

GENERAL

The Bendix® BA-921® air compressor can be used both with air induction systems that are naturally aspirated (atmospheric air) and pressurized (turbocharged). The following section covers Caterpillar and Detroit Diesel engine air induction arrangements. See Figure 4, for typical flanges used.

CATERPILLAR

Caterpillar HD ACERT engines (C11, C13, C15 and C18) and MD ACERT engines (C7 and C9) are typically equipped with Bendix® BA-921® compressors. These engines provide pressurized (turbocharged) air to the compressor's inlet port. Caterpillar recommends the use of an inlet check valve in the air induction system to prevent the air from the compressor being forced back into the engine air induction system when the compressor is operating in the "unloaded" condition (not building air). Because the compressor induction system is turbocharged, an additional air volume (reservoir) is required between the compressor inlet port and the inlet check valve to prevent excessive air pressure at the compressor inlet in the unloaded mode. Figures 10 and 11 show example of the different air induction systems used by Caterpillar to perform this function.

CATERPILLAR C7/C9 ENGINES

The Bendix® BA-921® compressor in the C7/C9 air induction system (see Figure 10) receives its air from the engine's intake manifold (turbocharged). During the pumping condition (loaded mode), the air flows from the engine intake manifold through the inlet check valve and inlet line to the compressor inlet port. During the non-pumping condition (unloaded mode), the compressor cylinder pushes air back out of the inlet port to the inlet check valve. The ICV prevents the air from traveling beyond this point. Because the air is boosted (under pressure), it is important that the compressor inlet line is of sufficient length, strength and volume to minimize the build-up of air pressure in the inlet system. The air shuttles back and forth between the compressor cylinder bore and the expansion tank during this phase of the compressor operation.

CATERPILLAR C11, C13, C15 AND C18 ENGINES

The Bendix® BA-921® compressor in the C11, C13, C15, and C18 air induction systems (see Figure 11) receives its air from the engine's intake manifold (turbocharged). During the pumping condition (loaded mode), the air flows from the engine intake manifold through the inlet check valve, expansion tank and inlet line to the compressor inlet port. During the non-pumping condition (unloaded mode), the compressor cylinder pushes air back out of the inlet port into the expansion tank. The ICV (at the end of the

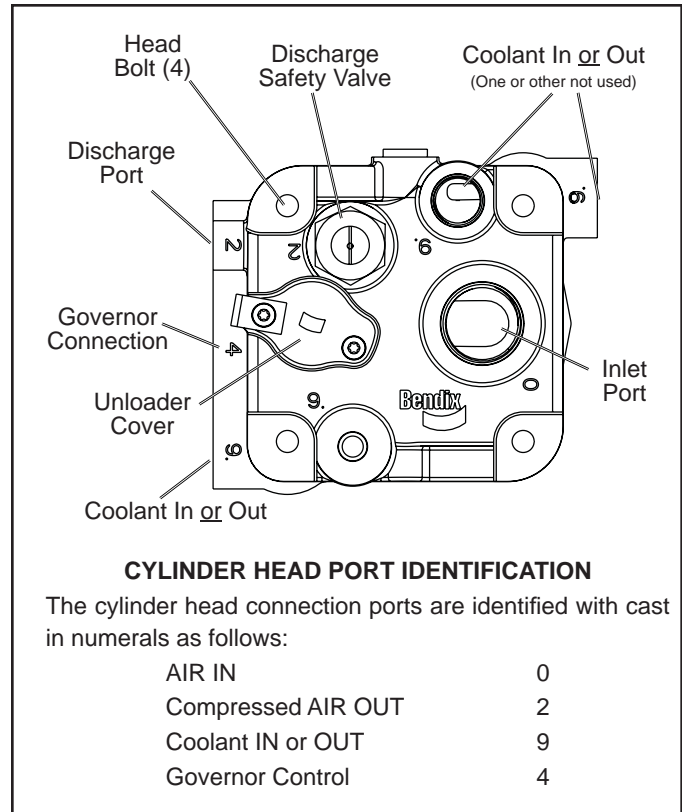

FIGURE 9 - TYPICAL BENDIX® BA-921® COMPRESSOR CYLINDER HEAD

expansion tank) prevents the air from traveling beyond this point. Because the air is boosted (under pressure), it is important that the compressor inlet line is of sufficient length, strength and volume to minimize the build-up of air pressure in the inlet system. The air shuttles back and forth between the compressor cylinder bore and the expansion tank during this phase of the compressor operation.

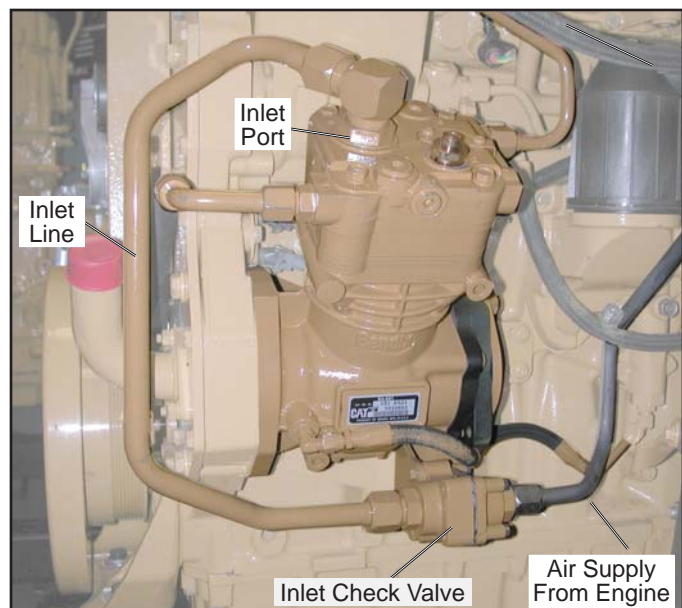

FIGURE 10 - EXAMPLE OF CATERPILLAR (ACERT ENGINE) C7/C9 COMPRESSOR AIR INDUCTION SYSTEM (TURBOCHARGED)

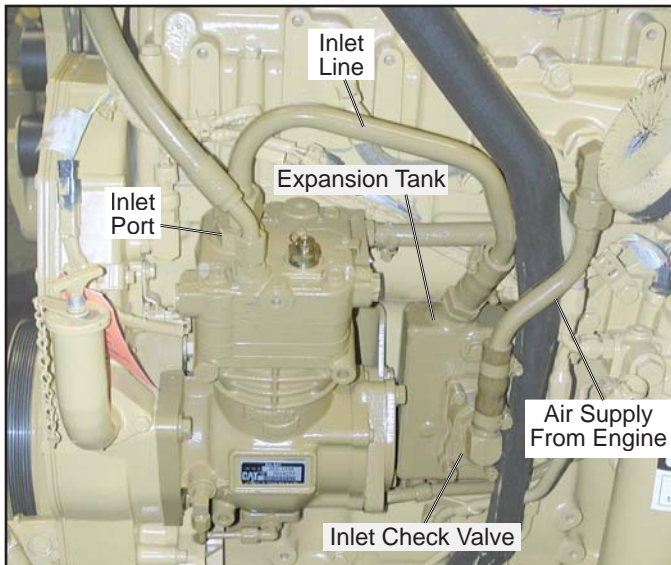

FIGURE 11 - EXAMPLE CATERPILLAR (HD ACERT ENGINE) C11/C13/C15/C18 COMPRESSOR AIR INDUCTION SYSTEM (TURBOCHARGED)

DETROIT DIESEL

The Detroit Diesel Series 60 (EGR) engine is equipped with the Bendix® BA-921® compressor and uses naturally aspirated air induction system. Detroit Diesel recommends the use of an inlet check valve in the air induction system to prevent the air from the compressor cylinder bore from being forced back into the engine air induction system when the compressor is in the unloaded mode (non-pumping condition). A flexible high-pressure hose is installed between the inlet check valve and the compressor inlet fitting. This hose can be of various lengths to accommodate the distance between the compressor and inlet check valve. See Figure 12.

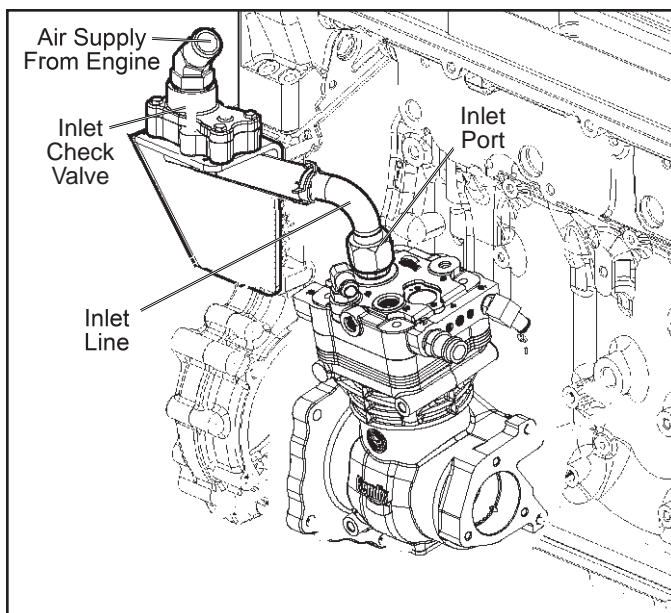

FIGURE 12 - EXAMPLE OF DETROIT DIESEL (EGR) S60 COMPRESSOR AIR INDUCTION SYSTEM (NATURALLY ASPIRATED)

During operation, non-pressurized air from the engine's air source is routed to the compressor from a point between the engine air filter and the non-pressure side of the turbocharger. When the compressor is building air (loaded mode), the air flows from the engine intake tube, through the inlet check valve into the inlet port of the compressor. When the compressor is not building air (unloaded mode), the compressor pushes the air back out the compressor during the cylinder upstroke towards the inlet check valve. The ICV prevents the air from traveling beyond this point. The air shuttles back and forth between the compressor cylinder bore and the ICV during this phase of the compressor operation.

PREVENTATIVE MAINTENANCE

Regularly scheduled maintenance is the single most important factor in maintaining the air brake charging system. Refer to Table A in the Troubleshooting section on page 17, for a guide to various considerations that must be given to maintenance of the compressor and other related charging system components.

Important Note: Review the warranty policy before performing any intrusive maintenance procedures. An extended warranty may be voided if intrusive maintenance is performed during this period.

EVERY 6 MONTHS, 1800 OPERATING HOURS OR AFTER EACH 50,000, MILES WHICHEVER OCCURS FIRST, PERFORM THE FOLLOWING INSPECTIONS AND TESTS.

AIR INDUCTION

The Bendix® BA-921® compressor is designed for connection to the vacuum side of the engine's air induction system and the pressure side (turbocharged) of the engine's air induction system.

A supply of clean air is one of the single most important factors in compressor preventive maintenance. Since the air supply for BA-921® compressor and engine is the engine air cleaner, periodic maintenance of the engine air filter is necessary.

Inspect the compressor air induction system each time engine air cleaner maintenance is performed.

1. Inspect the intake hose adapters for physical damage. Make certain to check the adapters at both ends of the intake hose or tubing.
2. Inspect the intake hose clamps and tighten them if needed.
3. Inspect the intake hose or line for signs of drying, cracking, chafing and ruptures and replace if necessary.
4. Verify that the compressor inlet fitting is tight (check torque).

5. Any metal tubes should also be tight (torqued properly) to the mating fitting. Inspect the metal tubes for any cracks or breaks and replace if necessary.
6. If an expansion tank is present (turbocharged air induction systems only), inspect any cracks and replace if necessary.

COMPRESSOR COOLING

Inspect the compressor discharge port, inlet cavity and discharge line for evidence of restrictions and carbon buildup. If more than 1/16" of carbon is found, thoroughly clean or replace the affected parts. In some case, carbon buildup indicates inadequate cooling. Closely inspect the compressor cooling system. Check all compressor coolant lines for kinks and restrictions to flow. Minimum coolant line size is 3/8" I.D. Check coolant lines for internal clogging from rust scale. If coolant lines appear suspicious, check the coolant flow and compare to the tabulated technical data present in the back of this manual. Carefully inspect the air induction system for restrictions.

LUBRICATION

Check the external oil supply line for kinks, bends, or restrictions to flow. Supply lines must be a minimum of 3/16" I.D. Refer to the tabulated technical data in the back of this manual for oil pressure minimum values.

Check the exterior of the compressor for the presence of oil seepage and refer to the TROUBLESHOOTING section for appropriate tests and corrective action.

Note: This is applicable only for Caterpillar engine installations. Detroit Diesel utilizes an internal oil feed design. No external oil supply line is used.

OIL PASSING

All reciprocating compressors pass a minimal amount of oil. Air dryers will remove the majority of oil before it can enter the air brake system. For particularly oil sensitive systems, the Bendix® PuraGuard® system can be use in conjunction with a Bendix® air dryer.

If compressor oil passing is suspected, refer to the TROUBLESHOOTING section and TABLE A for the symptoms and corrective action to be taken. In addition, Bendix has developed the "Bendix Air System Inspection Cup" or BASIC™ kit to help substantiate suspected excessive oil passing. The steps to be followed when using the BASIC™ kit are presented in APPENDIX A at the end of the TROUBLESHOOTING section.

COMPRESSOR DRIVE

Check for noisy compressor operation, which could indicate excessive drive component wear. Adjust and/or replace as necessary. Check all compressor mounting bolts and retighten evenly if necessary. Check for leakage and proper unloader mechanism operation. Repair or replace parts as necessary.

COMPRESSOR UNLOADER & GOVERNOR

Test and inspect the compressor and governor unloader system for proper operation and pressure setting.

1. Check for leakage at the unloader port. Replace leaking or worn o-rings.
2. Make certain the unloader system lines are connected as illustrated in Figure 6.
3. Cycle the compressor through the loaded and unloaded cycle several times. Make certain that the governor cuts-in (compressor resumes compressing air) at a minimum of 105psi (cut-out should be approximately 15 - 20psi greater than cut-in pressure). Adjust or replace the governor as required.
4. Note that the compressor cycles to the loaded and unloaded conditions promptly. If prompt action is not noted, repair or replace the governor and/or repair the compressor unloader.

IMPORTANT NOTE

Replacement air governors must have a minimum cut-in pressure of 100psi. The cut-in pressure is the lowest system pressure registered in the gauges before the compressor resumes compressing air.

Compressors with no signal line to the unloader port should have a vent cap (e.g. Bendix part number 222797) installed in the port. Under no circumstances should the port be plugged or left open.

SERVICE TESTS

GENERAL

The following compressor operating and leakage tests need not be performed on a regular basis. These tests should be performed when it is suspected that leakage is substantially affecting compressor buildup performance, or when it is suspected that the compressor is "cycling" between the loaded (pumping) and unloaded (non-pumping) modes due to unloader leakage.

IN SERVICE OPERATING TESTS

Compressor Performance: Build-up Test

This test is performed with the vehicle parked and the engine operating at maximum recommended governed speed. Fully charge the air system to governor cut out (air dryer purges). Pump the service brake pedal to lower the system air pressure below 80 psi using the dash gauges. As the air pressure builds back up, measure the time from when the dash gauge passes 85 psi to the time it passes 100 psi. The time should not exceed 40 seconds. If the vehicle exceeds 40 seconds, test for (and fix) any air leaks, and then re-test the compressor performance. If the vehicle does not pass the test the second time, use the Advanced Troubleshooting Guide for Air Brake Compressors, starting on page 15 of this document to assist your investigation of the cause(s).

Note: All new vehicles are certified using the FMVSS 121 test (paragraph S5.1.1) by the vehicle manufacturer, however the above test is a useful guide for in-service vehicles.

Optional Comparative Performance Check

It may be useful to also conduct the above test with the engine running at high idle (instead of maximum governed speed), and record the time taken to raise the system pressure a selected range (for example, from 90 to 120 psi, or from 100 to 120 psi, etc.) and record it in the vehicle's maintenance files. Subsequent build-up times throughout the vehicle's service life can then be compared to the first one recorded. (Note: the 40 second guide in the test above does not apply to this build-up time.) If the performance degrades significantly over time, you may use the Advanced Troubleshooting Guide for Air Brake Compressors, starting on page 15 of this document, to assist investigation of the cause(s).

Note: When comparing build-up times, be sure to make an allowance for any air system modifications which would cause longer times, such as adding air components or reservoirs. Always check for air system leakage.

LEAKAGE TESTS

See the standard Air Brake System and Accessory Leakage test on Page 28 (Test 2).

Note: Leakage in the air supply system (components before the supply reservoir - such as the governor, air dryer, reservoir drain cocks, safety valve and check valves) will not be registered on the vehicle dash gauges and must be tested separately. Refer to the various maintenance manuals for individual component leakage tests and the Bendix "Test and Checklist" published in the Air Brake System Handbook (BW5057) and on the back of the Dual Circuit Brake System Troubleshooting Card (BW1396).

CYLINDER HEAD

Check for cylinder head gasket air leakage.

1. With the engine running, lower air system pressure to 60 psi and apply a soap solution around the cylinder head. Check the gasket between the cylinder head and valve plate assembly and the inlet reed valve/gasket between the valve plate assembly and crankcase for air leakage.
2. No leakage is permitted. If leakage is detected replace the compressor or repair the cylinder head using a genuine Bendix maintenance kit available from an authorized Bendix parts outlet.

INLET, DISCHARGE & UNLOADER

In order to test the inlet and discharge valves and the unloader piston, it is necessary to have shop air pressure and an assortment of fittings. A soap solution is also required.

1. With the engine shut off, drain ALL air pressure from the vehicle.
2. Disconnect the inlet and discharge lines and remove the governor or its line or adapter fitting.
3. Apply 120-130 psi shop air pressure to the unloader port and soap the inlet port. Leakage at the inlet port should not exceed 50 sccm.
4. Apply 120-130 psi shop air pressure to the discharge port and then apply and release air pressure to the inlet port. Soap the inlet port and note that leakage at the inlet port does not exceed 20 sccm.

If excessive leakage is noted in Tests 3 or 4, replace or repair the compressor using genuine Bendix replacements or maintenance kits available from any authorized Bendix parts outlet.

While it is possible to test for inlet, discharge, and unloader piston leakage, it may not be practical to do so. Inlet and discharge valve leakage can generally be detected by longer compressor build-up and recovery times. Compare current compressor build-up times with the last several recorded times. Make certain to test for air system leakage, as described under In Service Operating Tests, before making a determination that performance has been lost.

Unloader leakage is generally exhibited by excessive compressor cycling between the loaded and unloaded condition.

1. With service and supply system leakage below the maximum allowable limits and the vehicle parked, bring system pressure to governor cut-out and allow the engine to idle.

- The compressor should remain unloaded for a minimum of 5-10 minutes. If compressor cycling occurs more frequently and service and supply system leakage is within tolerance replace the compressor or repair the compressor unloader system using a genuine Bendix maintenance kit available from authorized Bendix parts outlets.

COMPRESSOR REMOVAL & DISASSEMBLY

GENERAL

The following disassembly and assembly procedure is presented for reference purposes and presupposes that a rebuild or repair of the compressor is being undertaken. Several maintenance kits are available and the instructions provided with these parts and kits should be followed in lieu of the instructions presented here.

MAINTENANCE KITS & SERVICE PARTS

Cylinder Head Gasket Kit.....	5008558
Unloader Kit.....	5008557
Governor Adapter Kit.....	5008561
Compressor Seal Kit (crankcase).....	5008559
Components and kits for Caterpillar Engines	
CAT C7/C9 Inlet Check Valve.....	801580
CAT C11/C13/C15/C18 Inlet Check Valve.....	801592
CAT C7/C9 Engine Seal Kit.....	5012367
CAT C11/C13/C15/C18 Engine Seal Kit.....	5012369
CAT ST-4 Discharge Safety Valve (7/8"-14 thrd.).....	801116
Components and kits for DDC Engines	
DDC Inlet Check Valve.....	802192
DDC Series 60 Engine Seal Kit.....	5012371
DDC ST-4 Discharge Safety Valve (M16-1.5 thrd.).....	800534

IMPORTANT! PLEASE READ AND FOLLOW THESE INSTRUCTIONS TO AVOID PERSONAL INJURY OR DEATH:

When working on or around a vehicle, the following general precautions should be observed at all times:

- Park the vehicle on a level surface, apply the parking brakes, and always block the wheels. Always wear safety glasses. Where specifically directed, the parking brakes may have to be released, and/or spring brakes caged, and this will require that the vehicle be prevented from moving by other means for the duration of these tests/procedures.**
- Stop the engine and remove ignition key when working under or around the vehicle. When working in the engine compartment, the engine should be shut off and the ignition key should be removed. Where circumstances require that the engine be in operation, EXTREME CAUTION should**

be used to prevent personal injury resulting from contact with moving, rotating, leaking, heated or electrically charged components.

- Do not attempt to install, remove, disassemble or assemble a component until you have read and thoroughly understand the recommended procedures. Use only the proper tools and observe all precautions pertaining to use of those tools.**
- If the work is being performed on the vehicle's air brake system, or any auxiliary pressurized air systems, make certain to drain the air pressure from all reservoirs before beginning ANY work on the vehicle. If the vehicle is equipped with an AD-IS® air dryer system or a dryer reservoir module, be sure to drain the purge reservoir.**
- Following the vehicle manufacturer's recommended procedures, deactivate the electrical system in a manner that safely removes all electrical power from the vehicle.**
- Never exceed manufacturer's recommended pressures.**
- Never connect or disconnect a hose or line containing pressure; it may whip. Never remove a component or plug unless you are certain all system pressure has been depleted.**
- Use only genuine Bendix® replacement parts, components and kits. Replacement hardware, tubing, hose, fittings, etc. must be of equivalent size, type and strength as original equipment and be designed specifically for such applications and systems.**
- Components with stripped threads or damaged parts should be replaced rather than repaired. Do not attempt repairs requiring machining or welding unless specifically stated and approved by the vehicle and component manufacturer.**
- Prior to returning the vehicle to service, make certain all components and systems are restored to their proper operating condition.**
- For vehicles with Antilock Traction Control (ATC), the ATC function must be disabled (ATC indicator lamp should be ON) prior to performing any vehicle maintenance where one or more wheels on a drive axle are lifted off the ground and moving.**

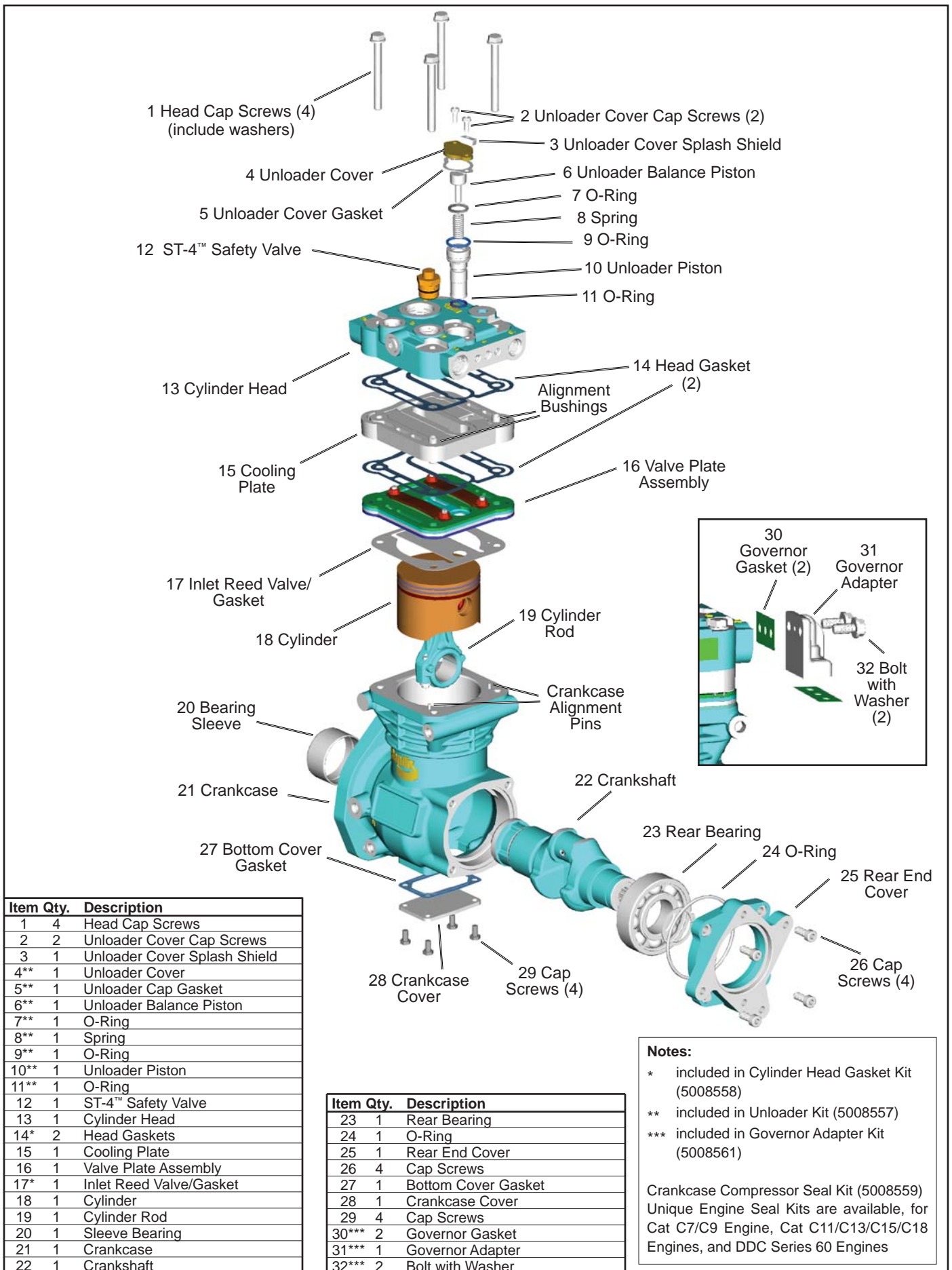

FIGURE 13 – BA-921® COMPRESSOR EXPLODED VIEW

REMOVAL

In many instances it may not be necessary to remove the compressor from the vehicle when installing the various maintenance kits and service parts. The maintenance technician must assess the installation and determine the correct course of action.

These instructions are general and are intended to be a guide. In some cases additional preparations and precautions are necessary. In all cases follow the instructions contained in the vehicle maintenance manual in lieu of the instructions, precautions and procedures presented in this manual.

1. Block the wheels of the vehicle and drain the air pressure from all the reservoirs in the system.
2. Drain the engine cooling system and the cylinder head of the compressor. Identify and disconnect all air, water and oil lines leading to the compressor.
3. Remove as much road dirt and grease from the exterior of the compressor as possible.
4. Remove the discharge and inlet fittings, if applicable, and note their position on the compressor to aid in reassembly.

Note: If a cylinder head maintenance kit is being installed, stop here and proceed to PREPARATION FOR DISASSEMBLY. If replacing the compressor continue.

5. Remove any supporting bracketing attached to the compressor and note their positions on the compressor to aid in reassembly.
6. Remove the front flange mounting bolts and remove the compressor from the vehicle.
7. Inspect drive gear and associated drive parts for visible wear or damage. If the compressor drive gear is worn or damaged, the compressor must be replaced. Refer the Engine Manufacturers service manual to address the associated engine drive parts.
8. If the compressor is being replaced stop here and proceed to "Installing the Compressor" at the end of the assembly procedure. (Note: Replacement compressors come with the drive gear pre-assembled on the compressor.)

PREPARATION FOR DISASSEMBLY

Remove the balance of road dirt and grease from the exterior of the compressor with a cleaning solvent. If a rear end cover or end cover adapter is used on the compressor being worked on, mark it in relation to the crankcase. It is recommended, but not specifically necessary, to mark the relationships of the cylinder head (13), cooling plate (15), valve plate assembly (16), and crankcase (21).

A convenient method to indicate the above relationships is to use a metal scribe to mark the parts with numbers or

lines. Do not use marking methods such as chalk that can be wiped off or obliterated during rebuilding.

Prior to disassembly make certain that the appropriate kits and or replacement parts are available. Refer to Figure 13 during the entire disassembly and assembly procedure.

What follows is a description of a complete disassembly, actual maintenance may only need to include portions of these instructions.

CYLINDER HEAD

1. Remove the discharge safety valve (12) from the cylinder head (13).
2. To restrain the spring force exerted by balance piston spring (8) of the unloader assembly, hold the unloader cover (4) in place while removing the two unloader cover cap screws (2) and spray shield (3). Carefully release the hold on the unloader cover until the spring force is relaxed, then remove the unloader cover.
3. Remove the unloader cover gasket (5).
4. Remove the balance piston (6), its spring (8) and the unloader piston (10) along with its o-rings (7, 9 & 11) from the cylinder head (13).
5. Remove the four hex head bolts (1) from the cylinder head.
6. Gently tap the cylinder head, cooling plate (15) and valve plate assembly (16) with a soft mallet to break the gasket seal between the valve plate assembly and the crankcase (21). Lift the cylinder head with cooling plate and valve plate assembly off the crankcase.
7. Remove the metal inlet reed valve/gasket (17).
8. Gently tap the cylinder head, cooling plate and valve plate assembly with a soft mallet to break the gasket seals. Then separate the cylinder head from the cooling plate (15) and valve plate assembly and remove the two gaskets (14) between them.

CRANKCASE COVER

1. Remove the four crankcase cover cap screws (29) securing the crankcase cover (28) to the crankcase (21). Using a soft mallet, gently tap the crankcase cover to break the gasket seal. Remove the crankcase cover gasket (27).
2. In the case of the Caterpillar C11 and C13 engine application, the BA-921[®] compressor utilizes an "oil jet" that sprays oil under the piston for purposes of cooling. This oil jet is part of a special crankcase cover that is used strictly on the BA-921[®] compressor for the C11 and C13 engine installation (Figure 11). Refer to section OPERATION – Lubrication for description of the system. To disassemble, follow the instructions below.

- a. Remove the oil supply line from the engine at the inlet to the special crankcase cover.
- b. Remove the metal oil supply tube at the compressor oil supply port and at the outlet fitting of the special crankcase cover.

NOTE: Mark position of the special crankcase cover. It must be re-installed with the same orientation to assure proper operation of the oil jet.

- c. Remove the four crankcase cover cap screws securing the special crankcase cover to the crankcase. Using a soft mallet, gently tap the crankcase cover to break the gasket seal. Remove the crankcase cover gasket (27).

REAR END COVER

1. Remove the four end cover cap screws (26) that secure the rear end cover to the crankcase.
2. Remove the rear end cover from the crankcase. Remove the o-ring seal (24) from the end cover.

CLEANING OF PARTS

GENERAL

All parts should be cleaned in a good commercial grade of solvent and dried prior to inspection.

CYLINDER HEAD ASSEMBLY

1. Carefully remove all gasket material adhering to the cylinder head (13), cooling plate (15), valve plate assembly (16) and cast iron crankcase (21). Make certain not to scratch or mar the gasket surfaces. Pay particular attention to the gasket surfaces of the head.
2. Remove carbon deposits from the discharge and inlet cavities of the cylinder head, cooling plate and valve plate assembly. They must be open and clear in both assemblies. Make certain not to damage the head.
3. Remove rust and scale from the cooling cavities and passages in the cylinder head, cooling plate and valve plate assembly and use shop air to clear debris from the passages.
4. Check the threads in all cylinder head ports for galling (e.g. abrasion, chafing). Minor thread chasing (damage) is permitted.
5. Make certain the unloader vent passage under the unloader cover (4) in the head is open and free of debris.

INSPECTION OF PARTS

CYLINDER HEAD, COOLING PLATE, VALVE PLATE ASSEMBLY AND UNLOADER MECHANISM

1. Carefully inspect the head gasket surfaces on the cylinder head (13) for deep gouges and nicks. Also, inspect the cylinder head for any cracks or port thread damage. If detected, the compressor must be replaced. If large amounts of carbon build-up are present in the discharge cavity such that it restricts the air flow through the cylinder head, the compressor should be replaced.
2. Carefully inspect both sides of the head gasket surfaces on the cooling plate (15) for deep gouges and nicks. Also, inspect the cooling plate for any cracks or other damage. If found, the compressor must be replaced.
3. Carefully inspect the valve plate assembly (16) gasket surfaces (both sides) for deep gouges and nicks. Pay particular attention to the gasket surface. An inlet reed valve/gasket (17) is used between the valve plate assembly and crankcase. This gasket surface must be smooth and free of all but the most minor scratches. If excessive marring or gouging is detected, the compressor must be replaced. If large amounts of carbon build-up are present on the two main surfaces, in the two discharge valve holes or between the discharge valve and the discharge seat, the compressor should be replaced.
4. If the unloader assembly has been removed from the cylinder head, the unloader assembly must be serviced using an unloader kit (5008557).
5. If large amounts of carbon build-up are present on the unloader piston (10) seat or orifice or if the return spring exhibits compression set, the unloader components must be replaced with an unloader kit.

REAR END COVER

Check for cracks and external damage. Check the crankshaft rear bearing diameter in the rear end cover (25) for excessive wear, flat spots or galling. Check the rear support bracket threaded holes and hydraulic pump attachment threaded holes (if present) for thread damage. Minor thread chasing is permitted but do not re-cut the threads. If any of these conditions are found, replace the compressor.

CRANKCASE

Check the cylinder head gasket surface on the deck (top) of the crankcase (21) for nicks, gouges, and marring. A metal gasket is used to seal the cylinder head to the crankcase. This surface must be smooth and free of all but the most minor scratching. If excessive marring or gouging is detected, the compressor must be replaced.

ASSEMBLY

General Note: All torques specified in this manual are assembly torques and typically can be expected to fall off after assembly is accomplished. Do not re-torque after initial assembly torques fall unless instructed otherwise. A compiled listing of torque specifications is presented on page 14.

INCH POUNDS TO FOOT POUNDS

To convert inch pounds to foot pounds of torque, divide inch pounds by 12.

Example: $\frac{12 \text{ Inch Pounds}}{12} = 1 \text{ Foot Pound}$

FOOT POUNDS TO INCH POUNDS

To convert foot pounds to inch pounds of torque, multiply foot pounds by 12.

Example: $1 \text{ Foot Pound} \times 12 = 12 \text{ Inch Pounds}$

CRANKCASE COVER

1. Position the crankcase cover gasket (27) on either the crankcase or crankcase cover and install the crankcase cover on the crankcase using the four cap screws. "Snug" all four cap screws then torque to 62-71 inch pounds (7-8 Nm) using a crossing pattern.
2. In the case of the Caterpillar C11 and C13 engine application, the compressor utilizes an "oil jet" that sprays oil under the piston for purposes of cooling. This oil jet is part of a special crankcase cover that is used strictly on the compressor for the C11 and C13 engine installation (Figure 14). Refer to section OPERATION – Lubrication for description of the system. To re-assemble, follow the instructions below.
 - a. Position the gasket (27) on either the crankcase or the special crankcase cover and install the special crankcase cover on the crankcase using the four cap screws. Note: Make sure that the cover is orientated in its original position. "Snug" all four cap screws then torque to 62-71 inch pounds (7-8 Nm) using a crossing pattern.
 - b. Assuming that the fittings at the outlet of the special crankcase cover and compressor oil supply port had not been removed (fittings still torqued in place), position both ends of the metal tube over the two fittings and run the fittings down to finger tight then torque to 130 - 150 inch pounds (16 – 17.5 Nm). If a torque wrench is not available, run fittings down to finger tight. Then tighten the fittings $\frac{1}{4}$ to $\frac{1}{2}$ turns.

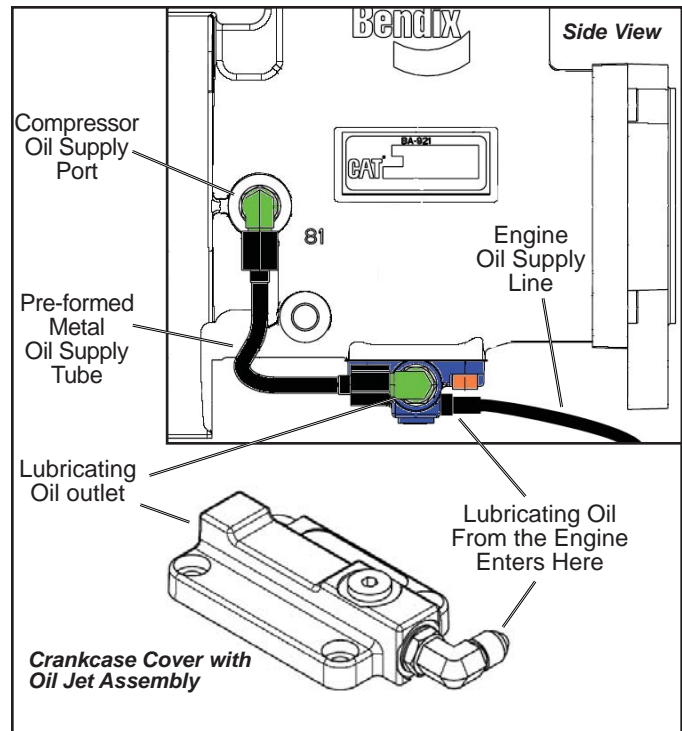

FIGURE 14 – VIEWS OF SPECIAL CRANKCASE COVER WITH OIL JET ASSEMBLY FOR CAT C11/C13 ENGINE APPLICATIONS

REAR END COVER (If Present)

1. Install the o-ring (24) on the rear end cover.
2. Orient the rear end cover (25) to the crankcase using the reference marks made during disassembly. Carefully install the rear end cover in the crankcase making certain not to damage the crankshaft bearing surface.
3. Install the four end cover cap screws (26) or studs. "Snug" the screws then tighten to 195 to 213 inch pounds (22-24 Nm) using a crossing pattern.

CYLINDER HEAD

1. Note the position of the protruding crankcase alignment pins on the deck (top) of the crankcase (21). Install the metal inlet reed valve/gasket (17) over the alignment pins on the crankcase.
2. Position the valve plate assembly (16) on the crankcase so that the alignment pins in the crankcase fit into the corresponding holes in the valve plate assembly.
3. Position one of the embossed metal head gaskets (14) over the alignment bushings protruding from the cooling plate. Position the second embossed metal head gasket over the alignment bushings on the opposite side of the cooling plate (15). When properly positioned, the outline of the two embossed gaskets match the outline of the cooling plate.

4. Install the cooling plate with the head gaskets onto valve plate assembly by lining up the alignment bushings on the cooling plate over oversized countersunk holes of the valve plate assembly. Again, when properly installed, the outline of the cooling plate matches the outline of the valve plate assembly.
5. Position and install the cylinder head (13) over the alignment bushings protruding from the cooling plate. When properly installed, the outline of the cylinder head assembly will match the outline of the cooling plate and valve plate assembly.

Note: To assist with correct installation, the alignment bushings only fit into two of the four cylinder head bolt holes.

6. Install the four hex head cylinder head bolts (1) and snug them, then tighten evenly to a torque of 265 to 292 inch pounds (30-33 Nm) using a crossing pattern.
7. Apply a coating of the lubricant provided in the unloader kit into the unloader bore (both diameters). Apply additional lubricant to the three o-ring grooves on the unloader piston (10). Note that the o-ring (7) installs inside the top of the unloader piston. Install the three o-rings (7, 9, 11) into the appropriate o-ring grooves on the unloader piston (10). Apply another coating of the lubricant onto the exposed o-ring surfaces and onto the large diameter of the balance piston (6). Install the unloader piston with the pre-installed o-rings into the cylinder head unloader bore making certain not to damage them in the process.
8. Install the balance piston spring (8) in the unloader piston.
9. Apply a coating of lubricant to the largest diameter of the balance piston. Install the small diameter end of the balance piston through the center of the spring.
10. Install the unloader cover gasket (5) on the cylinder head making certain both screw holes align.
11. Position the unloader cover (4) on top of the balance piston making certain the stamped logo is visible.
12. Press and hold the unloader cover in place on the cylinder head, place the spray shield (3) over the outboard hole (in order to cover the vent slot in the unloader cap). Install both unloader cover cap screws (2). Torque the cover cap screws (2) to 62 to 71 inch pounds (7-8 Nm).

INSTALLING THE COMPRESSOR

1. Install the appropriate gasket or o-ring on the front flange of the compressor. Make certain oil supply or return holes in the gasket are properly aligned with the compressor and engine. On the Detroit Diesel S60 engine installations, an additional o-ring is required to seal the oil feed passageway between the compressor and engine gear case cover. Gasket sealants are

not recommended. Secure the compressor on the engine and tighten the mounting bolts per Engine Manufacturers recommended torque requirements.

2. Install any supporting brackets on the compressor in the same position(s) noted and marked during removal. If a rear support bracket was on the original installation, hand tighten the bolts on both ends before torquing the bolts. Note: It is important that the rear support bracket is flush to both surfaces before the bolts are torqued.
3. Inspect all air, oil, and coolant lines and fittings before reconnecting them to the compressor. Make certain o-ring seals are in good or new condition, the threads are clean and the fittings are free of corrosion. Replace as necessary.
4. Install the discharge, inlet, coolant and governor adapter fittings, if applicable, in the same position on the compressor noted and marked during disassembly. See the Torque Specifications for various fitting sizes and types of thread at the rear of this manual. Tighten all hose clamps.
5. Before returning the vehicle to service, perform the Operation and Leakage Tests specified in this manual. Pay particular attention to all lines and hoses disconnected during the maintenance and check for air, oil, and coolant leaks at compressor connections. Also check for noisy operation.

TESTING THE REBUILT COMPRESSOR

In order to properly test a compressor under operating conditions, a test rack for correct mounting, cooling, lubricating, and driving the compressor is necessary. Such tests are not compulsory if the unit has been carefully rebuilt by an experienced person. A compressor efficiency or build-up test can be run which is not too difficult. An engine lubricated compressor must be connected to an oil supply line of at least 15psi pressure during the test and an oil return line must be installed to keep the crankcase drained. Connect to the compressor discharge port, a reservoir with a volume of 1500 cubic inches, including the volume of the connecting line. With the compressor operating at 2100 RPM, the time required to raise the reservoir(s) pressure from 85 psi to 100 psi should not exceed 5 seconds. During this test, the compressor should be checked for gasket leakage and noisy operation, as well as unloader operation and leakage. If the compressor functions as indicated, reinstall on the vehicle connecting all lines as marked in the disassembly procedure.

BA-921® COMPRESSOR SPECIFICATIONS

Typical weight	37 lbs.
Number of cylinders	1
Bore Diameter	3.622 in. (92 mm)
Stroke	2.126 in. (54 mm)
Calculated displacement at 1250 RPM	15.8 CFM
Flow Capacity @ 1800 RPM & 120 PSI	11.6 CFM
Flow Capacity @ 3000 RPM & 120 PSI	16.5 CFM
Approximate horsepower required:	
Loaded 1800 RPM at 120 PSIG.....	4.6 HP
Unloaded 1800 RPM.....	0.8 HP
Minimum coolant flow at maximum RPM	2.5 Gals./Min.
Maximum inlet air temperature	250°F
Maximum discharge air temperature	400°F
Minimum oil pressure required	15 PSI
Minimum oil-supply line size	3/16" I.D.
Minimum unloader-line size	3/16" I.D.
Minimum Governor Cut-out Pressure.....	120 PSI

TORQUE SPECIFICATIONS

Assembly Torques in inch pounds (in. lbs.)

M8x1.25-6g Cylinder Head.....	265-292 In. Lbs. (30-33 Nm)
M5x0.75-6g Unloader Cap	62-71 In. Lbs. (7-8 Nm)
M8x1.25-6g Governor Adapter.....	195-213 In. Lbs. (22-24 Nm)
M8x1.25-6g Rear End Cover.....	195-213 In. Lbs. (22-24 Nm)
M6x1.00-6g Crankcase Cover	62-71 In. Lbs. (7-8 Nm)
Inlet Port Fittings	
1 3/16"-12 UN-2B (Aluminum Cylinder Head)	
straight fitting.....	841-925 In. Lbs. (95-104 Nm)
adjustable (w/ jam nut).....	597-655 In. Lbs. (67-74 Nm)
M27x2-6g (Cast Iron Cylinder Head).....	885-980 In. Lbs. (100-111 Nm)
Discharge Port Fittings	
7/8"-14 UNF-2B (Aluminum Cylinder Head)	
straight fitting.....	509-553 In. Lbs. (57-62 Nm)
adjustable (w/ jam nut).....	354-389 In. Lbs. (40-44 Nm)
M22 x 1.5-6g (Cast Iron Cylinder Head).....	531-575 In. Lbs. (60-65 Nm)
Water Port Fittings	
3/4"-16 UNF-2B (Aluminum Cylinder Head)	
straight fitting.....	265-292 In. Lbs. (30-33 Nm)
adjustable (w/ jam nut).....	248-274 In. Lbs. (28-31 Nm)
M18 x 1.5-6g (Cast Iron Cylinder Head).....	354-395 In. Lbs. (40-45 Nm)
Unloader Port Fittings	
1/8"-27 NPT	2 - 3 TFFT ¹
M10 x 1.5-6g.....	120-145 In. Lbs. (14-16 Nm)
Safety Valve Port	
7/8"-14 UNF-2B	230-257 In. Lbs. (26-29 Nm)
M16x1.5-6H	230-257 In. Lbs. (26-29 Nm)
Oil Port	
7/16"-16 UNF	150-170 In. Lbs. (17-19 Nm)

Special Attachments – Cat C11/C13 Engine Crankcase Cover
w/ Oil Jet and Associated Hardware (Figure 14)

1) Crankcase Cover (In/Out) Oil Fittings

7/16"-16 UNF

150-170 In. Lbs. (17-19 Nm)

2) Compressor Oil Supply Fitting

7/16"-16 UNF

150-170 In. Lbs. (17-19 Nm)

3) Metal Tube (Tube Ends)

7/16"-16 UNF

130-150 In. Lbs. (16-17.5 Nm)

Option: Run fittings down finger tight. Tighten ¼ to ½ turns.

¹ Note: TFFT = Turns From Finger Tight

Advanced Troubleshooting Guide for Air Brake Compressors

INDEX

Symptom	Page Number	Symptom	Page Number
Air		Coolant	
Air brake charging system:		Compressor leaks coolant (17.0).....	27
Slow build (9.0)	23 - 24	Engine	
Doesn't build air (10.0).....	25	Oil consumption (6.0)	23
Air dryer:		Oil	
Doesn't purge (14.0)	26	Oil Test Card results (1.0).....	18
Safety valve releases air (12.0)	26	Oil is present:	
Compressor:		On the outside of the compressor (2.0)	19
Constantly cycles (15.0)	26	At the air dryer purge/exhaust	
Leaks air (16.0).....	27	or surrounding area (3.0).....	19
Safety valve releases air (11.0)	25	In the supply reservoir (4.0)	20 - 22
Noisy (18.0)	27	At the valves (5.0).....	22
Reservoir:		At air dryer cartridge (7.0).....	23
Safety valve releases air (13.0)	26	In the ping tank or compressor	
		discharge aftercooler (8.0).....	23

Test Procedures

- (1) Oil Leakage at Head Gasket 28
- (2) System Leakage 28
- (3) Compressor Discharge and
 Air Dryer Inlet Temperature 29
- (4) Governor Malfunction 28
- (5) Governor Control Line 29
- (6) Compressor Unloader 29
- BASIC™ Test Information 30-32

Maintenance & Usage Guidelines

- Maintenance Schedule and
Usage Guidelines (Table A) 17

Introduction to the Air Brake Charging System

Powered by the vehicle engine, the **air compressor** builds the air pressure for the air brake system. The air compressor is typically cooled by the engine coolant system and lubricated by the engine oil supply.

The compressor's unloader mechanism and **governor** (along with a synchro valve for the Bendix® DuraFlo™ 596 air compressor) control the brake system air pressure between a preset maximum and minimum pressure level by monitoring the pressure in the service (or “supply”) reservoir. When the air pressure becomes greater than that of the preset “cut-out”, the governor controls the unloader mechanism of the compressor to stop the compressor from building air and also causes the air dryer to purge. As the service reservoir air pressure drops to the “cut-in” setting of the governor, the governor returns the compressor back to building air and the air dryer to air drying mode.

As the atmospheric air is compressed, all the water vapor originally in the air is carried along into the air system, as well as a small amount of the lubricating oil as vapor.

The **duty cycle** is the ratio of time the compressor spends building air to the total engine running time. Air compressors are designed to build air (run “loaded”) up to 25% of the time. Higher duty cycles cause conditions that affect air brake charging system performance which may require additional maintenance. Factors that add to the duty cycle are: air suspension, additional air accessories, use of an undersized compressor, frequent stops, excessive leakage from fittings, connections, lines, chambers or valves, etc. The **discharge line** allows the air, water-vapor and oil-vapor mixture to cool between the compressor and air dryer. The typical size of a vehicle's discharge line, (see column 2 of Table A on page 17) assumes a compressor

with a normal (less than 25%) duty cycle, operating in a temperate climate. See Bendix and/or other air dryer manufacturer guidelines as needed.

When the **temperature** of the compressed air that enters the air dryer is within the normal range, the air dryer can remove most of the charging system oil. If the temperature of the compressed air is above the normal range, oil as oil-vapor is able to pass through the air dryer and into the air system. Larger diameter discharge lines and/or longer discharge line lengths can help reduce the temperature.

The discharge line must maintain a **constant slope** down from the compressor to the air dryer inlet fitting to avoid low points where ice may form and block the flow. If, instead, ice blockages occur at the air dryer inlet, insulation may be added here, or if the inlet fitting is a typical 90 degree fitting, it may be changed to a straight or 45 degree fitting. For more information on how to help prevent discharge line freeze-ups, see Bendix Bulletins TCH-08-21 and TCH-08-22 (see pages 33-35). Shorter discharge line lengths or insulation may be required in cold climates.

The **air dryer** contains a filter that collects oil droplets, and a desiccant bed that removes almost all of the remaining water vapor. The compressed air is then passed to the air brake service (supply) reservoir. The oil droplets and the water collected are automatically purged when the governor reaches its “cut-out” setting.

For vehicles with accessories that are sensitive to small amounts of oil, we recommended installation of a Bendix® PuraGuard® system filter, designed to minimize the amount of oil present.

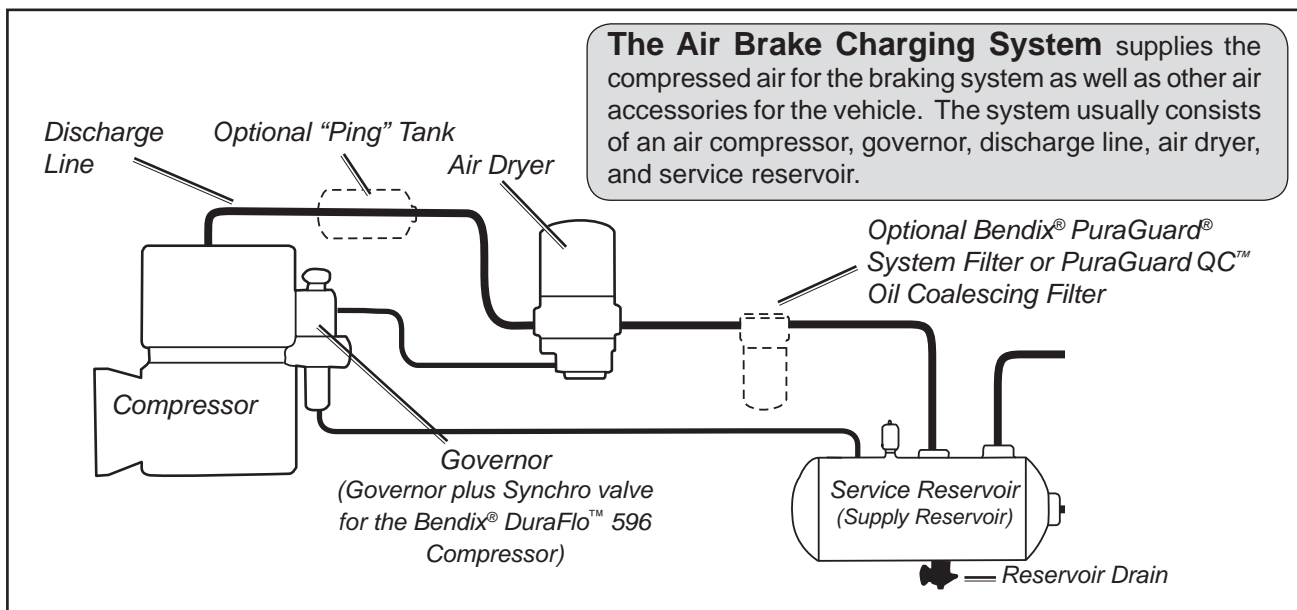





Table A: Maintenance Schedule and Usage Guidelines

Regularly scheduled maintenance is the single most important factor in maintaining the air brake charging

Vehicle Used for:	No. of Axles	Column 1	Column 2		Column 3	Column 4	Column 5
		Typical Compressors Spec'd (See footnote 7)	I.D.	Length	Recommended Air Dryer Cartridge Replacement ¹	Recommended Reservoir Drain Schedule ²	Acceptable Reservoir Oil Contents ³ at Regular Drain Interval
Low Air Use							
<p>Compressor with less than 15% duty cycle</p> <p>e.g. Line haul single trailer w/o air suspension, air over hydraulic brakes.</p> 	5 or less	Bendix® BA-921® air compressor	1/2 in.	6 ft.	Every 3 Years	Recommended Every Month - Max of every 90 days	BASIC™ test acceptable range: 3 oil units per month. See appendix A.
<p>Compressor with up to 25% duty cycle</p> <p>e.g. Line haul single trailer with air suspension, school bus.</p> 	5 or less		Bendix® Tu-Flo® 550 air compressor	1/2 in.			
High Air Use							
<p>Compressor with up to 25% duty cycle</p> <p>e.g. Double/triple trailer, open highway coach/RV, (most) pick-up & delivery, yard or terminal jockey, off-highway, construction, loggers, concrete mixer, dump truck, fire truck.</p> 	8 or less	Bendix® BA-921® air compressor	1/2 in.	12 ft.	Every 2 Years	Every Month	BASIC™ test acceptable range: 5 oil units per month. See appendix A.
<p>Compressor with up to 25% duty cycle</p> <p>e.g. City transit bus, refuse, bulk unloaders, low boys, urban region coach, central tire inflation.</p> 	12 or less	Bendix® Tu-Flo® 750 air compressor	1/2 in.	15 ft.			
Low Air Use (continued)							
		Bendix® BA-922®, or DuraFlo™ 596 air compressor	3/4 in.	12 ft.	Every Year		

For the BASIC™ Test Kit: Order Bendix P/N 5013711

Footnotes:

1. With increased air demand the air dryer cartridge needs to be replaced more often.
2. Use the drain valves to slowly drain all reservoirs to zero psi.
3. Allow the oil/water mixture to fully settle before measuring oil quantity.
4. To counter above normal temperatures at the air dryer inlet, (and resultant oil-vapor passing upstream in the air system) replace the discharge line with one of a larger diameter and/or longer length. This helps reduce the air's temperature. If sufficient cooling occurs, the oil-vapor condenses and can be removed by the air dryer. Discharge line upgrades are not covered under warranty. Note: To help prevent discharge line freeze-ups, shorter discharge line lengths or insulation may be required in cold climates. (See Bendix

Bulletins TCH-08-21 and TCH-08-22, included in Appendix B, for more information.)

5. For certain vehicles/applications, where turbo-charged inlet air is used, a smaller size compressor may be permissible.
6. Note: Compressor and/or air dryer upgrades are recommended in cases where duty cycle is greater than the normal range (for the examples above).
7. For correct compressor upgrades consult Bendix - Please note that because a compressor is listed in the same area of the chart does not necessarily mean that it would be a suitable candidate for upgrade purposes.

For Bendix® Tu-Flo® 550 and 750 compressors, unloader service is recommended every 250,000 miles.

Air Brake Charging System Troubleshooting

How to use this guide:

Find the **symptom(s)** that you see, then move to the right to find the possible causes (“**What it may indicate**”) and remedies (“**What you should do**”).

Review the warranty policy before performing any intrusive compressor maintenance. Unloader or cylinder head gasket replacement and resealing of the bottom cover plate are usually permitted under warranty. Follow all standard safety procedures when performing any maintenance.

Look for:

 **Normal**

Normal - Charging system is working within normal range.





 **Check**

Check - Charging system needs further investigation.

WARNING! Please READ and follow these instructions to avoid personal injury or death:

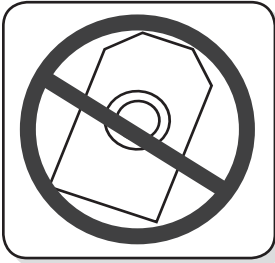
When working on or around a vehicle, the following general precautions should be observed at all times.

1. Park the vehicle on a level surface, apply the parking brakes, and always block the wheels. Always wear safety glasses.
2. Stop the engine and remove ignition key when working under or around the vehicle. When working in the engine compartment, the engine should be shut off and the ignition key should be removed. Where circumstances require that the engine be in operation, EXTREME CAUTION should be used to prevent personal injury resulting from contact with moving, rotating, leaking, heated or electrically charged components.
3. Do not attempt to install, remove, disassemble or assemble a component until you have read and thoroughly understand the recommended procedures. Use only the proper tools and observe all precautions pertaining to use of those tools.
4. If the work is being performed on the vehicle's air brake system, or any auxiliary pressurized air systems, make certain to drain the air pressure from all reservoirs before beginning ANY work on the vehicle. If the vehicle is equipped with an AD-IS® air dryer system or a dryer reservoir module, be sure to drain the purge reservoir.
5. Following the vehicle manufacturer's recommended procedures, deactivate the electrical system in a manner that safely removes all electrical power from the vehicle.
6. Never exceed manufacturer's recommended pressures.
7. Never connect or disconnect a hose or line containing pressure; it may whip. Never remove a component or plug unless you are certain all system pressure has been depleted.
8. Use only genuine Bendix® replacement parts, components and kits. Replacement hardware, tubing, hose, fittings, etc. must be of equivalent size, type and strength as original equipment and be designed specifically for such applications and systems.
9. Components with stripped threads or damaged parts should be replaced rather than repaired. Do not attempt repairs requiring machining or welding unless specifically stated and approved by the vehicle and component manufacturer.
10. Prior to returning the vehicle to service, make certain all components and systems are restored to their proper operating condition.
11. For vehicles with Antilock Traction Control (ATC), the ATC function must be disabled (ATC indicator lamp should be ON) prior to performing any vehicle maintenance where one or more wheels on a drive axle are lifted off the ground and moving.

Symptom:	What it may indicate:	What you should do:
<p>1.0 Oil Test Card Results</p>  	<p>Not a valid test.</p>  <p>Bendix® BASIC™ Test</p> 	<p>Discontinue using this test.</p> <p>Do not use this card test to diagnose compressor "oil passing" issues. They are subjective and error prone. Use only the Bendix® Air System Inspection Cup (BASIC™) test and the methods described in this guide for advanced troubleshooting.</p> <p>The Bendix® BASIC™ test should be the definitive method for judging excessive oil fouling/oil passing. (See Appendix A, on page 30 for a flowchart and expanded explanation of the checklist used when conducting the BASIC™ test.)</p>

Symptom:	What it may indicate:	What you should do:
2.0 Oil on the Outside of the Compressor	Engine and/or other accessories leaking onto compressor.	Find the source and repair. Return the vehicle to service.
2.1 Oil leaking at compressor / engine connections:	(a) Leak at the front or rear (fuel pump, etc.) mounting flange.	⇒ Repair or replace as necessary. If the mounting bolt torques are low, replace the gasket.
	(b) Leak at air inlet fitting.	⇒ Replace the fitting gasket. Inspect inlet hose and replace as necessary.
	(c) Leak at air discharge fitting.	⇒ Replace gasket or fitting as necessary to ensure good seal.
	(d) Loose/broken oil line fittings.	⇒ Inspect and repair as necessary.
2.2 Oil leaking from compressor:	(a) Excessive leak at head gasket.	⇒ Go to Test 1 on page 28.
	(b) Leak at bottom cover plate.	⇒ Reseal bottom cover plate using RTV silicone sealant.
	(c) Leak at internal rear flange gasket.	⇒ Replace compressor.
	(d) Leak through crankcase.	⇒ Replace compressor.
	(e) (If unable to tell source of leak.)	⇒ Clean compressor and check periodically.

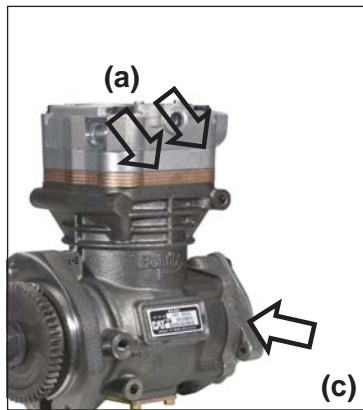

Head gaskets and rear flange gasket locations.

? Check

3.0 Oil at air dryer purge/exhaust or surrounding area	Air brake charging system functioning normally.	⇒ Air dryers remove water and oil from the air brake charging system. Check that regular maintenance is being performed. Return the vehicle to service. An optional kit (Bendix piece number 5011327 for the Bendix® AD-IS® or AD-IP™ air dryers, or 5003838 for the Bendix® AD-9™ air dryer) is available to redirect the air dryer exhaust.
---	---	---

✓ Normal

Symptom:**What it may indicate:****What you should do:****4.0 Oil in Supply or Service Reservoir (air dryer installed)**

(If a maintained Bendix® PuraGuard® system filter or Bendix® PuraGuard QC™ oil coalescing filter is installed, call 1-800-AIR-BRAKE (1-800-247-2725) and speak to a Tech Team member.)



See Table A, on page 17, for maintenance schedule information.

Maintenance

- (a) **If** air brake charging system maintenance **has not been performed**. That is, reservoir(s) **have not** been drained per the schedule in Table A on page 17, Column 4 **and/or** the air dryer maintenance **has not** been performed as in Column 3.
- (b) **If** the vehicle maintenance **has been performed** as recommended in Table A on page 17, some oil in the reservoirs is normal.



Drain all air tanks (reservoirs) into the Bendix® BASIC™ test cup. (Bendix kit P/N 5013711).

- ⇒ Drain all air tanks and check vehicle at next service interval using the Bendix® BASIC™ test. See Table A on page 17, column 3 and 4, for recommended service schedule.

? Check

- ⇒ Drain all air tanks into Bendix® BASIC™ test cup (Bendix Air System Inspection Cup). If less than one unit of reservoir contents is found, the vehicle can be returned to service. **Note: If more than one oil unit of water (or a cloudy emulsion mixture) is present, change the vehicle's air dryer, check for air system leakage (Test 2, on page 28), stop inspection and check again at the next service interval. See the BASIC™ test kit for full details.** If less than one "oil unit" of water (or water/cloudy emulsion mixture) is present, use the BASIC™ cup chart on the label of the cup to determine if the amount of oil found is within the acceptable level.
- ⇒ If within the normal range, return the vehicle to service. For vehicles with accessories that are sensitive to small amounts of oil, consider a Bendix® PuraGuard QC™ oil coalescing filter.
- ⇒ If outside the normal range go to Symptom 4.0(c).
- Also see the Table A on page 17, column 3 for recommended air dryer cartridge replacement schedule.

Duty cycle too high

- (c) Air brake system leakage.
- (d) Compressor may be undersized for the application.

- ⇒ Go to Test 2 on page 28.
- ⇒ See Table A, column 1, on page 17 for recommended compressor sizes.
- ⇒ If the compressor is "too small" for the vehicle's role (for example, where a vehicle's use has changed or service conditions exceed the original vehicle or engine OE spec's) then upgrade the compressor. **Note:** The costs incurred (e.g. installing a larger capacity compressor, etc.) are not covered under original compressor warranty.
- ⇒ If the compressor is correct for the vehicle, go to Symptom 4.0 (e).

The **duty cycle** is the ratio of time the compressor spends building air to total engine running time. Air compressors are designed to build air (to "run loaded") up to 25% of the time. Higher duty cycles cause conditions that affect air brake charging system performance which may require additional maintenance. Factors that add to the duty cycle are: air suspension, additional air accessories, use of an undersized compressor, frequent stops, excessive leakage from fittings, connections, lines, chambers or valves, etc.

Symptom:

What it may indicate:

What you should do:

4.0 Oil in Supply or Service Reservoir* (air dryer installed) (continued)

Temperature

(e) Air compressor discharge and/or air dryer inlet temperature too high.

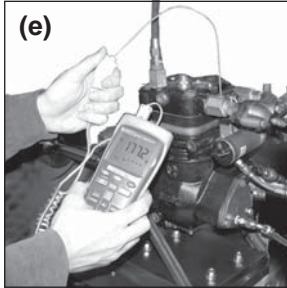

Testing the temperature at the discharge fitting.

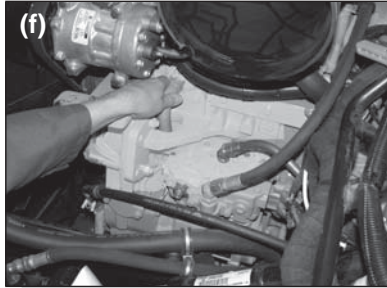

Inspecting the coolant hoses.

(f) Insufficient coolant flow.

(g) Restricted discharge line.



Kinked discharge line shown.

⇒ Check temperature as outlined in Test 3 on page 28. If temperatures are normal go to 4.0(h).

⇒ Inspect coolant line. Replace as necessary (I.D. is 1/2").

⇒ Inspect the coolant lines for kinks and restrictions and fittings for restrictions. Replace as necessary.

⇒ Verify coolant lines go from engine block to compressor and back to the water pump. Repair as necessary.

⇒ If discharge line is restricted or more than 1/16" carbon build-up is found, replace the discharge line. See Table A, column 2, on page 17 for recommended size. Replace as necessary.

⇒ The discharge line must maintain a **constant slope** down from the compressor to the air dryer inlet fitting to avoid low points where ice may form and block the flow. If, instead, ice blockages occur at the air dryer inlet, insulation may be added here, or if the inlet fitting is a typical 90 degree fitting, it may be changed to a straight or 45 degree fitting. For more information on how to help prevent discharge line freeze-ups, see Bendix Bulletins TCH-08-21 and TCH-08-22 (Appendix B). Shorter discharge line lengths or insulation may be required in cold climates.

Other

(h) Restricted air inlet (not enough air to compressor).

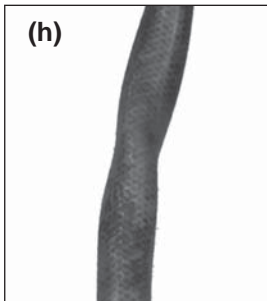

Partly collapsed inlet line shown.

⇒ Check compressor air inlet line for restrictions, brittleness, soft or sagging hose conditions etc. Repair as necessary. Inlet line size is 3/4 ID. Maximum restriction requirement for compressors is 25 inches of water.

⇒ Check the engine air filter and service if necessary (if possible, check the air filter usage indicator).

? Check

*If a maintained Bendix® PuraGuard® system filter or Bendix® PuraGuard QC™ oil coalescing filter is installed, call 1-800-AIR-BRAKE (1-800-247-2725) and speak to a Tech Team member.

Symptom:	What it may indicate:	What you should do:
----------	-----------------------	---------------------

4.0 Oil in Supply or Service Reservoir* (air dryer installed) (continued)

Other (cont.)

(i) Poorly filtered inlet air (poor air quality to compressor).



Inspect the engine air cleaner.

(j) Governor malfunction or setting.

(k) Compressor malfunction.

⇒ Check for leaking, damaged or defective compressor air inlet components (e.g. induction line, fittings, gaskets, filter bodies, etc.). Repair inlet components as needed. Note: Dirt ingestion will damage compressor and is not covered under warranty.

? Check

⇒ Go to Test 4 on page 29.

⇒ If you found excessive oil present in the service reservoir in step 4.0 (b) above and you did not find any issues in steps 4.0 (c) through 4.0 (j) above, the compressor may be passing oil.

Replace compressor. If still under warranty, follow normal warranty process. Note: After replacing a compressor, residual oil may take a considerable period of time to be flushed from the air brake system.

Crankcase Flooding
Consider installing a compressor bottom drain kit (where available) in cases of chronic oil passing where all other operating conditions have been investigated. Bendix compressors are designed to have a 'dry' sump and the presence of excess oil in the crankcase can lead to oil carryover.

*If a maintained Bendix® PuraGuard® system filter or Bendix® PuraGuard QC™ oil coalescing filter is installed, call 1-800-AIR-BRAKE (1-800-247-2725) and speak to a Tech Team member.

5.0 Oil present at valves (e.g. at exhaust, or seen during servicing).

Air brake system valves are required to tolerate a light coating of oil.

✓ Normal

⇒ A small amount of oil does not affect SAE J2024** compliant valves.



⇒ Check that regular maintenance is being performed and that the amount of oil in the air tanks (reservoirs) is within the acceptable range shown on the Bendix® BASIC™ test cup (see also column 5 of Table A on page 17). Return the vehicle to service.

For oil-sensitive systems, see page 16.



Genuine Bendix valves are all SAE J2024 compliant.

** SAE J2024 outlines tests all air brake system pneumatic components need to be able to pass, including minimum levels of tolerance to contamination.

Symptom:	What it may indicate:	What you should do:
<p>6.0 Excessive oil consumption in engine.</p>	<p>A problem with engine or other engine accessory.</p>  <p>The engine service manual has more information.</p>	<p>⇒ See engine service manual.</p> <p>? Check</p>
<p>7.0 Oil present at air dryer cartridge during maintenance.</p>	<p>Air brake charging system is functioning normally.</p>  <p>Oil shown leaking from an air dryer cartridge.</p> <p>✓ Normal</p>	<p>⇒ Air dryers remove water and oil from the air brake charging system. A small amount of oil is normal. Check that regular maintenance is being performed and that the amount of oil in the air tanks (reservoirs) is within the acceptable range shown by the BASIC™ test (see also column 5 of Table A on page 17). Replace the air dryer cartridge as needed and return the vehicle to service.</p>
<p>8.0 Oil in ping tank or compressor discharge aftercooler.</p>	<p>Air brake charging system is functioning normally.</p> <p>✓ Normal</p>	<p>⇒ Follow vehicle O.E. maintenance recommendation for these components.</p>
<p>9.0 Air brake charging system seems slow to build pressure.</p>	<p>(a) Air brake charging system functioning normally.</p> <p>✓ Normal</p> <p>(b) Air brake system leakage.</p> <p>(c) Compressor may be undersized for the application.</p> <p>(d) Compressor unloader mechanism malfunction.</p> <p>(e) Damaged compressor head gasket.</p>	<p>⇒ Using dash gauges, verify that the compressor builds air system pressure from 85-100 psi in 40 seconds or less with engine at full governed rpm. Return the vehicle to service.</p> <p>⇒ Go to Test 2 on page 28.</p> <p>⇒ See Table A, column 1, on page 17 for some typical compressor applications. If the compressor is "too small" for the vehicle's role, for example, where a vehicle's use has changed, then upgrade the compressor. Note: The costs incurred (e.g. installing a larger capacity compressor, etc.) are not covered under original compressor warranty.</p> <p>⇒ Go to Test 6 on page 29.</p> <p>⇒ An air leak at the head gasket may indicate a downstream restriction such as a freeze-up or carbon blockage and/or could indicate a defective or missing safety valve. Find blockage (go to 9.0(f) for details) and then replace the compressor. Do not reuse the safety valve without testing. See Symptom 12.0(a).</p>

Symptom:**What it may indicate:****What you should do:**

9.0 Air brake charging system seems slow to build pressure. (continued)



Dash gauges.

(f) Restricted discharge line.

? Check



Kinked discharge line shown.

Engine Oil Quality

Inadequate oil change intervals, the formulation of the oil and/or the quality of oil filter used can all lead to poor oil quality. These can increase the rate at which carbon builds up in the discharge line. Bendix recommends oil soot (solids) be maintained at less than 3%.

- ⇒ If discharge line is restricted:
 - ⇒ By more than 1/16" carbon build-up, replace the discharge line (see Table A, column 2, on page 17 for recommended size) and go to Test 3 on page 28.
 - ⇒ By other restrictions (e.g. kinks). Replace the discharge line. See Table A, column 2, on page 17 for recommended size. Re test for air build. Return vehicle to service or, if problem persists, go to 9.0(a).
- ⇒ The discharge line must maintain a **constant slope** down from the compressor to the air dryer inlet fitting to avoid low points where ice may form and block the flow. If, instead, ice blockages occur at the air dryer inlet, insulation may be added here, or if the inlet fitting is a typical 90 degree fitting, it may be changed to a straight or 45 degree fitting. For more information on how to help prevent discharge line freeze-ups, see Bendix Bulletins TCH-08-21 and TCH-08-22 (Appendix B). Shorter discharge line lengths or insulation may be required in cold climates.

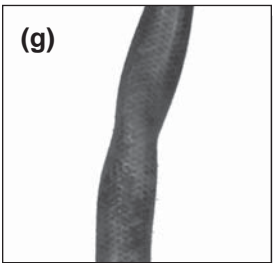

Partly collapsed inlet line shown.

(g) Restricted air inlet (not enough air to compressor).

? Check

(h) Poorly filtered inlet air (poor air quality to compressor).

? Check

(i) Compressor malfunction.

? Check

- ⇒ Check compressor air inlet line for restrictions, brittleness, soft or sagging hose conditions etc. Repair as necessary. Refer to vehicle manufacturer's guidelines for inlet line size.
- ⇒ Check the engine air filter and service if necessary (if possible, check the air filter usage indicator).
- ⇒ Check for leaking, damaged or defective compressor air inlet components (e.g. induction line, fittings, gaskets, filter bodies, etc.). Repair inlet components as needed. Note: Dirt ingestion will damage compressor and is not covered under warranty.
- ⇒ Replace the compressor only after making certain that none of the preceding conditions, 9.0 (a) through 9.0 (h), exist.

Symptom:	What it may indicate:	What you should do:
10.0 Air charging system doesn't build air.	(a) Governor malfunction*.	⇒ Go to Test 4 on page 29.
	(b) Restricted discharge line.	⇒ See 9.0(f).
	(c) Air dryer heater malfunction: exhaust port frozen open.	⇒ Replace air dryer heater.
	(d) Compressor malfunction.	⇒ Replace the compressor only after making certain the preceding conditions do not exist.
<p>* Note: For the Bendix® DuraFlo™ 596 air compressor, not only the governor, but also the SV-1™ synchro valve used would need to be tested. See Bulletin TCH-001-048.</p>		

11.0 Compressor safety valve releases air (Compressor builds too much air).

(a) Restricted discharge line.

? Check

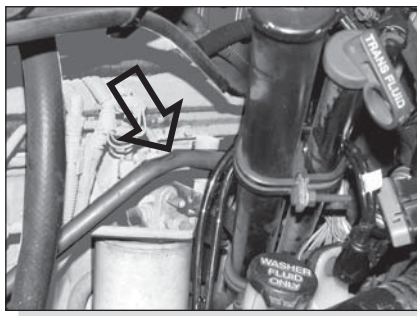

Damaged discharge line shown.

⇒ If discharge line is restricted:

- ⇒ By more than 1/16" carbon build-up, replace the discharge line (see Table A, column 2, on page 17 for recommended size) and go to Test 3 on page 28.
- ⇒ By other restrictions (e.g. kinks). Replace the discharge line. See Table A, column 2, on page 17 for recommended size.

⇒ The discharge line must maintain a **constant slope** down from the compressor to the air dryer inlet fitting to avoid low points where ice may form and block the flow. If, instead, ice blockages occur at the air dryer inlet, insulation may be added here, or if the inlet fitting is a typical 90 degree fitting, it may be changed to a straight or 45 degree fitting. For more information on how to help prevent discharge line freeze-ups, see Bendix Bulletins TCH-08-21 and TCH-08-22 (Appendix B). Shorter discharge line lengths or insulation may be required in cold climates.

(b) Downstream air brake system check valves or lines may be blocked or damaged.

⇒ Inspect air lines and verify check valves are operating properly.

(c) Air dryer lines incorrectly installed.

⇒ Ensure discharge line is installed into the inlet of the air dryer and delivery is routed to the service reservoir.

(d) Compressor safety valve malfunction.



⇒ Verify relief pressure is 250 psi. Replace if defective.

(e) Compressor unloader mechanism malfunction.

⇒ Go to Test 6 on page 29.

(f) Governor malfunction.

⇒ Go to Test 4 on page 29.

Symptom:	What it may indicate:	What you should do:
12.0 Air dryer safety valve releases air.	(a) Restriction between air dryer and reservoir. (b) Air dryer safety valve malfunction. (c) Air dryer maintenance not performed. (d) Air dryer malfunction. (e) Improper governor control line installation to the reservoir. (f) Governor malfunction.	⇨ Inspect delivery lines to reservoir for restrictions and repair as needed. ⇨ Verify relief pressure is at vehicle or component manufacturer specifications. Replace if defective. ⇨ See Maintenance Schedule and Usage Guidelines (Table A, column 3, on page 17). ⇨ Verify operation of air dryer. Follow vehicle O.E. maintenance recommendations and component Service Data information. ⇨ Go to Test 5 on page 29. ⇨ Go to Test 4 on page 29.
		
Technician removes governor.		
13.0 Reservoir safety valve releases air	(a) Reservoir safety valve malfunction. (b) Governor malfunction. (c) Compressor unloader mechanism malfunction.	⇨ Verify relief pressure is at vehicle or component manufacturer's specifications (typically 150 psi). Replace if defective. ⇨ Go to Test 4 on page 29. ⇨ Go to Test 6 on page 29.
14.0 Air dryer doesn't purge. (Never hear exhaust from air dryer.)	(a) Air dryer malfunction. (b) Governor malfunction. (c) Air brake system leakage. (d) Improper governor control line installation to the reservoir.	⇨ Verify operation of air dryer. Follow vehicle O.E. maintenance recommendations. ⇨ Go to Test 4 on page 29. ⇨ Go to Test 2 on page 28. ⇨ Go to Test 5 on page 29.
15.0 Compressor constantly cycles (compressor remains unloaded for a very short time.)	(a) Air brake charging system maintenance not performed. <div style="text-align: center; border: 1px solid black; border-radius: 10px; padding: 5px; width: fit-content; margin: 10px auto;"> ? Check </div> (b) Compressor unloader mechanism malfunction. (c) Air dryer purge valve or delivery check valve malfunction. (d) Air brake system leakage.	⇨ Available reservoir capacity may be reduced by build-up of water etc. Drain and perform routine maintenance per Table A, columns 3 & 4, on page 17. ⇨ Go to Test 6 on page 29. ⇨ Verify operation of air dryer. Follow vehicle O.E. maintenance recommendations and component Service Data information. ⇨ Go to Test 2 on page 28.

Symptom:	What it may indicate:	What you should do:
16.0 Compressor leaks air  Testing for leaks with soap solution.	(a) Compressor leaks air at connections or ports.	⇒ Check for leaking, damaged or defective compressor fittings, gaskets, etc. Repair or replace as necessary.
	(b) Compressor unloader mechanism malfunction.	⇒ Go to Test 6 on page 29.
	(c) Damaged compressor head gasket(s).	⇒ An air leak at the head gasket(s) may indicate a downstream restriction such as a freeze-up or carbon blockage and/or could indicate a defective or missing safety valve. Find blockage (go to 9.0(f) for details) and then replace the compressor. Do not re-use the safety valve without testing. See Symptom 12.0(a).
17.0 Compressor leaks coolant	(a) Improperly installed plugs or coolant line fittings.	⇒ Inspect for loose or over-torqued fittings. Reseal and tighten loose fittings and plugs as necessary. If overtorqued fittings and plugs have cracked ports in the head, replace the compressor.
	(b) Damaged compressor head gasket.	⇒ An air leak at the head gasket may indicate a downstream restriction such as a freeze-up or carbon blockage and/or could indicate a defective or missing safety valve. Find blockage (go to 9.0(f) for details) and then replace the compressor. Do not re-use the safety valve without testing. See Symptom 12.0(a).
	(c) Porous compressor head casting.	⇒ If casting porosity is detected, replace the compressor.
18.0 Noisy compressor (Multi-cylinder compressors only)	(a) Damaged compressor.	⇒ Replace the compressor.

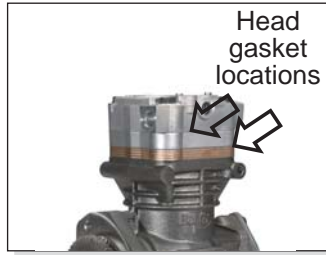

Other Miscellaneous Areas to Consider

This guide attempts to cover most compressor system problems. Here are some rare sources of problems not covered in this guide:

- Turbocharger leakage. Lubricating oil from leaking turbocharger seals can enter the air compressor intake and give misleading symptoms.

- Where a compressor does not have a safety valve installed, if a partial or complete discharge line blockage has occurred, damage can occur to the connecting rod bearings. Damage of this kind may not be detected and could lead to compressor problems at a later date.

Tests

Test 1: Excessive Oil Leakage at the Head Gasket

Exterior leaks at the head gasket are not a sign that oil is being passed into the air charging system. Oil weepage at the head gasket does not prevent the compressor from building air.

Observe the amount of weepage from the head gasket.

If the oil is only around the cylinder head area, it is acceptable (return the vehicle to service), but, if the oil weepage extends down to the nameplate area of the compressor, the gasket can be replaced.



Test 2: Air Brake System and Accessory Leakage

Inspect for air leaks when working on a vehicle and repair them promptly.

Park the vehicle on level ground and chock wheels. Build system pressure to governor cut-out and allow the pressure to stabilize for one minute.

Step 1: Observe the dash gauges for two additional minutes without the service brakes applied.

Step 2: Apply the service brakes and allow the pressure to stabilize. Continue holding for two minutes (you may use a block of wood to hold the

pedal in position.) Observe the dash gauges.

If you see **any noticeable decrease** of the dash air gauge readings (i.e. more than 4 psi, plus two psi for each additional trailer) during either two minute test, **repair the leaks** and repeat this test to confirm that they have been repaired.

Air leaks can also be found in the charging system, parking brakes, and/or other components - inspect and repair as necessary.

Test 3: Air Compressor Discharge Temperature and Air Dryer Inlet Temperature*

Caution: The temperatures used in this test are not normal vehicle conditions.

Above normal temperatures can cause oil (as vapor) to pass through the air dryer into the air brake system.

This test is run with the engine at normal operating temperature, with engine at max. rpm. If available, a dyno may be used.

1. Allow the compressor to build the air system pressure to governor cut-in.
2. Pump the brakes to bring the dash gauge pressure to 90 psi.
3. Allow the compressor to build pressure from 95 to 105 psi gauge pressure and maintain this pressure range by cycling the brakes **for five (5) minutes.**

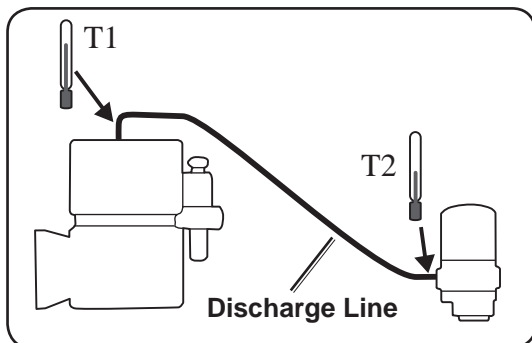

(* Note that only vehicles that have passed Test 2 would be candidates for this test.)

4. Then, while maintaining max rpm and pressure range, measure and **record the surface temperature** of the fittings:
 - ⇒ at the compressor discharge port. (T1).
 - ⇒ at the air dryer inlet fitting. (T2).
 Use a touch probe thermocouple for measuring the temperature.
5. See table below.
6. Re test before returning the vehicle to service.

T1 Compressor Discharge Fitting	T2 Air Dryer Inlet Fitting	Action
under 360°F	under 200°F	Temperatures are within normal range for this test, check other symptoms. Go to 4.0 (h).
under 360°F	over 200°F	This could indicate a discharge line problem (e.g. restriction). Call 1-800-AIR-BRAKE (1-800-247-2725) and speak with our Tech Team.
over 360°F	—	Compressor is running hot. Check coolant 4(f) and/or discharge line 4(g).

Tests (continued)

Test 4: Governor Malfunction

1. Inspect control lines to and from the governor for restrictions (e.g. collapsed or kinked). Repair as necessary.
2. Using a calibrated external gauge in the supply reservoir, service reservoir, or reservoir port of the D-2™ governor, verify cut-in and cut-out pressures are within vehicle OEM specification.
3. If the governor is malfunctioning, replace it.

Test 5: Governor Control Line

1. Ensure that the governor control line from the reservoir is located at or near the top of the reservoir. (This line, if located near the bottom of the reservoir, can become blocked or restricted by the reservoir contents e.g. water or ice.)
2. Perform proper reservoir drain intervals and air dryer cartridge maintenance per Maintenance Schedule and Usage Guidelines (Table A on page 17).
3. Return the vehicle to service.

Test 6: Compressor Unloader Leakage

Bendix® Compressors: Park vehicle, chock wheels, and follow all standard safety procedures. Remove the governor and install a fitting to the unloader port. Add a section of air hose (min 1 ft long for a 1/2" diameter line) and a gauge to the fitting followed by a shut-off valve and an air source (shop air or small air tank). Open the

shut-off and charge the unloader port by allowing air pressure to enter the hose and unload the compressor. Shut off the air supply and observe the gauge. A steady reading indicates no leakage at the unloader port, but a falling reading shows that the unloader mechanism is leaking and needs to be serviced.

Appendix A: Information about the BASIC™ Test Kit (Bendix P/N 5013711)

Bendix® Air System Inspection Cup (BASIC™) Test Information

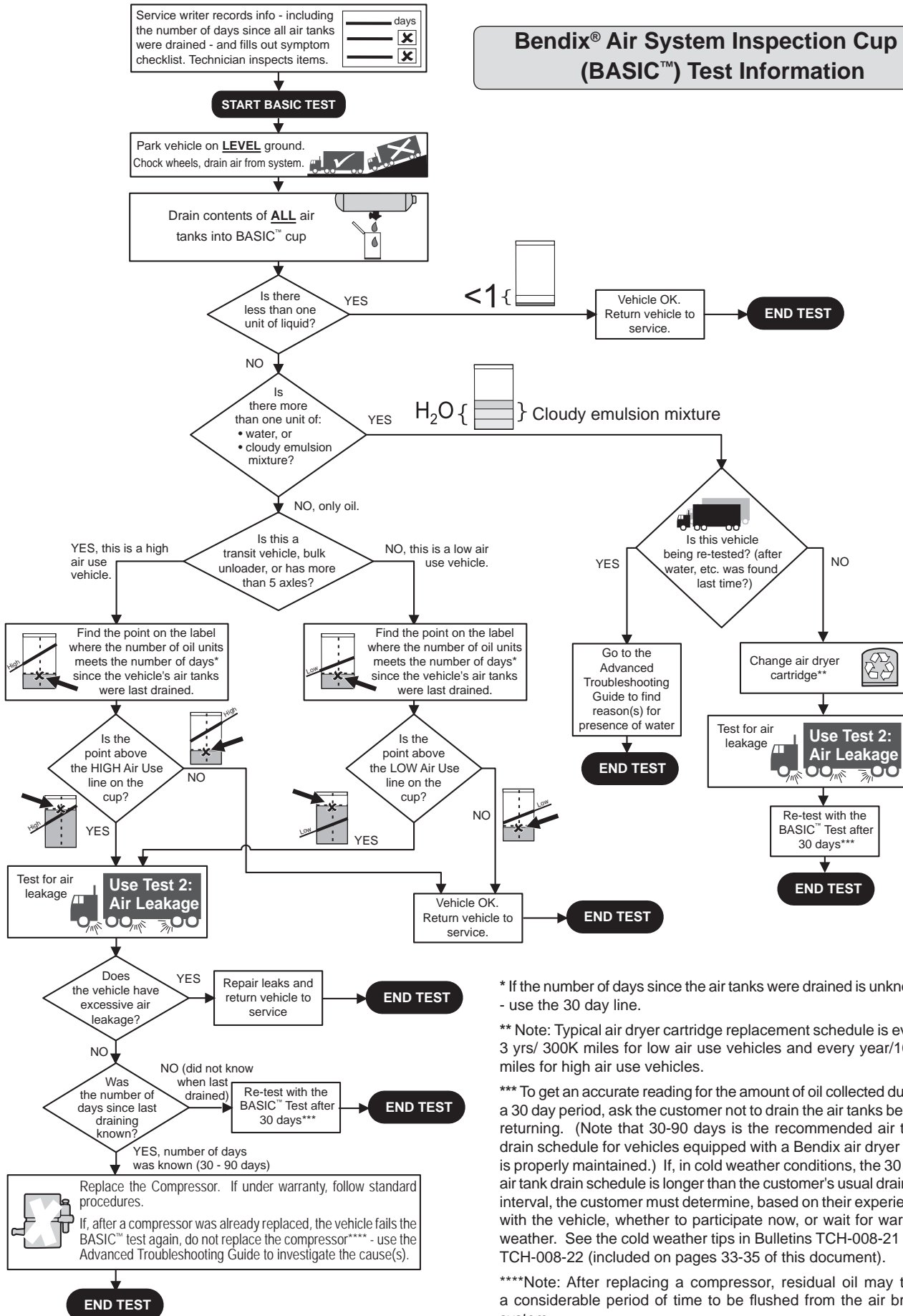

* If the number of days since the air tanks were drained is unknown - use the 30 day line.

** Note: Typical air dryer cartridge replacement schedule is every 3 yrs/ 300K miles for low air use vehicles and every year/100K miles for high air use vehicles.

*** To get an accurate reading for the amount of oil collected during a 30 day period, ask the customer not to drain the air tanks before returning. (Note that 30-90 days is the recommended air tank drain schedule for vehicles equipped with a Bendix air dryer that is properly maintained.) If, in cold weather conditions, the 30 day air tank drain schedule is longer than the customer's usual draining interval, the customer must determine, based on their experience with the vehicle, whether to participate now, or wait for warmer weather. See the cold weather tips in Bulletins TCH-008-21 and TCH-008-22 (included on pages 33-35 of this document).

****Note: After replacing a compressor, residual oil may take a considerable period of time to be flushed from the air brake system.

Appendix A continued: Information about the BASIC™ Test Kit (Bendix P/N 5013711)

Filling in the Checklist for the Bendix® Air System Inspection Cup (BASIC™) Test

Note: Follow all standard safety precautions. For vehicles using a desiccant air dryer.

The Service Writer fills out these fields with information gained from the customer

Number of Days Since Air Tanks Were Last Drained: _____ Date: _____ Vehicle #: _____
 Engine SN _____ Vehicle Used for: _____ Typical Load: _____ (lbs.)
 No. of Axles: ____ (tractor) ____ (trailer) No. of Lift Axles: ____ Technician's Name: _____

The Service Writer also checks off any complaints that the customer makes to help the Technician in investigating.

Customer's complaint? (Please check all that apply)	Checklist for Technician Have you confirmed
"Relay valve <input type="checkbox"/> leaks oil / <input type="checkbox"/> malfunctions"	<input type="checkbox"/> no <input type="checkbox"/> yes*
"Dash valve <input type="checkbox"/> leaks oil / <input type="checkbox"/> malfunctions"	<input type="checkbox"/> no <input type="checkbox"/> yes*
<input type="checkbox"/> "Air dryer leaks oil"	<input type="checkbox"/> no <input type="checkbox"/> yes*
<input type="checkbox"/> "Governor malfunction"	<input type="checkbox"/> no <input type="checkbox"/> yes*
<input type="checkbox"/> "Oil in gladhands"	<input type="checkbox"/> no <input type="checkbox"/> yes*
how much oil did you find? _____	
<input type="checkbox"/> "Oil on ground or vehicle exterior"	<input type="checkbox"/> no <input type="checkbox"/> yes*
amount described: _____	
<input type="checkbox"/> "Short air dryer cartridge life"	
replaces every: _____ <input type="checkbox"/> miles, <input type="checkbox"/> kms, or <input type="checkbox"/> months	
<input type="checkbox"/> "Oil in air tanks" amount described: _____	
We will measure amount currently found when we get to step B of the test.	
<input type="checkbox"/> "Excessive engine oil loss" amount described: _____	
Is the engine leaking oil?	<input type="checkbox"/> no <input type="checkbox"/> yes*
Is the compressor leaking oil?	<input type="checkbox"/> no <input type="checkbox"/> yes*
<input type="checkbox"/> Other complaint: _____	
<input type="checkbox"/> No customer complaint.	

The Technician checks boxes for any of the complaints that can be confirmed.

* Note: A confirmed complaint above **does NOT** mean that the compressor must be replaced. The full BASIC™ test below will investigate the facts.

BASIC™ test starts here:

STEP A - Select one:

- This is a low air use vehicle: Line haul (single trailer) with 5 or less axles, or
 - This is a high air use vehicle: Garbage truck, transit bus, bulk unloader, or line haul with more than 5 axles.
- Then go to Step B.**

The Technician selects the air use category for the vehicle. This decides which of the two acceptance lines on the cup will be used for the test below.

STEP B - Measure the Charging System Contents

1. Park and chock vehicle on level ground. Drain the air system by pumping the service brakes.
2. Completely drain ALL the air tanks into a single BASIC™ cup.
3. If there is less than one unit of contents total, end the test now and return the vehicle to service. Vehicle passes.
4. **If more than one oil unit of water (or a cloudy emulsion mixture) is found:**
 - (a) Change the vehicle's air dryer cartridge - see Footnote 1,
 - (b) Conduct the 4 minute leakage test (Step D),
 - (c) **STOP the inspection, and check the vehicle again after 30 days** - see Footnote 2.



For an accurate test, the contents of all the air tanks on the vehicle should be used.

Note for returning vehicles that are being re tested after a water/cloudy emulsion mixture was found last time and the air dryer cartridge replaced: If more than one oil unit of water or a cloudy emulsion mixture is found **again**, stop the BASIC™ test and consult the air dryer's Service Data sheet troubleshooting section.

Otherwise, go to Step C.

Footnote 1: Note: Typical air dryer cartridge replacement schedule is every 3 yrs/ 300K miles for low air use vehicles and every year/100K miles for high air use vehicles.

Footnote 2: To get an accurate reading for the amount of oil collected during a 30 day period, ask the customer not to drain the air tanks before returning. (Note that 30-90 days is the recommended air tank drain schedule for vehicles equipped with a Bendix air dryer that are properly maintained.) If, in cold weather conditions, the 30 day air tank drain schedule is longer than the customer's usual draining interval, the customer must determine, based on its experience with the vehicle, whether to participate now, or wait for warmer weather. See the cold weather tips in Bulletins TCH-008-21 and TCH-008-22 (included in Appendix B of the advanced troubleshooting guide).

Appendix A continued: Information about the BASIC™ Test Kit (Bendix P/N 5013711)

Filling in the Checklist for the Bendix® Air System Inspection Cup (BASIC™) Test

Note: Follow all standard safety precautions. For vehicles using a desiccant air dryer.

STEP C - How to Use the BASIC™ Test

The Technician uses the chart (label) on the BASIC™ test cup to help decide the action to take, based on the amount of oil found. Use the lower acceptance line for low air use vehicles, and upper line for high air use vehicles (from Step A).

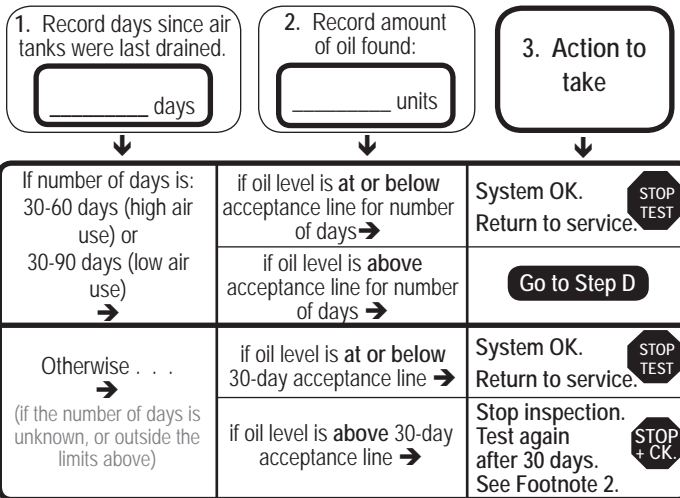

BASIC™ Test Example

An oil level of 4 units in a sixty-day period is within the acceptance area (at or below the line) for both low and high air use vehicles. Return the vehicle to service.

The Technician looks for the point where the number of days since the air tanks were drained meets the oil level. If it is at or below the (low or high use) acceptance line, the vehicle has passed the test. If the point is above the line then go to the leakage test.

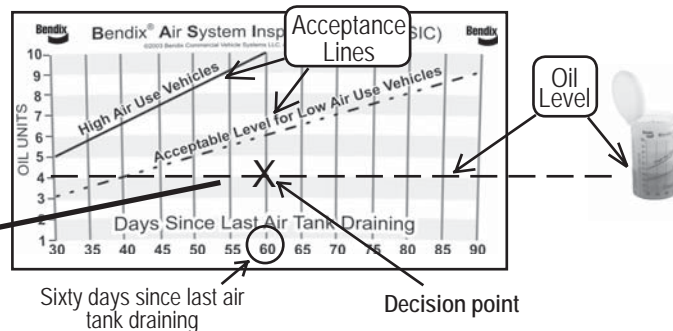

Air leakage is the number one cause of compressors having to pump excessive amounts of air, in turn run too hot and pass oil vapor along into the system. Here the Technician conducts a four-minute test to see if leakage is a problem with the vehicle being tested.

STEP D - Air Brake System Leakage Test

Park the vehicle on level ground and chock wheels. Build system pressure to governor cut-out and allow the pressure to stabilize for one minute.

- 1: Observe the dash gauges for two additional minutes without the service brakes applied.
- 2: Apply service brakes for two minutes (allow pressure to stabilize) and observe the dash gauges.

If you see any noticeable decrease of the dash air gauge readings, repair leaks. Repeat this test to confirm that air leaks have been repaired and return vehicle to service. Please repeat BASIC™ test at next service interval. Note: Air leaks can also be found in the charging system, parking brakes, and/or other components - inspect and repair as necessary.

If no air leakage was detected, and if you are conducting this test after completing Step C, go to Step E.

STEP E - If no air leakage was detected in Step D

Replace the compressor.

Note: If the compressor is within warranty period, please follow standard warranty procedures. Attach the completed checklist to warranty claim.

The Technician only reaches Step E if the amount of oil found, or the amount of time since the air tanks were last drained exceeds the acceptance level, AND the vehicle passes the four-minute leakage test (no noticeable leakage was detected).

Technical Bulletin



Bulletin No.: TCH-008-021
Page: 1 of 2

Effective Date: 11/1/92

Subject: **Air Brake System - Cold Weather Operation Tips**

As the cold weather approaches, operators and fleets alike begin to look to their vehicles with an eye toward “winterization”, and particularly what can be done to guard against air system freeze-up. Here are some BASIC™ “Tips” for operation in the cold weather.

Engine Idling

Avoid idling the engine for long periods of time! In addition to the fact that most engine manufacturers warn that long idle times are detrimental to engine life, winter idling is a big factor in compressor discharge line freeze-up. Discharge line freeze-ups account for a significant number of compressor failures each year. The discharge line recommendations under “Discharge Lines” are important for all vehicles but are especially so when some periods of extended engine idling can not be avoided.

Discharge Lines

The discharge line should slope downward from the compressor discharge port without forming water traps, kinks, or restrictions. Cross-overs from one side of the frame rail to the other, if required, should occur as close as possible to the compressor. Fitting extensions must be avoided. Recommended discharge line lengths and inside diameters are dependent on the vehicle application and are as follows.

Typical P&D, School Bus and Line Haul

The maximum discharge line length is 16 feet.

<u>Length</u>	<u>I.D. Min.</u>	<u>Other Requirements</u>
6.0-9.5 ft.	½ in.	None
9.5-12 ft. ½ in.		Last 3 feet, including fitting at the end of the discharge line, must be insulated with ½ inch thick closed cell polyethylene pipe insulation.
12-16 ft.	5/8 in.	Last 3 feet, including fitting at the end of the discharge line, must be insulated with ½ inch thick closed cell polyethylene pipe insulation.

If the discharge line length must be less than 6 feet or greater than 16 feet, contact your local Bendix representative.

Appendix B: Continued

High Duty Cycle Vehicles (City Transit Coaches, Refuse Haulers, Etc.)

The maximum discharge line length is 16 feet.

<u>Length</u>	<u>I.D. min.</u>	<u>Other Requirements</u>
10-16 ft. ½ in.	None	

If the discharge line length must be less than 10 feet or greater than 16 feet, contact your local Bendix representative.

System Leakage

Check the air brake system for excessive air leakage using the Bendix “Dual System Air Brake Test and Check List” (BW1279). Excessive system leakage causes the compressor to “pump” more air and also more moisture into the brake system.

Reservoir Draining (System Without Air Dryer)

Routine reservoir draining is the most BASIC™ step (although not completely effective) in reducing the possibility of freeze-up. **All reservoirs** in a brake system can accumulate water and other contamination and must be drained! The best practice is to drain all reservoirs daily. When draining reservoirs; turn the ENGINE OFF and drain ALL AIR from the reservoir, better still, open the drain cocks on all reservoirs and leave them open over night to assure all contamination is drained (reference Service Data Sheet SD-04-400 for Bendix Reservoirs). If automatic drain valves are installed, check their operation **before** the weather turns cold (reference Service Data Sheet SD-03-2501 for Bendix® DV-2™ Automatic Drain Valves). It should be noted that, while the need for daily reservoir draining is eliminated through the use of an automatic drain valve, periodic manual draining is still required.

Alcohol Evaporator or Injector Systems

Check for proper operation of these systems by monitoring alcohol consumption for a few days (Reference Service Data Sheet SD-08-2301 for the Bendix Alcohol Evaporator). Too little means the system is not receiving adequate protection and too much simply wastes alcohol. As a general guide, these systems should consume approximately 1 to 2 ounces of alcohol per hour of compressor loaded time (compressing air). City pick-up and delivery vehicles will operate with the compressors loaded (compressing air) more while compressors on highway vehicles will be loaded less. These figures are approximate and assume that air system leakage is within the limits of the Bendix “Dual System Air Brake Test and Check List” (BW1279). Last but not least, begin using alcohol several weeks prior to freezing weather to ensure that the system is completely protected. Use only methanol alcohol, such as Bendix “Air Guard”, in evaporators or injectors.

Air Dryers

Make certain air brake system leakage is within the limits stated in BW1279. Check the operation and function of the air dryer using the appropriate Service Data Sheet for the air dryer.

AD-9™ Air Dryer	Service Data Sheet SD-08-2412
AD-4™ Air Dryer	Service Data Sheet SD-08-2407
AD-2™ Air Dryer	Service Data Sheet SD-08-2403
AD-IP™ Air Dryer.	Service Data Sheet SD-08-2414
AD-SP™ Air Dryer	Service Data Sheet SD-08-2415
Trailer System-Guard® Air Dryer.	Service Data Sheet SD-08-2416
Bendix® PuraGuard QC™ Oil Coalescing Filter.	Service Data Sheet SD-08-187B



Technical Bulletin

Bulletin No.: TCH-008-022
Page: 1 of 1

Effective Date: 1/1/1994

Subject: **Additional Cold Weather Operation Tips for the Air Brake System**

Last year we published Bulletin PRO-08-21 which provided some guidelines for “winterizing” a vehicle air brake system. Here are some additional suggestions for making cold weather vehicle operation just a little more bearable.

Thawing Frozen Air Lines

The old saying; “Prevention is the best medicine” truly applies here! Each year this activity accounts for an untold amount of unnecessary labor and component replacement. Here are some Do’s and Don’ts for prevention and thawing.

Do’s

1. Do maintain freeze prevention devices to prevent road calls. Don’t let evaporators or injectors run out of methanol alcohol or protection will be degraded. Check the air dryer for proper operation and change the desiccant when needed.
2. Do thaw out frozen air lines and valves by placing the vehicle in a warmed building. This is the only method for thawing that will not cause damage to the air system or its components.
3. Do use dummy hose couplings on the tractor and trailer.
4. Do check for sections of air line that could form water traps. Look for “drooping” lines.

Don’ts

1. Do not apply an open flame to air lines and valves. Beyond causing damage to the internal nonmetallic parts of valves and melting or burning non-metallic air lines. **WARNING: THIS PRACTICE IS UNSAFE AND CAN RESULT IN VEHICLE FIRE!**
2. Do not introduce (pour) fluids into air brake lines or hose couplings (“glad hands”). Some fluids used can cause immediate and severe damage to rubber components. Even methanol alcohol, which is used in Alcohol Evaporators and Injectors, should not be poured into air lines. Fluids poured into the system wash lubricants out of valves, collect in brake chambers and valves and can cause malfunction. Loss of lubricant can affect valve operating characteristics, accelerate wear and cause premature replacement.
3. Do not park a vehicle outside after thawing its air system indoors. Condensation will form in the system and freeze again. Place the vehicle in operation when it is removed to the outdoors.

Supporting Air and Electrical Lines

Make certain tie wraps are replaced and support brackets are re-assembled if removed during routine maintenance. These items prevent the weight of ice and snow accumulations from breaking or disconnecting air lines and wires.

Automatic Drain Valves (System without Air Dryer)

As we stated last year, routine reservoir draining is the most BASIC™ step (although not completely effective) in reducing the possibility of freeze-up. While automatic drain valves relieve the operator of draining reservoirs on a daily basis, these valves **MUST** be routinely checked for proper operation. Don’t overlook them until they fail and a road call is required.

