

Section 07: CNC Controls

Fadal's Block Diagram

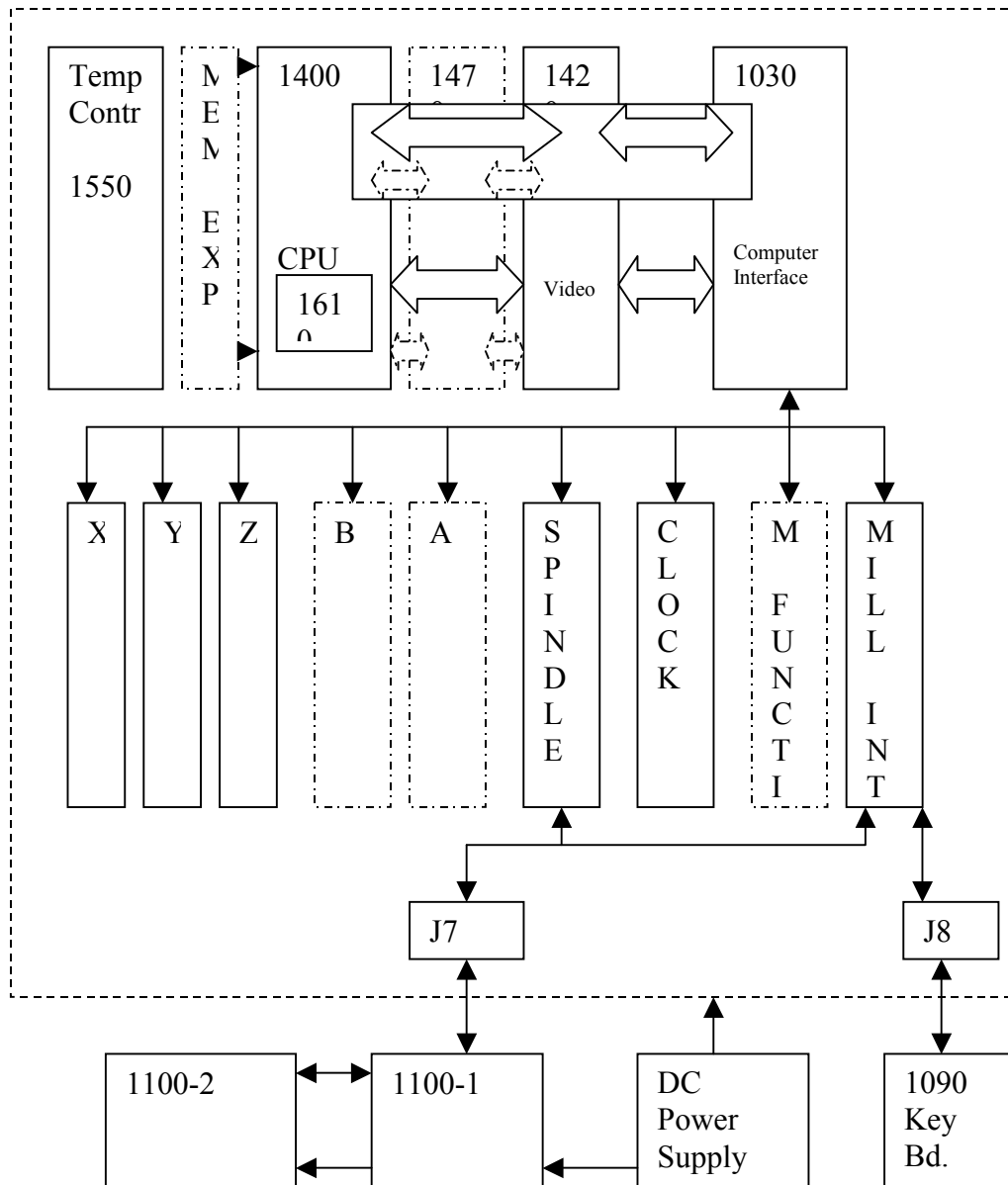

Electrostatic Discharge (ESD)

An electrostatic field is an electrical field surrounding objects with an electrical charge. This is a static electrical field and will vary for many reasons such as material or Relative Humidity. Everyone has experienced static electricity when you receive a shock by touching something. This shock is the static electricity discharging through a current path. ESD can and will damage electrical components. The damage may not be immediately noticeable and it could be hours, days or weeks before the circuit fails. To avoid the damage to the components follow the precautions listed:

- Do not touch leads or pins.
- Store boards or components in electrical conductive containers.
- Never install or de-install PBCA or electrical components with the power applied.
- Discharge yourself by touching the cabinet prior to handling components.
- Observing these precautions helps to reduce the failure rate.

Functional Description**Boards in Motherboard or Backplane**

The backplane or motherboard provides power and the interconnecting circuitry between the PCBs. The original backplane (1060-0) had 17 slots for PCBs and the current backplane (1060-1A) has 14 board slots. The reduction in slots was done for cost savings since with the newer PCBs the slots were no longer used. Also the new motherboard does not have TB1 and TB2 so if M-Functions are used a M-Function Interface board (1340-0) and cable (WIR-1679) are required. This difference is noted because the description will be done by slot location. The CPU PCB (1400) is the processing board and for this discussion will be referred to as 1400 with a dash number referring to different models of the board. The block diagram on the preceding page is for the 1400-5 model. However, it should be a good reference for all models.

Slot 1 to 4

The first two CPU PCBs (1400-1 & 1400-2) could be placed in any of the first five slots but is normally in slot 5. These first slots were used for memory expansion with a Optional Battery Backed Memory Board (1460-0 for 1400-1 & 1460-1 for 1400-2) which contained 128K of RAM. With the 1400-2 up to three of these Memory Boards could be installed. Each memory board needed to be configured with jumpers for the proper segment of memory. See the Board Jumper Configuration section for details. When Fadal started using a chiller on the coolant for the spindle and ballscrews a **Chiller Controller Board** (now in **Slot 3**) was added. The Chiller Controller Board (1550) uses the connection to the motherboard for DC voltage inputs but has no signals to the

other boards. The Chiller Controller monitors a ambient temperature and one or two coolant temperatures and activates the chiller(s) when temperature difference exceeds a couple of degrees.

Slot 5 This is the **Central Processing Unit (CPU) Board** (1400) slot. All CPU boards come with 38K of battery backed memory. This memory is used to store the following:

- CNC Part Program
- Tool Data – both Length and Diameter
- Fixture Offset Data
- SETP parameters
- Backlash

The CPU board executes the part program by issuing commands to the other boards and monitors the inputs from the other boards and proceeds as required by program and external information.

The Fadal CPUs are as follows:

- **1400-1** – This was the first CPU, it is very rare, if you have problems with one please call Fadal for assistance.
- **1400-2** – Served many years as the CPU. Can be in any of the first 5 slots however try to keep them in slot 5. Has a **Program Module** (1610-0) plugged into it, this module provides the operating program for the CPU. For optional memory expansion, memory expansion boards (1460-1) were added in slots 1 to 4. Each board contained 128K. Up to three memory boards could be added for a total of 422K.
- 1400-3 – This CPU board was an interim CPU between the 1400-2 and the 1400-4. It has to be in slot 5 because of the bus board which connects the Computer Interface Board and the CPU. This CPU uses the Computer Interface for the video signal. This CPU uses the **Program Module** (1610-1) and the Expanded Memory Boards that plug into the CPU Board. (J4-J5) Up to 422K Expanded Memory total.
- 1400-4 – This CPU board was used for years. It has to be in slot 5 because of the processor bus board which connects the Computer Interface Board (1030), the Video Graphics Board (1420-4) and the CPU. This CPU uses the Video Graphics for the video signal and the graphics. This CPU uses the **Program Module** (1610-1) and the Expanded Memory Boards that plug into the CPU Board. (J4-J5) Up to 422K Expanded Memory total.
- 1400-5 - This CPU board is the current CPU. It has to be in slot 5 because of the processor bus board which connects the Computer Interface Board (1030), the Video Graphics Board (1420) and the CPU. This CPU uses the Video Graphics for the video signal and the graphics. This CPU uses the **Program Module** (1610-1) and the **Expanded Memory Boards** that plug into the CPU Board. (J4-J5) Up to 16MB Expanded Memory total.

Expanded Memory Boards that plug into the CPU Boards at J4 and J5 are as follows:

- 128K Expanded Memory Board (1460-21) PCB-0040
- 384K Expanded Memory Board (1460-22) PCB-0041
- 4MB Expanded Memory Board (1460-34) PCB-0042
- 8MB Expanded Memory Board (1460-38) PCB-0043
- 16MB Expanded Memory Board (1460-316) PCB-0044

Slot 6 If either the Dual Arm Tool Changer (DATC) or the Advanced Feed Forward (AFF) option is installed in the machine then a **Option Sec. PCB (1470)** PCB-0191 will occupy this slot. This board requires a processor bus board connection.

Slot 7 This spot has the **Video / Graphics Board (1420-6)** installed. It provides Video display storage, Video monitor control, Graphics Display and Video output (J2). This board is connected to the processor bus board. This slot had a **Video Board (1420)** for the 1400-1 and 1400-2 CPU boards.

Slot 8 The **Computer Interface PCB (1030)** provides communication between the CPU and the controller and interface boards. The RS232 communications is also handled by this board. The functions performed by the 1030 are S100 Bus interface, Priority Interrupt and Device Selection. This board is connected to the processor bus board. During the 1400-3 CPU usage the Computer Interface board provided the Video Signal to the monitor.

Note: HS Processor Interface Board (1730-5 current) connects the 1400, 1470, 1420 and the 1030.

Slot 9 The **X-Axis Controller Board (1010)** belongs in this slot. Please see Axis Controller Board information section below.

Slot 10 The **Y-Axis Controller Board (1010)** belongs in this slot. Please see Axis Controller Board information section below.

Slot 11 The **Z-Axis Controller Board (1010)** belongs in this slot. Please see Axis Controller Board information section below.

Slot 12 The **B-Axis Controller Board (1010)** belongs in this slot. Please see Axis Controller Board information section below.

Slot 13 The **A-Axis Controller Board (1010)** belongs in this slot. Please see Axis Controller Board information section below.

Axis Controller Boards

The axis controller boards receive input position, direction and speed commands from the CPU via Computer Interface then outputs commands to the axis amplifier. The amplifier moves the axis motor and the resolver / tach or encoder provides position and speed information back to the controller board. The axis controller then uses this information to adjust the outputs to the amplifier to maintain the commanded speed and position. It also reports back to the CPU with the results. The Axis Controller boards are the same for each axis except for the jumper configuration at J4 position on the board and the EPROMs change from linear travel (X, Y, & Z) to rotary travel (A & B). The J4 jumpers determine the axis travel for that board. **It is very important that the jumpers are set correctly.** Refer to the Board Jumper Configuration section for proper configuration.

The Axis Controller boards store and use the ballscrew compensation, amplifier gain and position offset information. The position offset information is used for cold start position, for DC machine this would be zero unless glass scale option and for AC machine either the encode or glass scale.

There have been several versions of the Axis Controller board:

- 1010-1 has one program EPROM and one Tab EPROM (ballscrew compensation)
- 1010-4 has two program EPROMs U7 & U10 and comp., gain & offset are stored in EEPROM
- 1010-5 has two program EPROMs U15 & U18 and comp., gain & offset are stored in EEPROM
- 1010-6 has two program EPROMs U15 & U18 and comp., gain & offset are stored in EEPROM

Each version of the Axis Controller board requires its own software. The -5 & -6 versions use the same software. For the current proper software version for any board refer to the **“Fadal Machining Centers Current Software”** listing. This listing is published periodically and can be obtained by request.

The connections for the axis controller boards are: J1 – Signal 2 output, J2 – Resolver signal input, J3 – not used, J5 – Encoder input and J6 – Optional scale input. Not all of these connections are used on each machine.

Special configurations:

Servo Coolant option – uses an axis controller board with special program EPROMs. If no rotary table is installed, this board can be installed in either slot 12 or 13. With an A-axis installed the servo coolant must be in slot 12. If an A & B axis are installed, a Servo Coolant option CANNOT be added.

Tri-Tech Head option – both Axis Controllers in slot 12 & 13 are

configured as A-axis and SETP parameter is set.

Two pallets each with an A-axis option - both Axis Controllers in slot 12 & 13 are configured as A-axis and special software is installed.

The feedback to the Axis Controller boards for a DC machine is as follows:
The tach outputs a DC voltage to represent a speed in RPMs that is 7 VDC per 1000 RPM. A resolver is used to feedback the position. The resolver has two input signals generated by the Clock Board, they are called SIN and COS and are 10 VAC peak to peak (about 3.54 VAC on a meter). The resolver uses these two to generate a third signal, Resolver signal is 5 VAC peak to peak (about 1.77 VAC on a meter). Each Axis Controller board receives the resolver signal at J2 bullet connector. This voltage can be checked at this point the voltage must very close or there may be a problem with it. The controller compares the SIN and resolver signals to determine the position.

- J14** The **Resolver Test Board** (1060-0-1) PCB-0010 isolates the SIN and COS signals from the clock Board and distributes them to each axis. The result is that the machine can determine the axis at fault. If the motherboard has J14 and there is a DC axis then either a Resolver Test board or a Resolver Jumper board (1060-0-0) is required.

The feedback to the Axis Controller boards for a AC machine is as follows:
An incremental encoder provides position information from the motor. It operates with light source through a focus lens through rotating glass disk with precision etched lines through a light mask to two photoelectric cells offset 90 degrees from each other. This creates 5 volt square waves A,/A,B,/B. A and /A are 180 degrees out of phase as well as B and /B are 180 degrees out of phase. A and B are 90 degrees out of phase, by counting the pulses the position can be determined and the direction is determined by is A or B the first signal. This information is sent to the controller board. The 3 phase input from the hall effect (U,V,W) returns the rotor position feedback for the amplifier to compensate the magnetic fields to optimize the motor operation. The motor has a temperature sensor to detect over temperature in the motor, information is returned in the hall effect cable. The amplifier sends a Absolute Current signal to J3 on the controller board. This signal is 1 volt for every 4 amperes output by the amplifier. The amplifier provides test points, they are: Signal – is a 1:2 output of the differential signal + & - input, Tach – a scaling output of 4 volts per 1000 RPM created by the amp from the encoder information, ABS – the current output to all 3 phases. Scaling is 1 volt per 4 amperes.

- Slot 14** The **Spindle Controller Board (1010)** is a 1010 controller board but is NOT interchangeable with the axis controller because different components are installed on the board. An exception is the 1010-6 which has jumpers for both axis and spindle controller configurations. The Spindle Controller board must

have spindle jumper configuration and the proper spindle software. The Spindle Controller sends the spindle forward and reverses signals to the 1100-2 board and the speed command directly to the spindle drive. Encoder information is fed back to the controller for rigid tapping, this provides spindle position to coordinate Z axis with spindle. A 1010-1 can not be used as a rigid tapping spindle controller.

Slot 15 The **Clock Board (1020)** generates the system clock signals used for feedrate control and Sine / Cosine signals to the resolver to be used for position feedback. The feedrate override control pot signal is input at J1.

Slot 16 The **M-Function Board (1050)** is used when more than the five standard M-Functions is required or when a return signal is required. Please refer to detailed section (Section 09 Attached Optional Devices – M-Function Board use and setup).

Slot 17 The **Mill Interface Board (1040)** interfaces the control to the relays, switches, sensors and keyboard. It takes the CPU commands and activates the relays to perform the commanded task. Reads the sensors, switches and keyboard and sends the information to the CPU via Computer Interface Board.

Boards Outside the Motherboard

The **Power Distribution and Relay PCB 1100-1** has inputs of 120VAC, 5VDC and the control signals. The control signals used by the 1100-2 board are routed to another connector and go to the 1100-2 board. The control signals from the Mill Interface (1040) activate relays when required by pulling the control line low or about zero volts. This board has the Emergency Stop relays K1 & K2, high & low range, coolant pumps, Amplifier control, M-functions and power to the pendant.

The **Power Distribution and Relay PCB 1100-2** has inputs of 120VAC, 5VDC and the control signals. The control signals from the Mill Interface (1040) and Spindle Controller (1010) activate relays when required by pulling the control line low or about zero volts. This board has the spindle forward & reverse signals, ATC controls, Drawbar, Orientation and waylube.

The **Keyboard Interface Board 1090** receives inputs from the Keyboard, Manual Pulse Generator (MPG), Remote MPG (optional), optional stop, block skip, rapid travel, Resolution, axis selection, emergency stop, keylock, slide hold and start switches codes and sends the information to the Mill Interface (1040) board. Also takes the feedrate pot input and sends it to the clock board and the spindle pot input and sends it to the Spindle Controller board.

DC Power Supply

The Fadal VMCs require a DC Power Supply. The power supply requires an input voltage of 115VAC (105-125VAC @ 47-63Hz). This input is provided from the transformer and the Start / Brown-out circuit has a Solid State Relay (K1) on the power supply with the button mounted on the side of the cabinet by the main power quick disconnect box. The brown out will occur at around 70VAC for the Condor and around 50VAC for the Tri-Mag power supply. The Outputs are +5VDC (+5.05-5.5VDC), +12VDC (+11.9-12.6VDC) and -12VDC (-11.9-12.6VDC). Maximum ripple on all outputs is 1% Peak to Peak Volts.

**Door Interlock
Monitor Board 2000-
1B (PCB-0196)**

- Terminals** The terminal connections for the 2000-1B are identical to the 2000-1A.
- The 2000-1B has two additional connectors (J3 and J4) that are for future use. These connections do not change the functioning of the board.
- Inputs** There are three door interlock switches monitoring the left access panel, right access panel and front door respectively. Each switch has a normally open and a normally closed contact. Each switch and each contact are monitored separately. These inputs are J1 pins 1-12.
- The 120 VAC Emergency Stop circuit from 1100-1 TB1-10 goes to J2 pin 5.
- Outputs** The logic level outputs are external slide hold (J1 pin 16), and additional external slide hold and "OK" signals (J3 and J4). A 120 VAC output to control the spindle contactor is at J2 pins 3 and 2.
- Power** The board requires +5V and COM (J1 pins 15 and 17). If these inputs are reversed, diode D12 will short out the board, preventing damage. The 120 VAC is also required for operation (J2 pins 1 and 6).
- Operation** The 2000-1B monitors the interlocks for the three doors. If any door is open, an External Slide Hold is sent to the CNC control. If one circuit of the switch indicates door closed but the other indicates door open, a door open condition will be assumed by the board. The External Slide Hold is sent immediately when a door is opened. In addition, after a 5-10 second delay which allows time for a controlled stop, the spindle contactor will be de-energized, LEDs which removes power to the spindle drive; the delay is adjustable within the range of 5 seconds minimum to 10 seconds maximum by the Delay Adjust

potentiometer (R48). An Emergency stop will also de-energize the spindle contactor after the delay.

J3 and J4 are for future use. J3 pin 1 is identical to J1 pin 16 (active low output to generate External Slidehold). J3 pin 2 is an active high External Slidehold. J4 are Doors Closed signals which will change with the Doors Closed LED (D10). J4 pin 1 is active high (sourcing) and J4 pin 2 is active low (sinking).

Indicators (LEDs)

The LEDs on the 2000-1B are slightly different than the 2000-1A:

- There is only one green LED (D10) for the doors. It will be on only if all doors are closed and all circuitry is indicating doors closed.
- There is a separate red LED for each door circuit (one for the normally open of each door and one for the normally closed of each door). The red LED will be on if that circuit is indicating a door open condition.
- There is a yellow LED for each door. This indicates a fault condition in a door circuit (i.e. one circuit indicating door open but the other indicating door closed). This LED will flash whenever the door is opened or closed because the two circuits do not change state at the exact same instant. The flash is normal.
- There are two red LEDs for the External Slidehold outputs. D16 indicates the status of J1 pin 16 and J3 pin 1. D17 indicates the status of J3 pin 2. The LEDs light when the output is active. J1 pin 16 and J3 pin 1 are active low. J3 pin 2 is active high. J3 is for future use.
- A green LED has been added for the status of the spindle solid state relay. It will light when the output for the spindle contactor is on. In other words, it will light when all the doors are open and will go out 5-10 seconds after a door is opened.

Emergency Stop Circuit Overview

Basic Hardware Operation Description: Normal Operation (No Fault)

The Emergency Stop (E-stop) circuit is designed to stop the moving functions of the machine when a fault is detected.

When the CPU (1400) issues an enable E-stop command to the Mill Interface (1040), the Mill Interface pulls Panic line (pin 15) down (to ground or about zero volts) which activates K20 on the Power Distribution (1100-1). With K20 contacts closed, 120 VAC is allowed to flow through fuse F14 out 1100-1 TB2-26 to the overload relay switch contacts (number of relay(s) vary for different models and configurations) and the E-stop switch (normally closed) then returns to 1100-1 TB1-10. From this point a wire is contacted to 1100-2 TB1-25 and on the 1100-1 to the coils of K1 and K2, activating K1 and K2.

K1 and K2 normally closed contacts open. One side of these contacts is connected to ground. The other side to the fault lines (1100-1 TB1-2, TB1-3, TB-4, TB1-5, TB1-6, TB1-7), by opening the contacts the 10VDC (8 to 12 VDC) fault lines will allow the Axis Amplifiers or Spindle Drive and Controller PCBA to operate. K2 normally open contacts are connected to 120 VAC through fuse F17 and outputs (1100-1 TB1-8) to the control input on the Amplifier Chassis. This control input activates the solid-state relays on the Amp. Chassis closing the contacts and allowing power to the bridge rectifiers to power up the Amplifiers.

The connection to the 1100-2 (TB1-25) has three paths on the board. The first connects to the coil of K33 and activates the relay closing the contacts and allowing the 120 VAC input power to the Turret Motor. The second supplies 120 VAC to Spindle Forward, Spindle Reverse and Orientation circuits. The third connects through the normally closed contacts of K3 and provides power to the Drawbar and Slide Motor Reverse circuits. This third path also provides a safety function by removing power for the Drawbar and Slide Motor Reverse circuits when the Spindle Forward (K3) is activated.

This is the normal operation of the E-stop circuit providing power to all the circuits involved and allowing the fault lines to stay up (10VDC).

Fault Condition When there is a fault, the E-stop circuit shuts down the machine. It accomplishes this by removing the power to each device. First, the power to K1 and K2 is removed connecting all the fault lines to ground. This informs the Amplifiers and the Controller Boards that they are in E-stop. It also removes the control voltage to the Amplifier Chassis, which removes the power to the Amplifiers. The 120 VAC to the 1100-2 is removed and this causes K33 to open its contacts and stop the Turret Motor. Power is removed from Spindle Forward, Spindle Reverse, Orientation, Drawbar and Slide motor Reverse circuits.

Functional Block and Wiring Diagrams are at the end of this section.

Basic Software Operational Description There are many possible combinations of software functions. The computer board CPU(1400) communicates with the Computer Interface (1030), which communicates with the other boards, Axis Controllers (1010), Spindle controller (1010) and the Mill Interface (1040), or vice versa.

If the CPU initiates an E-stop condition then it disengages the panic line.

The Axis Controllers declares an E-stop to the CPU upon detecting the Fault line down (if cold started) or if the controller detects a problem in operation of the axis, such as the following error being too large.

If the operator hits the E-stop switch then the switch opens the 120VAC line to the 1100-1 TB1-10 to initial the hardware E-stop and reports to the CPU through the Keyboard Interface (1090) to the Mill Interface to the Computer Interface to the CPU.

Troubleshooting Tips

Some possibilities for error and troubleshooting tips:

- The machine does not use K18.
- Some of the new machines do not have Overload Relays.
- For troubleshooting purposes, place a jumper between F16 and F12 this bypasses the automatic part of the circuit. Use caution when the machine is jumpered because it cannot stop itself. An AC machine must be powered up with the E-stop button pushed in, because the axis will run away if control is not up first.

Emergency Stop and Fault Circuit

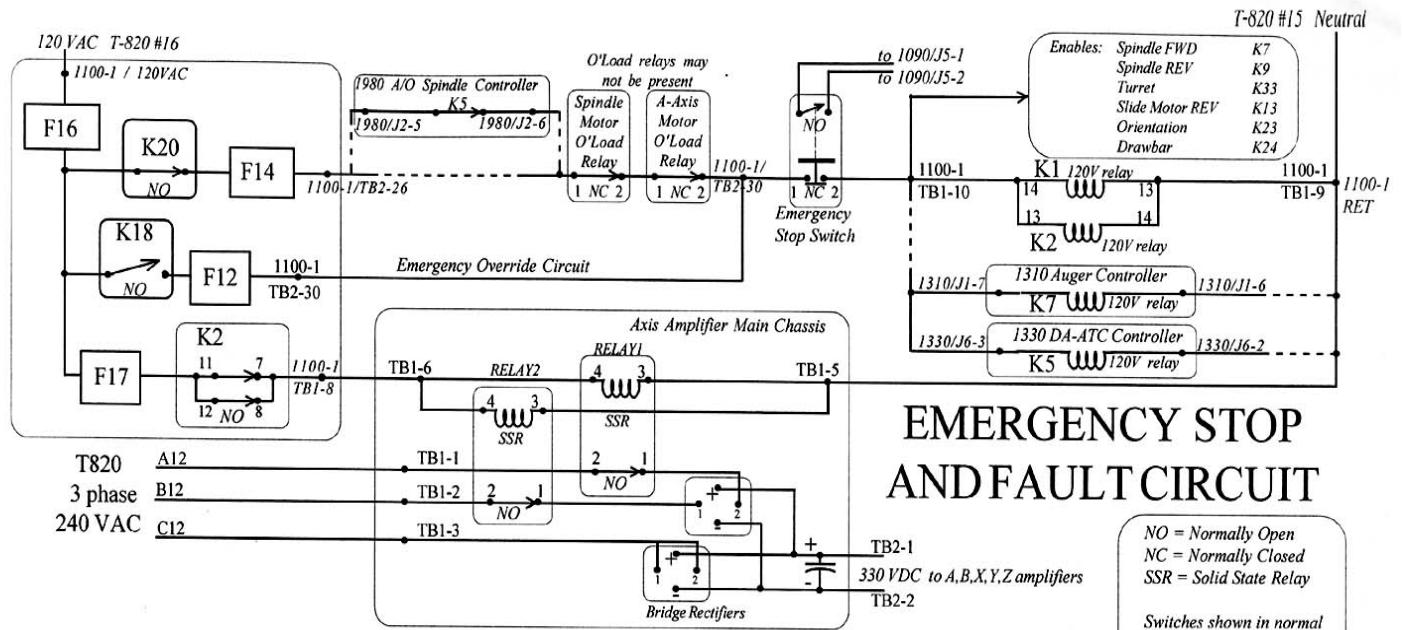

EMERGENCY STOP AND FAULT CIRCUIT

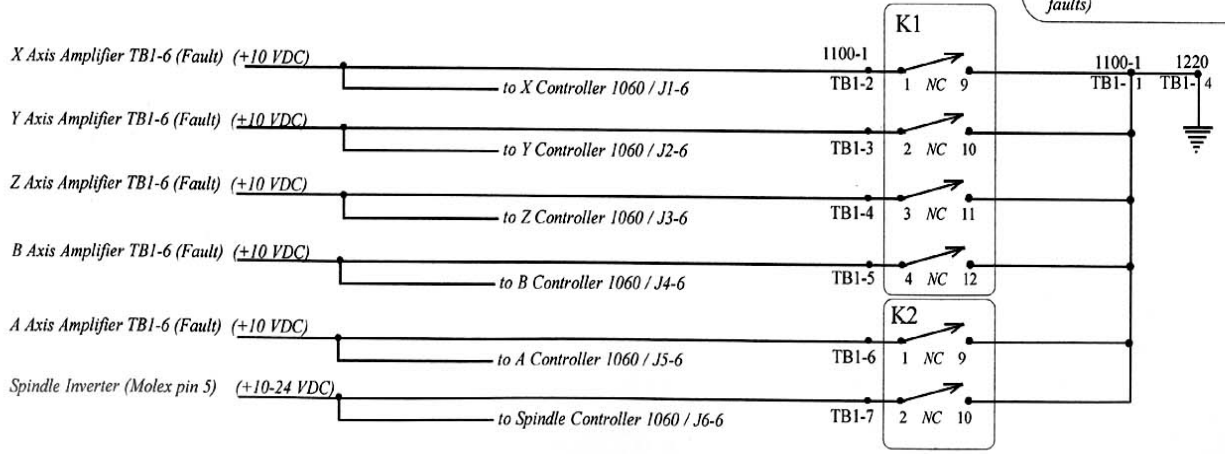

Emergency Stop Circuitry

EMERGENCY STOP CIRCUITRY

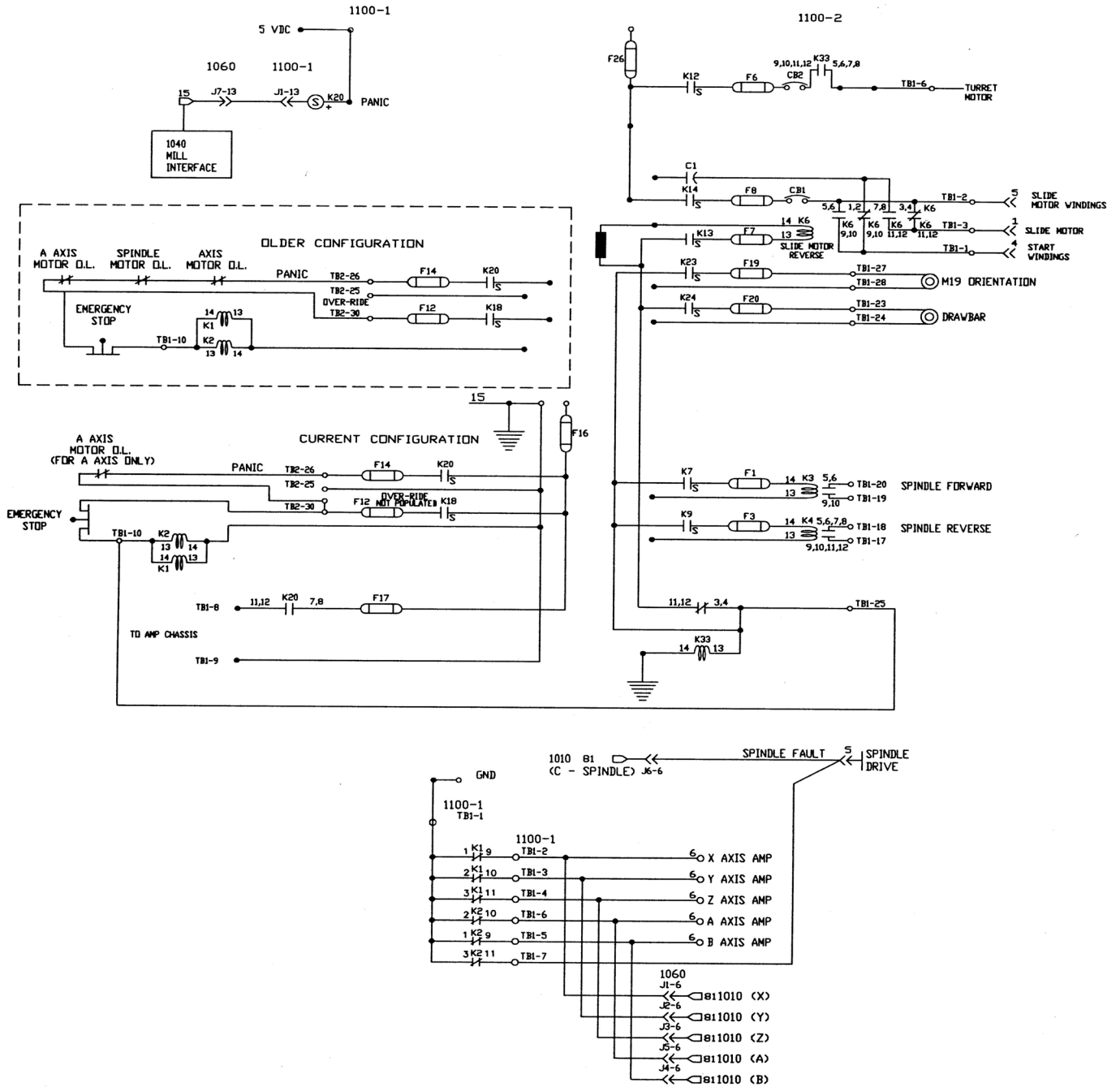

Fadal Axis Board Jumper

Axis Board 1010-6 at the J4 is an access connection jumper. Jumper the required axis as shown on the silk screen.

Axis Boards 1010-1, 1010-4 and 1010-5 at the J4 Jumper Block are as follows:

Slot 9- X Axis Controller (5 to 12, 7 to 10, 8 to 9)

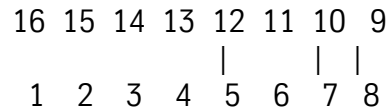

Slot 9- X Axis Controller 4020 w/ Pallet, 3020, 4525 (7 to 10, 8 to 9)

Slot 9- X Axis Controller

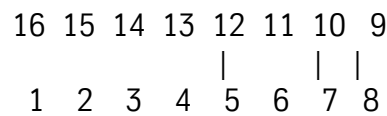

Slot 10- Y Axis Controller (5 to 12, 6 to 11, 8 to 9)

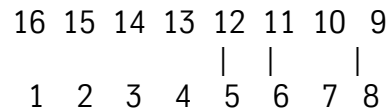

Slot 11- Z Axis Controller (8 to 9)

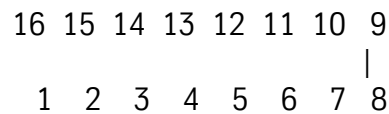

Slot 14- Spindle - C Axis Controller (5 to 12, 6 to 11)

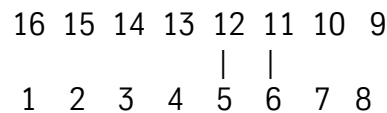

Note: Jumper 5 to 12 is for direction. This jumper may or may not be installed due to other wire connections. The following are marked as the standard

but may be incorrect for the wiring connections in a given machine or rotary table.

Slot 13 –A Axis Controller – VH65, TR65, SMW 175, SMW 275 (5 to 12, 7 to 10)

Tri Tech Head both controller boards

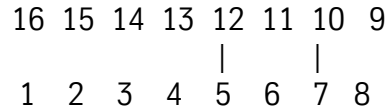

Slot 13 – A Axis Controller – VH5C, VH65 Left Hand, Tsudakoma A, Technara, V 300, V 400, SMW 225 (7 to 10)

Note: AC motor tables also need the red and black wires reversed from normal for this configuration.

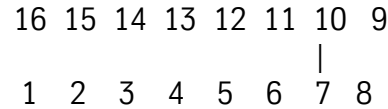

Slot 13 – A Axis Controller – Tsudakoma A & B (6 to 11, 7 to 10)

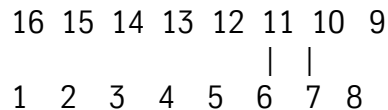

Slot 12 – B Axis Controller – TR65 (5 to 12, 6 to 11, 7 to 10)

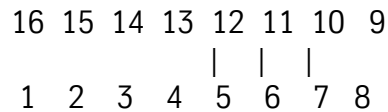

Slot 12 – B Axis Controller – Tsudakoma (5 to 12, 7 to 10)

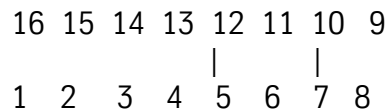

**Axis Controller
1010-6**

For axes X, Y, Z, A & B place jumper on proper position on J4 and jumpers at J16 & J19. For Spindle place jumper on proper position on J4 and install jumpers at J17 & J18. Install J4 REV-Dir, as required.

1460-1 Memory Expansion Boards

Expanded Memory Board – Slot 1-4 First 128K (10 to 16, 11 to 15)

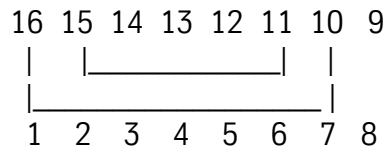

Expanded Memory Board – Slot 1-4 Second 128K (12 to 16, 13 to 15)

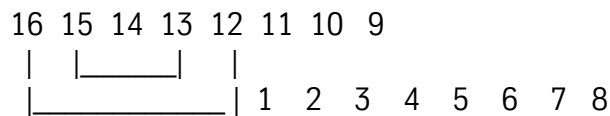

Expanded Memory Board – Slot 1-4 Third 128K (1 to 15, 14 to 16)

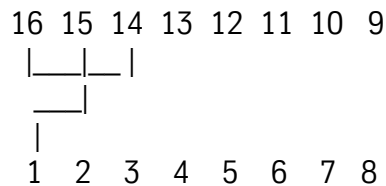

Master Feedrate

The master feedrate clock is adjusted by potentiometer R6 on the clock Rate Clockcard (1020), slot #15. This is the second potentiometer from the bottom as the card is in the machine (it can also be found just above the feed rate potentiometer connector). The adjustment procedure is as follows:

- 1) Enter the command PR <ENTER>
- 2) Press #3 (START NEW PROGRAM) <ENTER>
- 3) Enter NEW PROGRAM NUMBER <ENTER>
- 4) Press #6 (EXIT)
- 5) From the prompt ENTER NEXT COMMAND type in IN <ENTER>

Enter the following program:

```
N1 G91
N2 X-20. F100. G1 G8 M49
N3 X20.           (continued)
```

N4 X-20.
N5 X20.
N6 X-20.
N7 X20.
N8 M2_ _

- 6) From the prompt ENTER NEXT COMMAND: Type in SETCS then home the machine with the HO command.
- 7) Position the X axis at +10 inches if travel is less than 40 inches on X. Enter the SETX command.
- 8) Push the AUTO key to begin program execution.
- 9) When the program is complete, the time will be shown in the top right-hand corner of the video display. The move should take 72 seconds +1.5/-0.
- 10) If not, adjust potentiometer R6 until the move takes 72 seconds +1.5/ -0 to complete.

Feedrate Potentiometer (Pot) Adjustment

- 1) After cold starting the machine go to Manual Data (MD) mode.
- 2) Enter "X-10. G0" <ENTER> <START>
- 3) Enter "X20. G1 F100. M49" <ENTER>
- 4) Observe the following error number while axis is moving.
- 5) Enter "X-20." <ENTER>
- 6) Observe the following error number while axis is moving. This number should be the same as in the positive direction. If not, the Amplifier Loop Gain adjustment needs to be performed first.
- 7) Set the feedrate pot on 100%.
- 8) Enter "X20. G1 F100. M48" <ENTER>
- 9) Observe the following error number while axis is moving. If the following error is the same as before then it is set correctly. If it is not, turn pot until the following error is the same and loose and adjust the knob to 100%.
- 10) Enter "G28" <ENTER>
- 11) Turn feedrate pot to 0%.

- 12) Enter "X-2.0 G1 F100. M48" <ENTER>
- 13) If the X axis does not move then it is set correctly. If the X axis moves, adjust R19, the third pot up from the bottom on the Clock board for no movement.
- 14) <SLIDE HOLD>
- 15) <MANUAL>

Zero Out Memory Procedure

A Zero Out Memory chart follows this procedure.

- 1) Send machine to COLD START.
 - Type SETCS < ENTER >
 - Type HO <ENTER>
 - Press START.
- 2) Display and record the BACKLASH settings.
- 3) Type BL <ENTER>. Record the displayed values.
- 4) Display and record the PARAMETER settings. **NOTE:** Some parameters appear ONLY in Format 1 or in Format 2, but NOT IN BOTH FORMATS.
 - Type SETP <ENTER>. Record the displayed values.
 - Type P <ENTER> to display the second page of settings. Record the displayed values.
 - Type P <ENTER> to display the third page of settings. Record the displayed values.
- 5) After all BACKLASH and PARAMETER settings have been recorded, zero memory:
 - Press <MANUAL> to get to ENTER NEXT COMMAND.
 - Type DI < ENTER >.
 - Type GO 3000 <ENTER> to display the Diagnostics Menu.
 - Press spacebar to get to Page 2 of the Diagnostic Menu, and select option 5 -- ZERO MEMORY.
 - Answer "Y" (type Y) to both questions the control asks. Memory is reset.

NOTE: If you are replacing a module(s), now is the time to power down the machine, replace the modules, and power up. Then proceed directly to STEP 6 below.

- Select option 2-START CNC. This will take the control back to ENTER NEXT COMMAND.

6) Restore PARAMETER values as needed:

NOTE: The control will ask for BACKLASH values, but the PARAMETER values must be checked first.

- Type SETP <ENTER> to check and, if needed, reenter PARAMETER settings -page 1.
- Type P <ENTER> to check and, if needed, re-enter PARAMETER settings -page 2.
- Type P <ENTER> to check and, if needed, re-enter PARAMETER settings -page 3.

7) Restore BACKLASH values:

- Power off the machine, wait 15 seconds, power on the machine, then COLD START.
- Enter the BACKLASH values previously recorded as follows:
 - for X axis BL,1,value1, value2, value3 <ENTER>
 - for Y axis BL,2,value 1, value2, value3 <ENTER>
 - for Z axis BL,3,value <ENTER>
 - for A axis BL,4,value <ENTER>
 - for B axis BL,5,vafue <ENTER>

8) Load the programs and offsets back into the machine. The procedure is now complete.

Zero-out Memory

LAST HOME POSITION X _____ Y _____ Z _____

X-AXIS BACKLASH _____ , _____ , _____
Y-AXIS BACKLASH _____ , _____ , _____
Z-AXIS BACKLASH _____
A-AXIS BACKLASH _____
B-AXIS BACKLASH _____

BACKLASH settings

PARAMETER settings – Page 1

FORMAT: _____	BAUD RATE: _____	SPINDLE AFTER M6: _____
AXES: _____	TRAVEL: _____	PENDANT: _____
DEFAULT: _____	A-AXIS RATIO: _____	M60/A-AXIS BRAKE: _____
DEFAULT: _____	B-AXIS RATIO: _____	M60/B-AXIS BRAKE: _____
DEFAULT: _____	TOOL CHANGER CAP: _____	IMM FIXED CYCLE: _____
RPM FACTOR: _____	SPINDLE TYPE: _____	ORIENTATION FACTOR: _____

PARAMETER settings – Page 2

DEFAULT: _____	M8: _____ M7: _____	3 PHASE > 5% LOW: _____
PU FORMAT: _____	N-WORDS ORDERED: _____	TOOL TABLE: _____
CRC MODE: _____	BINARY BUFFERS: _____	HIGH TORQUE: _____
SPINDLE OFF: _____	TURRET FACTOR: _____	CMD MENU: _____
PALLET: _____	GAIN: _____	RAMP: _____
ASPECT: _____	TIMERS: _____	OVERLOAD: _____

PARAMETER settings – Page 3

SCREW: _____	IPM: _____	XYZ RAMP: _____
Z TAP GAIN: _____	VECTOR: _____	AXIS DISPLAY: _____
AUTO BRAKE: _____	A-PALLET: _____	B-PALLET: _____
5-AXIS HEAD: _____	GO DETAIL: _____	FEEDBACK: _____

PCBA Compatibility Chart

PCBA Number	Description	1	2	3	4	5	Notes
1400-1	CPU	X					
1400-2	CPU		X				
1400-3	CPU			X			
1400-4	CPU				X		
1400-5	CPU					X	
1460-1	128K RAM Expansion	X	X				
1460-21	128K RAM Expansion			X	X	X	
1460-22	384K RAM Expansion			X	X	X	
1460-34	4MB RAM Expansion					X	
1460-38	8MB RAM Expansion					X	
1460-316	16MB RAM Expansion					X	
1420	Video	X	X				
1420-4	Video Graphics				X	X	
1420-5	Video Graphics 32 MP				X	X	
1420-6	Video Graphics VGA					X	
1030	S100/ Interface	X	X				
1030-1B	S100/ Video			X			
1030-1C	Computer Interface				X	X	
1010-1	Axis Controller	X	X				
1010-4	Axis Controller		X	X	X	X	
1010-5	Axis Controller				X	X	
1010-6	Axis/Spindle Controller				X	X	
1010-1S	Spindle Controller	X	X	X	X	X	No Rigid Tap
1010-4S	Spindle Controller		X	X	X	X	No Rigid Tap
1010-5S	Spindle Controller			X	X	X	
1020-0D	Clock				X	X	
1020-0F	Clock	X	X	X	X	X	
1050-0	M-Function (up to 20)	X	X	X	X	X	
1050-3A	M-Function (2 function)	X	X	X	X	X	
1040	Mill interface	X	X	X	X	X	
1040-2	Mill Interface	X	X	X	X	X	Pallet Changer
1090	Keyboard Interface	X	X	X	X		
1090-3A	Keyboard Interface		X	X	X	X	CNC HS88
1090-4B	Keyboard Interface			X	X	X	32 MP Only
1100-1	Power Distribution	X	X	X	X	X	
1100-2	Power Distribution	X	X	X	X	X	

1100-3	Power Distribution			X	X	X	Pallet Changer
1170	Power Surge	X	X	X	X	X	240 VAC input
1170-1	Power Surge	X	X	X	X	X	480 VAC input
1550-0B	Temp. Controller		X	X	X	X	
1550-2	Dual Temp Controller		X	X	X	X	
1610-0	Program Module		X				
1610-1	Program Module			X	X	X	
1750-0	Modem		X	X	X	X	
1730-0	Buss Board			X			
1730-4	Buss Board			X	X	X	
1730-5	Buss Board			X	X	X	Required 1470
1470	Option Sec.					X	
1310-0	Auger Board					X	
1330	DATC Controller Board					X	