

SECTION 4: MATHEMATICAL MODELING

ESE 330 – Modeling & Analysis of Dynamic Systems

Introduction

In the last section of notes, we saw how to create a bond graph model from a physical system model.

The next step in the modeling process is the creation of a mathematical model

Mathematical Modeling – Introduction

3

- You're already familiar with some techniques for creating mathematical models for physical systems

- For example:

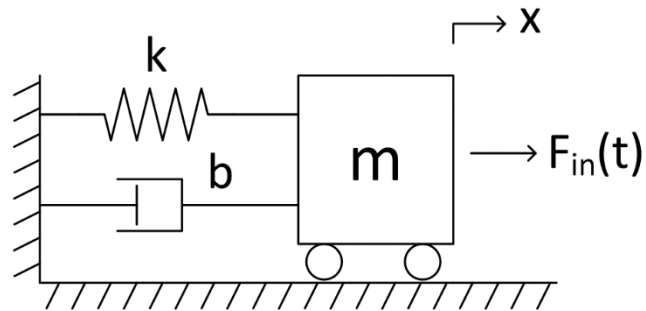

- First, create a free-body diagram:

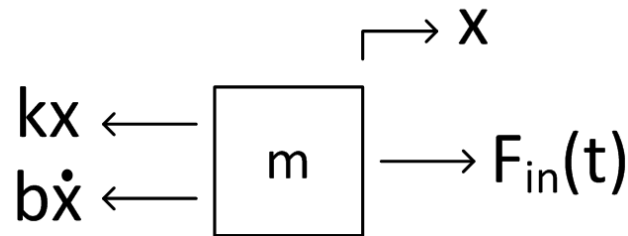

Mathematical Modeling – Introduction

4

- Next, apply Newton's 2nd law

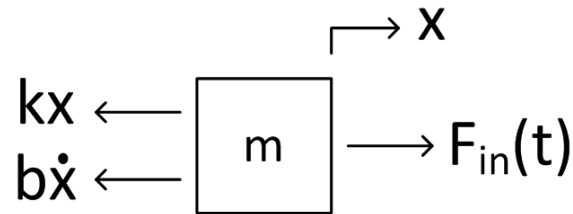

$$\Sigma F = ma$$

$$F_{in}(t) - kx - b\dot{x} = m\ddot{x}$$

rearranging:

$$m\ddot{x} + b\dot{x} + kx = F_{in}(t) \quad (1)$$

- This is a **mathematical model**
 - ▣ A second-order, linear, constant-coefficient, ordinary differential equation

Reduction to a System of 1st-Order ODE's

5

- Can reduce this 2nd-order ODE to a system of two 1st-order ODE's
- We know that

$$\dot{x} = v \quad (2)$$

and

$$\ddot{x} = a = \dot{v} \quad (3)$$

- Using (2) and (3), rewrite (1), the original ODE

$$m\dot{v} + bv + kx = F_{in}(t)$$

where

$$v = \dot{x} \quad (4)$$

Reduction to a System of 1st-Order ODE's

6

- Equations (4) is a system of first-order ODE's that is equivalent to (1)
- Rearranging (4):

$$\begin{aligned}\dot{v} &= -\frac{k}{m}x - \frac{b}{m}v + \frac{1}{m}F_{in}(t) \\ \dot{x} &= v\end{aligned}\tag{5}$$

- These equations can be put into matrix form :

$$\begin{bmatrix} \dot{x} \\ \dot{v} \end{bmatrix} = \begin{bmatrix} 0 & 1 \\ -\frac{k}{m} & -\frac{b}{m} \end{bmatrix} \begin{bmatrix} x \\ v \end{bmatrix} + \begin{bmatrix} 0 \\ \frac{1}{m} \end{bmatrix} F_{in}(t)\tag{6}$$

Reduction to a System of 1st-Order ODE's

7

- Let's say we want to consider the ***displacement*** of the mass as the ***output*** of the system
- We can add an ***output equation*** to the mathematical model

$$y = x \tag{7}$$

- We can rewrite (7) in a matrix form similar to (6):

$$y = [1 \quad 0] \begin{bmatrix} x \\ v \end{bmatrix} + [0]F_{in}(t) \tag{8}$$

Mathematical Model

8

- Together, (6) and (8) comprise the mathematical model for our mechanical system:

$$\begin{bmatrix} \dot{x} \\ \dot{v} \end{bmatrix} = \begin{bmatrix} 0 & 1 \\ -\frac{k}{m} & -\frac{b}{m} \end{bmatrix} \begin{bmatrix} x \\ v \end{bmatrix} + \begin{bmatrix} 0 \\ \frac{1}{m} \end{bmatrix} F_{in}(t)$$
$$y = [1 \quad 0] \begin{bmatrix} x \\ v \end{bmatrix} \tag{9}$$

-
- Note that \dot{x} , \dot{v} , x , v , and y are all ***functions of time***
 - The (t) is dropped to simplify the notation
 - The convention used here is to only include the (t) for ***inputs***, e.g. $F_{in}(t)$

State-Space Representation

9

- The system model of (9) is the ***state-space representation*** of the system, or the ***state-variable equations*** for the system
- Can be expressed in generic form as

$$\begin{aligned}\dot{\mathbf{x}} &= \mathbf{Ax} + \mathbf{Bu} \\ \mathbf{y} &= \mathbf{Cx} + \mathbf{Du}\end{aligned}\tag{10}$$

where

- \mathbf{x} : the state vector
- $\dot{\mathbf{x}}$: derivative of the state
- \mathbf{u} : vector of inputs
- \mathbf{y} : vector of outputs
- \mathbf{A} : system matrix
- \mathbf{B} : input matrix
- \mathbf{C} : output matrix
- \mathbf{D} : feed-through matrix

MIMO vs. SISO Systems

10

$$\begin{aligned}\dot{\mathbf{x}} &= \mathbf{A}\mathbf{x} + \mathbf{B}\mathbf{u} \\ \mathbf{y} &= \mathbf{C}\mathbf{x} + \mathbf{D}\mathbf{u}\end{aligned}\tag{10}$$

- Note that the state-space model (10) allows for **vectors of inputs and outputs**, \mathbf{u} and \mathbf{y}
- **Multi-input, multi-output (MIMO) systems**
 - ▣ \mathbf{u} and \mathbf{y} will be **vectors**
- **Single-input, single-output (SISO) systems**
 - ▣ u and y will be **scalars**
- In this course, we'll mostly focus on SISO systems
 - ▣ For now, we'll assume the more general MIMO case

System State and State Variables

11

- The vector \mathbf{x} is the ***state vector***
 - ▣ Elements of \mathbf{x} are the ***state variables*** of the system
- The **state** of the system is a complete description of the current condition of the system
 - ▣ From our energy-based perspective, the state describes all of the energy in a system, i.e. where it is stored, at a given point in time
- The **state variables** are *a* (not *the*) minimum set of system variables required to completely describe the ***state*** of a system

State Variables are Not Unique

12

- The state vector, i.e. the choice of state variables, for a system is ***not unique***
 - ▣ In this example, we have chosen displacement and velocity as the state variables, i.e.

$$\mathbf{x} = \begin{bmatrix} x \\ v \end{bmatrix}$$

- ▣ Could have chosen other quantities – later, we will
 - ▣ State variables need not even have direct physical significance
- Different state-space representations for the same system are related by ***similarity transforms***
 - ▣ Beyond the scope of this class

The Feed-Through Matrix

13

$$\dot{\mathbf{x}} = \mathbf{Ax} + \mathbf{Bu}$$

$$\mathbf{y} = \mathbf{Cx} + \mathbf{Du} \quad (10)$$

- **D** is the feed-through or feed-forward matrix
 - ▣ Very often zero for physical systems, as in our example
- Non-zero **D** implies that the input affects the output instantaneously
 - ▣ There exists a direct feed-through path from the input to the output

State-Space Vector and Matrix Dimensions

14

$$\begin{aligned}\dot{\mathbf{x}} &= \mathbf{Ax} + \mathbf{Bu} \\ \mathbf{y} &= \mathbf{Cx} + \mathbf{Du}\end{aligned}\tag{10}$$

- Assume the state space model of (10) represents an n^{th} -order, m -input, p -output MIMO system
- The **state vector** is an $n \times 1$ column vector
- The system has m inputs, so the **input vector** is an $m \times 1$ column vector
- There are p outputs, so the **output vector** is a $p \times 1$ column vector

State-Space Vector and Matrix Dimensions

15

$$\begin{aligned}\dot{\mathbf{x}} &= \mathbf{Ax} + \mathbf{Bu} \\ \mathbf{y} &= \mathbf{Cx} + \mathbf{Du}\end{aligned}\tag{10}$$

- If \mathbf{x} is $n \times 1$, then its derivative, $\dot{\mathbf{x}}$, is also $n \times 1$
- The product \mathbf{Ax} must have the same dimensions as $\dot{\mathbf{x}}$, $n \times 1$
 - ▣ The system matrix, \mathbf{A} , is a square $n \times n$ matrix
- The product \mathbf{Bu} must also be $n \times 1$
 - ▣ The vector of inputs, \mathbf{u} , is $m \times 1$, so \mathbf{B} is $n \times m$

State-Space Vector and Matrix Dimensions

16

$$\begin{aligned}\dot{\mathbf{x}} &= \mathbf{Ax} + \mathbf{Bu} \\ \mathbf{y} &= \mathbf{Cx} + \mathbf{Du}\end{aligned}\tag{10}$$

- The vector of p outputs, \mathbf{y} , is $p \times 1$
- The product \mathbf{Cx} must also have dimension $p \times 1$
 - ▣ \mathbf{x} is $n \times 1$, so \mathbf{C} must be $p \times n$
- The product \mathbf{Du} must also have the same dimension as \mathbf{y} , $p \times 1$
 - ▣ The vector of inputs, \mathbf{u} , is $m \times 1$, so \mathbf{D} is $p \times m$

State-Space Vector and Matrix Dimensions

17

- For an m -input, p -output, MIMO system:

$$\dot{\mathbf{x}} = \mathbf{A}\mathbf{x} + \mathbf{B}\mathbf{u}$$

$$\mathbf{y} = \mathbf{C}\mathbf{x} + \mathbf{D}\mathbf{u}$$

Term	Dimension
\mathbf{u}	$m \times 1$
\mathbf{y}	$p \times 1$
\mathbf{x}	$n \times 1$
$\dot{\mathbf{x}}$	$n \times 1$

Term	Dimension
\mathbf{A}	$n \times n$
\mathbf{B}	$n \times m$
\mathbf{C}	$p \times n$
\mathbf{D}	$p \times m$

State-Space Vector and Matrix Dimensions

18

- For SISO system, u and y , as well as D , are scalars:

$$\dot{\mathbf{x}} = \mathbf{A}\mathbf{x} + \mathbf{B}u$$

$$y = \mathbf{C}\mathbf{x} + Du$$

Term	Dimension
u	1×1
y	1×1
\mathbf{x}	$n \times 1$
$\dot{\mathbf{x}}$	$n \times 1$

Term	Dimension
\mathbf{A}	$n \times n$
\mathbf{B}	$n \times 1$
\mathbf{C}	$1 \times n$
D	1×1

State-Space Model Explained

19

- Remember, our reason for modeling a system is to enable the ***analysis of its dynamic behavior***

- Basic idea of the state space model:
 - If the current state of a system is known, and the current and future values of the inputs are known, then the trajectory of the system (i.e. the time-evolution of its state variables) can be determined

 - Don't need explicit knowledge of the history of the system or its inputs – no past information
 - All history is accounted for in the current value of the state

State-Space Model – Physical Significance

20

- Consider the physical meaning of the state-space system model

$$\dot{\mathbf{x}} = \mathbf{Ax} + \mathbf{Bu}$$

$$\mathbf{y} = \mathbf{Cx} + \mathbf{Du}$$

- The ***time derivative of a system's state variables*** can be expressed as a linear combination of the current state variables and the current inputs
- The ***outputs of a system*** can be expressed as a linear combination of the current state and the current inputs

State-Space Model – Utility

21

- Again, our goal is to analyze a system's time-domain behavior – the time-evolution of its state variables
- Knowledge of the current state variables, as well as the current rate of change of those state variables, allows us to do this

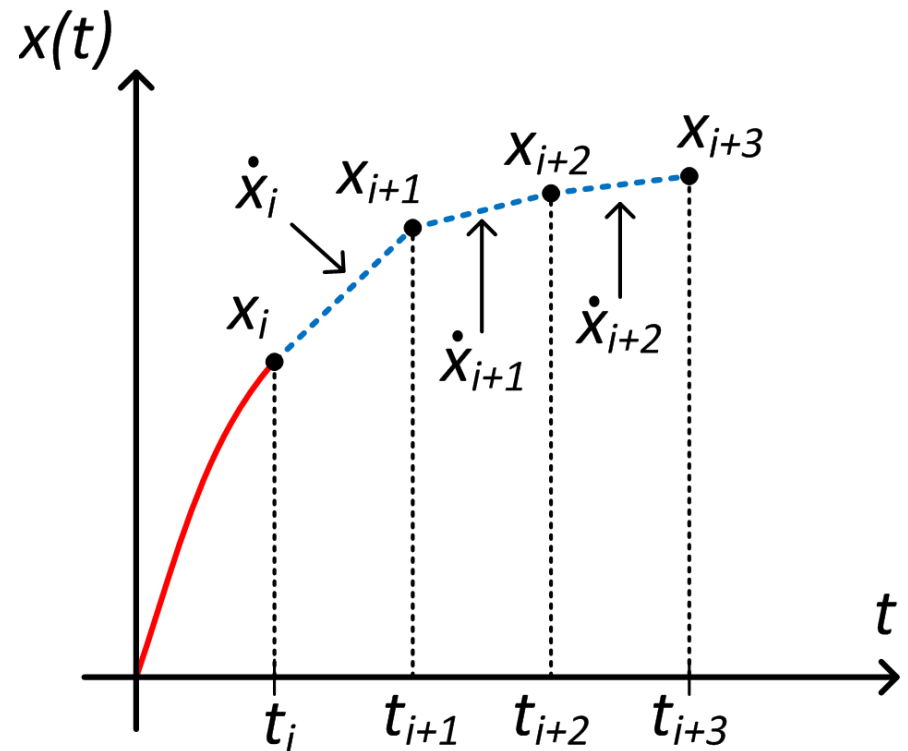

Where We're Going

22

- In the previous example, we derived the state-space model for a mechanical system by applying Newton's 2nd law
 - ▣ For an electrical system we could have applied Kirchhoff's and Ohm's laws
 - ▣ Can always derive a mathematical model by applying domain-specific laws to the physical model
- Our approach will be to ***derive state equations from bond-graph system models***

State Equations from Bond-Graph Models

23

- Bond graphs are ***energy-based*** models
 - ▣ Our choice of ***state variables*** will be those that describe the ***storage of energy*** within a system at a given instant in time
- State variables will be ***energy variables*** of the ***independent energy-storage elements*** in a system
 - ▣ ***Displacements of capacitors***
 - ▣ ***Momenta of inertias***
- Only independent ***I*'s** and ***C*'s**
 - ▣ State variables represent a minimum set of system variables needed to completely describe the state

24

State Equation Derivation

Deriving State Equations from Bond Graphs

25

- Start with the same mechanical **system model**:

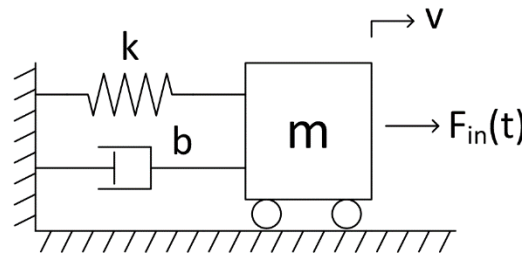

- The **computational bond graph**:

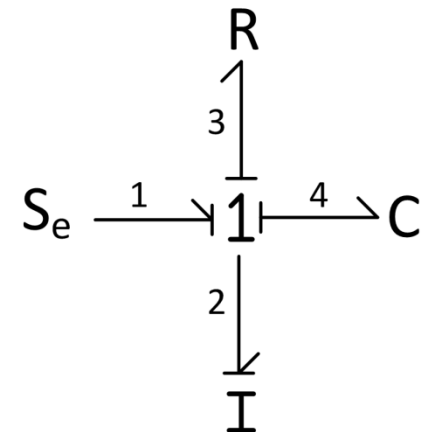

- Two independent energy-storage elements
 - ▣ **State variables** will be the **energy variables** associated with these two elements:

$$\mathbf{x} = \begin{bmatrix} p_2 \\ q_4 \end{bmatrix}$$

State Equation Derivation – State Variables

26

- State equation will be of the form:

$$\dot{\mathbf{x}} = \mathbf{A}\mathbf{x} + \mathbf{B}u$$

$$\begin{bmatrix} \dot{p}_2 \\ \dot{q}_4 \end{bmatrix} = \mathbf{A} \begin{bmatrix} p_2 \\ q_4 \end{bmatrix} + \mathbf{B}e_1(t)$$

- In general, state variables will be momenta and displacements
 - ▣ Their derivatives will be efforts and flows, respectively
 - ▣ For this example:

$$\begin{bmatrix} \dot{p}_2 \\ \dot{q}_4 \end{bmatrix} = \begin{bmatrix} e_2 \\ f_4 \end{bmatrix}$$

State Equation Derivation – Preparation

27

- **Annotate** the computational bond graph with **state variable derivatives**
 - ▣ Efforts on the independent Inertias and the flows on the independent Capacitors
- Apply constitutive laws to annotate the **other power variables** on the I 's and C 's
- Annotate the **known source power variables** and indicate as functions of time

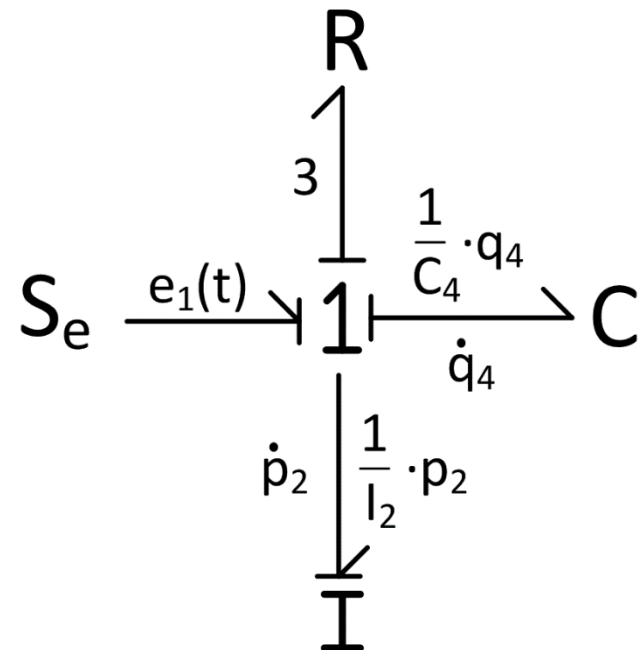

State Equation Derivation – Procedure

28

- **Objective**: derive a set of n equations, each expressing a state variable derivative as a linear combination of state variables and inputs
 - ▣ Determine the **A** and **B** matrices
-

- First, choose a state variable and write its derivative as an effort or flow:

$$\dot{p}_2 = e_2 \quad (1)$$

- Next, use the causality assigned to the bond graph to work from (1) to a state equation
 - ▣ Express \dot{p}_2 as a linear combination of states and inputs
 - ▣ Will ultimately relate an effort or flow to a state variable by applying a constitutive relationship for an energy-storage element

State Equation Derivation

29

- e_2 is an effort on a 1-jct
 - ▣ Caused by e_1 , e_3 , and e_4 , and e_1 is known, so

$$\dot{p}_2 = e_2 = e_1(t) - e_3 - e_4 \quad (2)$$

- Relate e_3 to f_3 using the const. law for the resistor

$$e_3 = R_3 f_3 \quad (3)$$

- f_3 is the flow on a 1-jct, set by f_2 , related to s.v. p_2 by the const. law for the inertia

$$f_3 = f_2 = \frac{1}{I_2} p_2 \quad (4)$$

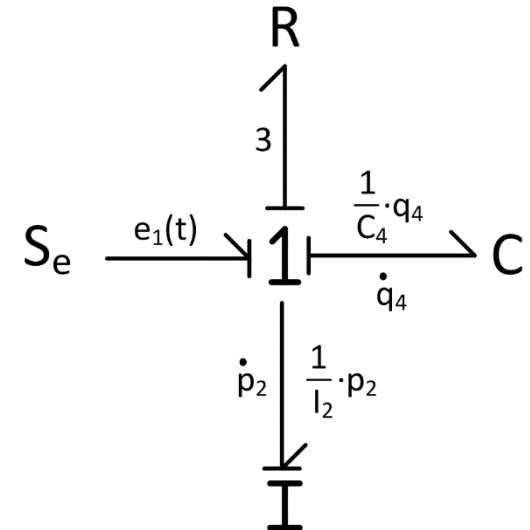

State Equation Derivation – Procedure

30

- Substituting (4) into (3)

$$e_3 = \frac{R_3}{I_2} p_2 \quad (5)$$

- And substituting (5) back into (2)

$$\dot{p}_2 = e_1(t) - \frac{R_3}{I_2} p_2 - e_4 \quad (6)$$

- Still need to eliminate e_4
 - e_4 related to state variable q_4 through constitutive law for the capacitor

$$e_4 = \frac{1}{C_4} q_4 \quad (7)$$

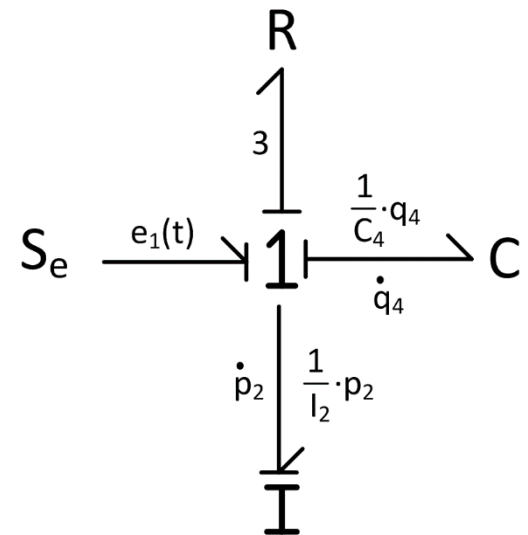

State Equation Derivation

31

- Substituting (7) into (6) yields the first of two **state equations**

$$\dot{p}_2 = -\frac{R_3}{I_2} p_2 - \frac{1}{C_4} q_4 + e_1(t) \quad (8)$$

- Next, follow a similar procedure for q_4

$$\dot{q}_4 = f_4 \quad (9)$$

- f_4 is the flow on a 1-jct, set by f_2 , related to state variable p_2 by the const. law for the inertia

$$f_4 = f_2 = \frac{1}{I_2} p_2 \quad (10)$$

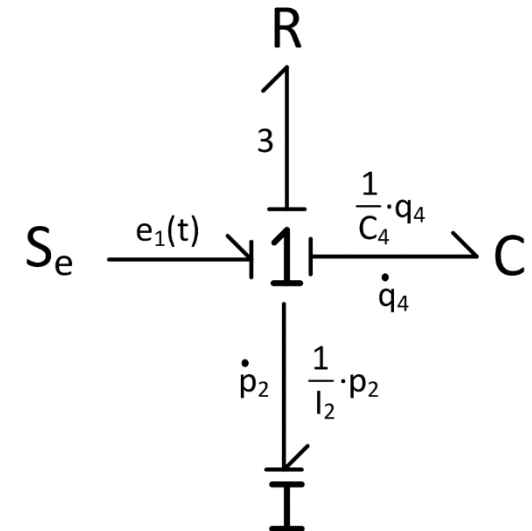

State Equation Derivation

32

- Substituting (10) into (9) yields the second of two ***state equations***

$$\dot{q}_4 = \frac{1}{I_2} p_2 \quad (11)$$

- Combine (8) and (11) into the ***state-variable model*** for our system in matrix form

$$\begin{bmatrix} \dot{p}_2 \\ \dot{q}_4 \end{bmatrix} = \begin{bmatrix} -\frac{R_3}{I_2} & -\frac{1}{c_4} \\ \frac{1}{I_2} & 0 \end{bmatrix} \begin{bmatrix} p_2 \\ q_4 \end{bmatrix} + \begin{bmatrix} 1 \\ 0 \end{bmatrix} e_1(t) \quad (12)$$

State Equation Derivation

33

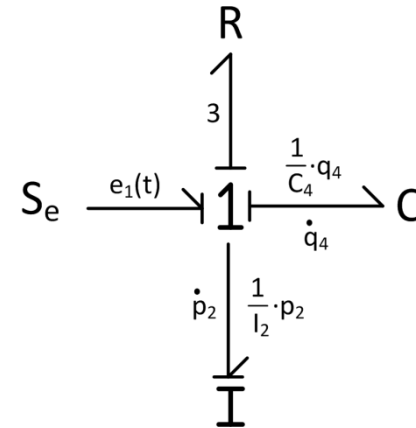
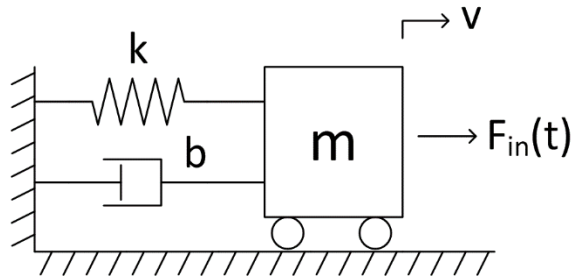

- Can now replace the computational bond graph parameters in (12) with physical system parameters

$$\begin{bmatrix} \dot{p} \\ \dot{x} \end{bmatrix} = \begin{bmatrix} -\frac{b}{m} & -k \\ \frac{1}{m} & 0 \end{bmatrix} \begin{bmatrix} p \\ x \end{bmatrix} + \begin{bmatrix} 1 \\ 0 \end{bmatrix} F_{in}(t) \quad (13)$$

State Equation Derivation – Output Equation

34

- Can also define an **output equation** as part of our state-space model
- Suppose we want to consider the **velocity of the mass** as our output
 - ▣ Constitutive relation relates an inertia's flow to its momentum:

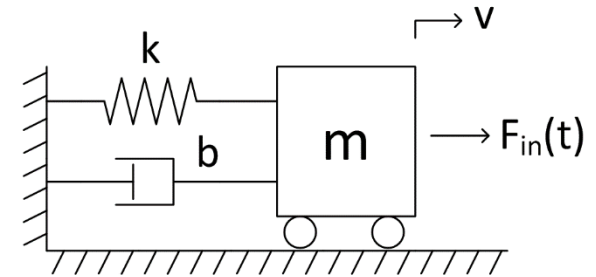

$$f_2 = v = \frac{1}{I_2} p_2 = \frac{1}{m} p \quad (14)$$

- The output equation would be:

$$y = [1/m \quad 0] \begin{bmatrix} p \\ x \end{bmatrix} \quad (15)$$

- Equations (13) and (15) comprise the complete state-space system model

State Equation Derivation – Output Equation

35

- Perhaps, instead, we want to consider the **displacement of the mass** as our output
 - ▣ Same as spring displacement – a state variable
- State-space model, including output equation, becomes:

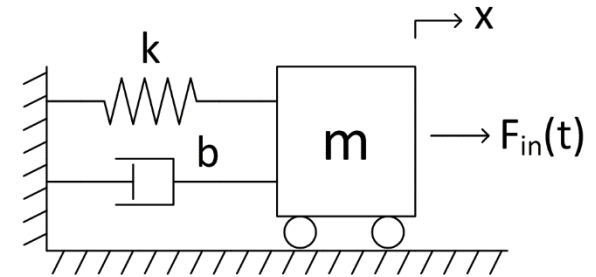

$$\begin{bmatrix} \dot{p} \\ \dot{x} \end{bmatrix} = \begin{bmatrix} -\frac{b}{m} & -k \\ \frac{1}{m} & 0 \end{bmatrix} \begin{bmatrix} p \\ x \end{bmatrix} + \begin{bmatrix} 1 \\ 0 \end{bmatrix} F_{in}(t)$$

(16)

$$y = [0 \quad 1] \begin{bmatrix} p \\ x \end{bmatrix}$$

State Equation Derivation – Causality

36

- In this example, assignment of causality yielded the simplest result:
 - ▣ ***All energy-storage elements ended up in integral causality***
– all were independent
 - ▣ ***No resistors had their causality arbitrarily assigned***
- Lack of derivative causality and/or algebraic loops (resistor fields) results in straightforward state equation derivation
 - ▣ Unfortunately, the inverse is also true
- Next, we'll look at two more examples without derivative causality or algebraic loops

State Equation Derivation – Example 1

37

- Consider the mechanical example from Section 3
- Four independent energy-storage elements
 - ▣ Fourth-order system
 - ▣ Four state variables:

$$\mathbf{x} = \begin{bmatrix} p_3 \\ q_5 \\ q_8 \\ p_{10} \end{bmatrix}$$

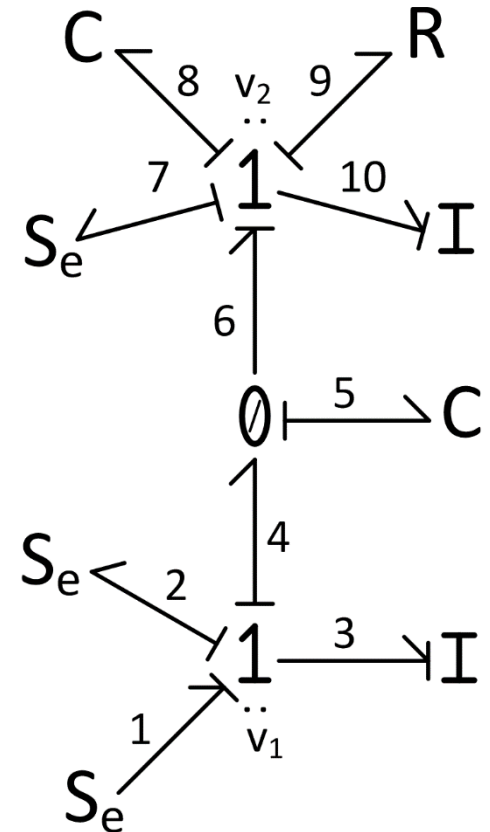

State Equation Derivation – Example 1

38

□ Annotate the bond graph:

■ State variable derivatives

- Efforts on independent inertias
- Flows on independent capacitors

■ Use constitutive laws and state variables to express:

- Flows on independent inertias
- Efforts on independent capacitors

■ Known source quantities

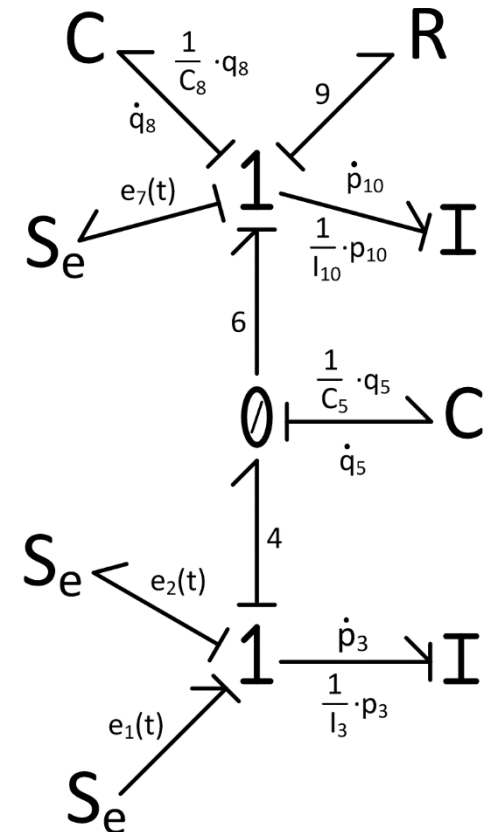

State Equation Derivation – Example 1

39

- Choose a state variable derivative and express it as an effort or a flow

$$\dot{p}_3 = e_3 = e_1(t) - e_2(t) - e_4 \quad (1)$$

- Known source efforts can remain
 - Need to eliminated e_4
 - Effort on a 0-jct, set by e_5

$$e_4 = e_5 = \frac{1}{C_5} q_5 \quad (2)$$

- Substituting (2) into (1) yields the **first of four state equations**

$$\dot{p}_3 = -\frac{1}{C_5} q_5 + e_1(t) - e_2(t) \quad (3)$$

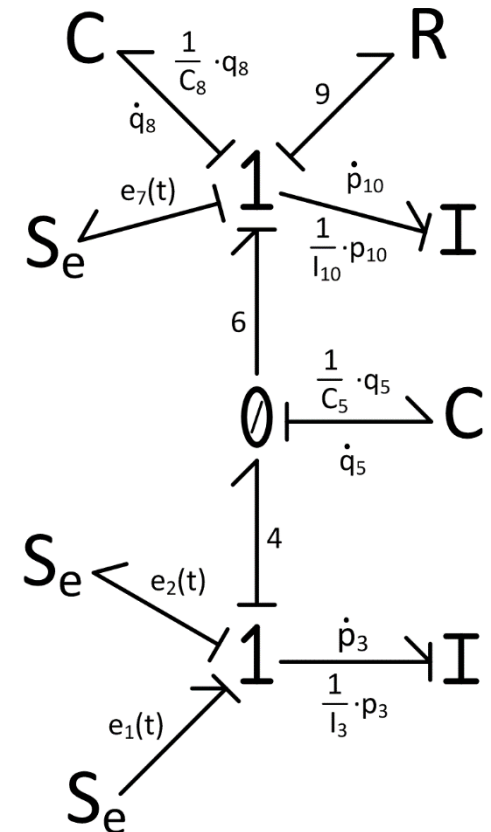

State Equation Derivation – Example 1

40

- Move on to the next state variable

$$\dot{q}_5 = f_5 = f_4 - f_6 \quad (4)$$

- f_4 and f_6 are both flows on 1-jct's set by f_3 and f_{10} , respectively

$$f_4 = f_3 = \frac{1}{I_3} p_3 \quad (5)$$

$$f_6 = f_{10} = \frac{1}{I_{10}} p_{10} \quad (6)$$

- Substituting (6) and (5) into (4) yields the **second state equation**

$$\dot{q}_5 = \frac{1}{I_3} p_3 - \frac{1}{I_{10}} p_{10} \quad (7)$$

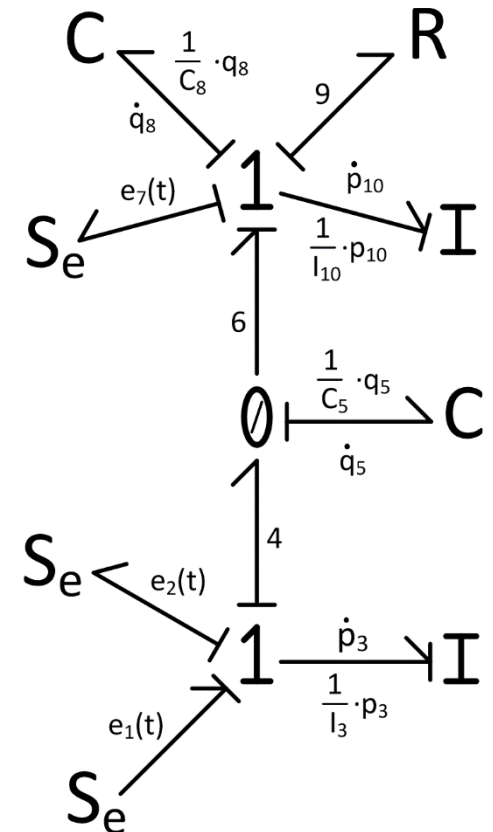

State Equation Derivation – Example 1

41

- Move on to \dot{q}_8

$$\dot{q}_8 = f_8 = f_{10} = \frac{1}{I_{10}} p_{10} \quad (8)$$

which gives the **third state equation**

$$\boxed{\dot{q}_8 = \frac{1}{I_{10}} p_{10}} \quad (9)$$

- Finally, derive the equation for \dot{p}_{10}

$$\dot{p}_{10} = e_{10} = e_6 - e_7(t) - e_8 - e_9 \quad (10)$$

- e_6 is the effort on a 0-jct, set by e_5

$$e_6 = e_5 = \frac{1}{C_5} q_5 \quad (11)$$

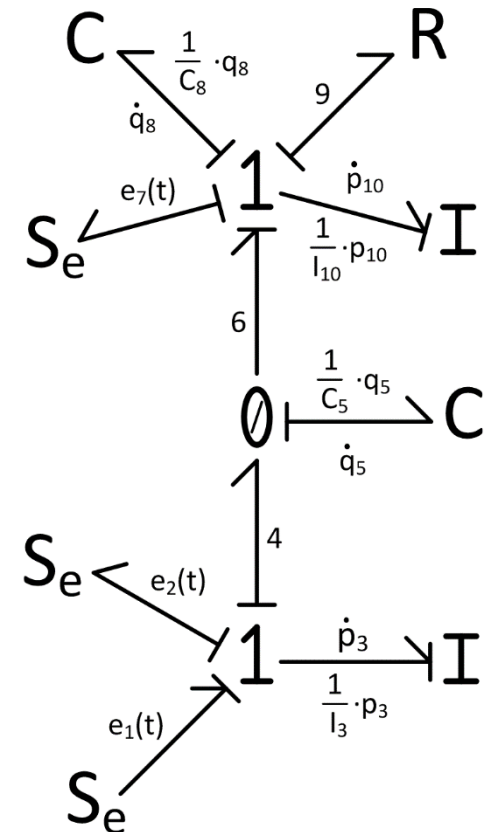

State Equation Derivation – Example 1

42

- e_8 is related to state variable q_8

$$e_8 = \frac{1}{C_8} q_8 \quad (12)$$

- e_9 can be related to f_9 using the constitutive law for resistor R_9

$$e_9 = R_9 f_9 \quad (13)$$

- And, f_9 is the flow on a 1-jct, set by f_{10}

$$e_9 = R_9 f_{10} = R_9 \frac{1}{I_{10}} p_{10} \quad (14)$$

- Substituting (11), (12), and (14) into (10) yields the **final state equation**

$$\dot{p}_{10} = \frac{1}{C_5} q_5 - \frac{1}{C_8} q_8 - \frac{R_9}{I_{10}} p_{10} - e_7(t) \quad (15)$$

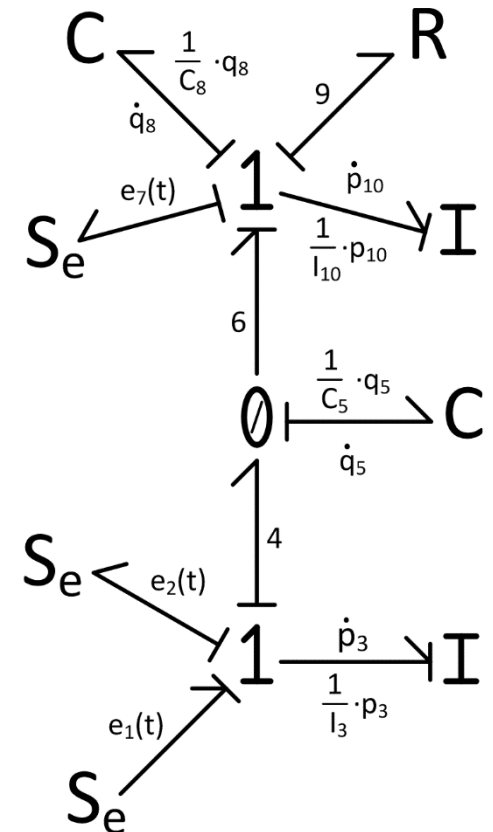

State Equation Derivation – Example 1

43

- Combine the state equations into matrix form

$$\begin{bmatrix} \dot{p}_3 \\ \dot{q}_5 \\ \dot{q}_8 \\ \dot{p}_{10} \end{bmatrix} = \begin{bmatrix} 0 & -\frac{1}{C_5} & 0 & 0 \\ \frac{1}{I_3} & 0 & 0 & -\frac{1}{I_{10}} \\ 0 & 0 & 0 & \frac{1}{I_{10}} \\ 0 & \frac{1}{C_5} & -\frac{1}{C_8} & -\frac{R_9}{I_{10}} \end{bmatrix} \begin{bmatrix} p_3 \\ q_5 \\ q_8 \\ p_{10} \end{bmatrix} + \begin{bmatrix} 1 & -1 & 0 \\ 0 & 0 & 0 \\ 0 & 0 & 0 \\ 0 & 0 & -1 \end{bmatrix} \begin{bmatrix} e_1(t) \\ e_2(t) \\ e_7(t) \end{bmatrix} \quad (16)$$

- Can rewrite, substituting in physical parameters
 - ▣ q_1 and q_2 are the displacements of springs k_1 and k_2 , respectively

$$\begin{bmatrix} \dot{p}_1 \\ \dot{q}_1 \\ \dot{q}_2 \\ \dot{p}_2 \end{bmatrix} = \begin{bmatrix} 0 & -k_1 & 0 & 0 \\ \frac{1}{m_1} & 0 & 0 & -\frac{1}{m_2} \\ 0 & 0 & 0 & \frac{1}{m_2} \\ 0 & k_1 & -k_2 & -\frac{b}{m_2} \end{bmatrix} \begin{bmatrix} p_1 \\ q_1 \\ q_2 \\ p_2 \end{bmatrix} + \begin{bmatrix} 1 & -1 & 0 \\ 0 & 0 & 0 \\ 0 & 0 & 0 \\ 0 & 0 & -1 \end{bmatrix} \begin{bmatrix} F_{in}(t) \\ m_1 g \\ m_2 g \end{bmatrix} \quad (17)$$

State Equation Derivation – Example 1

44

- Let the ***position of each mass*** to be our outputs
 - ▣ Two outputs
- Displacement of m_2 is

$$x_2 = q_2 \quad (18)$$

- Displacement of spring C_5 is

$$q_1 = x_1 - x_2 \quad (19)$$

so

$$x_1 = q_1 + x_2 = q_1 + q_2$$

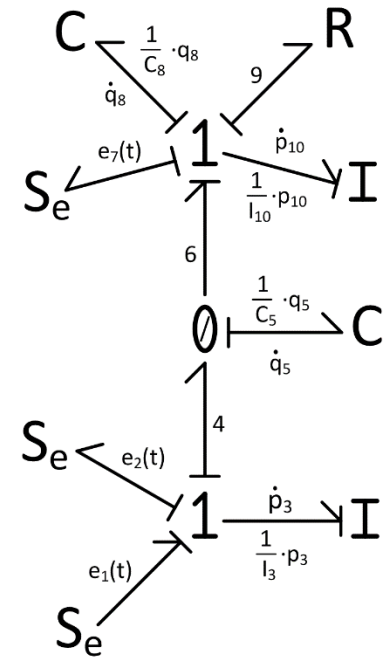
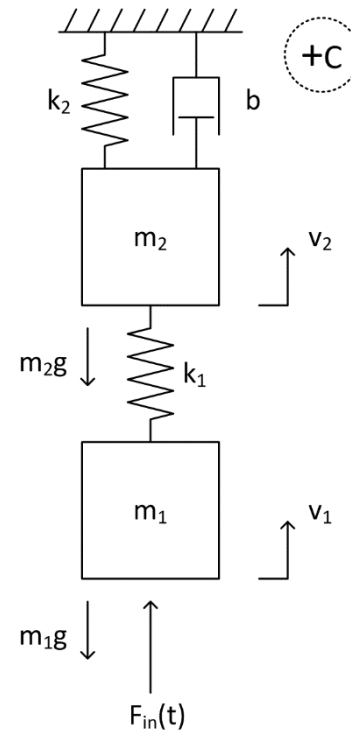

$$(20)$$

State Equation Derivation – Example 1

45

- Combine (20) and (18) into our output equation
 - ▣ Multiple outputs, so \mathbf{C} will be a **matrix**
- Complete state-space model, including output equation:

$$\dot{\mathbf{x}} = \begin{bmatrix} \dot{p}_1 \\ \dot{q}_1 \\ \dot{q}_2 \\ \dot{p}_2 \end{bmatrix} = \begin{bmatrix} 0 & -k_1 & 0 & 0 \\ \frac{1}{m_1} & 0 & 0 & -\frac{1}{m_2} \\ 0 & 0 & 0 & \frac{1}{m_2} \\ 0 & k_1 & -k_2 & -\frac{b}{m_2} \end{bmatrix} \begin{bmatrix} p_1 \\ q_1 \\ q_2 \\ p_2 \end{bmatrix} + \begin{bmatrix} 1 & -1 & 0 \\ 0 & 0 & 0 \\ 0 & 0 & 0 \\ 0 & 0 & -1 \end{bmatrix} \begin{bmatrix} F_{in}(t) \\ m_1 g \\ m_2 g \end{bmatrix}$$

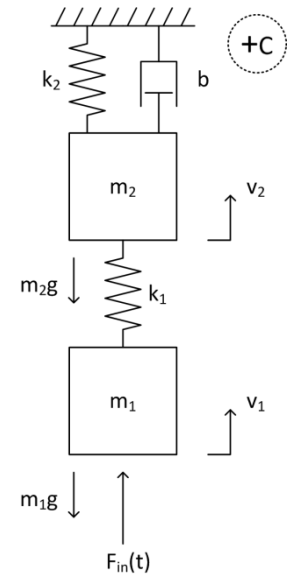

(21)

$$\mathbf{y} = \begin{bmatrix} x_1 \\ x_2 \end{bmatrix} = \begin{bmatrix} 0 & 1 & 1 & 0 \\ 0 & 0 & 1 & 0 \end{bmatrix} \begin{bmatrix} p_1 \\ q_1 \\ q_2 \\ p_2 \end{bmatrix}$$

State Equation Derivation – Example 2

46

- A slightly modified version of the electrical circuit from Section 3:

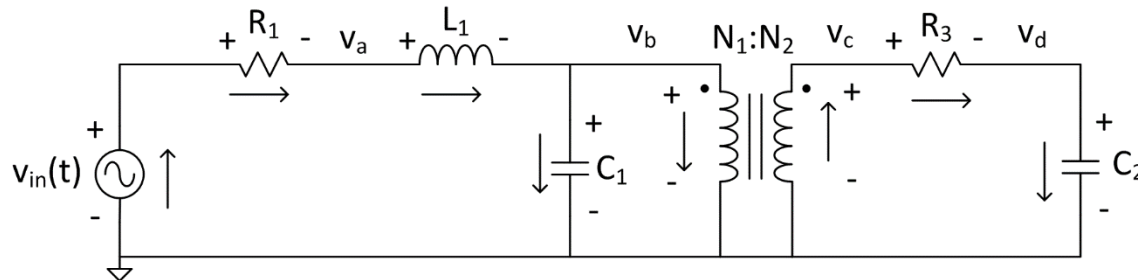

- The computational bond graph for this circuit:

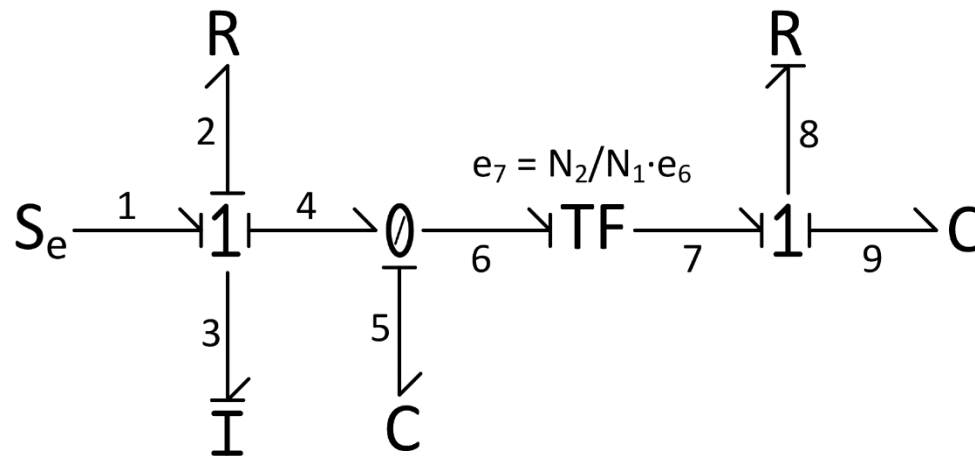

State Equation Derivation – Example 2

47

- Three independent energy-storage elements
 - Third order
- State variables:

$$\mathbf{x} = \begin{bmatrix} p_3 \\ q_5 \\ q_9 \end{bmatrix}$$

- Annotate the computational bond graph

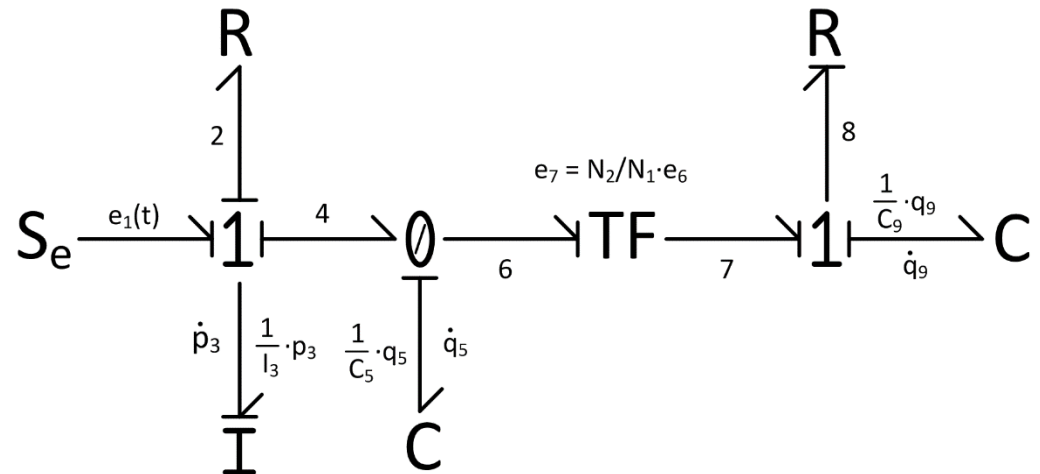
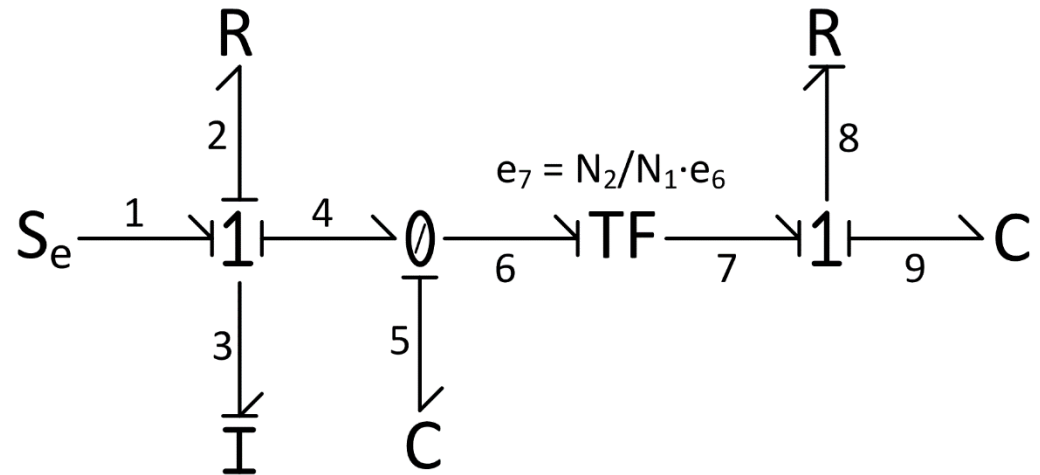

State Equation Derivation – Example 2

48

- Begin with equation for \dot{p}_3

$$\dot{p}_3 = e_3 = e_1(t) - e_2 - e_4 \quad (1)$$

$$e_2 = R_2 f_2 = R_2 f_3 = R_2 \frac{1}{I_3} p_3 \quad (2)$$

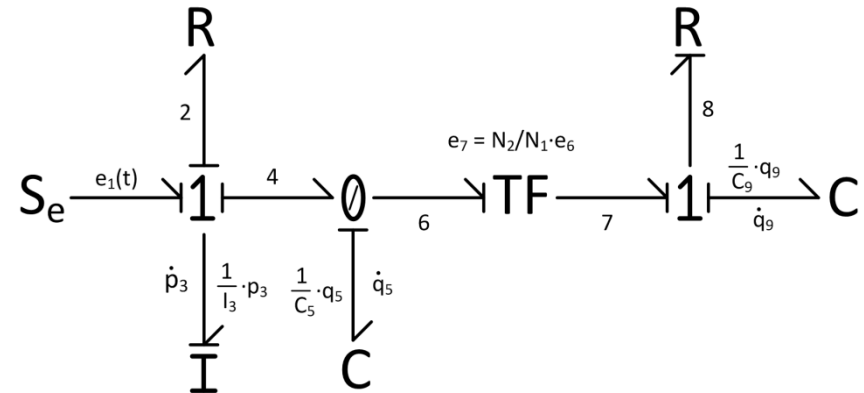

- e_4 is the effort on a 0-jct, set by the effort on C_5

$$e_4 = e_5 = \frac{1}{C_5} q_5 \quad (3)$$

- Substituting (2) and (3) into (1) gives the **first of three state equations**

$$\dot{p}_3 = -\frac{R_2}{I_3} p_3 - \frac{1}{C_5} q_5 + e_1(t) \quad (4)$$

State Equation Derivation – Example 2

49

- Next, move on to \dot{q}_5

$$\dot{q}_5 = f_5 = f_4 - f_6 \quad (5)$$

- f_4 is set by f_3

$$f_4 = f_3 = \frac{1}{I_3} p_3 \quad (6)$$

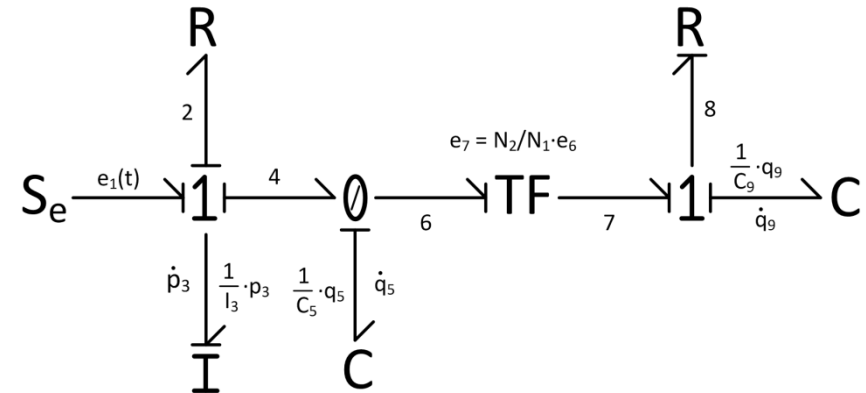

- The transformer modulus relates f_6 to f_7 , which is the flow on a 1-jct, set by f_8

$$f_6 = \frac{N_2}{N_1} f_7 = \frac{N_2}{N_1} f_8 = \frac{N_2}{N_1} \frac{1}{R_8} e_8 \quad (7)$$

- e_8 is algebraically related to e_7 and e_9

$$e_8 = e_7 - e_9 = e_7 - \frac{1}{C_9} q_9 \quad (8)$$

State Equation Derivation – Example 2

50

- The transformer relates e_7 back to e_6 , which is set by e_5

$$e_7 = \frac{N_2}{N_1} e_6 = \frac{N_2}{N_1} e_5 = \frac{N_2}{N_1} \frac{1}{C_5} q_5 \quad (9)$$

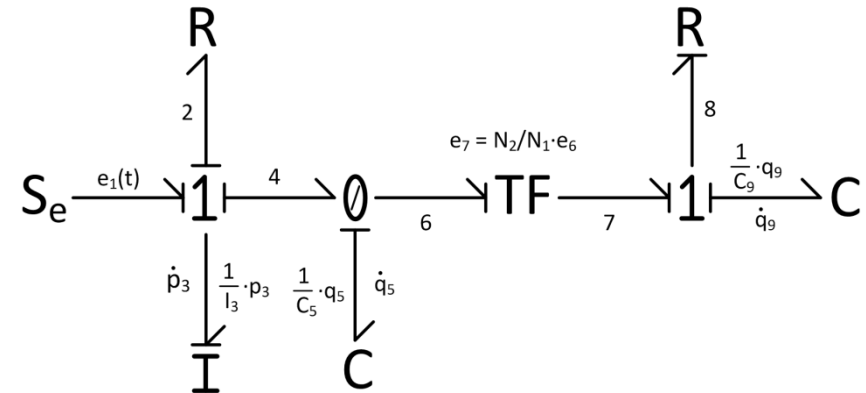

- Substituting (9) into (8) gives

$$e_8 = \frac{N_2}{N_1} \frac{1}{C_5} q_5 - \frac{1}{C_9} q_9 \quad (10)$$

- Equation (10) can be substituted into (7)

$$f_6 = \frac{N_2}{N_1} \frac{1}{R_8} \left(\frac{N_2}{N_1} \frac{1}{C_5} q_5 - \frac{1}{C_9} q_9 \right) \quad (11)$$

- Using (11) and (6) in (5) gives us our **second state equation**

$$\dot{q}_5 = \frac{1}{I_3} p_3 - \left(\frac{N_2}{N_1} \right)^2 \frac{1}{R_8 C_5} q_5 + \frac{N_2}{N_1} \frac{1}{R_8 C_9} q_9 \quad (12)$$

State Equation Derivation – Example 2

51

- Finally, derive the equation for \dot{q}_9

$$\dot{q}_9 = f_9 \quad (13)$$

- f_9 is the flow on a 1-jct, which is set by f_8

$$f_9 = f_8 = \frac{1}{R_8} e_8 \quad (14)$$

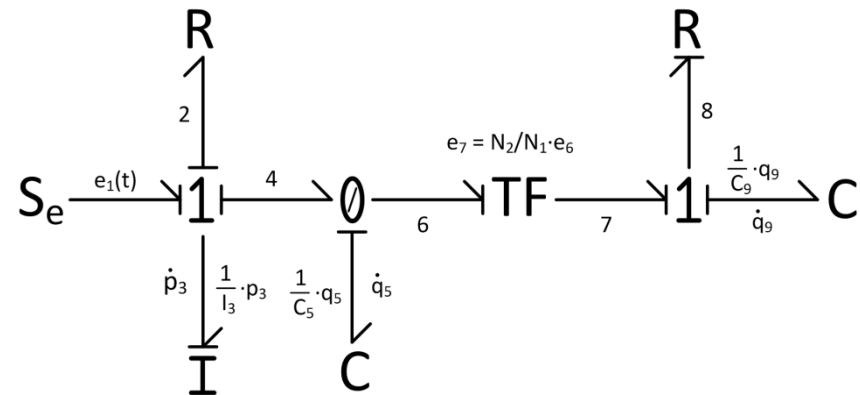

- Substituting (10) into (14)

$$f_9 = \frac{1}{R_8} \left(\frac{N_2}{N_1} \frac{1}{C_5} q_5 - \frac{1}{C_9} q_9 \right) \quad (15)$$

- Substituting (15) in (13) gives us our **third state equation**

$$\dot{q}_9 = \frac{N_2}{N_1} \frac{1}{R_8 C_5} q_5 - \frac{1}{R_8 C_9} q_9 \quad (16)$$

State Equation Derivation – Example 2

52

- Combine the state equations in matrix form

$$\dot{\mathbf{x}} = \begin{bmatrix} \dot{p}_3 \\ \dot{q}_5 \\ \dot{q}_9 \end{bmatrix} = \begin{bmatrix} -\frac{R_2}{I_3} & -\frac{1}{C_5} & 0 \\ \frac{1}{I_3} & -\left(\frac{N_2}{N_1}\right)^2 \frac{1}{R_8 C_5} & \frac{N_2}{N_1} \frac{1}{R_8 C_9} \\ 0 & \frac{N_2}{N_1} \frac{1}{R_8 C_5} & -\frac{1}{R_8 C_9} \end{bmatrix} \begin{bmatrix} p_3 \\ q_5 \\ q_9 \end{bmatrix} + \begin{bmatrix} 1 \\ 0 \\ 0 \end{bmatrix} e_1(t) \quad (17)$$

- Replacing computational bond graph parameters with physical parameters

$$\dot{\mathbf{x}} = \begin{bmatrix} \dot{\lambda}_1 \\ \dot{q}_1 \\ \dot{q}_2 \end{bmatrix} = \begin{bmatrix} -\frac{R_1}{L_1} & -\frac{1}{C_1} & 0 \\ \frac{1}{L_1} & -\left(\frac{N_2}{N_1}\right)^2 \frac{1}{R_3 C_1} & \frac{N_2}{N_1} \frac{1}{R_3 C_2} \\ 0 & \frac{N_2}{N_1} \frac{1}{R_3 C_1} & -\frac{1}{R_3 C_2} \end{bmatrix} \begin{bmatrix} \lambda_1 \\ q_1 \\ q_2 \end{bmatrix} + \begin{bmatrix} 1 \\ 0 \\ 0 \end{bmatrix} v_{in}(t) \quad (18)$$

State Equation Derivation – Example 2

53

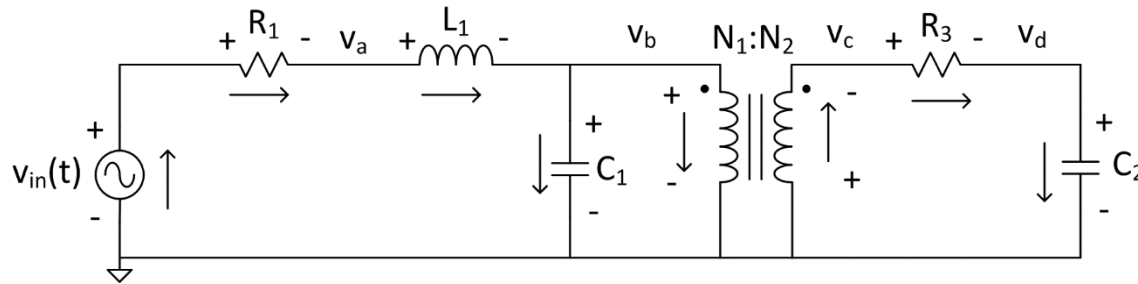

- Choosing the voltage across C_2 as our output, the complete state-space system representation is

$$\dot{\mathbf{x}} = \begin{bmatrix} \lambda_1 \\ \dot{q}_1 \\ \dot{q}_2 \end{bmatrix} = \begin{bmatrix} -\frac{R_1}{L_1} & -\frac{1}{C_1} & 0 \\ \frac{1}{L_1} & -\left(\frac{N_2}{N_1}\right)^2 \frac{1}{R_3 C_1} & \frac{N_2}{N_1} \frac{1}{R_3 C_2} \\ 0 & \frac{N_2}{N_1} \frac{1}{R_3 C_1} & -\frac{1}{R_3 C_2} \end{bmatrix} \begin{bmatrix} \lambda_1 \\ q_1 \\ q_2 \end{bmatrix} + \begin{bmatrix} 1 \\ 0 \\ 0 \end{bmatrix} v_{in}(t)$$

(19)

$$y = v_d = \begin{bmatrix} 0 & 0 & 1/C_2 \end{bmatrix} \begin{bmatrix} \lambda_1 \\ q_1 \\ q_2 \end{bmatrix}$$

State Equation Derivation – Example 2

54

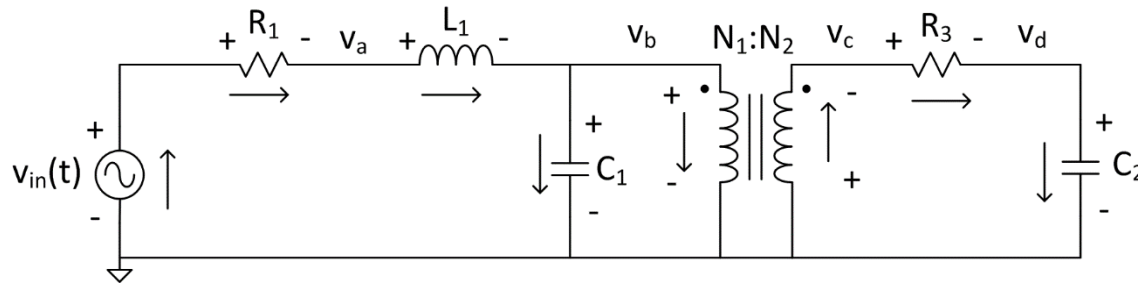

- Instead let the **voltage across L_1** be the system output
 - ▣ That is, the effort associated with L_1
 - ▣ Effort is the time derivative of momentum, so

$$y = v_{L1} = v_a - v_b = \dot{\lambda}_1 \quad (20)$$

- The output equation can be extracted from (19)

$$y = v_{L1} = \begin{bmatrix} -\frac{R_1}{L_1} & -\frac{1}{C_1} & 0 \end{bmatrix} \begin{bmatrix} \lambda_1 \\ q_1 \\ q_2 \end{bmatrix} + v_{in}(t) \quad (21)$$

- Note that, in this case, the feed-through term, D , is non-zero

55

Algebraic Loops or Resistor Fields

Algebraic Loops – Example 1

56

- Consider the following electrical circuit

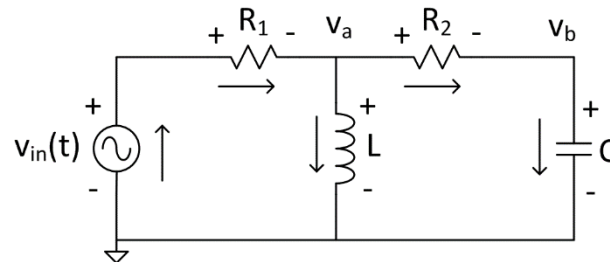

- Causality assignment is completed by arbitrarily assigning the causality of resistor R_2 (or R_6)
 - ▣ System contains an **algebraic loop** (resistor field)

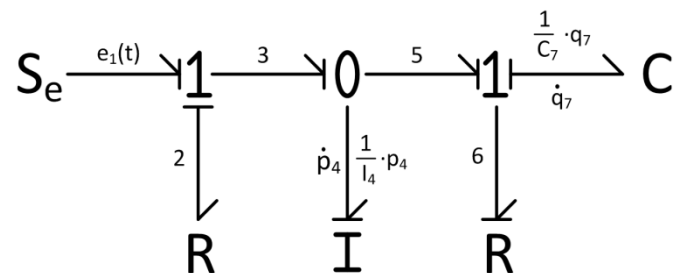

- Presence of the algebraic loop will complicate the state equation derivation a bit

Algebraic Loops – Example 1

57

- Second-order system
 - ▣ State variables are:

$$\mathbf{x} = \begin{bmatrix} p_4 \\ q_7 \end{bmatrix}$$

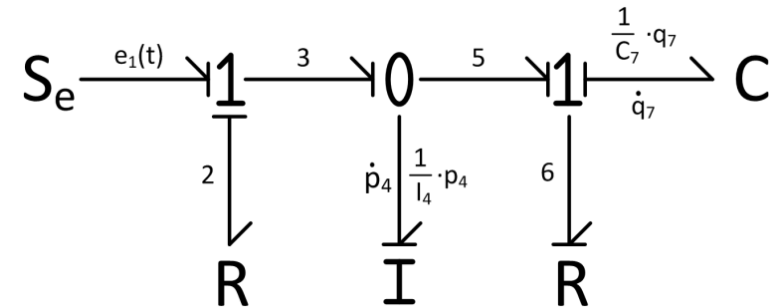

- Begin deriving equations as usual

$$\dot{p}_4 = e_4 = e_3 = e_1(t) - e_2 = e_1(t) - R_2 f_2 \quad (1)$$

$$f_2 = f_3 = \frac{1}{I_4} p_4 + f_5 = \frac{1}{I_4} p_4 + f_6 \quad (2)$$

$$f_6 = \frac{1}{R_6} e_6 = \frac{1}{R_6} \left(e_5 - \frac{1}{C_7} q_7 \right) \quad (3)$$

$$f_6 = \frac{1}{R_6} \left(e_3 - \frac{1}{C_7} q_7 \right) \quad (4)$$

- e_3 has reentered the formulation, and we're back where we started in (1)
 - ▣ An **algebraic loop**

Algebraic Loops – Procedure

58

1. The **output** of the resistor whose causality was arbitrarily assigned – e_2 in this case, though f_6 would work equally well – is the **auxiliary variable**
 2. Derive an expression relating the **auxiliary variable** to the **state variables, inputs, and to itself**
 3. Proceed with the **state equation derivation** as usual, but leave the auxiliary variable in the formulation along with state variables and inputs
 4. **Substitute** the result from step 2 into the result from step 3
-
- One auxiliary variable for each algebraic loop present
 - ▣ Multiple loops require solution of a system of equations
 - Apply this procedure first, whenever causality assignment involves an arbitrary assignment of resistor causality

Algebraic Loops – Example 1

59

- Follow causality to derive an expression for auxiliary variable e_2

$$e_2 = R_2 f_2 = R_2 f_3 = R_2 \left(\frac{1}{I_4} p_4 + f_5 \right) \quad (5)$$

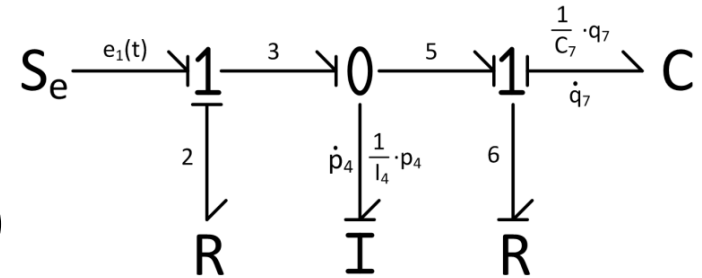

$$f_5 = f_6 = \frac{1}{R_6} e_6 = \frac{1}{R_6} \left(e_5 - \frac{1}{C_7} q_7 \right) \quad (6)$$

$$e_5 = e_3 = e_1(t) - e_2 \quad (7)$$

- e_2 is the aux. variable, so it can remain in the expression
- Substituting (7) into (6) into (5)

$$e_2 = \frac{R_2}{I_4} p_4 + \frac{R_2}{R_6} e_1(t) - \frac{R_2}{R_6} e_2 - \frac{R_2}{R_6 C_7} q_7 \quad (8)$$

$$e_2 \frac{R_2 + R_6}{R_6} = \frac{R_2}{I_4} p_4 - \frac{R_2}{R_6 C_7} q_7 + \frac{R_2}{R_6} e_1(t) \quad (9)$$

Algebraic Loops – Example 1

60

- Solve (9) for e_2

$$e_2 = \frac{R_2 R_6}{R_2 + R_6} \frac{1}{I_4} p_4 - \frac{R_2}{(R_2 + R_6) C_7} q_7 + \frac{R_2}{R_2 + R_6} e_1(t) \quad (10)$$

- Now, whenever e_2 appears in the formulation, substitute in the expression in (10)

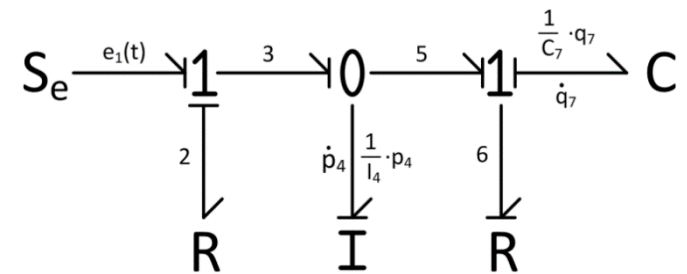

- Going back to (1), we had

$$\dot{p}_4 = e_1(t) - e_2 \quad (1)$$

- Substituting in (10) yields the **first state equation**

$$\dot{p}_4 = -\frac{R_2 R_6}{R_2 + R_6} \frac{1}{I_4} p_4 + \frac{R_2}{(R_2 + R_6) C_7} q_7 + \frac{R_6}{R_2 + R_6} e_1(t) \quad (11)$$

Algebraic Loops – Example 1

61

- Moving on to \dot{q}_7

$$\dot{q}_7 = f_7 = f_6 \quad (12)$$

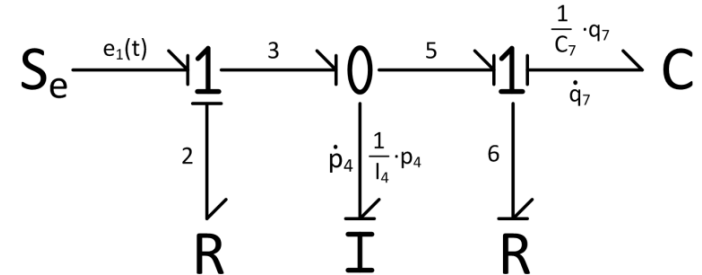

- We already have an expression for f_6 in (6) and (7)

$$\dot{q}_7 = \frac{1}{R_6} e_1(t) - \frac{1}{R_6} e_2 - \frac{1}{R_6 C_7} q_7 \quad (13)$$

- Substituting in (10) to eliminate e_2

$$\dot{q}_7 = \frac{1}{R_6} e_1(t) - \frac{R_2}{R_2 + R_6} \frac{1}{I_4} p_4 + \frac{R_2}{(R_2 + R_6) R_6 C_7} q_7 - \frac{R_2}{(R_2 + R_6) R_6} e_1(t) - \frac{1}{R_6 C_7} q_7$$

- Rearranging gives the **second state equation**

$$\dot{q}_7 = -\frac{R_2}{R_2 + R_6} \frac{1}{I_4} p_4 - \frac{1}{(R_2 + R_6) C_7} q_7 + \frac{1}{R_2 + R_6} e_1(t) \quad (14)$$

Algebraic Loops – Example 1

62

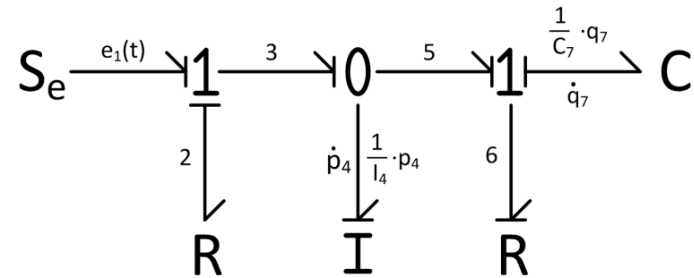
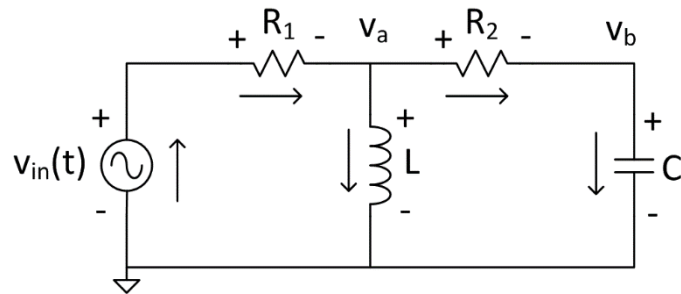

- Assembling (11) and (14) in matrix form gives our state variable system model

$$\begin{bmatrix} \dot{p}_4 \\ \dot{q}_7 \end{bmatrix} = \begin{bmatrix} -\frac{R_2 R_6}{R_2 + R_6} & \frac{1}{I_4} \\ \frac{R_2}{(R_2 + R_6) C_7} & 1 \end{bmatrix} \begin{bmatrix} p_4 \\ q_7 \end{bmatrix} + \begin{bmatrix} \frac{R_6}{R_2 + R_6} \\ 1 \\ \frac{1}{R_2 + R_6} \end{bmatrix} e_1(t) \quad (15)$$

Algebraic Loops – Example 1

63

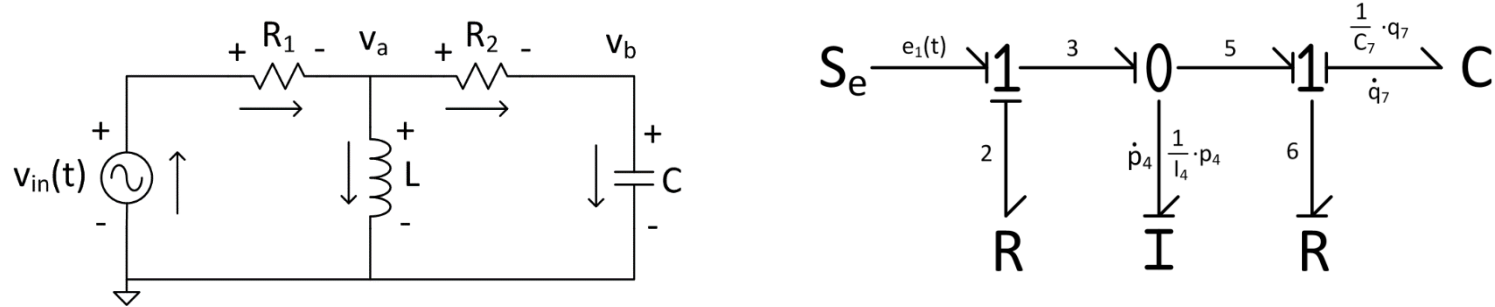

- Substitute in physical parameters and define an output equation for the voltage across the capacitor, v_b

$$\begin{bmatrix} \dot{\lambda} \\ \dot{q} \end{bmatrix} = \begin{bmatrix} -\frac{R_1 R_2}{R_1 + R_2} \frac{1}{L} & \frac{R_1}{(R_1 + R_2) C} \\ -\frac{R_1}{R_1 + R_2} \frac{1}{L} & -\frac{1}{(R_1 + R_2) C} \end{bmatrix} \begin{bmatrix} \lambda \\ q \end{bmatrix} + \begin{bmatrix} \frac{R_2}{R_1 + R_2} \\ 1 \\ R_1 + R_2 \end{bmatrix} v_{in}(t) \quad (16)$$

$$y = [0 \quad 1/C] \begin{bmatrix} \lambda \\ q \end{bmatrix}$$

Algebraic Loops – Example 2

64

- Next, consider a mechanical system

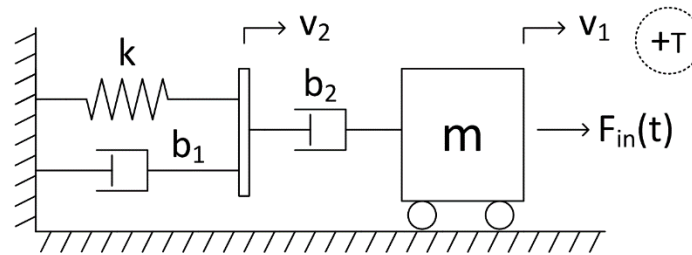

- Causality assignment is completed by arbitrarily assigning the causality of resistor R_2 (or R_4)

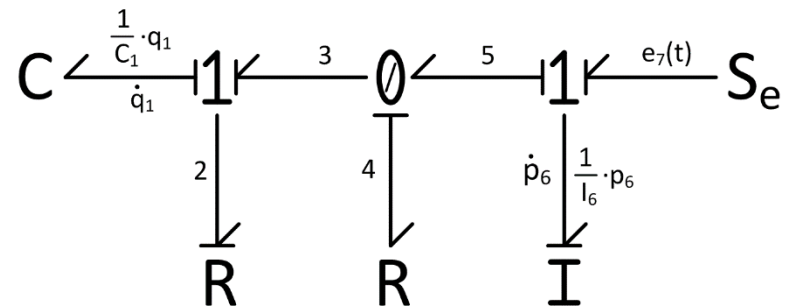

- A very similar bond graph to the electrical circuit in the previous example

Algebraic Loops – Example 2

65

- A **second-order system** with state variables:

$$\mathbf{x} = \begin{bmatrix} q_1 \\ p_6 \end{bmatrix}$$

- A **second-order system** with state variables:

$$\mathbf{x} = \begin{bmatrix} q_1 \\ p_6 \end{bmatrix}$$

- An **algebraic loop** is present, so we'll immediately go to the procedure outlined in the previous example
- **Auxiliary variable** is f_2
 - Express f_2 in terms of state variables, inputs, and itself

$$f_2 = \frac{1}{R_2} e_2 = \frac{1}{R_2} (e_3 - e_1) = \frac{1}{R_2} \left(e_4 - \frac{1}{C_1} q_1 \right) \quad (1)$$

$$e_4 = R_4 f_4 = R_4 (f_5 - f_3) = R_4 \left(\frac{1}{I_6} p_6 - f_2 \right) \quad (2)$$

- f_2 is the auxiliary variable, so it can remain in the expression

Algebraic Loops – Example 2

66

- Substitute (2) into (1)

$$f_2 = \frac{R_4}{R_2} \frac{1}{I_6} p_6 - \frac{R_4}{R_2} f_2 - \frac{1}{R_2 C_1} q_1 \quad (3)$$

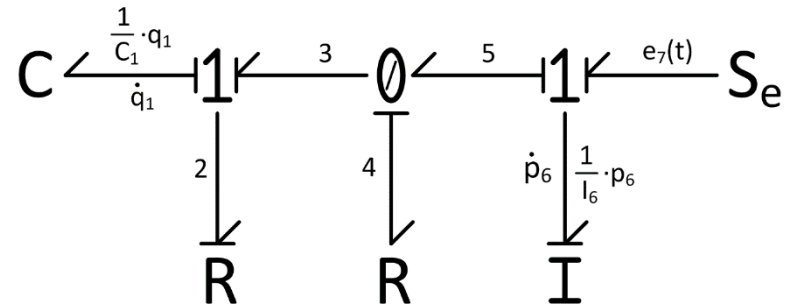

- Then solve for f_2

$$f_2 \left(\frac{R_2 + R_4}{R_2} \right) = -\frac{1}{R_2 C_1} q_1 + \frac{R_4}{R_2} \frac{1}{I_6} p_6 \quad (4)$$

$$f_2 = -\frac{1}{(R_2 + R_4) C_1} q_1 + \frac{R_4}{R_2 + R_4} \frac{1}{I_6} p_6 \quad (5)$$

- Now, Proceed with the state equation derivation
 - Whenever the auxiliary variable, f_2 , appears in the formulation, it will be replaced with (5)

Algebraic Loops – Example 2

67

- Start with \dot{q}_1

$$\dot{q}_1 = f_1 = f_2 \quad (6)$$

- Substituting (5) into (6) gives the **first state equation**

$$\dot{q}_1 = -\frac{1}{(R_2+R_4)C_1} q_1 + \frac{R_4}{R_2+R_4} \frac{1}{I_6} p_6 \quad (7)$$

- Moving on to \dot{p}_6

$$\dot{p}_6 = e_6 = e_7(t) - e_5 = e_7(t) - e_4 \quad (8)$$

$$e_4 = R_4 f_4 = R_4 (f_5 - f_3) = R_4 \left(\frac{1}{I_6} p_6 - f_2 \right) \quad (9)$$

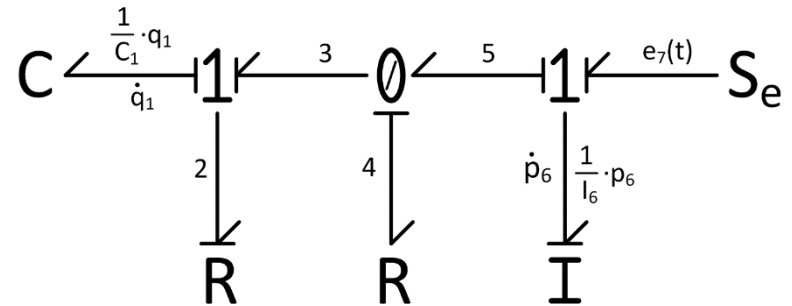

Algebraic Loops – Example 2

68

- Substitute (9) into (8)

$$\dot{p}_6 = e_7(t) - \frac{R_4}{I_6} p_6 + R_4 f_2 \quad (10)$$

- Substituting (5) in for f_2 gives the **second state equation**

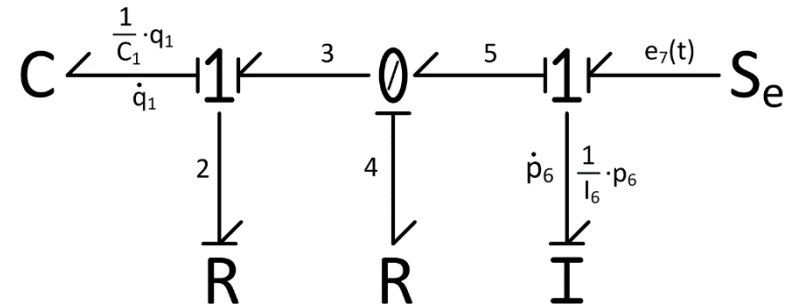

$$\dot{p}_6 = e_7(t) - \frac{R_4}{I_6} p_6 + R_4 \left(-\frac{1}{(R_2+R_4)C_1} q_1 + \frac{R_4}{R_2+R_4} \frac{1}{I_6} p_6 \right) \quad (11)$$

$$\dot{p}_6 = -\frac{R_4}{(R_2+R_4)C_1} q_1 - \frac{R_2 R_4}{R_2+R_4} \frac{1}{I_6} p_6 + e_7(t) \quad (12)$$

- In matrix form:

$$\begin{bmatrix} \dot{q}_1 \\ \dot{p}_6 \end{bmatrix} = \begin{bmatrix} -\frac{1}{(R_2+R_4)C_1} & \frac{R_4}{R_2+R_4} \frac{1}{I_6} \\ -\frac{R_4}{(R_2+R_4)C_1} & -\frac{R_2 R_4}{R_2+R_4} \frac{1}{I_6} \end{bmatrix} \begin{bmatrix} q_1 \\ p_6 \end{bmatrix} + \begin{bmatrix} 0 \\ 1 \end{bmatrix} e_7(t) \quad (13)$$

Algebraic Loops – Example 2

69

- Note that the origin of the algebraic loop in this example was a **modeling assumption**
 - The connection point between the spring and dampers was considered **massless**
 - Instead we could **account for the mass** of this junction

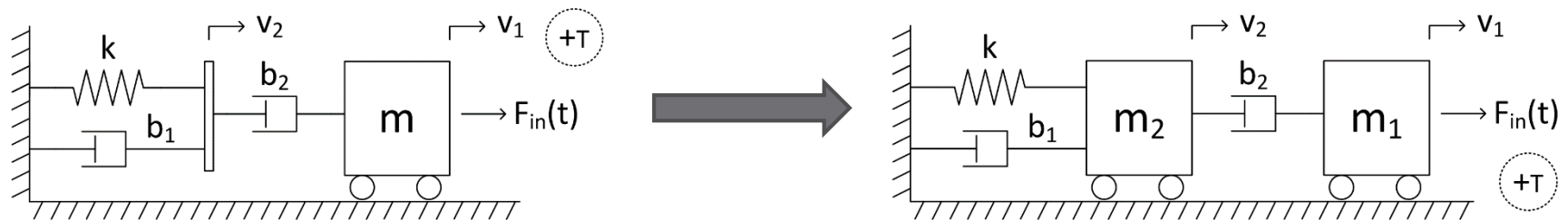

- Now, there are no arbitrary causality assignments and **no algebraic loops**

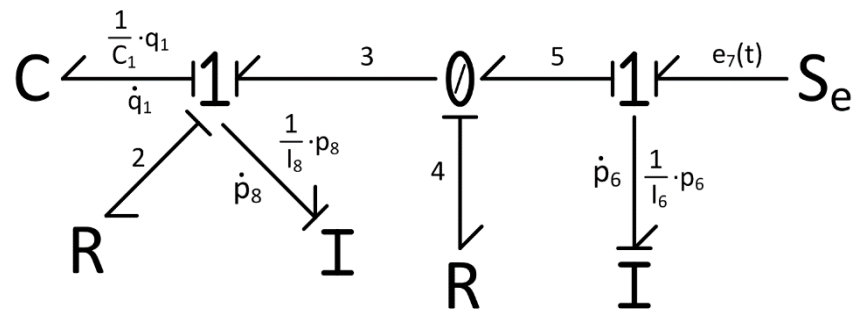

- State equation derivation will be greatly simplified

Algebraic Loops – Example 2

70

- System is now **third-order**, due to the additional independent energy-storage element

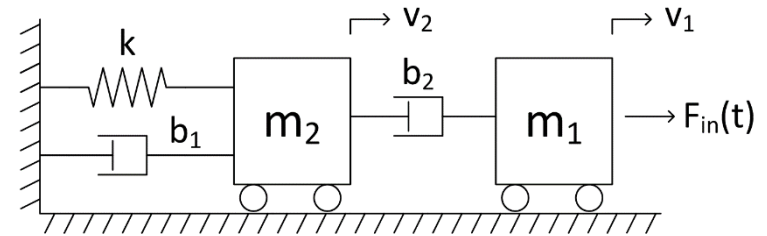

- State equation, after replacing physical parameters:

$$\begin{bmatrix} \dot{x}_2 \\ \dot{p}_1 \\ \dot{p}_2 \end{bmatrix} = \begin{bmatrix} 0 & 0 & \frac{1}{m_2} \\ 0 & -\frac{b_2}{m_1} & \frac{b_2}{m_1} \\ -k & \frac{b_2}{m_1} & -\frac{b_1+b_2}{m_2} \end{bmatrix} \begin{bmatrix} x_2 \\ p_1 \\ p_2 \end{bmatrix} + \begin{bmatrix} 0 \\ 1 \\ 0 \end{bmatrix} F_{in}(t) \quad (14)$$

- Looks very different from the original second order model, but if $m_2 \ll m_1$, their behaviors are nearly identical

71

Derivative Causality

Derivative Causality – Example

72

- Consider the mechanical system from Section 3
- The computational bond graph:

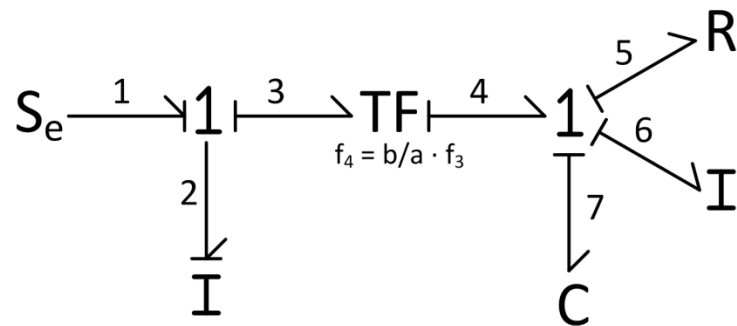

- Two **independent** energy-storage elements
 - ▣ Second-order
 - ▣ State variables are:

$$\mathbf{x} = \begin{bmatrix} p_2 \\ q_7 \end{bmatrix}$$

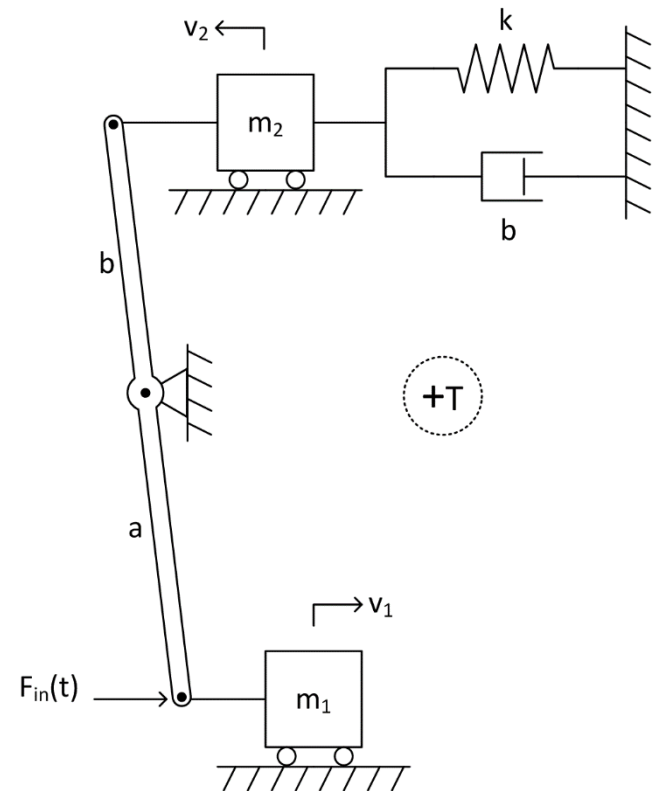

Derivative Causality – Example

73

- I_6 is in **derivative Causality**
 - ▣ **Not independent**
 - ▣ **Does not contribute a state**
 - ▣ Its energy variable p_6 (would be a q for an C -element) is **algebraically related** to the state variables

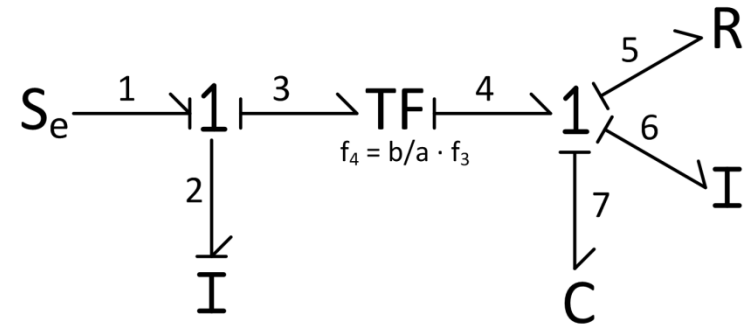

- Annotate the bond graph
 - ▣ Include the energy variable annotation for the dependent inertia

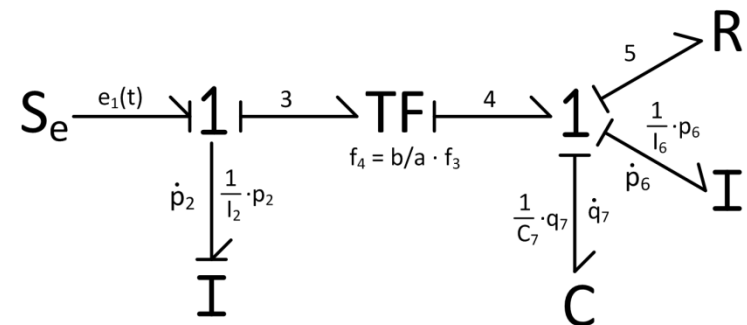

Derivative Causality – Example

74

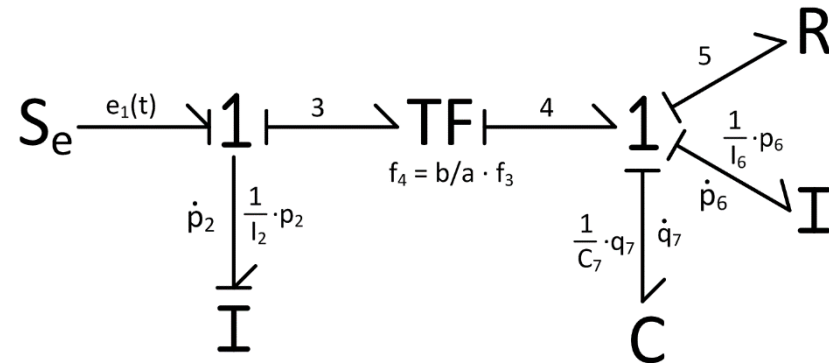

- p_6 is not a state variable
 - State equation derivation requires first determining the algebraic relationship between p_6 and the state variables, p_2 and q_7
 - When p_6 or \dot{p}_6 enters the formulation, substitute in this relationship or its derivative

Derivative Causality – Procedure

75

1. For the dependent energy-storage element, **apply the constitutive law 'backwards'** - i.e. express the energy variable as a function of a power variable
 - a. Inertia: express momentum as a function of flow
 - b. Capacitor: express displacement as a function of effort
2. **Follow causality** to relate that power variable to the state variables and inputs
3. **Substitute** the expression from step 2 into that from step 1
4. When the energy variable (or its derivative) enters the formulation, **substitute** in the expression from step 3

Derivative Causality – Example

76

- Apply the constitutive law for I_6 'backwards'
 - ▣ Express p_6 as a function of f_6

$$p_6 = I_6 f_6 \quad (1)$$

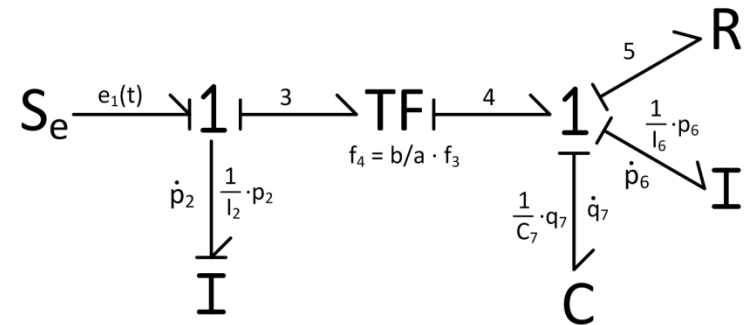

- Follow causality to express f_6 in terms of state variables and inputs

$$f_6 = f_4 = \frac{b}{a} f_3 = \frac{b}{a} \frac{1}{I_2} p_2 \quad (2)$$

- Substituting (2) into (1)

$$p_6 = \frac{b I_6}{a I_2} p_2 \quad (3)$$

- Now proceed with derivation, using (3) when needed

Derivative Causality – Example

77

- Begin state equation derivation

with \dot{p}_2

$$\dot{p}_2 = e_2 = e_1(t) - e_3 \quad (4)$$

- TF relates e_3 to e_4

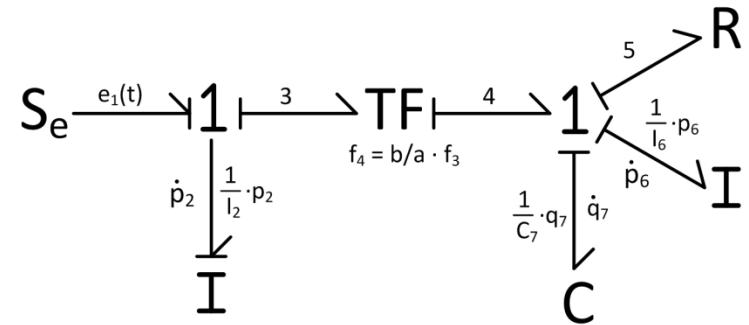

$$\dot{p}_2 = e_1(t) - \frac{b}{a} e_4 = e_1(t) - \frac{b}{a} \left(e_5 + \dot{p}_6 + \frac{1}{c_7} q_7 \right) \quad (5)$$

$$e_5 = R_5 f_5 = R_5 f_4 = R_5 \frac{b}{a} f_3 = R_5 \frac{b}{a} \frac{1}{l_2} p_2 \quad (6)$$

- Substituting (6) into (5)

$$\dot{p}_2 = e_1(t) - \frac{b}{a} \left(\frac{b R_5}{a l_2} p_2 + \dot{p}_6 + \frac{1}{c_7} q_7 \right)$$

$$\dot{p}_2 = e_1(t) - \left(\frac{b}{a} \right)^2 \frac{R_5}{l_2} p_2 - \frac{b}{a} \dot{p}_6 - \frac{b}{a} \frac{1}{c_7} q_7 \quad (7)$$

Derivative Causality – Example

78

- A \dot{p}_6 term has entered the formulation

- ▣ Differentiate (3)

$$\dot{p}_6 = \frac{b I_6}{a I_2} \dot{p}_2 \quad (8)$$

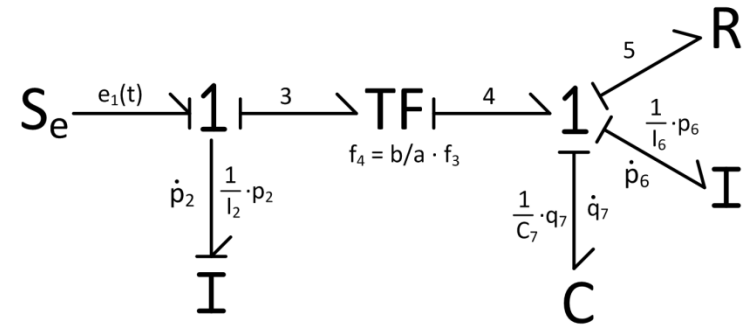

- Substitute (8) into (7)

$$\dot{p}_2 = e_1(t) - \left(\frac{b}{a}\right)^2 \frac{R_5}{I_2} p_2 - \left(\frac{b}{a}\right)^2 \frac{I_6}{I_2} \dot{p}_2 - \frac{b}{a} \frac{1}{C_7} q_7 \quad (9)$$

- Solve (9) for \dot{p}_2

$$\dot{p}_2 \left(\frac{I_2 + (b/a)^2 I_6}{I_2} \right) = e_1(t) - \left(\frac{b}{a}\right)^2 \frac{R_5}{I_2} p_2 - \frac{b}{a} \frac{1}{C_7} q_7 \quad (10)$$

Derivative Causality – Example

79

- Rearranging (10) gives the **first of two state equations**:

$$\dot{p}_2 = -\frac{\left(\frac{b}{a}\right)^2 R_5}{I_2 + \left(\frac{b}{a}\right)^2 I_6} p_2 - \frac{\left(\frac{b}{a}\right) I_2}{\left(I_2 + \left(\frac{b}{a}\right)^2 I_6\right) C_7} q_7 + \frac{I_2}{I_2 + \left(\frac{b}{a}\right)^2 I_6} e_1(t) \quad (11)$$

- Next, move on to \dot{q}_7

$$\dot{q}_7 = f_7 = f_4 = \frac{b}{a} f_3 \quad (12)$$

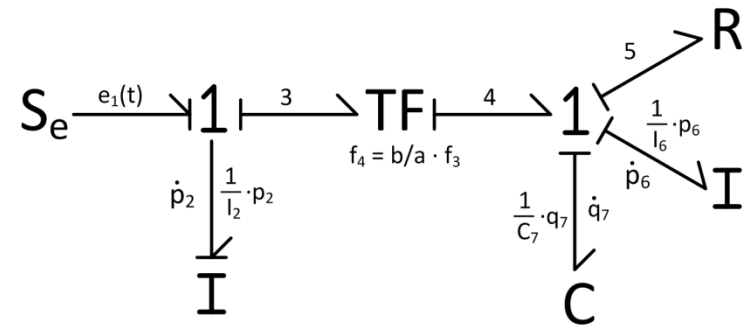

- The **second state equation**:

$$\dot{q}_7 = \frac{b}{a} \frac{1}{I_2} p_2 \quad (9)$$

Derivative Causality – Example

80

- The state-space system model:

$$\begin{bmatrix} \dot{p}_2 \\ \dot{q}_7 \end{bmatrix} = \begin{bmatrix} \frac{\left(\frac{b}{a}\right)^2 R_5}{I_2 + \left(\frac{b}{a}\right)^2 I_6} & -\frac{\left(\frac{b}{a}\right) I_2}{\left(I_2 + \left(\frac{b}{a}\right)^2 I_6\right) C_7} \\ \frac{b}{a} \frac{1}{I_2} & 0 \end{bmatrix} \begin{bmatrix} p_2 \\ q_7 \end{bmatrix} + \begin{bmatrix} \frac{I_2}{I_2 + \left(\frac{b}{a}\right)^2 I_6} \\ 0 \end{bmatrix} e_1(t)$$

- With physical parameters:

$$\begin{bmatrix} \dot{p}_1 \\ \dot{x}_2 \end{bmatrix} = \begin{bmatrix} \frac{\left(\frac{b}{a}\right)^2 b}{m_1 + \left(\frac{b}{a}\right)^2 m_2} & -\frac{\left(\frac{b}{a}\right) m_1 k}{\left(m_1 + \left(\frac{b}{a}\right)^2 m_2\right)} \\ \frac{b}{a} \frac{1}{m_1} & 0 \end{bmatrix} \begin{bmatrix} p_1 \\ x_2 \end{bmatrix} + \begin{bmatrix} \frac{m_1}{m_1 + \left(\frac{b}{a}\right)^2 m_2} \\ 0 \end{bmatrix} F_{in}(t)$$

Derivative Causality – Example

81

- Derivative causality in this case resulted from a ***modeling decision***
 - The lever was assumed to be rigid
 - Adding some compliance to the lever arm eliminates derivative causality (see Section 3 notes)
 - Increases system model to ***fourth-order***
 - Equation derivation simplified at the cost of model complexity
-
- In general, derive an expression for the energy variable of each energy-storage element in derivative causality
 - Multiple elements in derivative-causality will require solution of a system of equations