



WILLOUGHBY

COUNT ON US.



SECURITY PRODUCT GUIDE

PLUMBING FIXTURES & ACCESSORIES





TABLE OF CONTENTS

Security Product Guide: Plumbing Fixtures & Accessories



SECTIONS

COMBINATION UNITS

Available in 15", 18", 20", 26", and 36" widths. These lavatory and toilet units are fabricated from heavy gauge, type 304 stainless steel polished to a satin finish. **PAGE 3** 

TOILETS

Wall hung, floor mounted, blow-out, siphon jet, wall outlet, and floor outlet. All featuring an elongated bowl with contoured seat, crevice-free self-draining flush rim with positive afterfill, and fully enclosed trap. **PAGE 7** 

LAVATORIES

Rear mounted, front mounted, corner mounted, and ADA. All lavatories are available with machined stainless steel bubblers and pushbuttons **PAGE 10** 

SINKS

Service, mop, and multi-station. **PAGE 13** 

URINALS

Available in single person, multi-person, straddle, or trough type configurations. **PAGE 14** 

DRINKING FOUNTAINS

Rear mounted, front mounted, non-handicap, and handicap. **PAGE 15** 

SHOWERS

Cabinet, corner, single person, and multi-person. **PAGE 16** 

ACCESSORIES

Tissue holders, soap dishes, shelves, mirrors, and grab bars. **PAGE 20** 

VALVES

Pushbutton pneumatic and electronic, plus toilet overflow preventers. **PAGE 23** 

ELECTRONIC WATER CONSERVATION CONTROLS

Pneutronic, WITS, and WMS II. **PAGE 24** 

ANTI-SUICIDE FIXTURES **PAGE 27**

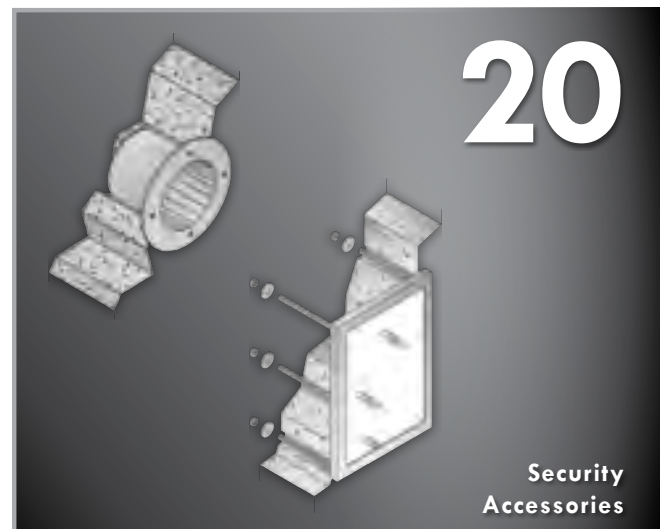

CERTIFICATIONS



COMBINATION UNITS



03

Willoughby combination lavatory/toilet units are fabricated from heavy gauge, type 304 stainless steel with all-welded construction and exposed stainless surfaces polished to a satin finish. The standard toilet has an elongated bowl with contoured seat, integral crevice-free self-draining flushing rim with positive afterfill and fully enclosed trap. All lavatories are available with machined stainless steel bubblers and pushbuttons. Call a Willoughby sales representative today at 1-800-428-4065.



1545 SERIES

- 15" Wide
- 45° Angled Wall
- Rear Mounted
- ADA



1546 SERIES

- 15" Wide
- Rear Mounted



1806 SERIES

- 18" Wide
- Rear Mounted
- Anti-suicide



1846 SERIES

- 18" Wide
- Rear Mounted

**1846-FA SERIES**

- 18" Wide
- Front Mounted

**1847 SERIES**

- 18" Wide
- Angled Lavatory Bowl
- Rear Mounted

**2046 SERIES**

- 20" Wide
- Angled Toilet Bowl
- Rear Mounted

**2096 SERIES**

- 20" Wide
- Offset Toilet Bowl
- Offset Lavatory Bowl
- Rear Mounted



2696 SERIES

- 26" Wide
- Offset Toilet Bowl
- Offset Lavatory Bowl
- Rear Mounted



3696 FA SERIES

- 36" Wide
- Offset Toilet Bowl
- Offset Lavatory Bowl
- Front Access
- ADA



3696 SERIES

- 36" Wide
- Offset Toilet Bowl
- Offset Lavatory Bowl
- Rear Mounted
- ADA



ECW-1546-350 SERIES

- 15" Wide
- Replacement for Super Secur A-350
- Wall Mounted
- Wall Outlet

**ECW-1546-150 SERIES**

- 15" Wide
- Replacement for Super Secur A-150
- Floor Mounted
- Wall Outlet

**ECF-1546-150 SERIES**

- 15" Wide
- Replacement for Super Secur A-150-F
- Floor Mounted
- Floor Outlet

Built to Last, In America

Willoughby Industries has manufactured commercial grade stainless steel and solid surface plumbing products for more than 65 years. Our focus is supplying the commercial, healthcare, recreational, and security industries with plumbing products of uncommon quality and durability. All of our plumbing products are American-made in our new 250,000 square foot manufacturing facility in Indianapolis, Indiana.



WILLOUGHBY

COUNT ON US.

TOILETS



07

Willoughby toilets are fabricated from heavy gauge, type 304 stainless steel. The construction is all-welded, with exposed stainless surfaces polished to a satin finish. The standard toilet shall include: elongated toilet bowl with contoured seat, integral crevice-free self-draining flushing rim with positive afterfill and fully enclosed trap. Call a Willoughby sales representative today at 1-800-428-4065.



ETF-1490-FM-10"-FA

- 10" Rough Floor Outlet
- Siphon Jet Flush
- Floor Mounted
- Front Mounted



ETF-1490-FM-12"-FA

- 12" Rough Floor Outlet
- Siphon Jet Flush
- Floor Mounted
- Front Mounted

ETF-1490-FM

- Siphon Jet Flush
- 4.25" Rough Floor
- Outlet
- Rear Mounted
- Floor Mounted



ETF-1490-FM-FA

- Siphon Jet Flush
- 4.25" Rough Floor Outlet
- Floor Mounted
- Front Mounted



ETF-1490-OW

- Siphon Jet Flush
- Floor Mounted
- Off-wall Mounted
- Floor Outlet

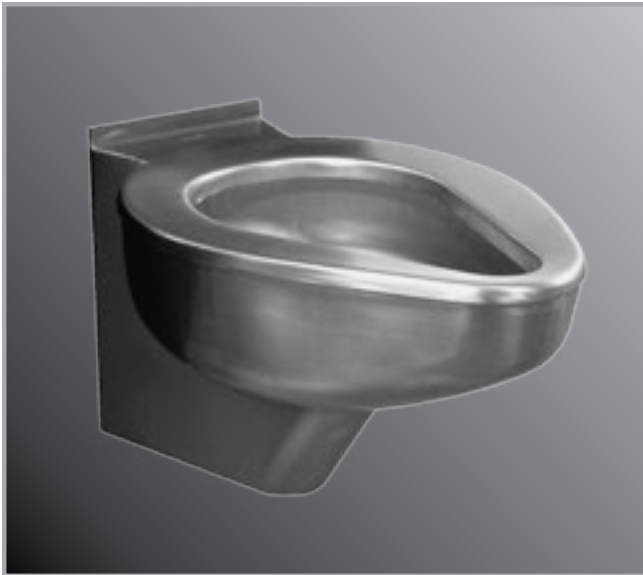
**LFCETW-1490-OF-BS**

- Blowout Flush
- China Alternative
- Off-floor Mounted
- Rear Mounted
- Wall Outlet

**ETW-1490-ES**

- Short & Compact
- Blowout Flush
- Wall Mounted
- Rear Mounted
- Wall Outlet

**ETW-1490-CM**

- 3-Bolt Carrier Mounted
- Blowout Flush
- Direct China Replacement

**ETWS-1490-CM**

- 4-Bolt Carrier Mounted
- Siphon Jet Flush
- Direct China Replacement



ETW-1490-FM-FA

- Blowout Flush
- Floor Mounted
- Front Mounted
- Wall Outlet



ETW-1490-FM

- Blowout Flush
- Floor Mounted
- Rear Mounted
- Wall Outlet

ETWS-1490-FM-FA

- Siphon Jet Flush
- Floor Mounted
- Front Mounted
- Wall Outlet

ETWS-1490-FM

- Siphon Jet Flush
- Floor Mounted
- Rear Mounted
- Wall Outlet



ETW-1490-OF

- Blowout Flush
- Off-floor Mounted
- Rear Mounted
- Wall Outlet

ETWS-1490-OF

- Siphon Jet Flush
- Off-floor Mounted
- Rear Mounted
- Wall Outlet



FD-1400

- In-floor Mounted
- Detox Toilet



Willoughby Lavatories are fabricated from heavy gauge, type 304 stainless steel. The construction is all-welded, with exposed stainless surfaces polished to a satin finish. All lavatories are available with machined stainless bubblers and pushbuttons. Call a Willoughby sales representative today at 1-800-428-4065.



HS-1013-96

- 18" Wide
- Rear Mounted



HS-1013-96-FA

- 18" Wide
- Removable Bottom
- Front Mounted



HS-1014-96-HC

- 18" Wide
- Rear Mounted
- Stainless Steel Deckspout
- ADA

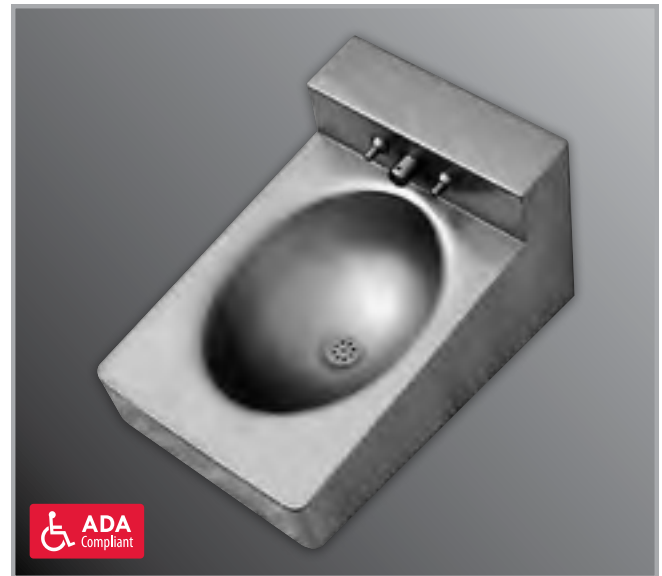

HS-1310-96-HC

- 13" Wide
- Rear Mounted
- 45° Angled Wall
- ADA



HS-1013-46

- 18" Wide
- Rear Mounted



HS-1013-46-HC

- 18" Wide
- Rear Mounted
- ADA



HS-1013-46-HC-FA

- 18" Wide
- Removable Bottom
- Front Mounted
- ADA



HS-1013-46-15

- 15" Wide
- Compact
- Rear Mounted

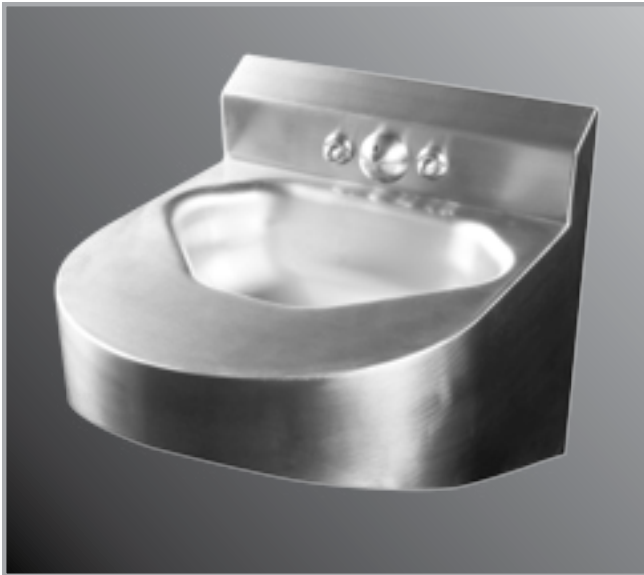
**ASHS-1013-06-HC**

- 15" Wide
- Anti-Suicide
- Rear Access

**ASHS-1013-06-HC-FA**

- 15" Wide
- Anti-Suicide
- Front Access

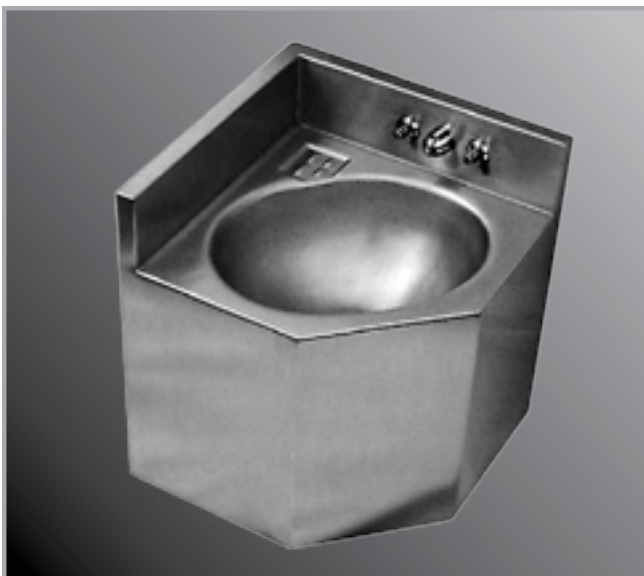
**CS-1013-46**

- 15" Wide
- Corner Configuration
- Rear Mounted

**HS-1013-46-R**

- 18" Wide
- China Replacement
- Rear Mounted

SINKS



Willoughby Commercial grade sinks are fabricated from heavy gauge, type 304 stainless steel. The construction is all-welded, with exposed stainless surfaces polished to a satin finish. Commercial grade faucetry is available for most models. Call a Willoughby sales representative today at 1-800-428-4065.

13



ES-1015-HC SERIES

- 18" Wide
- Front Mounted
- Exposed Trap & Supplies
- ADA



CWLDR SERIES

- Lavatory Deck
- Front Mounted
- ADA



CWMS SERIES

- Mop Sink



CWLD SERIES

- 1, 2, 3, or 4 Station Lavatory Deck
- ADA



Willoughby urinals are available in single or multi-person models with both straddle or trough type configurations. All models are fabricated from heavy gauge, type 304 stainless steel. The fixtures have "all-welded" construction. Call a Willoughby sales representative today at 1-800-428-4065.



UW-1412-WO SERIES

- Washout
- Straddle
- Rear Mounted

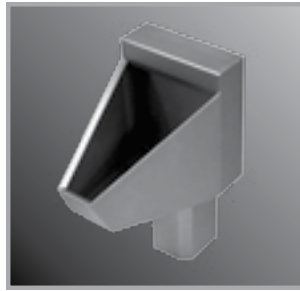

UW-1412-BJ SERIES

- Blowout
- Straddle
- Rear Mounted



UW-1412-WO-FA SERIES

- Washout
- Straddle
- Front Mounted



UW-1438 SERIES

- Stall
- Floor Mounted



UW-1814-WO SERIES

- Washout
- Single Person Trough
- Rear Mounted



UW-1814-BJ SERIES

- Blowout
- Single Person Trough
- Rear Mounted



UW-1814-WO-FA SERIES

- Washout
- Single Person Trough
- Front Mounted



UW-1800 SERIES

- Multiple Person Trough
- Rear Mounted
- Available in lengths of 36", 48", 60", 72" & 96"

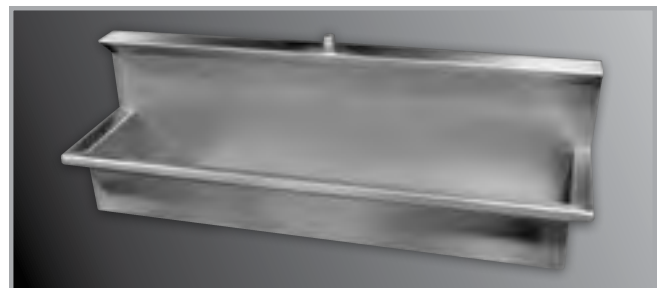

UW-1800-FA SERIES

- Multiple Person Trough
- Front Mounted
- Available in lengths of 36", 48", 60", 72" & 96"

DRINKING FOUNTAIN



Willoughby drinking fountains are fabricated from heavy gauge, type 304 stainless steel. The construction is all-welded, with exposed stainless surfaces polished to a satin finish. All drinking fountains are available with machined stainless bubblers and pushbuttons. Call a Willoughby sales representative today at 1-800-428-4065.

15



DF-1013-96

- 18" Wide
- Rear Mounted



DF-1013-96-FA

- 18" Wide
- Front Mounted
- Removable Bottom



DF-1015-96-HC

- 18" Wide
- Rear Mounted
- ADA



DF-1015-96-HC-FA

- 18" Wide
- Front Mounted
- Removable Bottom
- ADA



Willoughby showers are fabricated from heavy gauge, type 304 stainless steel. The construction is all-welded, with exposed stainless surfaces polished to a satin finish. Showerheads are machined stainless steel. Call a Willoughby sales representative today at 1-800-428-4065.

SHOWERS



CWKS SERIES

- Corner Configuration
- Front Mounted



CWSMS SERIES

- Single Station
- Front Mounted



CWDS SERIES

- Double Station
- Front Mounted



CWTS SERIES

- Triple Station
- Front Mounted



WRS SERIES

- Recessed Shower Panel
- Rear Mounted



WRS-FA SERIES

- Recessed Shower Panel
- Front Mounted



WRS-BF SERIES

- Recessed Shower Panel
- Hand Held Showerhead
- Rear Mounted
- ADA



WRS-BF-FA SERIES

- Recessed Shower Panel
- Hand Held Showerhead
- Front Mounted
- ADA



WRS-BF-2HD SERIES

- Recessed Shower Panel
- Two Fixed Showerheads
- Rear Mounted
- ADA



WRS-BF-FA-2HD SERIES

- Recessed Shower Panel
- Two Fixed Showerheads
- Front Mounted
- ADA



WBIS SERIES

- Rear Mounted
- Built-in Shower



US SERIES

- Unitized Cabinet Shower

KS SERIES

- Knockdown Cabinet Shower (details on page 18)



US-FA SERIES

- Unitized Cabinet Shower
- Front Access

KS-FA SERIES

- Knockdown Cabinet Shower
- Front Access

US-HC SERIES

- Unitized Cabinet Shower
- ADA

KS-HC SERIES

- Knockdown Cabinet Shower
- ADA



US-FA SERIES

- Unitized Cabinet Shower
- Front Access
- ADA

KS-FA SERIES

- Knockdown Cabinet Shower
- Front Access
- ADA

KNOCKDOWN CABINET SHOWER

For use in renovation projects or where unitized cabinet showers are not practical.

Construction of cabinet shall feature bolted, water-tight seams requiring no drilling, punching, etc. for assembly. Security fasteners are furnished for installation and assembly.

Call a Willoughby sales representative for details at 1-800-428-4065.





The heavy duty stainless steel security accessories are designed to withstand abusive environments. Call a Willoughby sales representative today at 1-800-428-4065.



RTH-1

- Recessed Tissue Holder
- Rear Mounted



RTH-2

- Recessed Tissue Holder
- Front Mounted



WA-1824 SERIES

- 4 Release Towel Hooks with Shelf
- Rear Mounted

WA-1824-FA SERIES

- 4 Release Towel Hooks with Shelf
- Front Mounted



RS-1 SERIES

- Recessed Shelf
- Rear Mounted

RS-2 SERIES

- Recessed Shelf
- Front Mounted



RSD-1 SERIES

- Recessed Soap Dish
- Rear Mounted



RSD-2 SERIES

- Recessed Soap Dish
- Front Mounted



MR-1 SERIES

- 12" x 10.5"
- One-Piece Security Mirror
- Front Mounted

MR-2 SERIES

- 16.5" x 12.5"
- One-Piece Security Mirror
- Front Mounted



FMR-1

- 12" x 18"
- Framed Security Mirror
- Rear Mounted

**GB SERIES**

- Grab Bar
- Lengths of 24", 36", 42" & 48"
- Available with Anti-suicide Plate (shown)

**GB-3318**

- L-shaped Grab Bar
- 33" x 18"
- Available with Anti-suicide Plate (shown)

**FSS-R SERIES**

- Folding Shower Seat
- Right Hand

FSS-L SERIES

- Folding Shower Seat
- Left Hand

**TH-3 SERIES**

- One Hook
- Front Mounted Release Towel Hooks

TH-4 SERIES

- Four Hooks
- Front Mounted Release Towel Hooks

VALVES



23

Willoughby offers a variety of pneumatic and electronic valves. All have machined stainless steel pushbuttons and escutcheons, including the piezoelectric actuators. Manifolding is available with some valves. Call a Willoughby sales representative today at 1-800-428-4065.



PML1

- Single Temperature
- Pneumatic Valve Assembly
- Pneumatic Push Button
- Lead free

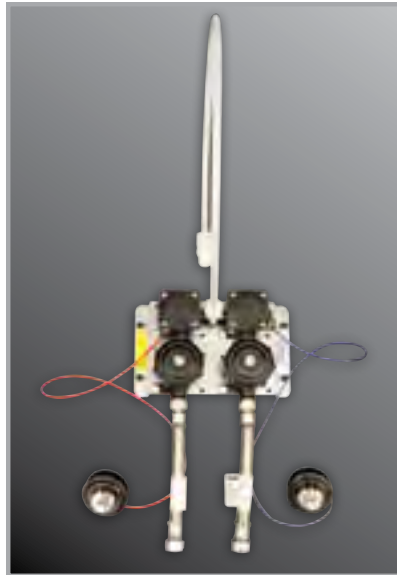

PML2

- Dual Temperature
- Pneumatic Valve Assembly
- Pneumatic Push Button
- Lead free



E1L1

- Single Temperature
- Electronic Valve Assembly
- Electronic Push Button
- Lead free



E1L2

- Dual Temperature
- Electronic Valve Assembly
- Electronic Push Button
- Lead free



T4

- Toilet Overflow Preventer
- Manual Reset



T4A

- Toilet Overflow Preventer
- Auto-Reset



Willoughby electronic systems function on 24V systems. The WMS-II is provided with stainless steel enclosures and a Lexan window for easy viewing of status and diagnostic LED lights. For more information, call a Willoughby sales representative today at 1-800-428-4065.

Willoughby Cell Valve Controller (CVC)

The Willoughby WMS II State-of-the-art Electronic Water Management System



The Willoughby WMS II Electronic Water Management System takes plumbing fixture water control from inmates and puts it back in the hands of prison officials while saving time, water, and money. The new WMS II system is the most technologically advanced in the industry today. After research with correctional facility professionals, Willoughby designed the system to:

- reduce water usage** through fixed scheduling, dynamic usage, or cycle timing control
- reduce sewer bills** by reducing water usage
- control overall water usage**, including the ability to lockout toilets, sinks, and showers from a central PC and detect/prevent toilet overflows
- provide valuable fixture usage data** that can be imported into Excel for further analysis
- enable system troubleshooting** from the service chase with no need to enter the cell to actuate the fixture
- be simple to administrate** with an optional graphical floor plan including fixture control icons
- include over-current protection** on all outputs, virtually eliminating potential damage from installation errors
- allow one cell valve controller to control several different devices** (two standard combination units or four toilets with overflow detection or six toilets without overflow detection or six shower valves, with mixing of fixtures types also possible)
- be simple to install**, using common connectors and color-coded wiring
- be less costly to install, use and maintain**

The net result can be a reduction in water and sewer usage of up to 50%

The WMS II system requires only a standard 110V outlet in the mechanical chase and features an operator display with an optional facility-specific floor plan for simple administration. For new installations or retrofits of existing systems, visit www.willoughby-ind.com for all the details.

WMS II

For Maximum Control and Conservation

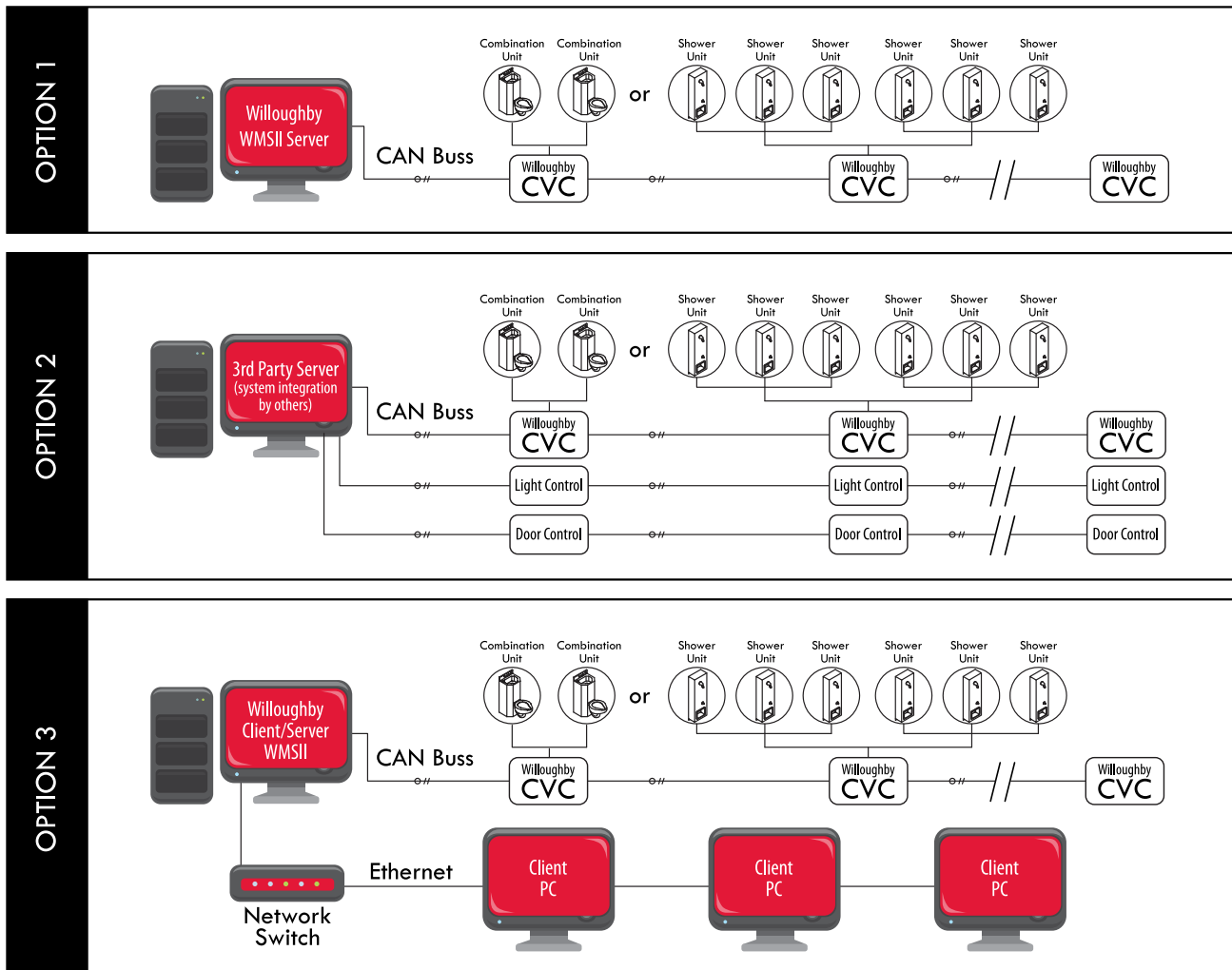

WMS II Water Management System

- Created for control of plumbing fixtures in correctional facilities
- Offered in both networked (full control from a central server) and stand-alone versions (control pre-programmed into each individual CVC controller)
- Network CAN lines can include up to 127 CVCs connected together in series
- Toilet overflow protection is available with the WMS II system (requires compatible Willoughby toilet/combination unit)
- Diagnostic lights are provided in the CVC and are easily viewed through the transparent cover
- Pushbutton switches require less than 5 lbs. of force to activate (ADA requirement)
- Optional touch-screen monitor is available
- In the event of a loss of network communications or loss of power, controllers will retain system timing parameters in memory to allow fixtures to operate in the same way they were operating prior to the loss of power or the loss of network communications
- Valve run times are adjustable (1–60 seconds for lavatory valves, 1 second– 9 minutes and 59 seconds for shower valves)

The WMS II system is capable of:

- Enabling or disabling an individual fixture or an entire group of fixtures from an operator work station
- Controlling the maximum number of simultaneous flushes (adjustable from 1-999) that can occur within a given time period (adjustable from 1-60 seconds)
- Automatically flushing a toilet after an adjustable period of non-use has passed to prevent the trap from drying out and water stagnating
- Logging all valve activity, including all overflow and alarm conditions
- Allowing for a remote flush from an operator work station
- Allowing for valve timing changes to be made from an operator work station
- Providing schedule use periods of selected fixtures
- Providing an interflush delay of up to four hours after a specified number of flushes in a given period of time
- Providing overuse control to set the maximum on time of any fixture function within a defined time period up to one day (24 hours)
- Providing options of how overuse will be handled:
 - only operator notification
 - fixture function lockout requiring operator intervention
 - auto-lockout of fixture function requiring sufficient time period to elapse until fixture comes out of overuse condition
- Providing three levels of operational security with privileges for each level as follows:
 - Operator Security Level
 - Remote flush
 - Lockout fixtures
 - Reset fixtures
 - Reset alarms
 - Supervisor Security Level
 - All of the above plus the following:
 - Set supervisor password
 - Adjust valve timing
 - Set and adjust scheduled use periods
 - Set overuse parameters & system response to overuse
 - Enable and set parameter of flush guard
 - Turn on activity logging
 - Enable and assign sound effects
 - Builder Security Level
 - All of the above plus the following:
 - Set builder password
 - Set communication settings
 - Place bit map floor plans or screens
 - Insert, set, and adjust fixtures
 - Delete fixtures

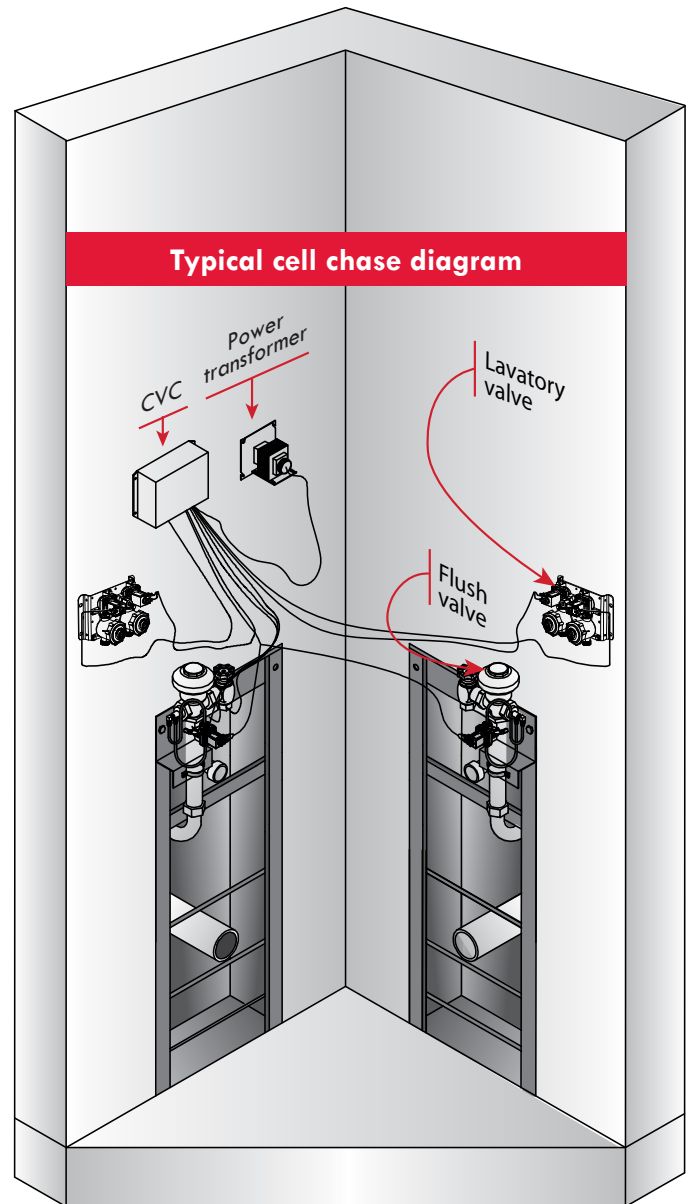

ANTI-SUICIDE FIXTURES



27

Willoughby anti-suicide fixtures are fabricated from heavy gauge, type 304 stainless steel with all-welded construction and exposed stainless surfaces polished to a satin finish. Call a Willoughby sales representative today at 1-800-428-4065.



1806 SERIES

- Combination Lavatory and Toilet
- 18" Wide
- Rear Mounted
- Anti-suicide



ASHS-1013-06

- Lavatory
- 18" Wide
- Rear Mounted
- Anti-suicide



ASCWSMS

- Single Station Wall Shower
- Front Mounted
- Anti-suicide



ASGB SERIES

- Grab Bar
- Lengths of 24", 36", 42", 48", and 33"x18"
- L-shaped.
- Includes Anti-suicide Plate



WILLOUGHBY

COUNT ON US.

Thank you for considering Willoughby products. With over sixty years of experience, our focus rests solely on providing the finest commercial plumbing products and service available in the industry. We are proud of the fact that our products are manufactured in the U.S.A. and sold throughout the world.

Our Indianapolis, Indiana manufacturing facility employs craftspeople that are committed to the research, design, and production of stainless steel and solid surface plumbing fixtures and accessories of the highest quality.

As you consider the selection and use of fixtures and/or accessories for your next project, we respectfully ask for your business. You can COUNT ON US to meet and exceed your expectations.



Willoughby Industries, Inc. reserves the right to make changes without notice in design, specifications, and models. © 2014 Willoughby Industries, Inc., All rights reserved. 69019

317.875.0830 PHONE | 317.875.0837 FAX | 1.800.428.4065 TOLL FREE | www.willoughby-ind.com