

SEPARATE MOTION AFTEREFFECTS FROM EACH EYE AND FROM BOTH EYES

STUART ANSTIS and KATHY DUNCAN

Department of Psychology, York University, 4700 Keele Street,
Downsview, Ontario, Canada M3J 1P3

(Received 19 May 1981; in revised form 24 June 1982)

Abstract—Monocular and binocular motion aftereffects (MAEs) are described, which were contingent upon which eye(s) was (were) exposed to the adapting motion. Subjects viewed clockwise rotation of a patterned disc with their left eye, alternating every 5 sec with anticlockwise rotation seen with their right eye, for a 10-min adapting period. Result: they saw an anticlockwise motion aftereffect with their left eye, and a clockwise MAE with their right eye. These monocular MAEs lasted for only 2–20 sec, but could be elicited repeatedly over a 2–6 min period, and could still be re-elicited two hours later. In a second experiment, subjects adapted for 10 min to the following cycle of 5-sec rotations: left eye, clockwise; right eye, clockwise; and both eyes together, anticlockwise. Result: they saw an anticlockwise MAE with their left eye only or with their right eye only, and a clockwise MAE when both eyes were open. A model of monocular and binocular inputs to motion sensitive neural channels is proposed.

INTRODUCTION

Following inspection of a slowly rotating disc, a subsequently viewed stationary disc often appears to be rotating back in the opposite direction. This is the well-known motion aftereffect. It is produced by movement of contours across the retina, and is independent of eye movements (Sekuler and Ganz, 1963; Anstis and Gregory, 1965). It is probably caused by adaptation of neural units which are selective to the direction of seen motion (Barlow and Hill, 1963; Srinivasan and Dvorak, 1979). Such units have been found in most vertebrate species (reviewed by Grüsser and Grüsser-Cornehls, 1973). Our study used psychophysical methods to assess the probable sites of motion aftereffects within the human visual system, based on techniques devised by Anstis and Moulden (1970) and especially by Vidyasagar (1976).

Motion aftereffects show interocular transfer. A motion aftereffect induced by inspecting an adapting motion with the left eye can be elicited by viewing a stationary test surface with the right eye (Favreau, 1976). However, this finding tells us little about the physiological site of the aftereffect. It does not demonstrate an origin central to the locus of binocular fusion, for instance, because it might well be that the adapted (left) eye is sending up a retinal aftereffect signal which is combined somewhere in the brain with the signal of a stationary test field from the unadapted right eye. Barlow and Brindley (1963) and Scott and Wood (1971) used a pressure-blinding technique to avoid this difficulty. Barlow and Brindley found interocular transfer even when the adapted eye was pressure-blinded between looking at the adapting motion with one eye and examining for its aftereffect in the other. This showed that the MAE did not reside in activity in the retinal ganglion cells. Various other

studies have shown that the MAE is probably central, not retinal, in origin, and that it involves both monocular and binocular channels in the brain. Wohlge-muth (1911) found that if one looks at a rotating spiral with one eye, and at another spiral rotating in the opposite direction with the other eye, one can elicit independent MAEs from each eye separately, although no MAE is seen when both eyes are open. These MAEs presumably lie in monocularly driven channels. Anstis and Moulden (1970) replicated this, and also used a stroboscopic display to share out the motion information between the two eyes. They flashed an interleaved stroboscopic sequence to the two eyes, designed so that the left eye on its own saw clockwise motion, and so did the right eye on its own, but the two eyes together saw anticlockwise motion. Subsequently, subjects saw a brief clockwise MAE, which must have been central to the point of binocular fusion. Papert (1964) reached a similar conclusion, using a dynamic random-dot stereogram in which neither eye on its own could see a coherent pattern, but moving stereoscopic bars could be seen when the two eyes fused the disparate sets of random dots. Inspection of these cyclopean bars gave rise to a short-lived MAE, which must have been central to the point of binocular fusion.

Blake (1972, 1974) applied some of these techniques to another aftereffect, namely contrast threshold elevation following inspection of a stationary grating. He used pressure-blinding to show that the threshold elevation was more central than the retina (1972), and the rivalry technique to show that it was peripheral to the point of binocular rivalry (1974).

Moulden (1980) measured the duration of MAEs produced by adapting one or both eyes, and then testing either the same eye, the other eye, or both eyes. He concluded that MAEs could result from the

adaptation of either monocular or binocular neurons, and that the strength of the MAE depended upon what subset of the tested neurons had been previously exposed to motion.

We used a modified interocular transfer design in two experiments. In our first experiment, the stimulus was alternately a disc rotating to the left, seen by the left eye, and the same disc rotating to the right and seen by the right eye. Result: when the two differently adapted eyes alternately viewed a stationary test disc, each eye saw its own aftereffect. These aftereffects were presumably built up either in retinal neurons, or (more probably) in more central neurons which received monocular inputs. In our second experiment, three stimuli were presented cyclically: a disc rotating to the right seen by the left eye, then the same disc still rotating to the right seen by the right eye, then the same disc now rotating to the left, seen by both eyes open together. Result: each eye alone saw an aftereffect apparently to the left, while both eyes when open together saw an aftereffect to the right. In our opinion, these "monocular" and "binocular" aftereffects probably reside in neurons receiving inputs from both eyes, and these inputs are, respectively, mutually inhibitory and mutually facilitatory.

EXPERIMENT 1

Procedure

Subjects viewed a patterned disc with the left eye as it rotated anticlockwise and with the right eye as it rotated clockwise. Each of these presentations was for 5 sec. and the cycle was repeated 60 times to give a

total adapting period of 10 min. The motor was then switched off, and each subject viewed the disc with each eye in alternation and noted any motion aftereffect, continuing until no further motion aftereffects were reported.

The stimulus was a 15 cm dia. disc which subtended 7.5° visual angle at the viewing distance of 114 cm. The disc was covered with random-dot speckled texture (Letratone 936) and was centred in a 27 × 27° stationary square screen, which was also speckled. The disc could be slowly rotated clockwise or anticlockwise at 4.65 rpm by a reversible servomotor.

Seven subjects were run, of whom five were unaware of the purpose of the experiment. Subjects were shown how to cover one eye with the palm of their hand while viewing the disc with the other eye. They then fixated the centre of the disc and adapted alternately to anticlockwise rotation with their left eye and to clockwise rotation with their right eye. Each of these presentations was for 5 sec. and the total adapting time was 10 min. A buzzer sounded every 5 sec. at which time the subject changed eyes and the experimenter flipped a reversing switch on the motor.

The motor was then stopped and the subject viewed the stationary disc with only one eye open and noted any MAE. As soon as he (or she) reported that the MAE had disappeared, he switched to his other eye and again noted any MAE. Half the subjects started with their left eye, the other half with their right eye. This test cycle was repeated until no further MAEs were reported. This took between 2–6 min for different subjects. The whole testing period was recorded on tape for later analysis. In this analysis, each MAE was timed to the nearest second, and aftereffects were plotted on separate graphs for the left and right eyes.













Each subject was re-tested (without further adaptation) 30 min after the end of adaptation, and again 2 hr after the end of adaptation.

Results

Results are plotted in Fig. 1. The abscissa shows total time elapsed since the start of the test period, and the ordinate shows the duration of each separate successive MAE. Note that the data do *not* represent the gradual decay over time of a single MAE. Instead, each datum point represents the total duration of a separate MAE, and the whole set of points portrays a sequence of separate MAE durations, in which each MAE tends to be briefer than its predecessors. Notice also that the spacing of the MAEs along the elapsed-time abscissa depends upon their duration. A 12-sec MAE which began at time 1 min would be plotted at time 1 min, 12 sec.

Figure 1 shows that the two eyes gave independent MAEs in opposite directions. Viewing the test field with the right eye (solid symbols) gave anticlockwise MAEs, which are plotted above the zero line in Fig. 1. Viewing with the left eye (open symbols) gave clockwise MAEs, which are plotted below the zero line.

Table 1

	Left eye	Right eye
Experiment 1		
Adapt		—
	—	
Test		—
	—	
Experiment 2		
Adapt		—
	—	
		
Test		—
	—	
		

Experimental conditions: solid arrows show direction of adapting motion; dashed arrows show directions of reported motion aftereffects.

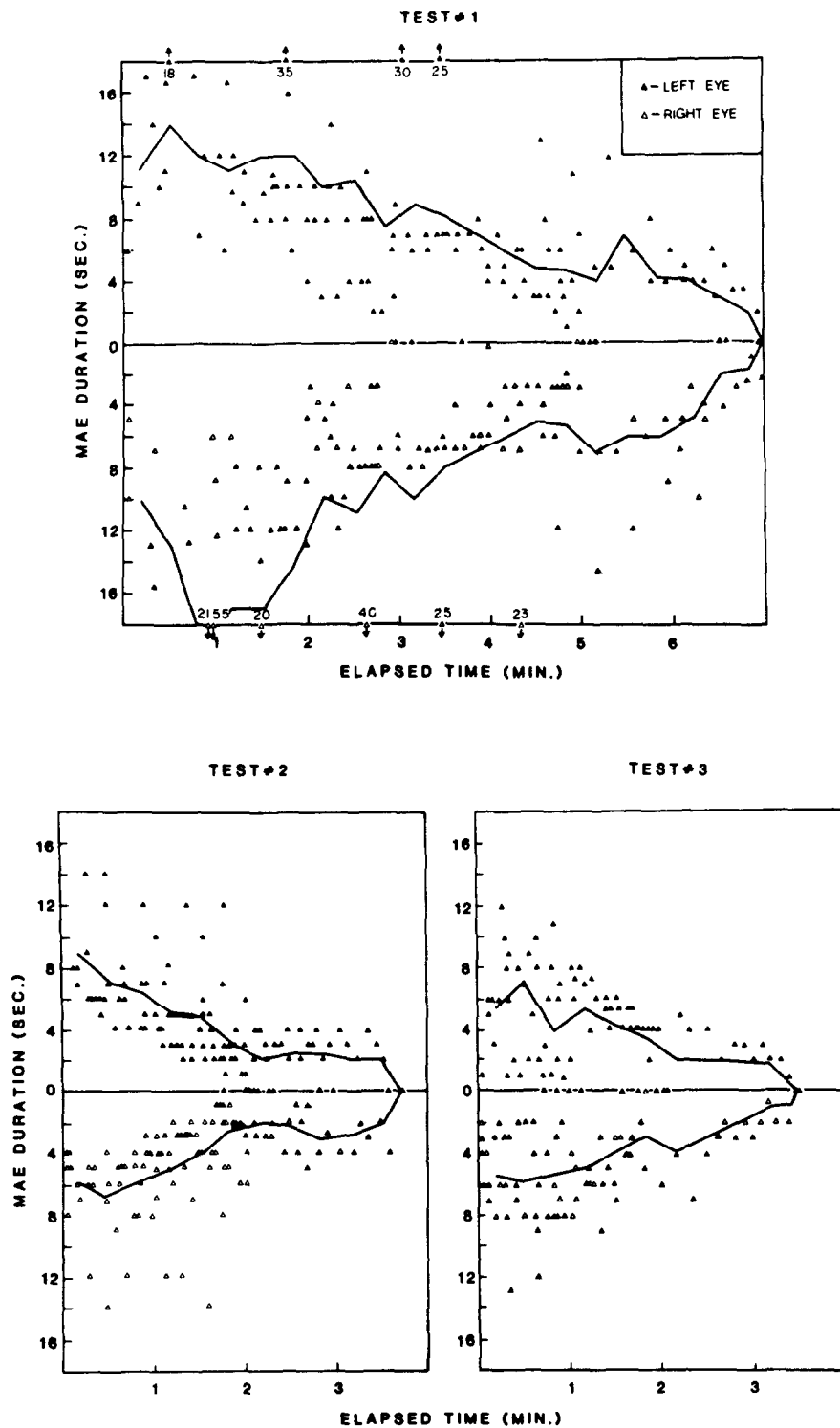

Fig. 1. Duration of motion aftereffects in Experiment 1. Each datum point represents the duration of a single MAE for one subject. Line represents mean for all subjects. Anticlockwise MAEs are plotted above zero, clockwise MAEs below. Subjects adapted their left eye to clockwise motion and their right eye to anticlockwise motion. Then they viewed stationary test disc with their left eye (solid triangles) and timed their MAE. They changed their right eye (open triangles), timed their MAE, and so on in alternation. Tests Nos 1, 2 and 3 were run 0, 30 and 120 min after the end of the adapting period.

When both eyes together viewed the test field, no MAE was reported (not shown in Fig. 1). Presumably the two equal and opposite MAEs were cancelling out.

Also, the MAEs could be revived by a rest of only a few seconds. When the clockwise MAE from the left eye had run down, an anticlockwise MAE was elicited from the right eye, and on returning to the left eye a fresh clockwise MAE could again be elicited from it. The duration of successive MAEs gradually reduced until they finally disappeared. Each MAE lasted about 2–20 sec. but the total time over which a sequence of MAEs could be elicited might be as long as 6 min.

Furthermore, after a 6-min sequence of MAEs had been collected, and no further MAEs could be elicited

from either eye, a rest of half an hour revived the MAEs so that a second sequence could be collected. After a further rest of 90 min, a third sequence was collected. MAEs tended to be briefer in the second and third test sessions than in the first.

EXPERIMENT 2

Procedure

The procedure was the same as for Experiment 1, except that three viewing conditions were used instead of two. The disc was first seen rotating clockwise by the left eye alone for 5 sec. then rotating, also clockwise, by the right eye alone for 5 sec: then it rotated anticlockwise and was viewed by both eyes

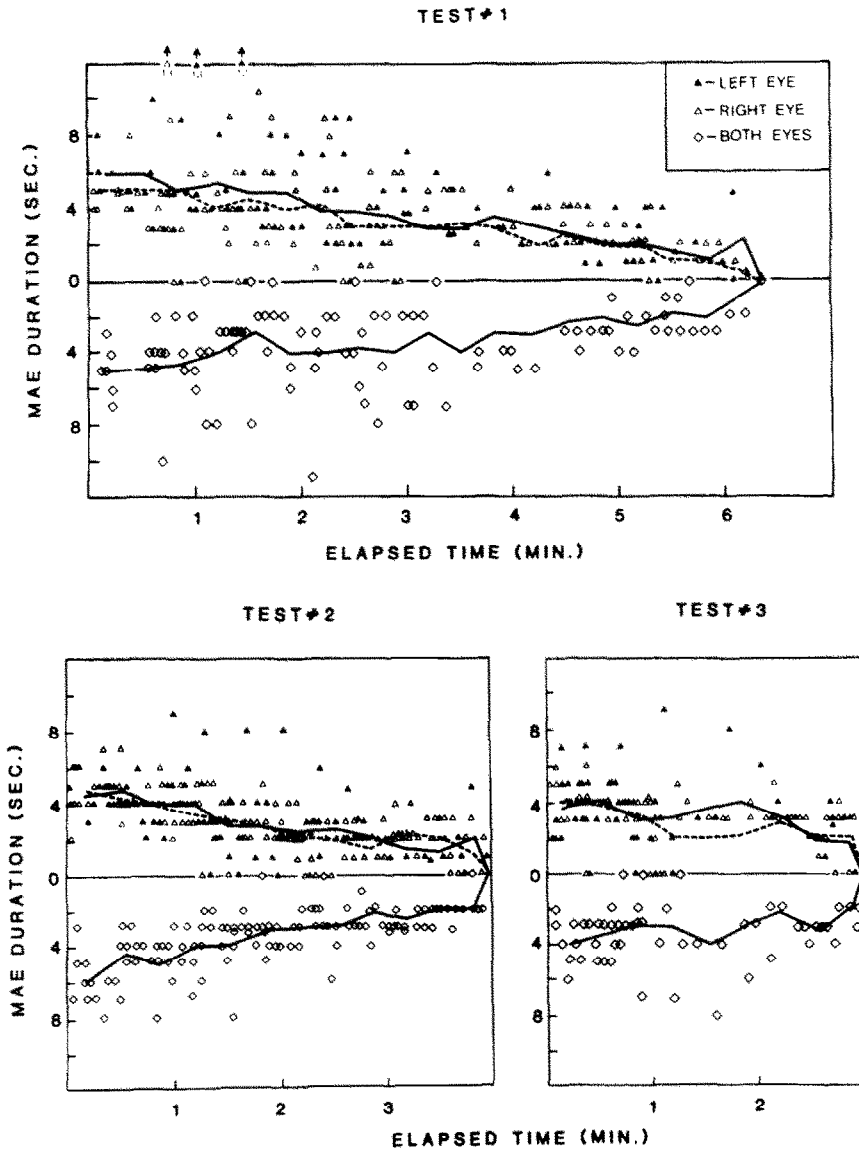

Fig. 2. Motion aftereffects in Experiment 2. Same as Fig. 1, except that left eye was adapted to clockwise motion: so was right eye: but both eyes together were adapted to anticlockwise motion. Results: left eye saw anticlockwise MAEs, and so did right eye, but both eyes together (open diamonds below zero line) saw clockwise MAEs.

together for a further 5 sec. This adapting cycle repeated 40 times for a total adapting period of 10 minutes. Notice that in terms of total viewing time, each eye saw equal amounts of clockwise and anticlockwise rotation, but a contingency was established such that rotation was clockwise whenever only one eye was open, and anticlockwise when both eyes were open.

In the test period the subject viewed the stationary test disc first with one eye, then with the other eye, and then with both eyes together. In each case he watched until any MAE had stopped, said so, and immediately switched to the other eye (or to both eyes). The test cycle was repeated until the aftereffects had died away. As in Experiment 1, a second and third test session were run 30 min and 2 hr after the end of adaptation.

Results

Results are plotted in Fig. 2. Conventions are the same as in Fig. 1. It was found that when the test field was viewed with the left eye alone (solid triangles) or with the right eye alone (open triangles), anticlockwise MAEs were reported, which are plotted above the zero line in Fig. 2. When both eyes were open (open diamonds), clockwise MAEs were reported, which are plotted below the zero line. Thus, separate monocular and binocular MAEs had been built up in opposite directions. Moreover, the monocular MAEs could be elicited from either the left eye alone or from the right eye alone.

As before, a sequence of MAEs could be elicited, and when they had run down a rest of 30 or 120 min could revive them. Overall, MAEs tended to be shorter in the conditions of this experiment than they were in Experiment 1.

It can be seen from Figs 1 and 2 that in Test No. 1, immediately after adaptation, the initial MAEs were longer than in Tests Nos 2 and 3. The median durations for the initial MAE in Tests Nos 1, 2 and 3 were 11.7, 6.6 and 7.0 sec for Experiment 1, and 7.0, 5.2 and 4.4 sec for Experiment 2. Thus the MAEs "extinguished" during each test period and then spontaneously recovered by the start of the next test period, but they never regained the same initial strength as they had at the start of Test No. 1.

DISCUSSION

Although subjects differed considerably in the absolute duration of their MAEs, every subject showed the same basic pattern of responses:

1. MAEs were opposite to the direction of the adapting motion which had previously been seen by that eye (or eyes).
2. Each test period consisted of a sequence of MAEs, whose durations gradually decreased.
3. MAEs recovered in strength during the rest periods between tests, although they never again

reached the strength which they enjoyed immediately after adaptation.

4. MAEs could be established even though the stimulated region of the retina had been exposed to equal and opposite motions. If the visual system were linear, this would make any simple MAEs cancel out.

Simple vs contingent aftereffects

Should our MAEs be thought of as eye-contingent MAEs? Or as a set of relatively independent simple (non-contingent) MAEs which are set up in different parts of the visual system, namely in monocular or binocular pathways? We cannot answer this question, but we shall discuss it in the light of the time-course, the opponence and the possible neural sites of our MAEs.

Time-courses

The results of our Experiment 1 confirm the findings of Wohlgenuth (1911), Anstis and Moulden (1970), and Favreau (1976). Our MAEs were not single, one-shot affairs, but could be elicited repeatedly. We adopted the procedures commonly used to measure contingent as opposed to simple MAEs (Mayhew and Anstis, 1972; Anstis and Harris, 1974).

Our MAEs were not particularly long-lasting (2–20 sec), but they could be elicited repeatedly over a period of hours. This time-course is consistent with the MAEs being utricular-contingent, but it is also consistent with their being simple MAEs, as demonstrated by Favreau (1979). Time-courses have sometimes been used as a criterion to distinguish simple from contingent aftereffects. However, a survey of the literature shows that this criterion is unreliable. At one time it was generally assumed that a simple aftereffect was a relatively brief, one-shot affair, whereas contingent aftereffects could be re-elicited many times, and could show an extraordinary persistence. Thus, Jones and Holding (1975) found that the McCollough aftereffect (McCollough, 1965) was still available at half its initial strength at least 3 months after 15 min of exposure to the adapting stimulus. But now, long durations for simple (non-contingent) aftereffects have been reported. As long ago as 1969, Masland reported that a simple motion aftereffect could still be seen 24 hr after a 15-min adaptation to a rotating spiral. This was confirmed by Kalfin and Locke (1972). Blake-more *et al.* (1970) reported simple aftereffects based upon spatial frequency which lasted up to several hours. Frome *et al.* (1979) pointed out a possible procedural artifact: in many experiments the adaptation time allotted to building up simple aftereffects is only tens of seconds, but for contingent aftereffects it is often tens of minutes. This procedural difference introduces a bias which tends to make contingent aftereffects longer than simple ones. Frome *et al.* found that a simple size-illusion aftereffect could persist for about one day, if the adaptation period was made as long as 10 min. They concluded that simple and contingent aftereffects tend to have fairly similar

time-courses when they are given similar adapting periods. Keck and Pentz (1977) showed that in any case the duration of a simple MAE is not a reliable guide to the duration of the adaptation in the underlying neural substrate. They used a standard adaptation period of 30 sec which presumably gave a standard amount of neural adaptation, and which gave an exponentially decaying MAE. However, the time constant of this MAE increased systematically as the contrast of the test grating was reduced.

All these experiments indicate that simple and contingent aftereffects do not always differ reliably in duration. What about persistence? (Duration refers to the length of time on any one test that the MAE is perceptible; persistence refers to how long after adaptation the MAE can be observed.) Favreau (1979) compared the persistence of simple and contingent MAEs. She exposed groups of subjects either to a single rotating spiral in order to build up a simple MAE, or else to a spiral which rotated clockwise under red light, alternating with anticlockwise under green light, in order to build up a colour-contingent MAE. For both groups the total adapting period was 16 min. Both groups were then tested at postadaptation intervals of 7 min, 24, 48, 96 or 168 h. She found that the simple and contingent MAEs were comparable in persistence, with both effects lasting for about a week. Both could be elicited repeatedly. Thus persistence, like duration, did not discriminate reliably between simple and contingent MAEs.

We were able to elicit MAEs repeatedly over a two-hour period. Together with the findings of Keck and Pentz (1977) and of Favreau (1979), this demonstrates that the dissipation of the MAE is not evidence that the underlying neural substrate has recovered to the preadaptation state. However, it does not tell us whether our MAEs were simple or eye-contingent.

Opponence

In considering whether our MAEs are simple or contingent, we should remember that simple MAEs are based upon simple adaptation of a patch of retina to motion in one direction. However, a contingent MAE is produced by opponent adaptation which applies equal and opposite motions to the same patch of retina. This would make any simple MAEs cancel out. A contingency is established by pairing the motion with (say) colour or depth. Mayhew and Anstis (1972) presented an adapting disc which rotated clockwise under red light, alternating with anticlockwise under green light. Subsequently, a stationary test disc showed an anticlockwise MAE when viewed under red light, and a clockwise MAE when viewed under green light. If the test lighting was made to alternate every few seconds between red and green, a series of clockwise and anticlockwise MAEs was seen. Anstis and Harris (1974) produced MAEs which were contingent upon depth or binocular disparity. They exposed their subjects to a disc rotating clockwise in a plane lying in front of the fixation

point, alternating with a disc rotating anticlockwise in a plane lying behind the fixation point. A stationary test disc then showed an anticlockwise (clockwise) MAE if it lay in front of (behind) the fixation point. They attributed this to motion adaptation in populations of hypothetical neurons which are tuned to different binocular disparities.

In our experiments we paired the motion, not with a stimulus variable such as colour or depth but with the eye viewing the stimulus. This can be regarded as an "eye-contingency," rather like the MAE contingent on direction of gaze which was reported by Mayhew (1973). But this sounds very unlike most other contingent aftereffects, which do pair motion with colour, etc.; should we classify our MAEs as eye-contingent, or as several simple MAEs in monocular or binocular pathways? The problem can be resolved by generalizing from McCollough's (1965) notion that her aftereffect involves chromatic adaptation of orientation detectors. We suggest that it makes little difference whether we speak of (1) MAEs contingent upon one or both eyes, i.e. motion adaptation in parts of the visual system whose inputs are labelled to "detect" the eye of origin, or (2) simple MAEs in neural pathways receiving inputs from one or both eyes. Let us now consider the probable neural site of our MAEs.

Neural site

The literature offers seemingly contradictory clues about the neural site of the MAE. The pressure-blinding experiment of Barlow and Brindley (1963) showed clearly that it is post-retinal. Further localization is controversial. The rivalry experiment of Lehmkühle and Fox (1975) suggests that the MAE is peripheral to the point of binocular rivalry, but the cyclopean experiment of Papert (1964) and the dichoptic experiments of Anstis and Moulden (1970) locate it central to the point of binocular fusion. Thus the fusion-point would be peripheral to the MAE, which in turn would be peripheral to the rivalry-point. But intuitively it is highly unlikely that the site of binocular rivalry could lie central to the point of binocular fusion. Once the images from the two eyes are fused, it is too late for rivalry. These conflicting findings may indicate not just one MAE at a single neural site, but a number of different MAEs, some sited in monocular pathways, others in binocular pathways.

Experiment 1 suggests that independent MAEs can be set up in monocularly driven neural channels. Figure 3a (after Moulden 1980) presents a very simple linear model. Experiment 2 reveals some non-linearities. In this experiment, each eye had received equal durations of clockwise and anti-clockwise adapting motion. Hence, any linear system, to which the principle of superposition applies, would not have shown any aftereffect in these conditions, because the equal and opposite adapting motions would simply have cancelled out, leaving no net aftereffect. It follows that the visual system was behaving non-linearly. This argument applies equally to monocular units driven

exclusively by one eye and to binocular units driven symmetrically or asymmetrically by both eyes. If their response was linear, such that their response to binocular stimulation was equal to the sum of their responses to each eye on its own, they would have shown no aftereffects.

Figure 3a needs to be modified to accommodate the "monocular" and "binocular" MAEs of Experiment 2. The binocularly driven channel in Fig. 3a would develop no MAEs, since it receives equal and opposite motion inputs. A non-linear, synergistic unit would develop MAEs, since its response to binocular inputs would be greater than the sum of its responses to inputs from the left and the right eye if presented separately. Such a unit would resemble an AND-gate, whose action threshold is exceeded by binocular but not by monocular inputs.

This will account for the "binocular" MAE of Experiment 2. By the same token, the monocular channels in Fig. 3 received equal and opposite adapting motions, so they would not develop the "monocular" MAEs; unless they were inhibited during the binocular phase of adaptation, perhaps by inhibitory inputs from the binocular channel (Fig. 3b).

Thus, the binocular motion aftereffect points to motion adaptation in synergistic (non-linear) binocular

units which give only a weak response to stimulation from either eye alone, but a very much stronger response to simultaneous stimulation from the two eyes. Electrophysiologically, many cells have been shown to be of this type (Hubel and Wiesel, 1962, 1965; Barlow *et al.*, 1967; Pettigrew *et al.*, 1968). The monocular aftereffect points to motion adaptation in units which are excited by one eye and inhibited by the other eye (Henry *et al.*, 1969; Bishop *et al.*, 1971; Noda *et al.*, 1971; Creutzfeldt *et al.*, 1971).

Henry *et al.* (1969) and Bishop *et al.* (1971) examined binocular interactions in single units of the cat striate cortex. They found that when the receptive fields from each eye were accurately aligned there was considerable binocular facilitation, with a firing rate about 75% greater than the sum of the firing rates when each eye was stimulated separately. However, facilitation switched to depression for very small degrees of receptive field misalignment at right angles to the optimal stimulus orientation. The important point for our purposes is that these units acted in a highly non-linear way. According to the disparity of the stimulus, the inputs from each eye on to a single cortical unit would either be facilitatory and synergistic, with a binocular output much greater than the sum of the monocular outputs, or else inhibitory, with a binocular output which could be smaller than either monocular input on its own.

We attribute our MAEs to selective adaptation of different sub-populations of motion-sensitive cells. Figure 3a is a simple minimum model to fit our results from Experiment 1. Figure 3b is a modified version to fit our results from Experiment 2. The binocular units are now AND-gates, and they now provide new inhibitory inputs (heavy lines in Fig. 3b) to the previously monocular units, which now become "eye-opponent" cells.

"AND-gate" binocular neurons respond only when both eyes are stimulated; or at least are synergistic, giving a much greater response to inputs received from both eyes simultaneously than the sum of each eye on its own. These units are implicated in binocular fusion, and adaptation of these units would underlie not only the MAE induced by moving cyclopean contours (Papert, 1964), but also our "binocular" MAEs in experiment 2.

"AND-gate" neurons could be made to respond to dichoptic apparent motion, in which one flash is seen by one eye and a slightly displaced, later flash is seen by the other eye. To respond to dichoptic motion, the AND-gate would need to have an integrating time which was longer than the inter-stimulus interval. Given such a response, adaptation of these units would underlie the very brief MAEs which Anstis and Moulden (1970) were able to induce with dichoptic adapting motion. Otherwise, responses to dichoptic motion could be attributed to a separate class of hypothetical OR-gate binocular neurons.

"Eye-opponent" neurons are excited by inputs to the left eye but inhibited by inputs from the right eye

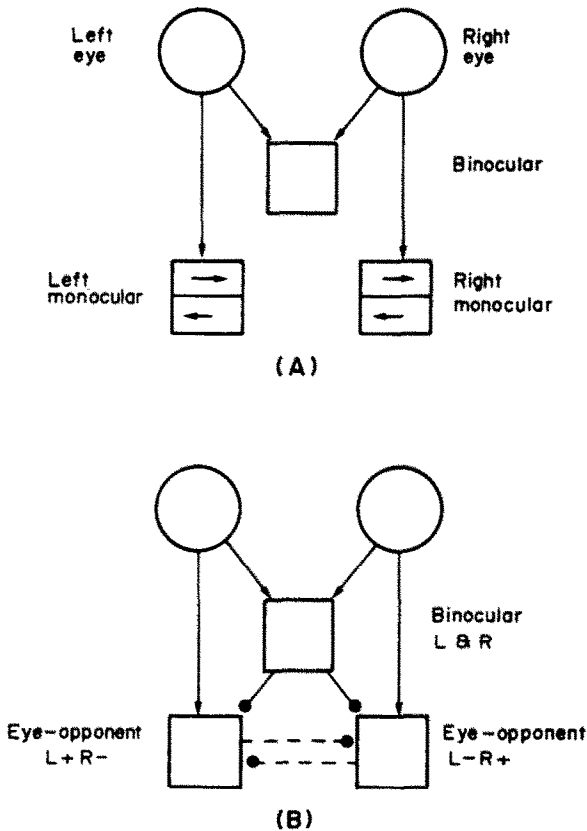

Fig. 3. (a) Model of monocular and binocular sites of MAEs in Experiment 1. (b) Model of sites of MAEs in Experiment 2. See text.

(L + R-) or vice versa (L - R+). We use the term "eye-opponent" by analogy with colour-opponent cells (red-plus, green-minus and vice versa) and spatial-opponent cells (on-centre, off-surround and vice versa). Wolfe (1981) has proposed a similar model on the basis of his psychophysical data: see also Wolfe and Held, 1981, 1983.

We attribute our "monocular" MAEs to adaptation of these eye opponent units—not to adaptation of straightforward monocular units (as in Fig. 3a), which by experimental design intentionally received equal and opposite adapting motion.

An optional extra feature (dashed line in Fig. 3b) could be mutual inhibition between the L + R- and the L - R+ eye-opponent units. This could provide a "seesaw" effect, like a multivibrator or square-wave oscillator. When the two eyes saw conflicting pictures, the AND-gate binocular units would be silent, and the seesaw would make inputs from the two eyes dominate in alternation. This would be a speculative model for binocular rivalry.

Interocular transfer

If one eye views the adapting motion and then the other eye views the stationary test stimulus, a MAE is still seen, even though its duration is reduced to about half the monoptic AE (Favreau, 1976; Moulden, 1980). This interocular transfer of the MAE raises problems for the binocular Left-AND-right gate proposed in Fig. 3b, which by definition would not be activated during monocular adaptation. To accommodate interocular transfer into the model the AND-gate can be modified so that it is not a Boolean AND-gate, but merely responds in a synergistic way, with a weak but non-zero response to monocular inputs and a very strong response to binocular inputs. Alternatively, the OR-gate of Fig. 3a can simply be left in the model. It will do no harm, since it will provide for interocular transfer, and will conveniently not respond in Experiments 1 or 2.

Although the units in our model are hypothetical constructs devised to explain psychophysical results, there is some evidence for their physiological plausibility. Hubel and Wiesel (1968) classified monkey cortical cells into seven dominance classes. Their ipsilaterally and contralaterally driven units correspond to our monocular units, and their binocularly driven units correspond to our AND-gate binocular units. Henry *et al.* (1969), Noda (1971) and Creutzfeldt *et al.* (1971) found neural units which are excited by one eye and inhibited by the other: these correspond to our "eye-opponent" units.

Acknowledgements—This research was supported by Grant No. A0260 from the National Science and Engineering Research Council of Canada (NSERC). We thank John Slavin for his assistance in setting up and running the experiments, and we thank Dr C. W. Tyler for commenting on a draft of this paper. This paper was written up while SMA was Visiting Professor at the Smith-Kettlewell Insti-

tute of Visual Science, San Francisco. We are grateful to the Smith-Kettlewell Eye Research Foundation for support.

REFERENCES

- Anstis S. M. (1967) Visual adaptation to gradual change of intensity. *Science* **158**, 710-712.
- Anstis S. M. and Moulden, B. P. (1970) Aftereffects of movement: Evidence for central and retinal components. *Q. J. exp. Psychol.* **22**, 222-229.
- Anstis S. M. and Harris J. P. (1974) Motion aftereffects contingent on binocular disparity. *Perception* **3**, 153-168.
- Barlow H. B. and Brindley G. S. (1963) Inter-ocular transfer of movement aftereffects during pressure blinding of the stimulated eye. *Nature* **200**, 1347.
- Barlow H. B. and Hill R. M. (1963) Evidence for a physiological explanation of the waterfall phenomenon and figural aftereffects. *Nature* **200**, 1345-1347.
- Barlow H. B., Blakemore C. B. and Pettigrew J. D. (1967) The neural mechanism of depth discrimination. *J. Physiol.* **193**, 327-342.
- Bishop P. O. (1973) Neurophysiology of binocular single vision and stereopsis. In *Handbook of Sensory Physiology, Vol. VII/3, Central Visual Information A* (Edited by Jung R.), pp. 255-305. Springer, Berlin.
- Bishop P. O., Henry G. H. and Smith C. J. (1971) Binocular interaction fields of single units in the cat striate cortex. *J. Physiol.* **216**, 39-68.
- Blake R. and Fox R. (1972) Interocular transfer of spatial frequency during retinal ischaemia. *Nature, Lond.* **240**, 76.
- Blake R. and Fox R. (1974) Adaptation to invisible gratings and the site of binocular rivalry suppression. *Nature, Lond.* **249**, 488-49.
- Blakemore C., Nachmias J. and Sutton P. (1970) The perceived spatial frequency shift: Evidence for frequency selective neuron in the human brain. *J. Physiol.* **210**, 727-750.
- Creutzfeldt O. D., Pöppel E. and Singer W. (1971) Quantitativ Ansatz zur Analyse der funktionellen Organisation des visuellen Cortex. In *1970 Kybernetik* (Edited by Grüsser O. J.), pp. 81-96. Springer, Berlin.
- Favreau O. E. (1976) Motion aftereffects: evidence for parallel processing in motion perception. *Vision Res.* **16**, 181-186.
- Favreau O. E. (1979) Persistence of simple and contingent motion aftereffects. *Percept. Psychophys.* **26**, 187-194.
- Frome F., Levinson J. Z., Danielson J. T. and Claudetscher J. E. (1979) Shifts in perception of size after adaptation to gratings. *Science* **206**, 1327-1329.
- Grüsser O.-J. and Grüsser-Cornehlis U. (1973) Neuronal mechanisms of visual movement perception and some psychophysical and behavioral correlations. In *Handbook of Sensory Physiology, Vol. VII/3, Central visual information, A* (Edited by Jung R.), pp. 333-430. Springer, Berlin.
- Henry G. H., Bishop P. O. and Coombs J. S. (1969) Inhibitory and subliminal excitatory receptive fields of simple units in cat striate cortex. *Vision Res.* **9**, 1289-1296.
- Hubel D. H. and Wiesel T. N. (1962) Receptive fields, binocular interaction and functional architecture in the cat's visual cortex. *J. Physiol.* **196**, 106-154.
- Hubel D. H. and Wiesel T. N. (1965) Receptive fields and functional architecture in two nonstriate visual areas (18 and 19) of the cat. *J. Neurophysiol.* **28**, 229-289.
- Hubel D. H. and Wiesel T. N. (1968) Receptive fields and functional architecture of monkey striate cortex. *J. Physiol., Lond.* **195**, 215-244.
- Jones D. D. and Holding D. H. (1975) Extremely long-term persistence of the McCollough effect. *J. exp. Psychol., Hum. Percept. Perform.* **1**, 323-327.

- Kalvin F. and Locke S. (1972) Evaluation of long-term visual motion afterimage following monocular stimulation. *Vision Res.* **12**, 359.
- Keck M. J. and Pentz. (1977) Recovery from adaptation to moving gratings. *Perception* **6**, 611-740.
- Lehmkühle S. W. and Fox R. (1975) Effect of binocular rivalry suppression on the motion aftereffect. *Vision Res.* **15**, 855-859.
- Masland R. H. (1969) Visual motion perception: Experimental modification. *Science* **165**, 819-821.
- Mayhew J. E. W. (1973) After-effects of movement contingent on direction of gaze. *Vision Res.* **13**, 877-880.
- Mayhew J. E. W. and Anstis S. M. (1972) Movement after-effects contingent on color, intensity and pattern. *Percept. Psychophys.* **12**, 77-85.
- McCollough C. (1965) Color adaptation of edge-detectors in the human visual system. *Science* **149**, 1115-1116.
- Moulden B. (1980) After-effects and the integration of patterns of neural activity within a channel. *Phil. Trans. R. Soc. B* **290**, 39-55. Reprinted in *Psychology of Vision* (1980). The Royal Society, London.
- Movshon J. A., Chambers B. E. I. and Blakemore C. (1972) Interocular transfer in normal humans and those who lack stereopsis. *Perception* **1**, 483-490.
- Noda H., Creutzfeldt O. D. and Freeman R. B. (1971) Binocular interaction in the visual cortex of awake cats. *Expl Brain Res.* **12**, 406-421.
- Pettigrew J. D., Nikara T. and Bishop P. O. (1968) Binocular interaction of single units in cat striate cortex: Simultaneous stimulation by single moving slit with receptive fields in correspondence. *Expl Brain Res.* **6**, 391-410.
- Scott T. R. and Wood D. X. (1966) Retinal anoxia and the locus of the aftereffect of motion. *Am. J. Psychol.* **79**, 435-442.
- Srinivasan M. V. and Dvorak D. R. (1979) The waterfall illusion in an insect visual system. *Vision Res.* **19**, 1435-1438.
- Vidyasagar T. R. (1976) Orientation specific colour adaptation at a binocular site. *Nature* **261**, 39-40.
- Wohlgemuth A. (1911) On the aftereffect of seen movement. *Br. J. Psychol. Monog. Suppl.* **1**.
- Wolfe J. (1981) On binocular single vision. Ph.D. Thesis, MIT.
- Wolfe J. and Held R. (1981) A purely binocular mechanism in human vision. *Vision Res.* **21**, 1755-1759.
- Wolfe J. and Held R. (1983) Shared characteristics of stereopsis and the purely binocular process. *Vision Res.* **23**. In press.