



# ARCHITECT'S GUIDE WINDOW HARDWARE

*September 2008*



# Architect's Guide

W I N D O W   H A R D W A R E

Kirsch, the most widely specified window hardware brand, offers a complete selection of window hardware and drapery heading systems suitable for virtually any installation. This guide will assist you in selecting and specifying the best solution for your facility needs.

[WWW.KIRSCH.COM](http://WWW.KIRSCH.COM)



# Architect's Guide

W I N D O W   H A R D W A R E

*This manual is designed to assist in the selection of Kirsch custom window hardware and special heading systems for various kinds of installations. It is divided into three convenient sections:*

1. *Kirsch custom window heading systems*
2. *Performance data of track systems*
3. *Basic component parts and specifications for each track system.*

## Window treatment products for every commercial and residential need

Founded in 1907, Kirsch is the world's leading manufacturer of window hardware. Kirsch pioneered the development of custom Architrac® and drapery heading systems to offer architects, interior designers and construction specifiers top quality, precisely engineered products for commercial, institutional and residential applications.

## Commercial/Contract Customer Service

Toll-Free 800-776-5788

## Specific product information

Individual product brochures are available for Ripplefold® and Baton Draw. Write for them or call toll-free.

## Drapery Heading Systems

Ripplefold® .....	3
Baton Draw systems .....	5

## Track Systems Performance .....6-7

## Draw Cord Operation

94001 Series.....	8-9
93001 Series.....	10-11
9095 Series.....	12

## Superfine® Contract Rods .....13

## Baton or Hand Drawn Operations

Application & Suggested Specifications.....	14-15
– 94003 Series	
– 94004 Series	
– 94005 Series	
– 94008 Series	
– 9046 Series	
Component Parts.....	16

## Cubicle Track Systems

Application & Popular Configurations.....	17
– 9600 Series	
– 9046 Series	
Component Parts.....	18

## Installation Aids.....19

Teflon® is a registered trademark of DuPont®  
Celcon® is a registered trademark of Ticona®

# Drapery Heading Systems

There are two headings that can be used with the various Kirsch Architrac® series. Each system uses a different pleating method to achieve unique and beautiful decorating effects. The custom heading system Ripplefold® offers definite benefits. It is designed for attractive appearance from both inside and outside a building — an advantage to designers who desire uniformity in the exterior appearance of a building. All custom tracks are designed for easy installation and maintenance.

## Ripplefold®

Soft ripple-like folds flow smoothly from one end of the track to the other. The effect is gently tailored — suitable for commercial or residential installations. Spaced carriers control drapery fullness.

### Features

- Panels can be pressed flat, yet fall into folds.
- Headings are suspended under the track.
- No hooks or pins.
- Stackback space is less than conventional draperies.
- Draperies easily snap on and off carriers.

### Recommendations

Recommended where draperies require frequent launderings, such as hospitals and institutions. Draperies have uniform ripple-like appearance inside and outside.

Note: When drapery pins can cause a safety hazard, use Ripplefold® snap systems.

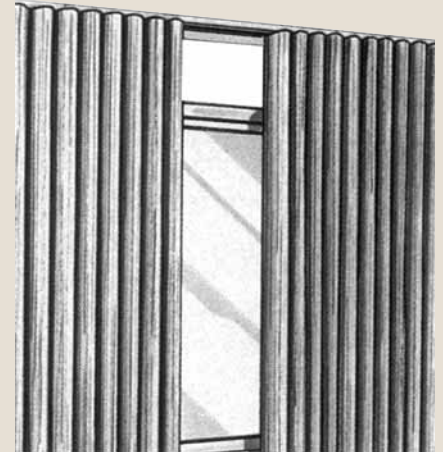

## Conventional Pleats

Familiar pinch-pleated draperies are attached to slide carriers with slip-in or pin-on hooks. Draperies can be custom-made or ready made. To select proper track system for this heading, see chart page 6.

### Features

- Can be used with most track systems.
- Headings can be suspended under the track or over the face of it.
- Most familiar of the heading systems.
- Can be tied back for effect.

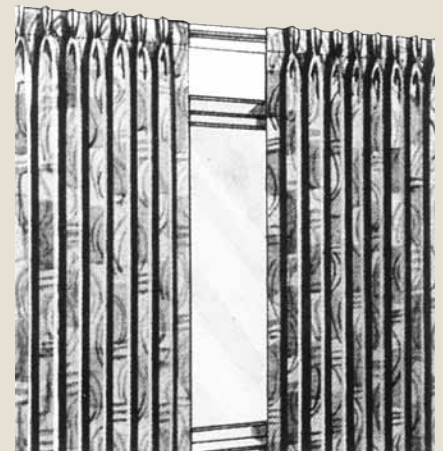

# Ripplefold® Drapery Heading System

An unbroken flow of softly rippled folds. Gently disciplined, uniquely fabricated so the panels can be pressed flat yet automatically fall into folds. Suitable for either commercial or residential installations. Folds are identically beautiful from inside the room or from outside the building — an architectural advantage. Stackback space is less. Headings are suspended under the track. Draperies easily snap on and off from carriers. Select fullness from four differently spaced snap carriers.

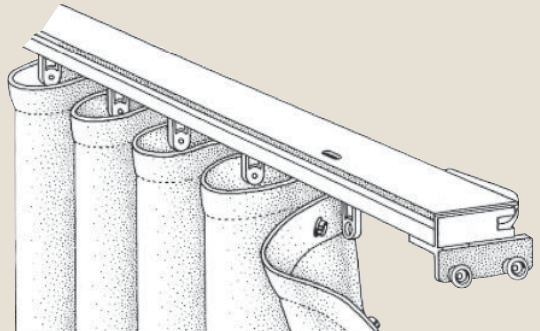

## Drapery specifications

Finished drapery panels to be fabricated per instructions in Kirsch Ripplefold Guide, F0337008, using No. 92145 stiffened nylon tape with snaps on 4¼" centers.

Bottom hems to be 4" wide with Kirsch No. 1615 covered lead weights in corner of each panel.

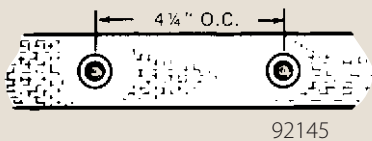

92145

(For Baton Draw, use F0337018 Fabrication Guide)

## Spaced carriers control drapery fullness

### Standard carriers

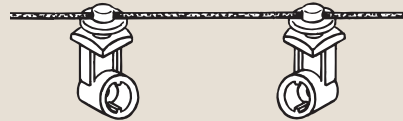

- Spaced snap carriers for use with all track systems except Nos. 93001
- No. 92140 for 120% fullness
- No. 92141 for 100% fullness
- No. 92142 for 80% fullness
- No. 92143 for 60% fullness

### Front load carriers



- Slide shoes for use with front load track systems Series 93001
- No. 93140 for 120% fullness
- No. 93141 for 100% fullness
- No. 93142 for 80% fullness
- No. 93143 for 60% fullness

## Applications

Can be used on track systems. For track specifications refer to page 6.

### Cord draw

No. 94001 Series

No. 93001 Series

No. 93601 Series

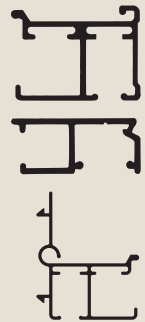

### Baton draw

No. 94003 Series

No. 94004 Series

No. 94005 Series

No. 9046 Series

No. 94008 Series

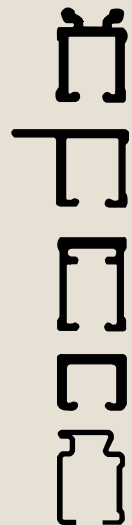

# Baton Draw System with Sewn-on Stiffener

## Custom Hand Draw System

Designed for a variety of commercial and institutional applications. Ideal for motels, hotels, dormitories, etc., where drapery and rod wear present special maintenance problems and costs. Puts baton in view of the user. No hidden cords. Just push or pull baton to open and close draperies. Multi-wheel masters will take torque in any direction. Can be used with conventional pleated and Ripplefold® heading systems.



## Features

- Stiffener is sewn and grommeted to drapery overlap.
- Stiffener socket is placed over master arm.
- Baton is attached by a screw through the eyelet and into the master arm.
- 92900 tooling with 94147 eyelet die required to grommet drapery.

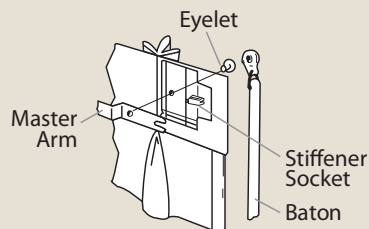

Back side of drapery

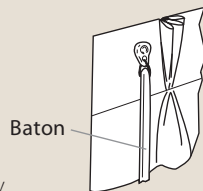

Front side of drapery

## Component Parts

### Multi-wheel baton masters

#### Nos. 94134 and 94133

Use with conventional pleated draperies

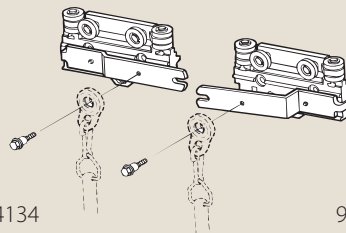

94134  
Left hand

94133  
Right hand

#### Nos. 94136 and 94135

Use with Ripplefold heading systems

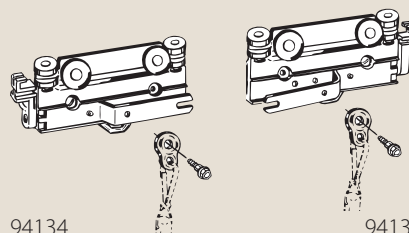

94134  
Left hand

94133  
Right hand

### Stiffeners

#### No. 94145

Overlap stiffener with eyelet  
For use with conventional pleated drapery trim; use with 94004.

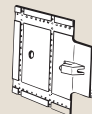

#### No. 94146

Overlap stiffener with eyelet  
For Ripplefold panels.



### Eyelet

Supplied with stiffeners



## Specifications

- Furnish and install Kirsch hand draw track Series 94003, 94004, 94005, or 94008
- Track to be equipped with appropriate components for heading system selected.
- Draperies to be grommeted with eyelet.
- Specify 2½', 3', 4', 5' or 6' baton.

### For conventional pleated draperies

Masters	No. 94133 R.H. No. 94134 L.H
Stiffener	No. 94145

### For Ripplefold









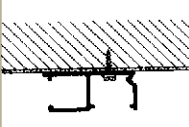

Masters	No. 94135 R.H. No. 94136 L.H
Stiffener	No. 94146

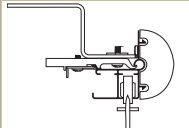
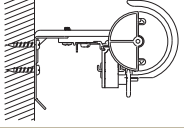
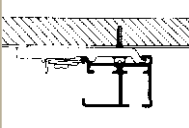
Refer to Baton Draw Systems Brochure F0337018

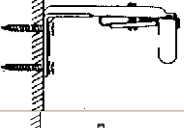
# Track Systems Performance Data

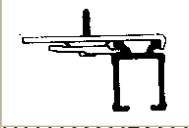
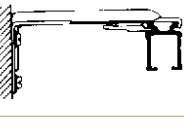
	SERIES	CROSS SECTION	MAX TRACK SET LENGTH	BENDING RADIUS	HEADING SYSTEMS
<b>Cord Draw Systems</b>					
<p>Track set is opened and closed by traverse cord.</p> <p>Continuous cord loop permits use of cord tension pulley.</p>	93001		One-Way Draw Two-Way Draw	16 ft. 32 ft.	12" *† Conventional Pleated Ripplefold <sup>∞</sup>
	93601		One-Way Draw Two-Way Draw	16 ft. 32 ft.	Not Available Conventional Pleated Ripplefold <sup>∞</sup>
	94001		One-Way Draw Two-Way Draw	½" pulley 16 ft. 1" pulley 20 ft. 32 ft. 40 ft.	12" *† Conventional Pleated Ripplefold <sup>∞</sup>
	9095		One-Way Draw Two-Way Draw	24 ft. 32 ft.	8" * Conventional Pleated
	3000 (Superfine)		One-Way Draw Two-Way Draw	12½ ft. 25 ft.	Not Available Conventional Pleated
<b>Hand Draw Cordless Systems</b>					
<p>Track set is opened and closed by hand — no cord involved.</p> <p>Fiberglass batons, attached to lead carriers, are recommended for traversing draperies.</p> <p>Maximum track lengths and maximum fabric weight do not apply to curved track. Send complete specifications and fabric weight to customer service for feasibility.</p>	94003		One-Way Draw Two-Way Draw	20 ft. 40 ft.	12" *† Conventional Pleated Cubicle Curtain Ripplefold
	94004		One-Way Draw Two-Way Draw	16 ft. 32 ft.	Not Available Conventional Pleated Cubicle Curtain Ripplefold
	94005		One-Way Draw Two-Way Draw	16 ft. 32 ft.	12" *† Conventional Pleated Cubicle Curtain Ripplefold
	9046		One-Way Draw Two-Way Draw	16 ft. 20 ft.	8" or 12" *† Conventional Pleated Cubicle Curtain Ripplefold
	94008		One-Way Draw Two-Way Draw	16 ft. 32 ft.	Not Available Pinch pleats Cubicle Curtain Ripplefold
<b>Footnotes</b>	<p>* Can be angular bent using radius listed or circular curved.</p> <p>† NOTE: Nos. 93001, 94001, 94003, 94005 and 9046 can be curved to a larger semi-circle radius. Contact customer service for more information.</p>				<p>∞ Maximum length for one-way draw Ripplefold<sup>®</sup> track systems is 16 feet.</p>

# Installation Application

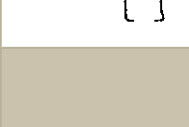
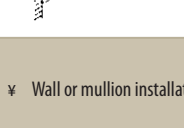
APPLICATION & BRACKET CLEARANCE		INTERMEDIATE SUPPORT SPACING	MAX FABRIC WEIGHT	LBS PER FOOT																
CEILING INSTALLATION	WALL INSTALLATION																			
	No brackets required	 2" - 3"	Track perforated 16" on center for direct mounting with screw. Wall Mount: Two brackets at each end 24" apart, 48" apart over remainder of track.	<table border="0"> <tr> <td></td> <td>½" pulley</td> <td>¾" pulley</td> <td></td> </tr> <tr> <td>One-Way Draw</td> <td>32 lbs.</td> <td>32 lbs.</td> <td>2</td> </tr> <tr> <td>Two-Way Draw</td> <td>32 lbs.</td> <td>40 lbs.</td> <td>2</td> </tr> </table>		½" pulley	¾" pulley		One-Way Draw	32 lbs.	32 lbs.	2	Two-Way Draw	32 lbs.	40 lbs.	2				
	½" pulley	¾" pulley																		
One-Way Draw	32 lbs.	32 lbs.	2																	
Two-Way Draw	32 lbs.	40 lbs.	2																	
	No. 1796 No. 94130	 3½" - 4½"	Two brackets at each end 24" apart, 48" apart over remainder of track	<table border="0"> <tr> <td>One-Way Draw</td> <td>48 lbs.</td> <td>3</td> </tr> <tr> <td>Two-Way Draw</td> <td>56 lbs.</td> <td>3.5</td> </tr> </table>	One-Way Draw	48 lbs.	3	Two-Way Draw	56 lbs.	3.5										
One-Way Draw	48 lbs.	3																		
Two-Way Draw	56 lbs.	3.5																		
	1½"	<table border="0"> <tr> <td>Single</td> <td>2¼" - 3¼"</td> </tr> <tr> <td>Double</td> <td>1¼" - 2½"</td> </tr> </table>	Single	2¼" - 3¼"	Double	1¼" - 2½"	Two brackets at each end 24" apart, 48" apart over remainder of track	<table border="0"> <tr> <td></td> <td>½" pulley</td> <td>¾" pulley</td> <td></td> </tr> <tr> <td>One-Way Draw</td> <td>32 lbs.</td> <td>64 lbs.</td> <td>3.1</td> </tr> <tr> <td>Two-Way Draw</td> <td>32 lbs.</td> <td>80 lbs.</td> <td>2</td> </tr> </table>		½" pulley	¾" pulley		One-Way Draw	32 lbs.	64 lbs.	3.1	Two-Way Draw	32 lbs.	80 lbs.	2
Single	2¼" - 3¼"																			
Double	1¼" - 2½"																			
	½" pulley	¾" pulley																		
One-Way Draw	32 lbs.	64 lbs.	3.1																	
Two-Way Draw	32 lbs.	80 lbs.	2																	
	No brackets required	 2" - 3" 4" - 5"	1 support 16" from each end, 32" apart over remainder of track	<table border="0"> <tr> <td>One-Way Draw</td> <td>30 lbs.</td> <td>1.9</td> </tr> <tr> <td>Two-Way Draw</td> <td>45 lbs.</td> <td>1.4</td> </tr> </table>	One-Way Draw	30 lbs.	1.9	Two-Way Draw	45 lbs.	1.4										
One-Way Draw	30 lbs.	1.9																		
Two-Way Draw	45 lbs.	1.4																		
	Drop-in 2" - 3"	 Push-in 2" - 3"	Two brackets at each end 24" apart, 48" apart over remainder of track	<table border="0"> <tr> <td>One-Way Draw</td> <td>15 lbs.</td> <td>1</td> </tr> <tr> <td>Two-Way Draw</td> <td>20 lbs.</td> <td>1.8</td> </tr> </table>	One-Way Draw	15 lbs.	1	Two-Way Draw	20 lbs.	1.8										
One-Way Draw	15 lbs.	1																		
Two-Way Draw	20 lbs.	1.8																		
	2"	 3½" - 4½" †	Two brackets at each end 24" apart, 48" apart over remainder of track	<table border="0"> <tr> <td>One-Way Draw</td> <td>40 lbs.</td> <td>2</td> </tr> <tr> <td>Two-Way Draw</td> <td>80 lbs.</td> <td>2</td> </tr> </table>	One-Way Draw	40 lbs.	2	Two-Way Draw	80 lbs.	2										
One-Way Draw	40 lbs.	2																		
Two-Way Draw	80 lbs.	2																		
	No brackets required	Not Available	Track perforated 16" on center for direct mounting with screws	<table border="0"> <tr> <td>One-Way Draw</td> <td>32 lbs.</td> <td>2</td> </tr> <tr> <td>Two-Way Draw</td> <td>64 lbs.</td> <td>2</td> </tr> </table>	One-Way Draw	32 lbs.	2	Two-Way Draw	64 lbs.	2										
One-Way Draw	32 lbs.	2																		
Two-Way Draw	64 lbs.	2																		
	No brackets required	Not Available	Track perforated 16" on center for direct mounting with screws	<table border="0"> <tr> <td>One-Way Draw</td> <td>32 lbs.</td> <td>2</td> </tr> <tr> <td>Two-Way Draw</td> <td>64 lbs.</td> <td>2</td> </tr> </table>	One-Way Draw	32 lbs.	2	Two-Way Draw	64 lbs.	2										
One-Way Draw	32 lbs.	2																		
Two-Way Draw	64 lbs.	2																		
	No brackets required	Not Available	Track perforated 16" on center for direct mounting with screws	<table border="0"> <tr> <td>One-Way Draw</td> <td>32 lbs.</td> <td>2</td> </tr> <tr> <td>Two-Way Draw</td> <td>64 lbs.</td> <td>2</td> </tr> </table>	One-Way Draw	32 lbs.	2	Two-Way Draw	64 lbs.	2										
One-Way Draw	32 lbs.	2																		
Two-Way Draw	64 lbs.	2																		
	3"	 3½" - 4½" †	Track perforated 16" on center for direct mounting with screw. Wall Mount: Two brackets at each end 24" apart, 48" apart over remainder of track.	<table border="0"> <tr> <td>One-Way Draw</td> <td>32 lbs.</td> <td>2</td> </tr> <tr> <td>Two-Way Draw</td> <td>64 lbs.</td> <td>2</td> </tr> </table>	One-Way Draw	32 lbs.	2	Two-Way Draw	64 lbs.	2										
One-Way Draw	32 lbs.	2																		
Two-Way Draw	64 lbs.	2																		
		† Wall or mullion installation																		

# Architrac Series 94001 Track

- Separate channels for operating equipment and carriers which hold draperies.
- Will accommodate Ripplefold® and standard pleated draperies.
- Remove and add slides with snap open end gate.

## Description

- For wall or ceiling mounting.
- Dual-channel, cord operated.
- Extruded .050" No. 6063T5 aluminum alloy, etched and anodized.
- White baked enamel finish.
- Two end pulleys to choose from for either lightweight or heavyweight draperies.
- Multiwheel roller-bearing masters prevent any binding and give easy traversing.

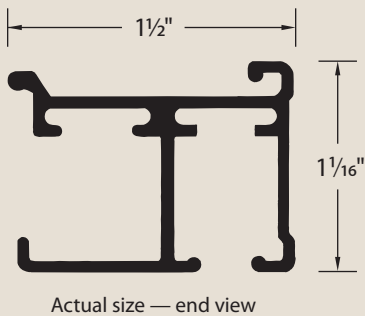

## Applications

Mounts on wall or ceiling (flush or recess). For spans up to 40' in a two-way draw. Track can be curved. This track series will accommodate Ripplefold® and conventional pleated drapery heading systems.

## Brackets

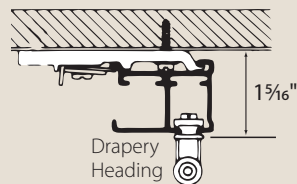

No. 94130  
Bracket for ceiling mounting

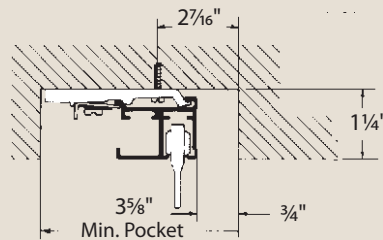

No. 94130  
Bracket for recess mounting

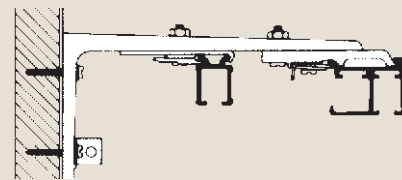

No. 94125  
Double bracket for wall mounting

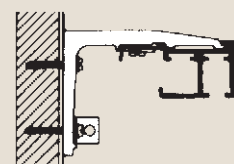

No. 94122  
Bracket for wall mounting  
3 1/2" return

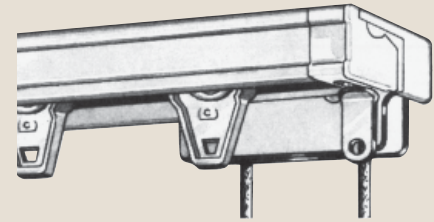

## Component Parts

### Standard Pulley set Nos. 94119 and 94120

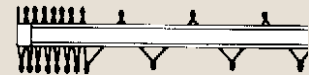
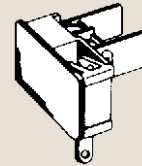

1/2" diameter Teflon® bearings for standard weight draperies where minimum stackback and uniform folding to the end of the rod is desired.

### Heavy Duty Pulley set Nos. 94101 and 94102

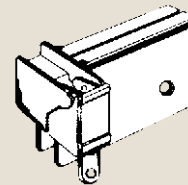

1" diameter heavy duty ball bearing pulley sets for heavier installations, larger spans.

Requires use of rod notching tool No. 9997



## Conventional Heading Systems

**Master Carriers for conventional pleated draperies**  
Nos. 94104 and 94103

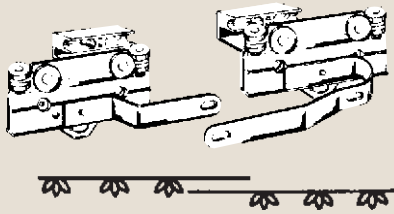

Multiwheel roller-bearing masters. Regardless of torque, master rollers won't bind.

## Optional Operational Components

**Butt Master Carriers**  
Nos. 94118 and 94117

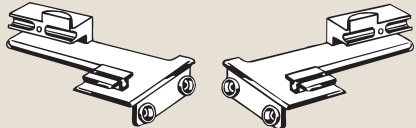

94118  
Left hand

94117  
Right hand

Drapery panels butt together at center.   
No flat areas or overlap shadow.

**Overlap Master Carriers**  
Nos. 94116 and 94115

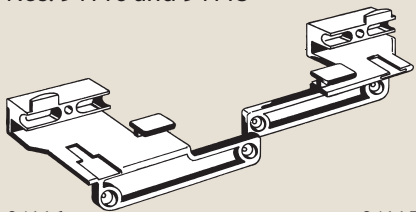

94116  
Left hand

94115  
Right hand

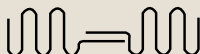
Drapery panels overlap at center. 

## Assembled Sets

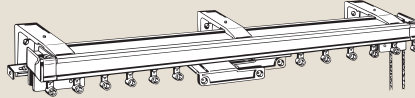

Set includes assembled rod, 94122 wall or 94130 ceiling brackets and 9923 cord tension pulley; longer brackets can be ordered separately. Rod may be angular bent or circular curved.

**Brackets:**  
Wall or ceiling mount.

**Draperies:**  
Pinch Pleat, Ripplefold® (butt or overlap masters and fullness).

**Fabrication and Planning Guides:**  
Ripplefold®-Tape: refer to F0337008

### Set with 1" end pulley

No. 94270H  
Finish (25) White, Baked Enamel

### Set with ½" end pulley

No. 94270  
Finish (25) White, Baked Enamel

## Suggested Specifications

- Furnish and install, as indicated on plans, Kirsch Track No. 94001, extruded of .050" 6063T5 aluminum alloy in accordance with Aluminum Association Specification. No.AA-C22A21. Finish (25) White, Baked Enamel
- Specify Mounting Brackets and Quantity
  - Ceiling
  - Wall – Single Track
  - Wall – Double Track
- Specify Drapery System and Fullness
  - Standard Pleated
  - Ripplefold® 120%, 100%, 80%, 60%
- Specify Master
  - Butt Master
  - Overlap Master
- End Pulley Options
  - ½" Teflon® Bearing  
Nos. 94119 and 94120
  - 1" H.D. Ball Bearing  
Nos. 94101 and 94102
- No. 9934 polyester cord, used with ½" Teflon® end and 1" ball bearing end pulley set.
- Tension Pulley to be No. 9923

# Architrac II Series 93001 Track

- Front loading carrier system for easy hanging of draperies.
- Large opening carrier channel accepts standard hex socket drivers for direct ceiling installation
- Available with either 3/4" or 1/2" end pulley sets.
- Choice of butt or overlap masters.
- Sliding edges coated with lubrication for smooth traversing action.

## Description

- For wall or ceiling mounting.
- Dual-channel, cord operated.
- Extruded .050" No. 6063T5 aluminum alloy, etched and anodized.
- Finish is white.
- Two end pulleys to choose from for either lightweight or heavyweight draperies.

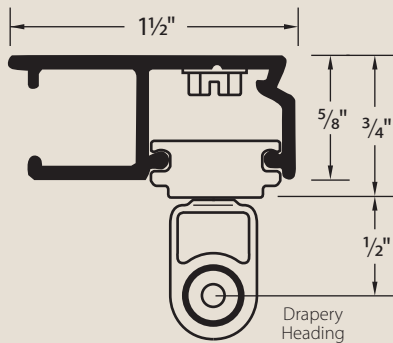

Actual size — end view

## Applications

Mounts on wall or ceiling. Track can be curved to any angle using a 12" radius or circular curve. Can be used in two-way draw for spans up to 32'. Will accommodate Ripplefold® and pinch pleated draperies.

## Ceiling Installations

Install directly through pre-drilled holes (16" intervals) in track and end pulleys. Use fasteners which yield direct withdrawal strength of 25 lbs.

## Wall Installations

Two brackets at each end of track 24" apart, 48" apart over remainder of track.

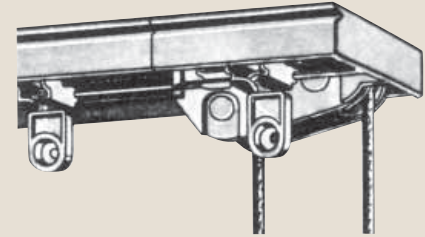

## Component Parts

### Pulleys

#### One-way draw

No. 93103

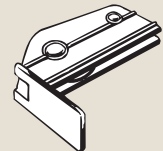

#### Two-way draw

1/2" dia.; max load 32 lbs.

No. 93101

Left hand

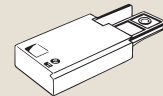

No. 93102

Right hand

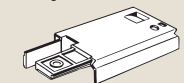

#### Heavy Duty

3/4" dia. with Teflon bearings;  
Max load 64 lbs.

No. 93091

Left hand

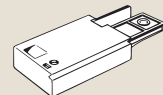

No. 93092

Right hand

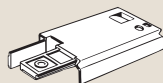

### Carriers



Nos. 93140-93143

Space slide shoes for Ripplefold systems

No. 93123

Slide shoe



No. 93121

Snap carrier



## Component Parts

### Brackets

No. 93138  
End bracket

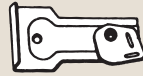

No. 93139  
Wall bracket  
2" - 3" clear

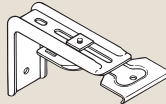

### Overlap Master Carriers Nos. 93107 and 93106

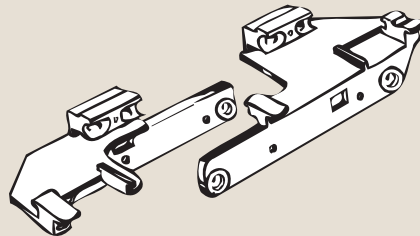

93107  
Left hand

93106  
Right hand

### Butt Master Carriers Nos. 93105 and 93104

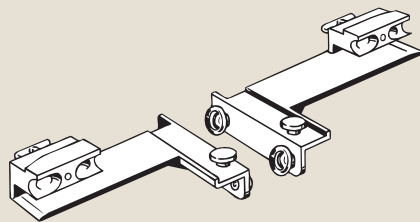

93105  
Left hand

93104  
Right hand

## Assembled Sets

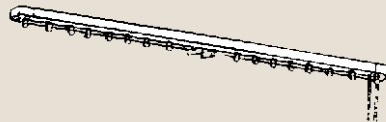
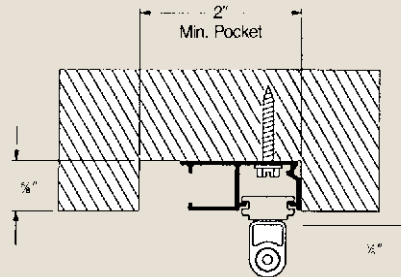

Set includes assembled rod, standard wall or ceiling brackets and 9923 cord tension pulley. Longer brackets must be ordered separately. Rod may be angular bent or circular curved.

**Fabrication and Planning Guides:**  
Ripplefold®: Refer to F4730002

### Track with heavy duty pulleys

No. 93150H  
Finish (25) White, Baked Enamel

### Track with standard pulleys

No. 93150  
Finish (25) White, Baked Enamel

## Suggested Specifications

- Furnish and install, as indicated on plans, Kirsch Track No. 93001, extruded of .050" 6063T5 aluminum alloy in accordance with Aluminum Association Specification No. AA-C22A21. Finish to be (25) white, baked enamel
- Specify Mount
  - A. Surface direct or No. 93138 ceiling brackets
  - B. Wall — No. 93139 brackets
- Specify Drapery System and Fullness
  - A. Conventional pleated
  - B. Ripplefold® 120%, 100%, 80%, 60%
- Specify Master Slides
  - A. Butt Masters: Nos. 93104 and 93105
  - B. Overlap Masters: Nos. 93106 and 93107
- End Pulley Options
  - A. Regular: No. 93102
  - B. Heavy Duty: Nos. 93091 and 93092
- Cord to be No. 9934 polyester
- Cord Guide to be Nos. 9945 or 9923 tension pulley

## Maximum capacity specifications for H.D. Architrac (series 93001)

Maximum widths are determined in part by available track lengths. **Splicing is not recommended.** Maximum loads apply when using Kirsch Ripplefold® drapery systems.

No. 93001, when installed with medium weight fabric on standard size windows (i.e., 16' wide by 8' high) will operate with a 2-3 lb. pull requirement. When installed with a maximum load, it will operate with a 5-6 lb. pull requirement.

*NOTE: All components have been tested under conditions simulating ten years' usage. Snaps will detach with a 4 lb. "peel" action and release with a sheer pull of 22 lbs.*

### Maximum loads

Type of fabric based on 48" goods – 5 oz. per linear yard. Unlined sheer or lightweight fabrics. Size of draperies to equal 32 lbs. based on 100% fullness 16' wide x 32' long – 32' wide x 16' long

Type of fabric based on 48" goods – 10 oz. per linear yard. Lined sheers or lightweight fabrics. Size of draperies to equal 32 lbs. based on 100% fullness 16' wide x 16' long – 32' wide x 8' long.

Type of fabric based on 48" goods – 20 oz. per linear yard. Lined medium weight fabrics or heavy cotton, velours and linens. Size of draperies to equal 32 lbs. based on 100% fullness 16' wide x 8' long

# Double Duty Rodding Series 9095 Track

- 22 gauge steel (.030"), white baked enamel finish.
- Extra strong and rugged deluxe traverse line.
- Push-in style brackets for fast mounting.
- Flange construction provides extra strength; makes surface mounting easy.
- Cords are completely concealed in track.

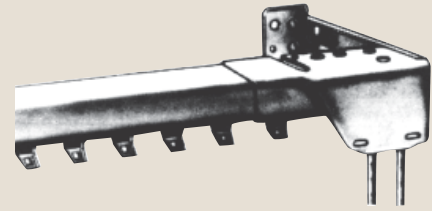

## Description

- For wall or ceiling mounting. Use with conventional draperies only.
- Single channel, cord operation.
- Can be curved to 8" radius.
- Ball bearing pulleys.
- Self-lubricating slides.
- Concealed cord, can't sag.

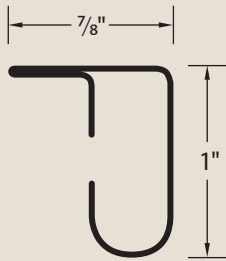

Actual size — end view

## Application

Surface or recess mounting. Holes pre-drilled in integral mounting flange on 16" centers for direct mount with Hex or Pan Head screws.

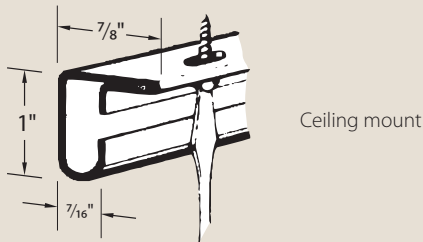

Ceiling mount

Track is perforated through flange; 16" on center. No brackets or supports needed. Use the same components for wall or ceiling mounts. Use choice of bracket/support projections.

## Component Parts

### Master Carriers



No. 9497

One-piece construction permits free overlap of draperies when closed.

### Slide Carriers

No. 3909

Molded of special formula, self-lubricating.



### Pulleys

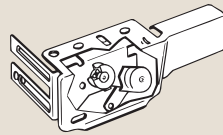

No. 9287N

Ball Bearing pulley set  
Easy operation at unusually wide or high spans or with heavy panels.

### Supports & Brackets

No. 9592

Intermediate Support

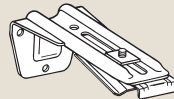

No. 3311-3312

Push-in End Brackets

1"- 2" clearance: No. 3311

2"- 3" clearance: No. 3312

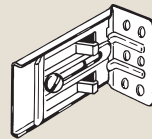

### Cord

No. 9934

Braided cord



## Suggested Specifications

- Furnish and install, as indicated on plans, Kirsch track No. 9095, formed of .030" 22 gauge steel with baked enamel finish inside and out. To be used with Kirsch components.
- End pulley Sets to be push-in style with ball bearings, No. 9287.
- End brackets to be push-in style. All supports to be fastened with appropriate fastening devices to provide 25 lbs. withdrawal strength per device.
- Cord to be polyester, No. 9934, and rigged for tension pulley.

# Superfine® Contract Rods

- White Baked enamel finish.
- All sliding edges have lubricated coating.
- Extra strength master slides.
- Teflon end pulleys for quiet, longer life.
- Universal cam lock supports for easy installation, secure hold.
- Kirsch Contract Rods are economically bulk packed for commercial installation.

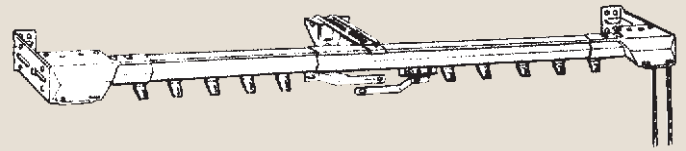

## Description

- Adjustable
- For wall or ceiling mounting
- White finish, conventional adjustable traverse rod.
- Roll formed of heavy gauge steel.
- Choice of drop-in or push-in mounting brackets.
- Kirsch Contract Rods are economically bulk packed for commercial installation.

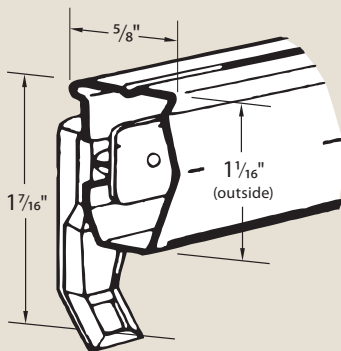

## Component Parts

### Supports & Brackets

No. 3576  
Universal cam support

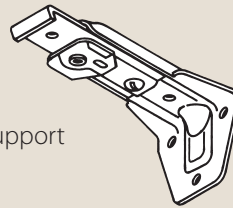

No. 3558  
Universal cam support



No. 3311  
Push-in bracket

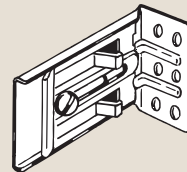

No. 3301  
Drop-in bracket

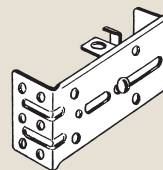

## Suggested Specifications

- Heavy duty, adjustable traverse rods to be Kirsch No. 3083R Series. Rod sections to be 24 gauge (.021") steel, white baked enamel finish.
- Tolerances between rod sections are not to exceed plus minus .010", assuring trouble free, telescoping joints.
- Rods to have 3/4" diameter pulleys and self-lubricating slides. Cords to be No. 4 (4/32" diameter) braided polyester.
- Brackets, supports and cord tension pulleys are to be ordered separately.
- Choice of drop-in or push-in mounting brackets. Specify size:
  - 30" - 48"
  - 38" - 66"
  - 48" - 86"
  - 66" - 120"
  - 86" - 156"
  - 120" - 224"
  - 100" - 180"
  - 160" - 300"

# Baton or Hand Draw

## Description

- Extruded .050" high strength, 6063T5 aluminum alloy single channel tracks etched and anodized in natural finish in accordance with Aluminum Association Specification No. AA-C22A21.
- For cordless traverse operation.
- All sliding edges lubricated with Kirlon® except 94008.

## No. 94003

### Application

- Hand draw.
- Wall or Ceiling mount.
- White baked enamel finish.
- Can be bent to any angle using 12" radius; larger semi-circular radius curved at factory.



## No. 94004

### Application

- Hand draw.
- Ceiling mount.
- White baked enamel finish.
- Rear flange perforated on 16" centers for direct ceiling mount; no need to screw through channel.
- Track cannot be curved.

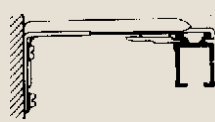

Wall mount

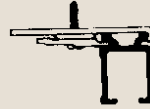

Ceiling mount

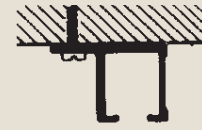

Ceiling mount

### Suggested Specifications

- **Track**
  - Furnish and install, as indicated on plans, Kirsch track NO. 94003, extruded of .050" 6063T5 Aluminum alloy etched and anodized.
- **Specify Finish:**
  - (25) White
- **Ball Bearing / Wheeled Slides:**
  - Use No. 9603 End Cap and No. 94113-94114 Master Carrier
  - No. 9670 Ball Bearing style
  - No. 9687 Ball Bearing style
  - No. 9673 Ball Bearing style
  - No. 9678R Wheeled style
- **Button Slides:**
  - Use with No. 9684 End Stop and No. 9644 Master Carrier with Button Style Slides
  - No. 9406 Button Style
  - No. 9685 Button Style
  - No. 9686 Button Style
- **Specify Mounting Bracket:**
  - Wall Mount: No. 94132V (2" - 3" Clearance)
  - Ceiling Mount: No. 94140. One Bracket to be mounted at each end of track. (One 24" from each drapery stacking end and one at 48" intervals over remainder of track).

### Suggested Specifications

- **Track**
  - Furnish and install, as indicated on plans, track No. 94004, extruded of .050" 6063T5 Aluminum. Track to be fastened securely at 16" intervals through pre-drilled holes.
- **Specify Finish:**
  - (25) White
- **Ball Bearing / Wheeled Slides:**
  - Use No. 94113 or 94114 Master Carrier
  - No. 9670 Ball Bearing style
  - No. 9687 Ball Bearing style
  - No. 9673 Ball Bearing style
  - No. 9678R Wheeled style
- **Button Slides:**
  - Use No. 9644 Master Carrier and No. 9684 End Stop
  - No. 9406 Button Style
  - No. 9685 Button Style
  - No. 9686 Button Style
- **Specify End Cap:**
  - No. 94142

## No. 94005

### Application

- Hand draw.
- Ceiling mount.
- White baked enamel finish.
- Can be bent to any angle using 12" radius; semi-circular curves of 48" radius (min.) can be curved at factory.

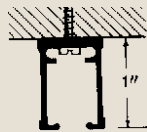

Ceiling mount

### Suggested Specifications

- **Track**
  - Furnish and install, as indicated on plans, track No. 94005, extruded of .050" 6063T5 Aluminum. Track to be fastened securely at 16" intervals through pre-drilled holes.
- **Ball Bearing / Wheeled Slides:**  
*Use No. 94113 or 94114 Master Carrier and No. 9670 Ball Bearing style*
  - No. 9670 Ball Bearing style
  - No. 9687 Ball Bearing Style
  - No. 9673 Ball Bearing style
  - No. 9678R Wheeled style
- **Button Slides:**  
*Use No. 9644 Master Carrier and No. 9684 End Stop*
  - No. 9406 Button Style
  - No. 9685 Button Style
  - No. 9686 Button Style.
- **Specify End Cap:**
  - No. 94141

## No. 9046

### Application

- Hand draw
- Ceiling mount.
- White baked enamel finish.
- Track perforated on 16" centers.
- Can be bent to any angle using 8" or 12" radius; semi-circular curves of 48" radius (min.) can be curved at factory.



Ceiling mount

### Suggested Specifications

- **Track:**
  - Furnish and install, as indicated on plans, Kirsch track No. 94008, rolled of 22 gauge (.030") Galvanized Steel, White Baked Enamel Finish.
- **Ball Bearing / Wheeled Slides:**  
*Use No. 94113 or 94114 Master Carrier and No. 9603 End Cap*
  - No. 9670 Ball Bearing style
  - No. 9687 Ball Bearing Style
  - No. 9673 Ball Bearing style
  - No. 9678R Wheeled style
- **Button Slides:**  
*Use No. 9644 Master Carrier and No. 9684 End Stop*
  - No. 9406 Button Style
  - No. 9685 Button Style
  - No. 9686 Button Style
- **Specify Mounting Brackets:**
  - Wall Mount: No. 94132V (2" - 3" Clearance)
  - Ceiling Mount: No. 94140. One Bracket to be mounted at each end of track. (One 24" from each drapery stacking end and one at 48" intervals over remainder of track).
  - *NOTE: Fastening devices should have a minimum 25lb. direct withdrawal strength. Screws used through channel openings should be a Phillips or #6 posidrive head.*

## No. 94008

### Application

- Hand draw.
- Wall or ceiling mount.
- White baked enamel finish.
- Cannot be bent.

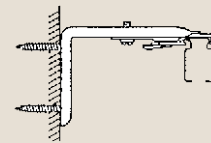

Wall mount

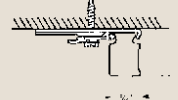

Ceiling mount

### Suggested Specifications

- **Track:**
  - Furnish and install, as indicated on plans, Kirsch track No. 9046, extruded of .070" 6063T5 Aluminum alloy etched and anodized.
- **Finish:**
  - (25) White
- **Specify Slide Carrier:**
  - No. 9406 Button Style
  - No. 9685 Button Style
  - No. 9686 Button Style.
- **Specify Master Carrier:**
  - No. 9644
  - No. 94158 & 94159
- **Specify End Cap:**
  - No. 9684
  - No. 9682

# Baton or Hand Draw Components

## Track Splices

No. 94110

Use with Track No. 94003

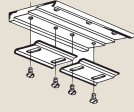

## Overlap Master Carriers

Drapery panels  
overlap at center

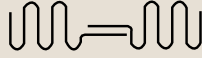

Nos. 94174 and 94173

Over the top master carrier.

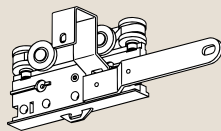
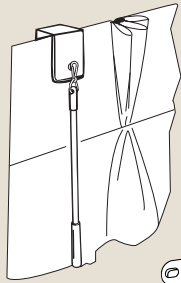

94174 — Left hand

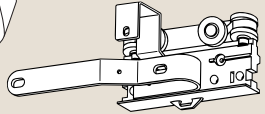

94173 — Right hand

Nos. 94114 and 94113

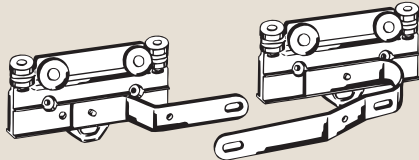

94114  
Left hand

94113  
Right hand

No. 9644

May be used with batons.

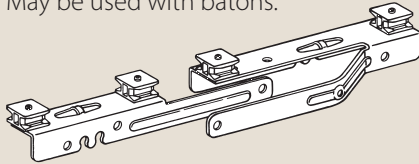

Nos. 94159 and 94158

For batons, Ripplefold® and  
conventional pleat draperies  
(panels must hang below track).

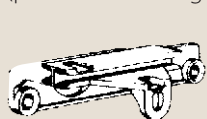

94159  
Left hand



94158  
Right hand

## Butt Master Carriers

Drapery panels  
butt together at center.  
No flat areas or overlap shadow.



Nos. 94136 and 94135

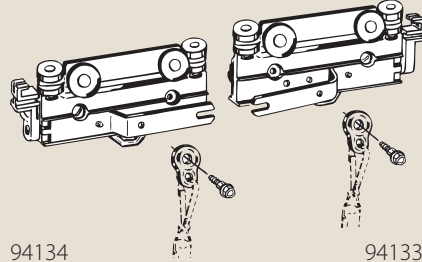

94134  
Left hand

94133  
Right hand

Nos. 94134 and 94133

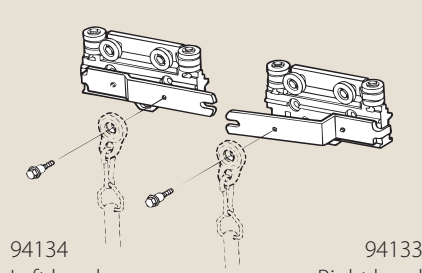

94134  
Left hand

94133  
Right hand

## Slide Carriers

No. 9670  
Slide Carrier  
Must use No. 9683 end stops  
and No. 9644 masters



No. 9406  
Button Carrier  
Lubri-side molded Celcon;  
glides smoothly in track



No. 9685  
Button Carrier (No. 9406)  
with attached hook



No. 9687  
Ball Bearing Carrier  
with hook, without chain.  
Has eyelets for  
No. 9688 chain.

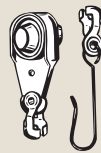

No. 9686

Slide Carrier with hook,  
without bead chain.  
Standard drop 3½" (other  
drops available at extra cost).



No. 9673

Ball Bearing Carrier  
with attached hook



No. 9678R

Wheeled Carrier



## End Stops

No. 9684

End Stop with pin-hole return



No. 9683



## End Caps

No. 9682

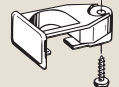

No. 94141

Use with Track No.  
94003, 94005

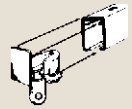

No. 94142

Use with Track No.  
94003, 94005

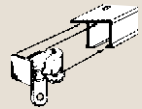

## Batons with Harness Snaps

For use with cordless hand draw.  
White finish.

3/8" Fiberglass	1/4" Steel	Length
No. 91232	91332R	2½'
No. 91233	91333R	3'
No. 91234	91334R	4'
No. 91235		5'
No. 91236		6'

Baton Draw Multi-Wheel Masters for 94133 and 94134 Pinch Pleat for extra overlap; 94135 and 94136 for Ripplefold®. Requires use of 94145 or 94146 stiffeners (see page 5).



# Cubicle Track System

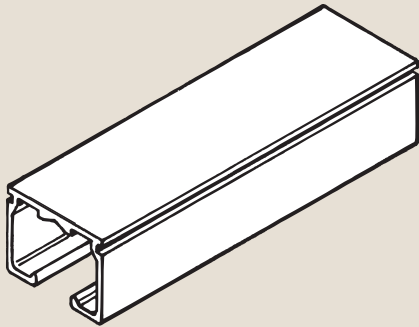

## No. 9600

### Application

- Excellent choice for privacy curtains in hospitals and extended care facilities.

### Description

- Track is  $29/32$ " x  $11/16$ " x .050 extruded 6063T5 anodized aluminum.
- Inner surface is center ridge-grooved for easy installation.
- If specified, tracks will be bent or circular curved from one continuous length up to 20'. Bends will be approx. 14" radius.
- Maximum weight per foot: 2.4 pounds.

### No. 9601/090

33" track with 90° bend.

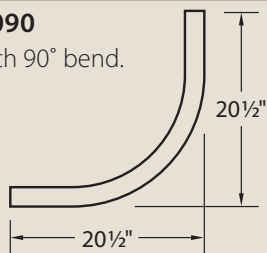

### No. 9605/090

Track with 90° bend, 9616 carriers, 9610 end stops and 9611 pull-out.

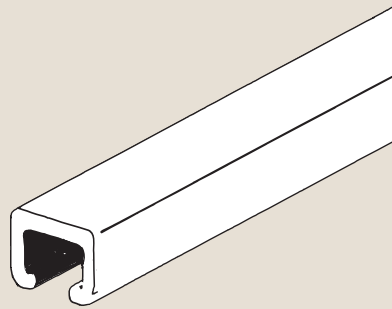
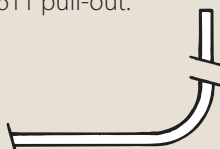

## No. 9046

### Application

- Good quality track for use with cubicle or pinch-pleated curtains.

### Description

- Track is  $5/8$ " x  $1/2$ " x .070 extruded 6063T5 anodized aluminum.
- Lubricated with Kirlon for friction-free operation.
- If specified, tracks will be bent or circular curved from one continuous length up to 16'. Bends will be approx. 8" or 12" radius.

## Popular Configurations for Intravenous or Cubicle Installations

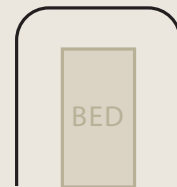
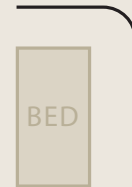

# Components for Cubicle Track System

## No. 9046

### Overlap Master Carriers

Drapery panels overlap at center

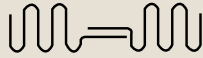

### No. 9644/061

Master slide for pinch-pleated panels; permits draperies to overlap for privacy.

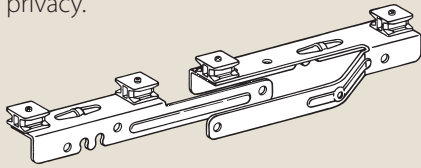

### Slide Carriers

#### No. 9406/061

Button Carrier  
Lubri-side molded Celcon;  
glides smoothly in track



#### No. 9685/061

Button Carrier (No. 9406)  
with attached zinc-plated  
.080 wire hook designed for  
grommeted panels



#### No. 9686/061

Slide Carrier with hook,  
without bead chain.  
Standard drop 3½" (other  
drops available at extra cost).



### End Caps

#### No. 9682

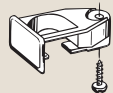

### End Stops

#### No. 9684



## No. 9600

### Carriers

#### No. 9633

Carrier body and wheels  
made of Celcon



#### No. 9616/061

Carrier (No. 9633) with  
attached hook. Eye and  
hook of .093 bright basic  
wire, nickel plated.

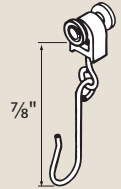

### Track Splices

#### No. 9612

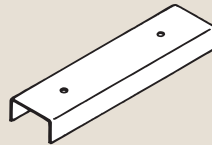

### End Stops

#### No. 9610

End Stop

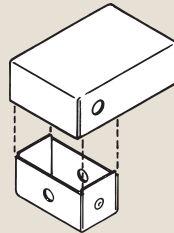

#### No. 9611

Pull-out

### End Caps

#### No. 9613

End Cap



### Supports & Brackets

#### No. 9637

Support

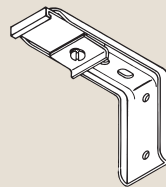

#### No. 9639

Bracket

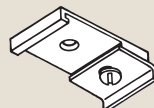

## No. 9600

#### No. 9623

Ceiling Flange



#### No. 9624

Track Socket

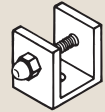

#### No. 9620/12

Suspension Tubing  
¾" x ¾"



#### No. 9689

16" PVC Hanger



#### No. 9690

16" Hook Chain



#### No. 9693

End Ring for shortening  
hook chain



# Installation Aids

## Suspended Ceiling Clips

**No. 9520**

Can be used for mounting Architrac rod sets on suspended type ceilings where conventional surface mounting with screws and/or mounting devices is not possible.

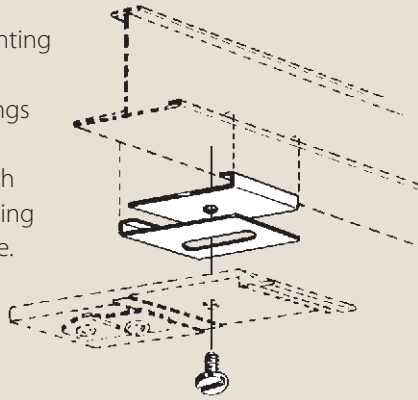

## Channel Protector

**No. 9955**

Plastic channel protector should be used as shown. Place inside the track during ceiling or recess mounting of surface track to prevent damage to sliding surface.

*Use with 94005, 94008 and 9046 tracks.*

*Do not use Hex head screws.  
Must use low profile heads.*

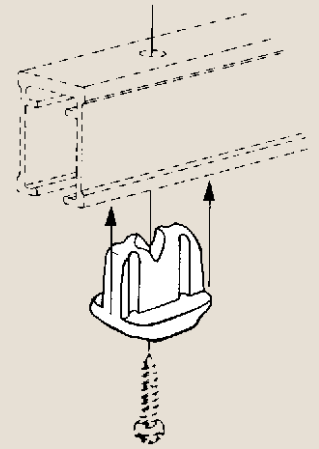



[www.kirsch.com](http://www.kirsch.com)

To place orders, verify status  
or obtain the latest product information,  
Call toll-free 1-800-817-6344  
or Fax toll-free: 1-800-308-4293

For express service, have your customer  
code readily available.

Kirsch Window Fashions ©2008  
4110 Premier Drive, High Point, NC 27265  
Phone: 1-800-817-6344 • Fax: 1-800-308-4293  
[www.kirsch.com](http://www.kirsch.com)

A **Newell Rubbermaid** Company

F0291008  
Updated 9/08