

# Series 1 Steel - Straight Sections

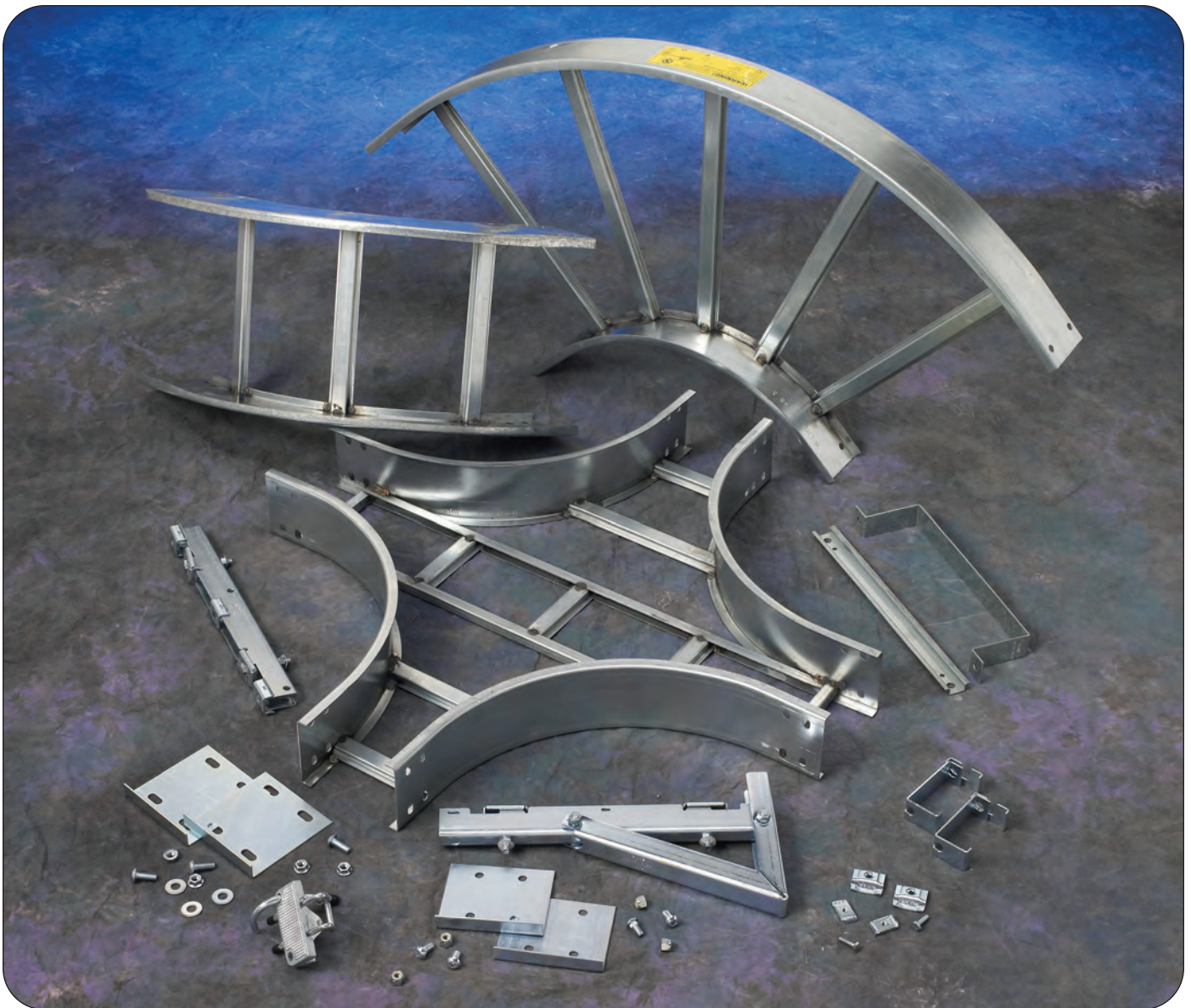

Series 1 Steel



## How The Service Advisor Works

We know that your time is important! That's why the color-coding system in this catalog is designed to help you select products that fit your service needs. Products are marked to indicate the typical lead time for orders of 50 pieces or less.

**Customer:** How do I select my straight sections, covers, or fittings so that I get the quickest turnaround?

**Service Advisor:** Each part of our selection chart is shown in colors. If any section of a part number is a different color, the part will typically ship with the longer lead time represented by the colors.

- Green = Fastest shipped items
- Black = Normal lead-time items
- Red = Normally long lead-time items

**Example:**            156G   09   -   24   -   144  
                              ●       ●       ●       ●

**Part will have a long lead time because of the 156G material.**

Changing the part number from 156G to 156P will change the coding to black for all sections and reduce lead time.

## 3" NEMA VE 1 Loading Depth Actual Loading Depth = 3.077"

### Straight Section Part Numbering

Example: **148 P 09 - 24 - 144**

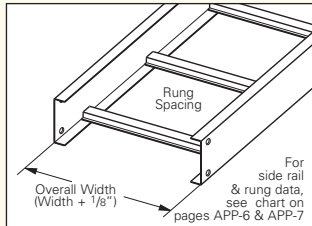
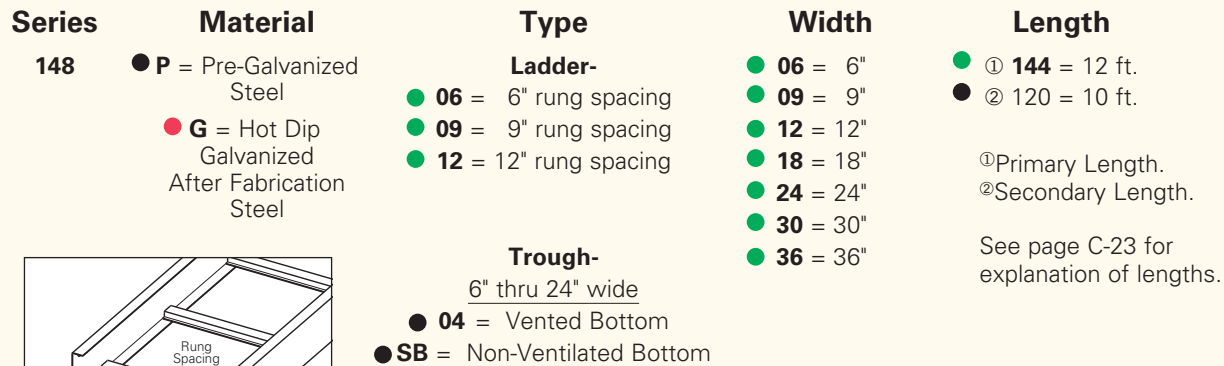

See page APP-1 for additional rung options. \*SB available for all widths.

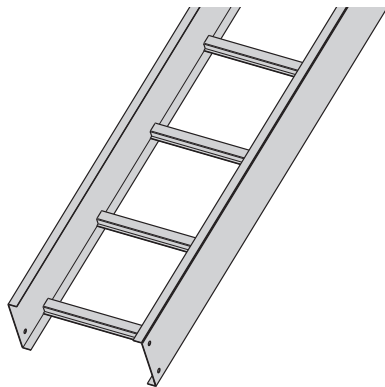

Ladder Type  
(Specify Rung Spacing)

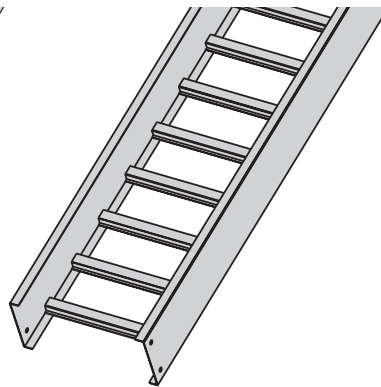

Ventilated Bottom

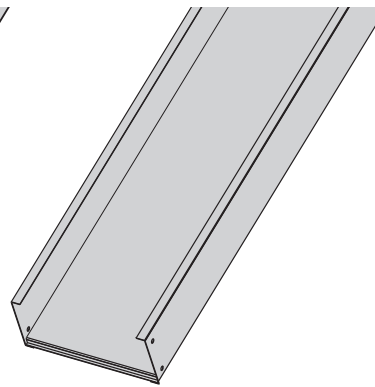

Non-Ventilated

Values are based on simple beam tests per NEMA VE 1 on 36" wide cable tray with rungs spaced on 12" centers. The published load safety factor is 1.5. To convert 1.5 safety factor to 2.0, multiply the published load by 0.75. To obtain mid-span deflection, multiply a load by the deflection multiplier. Cable tray must be supported on spans shorter than or equal to the length of the cable tray being installed.

B-Line Series Slide Rail Dimensions	NEMA, CSA & UL Classifications	Span ft	Load lbs/ft	Deflection Multiplier	Design Factors for Two Rails	Span meters	Load kg/m	Deflection Multiplier	Design Factors for Two Rails
	NEMA: 12A, 8C	6	204*	0.0011	Area = 0.510 in <sup>2</sup>	1.8	304*	0.019	Area = 3.290 cm <sup>2</sup>
	CSA: C1-3m	8	115	0.0036	Sx = 0.480 in <sup>3</sup>	2.4	171	0.061	Sx = 7.870 cm <sup>3</sup>
	UL Cross-Sectional	10	73	0.0087	Ix = 0.890 in <sup>4</sup>	3.0	109	0.149	Ix = 37.04 cm <sup>4</sup>
	Area: 0.40 in <sup>2</sup>	12	51	0.0181		3.7	76	0.309	

\*When using 12" rung spacing load capacity is limited to 195 lbs/ft (290.16 kg/m) for 36" tray width. When cable trays are used in continuous spans, the deflection of the cable tray is reduced by as much as 50%.

Design factors: Ix = Moment of Inertia, Sx = Section Modulus.

● Green = Fastest shipped items   ● Black = Normal lead-time items   ● Red = Normally long lead-time items

## 4" NEMA VE 1 Loading Depth Actual Loading Depth = 3.628"

### Straight Section Part Numbering

Prefix  
Example: **156 P 09 - 24 - 144**

<b>Series</b>	<b>Material</b>	<b>Type</b>	<b>Width</b>	<b>Length</b>
<b>156</b>	<ul style="list-style-type: none"> <li>● <b>P</b> = Pre-Galvanized Steel</li> <li>● <b>G</b> = Hot Dip Galvanized After Fabrication Steel</li> </ul>	<b>Ladder-</b> <ul style="list-style-type: none"> <li>● <b>06</b> = 6" rung spacing</li> <li>● <b>09</b> = 9" rung spacing</li> <li>● <b>12</b> = 12" rung spacing</li> </ul> <b>Trough-</b> 6" thru 24" wide <ul style="list-style-type: none"> <li>● <b>04</b> = Vented Bottom</li> <li>● <b>SB</b> = Non-Ventilated Bottom</li> </ul>	<ul style="list-style-type: none"> <li>● <b>06</b> = 6"</li> <li>● <b>09</b> = 9"</li> <li>● <b>12</b> = 12"</li> <li>● <b>18</b> = 18"</li> <li>● <b>24</b> = 24"</li> <li>● <b>30</b> = 30"</li> <li>● <b>36</b> = 36"</li> </ul>	<ul style="list-style-type: none"> <li>● ① <b>144</b> = 12 ft.</li> <li>● ② 120 = 10 ft.</li> </ul> <p>①Primary Length. ②Secondary Length.</p> <p>See page C-23 for explanation of lengths.</p>

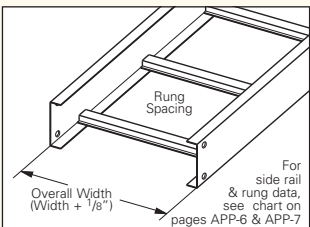

For side rail & rung data, see chart on pages APP-6 & APP-7

See page APP-1 for additional rung options. \*SB available for all widths.

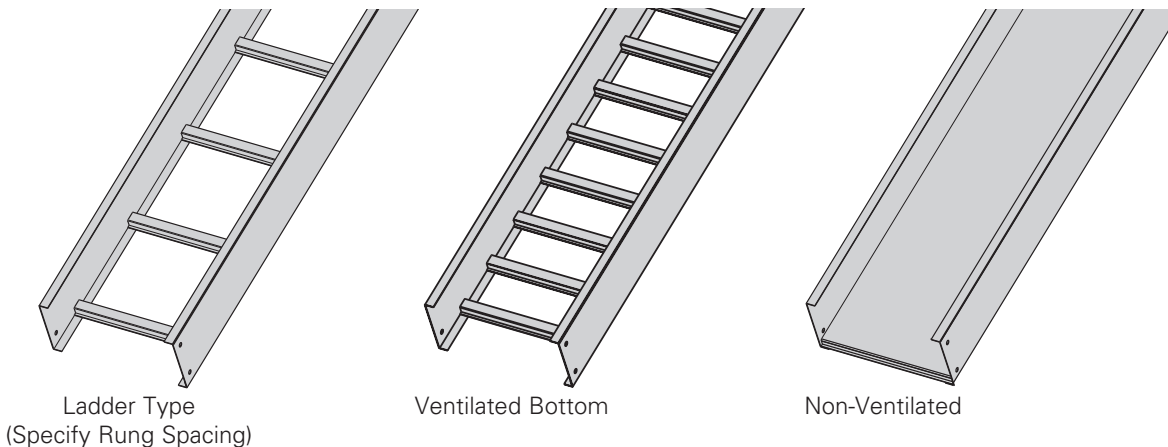

Values are based on simple beam tests per NEMA VE 1 on 36" wide cable tray with rungs spaced on 12" centers. Cable trays will support without collapse a 200 lb. (90.7 kg) concentrated load over and above the published loads. The published load safety factor is 1.5. To convert 1.5 safety factor to 2.0, multiply the published load by 0.75. To obtain mid-span deflection, multiply a load by the deflection multiplier. Cable tray must be supported on spans shorter than or equal to the length of the cable tray being installed.

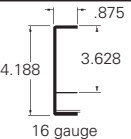
B-Line Series Slide Rail Dimensions	NEMA, CSA & UL Classifications	Span ft	Load lbs/ft	Deflection Multiplier	Design Factors for Two Rails	Span meters	Load kg/m	Deflection Multiplier	Design Factors for Two Rails
<b>156</b> 	NEMA: 12B, 8C CSA: C1-3m UL Cross-Sectional Area: 0.40 in <sup>2</sup>	6	304*	0.0007	Area = 0.690 in <sup>2</sup> Sx = 0.724 in <sup>3</sup> Ix = 1.517 in <sup>4</sup>	1.8	452*	0.011	Area = 4.390 cm <sup>2</sup> Sx = 11.860 cm <sup>3</sup> Ix = 63.140 cm <sup>4</sup>
		8	171	0.0021		2.4	254	0.036	
		10	109	0.0051		3.0	163	0.087	
		12	76	0.0011		3.7	113	0.181	

\*When using 12" rung spacing, load capacity is limited to 234 lbs/ft (348.192 kg/m) for 30" tray width and 195 lbs/ft (290.16 kg/m) for 36" tray width. When trays are used in continuous spans, the deflection of the tray is reduced by as much as 50%. Design factors: Ix = Moment of Inertia, Sx = Section Modulus.

● Green = Fastest shipped items    ● Black = Normal lead-time items    ● Red = Normally long lead-time items

All dimensions in parentheses are millimeters unless otherwise specified.

# Series 1 Steel - Straight Sections

## 5" NEMA VE 1 Loading Depth Actual Loading Depth = 4.628"

### Straight Section Part Numbering

Example: **166 P 09 - 24 - 144**

<p><b>Series</b> <b>166</b></p>	<p><b>Material</b></p> <ul style="list-style-type: none"> <li>● <b>P</b> = Pre-Galvanized Steel</li> <li>● <b>G</b> = Hot Dip Galvanized After Fabrication Steel</li> </ul>	<p><b>Type</b></p> <p><b>Ladder-</b></p> <ul style="list-style-type: none"> <li>● <b>06</b> = 6" rung spacing</li> <li>● <b>09</b> = 9" rung spacing</li> <li>● <b>12</b> = 12" rung spacing</li> </ul> <p><b>Trough-</b> 6" thru 24" wide</p> <ul style="list-style-type: none"> <li>● <b>04</b> = Vented Bottom</li> <li>● <b>SB</b> = Non-Ventilated Bottom</li> </ul>	<p><b>Width</b></p> <ul style="list-style-type: none"> <li>● <b>06</b> = 6"</li> <li>● <b>09</b> = 9"</li> <li>● <b>12</b> = 12"</li> <li>● <b>18</b> = 18"</li> <li>● <b>24</b> = 24"</li> <li>● <b>30</b> = 30"</li> <li>● <b>36</b> = 36"</li> </ul>	<p><b>Length</b></p> <ul style="list-style-type: none"> <li>● ① <b>144</b> = 12 ft.</li> <li>● ② <b>120</b> = 10 ft.</li> </ul> <p>① Primary Length. ② Secondary Length.</p> <p>See page C-23 for explanation of lengths.</p>
-------------------------------------	---	---	---	---

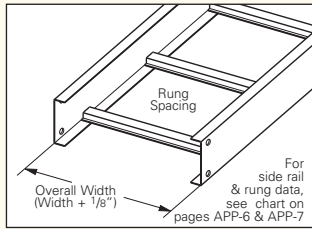

See page APP-1 for additional rung options. \*SB available for all widths.

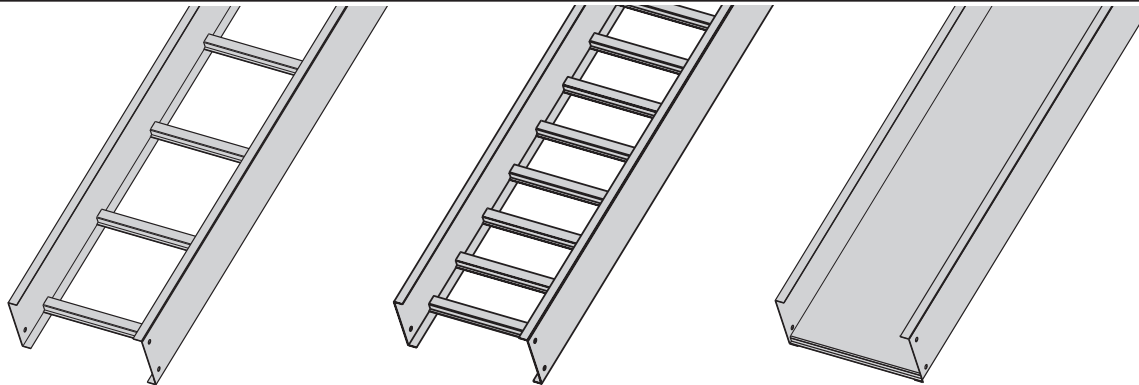

Values are based on simple beam tests per NEMA VE 1 on 36" wide cable tray with rungs spaced on 12" centers. Cable trays will support without collapse a 200 lb. (90.7 kg) concentrated load over and above published loads. The published load safety factor is 1.5. To convert 1.5 safety factor to 2.0, multiply the published load by 0.75. To obtain mid-span deflection, multiply a load by the deflection multiplier. Cable tray must be supported on spans shorter than or equal to the length of the cable tray being installed.

B-Line Series Side Rail Dimensions	NEMA, CSA & UL Classifications	Span ft	Load lbs/ft	Deflection Multiplier	Design Factors for Two Rails	Span meters	Load kg/m	Deflection Multiplier	Design Factors for Two Rails
	NEMA: 12B, 8C CSA: C1-3m UL Cross-Sectional Area: 0.70 in <sup>2</sup>	6	308*	0.0004	Area = 0.770 in <sup>2</sup> Sx = 0.930 in <sup>3</sup> Ix = 2.400 in <sup>4</sup>	1.8	458*	0.007	Area = 4.970 cm <sup>2</sup> Sx = 15.240 cm <sup>3</sup> Ix = 99.900 cm <sup>4</sup>
		8	173	0.0013		2.4	258	0.023	
		10	111	0.0032		3.0	165	0.055	
		12	77	0.0067		3.7	115	0.114	

\*When using 12" rung spacing, the load capacity is limited to 234 lbs/ft (348.192 kg/m) for 30" tray width and 195 lbs/ft (290.16 kg/m) for 36" tray width. When trays are used in continuous spans, the deflection of the tray is reduced by as much as 50%. Design factors: Ix = Moment of Inertia, Sx = Section Modulus.

● Green = Fastest shipped items    ● Black = Normal lead-time items    ● Red = Normally long lead-time items

All dimensions in parentheses are millimeters unless otherwise specified.

## 6" NEMA VE 1 Loading Depth Actual Loading Depth = 5.628"

### Straight Section Part Numbering

Prefix  
Example: **176 P 09 - 24 - 144**

<b>Series</b>	<b>Material</b>	<b>Type</b>	<b>Width</b>	<b>Length</b>
<b>176</b>	<ul style="list-style-type: none"> <li>● <b>P</b> = Pre-Galvanized Steel</li> <li>● <b>G</b> = Hot Dip Galvanized After Fabrication Steel</li> </ul>	<b>Ladder-</b> <ul style="list-style-type: none"> <li>● <b>06</b> = 6" rung spacing</li> <li>● <b>09</b> = 9" rung spacing</li> <li>● <b>12</b> = 12" rung spacing</li> </ul> <b>Trough-</b> 6" thru 24" wide <ul style="list-style-type: none"> <li>● <b>04</b> = Vented Bottom</li> <li>● <b>SB</b> = Non-Ventilated Bottom</li> </ul>	<ul style="list-style-type: none"> <li>● <b>06</b> = 6"</li> <li>● <b>09</b> = 9"</li> <li>● <b>12</b> = 12"</li> <li>● <b>18</b> = 18"</li> <li>● <b>24</b> = 24"</li> <li>● <b>30</b> = 30"</li> <li>● <b>36</b> = 36"</li> </ul>	<ul style="list-style-type: none"> <li>● ① <b>144</b> = 12 ft.</li> <li>● ② <b>120</b> = 10 ft.</li> </ul> <p>① Primary Length. ② Secondary Length.</p> <p>See page C-23 for explanation of lengths.</p>

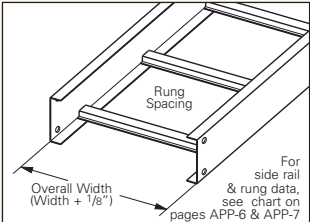

See page APP-1 for additional rung options. \*SB available for all widths.

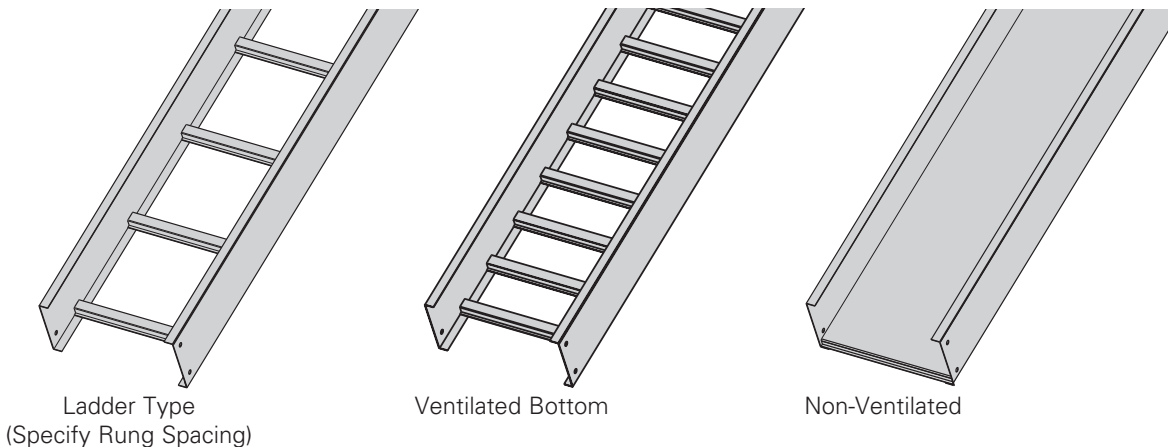

Values are based on simple beam tests per NEMA VE 1 on 36" wide cable tray with rungs spaced on 12" centers. Cable trays will support without collapse a 200 lb. (90.7 kg) concentrated load over and above published loads. The published load safety factor is 1.5. To convert 1.5 safety factor to 2.0, multiply published load by 0.75. To obtain mid-span deflection, multiply a load by the deflection multiplier. Cable tray must be supported on spans shorter than or equal to the length of the cable tray being installed.

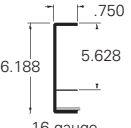
B-Line Series Side Rail Dimensions	NEMA, CSA & UL Classifications	Span ft	Load lbs/ft	Deflection Multiplier	Design Factors for Two Rails	Span meters	Load kg/m	Deflection Multiplier	Design Factors for Two Rails
<b>176</b> 	NEMA: <b>12B, 8C</b> CSA: 137 kg/m 3.7m UL Cross-Sectional Area: 0.70 in <sup>2</sup>	8	194	0.0008	Area = 0.890 in <sup>2</sup>	2.4	458*	0.014	Area = 5.740 cm <sup>2</sup>
		10	124	0.0020	Sx = 1.230 in <sup>3</sup>	3.0	258	0.035	Sx = 20.160 cm <sup>3</sup>
		12	86	0.0042	Ix = 3.800 in <sup>4</sup>	3.7	165	0.072	Ix = 158.200 cm <sup>4</sup>

When cable trays are used in continuous spans, the deflection of the tray is reduced by as much as 50%.  
Design factors: Ix = Moment of Inertia, Sx = Section Modulus.

● Green = Fastest shipped items    ● Black = Normal lead-time items    ● Red = Normally long lead-time items

All dimensions in parentheses are millimeters unless otherwise specified.

# Series 1 Steel - Accessories

## Standard (L-Shaped) Splice Plates

- One pair including hardware provided with each section. (Expansion splice quantity subtracted)
- Furnished in pairs with hardware.
- Prepackaged in pairs in a plastic bag, with hardware.
- 4-hole pattern L-shaped splice plates.
- L-shaped lay-in design.
- (\*) Insert **ZN** or **G**

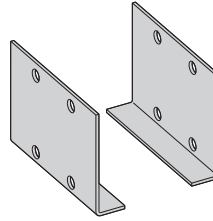

Tray Series	Catalog No.
148	<b>9(*)-4004</b>
156	<b>9(*)-4005</b>
166	<b>9(*)-4006</b>
176	<b>9(*)-4007</b>

## Expansion (L-Shaped) Splice Plates

- Expansion plates allow for one inch expansion or contraction of the cable tray, or where expansion joints occur in the supporting structure.
- Bonding Jumpers are required on each side rail. Order Separately.
- L-shaped lay-in design.
- Furnished in pairs with hardware.
- (\*) Insert **ZN** or **G**

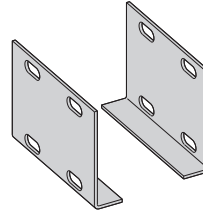

Tray Series	Catalog No.
148	<b>9(*)-4014</b>
156	<b>9(*)-4015</b>
166	<b>9(*)-4016</b>
176	<b>9(*)-4017</b>

## Universal Splice Plates

- Used to splice to existing cable tray systems.
- Furnished in pairs with hardware.
- (\*) Insert **P** or **G**

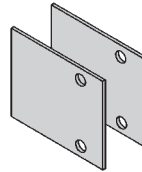

Tray Series	Catalog No.
148	<b>9(*)-2004-1/2</b>
156	<b>9(*)-2005-1/2</b>
166	<b>9(*)-2006-1/2</b>
176	<b>9(*)-2007-1/2</b>

## Step Down Splice Plates

- These splice plates are offered for connecting cable tray sections having side rails of different heights.
- Furnished in pairs with hardware.
- (\*) Insert **ZN** or **G**

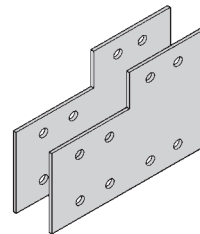

Tray Series	Catalog No.
156 to 148	<b>9(*)-8044</b>
166 to 156 or 148	<b>9(*)-8045</b>
176 to 156 or 148	<b>9(*)-8046</b>
176 to 166	<b>9(*)-8060</b>

## Vertical Adjustable Splice Plates

- These plates provide for changes in elevation that do not conform to standard vertical fittings.
- Bonding jumpers not required.
- Furnished in pairs with hardware.
- (\*) Insert **ZN** or **G**
- (\*\*\*) Insert **P** or **G**

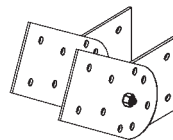

Requires supports within 24" on both sides, per NEMA VE 2.

Tray Series	Catalog No.
148	<b>9(*)-7024</b>
156	<b>9(**)-8024</b>
166	<b>9(**)-8025</b>
176	<b>9(**)-8026</b>

## Horizontal Adjustable Splice Plates

- Offered to adjust a cable tray run for changes in direction in a horizontal plane that do not conform to standard horizontal fittings.
- Furnished in pairs with hardware.
- Bonding jumpers not required.
- (\*) Insert **ZN** or **G**
- (X) Insert 4 for series 148 or 156, 5 for series 166, or 6 for series 176

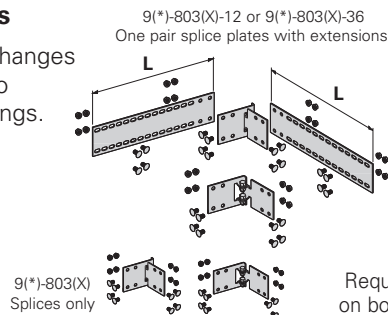

Catalog No.	Cable Tray End Cut	Tray Width	'L'
<b>9(*)-803(X)</b>	Mitered	Thru 36"	N/A
<b>9(*)-803(X)-12</b>	Not mitered	Thru 12"	16"
<b>9(*)-803(X)-36</b>	Not mitered	Thru 36"	41"

Requires supports within 24" on both sides, per NEMA VE 2.

● Green = Fastest shipped items   ● Black = Normal lead-time items   ● Red = Normally long lead-time items

All dimensions in parentheses are millimeters unless otherwise specified.

## Branch Pivot Connectors

- Branch from existing cable tray runs at any point.
- Pivot to any required angle.
- UL Classified for grounding (bonding jumpers are not required).
- Furnished in pairs with hardware.
- (\*) Insert **ZN** or **G**

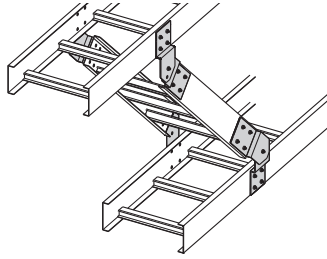

Tray Series	Catalog No.
156 to 148	<b>9(*)-8244</b>
166	<b>9(*)-8245</b>
176	<b>9(*)-8246</b>

## Offset Reducing Splice Plate

- This plate is used for joining cable trays having different widths. When used in pairs they form a straight reduction; when used singly with a standard splice plate they form an offset reduction.
- Furnished as one plate with hardware.
- (‡) Insert reduction
- (\*) Insert **P** or **G**

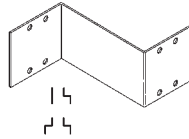

Tray Series	Catalog No.
148	<b>9(*)-8064-(‡)</b>
156	<b>9(*)-8064-(‡)</b>
166	<b>9(*)-8065-(‡)</b>
176	<b>9(*)-8066-(‡)</b>

## Tray to Box Splice Plates

- Used to attach the end of a cable tray run to a distribution box or control panel.
- Furnished in pairs with hardware.
- (\*) Insert **P** or **G**

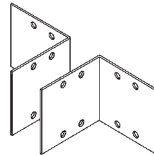

Tray Series	Catalog No.
148	<b>9(*)-8054</b>
156	<b>9(*)-8054</b>
166	<b>9(*)-8055</b>
176	<b>9(*)-8056</b>

## Frame Type Box Connector

- Designed to attach the end of a cable tray run to a distribution cabinet or control center to help reinforce the box at the point of entry.
- Furnished with tray connection hardware.
- (‡) Insert tray width
- (\*) Insert **ZN** or **G**

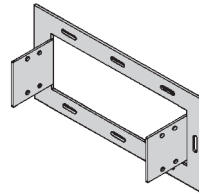

Tray Series	Catalog No.
148	<b>9(*)-8074-(‡)</b>
156	<b>9(*)-8074-(‡)</b>
166	<b>9(*)-8075-(‡)</b>
176	<b>9(*)-8076-(‡)</b>

## Blind End

- This plate forms a closure for a dead end cable tray.
- Furnished as one plate with hardware.
- (‡) Insert tray width
- (\*) Insert **P** or **G**

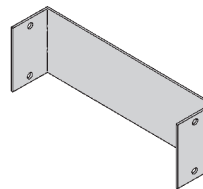

Tray Series	Catalog No.
148	<b>9(*)-8084-(‡)</b>
156	<b>9(*)-8084-(‡)</b>
166	<b>9(*)-8085-(‡)</b>
176	<b>9(*)-8086-(‡)</b>

## Tray Hardware

### Pre-Galvanized Tray Hardware

**Catalog No.** ● **RNCB 3/8"-16 x 3/4" Znplt**  
Ribbed Neck Carriage Bolt ASTM A307 Grade A

**Catalog No.** ● **SFHN 3/8"-16 Znplt**  
Serrated Flange Hex Nut ASTM A563 Grade A

**Finish:** Zinc Plated ASTM B633, SC1

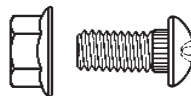

### Hot Dip Galvanized Tray Hardware

**Catalog No.** ● **RNCB 3/8"-16 x 3/4" CZ** Ribbed Neck Carriage Bolt Chromium Zinc ASTM F-1136-88

**Catalog No.** ● **SFHN 3/8"-16 CZ** Serrated Flange Hex Nut Chromium Zinc ASTM F-1136-88

● Green = Fastest shipped items    ● Black = Normal lead-time items    ● Red = Normally long lead-time items

All dimensions in parentheses are millimeters unless otherwise specified.



# Series 1 Steel - Accessories

## Conduit to Tray Adaptor

- For easy attachment of conduit terminating at a cable tray.
- Use on aluminum or steel cable trays.

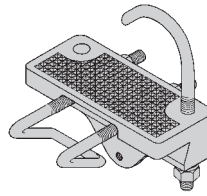
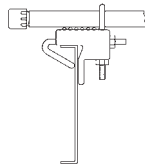

Conduit Size		Catalog No.
in.	(mm)	
1/2, 3/4	(15, 20)	<b>9G-1159-1/2, 3/4</b>
1, 1 1/4	(25, 32)	<b>9G-1159-1, 1 1/4</b>
1 1/2, 2	(40, 50)	<b>9G-1159-1 1/2, 2</b>
2 1/2, 3	(65, 80)	<b>9G-1159-2 1/2, 3</b>
3 1/2, 4	(90, 100)	<b>9G-1159-3 1/2, 4</b>

## Conduit to Tray Adaptor

- Assembly required.
- Mounting hardware included.
- Conduit clamp included
- (‡) = Conduit size (1/2" thru 4").

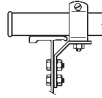

Catalog No.
<b>9ZN-1150-(‡)</b>

## Cable Tie (Ladder Tray)

- Nylon ties provide easy attachment of cable to ladder rungs; maximum cable O.D. of 3" (76 mm).

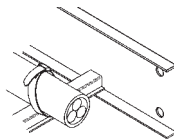

Catalog No.
<b>99-2125-15</b>

## Cable Tray Clamp/Guide

- Features a no-twist design.
- Has four times the strength of the traditional design.
- Each side is labeled to ensure proper installation.
- Furnished in pairs, with or without hardware.

Patent # RE35479

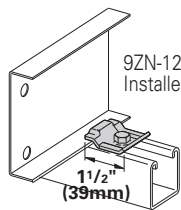

9ZN-1204 shown. Installed as a guide.

1 1/2" (39mm)

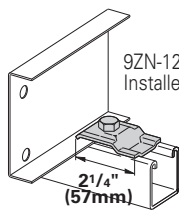

9ZN-1208 shown. Installed as a clamp.

2 1/4" (57mm)

Catalog No.		Overall Length in. (mm)	Hardware Size	Finish
Without Hardware	With Hardware			
<b>9ZN-1204</b>	<b>9ZN-1204NB</b>	1 1/2 38	1/4"	G90
<b>9ZN-1208</b>	<b>9ZN-1208NB</b>	2 1/4 57	3/8"	G90

## Bonding Jumper

Use at each expansion splice and where the cable tray is not mechanically/electrically continuous to ground.

Sold individually.

- Hardware included.
- See table 392.7(B)(2) on page C-9 for amperage ratings required to match the UL cross-sectional area of the tray.
- 600 amp rating.
- Bonding jumper is 14 1/2" (368mm) long.

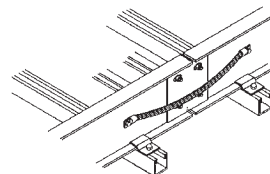

Catalog No.	Copper Wire Size
<b>99-N1</b>	#1

## Grounding Clamp

Eaton's B-Line series cable tray is UL® classified as its suitability as an equipment grounding conductor. If a separate conductor for additional grounding capability is desired, we offer this clamp for bolting the conductor at least once to each tray section.

- Tin plated Aluminum clamp accepts #6 AWG to 250 MCM.

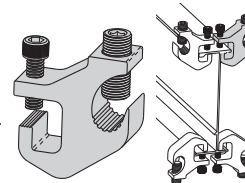

Catalog No.
<b>9A-2130</b>

## Ground Wire Clamp

- Mechanically attaches grounding cables to cable tray.
- Hardware included.
- (\*) Insert **ZN** or **SS4**

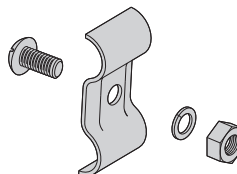

Catalog No.	Cable Size
<b>9(*)-2351</b>	#1 thru 2/0
<b>9(*)-2352</b>	3/0 thru 250 MCM

● Green = Fastest shipped items   ● Black = Normal lead-time items   ● Red = Normally long lead-time items

All dimensions in parentheses are millimeters unless otherwise specified.

## Threaded Rod (ATR) & Rod Coupling

- Loading based on safety factor 5.
- Standard Finish: Zinc plated

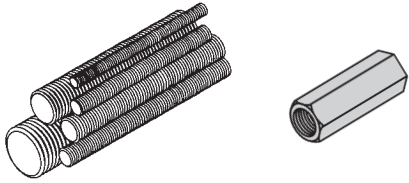

Size	Loading lbs. (kN)	Threaded Rod Catalog No.	Available Lengths in. (mm)	Coupling Cat. No.
3/8-16	730 (3.25)	● ATR 3/8 x Length	36, 72, 120, 144 (914, 1829, 3048, 3657)	● B655-3/8
1/2-13	1350 (6.00)	● ATR 3/8 x Length	36, 72, 120, 144 (914, 1829, 3048, 3657)	● B655-1/2

See B-Line series Strut Systems Catalog for other sizes and finishes.

## Hanger Rod Clamp

- For 1/2" ATR.
- Furnished in pairs.
- Order ATR and hex nuts separately.
- Two piece "J"-hanger design.
- 9ZN-1113 has 275 lbs./pair.
- 9ZN-532(X) has 1350 lbs./pair.

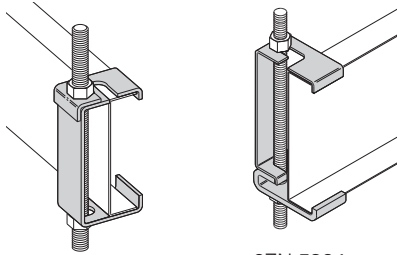

9ZN-1113

9ZN-5324  
9ZN-5325  
9ZN-5326

Tray Series	Catalog No.
148	● 9ZN-1113
156	● 9ZN-5324
166	● 9ZN-5325
176	● 9ZN-5326

## Support Bracket

- Designed for center hung or trapeze supports.
- Used with ladder or vented bottom tray only.
- Can be purchased as a wall mounted bracket.
- Load capacity is 600 lbs. (272.1 kg), safety factor 3.
- All components are zinc plated.
- 1/2" threaded rod and 1/2" hex nuts not included.

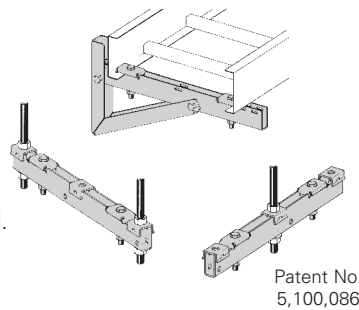

Patent No.  
5,100,086

Catalog No.		For Cable Tray Width in. (mm)
Center Hung or Trapeze	Wall Mount	
● 9ZN-5106	● 9ZN-5106-WB	6 (152)
● 9ZN-5109	● 9ZN-5109-WB	9 (226)
● 9ZN-5112	● 9ZN-5112-WB	12 (305)
● 9ZN-5118	● 9ZN-5118-WB	18 (452)
● 9ZN-5124	● 9ZN-5124-WB	24 (609)

## Cantilever Bracket (12" - 42")

- Finishes available:  
● ZN ● GRN or ● HDG
- Safety Load Factor 2.5

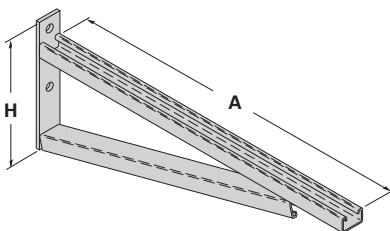

Bottom brace is B42 channel on B494-24 and smaller and B22 channel on B494-30 and larger

Catalog No.	Uniform Load lbs. (kN)	Tray Width in. (mm)	'A' in. (mm)	'H' in. (mm)
● B494-12	2500 (11.12)	6 & 9 (152 & 229)	12 (305)	8 <sup>3</sup> / <sub>4</sub> (222)
● B494-18	1700 (7.56)	12 (305)	18 (457)	8 <sup>3</sup> / <sub>4</sub> (222)
● B494-24	1300 (5.78)	18 (457)	24 (610)	8 <sup>3</sup> / <sub>4</sub> (222)
B494-30	1600 (7.11)	24 (610)	30 (762)	11 <sup>1</sup> / <sub>4</sub> (286)
B494-36	1100 (4.89)	30 (762)	36 (914)	11 <sup>1</sup> / <sub>4</sub> (286)
B494-42	980 (4.36)	36 (914)	42 (1067)	16 (406)

For more dimensional data see Strut Systems catalog

● Green = Fastest shipped items ● Black = Normal lead-time items ● Red = Normally long lead-time items

All dimensions in parentheses are millimeters unless otherwise specified.

# Series 1 Steel - Accessories

## Cantilever Bracket

- Finishes available: **ZN** **GRN** **HDG** **SS4** or **SS6**
- Safety Load Factor 2.5

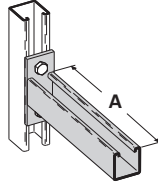

Catalog No.	Uniform Load		Tray Width		'A'	
	lbs	(kN)	in.	(mm)	in.	(mm)
<b>B409-12</b>	960	(4.27)	6 & 9	(152 & 229)	12	(304.8)
<b>B409-18</b>	640	(2.84)	12	(305)	18	(457.2)
<b>B409-24</b>	480	(2.13)	18	(457)	24	(609.6)

## Cantilever Bracket

- Finishes available: **ZN** **GRN** **HDG** or **SS4**
- Safety Load Factor 2.5

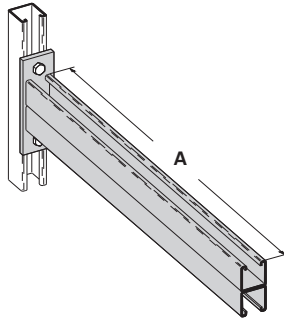

Catalog No.	Uniform Load		Tray Width		'A'	
	lbs	(kN)	in.	(mm)	in.	(mm)
<b>B297-30</b>	665	(2.95)	24	(609.6)	30	(762.0)
<b>B297-36</b>	550	(2.44)	30	(762.0)	36	(914.4)
<b>B297-42</b>	465	(2.06)	36	(914.4)	42	(1066.8)

## Underfloor Support (U-Bolts not included)

- Finishes available: **ZN**
- Safety Load Factor 2.5
- Order properly sized U-Bolts separately.

U-Bolt Size	Fits Pipe O.D.
B501-3/4	.841 - 1.050
B501-1	1.051 - 1.315
B501-1 1/4	1.316 - 1.660
B501-1 1/2	1.661 - 1.900
B501-2	1.901 - 2.375
B501-2 1/2	2.376 - 2.875

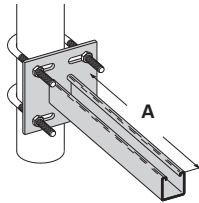

Catalog No.	Uniform Load		Tray Width		'A'	
	lbs	(kN)	in.	(mm)	in.	(mm)
<b>B409UF-12</b>	800	(3.55)	6 & 9	(152 & 229)	12	(304.8)
<b>B409UF-21</b>	450	(2.00)	12 & 18	(305 & 457)	21	(533.4)

## Beam Clamp

- Finishes available: **ZN** or **HDG**
- Sold in pieces with hardware.
- Design load when used in pairs. Safety Load Factor 5.0

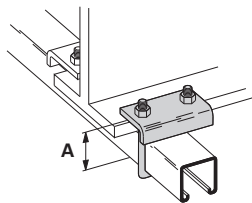

Catalog No.	Design Load*		'A'	
	lbs	(kN)	in.	(mm)
<b>B441-22</b>	1200	(5.34)	3 3/8	(86)
<b>B441-22A</b>	1200	(5.34)	5	(127)

## Steel C-Clamp With Locknut

- Finishes available:
  - ZN** for 3/8 & 1/2
  - ZN** for 5/8 & 3/4
  - SS4** all sizes
- Safety Load Factor 5.0

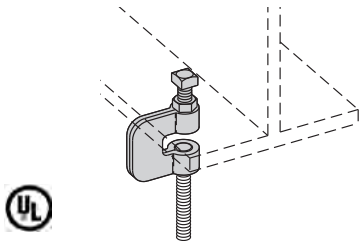

Catalog Number	Rod Size	Design Load	
		lbs	(kN)
<b>B351L-3/8</b>	3/8"-16	300	(0.89)
<b>B351L-1/2</b>	1/2"-13	380	(1.69)
<b>B351L-5/8</b>	5/8"-11	550	(2.44)
<b>B351L-3/4</b>	3/4"-10	630	(2.80)

● Green = Fastest shipped items ● Black = Normal lead-time items ● Red = Normally long lead-time items

All dimensions in parentheses are millimeters unless otherwise specified.

## Beam Clamp

- Finishes available: **ZN** **GRN** or **HDG**
- Setscrew included.
- Sold in pieces.
- Design load when used in pairs.  
Safety Load Factor 5.0

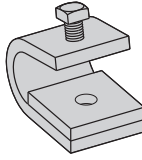

Cat. No.	B210	B210A
<b>Design Load</b>	800 lbs. (3.56kN)	300 lbs. (1.33kN)
<b>Tap Size</b>	1/2"-13	3/8"-16
<b>Mat'l. Thickness</b>	3/8" (9.5mm)	1/4" (6.4mm)

## Beam Clamp

- Finishes available: **ZN** **GRN** or **HDG**
- Setscrew included.
- Sold in pieces.
- Design load when used in pairs.  
Safety Load Factor 5.0

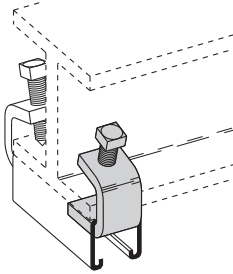

Cat. No.	B212-1/4	B212-3/8
<b>Design Load</b>	800 lbs. (3.56kN)	1000 lbs. (4.45kN)
<b>Max. Flange Thick.</b>	3/4" (19.0mm)	1 1/8" (28.6mm)
<b>Mat'l. Thickness</b>	1/4" (6.4mm)	3/8" (9.5mm)

## B305 Thru B308 & B321 Series Beam Clamps

- Finishes available: **ZN** or **HDG**
- Setscrew included.
- Safety Load Factor 5.0

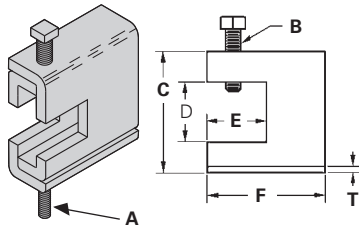

Cat. No.	A	B	C	D	E	F	T	Design Load
			in. (mm)	in. (mm)	in. (mm)	in. (mm)	in. (mm)	lbs (kN)
<b>B305</b>	3/8"-16	3/8"-16	2 5/16 (58.7)	7/8 (22.2)	1 1/8 (28.6)	2 1/2 (63.5)	11 Ga. (3.0)	600 (2.67)
<b>B306</b>	3/8"-16	1/2"-13	2 7/16 (61.9)	7/8 (22.2)	1 1/8 (28.6)	2 1/2 (63.5)	7 Ga. (4.5)	1100 (4.90)
<b>B307</b>	1/2"-13	1/2"-13	2 7/16 (61.9)	7/8 (22.2)	1 1/8 (28.6)	2 1/2 (63.5)	7 Ga. (4.5)	1100 (4.90)
<b>B308</b>	1/2"-13	1/2"-13	2 9/16 (65.1)	7/8 (22.2)	1 1/8 (28.6)	2 1/2 (63.5)	1/4 (6.3)	1500 (6.68)
<b>B321-1</b>	3/8"-16	1/2"-13	3 9/16 (90.5)	1 11/16 (42.8)	1 5/8 (41.3)	3 1/4 (82.5)	1/4 (6.3)	1300 (5.79)
<b>B321-2</b>	1/2"-13	1/2"-13	3 9/16 (90.5)	1 11/16 (42.8)	1 5/8 (41.3)	3 1/4 (82.5)	1/4 (6.3)	1400 (6.23)

## B312 Anchor Strap

- Finishes available: **ZN** or **HDG**
- For a maximum beam thickness of 3/4".
- For thicker beams, step up one flange width size.

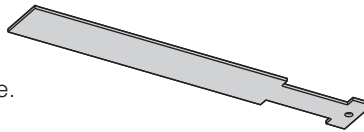

Cat. No.	Flange Width
	in. (mm)
<b>B312-6</b>	Up to 6 (up to 152.4)
<b>B312-9</b>	6 - 9 (152.4 to 228.6)
<b>B312-12</b>	9 - 12 (228.6 to 304.8)

## B751 Bottom Beam Clamp and Accessories

- Setscrew included.
- Finish available: ZN

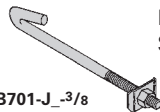

Loading position A - 500 lbs.  
Loading position B - 300 lbs.  
Safety Load Factor 5.0

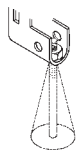
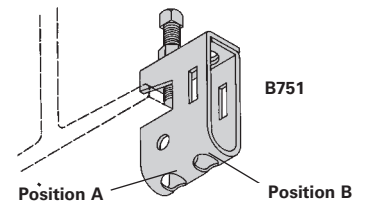
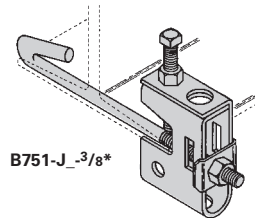

B753

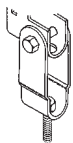

B752

Provides a full 15° swivel in any direction. (State the desired rod size.)

Assembly No.	B751	B701J_	B752	B753
Fits Flange Sizes	Clamp, Setscrew & J-Hook	J-Hook, Clip & Square Nut	Swivel & Bolt Only	Swivel Nut Only
in. (mm)				
4 - 5 7/8 (101 - 149)	● B751-J4-3/8*	● B701-J4-3/8	● B752	● B753-**
6 - 8 7/8 (152 - 225)	● B751-J6-3/8*	● B701-J6-3/8	● B752	● B753-**
9 - 11 7/8 (228 - 301)	● B751-J9-3/8*	● B701-J9-3/8	● B752	● B753-**

\* Clamp Assembly complete with J-Hook Assembly. Setscrew included.

\*\* Insert 1/4, 3/8 or 1/2 for the desired rod size.

● Green = Fastest shipped items    ● Black = Normal lead-time items    ● Red = Normally long lead-time items

All dimensions in parentheses are millimeters unless otherwise specified.

# Series 1 Steel - Accessories

## Trapeze Support Kit

Trapeze kits provide the components required for a single trapeze support in one package. These kits are available in pre-galvanized steel with zinc-plated hardware or hot dip galvanized steel with 316 stainless steel hardware.

The SH channel provides the convenience of pre-punched slots, which eliminate the need for field drilling.

The illustrated hardware is sealed in a plastic bag and boxed with the channel, which is pre-cut to the appropriate length as shown in the chart.

Designed for use with 1/2" threaded rod. (order separately)

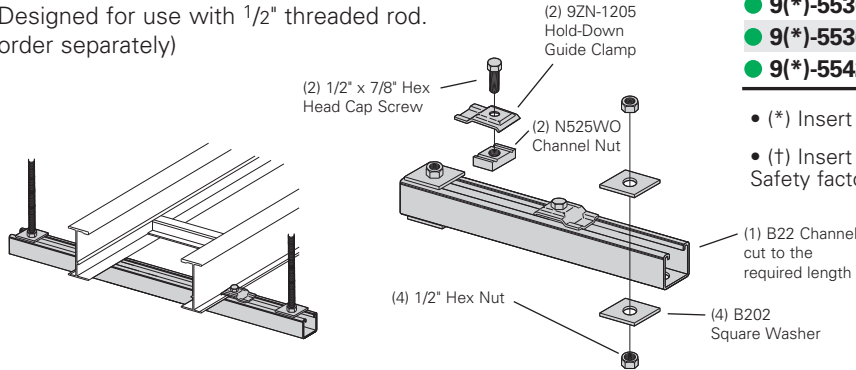

Catalog No.	Tray Width in. (mm)	Channel Length in. (mm)	Uniform Load lbs (kN)
● 9(*)-5506-22SH(+)	6 (152)	16 (406)	1600 (7.11)
● 9(*)-5509-22SH(+)	9 (229)	18 (457)	1250 (5.56)
● 9(*)-5512-22SH(+)	12 (305)	22 (559)	1125 (5.00)
● 9(*)-5518-22SH(+)	18 (457)	28 (711)	865 (3.85)
● 9(*)-5524-22SH(+)	24 (610)	34 (864)	700 (3.11)
● 9(*)-5530-22SH(+)	30 (762)	40 (1016)	590 (2.62)
● 9(*)-5536-22SH(+)	36 (914)	46 (1168)	510 (2.27)
● 9(*)-5542-22SH(+)	42 (1067)	52 (1321)	450 (2.00)

- (\*) Insert **P** or **G**
- (+) Insert 3/8 for 3/8" threaded rod hardware. Safety factor of 3.0 on all loads.

## Heavy Duty Trapeze Support Kit

Trapeze kits provide the components required for a single trapeze support in one package. These kits are available in Dura Green™ epoxy coated steel with zinc-plated hardware or hot dip galvanized steel with 316 stainless steel hardware.

The SH channel provides the convenience of pre-punched slots, which eliminates the need for field drilling.

The illustrated hardware is sealed in a plastic bag and boxed with the channel, which is pre-cut to the appropriate length as shown in the chart.

Designed for use with 1/2" threaded rod. (order rod separately)

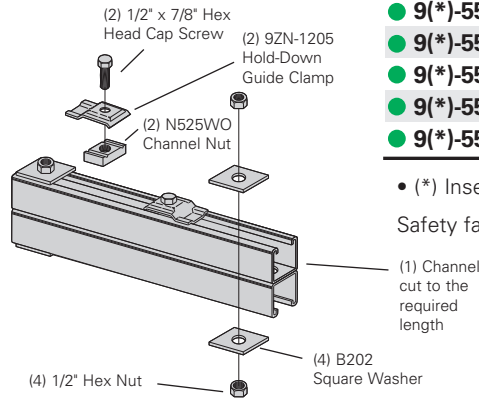

Catalog No.	Tray Width in. (mm)	Channel Length in. (mm)	Uniform Load lbs (kN)
● 9(*)-5506-22SHA	6 (152)	16 (406)	1350 (6.01)
● 9(*)-5509-22SHA	9 (229)	18 (457)	1350 (6.01)
● 9(*)-5512-22SHA	12 (305)	22 (559)	1350 (6.01)
● 9(*)-5518-22SHA	18 (457)	28 (711)	1350 (6.01)
● 9(*)-5524-22SHA	24 (610)	34 (864)	1350 (6.01)
● 9(*)-5530-22SHA	30 (762)	40 (1016)	1350 (6.01)
● 9(*)-5536-22SHA	36 (914)	46 (1168)	1350 (6.01)
● 9(*)-5542-22SHA	42 (1067)	52 (1321)	1350 (6.01)

- (\*) Insert **G** or **GRN**
- Safety factor of 3.0 on all loads.

## Trapeze Hardware Kit

- Kit sold in plastic bag.

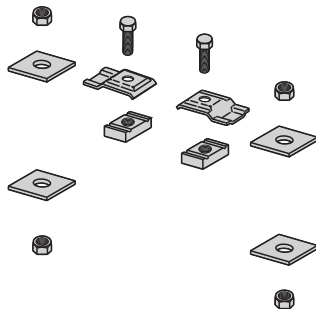

Catalog No.	
● 9ZN-5500-1/2	● 9G-5500-1/2
(1) pr. 9ZN-1205	(1) pr. 9G-1205
(2) HHC Screw 1/2 x 7/8" ZN	(2) HHC Screw 1/2" x 7/8" SS6
(2) N525 WO ZN	(2) N525 WO SS6
(4) B202 ZN 1/2" sq washer	(4) B202 HDG 1/2" sq washer
(4) HN 1/2" ZN	(4) HN 1/2" SS6

● Green = Fastest shipped items    ● Black = Normal lead-time items    ● Red = Normally long lead-time items

All dimensions in parentheses are millimeters unless otherwise specified.

## Ladder Drop-Out

- This special designed, easy to install drop-out provides a 4" (101.6 mm) radius to protect cables exiting the cable tray from damage.
- Attaches to a ladder rung.
- Hardware included.
- (\*) Insert P or G
- (‡) Insert tray width

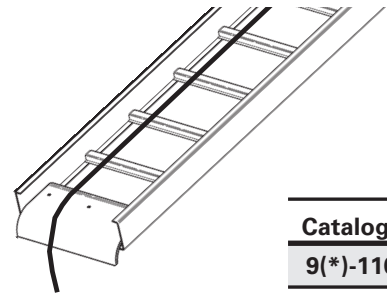
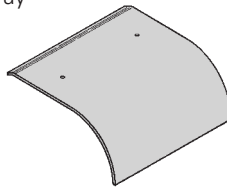

**Catalog No.**  
**9(\*)-1104T-(‡)**

## Straight Section

- Standard length: 120" (3 m) 144" (12 ft.).
- Order catalog number based on loading depth.
- Furnished with four #10 x 1/2" plated self-drilling screws and a 99-9982 splice.
- (\*) Insert P or G

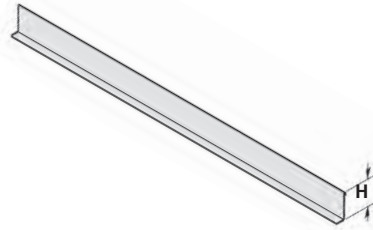

**Length =**  
144 for 12' or 120 for 10'

Tray Series	Catalog No.	H	
		in.	(mm)
148	<b>72(*)-Length</b>	2.8	(58)
156	<b>737(*)-Length</b>	3.4	(70)
166	<b>747(*)-Length</b>	4.4	(91)
176	<b>757(*)-Length</b>	5.4	(112)

## Horizontal Bend

- Horizontal Bend Barriers are flexible in order to conform to any horizontal fitting radius. Cut to length.
- Order catalog number based on loading depth.
- Furnished with three #10 x 1/2" zinc plated self-drilling screws and a 99-9982 Barrier Strip Splice.
- Standard length is 72" [6 ft.] (1829mm), sold individually.
- (\*) Insert P or G

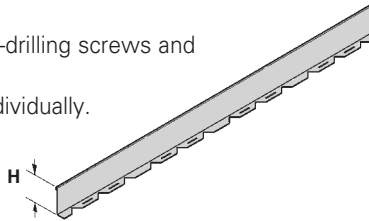

Tray Series	Catalog No.	H	
		in.	(mm)
148	<b>72(*)-90HBFL</b>	2.8	(58)
156	<b>737(*)-90HBFL</b>	3.4	(70)
166	<b>747(*)-90HBFL</b>	4.4	(91)
176	<b>757(*)-90HBFL</b>	5.4	(112)

## Vertical Bend Barriers

- Vertical Bend Barriers are preformed to conform to a specific vertical fitting.
- Furnished with three #10 x 1/2" plated self-drilling screws and a 99-9982 Barrier Strip Splice.
- (\*) Insert P or G
- (\*\*\*) Insert 30, 45, 60 or 90 for degrees
- (t) Insert 12, 24, or 36 for radius

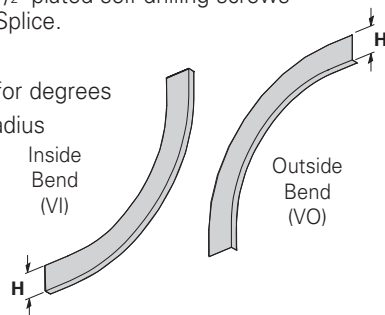

Tray Series	Catalog No.		H	
	Inside Bend	Outside Bend	in.	(mm)
148	<b>72(*)-(***)VI(t)</b>	<b>72(*)-(***)VO(t)</b>	2.8	(58)
156	<b>737(*)-(***)VI(t)</b>	<b>737(*)-(***)VO(t)</b>	3.4	(70)
166	<b>747(*)-(***)VI(t)</b>	<b>747(*)-(***)VO(t)</b>	4.4	(91)
176	<b>757(*)-(***)VI(t)</b>	<b>757(*)-(***)VO(t)</b>	5.4	(112)

## Barrier Strip Splice

- 2.85" (72.4mm) long
- Ribbed edge for increased rigidity and grip
- Comfort edge for ease of installation
- Slotted top window with center mark for accurate placement and inspection capability
- Patent pending

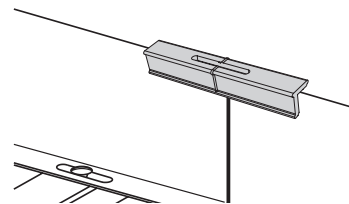
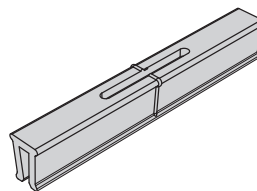

**Catalog No.**  
● **99-9982**

● Green = Fastest shipped items    ● Black = Normal lead-time items    ● Red = Normally long lead-time items

All dimensions in parentheses are millimeters unless otherwise specified.

## Covers

**Solid covers** should be used when maximum enclosure of the cables is desired and no accumulation of heat is expected. **Ventilated covers** provide an overhead cable shield yet allow heat to escape.

We recommend that covers on vertical cable tray runs to a height of 6 ft. (1.83 m) to 8 ft. (2.44 m) above the floor to isolate both cables and personnel. **Flanged covers** have a .30 in. (7.6 mm) flange. Cover clamps are not included with the cover and must be ordered separately.

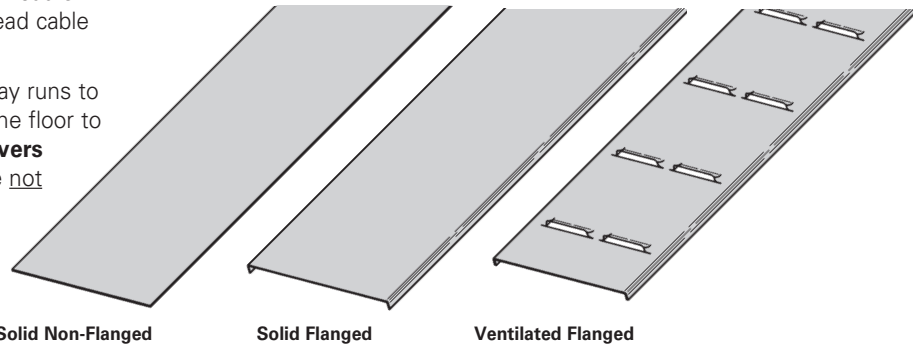

Solid Non-Flanged

Solid Flanged

Ventilated Flanged

### Covers Part Numbering

Prefix  
Example: **80 1 P - 24 - 144**

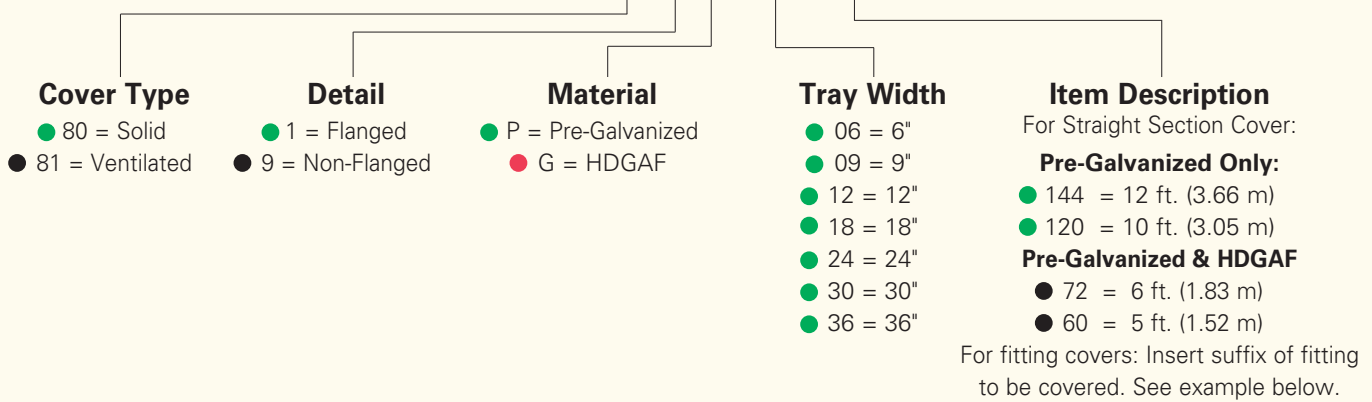

### Example of Catalog Number for Fitting Cover:

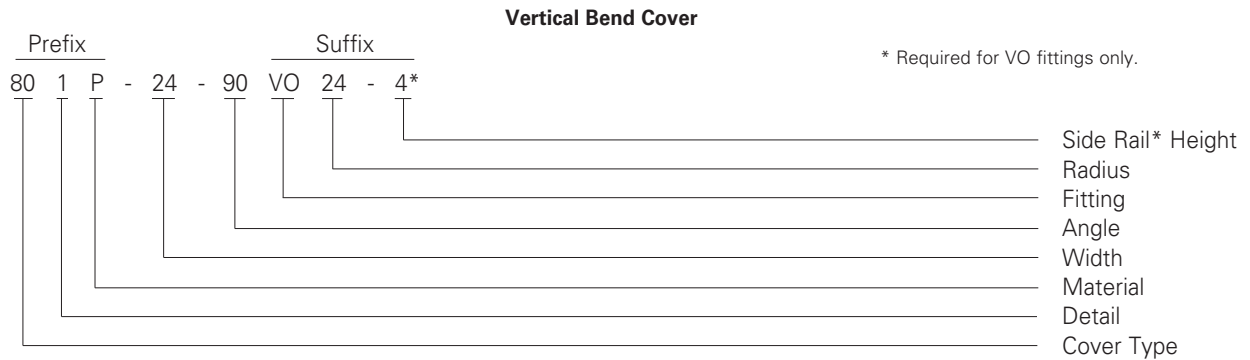

### Quantity of Standard Cover Clamps Required

Straight Section 60" or 72"	4 pcs.
Straight Section 120" or 144"	6 pcs.
Horizontal/Vertical Bends	4 pcs.
Tees	6 pcs.
Crosses	8 pcs.

Note: When using the Heavy Duty Cover Clamp, only one-half the number of clamps stated above is required.

● Green = Fastest shipped items    ● Black = Normal lead-time items    ● Red = Normally long lead-time items

All dimensions in parentheses are millimeters unless otherwise specified.

## Cover Joint Strip

- Used to join covers
- Plastic
- (‡) Insert tray width

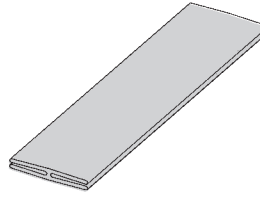

Catalog No.

● 99-9980-(‡)

## Standard Cover Clamp

- Sold per piece
- For indoor service only

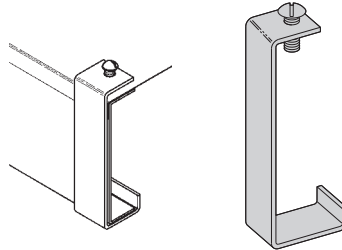

Tray Series	Catalog No.	
	Znplt	HDGAF
148	● 9ZN-9019	● 9G-9019
156	● 9ZN-9014	● 9G-9014
166	● 9ZN-9015	● 9G-9015
176	● 9ZN-9016	● 9G-9016

## Combination Hold Down & Cover Clamp

- Sold per piece
- For indoor service only

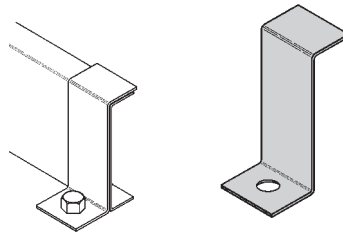

Tray Series	Catalog No.	
	Znplt/Pre-Galv	HDGAF
148	● 9ZN-9243	● 9G-9243
156	● 9P-9043	● 9G-9043
166	● 9P-9053	● 9G-9053
176	● 9P-9063	● 9G-9063

## Heavy Duty Cover Clamp

- (‡) Insert tray width

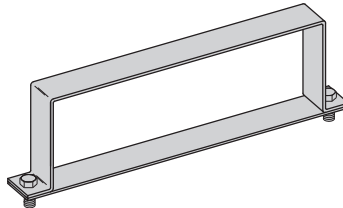

Tray Series	Catalog No.	
	Pre-Galv	HDGAF
148	● 9P-(‡)-9040	● 9G-(‡)-9040
156	● 9P-(‡)-9044	● 9G-(‡)-9044
166	● 9P-(‡)-9054	● 9G-(‡)-9054
176	● 9P-(‡)-9064	● 9G-(‡)-9064

## Raised Cover Clamp

- For indoor service only.
- Sold per piece
- For use with flanged covers only.

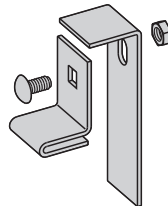

† Specify gap of 1", 2", 3" or 4".

Tray Series	Catalog No.		Gap in. (mm)
	Catalog No.		
Series 1	9ZN-9101		1 (25.4)
	9ZN-9102		2 (50.8)
	9ZN-9103		3 (76.2)
	9ZN-9104		4 (101.6)

● Green = Fastest shipped items   ● Black = Normal lead-time items   ● Red = Normally long lead-time items

All dimensions in parentheses are millimeters unless otherwise specified.



## Section 1- Acceptable Manufacturers

- 1.01 Manufacturer: Subject to compliance with these specifications, Eaton's B-Line series cable tray systems shall be as manufactured by Eaton.

## Section 2- Cable Tray Sections and Components

- 2.01 General: Except as otherwise indicated, provide metal cable trays, of types, classes and sizes indicated; with splice plates, bolts, nuts and washers for connecting units. Construct units with rounded edges and smooth surfaces; in compliance with applicable standards; and with the following additional construction features. Cable tray shall be installed according to the latest revision of NEMA VE 2.
- 2.02 Pre-Galvanized Steel: Straight sections, fitting side rails, rungs, and covers shall be made from structural quality steel meeting the minimum mechanical properties and mill galvanized in accordance with ASTM A653 SS, Grade 33, coating designation G90. Hardware finish shall be electro-galvanized zinc per ASTM B633.
- 2.03 Hot dip Galvanized Steel: All side rails, covers, splice plates, and rungs shall be made from structural quality steel meeting the minimum mechanical properties of ASTM A1011 SS, Grade 33 for 14 gauge and heavier, ASTM A1008, Grade 33 Type 2 for 16 gauge and lighter, and shall be hot dip galvanized after fabrication in accordance with ASTM A123. Mill galvanized covers are not acceptable for hot dipped galvanized cable tray. Hardware finish shall be chromium zinc per ASTM F-1136-88.
- 2.04 Ladder Cable Trays shall consist of two longitudinal members (side rails) with transverse members (rungs) welded to the side rails. Rungs shall be spaced [6] [9] [12] inches apart. Rung spacing in radiused fittings shall be industry standard 9" and measured at the center of the tray's width. No portion of the rungs shall protrude below the bottom plane of the side rails.
- 2.05 Ventilated Trough Cable Trays shall consist of two longitudinal members (side rails) with a corrugated bottom welded to the side rails or rungs spaced 4" apart. The peaks of the corrugated bottom shall have a minimum flat cable bearing surface of 2<sup>3</sup>/<sub>4</sub>" and shall be spaced on 6" centers. To provide ventilation in the tray, the valleys of the corrugated bottom shall have 2<sup>1</sup>/<sub>4</sub>" x 4" rectangular holes punched along the width of the bottom.
- 2.06 Non-Ventilated Bottom Trough Cable Trays shall consist of two longitudinal members (side rails) with a corrugated bottom welded to the side rails or a solid sheet over rungs. The peaks of the corrugated bottom shall have a minimum flat cable bearing surface of 2<sup>3</sup>/<sub>4</sub>" and shall be spaced on 6" centers.
- 2.07 Cable tray loading depth shall be [3] [4] [5] [6] inches per NEMA VE 1.
- 2.08 Straight sections shall be supplied in standard [12 foot] [10 foot (3 m)] lengths.
- 2.09 Cable tray widths shall be [6] [9] [12] [18] [24] [30] [36] inches or as shown on drawings.
- 2.10 Splice plates shall be L-shaped with 4 nuts and bolts per plate. The resistance of fixed splice connections between an adjacent section of tray shall not exceed 0.00033 ohm.
- 2.11 All fittings must have a minimum radius of [12] [24] inches.

## Section 3- Loading Capacities and Testing

- 3.01 Cable tray shall be capable of carrying a uniformly distributed load of \_\_\_\_\_ lbs./ft. on a \_\_\_\_\_ ft. support span with a safety factor of 1.5 when supported as a simple span and tested per NEMA VE 1 5.2. Cable tray shall be made to manufacturing tolerances as specified by NEMA.
- 3.02 Upon request, manufacturer shall provide test reports in accordance with the latest revision of NEMA VE 1 or CSA C22.2 No. 126.

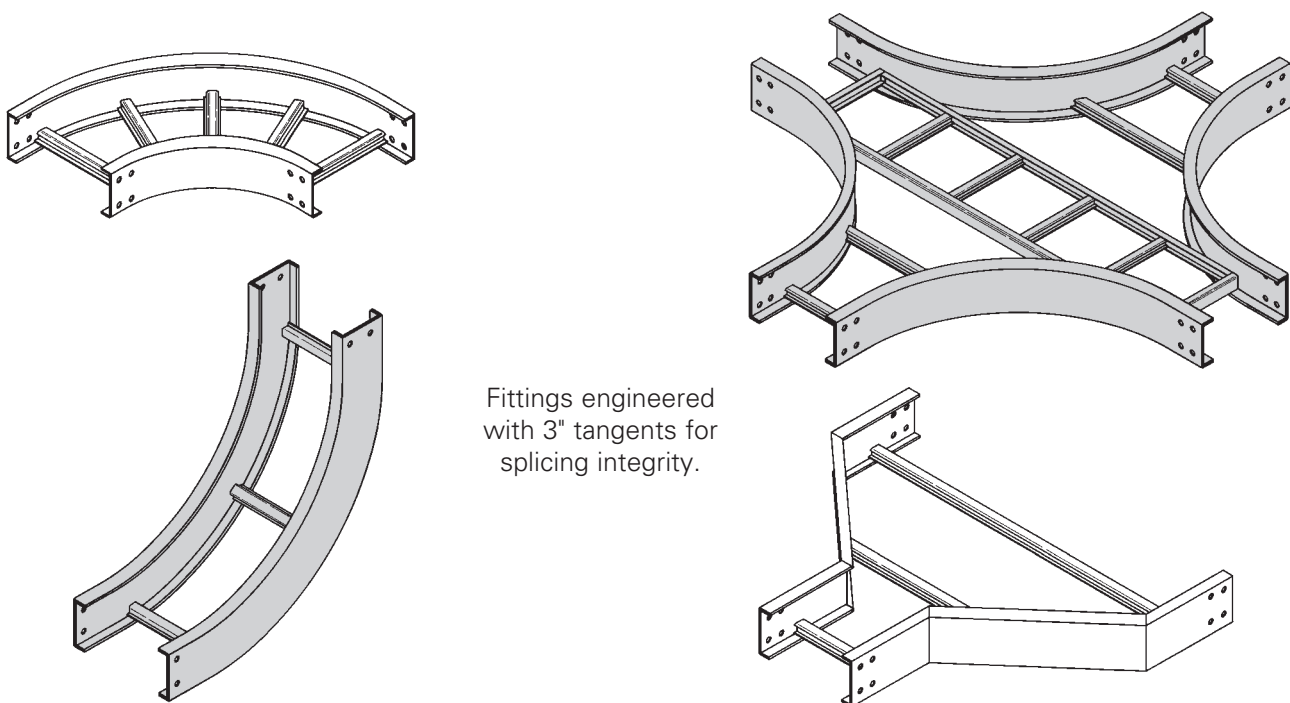

## Fittings Part Numbering

Example: 1 4 P - 24 - 90 HB 24 (9" rung spacing is standard)

Series	Height	Material	Width	Angle	Type	Radius
1	<ul style="list-style-type: none"> <li>● 4 = 148</li> <li>● 5 = 156</li> <li>● 6 = 166</li> <li>● 7 = 176</li> </ul>	<ul style="list-style-type: none"> <li>● P = Pre-Galvanized</li> <li>● G = HDGAF</li> </ul>	<ul style="list-style-type: none"> <li>● 06 = 6" (152)</li> <li>● 09 = 9" (228)</li> <li>● 12 = 12" (305)</li> <li>● 18 = 18" (457)</li> <li>● 24 = 24" (609)</li> <li>● 30 = 30" (762)</li> <li>● 36 = 36" (914)</li> </ul>	<ul style="list-style-type: none"> <li>● 30 = 30°</li> <li>● 45 = 45°</li> <li>● 60 = 60°</li> <li>● 90 = 90°</li> </ul>	<ul style="list-style-type: none"> <li>● HB = Horizontal Bend</li> <li>● HT = Horizontal Tee</li> <li>● HX = Horizontal Cross</li> <li>● VI = Vertical Inside Bend</li> <li>● VO = Vertical Outside Bend</li> <li>● LR = Left Reducer</li> <li>● RR = Right Reducer</li> <li>● SR = Straight Reducer</li> </ul>	<ul style="list-style-type: none"> <li>● 12 = 12" (305)</li> <li>● 24 = 24" (609)</li> <li>● 36 = 36" (914)</li> </ul>

For steel 4", 5", 6", 7" vented or non-vented add 04 or SB as shown below.

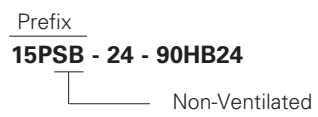
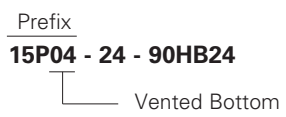

● Green = Fastest shipped items    ● Black = Normal lead-time items    ● Red = Normally long lead-time items

All dimensions in parentheses are millimeters unless otherwise specified.

# Series 1 Steel - Fittings

## Horizontal Bends 90° 60° 45° 30° (HB)

1 pair splice plates with hardware included.

**Bottoms manufactured:**  
**Ladder = 9" Rung Spacing**  
**04 = 4" Rung Spacing**  
**SB = Flat sheet over 12"**  
**Rung Spacing**

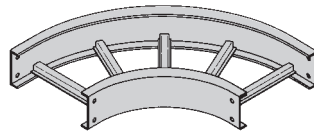

90° Horizontal Bend

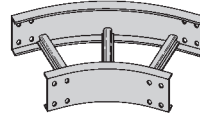

45° Horizontal Bend

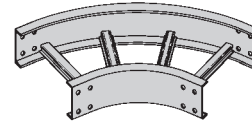

60° Horizontal Bend

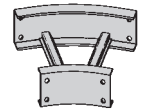

30° Horizontal Bend

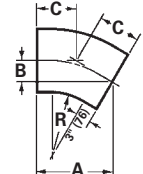
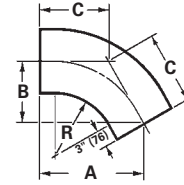
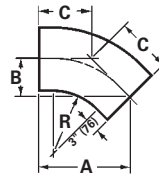
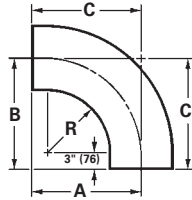

Bend Radius R	Tray Width	90° Horizontal Bend Dimensions				60° Horizontal Bend Dimensions			
		Catalog No.	A	B	C	Catalog No.	A	B	C
in. (mm)	in. (mm)		in. (mm)	in. (mm)	in. (mm)		in. (mm)	in. (mm)	in. (mm)
12 (305)	6 (152)	(Pre)-06-90HB12	18 (457)	18 (457)	18 (457)	(Pre)-06-60HB12	17 <sup>1</sup> / <sub>2</sub> (445)	10 <sup>1</sup> / <sub>8</sub> (257)	11 <sup>11</sup> / <sub>16</sub> (297)
	9 (228)	(Pre)-09-90HB12	19 <sup>1</sup> / <sub>2</sub> (495)	19 <sup>1</sup> / <sub>2</sub> (495)	19 <sup>1</sup> / <sub>2</sub> (495)	(Pre)-09-60HB12	18 <sup>13</sup> / <sub>16</sub> (478)	10 <sup>7</sup> / <sub>8</sub> (276)	12 <sup>1</sup> / <sub>2</sub> (318)
	12 (305)	(Pre)-12-90HB12	21 (533)	21 (533)	21 (533)	(Pre)-12-60HB12	20 <sup>1</sup> / <sub>16</sub> (510)	11 <sup>5</sup> / <sub>8</sub> (295)	13 <sup>3</sup> / <sub>8</sub> (340)
	18 (457)	(Pre)-18-90HB12	24 (610)	24 (610)	24 (610)	(Pre)-18-60HB12	22 <sup>11</sup> / <sub>16</sub> (576)	13 <sup>1</sup> / <sub>8</sub> (333)	15 <sup>1</sup> / <sub>8</sub> (384)
	24 (609)	(Pre)-24-90HB12	27 (686)	27 (686)	27 (686)	(Pre)-24-60HB12	25 <sup>5</sup> / <sub>16</sub> (643)	14 <sup>5</sup> / <sub>8</sub> (372)	16 <sup>7</sup> / <sub>8</sub> (429)
	30 (762)	(Pre)-30-90HB12	30 (762)	30 (762)	30 (762)	(Pre)-30-60HB12	27 <sup>7</sup> / <sub>8</sub> (708)	16 <sup>1</sup> / <sub>8</sub> (410)	18 <sup>9</sup> / <sub>16</sub> (472)
	36 (914)	(Pre)-36-90HB12	33 (838)	33 (838)	33 (838)	(Pre)-36-60HB12	30 <sup>1</sup> / <sub>2</sub> (775)	17 <sup>5</sup> / <sub>8</sub> (448)	20 <sup>5</sup> / <sub>16</sub> (516)
24 (609)	6 (152)	(Pre)-06-90HB24	30 (762)	30 (762)	30 (762)	(Pre)-06-60HB24	27 <sup>7</sup> / <sub>8</sub> (708)	16 <sup>1</sup> / <sub>8</sub> (410)	18 <sup>9</sup> / <sub>16</sub> (472)
	9 (228)	(Pre)-09-90HB24	31 <sup>1</sup> / <sub>2</sub> (800)	31 <sup>1</sup> / <sub>2</sub> (800)	31 <sup>1</sup> / <sub>2</sub> (800)	(Pre)-09-60HB24	29 <sup>3</sup> / <sub>16</sub> (741)	16 <sup>7</sup> / <sub>8</sub> (429)	19 <sup>7</sup> / <sub>16</sub> (494)
	12 (305)	(Pre)-12-90HB24	33 (838)	33 (838)	33 (838)	(Pre)-12-60HB24	30 <sup>1</sup> / <sub>2</sub> (775)	17 <sup>5</sup> / <sub>8</sub> (448)	20 <sup>5</sup> / <sub>16</sub> (516)
	18 (457)	(Pre)-18-90HB24	36 (914)	36 (914)	36 (914)	(Pre)-18-60HB24	33 <sup>1</sup> / <sub>16</sub> (840)	19 <sup>1</sup> / <sub>8</sub> (486)	22 <sup>1</sup> / <sub>16</sub> (560)
	24 (609)	(Pre)-24-90HB24	39 (991)	39 (991)	39 (991)	(Pre)-24-60HB24	35 <sup>11</sup> / <sub>16</sub> (907)	20 <sup>5</sup> / <sub>8</sub> (524)	23 <sup>13</sup> / <sub>16</sub> (605)
	30 (762)	(Pre)-30-90HB24	42 (1067)	42 (1067)	42 (1067)	(Pre)-30-60HB24	38 <sup>1</sup> / <sub>4</sub> (972)	22 <sup>1</sup> / <sub>8</sub> (562)	25 <sup>1</sup> / <sub>2</sub> (648)
	36 (914)	(Pre)-36-90HB24	45 (1143)	45 (1143)	45 (1143)	(Pre)-36-60HB24	40 <sup>7</sup> / <sub>8</sub> (1038)	23 <sup>5</sup> / <sub>8</sub> (600)	27 <sup>1</sup> / <sub>4</sub> (692)
		45° Horizontal Bend				30° Horizontal Bend			
12 (305)	6 (152)	(Pre)-06-45HB12	15 <sup>3</sup> / <sub>4</sub> (400)	6 <sup>1</sup> / <sub>2</sub> (165)	9 <sup>3</sup> / <sub>16</sub> (233)	(Pre)-06-30HB12	13 <sup>1</sup> / <sub>8</sub> (333)	3 <sup>1</sup> / <sub>2</sub> (89)	7 (175)
	9 (228)	(Pre)-09-45HB12	16 <sup>13</sup> / <sub>16</sub> (427)	6 <sup>15</sup> / <sub>16</sub> (176)	9 <sup>13</sup> / <sub>16</sub> (249)	(Pre)-09-30HB12	13 <sup>7</sup> / <sub>8</sub> (352)	3 <sup>11</sup> / <sub>16</sub> (94)	7 <sup>7</sup> / <sub>16</sub> (189)
	12 (305)	(Pre)-12-45HB12	17 <sup>7</sup> / <sub>8</sub> (454)	7 <sup>3</sup> / <sub>8</sub> (187)	10 <sup>7</sup> / <sub>16</sub> (265)	(Pre)-12-30HB12	14 <sup>5</sup> / <sub>8</sub> (372)	3 <sup>15</sup> / <sub>16</sub> (100)	7 <sup>13</sup> / <sub>16</sub> (198)
	18 (457)	(Pre)-18-45HB12	20 (500)	8 <sup>1</sup> / <sub>4</sub> (210)	11 <sup>11</sup> / <sub>16</sub> (297)	(Pre)-18-30HB12	16 <sup>1</sup> / <sub>8</sub> (410)	4 <sup>5</sup> / <sub>16</sub> (135)	8 <sup>5</sup> / <sub>8</sub> (219)
	24 (609)	(Pre)-24-45HB12	22 <sup>1</sup> / <sub>16</sub> (560)	9 <sup>1</sup> / <sub>8</sub> (232)	12 <sup>15</sup> / <sub>16</sub> (329)	(Pre)-24-30HB12	17 <sup>5</sup> / <sub>8</sub> (448)	4 <sup>11</sup> / <sub>16</sub> (119)	9 <sup>7</sup> / <sub>16</sub> (240)
	30 (762)	(Pre)-30-45HB12	24 <sup>3</sup> / <sub>16</sub> (614)	10 (250)	14 <sup>3</sup> / <sub>16</sub> (360)	(Pre)-30-30HB12	19 <sup>1</sup> / <sub>8</sub> (486)	5 <sup>1</sup> / <sub>8</sub> (130)	10 <sup>1</sup> / <sub>4</sub> (260)
	36 (914)	(Pre)-36-45HB12	26 <sup>5</sup> / <sub>16</sub> (668)	10 <sup>15</sup> / <sub>16</sub> (278)	15 <sup>7</sup> / <sub>16</sub> (392)	(Pre)-36-30HB12	20 <sup>5</sup> / <sub>8</sub> (524)	5 <sup>1</sup> / <sub>2</sub> (140)	11 <sup>1</sup> / <sub>16</sub> (281)
24 (609)	6 (152)	(Pre)-06-45HB24	24 <sup>3</sup> / <sub>16</sub> (614)	10 (250)	14 <sup>3</sup> / <sub>16</sub> (360)	(Pre)-06-30HB24	19 <sup>1</sup> / <sub>8</sub> (486)	5 <sup>1</sup> / <sub>8</sub> (130)	10 <sup>1</sup> / <sub>4</sub> (260)
	9 (228)	(Pre)-09-45HB24	25 <sup>1</sup> / <sub>4</sub> (641)	10 <sup>1</sup> / <sub>2</sub> (267)	14 <sup>13</sup> / <sub>16</sub> (376)	(Pre)-09-30HB24	19 <sup>7</sup> / <sub>8</sub> (505)	5 <sup>5</sup> / <sub>16</sub> (135)	10 <sup>5</sup> / <sub>8</sub> (270)
	12 (305)	(Pre)-12-45HB24	26 <sup>5</sup> / <sub>16</sub> (668)	10 <sup>15</sup> / <sub>16</sub> (278)	15 <sup>7</sup> / <sub>16</sub> (392)	(Pre)-12-30HB24	20 <sup>5</sup> / <sub>8</sub> (524)	5 <sup>1</sup> / <sub>2</sub> (140)	11 <sup>1</sup> / <sub>16</sub> (281)
	18 (457)	(Pre)-18-45HB24	28 <sup>7</sup> / <sub>16</sub> (722)	11 <sup>13</sup> / <sub>16</sub> (300)	16 <sup>11</sup> / <sub>16</sub> (424)	(Pre)-18-30HB24	22 <sup>1</sup> / <sub>8</sub> (562)	5 <sup>15</sup> / <sub>16</sub> (151)	11 <sup>13</sup> / <sub>16</sub> (300)
	24 (609)	(Pre)-24-45HB24	30 <sup>9</sup> / <sub>16</sub> (776)	12 <sup>11</sup> / <sub>16</sub> (322)	17 <sup>15</sup> / <sub>16</sub> (456)	(Pre)-24-30HB24	23 <sup>5</sup> / <sub>8</sub> (600)	6 <sup>5</sup> / <sub>16</sub> (160)	12 <sup>5</sup> / <sub>8</sub> (321)
	30 (762)	(Pre)-30-45HB24	32 <sup>11</sup> / <sub>16</sub> (830)	13 <sup>9</sup> / <sub>16</sub> (345)	19 <sup>1</sup> / <sub>8</sub> (486)	(Pre)-30-30HB24	25 <sup>1</sup> / <sub>8</sub> (638)	6 <sup>3</sup> / <sub>4</sub> (172)	13 <sup>7</sup> / <sub>16</sub> (341)
	36 (914)	(Pre)-36-45HB24	34 <sup>13</sup> / <sub>16</sub> (884)	14 <sup>7</sup> / <sub>16</sub> (367)	20 <sup>3</sup> / <sub>8</sub> (518)	(Pre)-36-30HB24	26 <sup>5</sup> / <sub>8</sub> (676)	7 <sup>1</sup> / <sub>8</sub> (181)	14 <sup>1</sup> / <sub>4</sub> (362)

(Pre) See page H-18 for catalog number prefix.

Width dimensions are to inside wall. Manufacturing tolerances apply to all dimensions.

All dimensions in parentheses are millimeters unless otherwise specified.

## Horizontal Tee (HT)

2 pair splice plates with hardware included.

Bend Radius R	Tray Width	Horizontal Tee Dimensions		
		Catalog No.	A	B
in. (mm)	in. (mm)		in. (mm)	in. (mm)
12 (305)	6 (152)	<b>(Prefix)-06-HT12</b>	18 (457)	36 (914)
	9 (228)	<b>(Prefix)-09-HT12</b>	19 <sup>1</sup> / <sub>2</sub> (495)	39 (991)
	12 (305)	<b>(Prefix)-12-HT12</b>	21 (533)	42 (1067)
	18 (457)	<b>(Prefix)-18-HT12</b>	24 (610)	48 (1219)
	24 (609)	<b>(Prefix)-24-HT12</b>	27 (686)	54 (1372)
	30 (762)	<b>(Prefix)-30-HT12</b>	30 (762)	60 (1524)
24 (609)	36 (914)	<b>(Prefix)-36-HT12</b>	33 (838)	66 (1676)
	6 (152)	<b>(Prefix)-06-HT24</b>	30 (762)	60 (1524)
	9 (228)	<b>(Prefix)-09-HT24</b>	31 <sup>1</sup> / <sub>2</sub> (800)	63 (1600)
	12 (305)	<b>(Prefix)-12-HT24</b>	33 (838)	66 (1676)
	18 (457)	<b>(Prefix)-18-HT24</b>	36 (914)	72 (1829)
	24 (609)	<b>(Prefix)-24-HT24</b>	39 (991)	78 (1981)
	30 (762)	<b>(Prefix)-30-HT24</b>	42 (1067)	84 (2134)
	36 (914)	<b>(Prefix)-36-HT24</b>	45 (1143)	90 (2286)

(Prefix) See page H-18 for catalog number prefix.

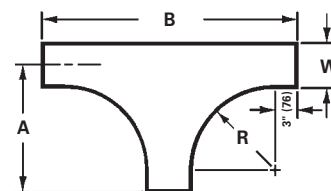
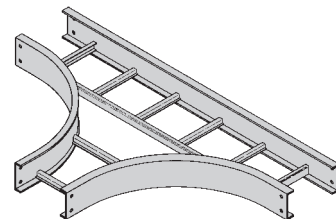

## Horizontal Cross (HX)

3 pair splice plates with hardware included.

Bend Radius R	Tray Width	Horizontal Cross Dimensions		
		Catalog No.	A	B
in. (mm)	in. (mm)		in. (mm)	in. (mm)
12 (305)	6 (152)	<b>(Prefix)-06-HX12</b>	18 (457)	36 (914)
	9 (228)	<b>(Prefix)-09-HX12</b>	19 <sup>1</sup> / <sub>2</sub> (495)	39 (991)
	12 (305)	<b>(Prefix)-12-HX12</b>	21 (533)	42 (1067)
	18 (457)	<b>(Prefix)-18-HX12</b>	24 (610)	48 (1219)
	24 (609)	<b>(Prefix)-24-HX12</b>	27 (686)	54 (1372)
	30 (762)	<b>(Prefix)-30-HX12</b>	30 (762)	60 (1524)
24 (609)	36 (914)	<b>(Prefix)-36-HX12</b>	33 (838)	66 (1676)
	6 (152)	<b>(Prefix)-06-HX24</b>	30 (762)	60 (1524)
	9 (228)	<b>(Prefix)-09-HX24</b>	31 <sup>1</sup> / <sub>2</sub> (800)	63 (1600)
	12 (305)	<b>(Prefix)-12-HX24</b>	33 (838)	66 (1676)
	18 (457)	<b>(Prefix)-18-HX24</b>	36 (914)	72 (1829)
	24 (609)	<b>(Prefix)-24-HX24</b>	39 (991)	78 (1981)
	30 (762)	<b>(Prefix)-30-HX24</b>	42 (1067)	84 (2134)
	36 (914)	<b>(Prefix)-36-HX24</b>	45 (1143)	90 (2286)

(Prefix) See page H-18 for catalog number prefix.

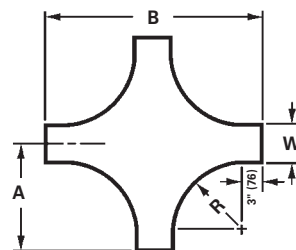
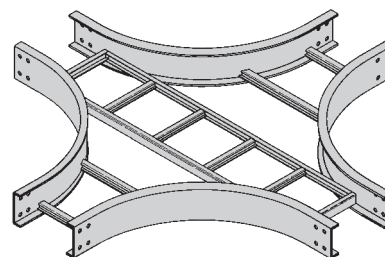

Width dimensions are to inside wall. Manufacturing tolerances apply to all dimensions.

All dimensions in parentheses are millimeters unless otherwise specified.

# Series 1 Steel - Fittings

## Reducers (LR, SR, RR)

1 pair splice plates with hardware included.

### Reducer Part Numbering

14P - 24 - RR 18

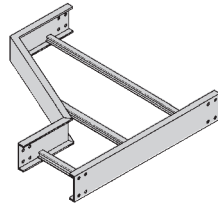
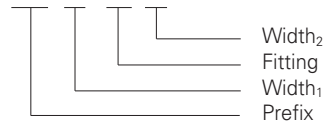

Left Reducer - LR

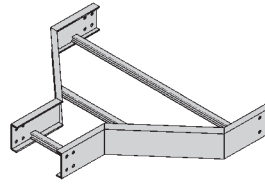

Straight Reducer - SR

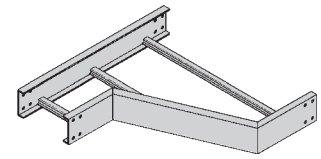

Right Reducer - RR

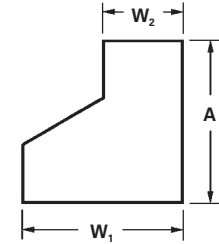
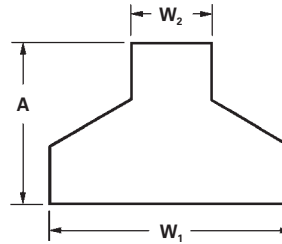
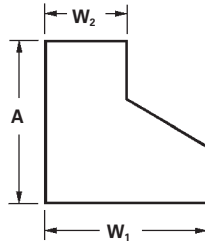

Tray Width		Left Reducer - LR		Straight Reducer - SR		Right Reducer - RR	
W <sub>1</sub>	W <sub>2</sub>	Catalog No.	A	Catalog No.	A	Catalog No.	A
in. (mm)	in. (mm)		in. (mm)		in. (mm)		in. (mm)
9 (228)	6 (152)	(Prefix)-09-LR06	9 <sup>3</sup> / <sub>4</sub> (248)	(Prefix)-09-SR06	8 <sup>7</sup> / <sub>8</sub> (225)	(Prefix)-09-RR06	9 <sup>3</sup> / <sub>4</sub> (248)
12 (305)	6 (152)	(Prefix)-12-LR06	11 <sup>1</sup> / <sub>2</sub> (292)	(Prefix)-12-SR06	9 <sup>3</sup> / <sub>4</sub> (248)	(Prefix)-12-RR06	11 <sup>1</sup> / <sub>2</sub> (292)
	9 (228)	(Prefix)-12-LR09	9 <sup>3</sup> / <sub>4</sub> (248)	(Prefix)-12-SR09	8 <sup>7</sup> / <sub>8</sub> (225)	(Prefix)-12-RR09	9 <sup>3</sup> / <sub>4</sub> (248)
18 (457)	6 (152)	(Prefix)-18-LR06	14 <sup>15</sup> / <sub>16</sub> (379)	(Prefix)-18-SR06	11 <sup>1</sup> / <sub>2</sub> (292)	(Prefix)-18-RR06	14 <sup>15</sup> / <sub>16</sub> (379)
	9 (228)	(Prefix)-18-LR09	13 <sup>3</sup> / <sub>16</sub> (335)	(Prefix)-18-SR09	10 <sup>5</sup> / <sub>8</sub> (270)	(Prefix)-18-RR09	13 <sup>3</sup> / <sub>16</sub> (335)
	12 (305)	(Prefix)-18-LR12	11 <sup>1</sup> / <sub>2</sub> (292)	(Prefix)-18-SR12	9 <sup>3</sup> / <sub>4</sub> (248)	(Prefix)-18-RR12	11 <sup>1</sup> / <sub>2</sub> (292)
24 (609)	6 (152)	(Prefix)-24-LR06	18 <sup>3</sup> / <sub>8</sub> (467)	(Prefix)-24-SR06	13 <sup>3</sup> / <sub>16</sub> (335)	(Prefix)-24-RR06	18 <sup>3</sup> / <sub>8</sub> (467)
	9 (228)	(Prefix)-24-LR09	16 <sup>11</sup> / <sub>16</sub> (424)	(Prefix)-24-SR09	12 <sup>3</sup> / <sub>8</sub> (314)	(Prefix)-24-RR09	16 <sup>11</sup> / <sub>16</sub> (424)
	12 (305)	(Prefix)-24-LR12	14 <sup>15</sup> / <sub>16</sub> (379)	(Prefix)-24-SR12	11 <sup>1</sup> / <sub>2</sub> (292)	(Prefix)-24-RR12	14 <sup>15</sup> / <sub>16</sub> (379)
	18 (457)	(Prefix)-24-LR18	11 <sup>1</sup> / <sub>2</sub> (292)	(Prefix)-24-SR18	9 <sup>3</sup> / <sub>4</sub> (248)	(Prefix)-24-RR18	11 <sup>1</sup> / <sub>2</sub> (292)
30 (762)	6 (152)	(Prefix)-30-LR06	21 <sup>7</sup> / <sub>8</sub> (555)	(Prefix)-30-SR06	14 <sup>15</sup> / <sub>16</sub> (379)	(Prefix)-30-RR06	21 <sup>7</sup> / <sub>8</sub> (555)
	9 (228)	(Prefix)-30-LR09	20 <sup>1</sup> / <sub>8</sub> (511)	(Prefix)-30-SR09	14 <sup>1</sup> / <sub>16</sub> (358)	(Prefix)-30-RR09	20 <sup>1</sup> / <sub>8</sub> (511)
	12 (305)	(Prefix)-30-LR12	18 <sup>3</sup> / <sub>8</sub> (467)	(Prefix)-30-SR12	13 <sup>3</sup> / <sub>16</sub> (335)	(Prefix)-30-RR12	18 <sup>3</sup> / <sub>8</sub> (467)
	18 (457)	(Prefix)-30-LR18	14 <sup>15</sup> / <sub>16</sub> (379)	(Prefix)-30-SR18	11 <sup>1</sup> / <sub>2</sub> (292)	(Prefix)-30-RR18	14 <sup>15</sup> / <sub>16</sub> (379)
	24 (609)	(Prefix)-30-LR24	11 <sup>1</sup> / <sub>2</sub> (292)	(Prefix)-30-SR24	9 <sup>3</sup> / <sub>4</sub> (248)	(Prefix)-30-RR24	11 <sup>1</sup> / <sub>2</sub> (292)
36 (914)	6 (152)	(Prefix)-36-LR06	25 <sup>5</sup> / <sub>16</sub> (643)	(Prefix)-36-SR06	16 <sup>11</sup> / <sub>16</sub> (424)	(Prefix)-36-RR06	23 <sup>5</sup> / <sub>16</sub> (643)
	9 (228)	(Prefix)-36-LR09	23 <sup>9</sup> / <sub>16</sub> (598)	(Prefix)-36-SR09	15 <sup>13</sup> / <sub>16</sub> (402)	(Prefix)-36-RR09	23 <sup>9</sup> / <sub>16</sub> (598)
	12 (305)	(Prefix)-36-LR12	21 <sup>7</sup> / <sub>8</sub> (555)	(Prefix)-36-SR12	14 <sup>15</sup> / <sub>16</sub> (379)	(Prefix)-36-RR12	21 <sup>7</sup> / <sub>8</sub> (555)
	18 (457)	(Prefix)-36-LR18	18 <sup>3</sup> / <sub>8</sub> (467)	(Prefix)-36-SR18	13 <sup>3</sup> / <sub>16</sub> (335)	(Prefix)-36-RR18	18 <sup>3</sup> / <sub>8</sub> (467)
	24 (609)	(Prefix)-36-LR24	14 <sup>15</sup> / <sub>16</sub> (379)	(Prefix)-36-SR24	11 <sup>1</sup> / <sub>2</sub> (292)	(Prefix)-36-RR24	14 <sup>15</sup> / <sub>16</sub> (379)
	30 (762)	(Prefix)-36-LR30	11 <sup>1</sup> / <sub>2</sub> (292)	(Prefix)-36-SR30	9 <sup>3</sup> / <sub>4</sub> (248)	(Prefix)-36-RR30	11 <sup>1</sup> / <sub>2</sub> (292)

(Prefix) See page H-18 for catalog number prefix.

Width dimensions are to inside wall. Manufacturing tolerances apply to all dimensions.

All dimensions in parentheses are millimeters unless otherwise specified.

## Vertical Bend 90° (VO, VI)

1 pair splice plates with hardware included.

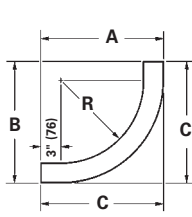

90° Vertical Inside

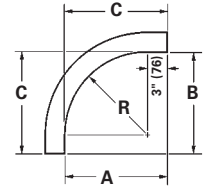
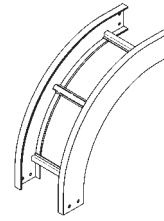
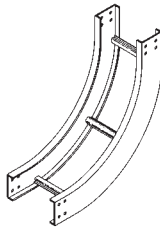

90° Vertical Outside

### 90° Vertical Inside Bend (VI)

Bend Radius R in. (mm)	Width in. (mm)	Catalog No.	VI Dimensions [in. (mm)]											
			Series 14 Steel			Series 15 Steel			Series 16 Steel			Series 17 Steel		
			A	B	C	A	B	C	A	B	C	A	B	C
12 (305)	6 (152)	(Pre)-06-90VI12												
	9 (228)	(Pre)-09-90VI12												
	12 (305)	(Pre)-12-90VI12												
	18 (457)	(Pre)-18-90VI12	18 <sup>7</sup> / <sub>16</sub> (468)	18 <sup>7</sup> / <sub>16</sub> (468)	18 <sup>7</sup> / <sub>16</sub> (468)	19 <sup>3</sup> / <sub>16</sub> (487)	19 <sup>3</sup> / <sub>16</sub> (487)	19 <sup>3</sup> / <sub>16</sub> (487)	20 <sup>3</sup> / <sub>16</sub> (513)	20 <sup>3</sup> / <sub>16</sub> (513)	20 <sup>3</sup> / <sub>16</sub> (513)	21 <sup>3</sup> / <sub>16</sub> (538)	21 <sup>3</sup> / <sub>16</sub> (538)	21 <sup>3</sup> / <sub>16</sub> (538)
	24 (609)	(Pre)-24-90VI12												
	30 (762)	(Pre)-30-90VI12												
24 (609)	6 (152)	(Pre)-06-90VI24												
	9 (228)	(Pre)-09-90VI24												
	12 (305)	(Pre)-12-90VI24												
	18 (457)	(Pre)-18-90VI24	30 <sup>7</sup> / <sub>16</sub> (773)	30 <sup>7</sup> / <sub>16</sub> (773)	30 <sup>7</sup> / <sub>16</sub> (773)	31 <sup>3</sup> / <sub>16</sub> (792)	31 <sup>3</sup> / <sub>16</sub> (792)	31 <sup>3</sup> / <sub>16</sub> (792)	32 <sup>3</sup> / <sub>16</sub> (817)	32 <sup>3</sup> / <sub>16</sub> (817)	32 <sup>3</sup> / <sub>16</sub> (817)	33 <sup>3</sup> / <sub>16</sub> (843)	33 <sup>3</sup> / <sub>16</sub> (843)	33 <sup>3</sup> / <sub>16</sub> (843)
	24 (609)	(Pre)-24-90VI24												
	30 (762)	(Pre)-30-90VI24												
36 (914)	(Pre)-36-90VI24													

### 90° Vertical Outside Bend (VO)

Bend Radius R in. (mm)	Width in. (mm)	Catalog No.	VO Dimensions [in. (mm)]		
			All Series 1		
			A	B	C
12 (305)	6 (152)	(Pre)-06-90VO12			
	9 (228)	(Pre)-09-90VO12			
	12 (305)	(Pre)-12-90VO12			
	18 (457)	(Pre)-18-90VO12	15 (381)	15 (381)	15 (381)
	24 (609)	(Pre)-24-90VO12			
	30 (762)	(Pre)-30-90VO12			
24 (609)	6 (152)	(Pre)-06-90VO24			
	9 (228)	(Pre)-09-90VO24			
	12 (305)	(Pre)-12-90VO24			
	18 (457)	(Pre)-18-90VO24	27 (686)	27 (686)	27 (686)
	24 (609)	(Pre)-24-90VO24			
	30 (762)	(Pre)-30-90VO24			
36 (914)	(Pre)-36-90VO24				

(Pre) See page H-18 for catalog number prefix.

Manufacturing tolerances apply to all dimensions.

All dimensions in parentheses are millimeters unless otherwise specified.

# Series 1 Steel - Fittings

## Vertical Bend 60° (VO, VI)

1 pair splice plates with hardware included.

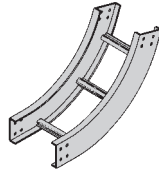
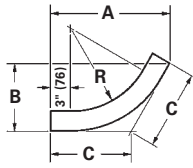

60° Vertical Inside

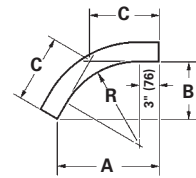
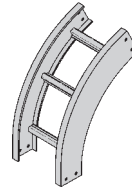

60° Vertical Outside

### 60° Vertical Inside Bend (VI)

Bend Radius R in. (mm)	Width in. (mm)	Catalog No.	VI Dimensions [in. (mm)]											
			Series 14 Steel			Series 15 Steel			Series 16 Steel			Series 17 Steel		
			A	B	C	A	B	C	A	B	C	A	B	C
12 (305)	6 (152)	(Pre)-06-60VI12												
	9 (228)	(Pre)-09-60VI12												
	12 (305)	(Pre)-12-60VI12												
	18 (457)	(Pre)-18-60VI12	18 <sup>1</sup> / <sub>16</sub> (459)	10 <sup>7</sup> / <sub>16</sub> (265)	12 (305)	18 <sup>1</sup> / <sub>2</sub> (470)	10 <sup>11</sup> / <sub>16</sub> (271)	12 <sup>3</sup> / <sub>8</sub> (314)	19 <sup>3</sup> / <sub>8</sub> (492)	11 <sup>3</sup> / <sub>16</sub> (284)	12 <sup>15</sup> / <sub>16</sub> (328)	20 <sup>1</sup> / <sub>4</sub> (514)	11 <sup>11</sup> / <sub>16</sub> (297)	13 <sup>1</sup> / <sub>2</sub> (343)
	24 (609)	(Pre)-24-60VI12												
	30 (762)	(Pre)-30-60VI12												
24 (609)	6 (152)	(Pre)-06-60VI24												
	9 (228)	(Pre)-09-60VI24												
	12 (305)	(Pre)-12-60VI24												
	18 (457)	(Pre)-18-60VI24	28 <sup>7</sup> / <sub>16</sub> (722)	16 <sup>7</sup> / <sub>16</sub> (417)	18 <sup>15</sup> / <sub>16</sub> (481)	28 <sup>15</sup> / <sub>16</sub> (735)	18 <sup>11</sup> / <sub>16</sub> (424)	19 <sup>1</sup> / <sub>4</sub> (489)	29 <sup>3</sup> / <sub>4</sub> (755)	17 <sup>3</sup> / <sub>16</sub> (436)	19 <sup>7</sup> / <sub>8</sub> (505)	30 <sup>5</sup> / <sub>8</sub> (778)	17 <sup>11</sup> / <sub>16</sub> (449)	20 <sup>7</sup> / <sub>16</sub> (519)
	24 (609)	(Pre)-24-60VI24												
	30 (762)	(Pre)-30-60VI24												
36 (914)	(Pre)-36-60VI24													

### 60° Vertical Outside Bend (VO)

Bend Radius R in. (mm)	Width in. (mm)	Catalog No.	VO Dimensions [in. (mm)]		
			All Series 1		
			A	B	C
12 (305)	6 (152)	(Pre)-06-60VO12			
	9 (228)	(Pre)-09-60VO12			
	12 (305)	(Pre)-12-60VO12			
	18 (457)	(Pre)-18-60VO12	14 <sup>7</sup> / <sub>8</sub> (378)	8 <sup>5</sup> / <sub>8</sub> (219)	9 <sup>15</sup> / <sub>16</sub> (252)
	24 (609)	(Pre)-24-60VO12			
	30 (762)	(Pre)-30-60VO12			
24 (609)	6 (152)	(Pre)-06-60VO24			
	9 (228)	(Pre)-09-60VO24			
	12 (305)	(Pre)-12-60VO24			
	18 (457)	(Pre)-18-60VO24	25 <sup>5</sup> / <sub>16</sub> (643)	14 <sup>5</sup> / <sub>8</sub> (371)	16 <sup>7</sup> / <sub>8</sub> (428)
	24 (609)	(Pre)-24-60VO24			
	30 (762)	(Pre)-30-60VO24			
36 (914)	(Pre)-36-60VO24				

(Pre) See page H-18 for catalog number prefix.  
Manufacturing tolerances apply to all dimensions.

All dimensions in parentheses are millimeters unless otherwise specified.

## Vertical Bend 45° (VO, VI)

1 pair splice plates with hardware included.

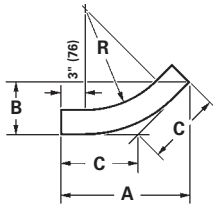

45° Vertical Inside

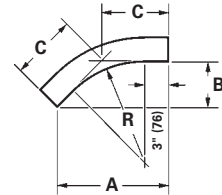
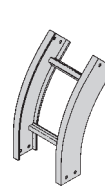
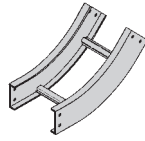

45° Vertical Outside

### 45° Vertical Inside Bend (VI)

Bend Radius R in. (mm)	Width in. (mm)	Catalog No.	VI Dimensions [in. (mm)]											
			Series 14 Steel			Series 15 Steel			Series 16 Steel			Series 17 Steel		
			A	B	C	A	B	C	A	B	C	A	B	C
12 (305)	6 (152)	(Pre)-06-45VI12	16 <sup>3</sup> / <sub>16</sub> (411)	6 <sup>1</sup> / <sub>16</sub> (170)	9 <sup>1</sup> / <sub>2</sub> (241)	16 <sup>9</sup> / <sub>16</sub> (420)	6 <sup>7</sup> / <sub>8</sub> (174)	9 <sup>1</sup> / <sub>16</sub> (246)	17 <sup>1</sup> / <sub>4</sub> (438)	7 <sup>3</sup> / <sub>16</sub> (182)	10 <sup>1</sup> / <sub>8</sub> (257)	18 (457)	7 <sup>7</sup> / <sub>16</sub> (189)	10 <sup>9</sup> / <sub>16</sub> (268)
	9 (228)	(Pre)-09-45VI12												
	12 (305)	(Pre)-12-45VI12												
	18 (457)	(Pre)-18-45VI12												
	24 (609)	(Pre)-24-45VI12												
	30 (762)	(Pre)-30-45VI12												
36 (914)	(Pre)-36-45VI12													
24 (609)	6 (152)	(Pre)-06-45VI24	24 <sup>1</sup> / <sub>16</sub> (627)	10 <sup>3</sup> / <sub>16</sub> (259)	14 <sup>7</sup> / <sub>16</sub> (367)	25 <sup>1</sup> / <sub>16</sub> (792)	10 <sup>3</sup> / <sub>8</sub> (792)	14 <sup>1</sup> / <sub>16</sub> (373)	25 <sup>3</sup> / <sub>4</sub> (654)	10 <sup>1</sup> / <sub>16</sub> (271)	15 <sup>1</sup> / <sub>16</sub> (382)	26 <sup>1</sup> / <sub>2</sub> (673)	11 (279)	15 <sup>1</sup> / <sub>2</sub> (394)
	9 (228)	(Pre)-09-45VI24												
	12 (305)	(Pre)-12-45VI24												
	18 (457)	(Pre)-18-45VI24												
	24 (609)	(Pre)-24-45VI24												
	30 (762)	(Pre)-30-45VI24												
36 (914)	(Pre)-36-45VI24													

### 45° Vertical Outside Bend (VO)

Bend Radius R in. (mm)	Width in. (mm)	Catalog No.	VO Dimensions [in. (mm)]		
			All Series 1		
			A	B	C
12 (305)	6 (152)	(Pre)-06-45VO12	13 <sup>5</sup> / <sub>8</sub> (346)	5 <sup>5</sup> / <sub>8</sub> (143)	8 (203)
	9 (228)	(Pre)-09-45VO12			
	12 (305)	(Pre)-12-45VO12			
	18 (457)	(Pre)-18-45VO12			
	24 (609)	(Pre)-24-45VO12			
	30 (762)	(Pre)-30-45VO12			
36 (914)	(Pre)-36-45VO12				
24 (609)	6 (152)	(Pre)-06-45VO24	22 <sup>1</sup> / <sub>16</sub> (560)	9 <sup>1</sup> / <sub>8</sub> (232)	12 <sup>15</sup> / <sub>16</sub> (328)
	9 (228)	(Pre)-09-45VO24			
	12 (305)	(Pre)-12-45VO24			
	18 (457)	(Pre)-18-45VO24			
	24 (609)	(Pre)-24-45VO24			
	30 (762)	(Pre)-30-45VO24			
36 (914)	(Pre)-36-45VO24				

(Pre) See page H-18 for catalog number prefix.

Manufacturing tolerances apply to all dimensions.

All dimensions in parentheses are millimeters unless otherwise specified.



# Series 1 Steel - Fittings

## Vertical Bend 30° (VO, VI)

1 pair splice plates with hardware included.

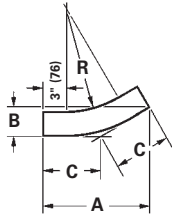

30° Vertical Inside

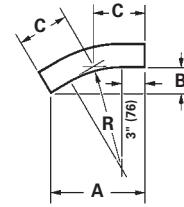
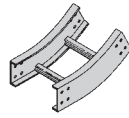

30° Vertical Outside

### 30° Vertical Inside Bend (VI)

Bend Radius R in. (mm)	Width in. (mm)	Catalog No.	VI Dimensions [in. (mm)]											
			Series 14 Steel			Series 15 Steel			Series 16 Steel			Series 17 Steel		
			A	B	C	A	B	C	A	B	C	A	B	C
12 (305)	6 (152)	(Pre)-06-30VI12												
	9 (228)	(Pre)-09-30VI12												
	12 (305)	(Pre)-12-30VI12												
	18 (457)	(Pre)-18-30VI12	13 <sup>7</sup> / <sub>16</sub> (341)	3 <sup>5</sup> / <sub>8</sub> (92)	7 <sup>3</sup> / <sub>16</sub> (182)	13 <sup>11</sup> / <sub>16</sub> (347)	3 <sup>11</sup> / <sub>16</sub> (93)	7 <sup>5</sup> / <sub>16</sub> (186)	14 <sup>3</sup> / <sub>16</sub> (360)	3 <sup>13</sup> / <sub>16</sub> (97)	7 <sup>5</sup> / <sub>8</sub> (193)	14 <sup>11</sup> / <sub>16</sub> (373)	3 <sup>15</sup> / <sub>16</sub> (100)	7 <sup>7</sup> / <sub>8</sub> (200)
	24 (609)	(Pre)-24-30VI12												
	30 (762)	(Pre)-30-30VI12												
24 (609)	6 (152)	(Pre)-06-30VI24												
	9 (228)	(Pre)-09-30VI24												
	12 (305)	(Pre)-12-30VI24												
	18 (457)	(Pre)-18-30VI24	19 <sup>7</sup> / <sub>16</sub> (494)	5 <sup>3</sup> / <sub>16</sub> (132)	10 <sup>7</sup> / <sub>16</sub> (265)	19 <sup>11</sup> / <sub>16</sub> (500)	5 <sup>5</sup> / <sub>16</sub> (135)	10 <sup>9</sup> / <sub>16</sub> (268)	20 <sup>3</sup> / <sub>16</sub> (513)	5 <sup>7</sup> / <sub>16</sub> (138)	10 <sup>13</sup> / <sub>16</sub> (274)	20 <sup>11</sup> / <sub>16</sub> (525)	5 <sup>9</sup> / <sub>16</sub> (141)	11 <sup>1</sup> / <sub>16</sub> (281)
	24 (609)	(Pre)-24-30VI24												
	30 (762)	(Pre)-30-30VI24												
36 (914)	(Pre)-36-30VI24													

### 30° Vertical Outside Bend (VO)

Bend Radius R in. (mm)	Width in. (mm)	Catalog No.	VO Dimensions [in. (mm)]		
			All Series 1		
			A	B	C
12 (305)	6 (152)	(Pre)-06-30VO12			
	9 (228)	(Pre)-09-30VO12			
	12 (305)	(Pre)-12-30VO12			
	18 (457)	(Pre)-18-30VO12	11 <sup>5</sup> / <sub>8</sub> (295)	3 <sup>1</sup> / <sub>8</sub> (79)	6 <sup>3</sup> / <sub>16</sub> (157)
	24 (609)	(Pre)-24-30VO12			
	30 (762)	(Pre)-30-30VO12			
24 (609)	6 (152)	(Pre)-06-30VO24			
	9 (228)	(Pre)-09-30VO24			
	12 (305)	(Pre)-12-30VO24			
	18 (457)	(Pre)-18-30VO24	17 <sup>5</sup> / <sub>8</sub> (448)	4 <sup>11</sup> / <sub>16</sub> (119)	9 <sup>7</sup> / <sub>16</sub> (240)
	24 (609)	(Pre)-24-30VO24			
	30 (762)	(Pre)-30-30VO24			
36 (914)	(Pre)-36-30VO24				

(Pre) See page H-18 for catalog number prefix.  
Manufacturing tolerances apply to all dimensions.

All dimensions in parentheses are millimeters unless otherwise specified.

## Vertical Bend Segments (VBS)

Adjustable Vertical Bends are made up of one or more vertical bend segments and can be used as a vertical inside (VI) or vertical outside (VO) bend. This design provides for vertical changes in direction with angles 45°, 60° and 90° for 12" (305 mm) or 24" (609 mm) radius. The chart below shows the number of segments required for the various combinations of angles and radii. The VBS-1, VBS-2 and VBS-3 include one, two or three segments respectively with splice plates and hardware. Holes for setting standard angles are pre-punched in each segment. Other angles can be set by field drilling another hole for the locking bolt.

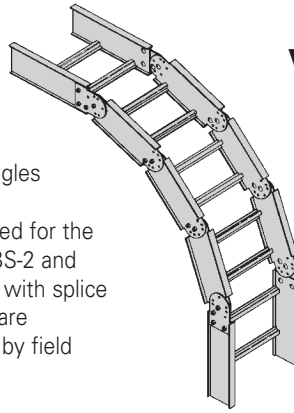

Available for **148P** and **148G** only.

Nominal Bend Radius in. (mm)	Catalog No.	Dimensions					
		VO			VI		
		A in. (mm)	B in. (mm)	R in. (mm)	A in. (mm)	B in. (mm)	R in. (mm)
<b>90° Vertical Inside or Outside</b>							
12 (305)	<b>14(*)†-(‡)-VBS-1</b>	8 <sup>1</sup> / <sub>4</sub> (210)	8 <sup>1</sup> / <sub>4</sub> (210)	6 <sup>1</sup> / <sub>2</sub> (165)	12 <sup>1</sup> / <sub>8</sub> (303)	12 <sup>1</sup> / <sub>8</sub> (303)	10 <sup>1</sup> / <sub>2</sub> (267)
24 (609)	<b>14(*)†-(‡)-VBS-3</b>	24 (610)	24 (610)	22 <sup>1</sup> / <sub>4</sub> (565)	27 <sup>7</sup> / <sub>8</sub> (708)	27 <sup>7</sup> / <sub>8</sub> (708)	26 <sup>1</sup> / <sub>4</sub> (667)
<b>60° Vertical Inside or Outside</b>							
12 (305)	<b>14(*)†-(‡)-VBS-1</b>	11 <sup>3</sup> / <sub>4</sub> (298)	6 <sup>1</sup> / <sub>2</sub> (165)	12 (305)	14 <sup>3</sup> / <sub>4</sub> (375)	8 <sup>1</sup> / <sub>2</sub> (216)	16 (406)
24 (609)	<b>14(*)†-(‡)-VBS-2</b>	11 <sup>3</sup> / <sub>4</sub> (298)	6 <sup>1</sup> / <sub>2</sub> (165)	12 (305)	14 <sup>3</sup> / <sub>4</sub> (375)	8 <sup>1</sup> / <sub>2</sub> (216)	16 (406)
<b>45° Vertical Inside or Outside</b>							
12 (305)	<b>14(*)†-(‡)-VBS-1</b>	12 <sup>3</sup> / <sub>4</sub> (324)	5 <sup>1</sup> / <sub>4</sub> (133)	17 <sup>1</sup> / <sub>8</sub> (435)	15 <sup>1</sup> / <sub>2</sub> (394)	6 <sup>7</sup> / <sub>8</sub> (175)	21 (540)
24 (609)	<b>14(*)†-(‡)-VBS-1</b>	12 <sup>3</sup> / <sub>4</sub> (324)	5 <sup>1</sup> / <sub>4</sub> (133)	17 <sup>1</sup> / <sub>8</sub> (435)	15 <sup>1</sup> / <sub>2</sub> (394)	6 <sup>7</sup> / <sub>8</sub> (175)	21 (540)

### Notes:

- (\*) Insert material type: P=Pre Galvanized, G=HDGAF
- (†) Contact home office for information on Ventilated Trough and Solid Trough availability
- (‡) Insert width 6, 9, 12, 18, 24, 30, 36

### Fitting Hole Pattern

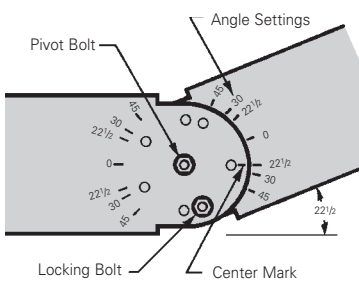

### Setting the Angle

To find correct angle setting, divide angle of offset by the number of segments plus one. The result is equal to the angle setting stamped on the vertical bend segment and the splice plate. After inserting center pivot bolt, align the mark at the end of the segment or splice plate with the angle and insert locking bolt in the pre-punched hole.

**Example:** 90° bend, 24" radius requires 3 segments  
 $3 \text{ segments} + 1 = 4$   
 $90^\circ \text{ divided by } 4 = 22\frac{1}{2}^\circ$   
 Set all vertical segments at  $22\frac{1}{2}^\circ$

### Offset Dimensions

One vertical bend segment can be used to complete a vertical offset. Offset dimensions are shown.

Angle ∅	A in. (mm)	B in. (mm)
45°	12 (305)	8 <sup>1</sup> / <sub>2</sub> (216)
30°	14 (355)	5 <sup>3</sup> / <sub>4</sub> (146)
22 <sup>1</sup> / <sub>2</sub> °	14 <sup>1</sup> / <sub>4</sub> (362)	5 (127)

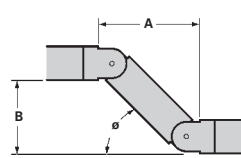

### VBS-1 (1 Segment)

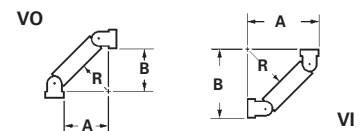

### VBS-2 (2 Segments)

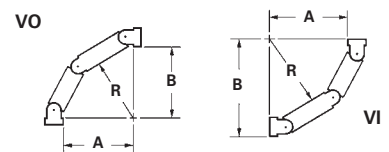

### VBS-3 (3 Segments)

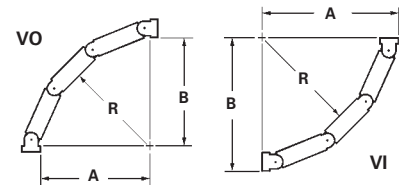

● Green = Fastest shipped items   ● Black = Normal lead-time items   ● Red = Normally long lead-time items

All dimensions in parentheses are millimeters unless otherwise specified.

# Series 2, 3, 4, & 5 Aluminum - Straight Sections



Series 2, 3, 4, & 5 Aluminum

For Aluminum Fittings  
see fittings section pages  
L-1 thru L-17

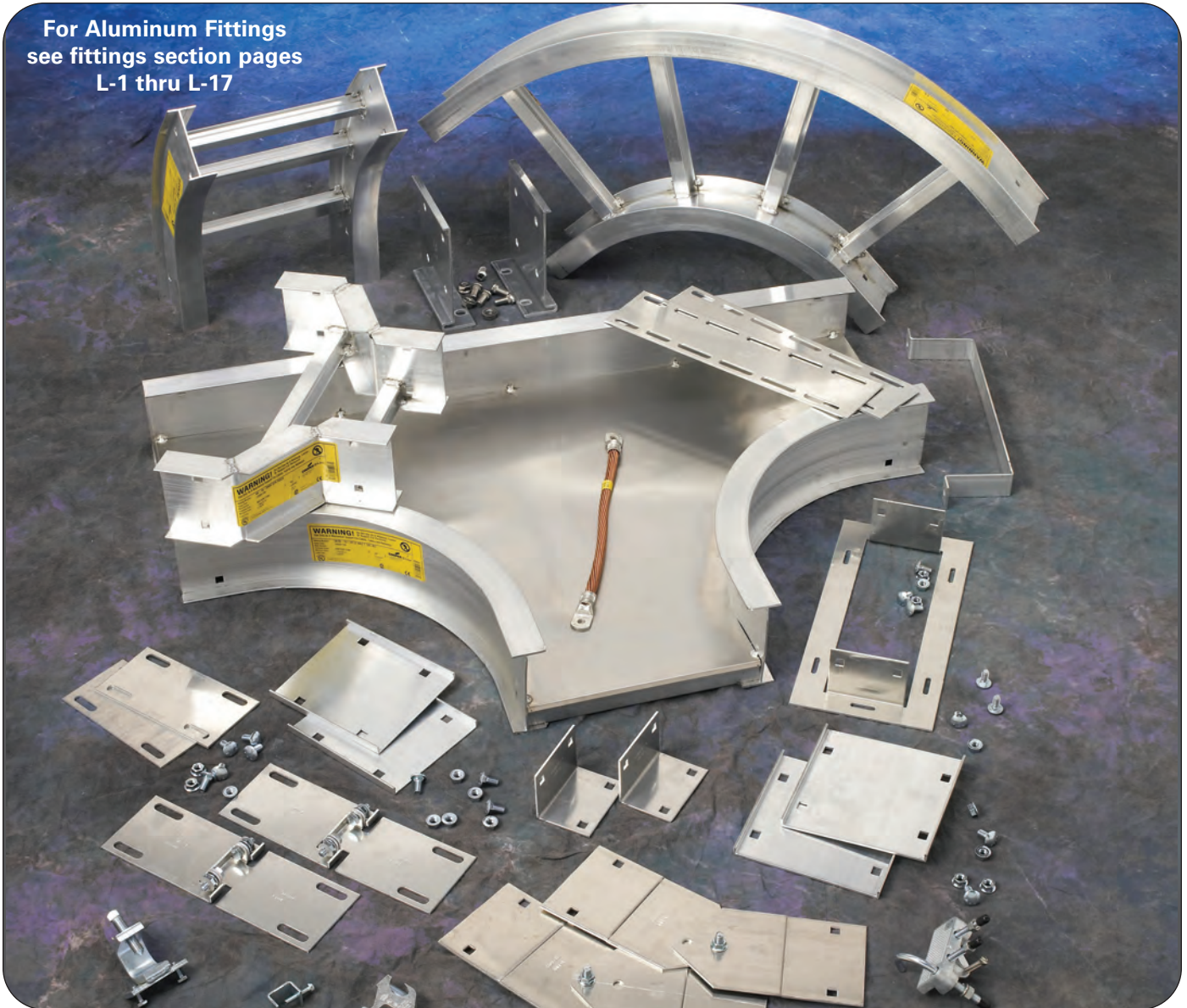

## How The Service Advisor Works

We know that your time is important! That's why the color-coding system in this catalog is designed to help you select products that fit your service needs. Products are marked to indicate the typical lead time for orders of 50 pieces or less.

**Customer:** How do I select my straight sections, covers, or fittings so that I get the quickest turnaround?

**Service Advisor:** Each part of our selection chart is shown in colors. If any section of a part number is a different color, the part will typically ship with the longer lead time represented by the colors.

- Green = Fastest shipped items
- Black = Normal lead-time items
- Red = Normally long lead-time items

**Example:**            34A    VT   -   24   -   144  
                             ●        ●        ●        ●

**Part will have a normal lead time because of the VT bottom type.**

## 3" NEMA VE 1 Loading Depth 4" Side Rail Height

### Straight Section Part Numbering

Example: <sup>Prefix</sup> **24 A 09 - 24 - 144**

#### Series

● **24**

● **H24**

● **34**

#### Material

● **A** = Aluminum

#### \*Type

##### Ladder-

- **06** = 6" rung spacing
- **09** = 9" rung spacing
- **12** = 12" rung spacing

##### Trough-

6" thru 36" wide

- **VT** = Ventilated Trough
- **ST** = Non-Ventilated Trough

#### \*Width

- **06** = 6"
- **09** = 9"
- **12** = 12"
- **18** = 18"
- **24** = 24"
- **30** = 30"
- **36** = 36"

#### Length

- ① **144** = 12 ft.      24
- ② **120** = 10 ft.      H24
- ① **240** = 20 ft.      H24
- ② **144** = 12 ft.      H24
- ① **240** = 20 ft.      34
- ② **144** = 12 ft.      34

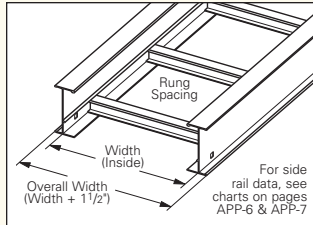

① Primary Length.

② Secondary Length.

See page C-23 for explanation of lengths.

See page APP-1 for additional rung options. \*Special sizes available.

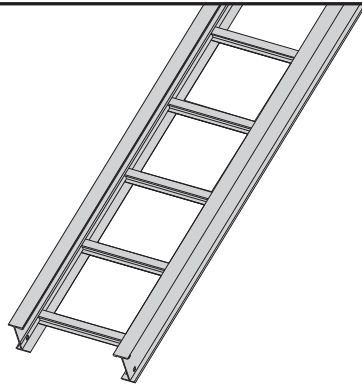

Ladder Type  
(Specify Rung Spacing)

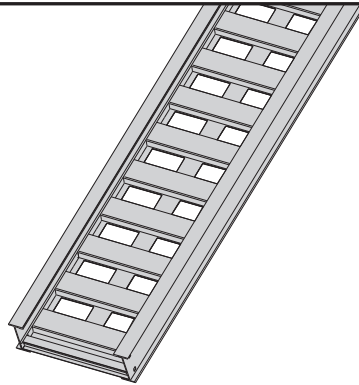

Ventilated Trough

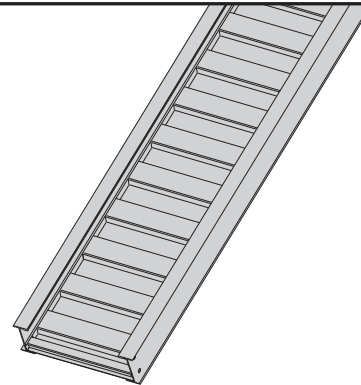

Non-Ventilated Trough

● Green = Fastest shipped items    ● Black = Normal lead-time items    ● Red = Normally long lead-time items

All dimensions in parentheses are millimeters unless otherwise specified.

# Series 2, 3, 4, & 5 Aluminum - Straight Sections

## 3" NEMA VE 1 Loading Depth 4" Side Rail Height

Values are based on simple beam tests per NEMA VE 1 on 36" wide cable tray with rungs spaced on 12" centers. Cable trays will support without collapse a 200 lb. (90.7 kg) concentrated load over and above published loads. Published load safety factor is 1.5. To convert 1.5 safety factor to 2.0, multiply the published load by 0.75. To obtain mid-span deflection, multiply a load by the deflection multiplier. Cable tray must be supported on spans shorter than or equal to the length of the cable tray being installed.

Individual rungs will support without collapse a 200 lb. (90.7 kg) concentrated load applied at the mid-span of the rung, over and above the NEMA rated cable load with a 1.5 safety factor for highlighted NEMA spans and loads.

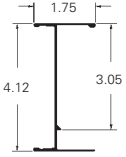
B-Line Series	Side Rail Dimensions	NEMA, CSA & UL Classifications	Span ft	Load lbs/ft	Deflection Multiplier	Design Factors for Two Rails	Span meters	Load kg/m	Deflection Multiplier	Design Factors for Two Rails
24		NEMA: 16A, 12C CSA: 277 kg/m 3.0m D-3m UL Cross-Sectional Area: 1.00 in <sup>2</sup>	6	487*	0.001	Area = 1.05 in <sup>2</sup> Sx = 1.34 in <sup>3</sup> Ix = 2.85 in <sup>4</sup>	1.8	725*	0.017	Area = 6.77 cm <sup>2</sup> Sx = 21.96 cm <sup>3</sup> Ix = 118.63 cm <sup>4</sup>
			8	284	0.003		2.4	422	0.055	
			10	181	0.008		3.0	270	0.136	
			12	126	0.016		3.7	187	0.279	
			14	93	0.030		4.3	138	0.618	
			16	71	0.052		4.9	105	0.883	

When trays are used in continuous spans, the deflection of the tray is reduced by as much as 50%. Design factors: Ix = Moment of Inertia, Sx = Section Modulus.

\* When using 18" rung spacing, load capacity is limited to 394 lbs/ft (586.27 kg/m) for 30" tray width and 325 lbs/ft (483.6 kg/m) for 36" tray width.

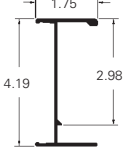
B-Line Series	Side Rail Dimensions	NEMA, CSA & UL Classifications	Span ft	Load lbs/ft	Deflection Multiplier	Design Factors for Two Rails	Span meters	Load kg/m	Deflection Multiplier	Design Factors for Two Rails
H24		NEMA: 20A CSA: 84 kg/m 6.1m D-6m UL Cross-Sectional Area: 1.00 in <sup>2</sup>	10	225	0.006	Area = 1.32 in <sup>2</sup> Sx = 1.57 in <sup>3</sup> Ix = 3.69 in <sup>4</sup>	3.0	330	0.106	Area = 8.52 cm <sup>2</sup> Sx = 25.73 cm <sup>3</sup> Ix = 153.59 cm <sup>4</sup>
			12	156	0.013		3.7	226	0.222	
			14	115	0.023		4.3	171	0.400	
			16	88	0.040		4.9	129	0.693	
			18	70	0.064		5.5	103	1.093	
			20	56	0.098		6.1	83	1.682	

When trays are used in continuous spans, the deflection of the tray is reduced by as much as 50%. Design factors: Ix = Moment of Inertia, Sx = Section Modulus.

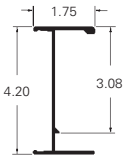
B-Line Series	Side Rail Dimensions	NEMA, CSA & UL Classifications	Span ft	Load lbs/ft	Deflection Multiplier	Design Factors for Two Rails	Span meters	Load kg/m	Deflection Multiplier	Design Factors for Two Rails
34		NEMA: 20B, 16C CSA: 112 kg/m 6.0m E-6m UL Cross-Sectional Area: 1.50 in <sup>2</sup>	10	320	0.005	Area = 1.82 in <sup>2</sup> Sx = 2.10 in <sup>3</sup> Ix = 4.98 in <sup>4</sup>	3.0	476	0.077	Area = 11.74 cm <sup>2</sup> Sx = 34.41 cm <sup>3</sup> Ix = 207.28 cm <sup>4</sup>
			12	222	0.009		3.7	331	0.160	
			14	163	0.017		4.3	243	0.296	
			16	125	0.030		4.9	186	0.505	
			18	99	0.047		5.5	147	0.810	
			20	80	0.072		6.1	119	1.234	

When trays are used in continuous spans, the deflection of the tray is reduced by as much as 50%. Design factors: Ix = Moment of Inertia, Sx = Section Modulus.

All dimensions in parentheses are millimeters unless otherwise specified.

## 4" NEMA VE 1 Loading Depth 5" Side Rail Height

### Straight Section Part Numbering

Example: <sup>Prefix</sup> **25 A 09 - 24 - 144**

Series	Material	*Type	*Width	Length
● 25	● A = Aluminum	<b>Ladder-</b>	● 06 = 6"	● ① 144 = 12 ft.     25
● 35		● 06 = 6" rung spacing	● 09 = 9"	● ② 120 = 10 ft.
		● 09 = 9" rung spacing	● 12 = 12"	● ① 240 = 20 ft.     35
		● 12 = 12" rung spacing	● 18 = 18"	● ② 144 = 12 ft.
		<b>Trough-</b>	● 24 = 24"	
		6" thru 36" wide	● 30 = 30"	
		● VT = Ventilated Trough	● 36 = 36"	
		● ST = Non-Ventilated Trough		

① Primary Length.  
② Secondary Length.

See page C-23 for explanation of lengths.

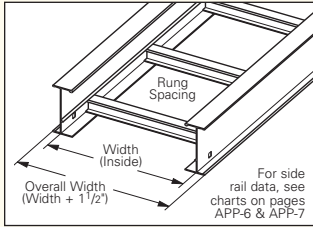

See page APP-1 for additional rung options. \*Special sizes available.

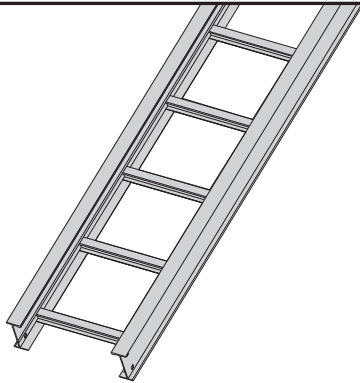

Ladder Type  
(Specify Rung Spacing)

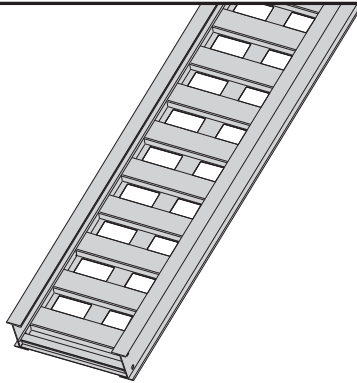

Ventilated Trough

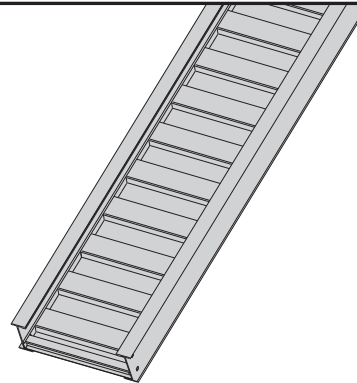

Non-Ventilated Trough

● Green = Fastest shipped items   ● Black = Normal lead-time items   ● Red = Normally long lead-time items

All dimensions in parentheses are millimeters unless otherwise specified.

# Series 2, 3, 4, & 5 Aluminum - Straight Sections

## 4" NEMA VE 1 Loading Depth 5" Side Rail Height

Values are based on simple beam tests per NEMA VE 1 on 36" wide cable tray with rungs spaced on 12" centers. Cable trays will support without collapse a 200 lb. (90.7 kg) concentrated load over and above published loads. Published load safety factor is 1.5. To convert 1.5 safety factor to 2.0, multiply published load by 0.75. To obtain mid-span deflection, multiply a load by the deflection multiplier. Cable tray must be supported on spans shorter than or equal to the length of the cable tray being installed.

Individual rungs will support without collapse a 200 lb. (90.7 kg) concentrated load applied at the mid-span of the rung, over and above the NEMA rated cable load with a 1.5 safety factor for highlighted NEMA spans and loads.

B-Line Series	Side Rail Dimensions	NEMA, CSA & UL Classifications	Span ft	Load lbs/ft	Deflection Multiplier	Design Factors for Two Rails	Span meters	Load kg/m	Deflection Multiplier	Design Factors for Two Rails
25		NEMA: 20A, 12C CSA: 67 kg/m 6.0m D-6m UL Cross-Sectional Area: 1.00 in <sup>2</sup>	10	200	0.0049	Area = 1.24 in <sup>2</sup> S <sub>x</sub> = 1.80 in <sup>3</sup> I <sub>x</sub> = 4.62 in <sup>4</sup>	3.0	298	0.083	Area = 8.00 cm <sup>2</sup> S <sub>x</sub> = 29.50 cm <sup>3</sup> I <sub>x</sub> = 192.30 cm <sup>4</sup>
			12	139	0.010		3.7	207	0.172	
			14	102	0.019		4.3	152	0.319	
			16	78	0.032		4.9	116	0.545	
			18	62	0.051		5.5	92	0.873	
			20	50	0.078		6.1	74	1.330	

When trays are used in continuous spans, the deflection of the tray is reduced by as much as 50%. Design factors: I<sub>x</sub> = Moment of Inertia, S<sub>x</sub> = Section Modulus.

B-Line Series	Side Rail Dimensions	NEMA, CSA & UL Classifications	Span ft	Load lbs/ft	Deflection Multiplier	Design Factors for Two Rails	Span meters	Load kg/m	Deflection Multiplier	Design Factors for Two Rails
35		NEMA: 20B, 16C CSA: 112 kg/m 6.0m E-6m UL Cross-Sectional Area: 1.50 in <sup>2</sup>	10	310	0.0036	Area = 1.67 in <sup>2</sup> S <sub>x</sub> = 2.35 in <sup>3</sup> I <sub>x</sub> = 6.37 in <sup>4</sup>	3.0	461	0.060	Area = 10.77 cm <sup>2</sup> S <sub>x</sub> = 38.51 cm <sup>3</sup> I <sub>x</sub> = 265.14 cm <sup>4</sup>
			12	215	0.0073		3.7	320	0.125	
			14	158	0.014		4.3	235	0.232	
			16	121	0.023		4.9	180	0.395	
			18	96	0.037		5.5	142	0.633	
			20	77	0.057		6.1	115	0.965	

When trays are used in continuous spans, the deflection of the tray is reduced by as much as 50%. Design factors: I<sub>x</sub> = Moment of Inertia, S<sub>x</sub> = Section Modulus.

All dimensions in parentheses are millimeters unless otherwise specified.



## 5" NEMA VE 1 Loading Depth 6" Side Rail Height

### Straight Section Part Numbering

Example: <sup>Prefix</sup> **26 A 09 - 24 - 144**

#### Series

- 26
- 36
- 46
- H46
- 56

#### Material

- A = Aluminum

#### \*Type

##### Ladder-

- 06 = 6" rung spacing
- 09 = 9" rung spacing
- 12 = 12" rung spacing

#### \*Width

- 06 = 6"
- 09 = 9"
- 12 = 12"
- 18 = 18"
- 24 = 24"
- 30 = 30"
- 36 = 36"
- 42 = 42"†
- 48 = 48"†

#### Length

- ① 144 = 12 ft. 26
- ② 120 = 10 ft.
- ① 240 = 20 ft. 36
- ② 144 = 12 ft.
- ① 240 = 20 ft. 46
- ② 288 = 24 ft.
- ① 240 = 20 ft. H46
- ② 300 = 25 ft.
- ① 240 = 20 ft. 57
- ② 288 = 24 ft.
- ② 300 = 25 ft.
- ② 360 = 30 ft.

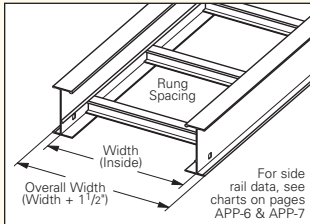

##### Trough-

6" thru 36" wide

- VT = Ventilated Trough
- ST = Non-Ventilated Trough

† For 56A only

① Primary Length.  
② Secondary Length.

See page C-23 for explanation of lengths.

See page APP-1 for additional rung options. \*Special sizes available.



Ladder Type  
(Specify Rung Spacing)

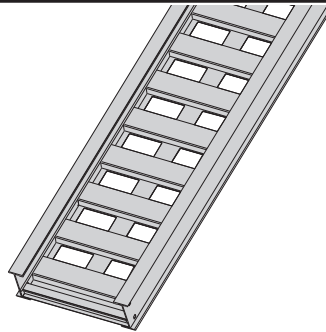

Ventilated Trough

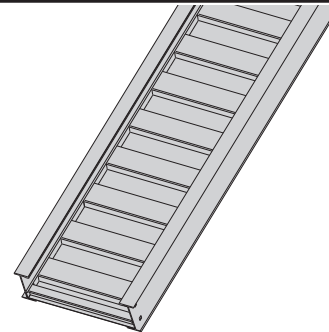

Non-Ventilated Trough

● Green = Fastest shipped items ● Black = Normal lead-time items ● Red = Normally long lead-time items

All dimensions in parentheses are millimeters unless otherwise specified.

# Series 2, 3, 4, & 5 Aluminum - Straight Sections

## 5" NEMA VE 1 Loading Depth 6" Side Rail Height

Values are based on simple beam tests per NEMA VE 1 on 36" wide cable tray with rungs spaced on 12" centers. Cable trays will support, without collapse, a 200 lb. (90.7 kg) concentrated load over and above published loads. Published load safety factor is 1.5. To convert 1.5 safety factor to 2.0, multiply the published load by 0.75. To obtain mid-span deflection, multiply a load by the deflection multiplier. Cable tray must be supported on spans shorter than or equal to the length of the cable tray being installed.

Individual rungs will support without collapse a 200 lb. (90.7 kg) concentrated load applied at the mid-span of the rung, over and above the NEMA rated cable load with a 1.5 safety factor for highlighted NEMA spans and loads.

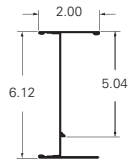
B-Line Series	Side Rail Dimensions	NEMA, CSA & UL Classifications	Span ft	Load lbs/ft	Deflection Multiplier	Design Factors for Two Rails	Span meters	Load kg/m	Deflection Multiplier	Design Factors for Two Rails
26		NEMA: 20A, 16B CSA: 67 kg/m 6.0m D-6m UL Cross-Sectional Area: 1.00 in <sup>2</sup>	10	204	0.0028	Area = 1.41 in <sup>2</sup> Sx = 2.53 in <sup>3</sup> Ix = 7.915 in <sup>4</sup>	3.0	304	0.049	Area = 9.10 cm <sup>2</sup> Sx = 41.46 cm <sup>3</sup> Ix = 329.45 cm <sup>4</sup>
			12	142	0.006		3.7	211	0.101	
			14	104	0.011		4.3	155	0.186	
			16	80	0.019		4.9	119	0.318	
			18	63	0.030		5.5	94	0.509	
			20	51	0.045		6.1	76	0.776	

When trays are used in continuous spans, the deflection of the tray is reduced by as much as 50%. Design factors: Ix = Moment of Inertia, Sx = Section Modulus.

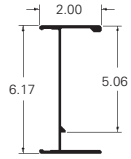
B-Line Series	Side Rail Dimensions	NEMA, CSA & UL Classifications	Span ft	Load lbs/ft	Deflection Multiplier	Design Factors for Two Rails	Span meters	Load kg/m	Deflection Multiplier	Design Factors for Two Rails
36		NEMA: 20B, 16C CSA: 112 kg/m 6.0m E-6m UL Cross-Sectional Area: 1.50 in <sup>2</sup>	12	233	0.0043	Area = 1.81 in <sup>2</sup> Sx = 3.36 in <sup>3</sup> Ix = 10.85 in <sup>4</sup>	3.7	347	0.073	Area = 11.68 cm <sup>2</sup> Sx = 55.06 cm <sup>3</sup> Ix = 451.61 cm <sup>4</sup>
			14	171	0.008		4.3	255	0.136	
			16	131	0.014		4.9	195	0.232	
			18	104	0.022		5.5	154	0.372	
			20	84	0.033		6.1	125	0.566	
			22	69	0.049		6.7	103	0.829	

When trays are used in continuous spans, the deflection of the tray is reduced by as much as 50%. Design factors: Ix = Moment of Inertia, Sx = Section Modulus.

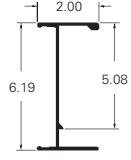
B-Line Series	Side Rail Dimensions	NEMA, CSA & UL Classifications	Span ft	Load lbs/ft	Deflection Multiplier	Design Factors for Two Rails	Span meters	Load kg/m	Deflection Multiplier	Design Factors for Two Rails
46		NEMA: 20C CSA: 168 kg/m 6.1m E-6m UL Cross-Sectional Area: 1.50 in <sup>2</sup>	14	210	0.0071	Area = 2.06 in <sup>2</sup> Sx = 3.59 in <sup>3</sup> Ix = 12.18 in <sup>4</sup>	4.3	313	0.121	Area = 13.29 cm <sup>2</sup> Sx = 58.83 cm <sup>3</sup> Ix = 506.97 cm <sup>4</sup>
			16	161	0.012		4.9	239	0.207	
			18	127	0.019		5.5	189	0.331	
			20	103	0.030		6.1	153	0.505	
			22	85	0.043		6.7	127	0.739	
			24	72	0.061		7.3	106	1.046	

When trays are used in continuous spans, the deflection of the tray is reduced by as much as 50%. Design factors: Ix = Moment of Inertia, Sx = Section Modulus.

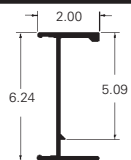
B-Line Series	Side Rail Dimensions	NEMA, CSA & UL Classifications	Span ft	Load lbs/ft	Deflection Multiplier	Design Factors for Two Rails	Span meters	Load kg/m	Deflection Multiplier	Design Factors for Two Rails
H46		NEMA: 20C+ CSA: 131 kg/m 7.6m E-6m UL Cross-Sectional Area: 2.00 in <sup>2</sup>	16	261	0.0085	Area = 2.95 in <sup>2</sup> Sx = 5.33 in <sup>3</sup> Ix = 17.30 in <sup>4</sup>	4.9	388	0.145	Area = 19.03 cm <sup>2</sup> Sx = 87.34 cm <sup>3</sup> Ix = 720.08 cm <sup>4</sup>
			18	206	0.014		5.5	307	0.233	
			20	167	0.021		6.1	248	0.355	
			22	138	0.030		6.7	205	0.520	
			24	116	0.043		7.3	173	0.737	
			25	88	0.051		7.6	131	0.867	

When trays are used in continuous spans, the deflection of the tray is reduced by as much as 50%. Design factors: Ix = Moment of Inertia, Sx = Section Modulus.

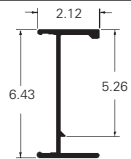
B-Line Series	Side Rail Dimensions	NEMA, CSA & UL Classifications	Span ft	Load lbs/ft	Deflection Multiplier	Design Factors for Two Rails	Span meters	Load kg/m	Deflection Multiplier	Design Factors for Two Rails
56		NEMA: 20C+ CSA: 112 kg/m 9.1m E-6m UL Cross-Sectional Area: 2.00 in <sup>2</sup>	20	169	0.016	Area = 3.63 in <sup>2</sup> Sx = 6.12 in <sup>3</sup> Ix = 22.63 in <sup>4</sup>	6.1	251	0.272	Area = 23.42 cm <sup>2</sup> Sx = 100.29 cm <sup>3</sup> Ix = 941.86 cm <sup>4</sup>
			22	139	0.023		6.7	208	0.398	
			24	117	0.033		7.3	174	0.563	
			26	100	0.045		7.9	149	0.776	
			28	86	0.061		8.5	128	1.043	
			30	75	0.081		9.1	112	1.375	

When trays are used in continuous spans, the deflection of the tray is reduced by as much as 50%. Design factors: Ix = Moment of Inertia, Sx = Section Modulus.

All dimensions in parentheses are millimeters unless otherwise specified.

# Series 2, 3, 4, & 5 Aluminum - Straight Sections

## 6" NEMA VE 1 Loading Depth 7" Side Rail Height

### Straight Section Part Numbering

Example: <sup>Prefix</sup> **37 A 09 - 24 - 144**

#### Series

● 27

● 37

● 47

● H47†

● 57

#### Material

● A = Aluminum

#### \*Type

##### Ladder-

- 06 = 6" rung spacing
- 09 = 9" rung spacing
- 12 = 12" rung spacing

#### \*Width

- 06 = 6"
- 09 = 9"
- 12 = 12"
- 18 = 18"
- 24 = 24"
- 30 = 30"
- 36 = 36"

#### Length

- ① 144 = 12 ft.      27
- ② 120 = 10 ft.
- ① 240 = 20 ft.      37
- ② 144 = 12 ft.
- ① 240 = 20 ft.      47
- ② 288 = 24 ft.
- ① 240 = 20 ft.      H47
- ② 300 = 25 ft.
- ① 360 = 30 ft.      57
- ② 300 = 25 ft.

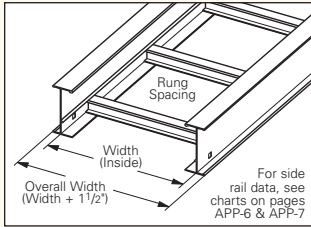

##### ● Trough-

- 6" thru 36" wide
- VT = Ventilated Trough
- ST = Non-Ventilated Trough

† H47A & 57A only available in ladder type 9" and 12" rung spacing.  
See page APP-2.

① Primary Length.  
② Secondary Length.

See page C-23 for explanation of lengths.

See page APP-1 for additional rung options. \*Special sizes available.

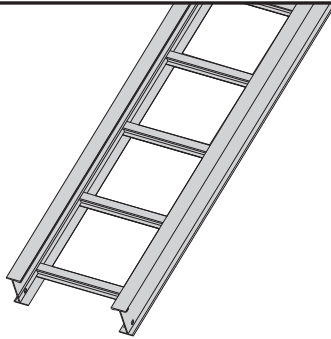

Ladder Type  
(Specify Rung Spacing)

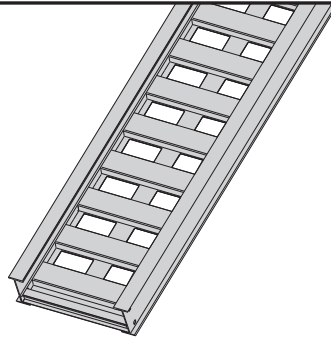

Ventilated Trough

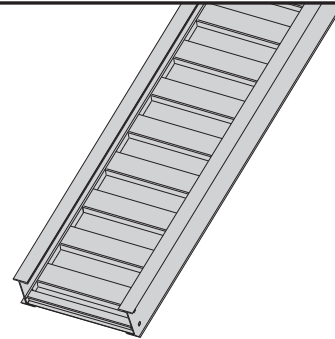

Non-Ventilated Trough

57A available in  
(9" & 12" rung spacing in  
12" to 36" widths)

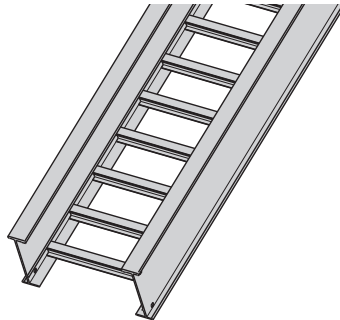

● Green = Fastest shipped items    ● Black = Normal lead-time items    ● Red = Normally long lead-time items

All dimensions in parentheses are millimeters unless otherwise specified.

# Series 2, 3, 4, & 5 Aluminum - Straight Sections

## 6" NEMA VE 1 Loading Depth 7" Side Rail Height

Values are based on simple beam tests per NEMA VE 1 on 36" wide cable tray with rungs spaced on 12" centers. Cable trays will support without collapse a 200 lb. (90.7 kg) concentrated load over and above published loads. Published load safety factor is 1.5. To convert 1.5 safety factor to 2.0, multiply the published load by 0.75. To obtain mid-span deflection, multiply a load by the deflection multiplier. Cable tray must be supported on spans shorter than or equal to the length of the cable tray being installed.

Individual rungs will support without collapse a 200 lb. (90.7 kg) concentrated load applied at the mid-span of the rung, over and above the NEMA rated cable load with a 1.5 safety factor for highlighted NEMA spans and loads.

B-Line Series	Side Rail Dimensions	NEMA, CSA & UL Classifications	Span ft	Load lbs/ft	Deflection Multiplier	Design Factors for Two Rails	Span meters	Load kg/m	Deflection Multiplier	Design Factors for Two Rails
27		NEMA: 12C CSA: 68 kg/m 6.0m D-6m UL Cross-Sectional Area: 1.50 in <sup>2</sup>	10	177	0.006	Area = 1.63 in <sup>2</sup> Sx = 2.93 in <sup>3</sup> Ix = 11.28 in <sup>4</sup>	3.0	269	0.033	Area = 10.52 cm <sup>2</sup> Sx = 48.01 cm <sup>3</sup> Ix = 469.51 cm <sup>4</sup>
			12	123	0.013		3.7	177	0.073	
			14	90	0.023		4.3	134	0.131	
			16	69	0.040		4.9	101	0.227	
			18	54	0.064		5.5	81	0.357	
			20	44	0.098		6.1	67	0.534	
37		NEMA: 20B, 16C CSA: 101 kg/m 6.1m D-6m UL Cross-Sectional Area: 1.50 in <sup>2</sup>	12	222	0.0035	Area = 1.81 in <sup>2</sup> Sx = 3.77 in <sup>3</sup> Ix = 13.50 in <sup>4</sup>	3.7	331	0.059	Area = 11.68 cm <sup>2</sup> Sx = 61.78 cm <sup>3</sup> Ix = 561.91 cm <sup>4</sup>
			14	163	0.0064		4.3	243	0.109	
			16	125	0.011		4.9	186	0.186	
			18	99	0.017		5.5	147	0.299	
			20	80	0.027		6.1	119	0.455	
			22	66	0.039		6.7	98	0.666	
47		NEMA: 20C CSA: 142 kg/m 6.1m E-6m UL Cross-Sectional Area: 2.00 in <sup>2</sup>	14	204	0.0048	Area = 2.38 in <sup>2</sup> Sx = 4.94 in <sup>3</sup> Ix = 17.88 in <sup>4</sup>	4.3	305	0.083	Area = 15.35 cm <sup>2</sup> Sx = 80.95 cm <sup>3</sup> Ix = 744.22 cm <sup>4</sup>
			16	156	0.0082		4.9	233	0.141	
			18	123	0.0132		5.5	184	0.225	
			20	100	0.0201		6.1	149	0.344	
			22	83	0.0295		6.7	123	0.503	
			24	69	0.0418		7.3	103	0.713	
H47		NEMA: 20C+ CSA: 241 kg/m 6.1m E-6m UL Cross-Sectional Area: 2.00 in <sup>2</sup>	16	233	0.0064	Area = 3.04 in <sup>2</sup> Sx = 6.10 in <sup>3</sup> Ix = 22.91 in <sup>4</sup>	4.9	346	0.110	Area = 19.61 cm <sup>2</sup> Sx = 99.96 cm <sup>3</sup> Ix = 953.59 cm <sup>4</sup>
			18	184	0.010		5.4	274	0.176	
			20	149	0.016		6.1	222	0.268	
			22	123	0.023		6.7	183	0.393	
			24	103	0.033		7.3	154	0.556	
			25	95	0.038		7.6	142	0.655	
57		NEMA: 20C+ CSA: 151 kg/m 9.1m E-6m UL Cross-Sectional Area: 2.00 in <sup>2</sup>	20	232	0.011	Area = 4.22 in <sup>2</sup> Sx = 7.73 in <sup>3</sup> Ix = 32.86 in <sup>4</sup>	6.1	345	0.187	Area = 27.73 cm <sup>2</sup> Sx = 126.67 cm <sup>3</sup> Ix = 1367.74 cm <sup>4</sup>
			22	192	0.016		6.7	285	0.274	
			24	161	0.023		7.3	240	0.388	
			26	136	0.031		7.9	202	0.534	
			28	117	0.042		8.5	174	0.718	
			30	102	0.055		9.1	152	0.947	

When trays are used in continuous spans, the deflection of the tray is reduced by as much as 50%. Design factors: Ix = Moment of Inertia, Sx = Section Modulus.

All dimensions in parentheses are millimeters unless otherwise specified.

# Series 2, 3, 4, & 5 Aluminum - Straight Sections

## 6" NEMA VE 1 Loading Depth 8" Side Rail Height

### Straight Section Part Numbering

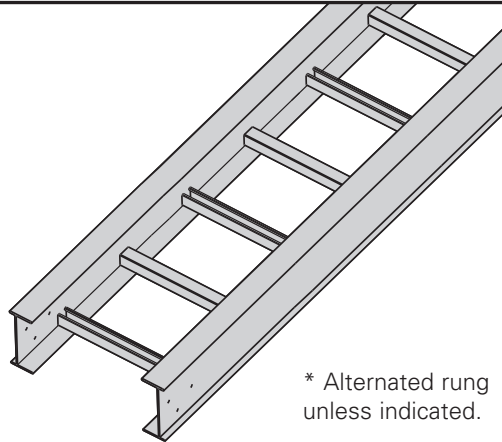
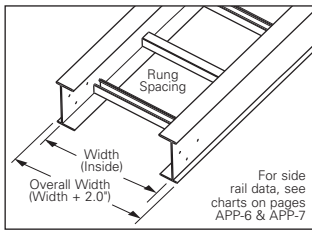
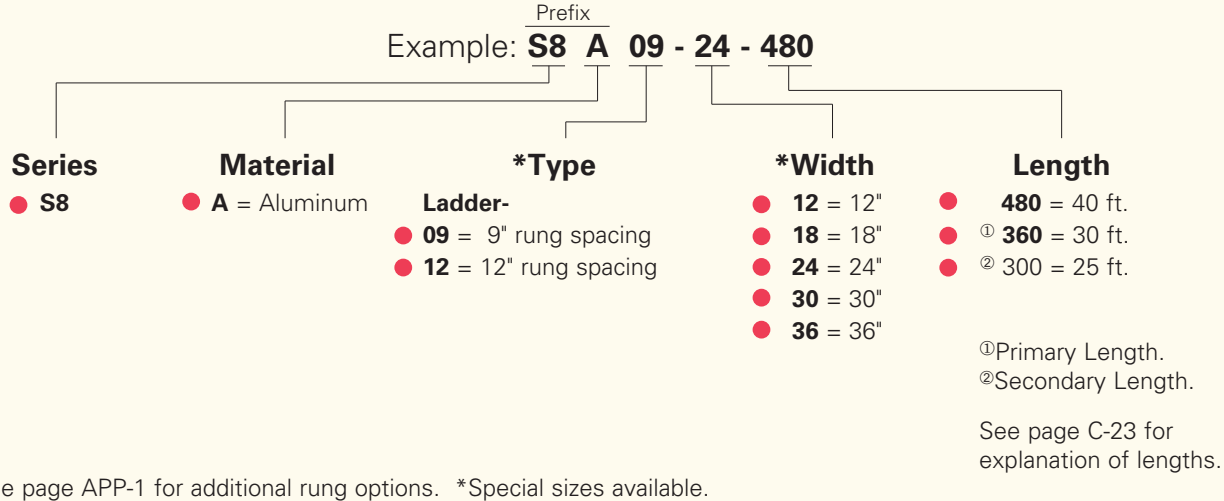

Values are based on simple beam tests per NEMA VE 1 on 36" wide cable tray with rungs spaced on 12" centers. Cable trays will support without collapse a 200 lb. (90.7 kg) concentrated load over and above published loads. Published load safety factor is 1.5. To convert 1.5 safety factor to 2.0, multiply the published load by 0.75. To obtain mid-span deflection, multiply a load by the deflection multiplier. Cable tray must be supported on spans shorter than or equal to the length of the cable tray being installed.

Individual rungs will support without collapse a 200 lb. (90.7 kg) concentrated load applied at the mid-span of the rung, over and above the NEMA rated cable load with a 1.5 safety factor for highlighted NEMA spans and loads.

B-Line Series	Side Rail Dimensions	NEMA, CSA & UL Classifications	Span ft	Load lbs/ft	Deflection Multiplier	Design Factors for Two Rails	Span meters	Load kg/m	Deflection Multiplier	Design Factors for Two Rails
<b>S8A</b>		NEMA: 20C+	20	363	0.007	Area=5.50 in <sup>2</sup> Sx=15.39 in <sup>3</sup> Ix=55.35 in <sup>4</sup>	6.1	540	0.111	Area=35.48 cm <sup>2</sup> Sx=252.20 cm <sup>3</sup> Ix=2303.84 cm <sup>4</sup>
		CSA: 240 kg/m 9.1m	22	300	0.010		6.7	446	0.163	
		UL Cross-Sectional Area: 2.00 in <sup>2</sup>	24	252	0.013		7.3	375	0.230	
			26	215	0.019		7.9	320	0.317	
			28	185	0.025		8.5	276	0.427	
			30	161	0.033		9.1	240	0.562	
			40	101	0.146		12.2	151	2.488	

● Green = Fastest shipped items   ● Black = Normal lead-time items   ● Red = Normally long lead-time items

All dimensions in parentheses are millimeters unless otherwise specified.

The following is a list of accessories and fittings that can be provided with S8A tray. For more information on these items, contact our Engineering Department.

## ● Fittings

### Horizontal Bends

- 30° Bends with 24", 36", or 48" radius
- 45° Bends with 24", 36", or 48" radius
- 60° Bends with 24", 36", or 48" radius
- 90° Bends with 24", 36", or 48" radius

### Horizontal Tees & Crosses

With 24", 36", or 48" radius

### Vertical Outside Bends

- 30° Bends with 24", 36", or 48" radius
- 45° Bends with 24", 36", or 48" radius
- 60° Bends with 24", 36", or 48" radius
- 90° Bends with 24", 36", or 48" radius

### Vertical Inside Bends

- 30° Bends with 24", 36", or 48" radius
- 45° Bends with 24", 36", or 48" radius
- 60° Bends with 24", 36", or 48" radius
- 90° Bends with 24", 36", or 48" radius

### Reducing Fittings

## ● Accessories - (standard hardware is stainless steel Type 316)

**Splice Plate** - 9A-1008

**Expansion Splice Plate** - 9A-1018

**Horizontal Adjustable Splice Plate** - 9A-1038

**Vertical Adjustable Splice Plate** - 9A-1028

**Hold Down Clamps** - 9ZN-1281, 9G-1281, 9A-1281

**Guides** - S9ZN-1202, S9G-1202

**Step Down Splice Plate** -

9A-1048 = 8" to 4"

9A-1051 = 8" to 5"

9A-1050 = 8" to 6"

9A-1078 = 8" to 7"

**Other Accessories Include:**

**Offset Splice Plates**

**Blind Ends**

**Covers** - Standard aluminum cover number with S in front (Example: S807A40)

● Green = Fastest shipped items   ● Black = Normal lead-time items   ● Red = Normally long lead-time items

All dimensions in parentheses are millimeters unless otherwise specified.

# Series 2, 3, 4, & 5 Aluminum - Accessories

## Wedge Lock Splice Plates

- Furnished in pairs with  $\frac{3}{8}$ " hardware.
- Standard 4-hole pattern.
- Furnished in pairs, with hardware.
- One pair including hardware provided with each section.  
(Expansion splice quantity subtracted)
- Boxed in pairs with hardware.
- For field installation drill  $1\frac{3}{32}$ " hole.

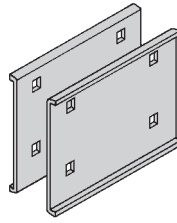

Catalog No.	Height in. mm
● 9A-1004	4 (101)
● 9A-1005	5 (127)
● 9A-1006	6 (152)
● 9A-1007	7 (178)

## H46A, H47A and 57A Mid-Span Splice

- Furnished in pairs with  $\frac{3}{8}$ " hardware.
- Standard for H46A, H47A and 57A straight sections.
- Six bolt design  $\frac{1}{2}$ " Stainless Steel Type 316 hardware standard.
- Available on ladder bottoms only. 09 and 12" rung spacing.
- Furnished in pairs with hardware.

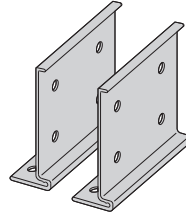

Catalog No.	Tray Series
● 9A-6006	H46A
● 9A-6007	H47A, 57A

## Expansion Splice Plates

- Expansion plates allow for one inch expansion or contraction of the cable tray, or where expansion joints occur in the supporting structure.
- Furnished in pairs with hardware.
- **Bonding Jumpers are required on each siderail. Order Separately.**

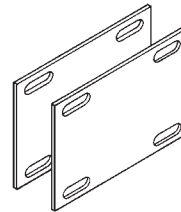

Catalog No.	Height in. mm
● 9A-1014	4 (101)
● 9A-1015	5 (127)
● 9A-1016	6 (152)
● 9A-1017	7 (178)

For heavy duty expansion splice plates see page APP-3.

## Universal Splice Plates

- Furnished in pairs with  $\frac{3}{8}$ " hardware.
- UL Classified.

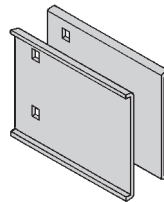

Catalog No.	Height in. mm
● 9A-1004-1/2	4 (101)
● 9A-1005-1/2	5 (127)
● 9A-1006-1/2	6 (152)
● 9A-1007-1/2	7 (178)

## Step Down Splice Plates

- These splice plates are offered for connecting cable tray sections having side rails of different heights.
- Furnished in pairs with hardware.

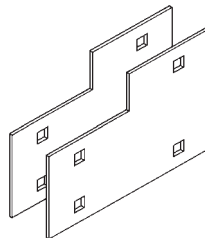

Requires supports within 24" on both sides, per NEMA VE 2.

Catalog No.	Height in. mm
● 9A-1045	5 to 4 (127 to 101)
● 9A-1046	6 to 4 (152 to 101)
● 9A-1060	6 to 5 (152 to 127)
● 9A-1047	7 to 4 (178 to 101)
● 9A-1061	7 to 5 (178 to 127)
● 9A-1062	7 to 6 (178 to 152)

## Vertical Adjustable Splice Plates

- These plates provide for changes in elevation that do not conform to standard vertical fittings.
- Furnished in pairs with hardware.
- Bonding Jumpers not required.

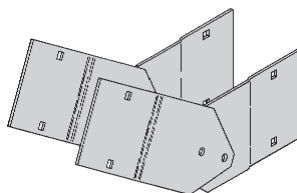

Catalog No.	Height in. mm
● 9A-1024	4 (101)
● 9A-1025	5 (127)
● 9A-1026	6 (152)
● 9A-1027	7 (178)

● Green = Fastest shipped items    ● Black = Normal lead-time items    ● Red = Normally long lead-time items

All dimensions in parentheses are millimeters unless otherwise specified.

## Horizontal Adjustable Splice Plates

- Offered to adjust a cable tray run for changes in direction in a horizontal plane that do not conform to standard horizontal fittings.
- Furnished in pairs with hardware.
- Bonding jumpers **not** required.
- (X) Insert 4, 5, 6 or 7 for side rail height.

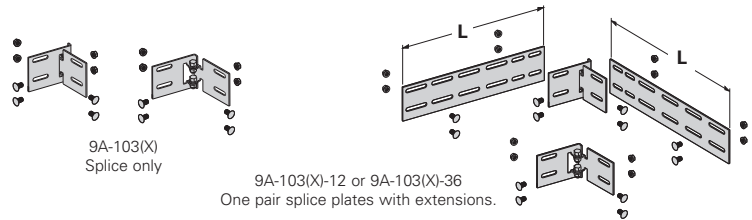

Requires supports within 24" on both sides, per NEMA VE 2.

Catalog No.	Cable Tray End Cut	Thru Tray Width in. (mm)	'L' in. (mm)
● 9A-103(X)	Mitered	36 (914)	N/A (NA)
● 9A-103(X)-12	Not mitered	12 (305)	16 (406)
● 9A-103(X)-36	Not mitered	36 (914)	41 (1041)

## Branch Pivot Connectors

- Branch from existing cable tray runs at any point.
- Pivot to any required angle.
- UL Classified for grounding (bonding jumpers not required).
- Furnished in pairs with hardware.

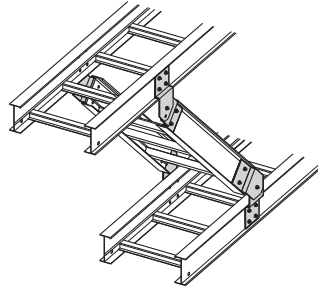

Catalog No.	Height in. mm
● 9A-2044	4 (101)
● 9A-2045	5 (127)
● 9A-2046	6 (152)
● 9A-2047	7 (178)

## Offset Reducing Splice Plate

- This plate is used for joining cable trays having different widths. When used in pairs they form a straight reduction; when used singly with a standard splice plate, they form an offset reduction.
- Furnished as one plate with hardware.
- (‡) Insert reduction

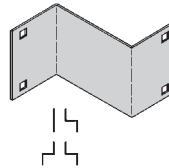

Catalog No.	Height in. mm
● 9A-1064-‡	4 (101)
● 9A-1065-‡	5 (127)
● 9A-1066-‡	6 (152)
● 9A-1067-‡	7 (178)

## Tray to Box Splice Plates

- Used to attach the end of a cable tray run to a distribution box or control panel.
- Furnished in pairs with hardware

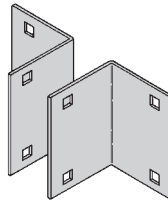

Catalog No.	Height in. mm
● 9A-1054	4 (101)
● 9A-1055	5 (127)
● 9A-1056	6 (152)
● 9A-1057	7 (178)

## Frame Type Box Connector

- Designed to attach the end of a cable tray run to a distribution cabinet or control center to help reinforce the box at the point of entry.
- Furnished with tray connection hardware.

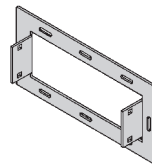

Catalog No.	Height in. mm
● 9A-1074-‡	4 (101)
● 9A-1075-‡	5 (127)
● 9A-1076-‡	6 (152)
● 9A-1077-‡	7 (178)

## Blind End

- This plate forms a closure for a dead end cable tray.
- Furnished as one plate with hardware.
- (‡) Insert tray width

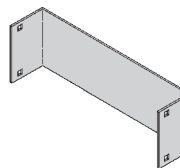

Catalog No.	Height in. mm
● 9A-1084-‡	4 (101)
● 9A-1085-‡	5 (127)
● 9A-1086-‡	6 (152)
● 9A-1087-‡	7 (178)

● Green = Fastest shipped items   ● Black = Normal lead-time items   ● Red = Normally long lead-time items

All dimensions in parentheses are millimeters unless otherwise specified.



# Series 2, 3, 4, & 5 Aluminum - Accessories

## Standard Tray Hardware (for field installation drill $1\frac{3}{32}$ " hole)

- Finish: Zinc Plated ASTM B633 SC1

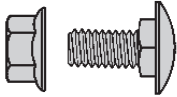

Catalog No.	Description
● SNCB $\frac{3}{8}$ " x $\frac{3}{4}$ " ZN	Square Neck Carriage Bolt ASTM A307 Grade A
● SFHN $\frac{3}{8}$ "-16 ZN	Serrated Flange Hex Nut ASTM A563 Grade A

## Optional Tray Hardware (for field installation drill $1\frac{3}{32}$ " hole)

- To order 316 stainless steel hardware add SS6 suffix to catalog number - Example: 9A1004SS6

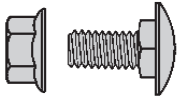

Catalog No.	Description
● SNCB $\frac{3}{8}$ " x $\frac{3}{4}$ " SS6	Square Neck Carriage Bolt AISI 316 Stainless Steel
● SFHN $\frac{3}{8}$ "-16 SS6	Serrated Flange Hex Nut AISI 316 Stainless Steel

## Cross Connector Bracket

- For field connecting crossing section.
- Furnished in pairs with  $\frac{3}{8}$ " hardware.

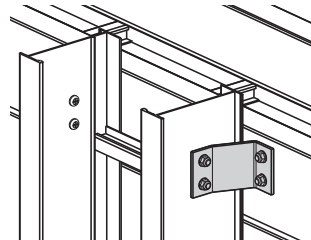
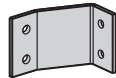

Catalog No.
● 9A-1240

## Conduit to Cable Tray Adaptor

- For easy attachment of conduit terminating at a cable tray.
- Use on aluminum or steel cable trays.

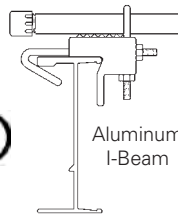
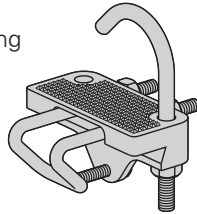

Aluminum I-Beam

Catalog No.	Conduit Size	
	in.	mm
● 9G-1158- $1\frac{1}{2}$ , $3\frac{1}{2}$	$1\frac{1}{2}$ , $3\frac{1}{4}$	(15, 20)
● 9G-1158-1, $1\frac{1}{4}$	1, $1\frac{1}{4}$	(25, 32)
● 9G-1158- $1\frac{1}{2}$ , 2	$1\frac{1}{2}$ , 2	(40, 50)
● 9G-1158- $2\frac{1}{2}$ , 3	$2\frac{1}{2}$ , 3	(65, 80)
● 9G-1158- $3\frac{1}{2}$ , 4	$3\frac{1}{2}$ , 4	(90, 100)

## Conduit to Cable Tray Adaptor

- Assembly required.
- Mounting hardware included.
- Conduit clamps provided.
- (‡) = Insert conduit size ( $1\frac{1}{2}$ " thru 4").

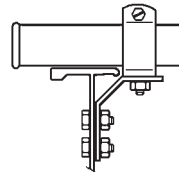

Catalog No.
● 9ZN-1150-(‡)

## Conduit to Cable Tray Adaptor

- Assembly required.
- Conduit clamps included.
- (‡) = Insert conduit size ( $1\frac{1}{2}$ " thru 4").

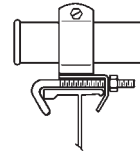
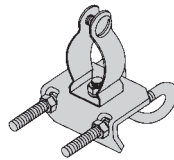

Catalog No.
● 9ZN-1155-(‡)

## Cable Tie (Ladder Tray)

- Nylon ties provide easy attachment of cable to ladder rungs; maximum cable O.D. is 3" (76mm).

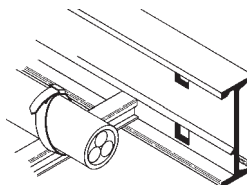

Overall Length 15" (381mm)

Catalog No.
● 99-2125-15

● Green = Fastest shipped items   ● Black = Normal lead-time items   ● Red = Normally long lead-time items

All dimensions in parentheses are millimeters unless otherwise specified.

## Ladder Drop-Out

- Specially-designed Ladder Drop-Outs provide a rounded surface with 4" (101 mm) radius to protect cable as it exits from the cable tray, preventing damage to insulation. The drop-out will attach to any desired rung.
- (‡) Insert tray width

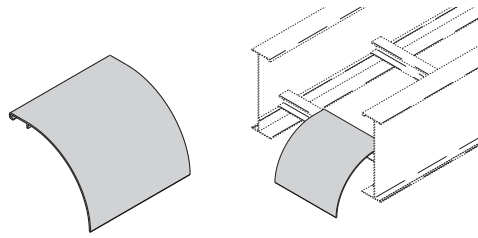

Catalog No.
● 9A-1104-(‡)

## Trough Drop-Out & Drop-Out Bushing

- These devices provide a rounded surface to protect cable as it exits from the trough-type cable tray.
- Hardware is included for attachment of the trough bottom drop-out.
- (‡) Insert tray width

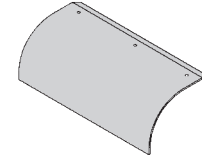
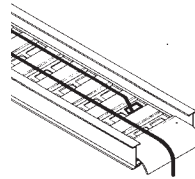

Trough-Type Drop-Out

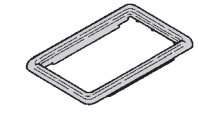

Snap-In Plastic Bushing

Catalog No.
● 9A-1104T-(‡)

Catalog No.
● 99-1124

## Barrier - Straight Section

- Length: Insert 120 for [120" - 10 ft.] (3.0 m) or 144 for [144" - 12 ft.] (3.6 m)
- Order catalog number based on loading depth.
- Furnished with four #10 x 1/2" plated self-drilling screws and a 99-9982 Barrier Strip Splice.

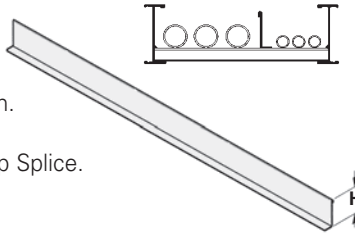

Catalog No.	Side Rail Height in. mm	Loading Depth 'H' in. mm
● 73A-Length	4 (101)	3 (76)
● 74A-Length	5 (127)	4 (101)
● 75A-Length	6 (152)	5 (127)
● 76A-Length	7 (178)	6 (152)

## Barrier - Horizontal Bend

- Horizontal Bend Barriers are flexible in order to conform to any horizontal fitting radius. Can be cut to desired length.
- Standard length is 72" [6 ft.] (1.8 m) - sold individually
- Order catalog number based on loading depth.
- Furnished with three #10 x 1/2" plated self-drilling screws and a 99-9982 Barrier Strip Splice.

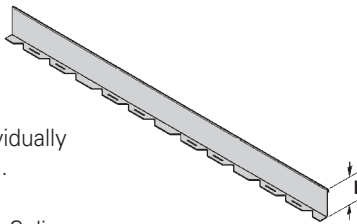

Catalog No.	Side Rail Height in. mm	Loading Depth 'H' in. mm
● 73A-90HBFL	4 (101)	3 (76)
● 74A-90HBFL	5 (127)	4 (101)
● 75A-90HBFL	6 (152)	5 (127)
● 76A-90HBFL	7 (178)	6 (152)

## Barrier - Vertical Outside Bend

- Vertical Outside Bend Barriers are preformed to conform to a specific vertical outside bend fitting.
- Furnished with three #10 x 1/2" plated self-drilling screws and a 99-9982 Barrier Strip Splice.
- (\*) Insert 30, 45, 60 or 90 for degrees
- (t) Insert 12, 24, 36 or 48 for radius

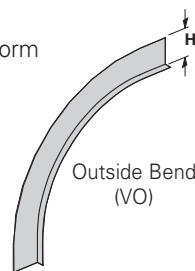

Catalog No.	Side Rail Height in. mm	Loading Depth 'H' in. mm
● 73A-(*)VO(†)	4 (101)	3 (76)
● 74A-(*)VO(†)	5 (127)	4 (101)
● 75A-(*)VO(†)	6 (152)	5 (127)
● 76A-(*)VO(†)	7 (178)	6 (152)

## Barrier - Vertical Inside Bend

- Vertical Inside Bend Barriers are preformed to conform to a specific vertical inside bend fitting.
- Furnished with three #10 x 1/2" plated self-drilling screws and a 99-9982 Barrier Strip Splice.
- (\*) Insert 30, 45, 60 or 90 for degrees
- (t) Insert 12, 24, 36 or 48 for radius

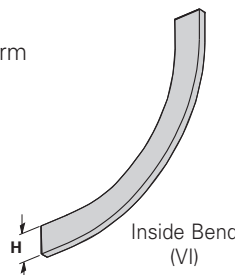

Catalog No.	Side Rail Height in. mm	Loading Depth 'H' in. mm
● 73A-(*)VI(†)	4 (101)	3 (76)
● 74A-(*)VI(†)	5 (127)	4 (101)
● 75A-(*)VI(†)	6 (152)	5 (127)
● 76A-(*)VI(†)	7 (178)	6 (152)

● Green = Fastest shipped items   ● Black = Normal lead-time items   ● Red = Normally long lead-time items

All dimensions in parentheses are millimeters unless otherwise specified.

# Series 2, 3, 4, & 5 Aluminum - Accessories

## Barrier Strip Clip

- Provides attachment to rung.
- Allows for installed barrier adjustment.
- Asymmetrical clip provides a wide range for screw location.
- Barrier strip clips not included with barriers. (Must be ordered separately)

Screw slot for sheet metal screw

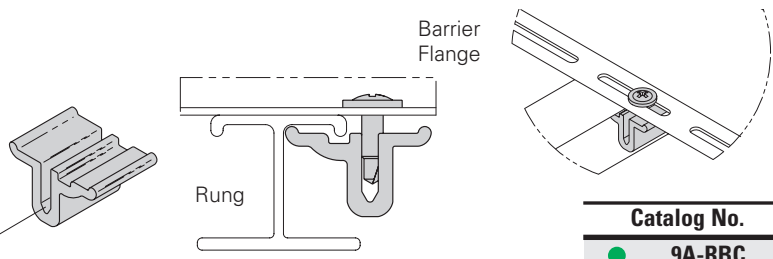

Catalog No.	
●	9A-RBC

## Barrier Strip Splice

- 2.85" (72.4mm) long
- Ribbed edge for increased rigidity and grip
- Comfort edge for ease of installation
- Slotted top window with center mark for accurate placement and inspection capability
- Patent pending

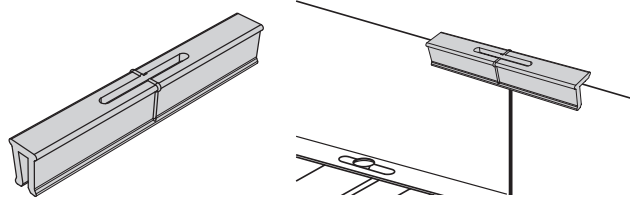

Catalog No.	
●	99-9982

## Bonding Jumper

Use at each expansion splice and where the cable tray is not mechanically/electrically continuous to ground. Sold individually.

- Hardware included.
- See table 392.6(B)(2) on page CTS-9 for amperage ratings required to match the UL cross-sectional area of the tray.
- See tray loading chart for UL cross-sectional area.
- Bonding jumper is 14<sup>1</sup>/<sub>2</sub>" (368mm) long.

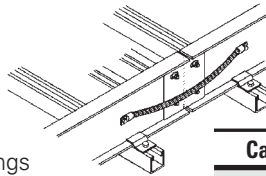

Catalog No.	Copper Wire Size	Ampacity
● 99-N1	#1	600
● 99-40	4/0	1600
● 99-1620	250 MCM	2000

## Grounding Clamp

Eaton's B-Line series cable tray is UL® classified as to its suitability as an equipment grounding conductor. If a separate conductor for additional grounding capability is desired, B-Line offers this clamp for bolting the conductor at least once to each cable tray section.

- Accepts #6 AWG to 250 MCM.

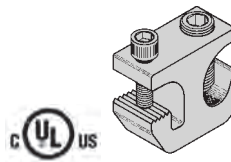

Catalog No.	Material
● 9A-2130	Tin Plated Aluminum

## Ground Wire Clamp

- Mechanically attaches grounding cables to cable tray.
- Hardware included.
- (\*) Insert **ZN** or **SS4**

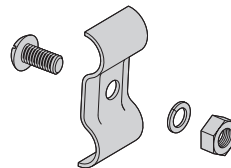

Catalog No.	Material
9(*)-2351	#1 thru 2/0
9(*)-2352	3/0 thru 250 MCM

## Thread Rod (ATR) & Rod Couplings

Loading based on safety factor 5.  
Standard Finish: Zinc plated  
See B-Line series Strut Systems Catalog for other sizes and finishes.

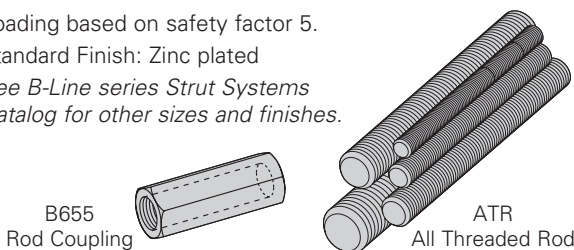

Size	Catalog No.	Available Length	Loading
<b>All Threaded Rod</b>			
3/8"-16	● ATR 3/8" x Length	36", 72", 120", 144"	730 lbs.
1/2"-13	● ATR 1/2" x Length	36", 72", 120", 144"	1350 lbs.
<b>Rod Coupling</b>			
3/8"-16	● B655-3/8"	NA	730 lbs.
1/2"-13	● B655-1/2"	NA	1350 lbs.

● Green = Fastest shipped items   ● Black = Normal lead-time items   ● Red = Normally long lead-time items

All dimensions in parentheses are millimeters unless otherwise specified.

# Series 2, 3, 4, & 5 Aluminum - Accessories

## Stainless Steel Cable Clamp 'P'

- Fits with series 2, 3, & 4 rungs.
- Attaches to rung at any point.
- 14 gauge Type 316 stainless steel material to minimize corrosion and induction heating.
- Plated steel and aluminum also available.

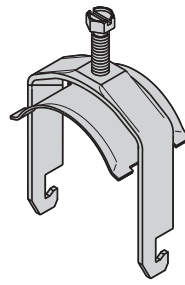
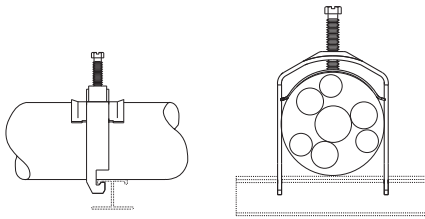

Refer to Section CF  
Cable Fixing

Catalog No.	Cable Size	
	in.	mm
● BP081SS	.250 - .840	(6.4 - 21.3)
● BP110SS	.810 - 1.100	(20.6 - 28.0)
● BP135SS	.850 - 1.350	(21.6 - 34.8)
● BP175SS	1.250 - 1.750	(31.8 - 44.5)
● BP205SS	1.550 - 2.050	(39.4 - 52.1)
● BP250SS	2.000 - 2.500	(50.8 - 63.5)
● BP300SS	2.500 - 3.000	(63.5 - 76.2)
● BP325SS	2.750 - 3.250	(69.9 - 82.6)
● BP375SS	3.250 - 3.750	(82.6 - 95.3)
● BP425SS	3.750 - 4.250	(95.3 - 108.0)
● BP475SS	4.250 - 4.750	(108.0 - 120.7)

## Hanger Rod Clamp

- For 1/2" ATR.
- Furnished in pairs.
- Order ATR and hex nuts separately.
- Two-piece "J"-hanger design.
- 1350 lbs./pair capacity.
- (\*) Insert **ZN** or **G**

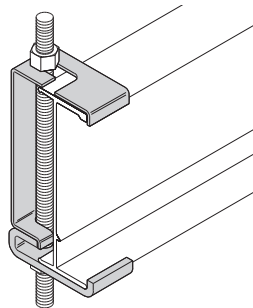

Catalog No.	Height	
	in.	mm
9(*)-5324	4	(101)
9(*)-5325	5	(127)
9(*)-5326	6	(152)
9(*)-5327	7	(178)

## Cable Tray Clamp/Guide

- Features a no-twist design.
- Has four times the strength of the traditional design.
- Each side is labeled to ensure proper installation.
- Furnished in pairs, with or without hardware.
- Not recommended for vertical support.

Note: For heavy duty or vertical applications see 9(\*)-1241 or 9(\*)-1242 page HAT-20

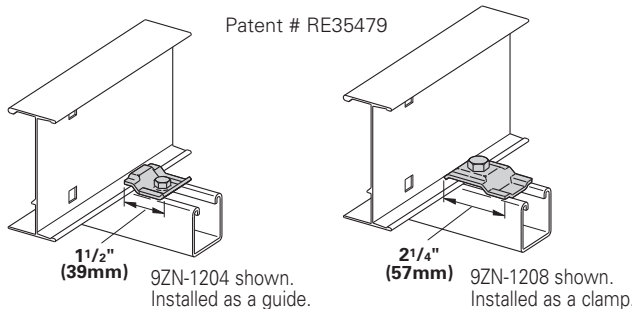

Catalog No.		Overall Length in. (mm)	Hardware Size in.	Finish
Without Hardware	With Hardware			
● 9ZN-1204	● 9ZN-1204NB	1 1/2 (38)	1/4"	G90
● 9ZN-1208	● 9ZN-1208NB	2 1/4 (57)	3/8"	G90
● 9A-1205	--	2 1/4 (57)	1/2"	Alum.
● 9G-1205	--	2 1/4 (57)	1/2"	HDGAF
● 9SS6-1205	--	2 1/4 (57)	1/2"	316SS
● 9ZN-1205	--	2 1/4 (57)	1/2"	G90

## Isolator Pad

- Use as a friction reducer and/or as a dissimilar metal isolator barrier.
- UV resistant HDPE.
- Temperature range: -100 to 160° F.
- Designed to use with 9(\*)-1205 or 9(\*)-1208 clamp/guide.
- Color - White.
- Patent Pending

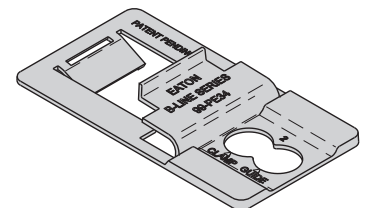
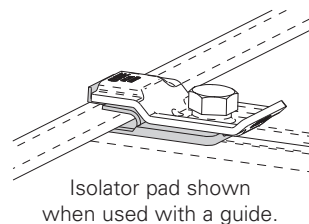
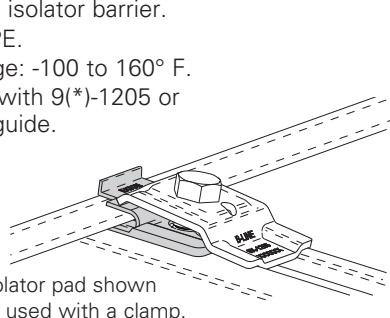

Catalog No.

● 99-PE34

● Green = Fastest shipped items    ● Black = Normal lead-time items    ● Red = Normally long lead-time items

All dimensions in parentheses are millimeters unless otherwise specified.

# Series 2, 3, 4, & 5 Aluminum - Accessories

## Combination Hold Down Guide Clamp

- Concentric hole location for ease of installation.
- Material: 6063-T6 Copper Free Aluminum.
- Allows for predrilled I-Beam locations.
- Designed for multiple support methods.
- No twist feature compatible with strut profile.
- Visual indicators for proper assembly.
- Compatible with aluminum and steel side rails.

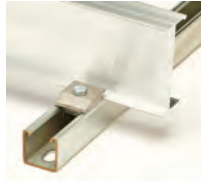

Shown on strut as a guide

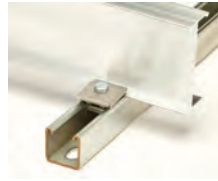

Shown on strut as a clamp

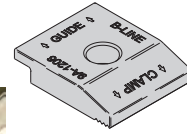

### Catalog No.

● 9A-1206

## Cable Tray Clamp

- Hold-down clamps for single or double cable tray runs.
- No drilling of support I-beam or channel is required.
- Sold in pieces - two clamps are required per tray.
- Maximum beam flange thickness 1 1/8" (28.58 mm).

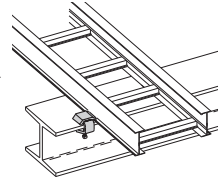
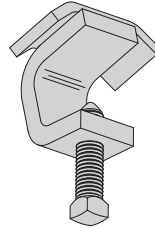

### Catalog No. Finish

● 9ZN-1249HD Znplt

● 9G-1249HD HDGAF

## Cable Tray Guide

- Expansion guide for single or double cable tray runs.
- Guide allows for longitudinal movement of the cable tray.
- No field drilling of support I-beam or channel is required.
- Guides are required on both sides of cable tray to prevent lateral movement - can be placed on either the inside or outside flange of cable tray.
- Guides are sold in pieces - two guides are required per tray.
- Maximum flange thickness 1 1/8" (28.58 mm).

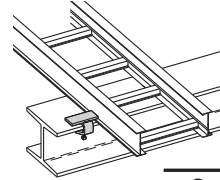
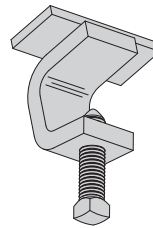

### Catalog No. Finish

● 9ZN-1249 Znplt

● 9G-1249 HDGAF

## Nylon Pad

- Use for friction reduction.
- Hardness: Shore D80.
- Low friction coefficient.
- UV resistant.
- Excellent weatherability.
- UL - 94HB.

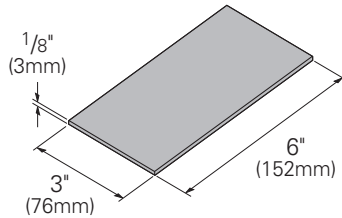

### Catalog No.

● 99-PE36

## Neoprene Roll

- Use for material isolation.
- 1/8" x 2" x 25' roll.
- Hardness: Shore A60.
- Good weatherability.

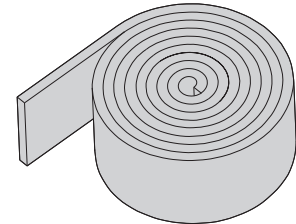

### Catalog No.

● 99-NP300

## DURA-BLOK™ Rooftop Support Bases with B22 Channel

- Designed as a superior rooftop support for cable tray,
- UV resistant and approved for most roofing material or other flat surfaces.
- Can be used with any of B-Line series cable tray clamps and guides.
- Ultimate Load Capacity: 1,000 lbs. (uniform load)



Catalog No.	Height x Width x Length in. (mm)
● DB10-28	5 <sup>5</sup> / <sub>8</sub> x 6 x 28.0 (143 x 152 x 711)
● DB10-36	5 <sup>5</sup> / <sub>8</sub> x 6 x 36.0 (143 x 152 x 914)
● DB10-42	5 <sup>5</sup> / <sub>8</sub> x 6 x 42.0 (143 x 152 x 1067)
● DB10-50	5 <sup>5</sup> / <sub>8</sub> x 6 x 50.0 (143 x 152 x 1270)
● DB10-60	5 <sup>5</sup> / <sub>8</sub> x 6 x 60.0 (143 x 152 x 1524)



LEEDS credit available, base made from 100% recycled material.

General Note: Consult roofing manufacturer or engineer for roof load capacity. The weakest point may be the insulation board beneath the rubber membrane.

● Green = Fastest shipped items ● Black = Normal lead-time items ● Red = Normally long lead-time items

All dimensions in parentheses are millimeters unless otherwise specified.

## Trapeze Support Kit

- Eaton's B-Line series trapeze kits provide the components required for a single trapeze support in one package. These kits are available in pre-galvanized steel with zinc-plated hardware, hot dip galvanized steel with 316 stainless steel hardware, or DURA GREEN™ painted steel with zinc-plated hardware.
- The SH channel provides the convenience of pre-punched slots, which eliminate the need for field drilling.
- The illustrated hardware is sealed in a plastic bag and boxed with the channel, which is pre-cut to the appropriate length as shown in the chart.
- Designed for use with 1/2" threaded rod. Order rod separately.

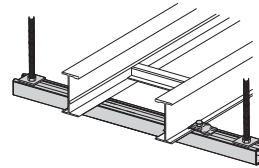
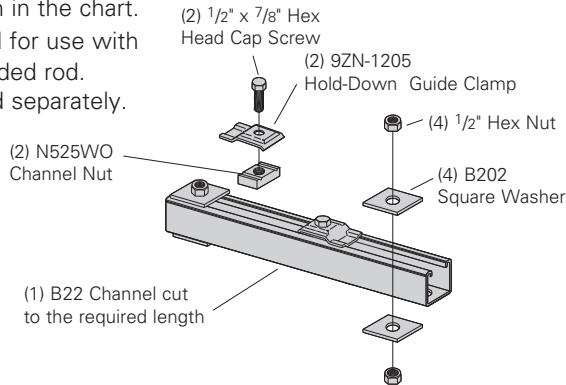

Catalog No.	Tray Width		Channel Length		Uniform Load	
	in.	mm	in.	mm	lbs	kN
● 9(*)-5506-22SH(†)	6	(152)	16	(406)	1350	(6.00)
● 9(*)-5509-22SH(†)	9	(229)	18	(457)	1250	(5.56)
● 9(*)-5512-22SH(†)	12	(305)	22	(559)	1125	(5.00)
● 9(*)-5518-22SH(†)	18	(457)	28	(711)	865	(3.85)
● 9(*)-5524-22SH(†)	24	(610)	34	(864)	700	(3.11)
● 9(*)-5530-22SH(†)	30	(762)	40	(1016)	590	(2.62)
● 9(*)-5536-22SH(†)	36	(914)	46	(1168)	510	(2.27)
● 9(*)-5542-22SH(†)	42	(1067)	52	(1321)	450	(2.00)

- (\*) Insert **P** **G** or **GRN**
- (†) Insert 3/8 for 3/8" threaded rod hardware. Safety factor of 3.0 on all loads.

## Heavy Duty Trapeze Support Kit

- Eaton's B-Line series trapeze kits provide the components required for a single trapeze support in one package. These kits are available in pre-galvanized steel with zinc-plated hardware, hot dip galvanized steel with 316 stainless steel hardware, or DURA GREEN™ painted steel with zinc-plated hardware.
- The SH channel provides the convenience of pre-punched slots, which eliminates the need for field drilling.
- The illustrated hardware is sealed in a plastic bag and boxed with the channel, which is pre-cut to the appropriate length as shown in the chart.
- Designed for use with 1/2" threaded rod. Order rod separately.

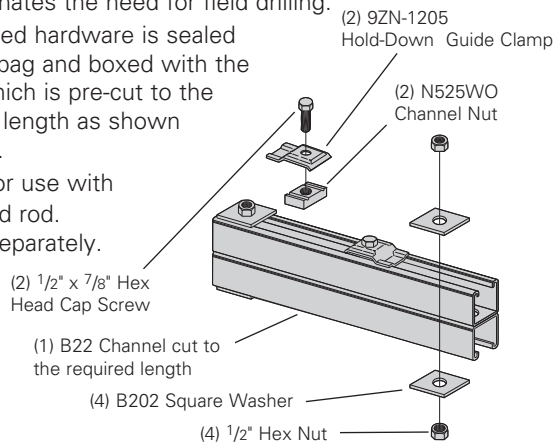

Catalog No.	Tray Width		Channel Length		Uniform Load	
	in.	mm	in.	mm	lbs	kN
● 9(*)-5506-22SHA	6	(152)	16	(406)	1350	(6.00)
● 9(*)-5509-22SHA	9	(229)	18	(457)	1350	(6.00)
● 9(*)-5512-22SHA	12	(305)	22	(559)	1350	(6.00)
● 9(*)-5518-22SHA	18	(457)	28	(711)	1350	(6.00)
● 9(*)-5524-22SHA	24	(610)	34	(864)	1350	(6.00)
● 9(*)-5530-22SHA	30	(762)	40	(1016)	1350	(6.00)
● 9(*)-5536-22SHA	36	(914)	46	(1168)	1350	(6.00)
● 9(*)-5542-22SHA	42	(1067)	52	(1321)	1350	(6.00)

- (\*) Insert **P** **G** or **GRN**
- Safety factor of 3.0 on all loads.

## Trapeze Hardware Kit

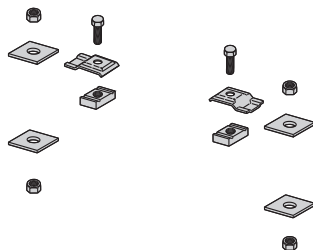

Catalog No.	● 9ZN-5500-1/2	● 9G-5500-1/2
In plastic bag	1 pr. 9ZN-1205 2 HHC Screw 1/2 x 7/8 ZN 2 N525 WO ZN 4 B202 ZN 1/2" sq washer 4 HN 1/2" ZN	1 pr. 9G-1205 2 HHC Screw 1/2 x 7/8 SS6 2 N525 WO SS6 4 B202 HDG 1/2" sq washer 4 HN 1/2" SS6

● Green = Fastest shipped items    ● Black = Normal lead-time items    ● Red = Normally long lead-time items

All dimensions in parentheses are millimeters unless otherwise specified.

# Series 2, 3, 4, & 5 Aluminum - Accessories

## Center Hung Tray Support

- Center Hung Cable Tray Support allows cable to be laid-in from both sides.
- Eliminates costly cable pulling and field cutting of cable tray supports. Labor costs are dramatically reduced.
- Required hardware and threaded rod material for trapeze assemblies are reduced by up to 50%.
- Designed for use with 1/2" threaded rod. (Order rod separately)
- Use with all aluminum and steel cable trays through 24" width.
- Load capacity is 700 lbs. (311kN) per support. Safety factor of 3.0. Eccentric loading is not to exceed a 60% vs. 40% load differential.
- The maximum recommended unsupported span length is 144"/12 ft. (3.66 m).
- Hardware shown is furnished.
- Finish available: Zinc Plated

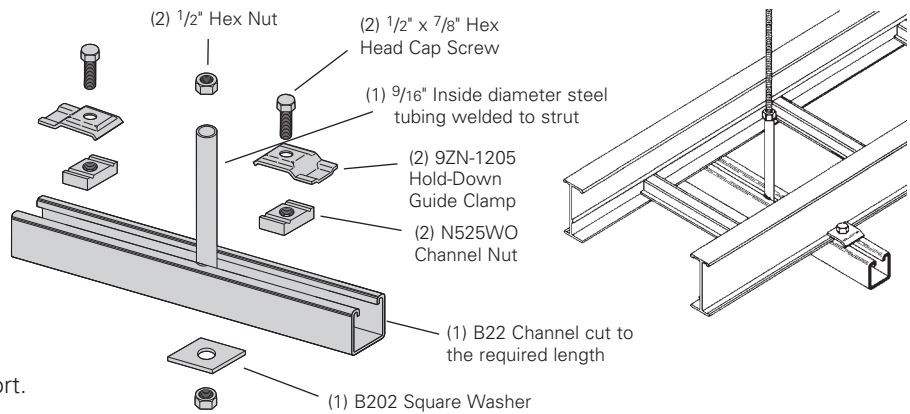

Catalog No.	Tray Width		Channel Length	
	in.	(mm)	in.	(mm)
● 9ZN-5212	6", 9", 12"	(152, 228, 305)	18"	(457)
● 9ZN-5224	18", 24"	(457, 609)	30"	(762)

## Center Hung Support Hardware Kit

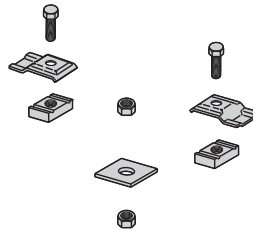

Catalog No.	● 9ZN-5200
In plastic bag	1 pr. 9ZN-1205 2 HHC Screw 1/2 x 7/8 ZN 2 N525 WO ZN 1 B202 ZN 1/2" sq washer 4 HN 1/2 ZN

## Bracket (12" - 48")

- (\*) Insert available finish: **ZN** **GRN** or **HDG**
- Safety Load Factor 2.5

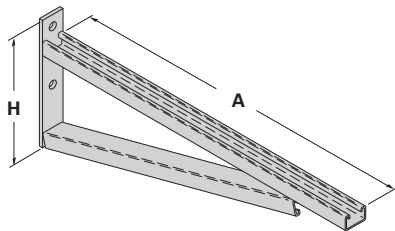

Bottom brace is B42 channel on B494-24 and smaller and B22 channel on B494-30 and larger

Catalog No.	Uniform Load lbs (kN)	Tray Width		'A'		'H'	
		in.	(mm)	in.	(mm)	in.	(mm)
● B494-12	2500 (11.12)	6 & 9 (152 & 229)		12 (305)	8 <sup>3</sup> / <sub>4</sub> (222)		
● B494-18	1700 (7.56)	12 (305)		18 (457)	8 <sup>3</sup> / <sub>4</sub> (222)		
● B494-24	1300 (5.78)	18 (457)		24 (610)	8 <sup>3</sup> / <sub>4</sub> (222)		
● B494-30	1600 (7.11)	24 (610)		30 (762)	11 <sup>1</sup> / <sub>4</sub> (286)		
● B494-36	1100 (4.89)	30 (762)		36 (914)	11 <sup>1</sup> / <sub>4</sub> (286)		
● B494-42	980 (4.36)	36 (914)		42 (1067)	16 (406)		
● B494-48	980 (4.36)	42 (1067)		48 (1219)	16 (406)		

For more dimensional data see Strut Systems catalog

## Cantilever Bracket

- (\*) Insert available finish: **ZN** **GRN** **HDG** **SS4** or **SS6**
- Safety Load Factor 2.5

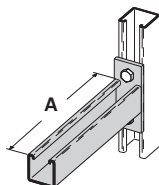

Catalog No.	Uniform Load		Tray Width		'A'	
	lbs	kN	in.	mm	in.	mm
B409-12	960	(4.27)	6 & 9 (152 & 229)		12	(305)
B409-18	640	(2.84)	12 (305)		18	(457)
B409-24	480	(2.13)	18 (457)		24	(610)

● Green = Fastest shipped items ● Black = Normal lead-time items ● Red = Normally long lead-time items

All dimensions in parentheses are millimeters unless otherwise specified.

# Series 2, 3, 4, & 5 Aluminum - Accessories

## Cantilever Bracket

- (\*) Insert available finish: **ZN** **GRN** **HDG** or **SS4**
- Safety Load Factor 2.5

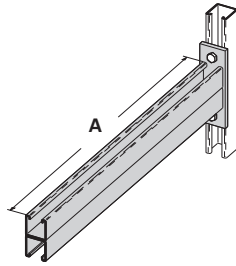

Catalog No.	Uniform Load		Tray Width		'A'	
	lbs	kN	in.	mm	in.	mm
<b>B297-12</b>	1660	(7.38)	6 & 9	(152 & 229)	12	(305)
<b>B297-18</b>	1100	(4.89)	12	(305)	18	(457)
<b>B297-24</b>	835	(3.71)	18	(457)	24	(610)
<b>B297-30</b>	665	(2.93)	24	(610)	30	(762)
<b>B297-36</b>	550	(2.44)	30	(762)	36	(914)
<b>B297-42</b>	465	(2.06)	36	(914)	42	(1067)

## Underfloor Support (U-Bolts not included)

- Finishes available: **ZN**
- Safety Load Factor 2.5

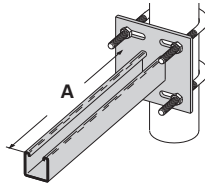

U-Bolt Size	Fits Pipe O.D.
B501-3/4	.841 - 1.050
B501-1	1.051 - 1.315
B501-1 1/4	1.316 - 1.660
B501-1 1/2	1.661 - 1.900
B501-2	1.901 - 2.375
B501-2 1/2	2.376 - 2.875

Catalog No.	Uniform Load		Tray Width		'A'	
	lbs	(kN)	in.	(mm)	in.	(mm)
<b>B409UF-12</b>	800	(3.56)	6 & 9	(152 & 229)	12	(305)
<b>B409UF-21</b>	450	(2.00)	12 & 18	(305 & 457)	21	(533)

## Vertical Hanger Splice Plates

- Design load is 1500 lbs (6.67kN) per pair.
- Safety Factor of 2.5
- Furnished in pairs.
- Hole size: 9/16" (14mm) for 1/2" threaded rod.

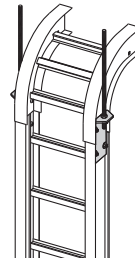
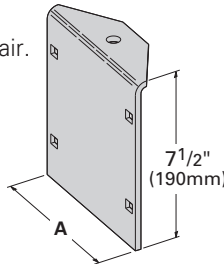

Catalog No.	Outside Cable Tray Ht.	'A'	
		in.	(mm)
● <b>9A-1224</b>	4"	3.84	(97.54)
● <b>9A-1225</b>	5"	4.73	(120.14)
● <b>9A-1226</b>	6"	5.84	(148.34)
● <b>9A-1227</b>	7"	6.84	(173.74)

## Heavy Duty Hold Down Bracket

- Design load is 2000 lbs (8.89kN) per pair.
- Two bolt design.
- Sold in pairs.
- 3/8" cable tray attachment hardware provided.
- 1/2" support attachment hardware **not** provided.
- (\*) Insert **ZN** **SS4** or **SS6**
- Recommended for support of vertical trays.

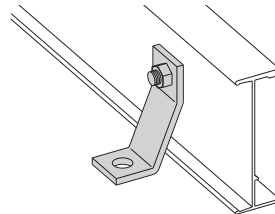

Catalog No.  
**9(\*)-1241**

## Heavy Duty Hold Down Bracket

- Design load is 4000 lbs (17.79kN) per pair.
- Four bolt design.
- Sold in pairs.
- 3/8" cable tray attachment hardware provided.
- 1/2" support attachment hardware **not** provided.
- (\*) Insert **ZN** **SS4** or **SS6**
- Recommended for support of vertical trays.

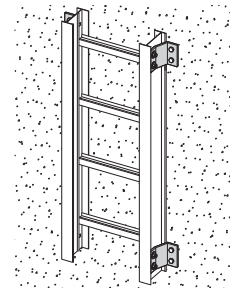
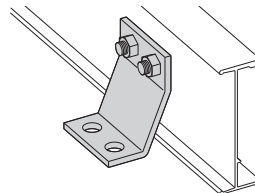

Catalog No.  
**9(\*)-1242**

## Beam Clamp

- Finishes available: **ZN** **GRN** **HDG** or **SS4**
- Sold in pieces.
- Design load is 1200 lbs (5.34kN) per pair.
- Safety Load Factor 5.0.
- Order HHCS and Channel Nuts separately.

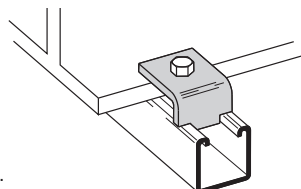

Catalog No.  
**B355**

● Green = Fastest shipped items    ● Black = Normal lead-time items    ● Red = Normally long lead-time items

All dimensions in parentheses are millimeters unless otherwise specified.



# Series 2, 3, 4, & 5 Aluminum - Accessories

## Beam Clamp

- Finishes available: **ZN** or **HDG**
- Sold in pieces.
- \*Design load when used in pairs.  
Safety Load Factor 5.0

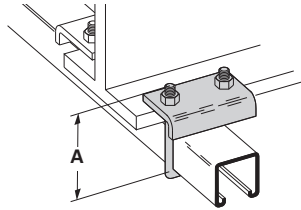

Catalog No.	Design Load lbs (kN)	'A' in. (mm)
<b>B441-22</b>	1200 (5.34)	3 <sup>3</sup> / <sub>8</sub> (86)
<b>B441-22A</b>	1200 (5.34)	5 (127)

## Beam Clamp

- Finishes available: **ZN** **GRN** or **HDG**
- Sold in pieces.
- \*Design load when used in pairs.  
Safety Load Factor 5.0

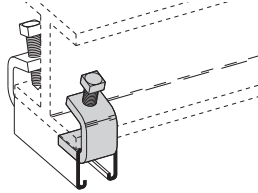

Catalog No.	B212-1/4	B212-3/8
<b>Design Load *</b>	600 lbs. (2.67kN)	1000 lbs. (4.45 kN)
<b>Max. Flange Thick</b>	3/4" (19 mm)	1 1/8" (28.6 mm)
<b>Mat'l. Thickness</b>	1/4" (6.3 mm)	3/8" (9.5 mm)

## B305 Thru B308 & B321 Series Beam Clamps

- Finishes available: **ZN** or **HDG**
- Setscrew included.
- Safety Load Factor 5.0

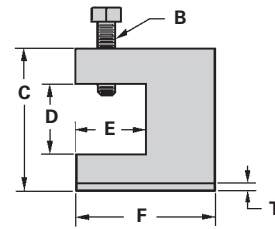
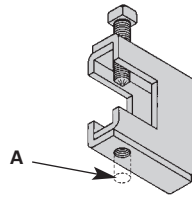

Catalog No.	Rod Size A	B	C in. (mm)	D in. (mm)	E in. (mm)	F in. (mm)	T in. (mm)	Design Load lbs (kN)
<b>B305</b>	3/8"-16	3/8"-16	2 <sup>5</sup> / <sub>16</sub> (58.7)	7/8 (22.2)	1 1/8 (28.6)	2 1/2 (63.5)	11 Ga. (3.0)	600 (2.67)
<b>B306</b>	3/8"-16	1/2"-13	2 <sup>7</sup> / <sub>16</sub> (61.9)	7/8 (22.2)	1 1/8 (28.6)	2 1/2 (63.5)	7 Ga. (4.5)	1100 (4.90)
<b>B307</b>	1/2"-13	1/2"-13	2 <sup>7</sup> / <sub>16</sub> (61.9)	7/8 (22.2)	1 1/8 (28.6)	2 1/2 (63.5)	7 Ga. (4.5)	1100 (4.90)
<b>B308</b>	1/2"-13	1/2"-13	2 <sup>9</sup> / <sub>16</sub> (65.1)	7/8 (22.2)	1 1/8 (28.6)	2 1/2 (63.5)	1/4 (6.3)	1500 (6.68)
<b>B321-1</b>	3/8"-16	1/2"-13	3 <sup>9</sup> / <sub>16</sub> (90.5)	1 11/16 (42.9)	1 <sup>5</sup> / <sub>8</sub> (41.3)	3 1/4 (82.5)	1/4 (6.3)	1300 (5.79)
<b>B321-2</b>	1/2"-13	1/2"-13	3 <sup>9</sup> / <sub>16</sub> (90.5)	1 11/16 (42.9)	1 <sup>5</sup> / <sub>8</sub> (41.3)	3 1/4 (82.5)	1/4 (6.3)	1400 (6.23)

## Anchor Strap - for B305 thru B308 & B321 Series

- Finish available: **ZN**
- For a maximum beam thickness of 3/4" (19mm).
- For thicker beams, step up one flange width size.

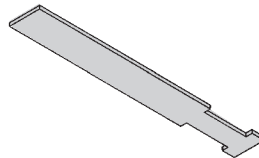

Catalog No.	Flange Width in. (mm)
<b>B312-6</b>	Up to 6 (Up to 152)
<b>B312-9</b>	6 - 9 (152 to 228)
<b>B312-12</b>	9 - 12 (228 to 305)

## Beam Clamp

- Finish available: **ZN**
- Design Load 500 lbs. (2.22 kN)
- Safety Load Factor 5.0
- Recommended torque:  
'J'-Hook Nut 125 In.-Lbs. (14.1 kN/m)
- Maximum flange thickness  
of 3/4" (19mm).

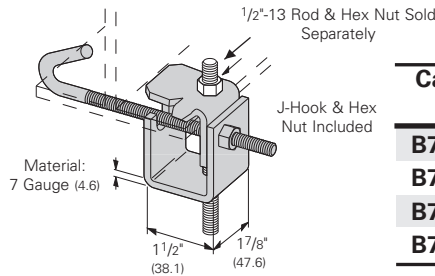

Catalog No.	For Flange Width in. (mm)	Wt./C lbs (kg)
<b>B750-J4</b>	3 - 6 (76.2 - 152.4)	109 (49.4)
<b>B750-J6</b>	5 - 9 (127.0 - 228.6)	124 (56.2)
<b>B750-J9</b>	8 - 12 (203.2 - 304.8)	135 (61.2)
<b>B750-J12</b>	11 - 15 (279.4 - 381.0)	147 (66.7)

## 'J'-Hook

- Finishes available: **ZN**
- Hex Nut included.

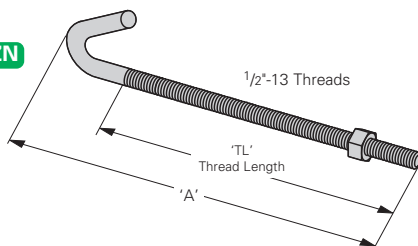

Catalog No.	'A' in. (mm)	'TL' in. (mm)	Wt./C lbs (kg)
<b>B700-J4</b>	8 1/2 (215.9)	5 (127.0)	44 (19.9)
<b>B700-J6</b>	11 1/2 (292.1)	6 (152.4)	53 (24.0)
<b>B700-J9</b>	12 1/4 (368.3)	6 (152.4)	63 (28.6)
<b>B700-J12</b>	17 1/2 (444.5)	6 (152.4)	78 (35.4)

● Green = Fastest shipped items ● Black = Normal lead-time items ● Red = Normally long lead-time items

All dimensions in parentheses are millimeters unless otherwise specified.

## Covers

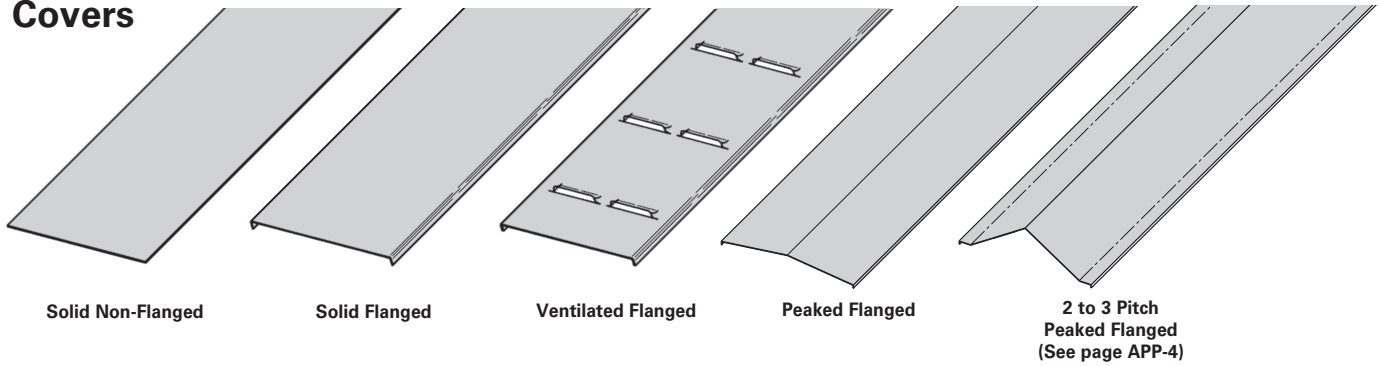

A full range of covers is available for straight sections and fittings.

**Solid covers** should be used when maximum enclosure of the cable is desired and no accumulation of heat is expected.

**Ventilated covers** provide an overhead cable shield, yet allow heat to escape.

We recommend that covers be placed on vertical cable tray runs to a height of 6 ft. (1.83 m) to 8 ft. (2.44 m) above the floor to isolate both cables and personnel. **Flanged covers** have a 1/2 in. (13 mm) flange. Cover clamps are not included with the cover and must be ordered separately. All **peaked covers** are flanged. Standard peaked covers have 1/2" peak. Special purpose peaked covers, having a 2 to 3 pitch, provide additional slope and material thickness. The 2 to 3 pitch fitting covers are of multiple piece, welded construction.

## Aluminum Cover Part Numbering

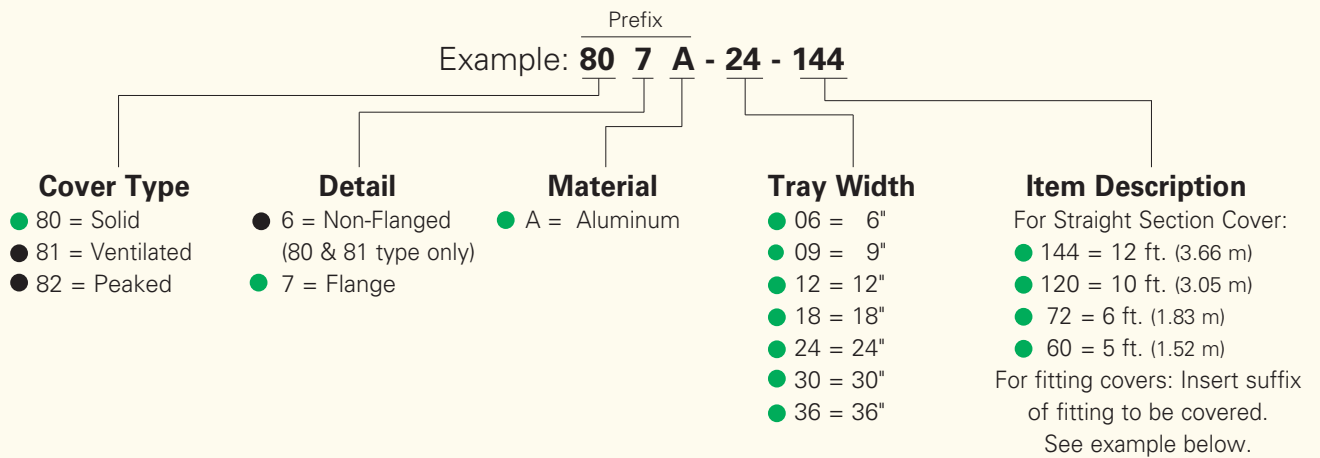

### Examples of Catalog Numbers for Fitting Covers:

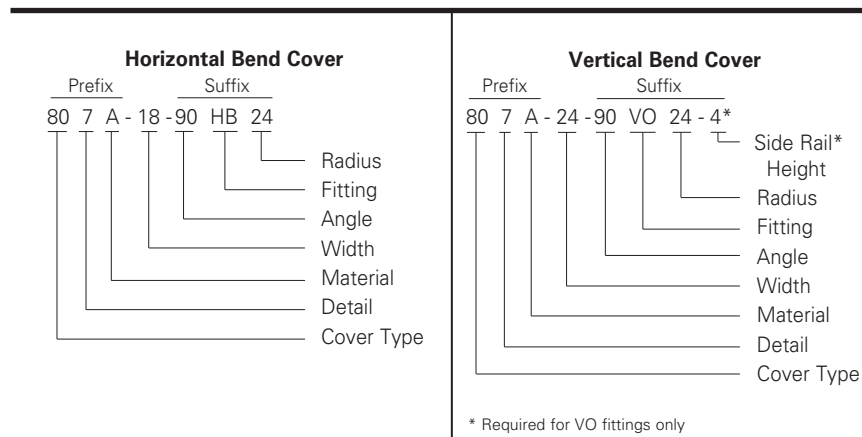

● Green = Fastest shipped items    ● Black = Normal lead-time items    ● Red = Normally long lead-time items

All dimensions in parentheses are millimeters unless otherwise specified.

# Series 2, 3, 4, & 5 Aluminum - Accessories

## Standard Cover Clamp

- For indoor service only.
- Setscrew included.
- Sold per piece.

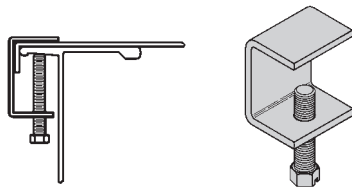

Tray Type	Catalog No.	Side Rail Height
Aluminum	● 9ZN-9012	All Sizes
	● 9A-9012	

## Combination Cover and Hold Down Clamp

- Sold per piece.
- For indoor service only.

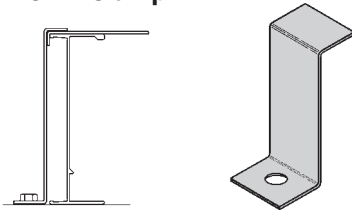

Tray Type	Catalog No.	Side Rail Height	
		in.	(mm)
Aluminum	● 9A-9043	4	(101)
	● 9A-9053	5	(127)
	● 9A-9063	6	(152)
	● 9A-9073	7	(78)

## Raised Cover Clamp

- For indoor service only.
- For use with flanged covers only.  
† Specify gap of 1", 2", 3" or 4".

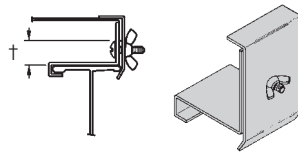

Tray Type	Catalog No.	Side Rail Height
Aluminum	● 9ZN-9112-†	4 & 5 Deep
	● 9ZN-9113-†	6 & 7 Deep

## Heavy Duty Cover Clamp

- Recommended for outdoor service.
- (‡) Insert tray width  
† Add P to Catalog No.  
for peaked cover clamp.

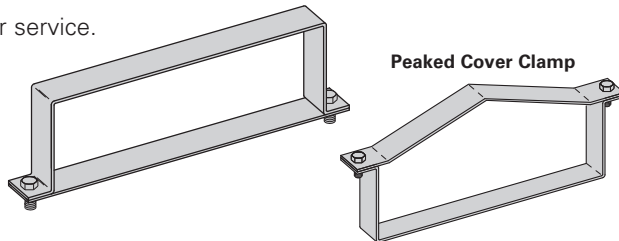

Catalog No.	Side Rail Height	
	in.	mm
● 9A-(‡)-9044†	4	(101)
● 9A-(‡)-9054†	5	(127)
● 9A-(‡)-9064†	6	(152)
● 9A-(‡)-9074†	7	(178)

## Quantity of Standard Cover Clamps Required

Notes:

When using the Heavy Duty Cover Clamp, only on-half the number of clamps stated above is required.

Additional clamps may be necessary in extreme wind applications.

Straight Section 60" or 72"	4 pcs.
Straight Section 120" or 144"	6 pcs.
Horizontal/Vertical Bends	4 pcs.
Tees	6 pcs.
Crosses	8 pcs.

## Cover Joint Strip

- Used to join covers
- Plastic
- (‡) Insert tray width

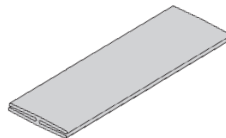

Catalog No.
● 99-9980-(‡)

## Cable Cleats

(see pages O-1 thru O-5) Standard

Trefoil  
Cable  
Cleats



Single  
Cable  
Cleats

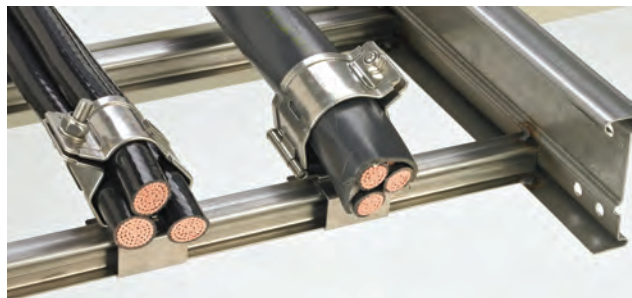
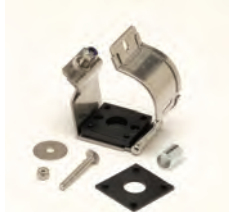

● Green = Fastest shipped items   ● Black = Normal lead-time items   ● Red = Normally long lead-time items

All dimensions in parentheses are millimeters unless otherwise specified.

## Section 1- Acceptable Manufacturers

- 1.01 Manufacturer: Subject to compliance with these specifications, Eaton's B-Line series cable tray systems shall be as manufactured by Eaton.

## Section 2- Cable Tray Sections and Components

- 2.01 General: Except as otherwise indicated, provide metal cable trays, of types, classes and sizes indicated; with splice plates, bolts, nuts and washers for connecting units. Construct units with rounded edges and smooth surfaces; in compliance with applicable standards; and with the following additional construction features. Cable tray shall be installed according to the latest revision of NEMA VE 2.
- 2.02 Materials and Finish: Straight section and fitting side rails and rungs shall be extruded from Aluminum Association Alloy 6063. All fabricated parts shall be made from Aluminum Association Alloy 5052.
- 2.03 Ladder Cable Trays shall consist of two longitudinal members (side rails) with transverse members (rungs) welded to the side rails. Rungs shall be spaced [6] [9] [12] inches apart. Rung spacing in radiused fittings shall be industry standard 9" and measured at the center of the tray's width. Each rung must be capable of supporting a 200 lb. concentrated load at the center of the cable tray over and above the cable load with a safety factor of 1.5.
- 2.04 Ventilated Trough Cable Trays shall consist of two longitudinal members (side rails) with a corrugated bottom welded to the side rails or rungs spaced 4" apart. The peaks of the corrugated bottom shall have a minimum flat cable bearing surface of 2<sup>3</sup>/<sub>4</sub>" and shall be spaced on 6" centers. To provide ventilation in the tray, the valleys of the corrugated bottom shall have 2<sup>1</sup>/<sub>4</sub>" x 4" rectangular holes punched along the width of the bottom.
- 2.05 Non-Ventilated Bottom Trough Cable Trays shall consist of two longitudinal members (side rails) with a corrugated bottom welded to the side rails or a solid sheet over rungs. The peaks of the corrugated bottom shall have a minimum flat cable bearing surface of 2<sup>3</sup>/<sub>4</sub>" and shall be spaced on 6" centers.
- 2.06 Cable tray loading depth shall be [3] [4] [5] [6] inches per NEMA VE 1.
- 2.07 Straight sections shall have side rails fabricated as I-beams. Straight sections shall be supplied in standard [12 foot] [24 foot] [10 foot (3 m)] [20 foot (6 m)] lengths.
- 2.08 Cable tray widths shall be [6] [9] [12] [18] [24] [30] [36] inches or as shown on drawings.
- 2.09 Splice plates shall be the Wedge-Lock design with 4 nuts and bolts per plate. The resistance of fixed splice connections between an adjacent section of tray shall not exceed 0.00033 ohm.
- 2.10 All fittings must have a minimum radius of [12] [24] [36] [48] inches.

## Section 3- Loading Capacities and Testing

- 3.01 Cable tray shall be capable of carrying a uniformly distributed load of \_\_\_\_\_ lbs./ft. on a \_\_\_\_\_ ft. support span with a safety factor of 1.5 when supported as a simple span and tested per NEMA VE 1 5.2. In addition to the uniformly distributed load the cable tray shall support 200 lbs. concentrated load at mid-point of span. Load and safety factors specified are applicable to both the side rails and rung capacities. Cable tray shall be made to manufacturing tolerances as specified by NEMA.
- 3.02 Upon request, manufacturer shall provide test reports in accordance with the latest revision of NEMA VE 1 or CSA C22.2 No. 126.

# Series 2, 3, 4, & 5 Steel - Straight Sections

Series 2, 3, 4, & 5 Steel



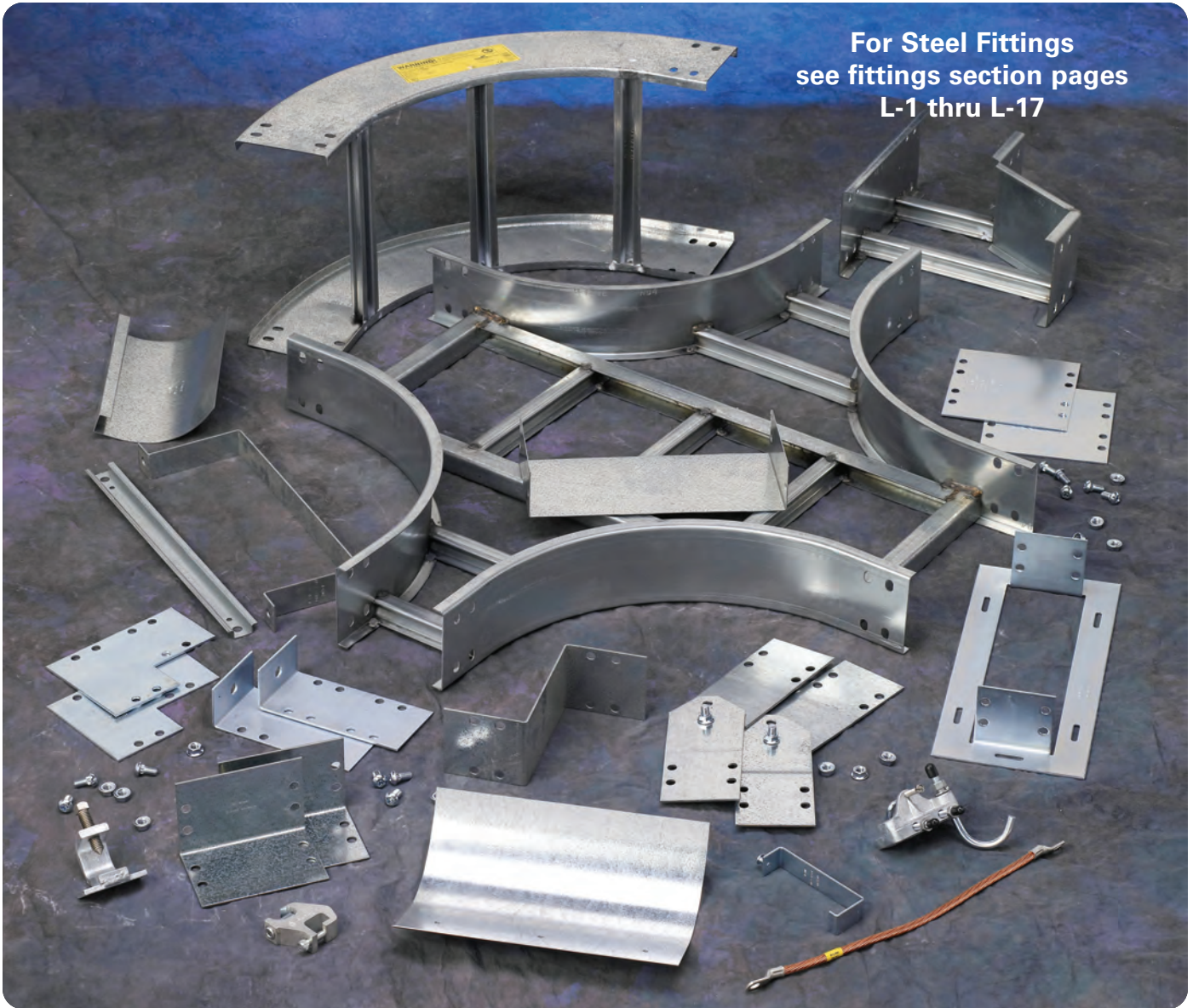

For Steel Fittings  
see fittings section pages  
L-1 thru L-17

## How The Service Advisor Works

We know that your time is important! That's why the color-coding system in this catalog is designed to help you select products that fit your service needs. Products are marked to indicate the typical lead time for orders of 50 pieces or less.

**Customer:** How do I select my straight sections, covers, or fittings so that I get the quickest turnaround?

**Service Advisor:** Each part of our selection chart is shown in colors. If any section of a part number is a different color, the part will typically ship with the longer lead time represented by the colors.

- Green = Fastest shipped items
- Black = Normal lead-time items
- Red = Normally long lead-time items

**Example:**            258G   12   -   24   -   144  
                             ●       ●       ●       ●

**Part will have a long lead time because of the 258G material.**

Changing the part number from 258G to 258P will change the coding to black and reduce lead time.

## 3" NEMA VE 1 Loading Depth 4" Side Rail Height

### Straight Section Part Numbering

Prefix  
Example: **248 P 09 - 24 - 144**

Series	Material	*Type	*Width	Length
● 248	● P = Pre-Galvanized ● G = HDGAF	<b>Ladder-</b> ● 06 = 6" rung spacing ● 09 = 9" rung spacing ● 12 = 12" rung spacing	● 06 = 6" ● 09 = 9" ● 12 = 12" ● 18 = 18" ● 24 = 24" ● 30 = 30" ● 36 = 36"	● ① 144 = 12 ft. ● ② 120 = 10 ft.
● 346				● ① 240 = 20 ft. ● ② 144 = 12 ft.
● 444				● ① 240 = 20 ft. ● ② 288 = 24 ft.

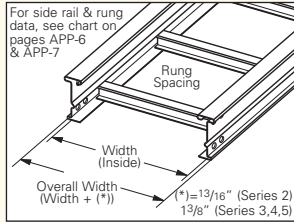

#### Trough- 6" thru 36" wide

- VT = Ventilated Trough
- ST = Non-Ventilated Trough

① Primary Length.  
② Secondary Length.

See page C-23 for explanation of lengths.

See page APP-1 for additional rung options. \*Special sizes available.

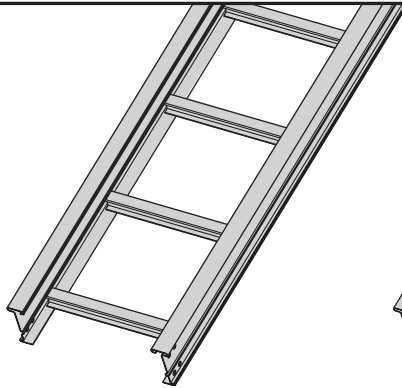

Ladder Type  
(Specify Rung Spacing)

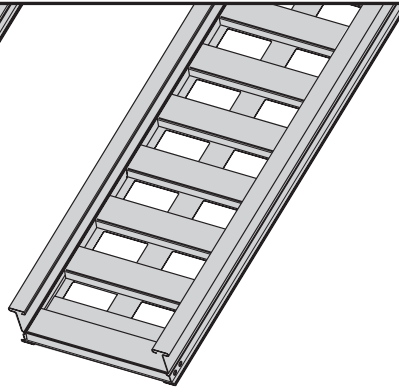

Ventilated Trough

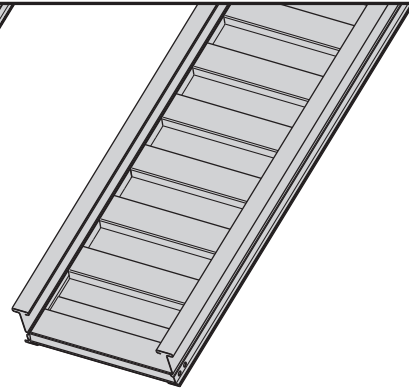

Non-Ventilated Trough

● Green = Fastest shipped items   ● Black = Normal lead-time items   ● Red = Normally long lead-time items

All dimensions in parentheses are millimeters unless otherwise specified.

## 3" NEMA VE 1 Loading Depth 4" Side Rail Height

Values are based on simple beam tests per NEMA VE 1 on 36" wide cable tray with rungs spaced on 12" centers. Cable trays will support without collapse a 200 lb. (90.7 kg) concentrated load over and above published loads. Published load safety factor is 1.5. To convert 1.5 safety factor to 2.0, multiply published load by 0.75. To obtain mid-span deflection, multiply a load by the deflection multiplier. Cable tray must be supported on spans shorter than or equal to the length of the cable tray being installed.

Individual rungs will support without collapse a 200 lb. (90.7 kg) concentrated load applied at the mid-span of the rung, over and above the NEMA rated cable load with a 1.5 safety factor for highlighted NEMA spans and loads.

B-Line Series	Side Rail Dimensions	NEMA, CSA & UL Classifications	Span ft	Load lbs/ft	Deflection Multiplier	Design Factors for Two Rails	Span meters	Load kg/m	Deflection Multiplier	Design Factors for Two Rails
248		NEMA: 16A, 12C CSA: D1-3m  UL Cross-Sectional Area: 0.40 in <sup>2</sup>	6	412*	0.0007	Area = 0.62 in <sup>2</sup> Sx = 0.64 in <sup>3</sup> Ix = 1.43 in <sup>4</sup>	1.8	613*	0.012	Area = 4.00 cm <sup>2</sup> Sx = 10.49 cm <sup>3</sup> Ix = 59.52 cm <sup>4</sup>
			8	232	0.0022		2.4	345	0.038	
			10	148	0.0054		3.0	221	0.093	
			12	103	0.011		3.7	153	0.192	
			14	76	0.021		4.3	113	0.356	
			16	58	0.036		4.9	86	0.607	

B-Line Series	Side Rail Dimensions	NEMA, CSA & UL Classifications	Span ft	Load lbs/ft	Deflection Multiplier	Design Factors for Two Rails	Span meters	Load kg/m	Deflection Multiplier	Design Factors for Two Rails
346		NEMA: 20A, 16B CSA: D1-6m  UL Cross-Sectional Area: 0.70 in <sup>2</sup>	10	252	0.0036	Area = 0.89 in <sup>2</sup> Sx = 0.96 in <sup>3</sup> Ix = 2.22 in <sup>4</sup>	3.0	375	0.060	Area = 5.74 cm <sup>2</sup> Sx = 15.73 cm <sup>3</sup> Ix = 92.40 cm <sup>4</sup>
			12	175	0.0072		3.7	260	0.124	
			14	129	0.013		4.3	191	0.229	
			16	98	0.023		4.9	146	0.391	
			18	78	0.037		5.5	116	0.626	
			20	63	0.056		6.1	94	0.955	

B-Line Series	Side Rail Dimensions	NEMA, CSA & UL Classifications	Span ft	Load lbs/ft	Deflection Multiplier	Design Factors for Two Rails	Span meters	Load kg/m	Deflection Multiplier	Design Factors for Two Rails
444		NEMA: 20B, 16C CSA: E-3m  UL Cross-Sectional Area: 1.00 in <sup>2</sup>	12	253	0.0055	Area = 1.19 in <sup>2</sup> Sx = 1.27 in <sup>3</sup> Ix = 2.94 in <sup>4</sup>	3.7	376	0.093	Area = 7.68 cm <sup>2</sup> Sx = 20.81 cm <sup>3</sup> Ix = 122.37 cm <sup>4</sup>
			16	142	0.027		4.9	212	0.295	
			18	112	0.028		5.5	167	0.473	
			20	91	0.042		6.1	135	0.721	
			22	75	0.062		6.7	112	1.055	
			24	63	0.088		7.3	94	1.495	

\*When using 18" rung spacing, load capacity is limited to 394 lbs/ft (586.272 kg/m) for 30" cable tray width and 325 lbs/ft (483.6 kg/m) for 36" cable tray width. When cable trays are used in continuous spans, the deflection of the cable tray is reduced by as much as 50%. Design factors: Ix = Moment of Inertia, Sx = Section Modulus.

All dimensions in parentheses are millimeters unless otherwise specified.



## 4" NEMA VE 1 Loading Depth 5" Side Rail Height

### Straight Section Part Numbering

Example: <sup>Prefix</sup> **258 P 09 - 24 - 144**

Series	Material	*Type	*Width	Length	
● 258	● P = Pre-Galvanized ● G = HDGAF	<b>Ladder-</b> ● 06 = 6" rung spacing ● 09 = 9" rung spacing ● 12 = 12" rung spacing	● 06 = 6" ● 09 = 9" ● 12 = 12" ● 18 = 18" ● 24 = 24" ● 30 = 30" ● 36 = 36"	● ① 144 = 12 ft. ● ② 120 = 10 ft.	258
● 356				● ① 240 = 20 ft. ● ② 144 = 12 ft.	356
● 454				● ① 240 = 20 ft. ● ② 288 = 24 ft.	454

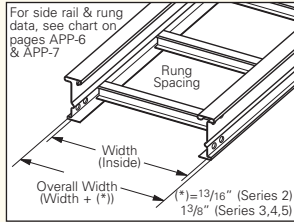

#### Trough- 6" thru 36" wide

- VT = Ventilated Trough
- ST = Non-Ventilated Trough

① Primary Length.  
② Secondary Length.

See page C-23 for explanation of lengths.

See page APP-1 for additional rung options. \*Special sizes available.

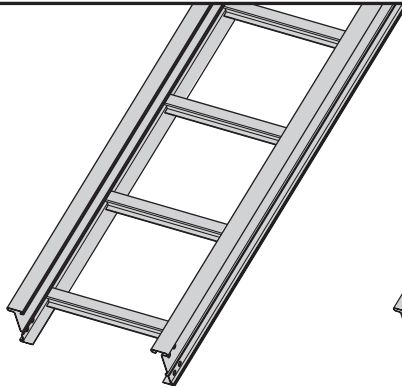

Ladder Type  
(Specify Rung Spacing)

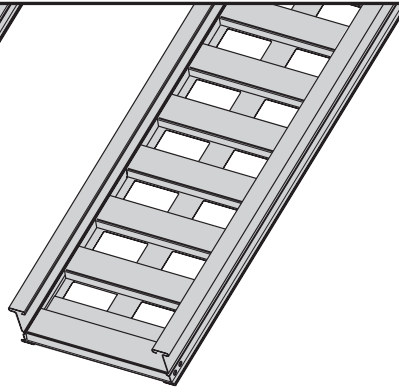

Ventilated Trough

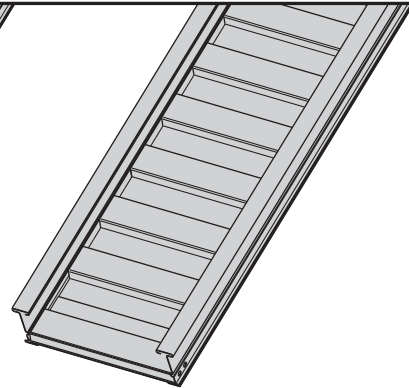

Non-Ventilated Trough

● Green = Fastest shipped items    ● Black = Normal lead-time items    ● Red = Normally long lead-time items

All dimensions in parentheses are millimeters unless otherwise specified.

## 4" NEMA VE 1 Loading Depth 5" Side Rail Height

Values are based on simple beam tests per NEMA VE 1 on 36" wide cable tray with rungs spaced on 12" centers. Cable trays will support without collapse a 200 lb. (90.7 kg) concentrated load over and above published loads. Published load safety factor is 1.5. To convert 1.5 safety factor to 2.0, multiply published load by 0.75. To obtain mid-span deflection, multiply a load by the deflection multiplier. Cable tray must be supported on spans shorter than or equal to the length of the cable tray being installed.

Individual rungs will support without collapse a 200 lb. (90.7 kg) concentrated load applied at the mid-span of the rung, over and above the NEMA rated cable load with a 1.5 safety factor for highlighted NEMA spans and loads.

B-Line Series	Side Rail Dimensions	NEMA, CSA & UL Classifications	Span ft	Load lbs/ft	Deflection Multiplier	Design Factors for Two Rails	Span meters	Load kg/m	Deflection Multiplier	Design Factors for Two Rails
258		NEMA: 16A, 12C CSA: D1-3m  UL Cross-Sectional Area: 0.40 in <sup>2</sup>	6	436*	0.0004	Area = 0.71 in <sup>2</sup> Sx = 0.89 in <sup>3</sup> Ix = 2.44 in <sup>4</sup>	1.8	649*	0.007	Area = 4.58 cm <sup>2</sup> Sx = 14.58 cm <sup>3</sup> Ix = 101.56 cm <sup>4</sup>
			8	245	0.0013		2.4	365	0.022	
			10	157	0.0032		3.0	234	0.054	
			12	109	0.0066		3.7	162	0.113	
			14	80	0.012		4.3	119	0.209	
			16	61	0.021		4.9	91	0.356	

B-Line Series	Side Rail Dimensions	NEMA, CSA & UL Classifications	Span ft	Load lbs/ft	Deflection Multiplier	Design Factors for Two Rails	Span meters	Load kg/m	Deflection Multiplier	Design Factors for Two Rails
356		NEMA: 20A, 16C CSA: D1-6m  UL Cross-Sectional Area: 0.70 in <sup>2</sup>	10	276	0.0021	Area = 1.00 in <sup>2</sup> Sx = 1.31 in <sup>3</sup> Ix = 3.73 in <sup>4</sup>	3.0	411	0.036	Area = 6.45 cm <sup>2</sup> Sx = 21.47 cm <sup>3</sup> Ix = 155.25 cm <sup>4</sup>
			12	192	0.0043		3.7	285	0.074	
			14	141	0.0080		4.3	210	0.136	
			16	108	0.014		4.9	160	0.233	
			18	85	0.022		5.5	127	0.373	
			20	69	0.033		6.1	103	0.568	

B-Line Series	Side Rail Dimensions	NEMA, CSA & UL Classifications	Span ft	Load lbs/ft	Deflection Multiplier	Design Factors for Two Rails	Span meters	Load kg/m	Deflection Multiplier	Design Factors for Two Rails
454		NEMA: 20C CSA: E-6m  UL Cross-Sectional Area: 1.00 in <sup>2</sup>	12	294	0.0032	Area = 1.34 in <sup>2</sup> Sx = 1.75 in <sup>3</sup> Ix = 4.96 in <sup>4</sup>	3.7	438	0.055	Area = 8.65 cm <sup>2</sup> Sx = 28.68 cm <sup>3</sup> Ix = 206.45 cm <sup>4</sup>
			16	166	0.010		4.9	246	0.175	
			18	131	0.016		5.5	195	0.280	
			20	106	0.026		6.1	158	0.427	
			22	88	0.037		6.7	130	0.625	
			24	74	0.052		7.3	110	0.886	

\*When using 18" rung spacing, load capacity is limited to 394 lbs/ft (586.272 kg/m) for 30" cable tray width and 325 lbs/ft (483.6 kg/m) for 36" cable tray width. When cable trays are used in continuous spans, the deflection of the cable tray is reduced by as much as 50%. Design factors: Ix = Moment of Inertia, Sx = Section Modulus.

All dimensions in parentheses are millimeters unless otherwise specified.

## 5" NEMA VE 1 Loading Depth 6" Side Rail Height

### Straight Section Part Numbering

Example: <sup>Prefix</sup> **268 P 09 - 24 - 144**

Series	Material	*Type	*Width	Length
● <b>268</b>	● <b>P</b> = Pre-Galvanized ● <b>G</b> = HDGAF	<b>Ladder-</b> ● <b>06</b> = 6" rung spacing ● <b>09</b> = 9" rung spacing ● <b>12</b> = 12" rung spacing	● <b>06</b> = 6" ● <b>09</b> = 9" ● <b>12</b> = 12" ● <b>18</b> = 18" ● <b>24</b> = 24" ● <b>30</b> = 30" ● <b>36</b> = 36"	● ① <b>144</b> = 12 ft. ● ② <b>120</b> = 10 ft. ● ① <b>240</b> = 20 ft. ● ② <b>144</b> = 12 ft. ● ① <b>240</b> = 20 ft. ● ② <b>288</b> = 24 ft.
● <b>366</b>				268 366
● <b>464</b>				464

① Primary Length.  
② Secondary Length.  
See page C-23 for explanation of lengths.

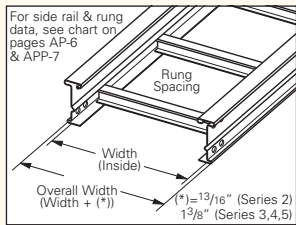

See page APP-1 for additional rung options. \*Special sizes available.

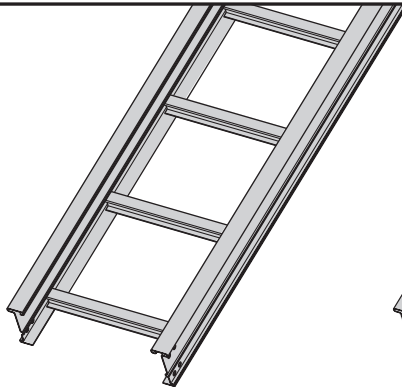

Ladder Type  
(Specify Rung Spacing)

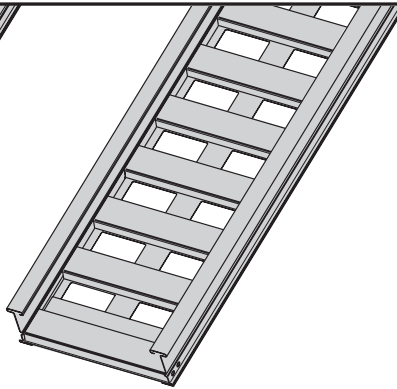

Ventilated Trough

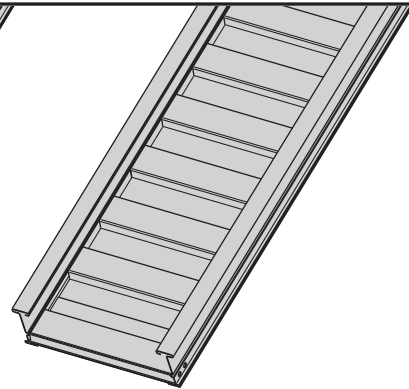

Non-Ventilated Trough

● Green = Fastest shipped items   ● Black = Normal lead-time items   ● Red = Normally long lead-time items

All dimensions in parentheses are millimeters unless otherwise specified.

## 5" NEMA VE 1 Loading Depth 6" Side Rail Height

Values are based on simple beam tests per NEMA VE 1 on 36" wide cable tray with rungs spaced on 12" centers. Cable trays will support without collapse a 200 lb. (90.7 kg) concentrated load over and above published loads. Published load safety factor is 1.5. To convert 1.5 safety factor to 2.0, multiply published load by 0.75. To obtain mid-span deflection, multiply a load by the deflection multiplier. Cable tray must be supported on spans shorter than or equal to the length of the cable tray being installed.

Individual rungs will support without collapse a 200 lb. (90.7 kg) concentrated load applied at the mid-span of the rung, over and above the NEMA rated cable load with a 1.5 safety factor for highlighted NEMA spans and loads.

B-Line Series	Side Rail Dimensions	NEMA, CSA & UL Classifications	Span ft	Load lbs/ft	Deflection Multiplier	Design Factors for Two Rails	Span meters	Load kg/m	Deflection Multiplier	Design Factors for Two Rails
268		NEMA: 16A, 12C CSA: D1-3m  UL Cross-Sectional Area: 0.70 in <sup>2</sup>	6	440*	0.0003	Area = 0.80 in <sup>2</sup> Sx = 1.18 in <sup>3</sup> Ix = 3.81 in <sup>4</sup>	1.8	655*	0.005	Area = 5.16 cm <sup>2</sup> Sx = 19.34 cm <sup>3</sup> Ix = 158.58 cm <sup>4</sup>
			8	248	0.0008		2.4	368	0.014	
			10	158	0.0020		3.0	236	0.035	
			12	110	0.0042		3.7	164	0.072	
			14	81	0.0078		4.3	120	0.134	
			16	62	0.013		4.9	92	0.228	

B-Line Series	Side Rail Dimensions	NEMA, CSA & UL Classifications	Span ft	Load lbs/ft	Deflection Multiplier	Design Factors for Two Rails	Span meters	Load kg/m	Deflection Multiplier	Design Factors for Two Rails
366		NEMA: 20B, 16C CSA: E-6m  UL Cross-Sectional Area: 1.00 in <sup>2</sup>	10	300	0.0014	Area = 1.11 in <sup>2</sup> Sx = 1.71 in <sup>3</sup> Ix = 5.74 in <sup>4</sup>	3.0	446	0.023	Area = 7.16 cm <sup>2</sup> Sx = 28.02 cm <sup>3</sup> Ix = 238.92 cm <sup>4</sup>
			12	208	0.0028		3.7	310	0.048	
			14	153	0.0052		4.3	228	0.089	
			16	117	0.0089		4.9	174	0.151	
			18	93	0.014		5.5	138	0.242	
			20	75	0.022		6.1	112	0.369	

B-Line Series	Side Rail Dimensions	NEMA, CSA & UL Classifications	Span ft	Load lbs/ft	Deflection Multiplier	Design Factors for Two Rails	Span meters	Load kg/m	Deflection Multiplier	Design Factors for Two Rails
464		NEMA: 20C CSA: E-6m  UL Cross-Sectional Area: 1.00 in <sup>2</sup>	12	342*	0.002	Area = 1.49 in <sup>2</sup> Sx = 2.27 in <sup>3</sup> Ix = 7.65 in <sup>4</sup>	3.7	508*	0.035	Area = 9.61 cm <sup>2</sup> Sx = 37.36 cm <sup>3</sup> Ix = 318.42 cm <sup>4</sup>
			16	192	0.007		4.9	286	0.113	
			18	152	0.011		5.5	226	0.182	
			20	123	0.016		6.1	183	0.277	
			22	102	0.024		6.7	151	0.406	
			24	85	0.034		7.3	127	0.574	

\*When using 18" rung spacing, load capacity is limited to 394 lbs/ft (586.272 kg/m) for 30" cable tray width and 325 lbs/ft (483.6 kg/m) for 36" cable tray width. When cable trays are used in continuous spans, the deflection of the cable tray is reduced by as much as 50%. Design factors: Ix = Moment of Inertia, Sx = Section Modulus.

All dimensions in parentheses are millimeters unless otherwise specified.

## 6" NEMA VE 1 Loading Depth 7" Side Rail Height

### Straight Section Part Numbering

Example: <sup>Prefix</sup> **378 P 09 - 24 - 144**

Series	Material	*Type	*Width	Length	
● <b>378</b>	● <b>P</b> = Pre-Galvanized ● <b>G</b> = HDGAF	<b>Ladder-</b> ● <b>06</b> = 6" rung spacing ● <b>09</b> = 9" rung spacing ● <b>12</b> = 12" rung spacing	● <b>06</b> = 6" ● <b>09</b> = 9" ● <b>12</b> = 12" ● <b>18</b> = 18" ● <b>24</b> = 24" ● <b>30</b> = 30" ● <b>36</b> = 36"	● ① <b>144</b> = 12 ft. ● ② <b>120</b> = 10 ft. ● ① <b>240</b> = 20 ft. ● ② <b>288</b> = 24 ft. ● ① <b>240</b> = 20 ft. ● ② <b>288</b> = 24 ft.	378 476 574

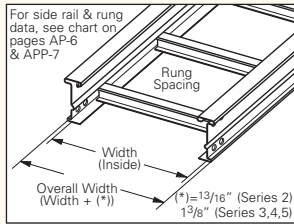

#### Trough-

6" thru 36" wide

- **VT** = Ventilated Trough
- **ST** = Non-Ventilated Trough

① Primary Length.  
② Secondary Length.

See page C-23 for explanation of lengths.

See page APP-1 for additional rung options. \*Special sizes available.

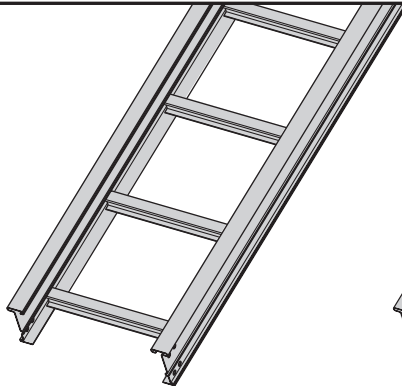

Ladder Type  
(Specify Rung Spacing)

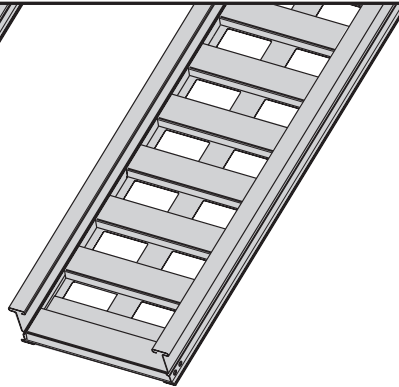

Ventilated Trough

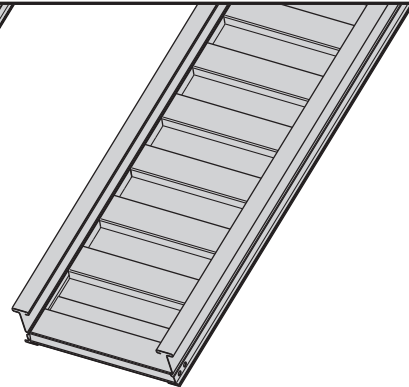

Non-Ventilated Trough

● Green = Fastest shipped items   ● Black = Normal lead-time items   ● Red = Normally long lead-time items

All dimensions in parentheses are millimeters unless otherwise specified.

## 6" NEMA VE 1 Loading Depth 7" Side Rail Height

Values are based on simple beam tests per NEMA VE 1 on 36" wide cable tray with rungs spaced on 12" centers. Cable trays will support without collapse a 200 lb. (90.7 kg) concentrated load over and above published loads. Published load safety factor is 1.5. To convert 1.5 safety factor to 2.0, multiply published load by 0.75. To obtain mid-span deflection, multiply a load by the deflection multiplier. Cable tray must be supported on spans shorter than or equal to the length of the cable tray being installed.

Individual rungs will support without collapse a 200 lb. (90.7 kg) concentrated load applied at the mid-span of the rung, over and above the NEMA rated cable load with a 1.5 safety factor for highlighted NEMA spans and loads.

B-Line Series	Side Rail Dimensions	NEMA, CSA & UL Classifications	Span ft	Load lbs/ft	Deflection Multiplier	Design Factors for Two Rails	Span meters	Load kg/m	Deflection Multiplier	Design Factors for Two Rails
378		NEMA: 20A, 16B CSA: D1-3m  UL Cross-Sectional Area: 0.70 in <sup>2</sup>	8	319	0.0006	Area = 1.01 in <sup>2</sup> S <sub>x</sub> = 1.77 in <sup>3</sup> I <sub>x</sub> = 6.90 in <sup>4</sup>	2.4	474	0.009	Area = 6.52 cm <sup>2</sup> S <sub>x</sub> = 29.01 cm <sup>3</sup> I <sub>x</sub> = 287.20 cm <sup>4</sup>
			10	204	0.0014		3.0	304	0.023	
			12	142	0.0028		3.7	211	0.048	
			14	104	0.0052		4.3	155	0.089	
			16	80	0.0089		4.9	119	0.151	
			18	63	0.014		5.5	94	0.242	
			20	51	0.022		6.1	76	0.369	

B-Line Series	Side Rail Dimensions	NEMA, CSA & UL Classifications	Span ft	Load lbs/ft	Deflection Multiplier	Design Factors for Two Rails	Span meters	Load kg/m	Deflection Multiplier	Design Factors for Two Rails
476		NEMA: 20B, 16C CSA: D1-6m  UL Cross-Sectional Area: 1.00 in <sup>2</sup>	12	214	0.0019	Area = 1.22 in <sup>2</sup> S <sub>x</sub> = 2.14 in <sup>3</sup> I <sub>x</sub> = 8.30 in <sup>4</sup>	3.7	318	0.033	Area = 7.87 cm <sup>2</sup> S <sub>x</sub> = 35.07 cm <sup>3</sup> I <sub>x</sub> = 345.47 cm <sup>4</sup>
			16	129	0.0061		4.9	179	0.105	
			18	95	0.010		5.5	141	0.168	
			20	77	0.015		6.1	115	0.255	
			22	64	0.022		6.7	95	0.374	
			24	53	0.031		7.3	80	0.529	

B-Line Series	Side Rail Dimensions	NEMA, CSA & UL Classifications	Span ft	Load lbs/ft	Deflection Multiplier	Design Factors for Two Rails	Span meters	Load kg/m	Deflection Multiplier	Design Factors for Two Rails
574		NEMA: 20C CSA: E-6m  UL Cross-Sectional Area: 1.50 in <sup>2</sup>	12	361	0.0014	Area = 1.64 in <sup>2</sup> S <sub>x</sub> = 2.87 in <sup>3</sup> I <sub>x</sub> = 11.10 in <sup>4</sup>	3.7	537	0.025	Area = 10.58 cm <sup>2</sup> S <sub>x</sub> = 47.03 cm <sup>3</sup> I <sub>x</sub> = 462.02 cm <sup>4</sup>
			16	203	0.0046		4.9	302	0.078	
			18	160	0.0073		5.5	239	0.125	
			20	130	0.011		6.1	193	0.191	
			22	107	0.016		6.7	160	0.280	
			24	90	0.023		7.3	134	0.396	

When cable trays are used in continuous spans, the deflection of the cable tray is reduced by as much as 50%. Design factors:  
 I<sub>x</sub> = Moment of Inertia, S<sub>x</sub> = Section Modulus.

All dimensions in parentheses are millimeters unless otherwise specified.

# Series 2, 3, 4, & 5 Steel - Accessories

## Splice Plates

- Standard 8-hole pattern for all steel splice plates.
- Furnished in pairs with hardware.
- One pair including hardware provided with straight section. (Expansion splice quantity subtracted)
- Boxed in pairs with hardware.
- (\*) Insert Z**N** or G

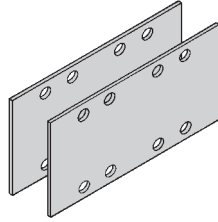

Catalog No.	Height in. mm
<b>9(*)-8004</b>	4 (101)
<b>9(*)-8005</b>	5 (127)
<b>9(*)-8006</b>	6 (152)
<b>9(*)-8007</b>	7 (178)

## Expansion Splice Plates

- Expansion plates allow for one inch expansion or contraction of the cable tray, or where expansion joints occur in the support structure.
- Furnished in pairs with hardware.
- Bonding Jumpers are required on each siderail. Order Separately.
- (\*) Insert Z**N** or G

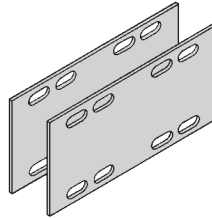

For heavy duty expansion splice plates see page APP-3.

Catalog No.	Height in. mm
<b>9(*)-8014</b>	4 (101)
<b>9(*)-8015</b>	5 (127)
<b>9(*)-8016</b>	6 (152)
<b>9(*)-8017</b>	7 (178)

## Universal Splice Plates

- Used to splice to existing cable tray systems.
- Furnished in pairs with hardware.
- (\*) Insert Z**N** or G

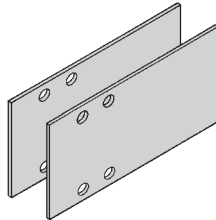

Catalog No.	Height in. mm
<b>9(*)-8004-1/2</b>	4 (101)
<b>9(*)-8005-1/2</b>	5 (127)
<b>9(*)-8006 -1/2</b>	6 (152)
<b>9(*)-8007 -1/2</b>	7 (178)

## Step Down Splice Plates

- These splice plates are offered for connecting cable tray sections having side rails of different heights.
- Furnished in pairs with hardware.
- (\*) Insert Z**N** or G

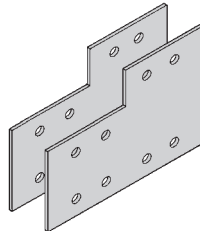

Catalog No.	Height in. mm
<b>9(*)-8045</b>	5 to 4 (127 to 101)
<b>9(*)-8046</b>	6 to 4 (152 to 101)
<b>9(*)-8060</b>	6 to 5 (152 to 127)
<b>9(*)-8047</b>	7 to 4 (178 to 101)
<b>9(*)-8061</b>	7 to 5 (178 to 127)
<b>9(*)-8062</b>	7 to 6 (178 to 152)

## Vertical Adjustable Splice Plates

- These plates provide for changes in elevation that do not conform to standard vertical fittings.
- Furnished in pairs with hardware.
- **Bonding Jumpers not required.**
- (\*) Insert G or P

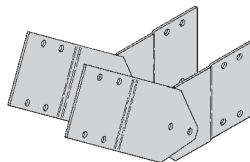

Requires supports within 24" on both sides, per NEMA VE 2.

Catalog No.	Height in. mm
<b>9(*)-8024</b>	4 (101)
<b>9(*)-8025</b>	5 (127)
<b>9(*)-8026</b>	6 (152)
<b>9(*)-8027</b>	7 (178)

## Branch Pivot Connectors

- Branch from existing cable tray runs at any point.
- Pivot to any required angle.
- UL Classified for grounding (bonding jumpers not required).
- Furnished in pairs with hardware.
- (\*) Insert Z**N** or G

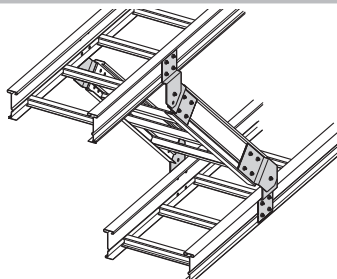

Catalog No.	Height in. mm
<b>9(*)-8244</b>	4 (101)
<b>9(*)-8245</b>	5 (127)
<b>9(*)-8246</b>	6 (152)
<b>9(*)-8247</b>	7 (178)

● Green = Fastest shipped items    ● Black = Normal lead-time items    ● Red = Normally long lead-time items

All dimensions in parentheses are millimeters unless otherwise specified.

## Horizontal Adjustable Splice Plates

- Offered to adjust a cable tray run for changes in direction in a horizontal plane that do not conform to standard horizontal fittings.
- Furnished in pairs with hardware.
- Bonding jumpers **not** required.
- (\*) Insert **ZN** or **G**
- (X) Insert 4, 5, 6 or 7 for side rail height.

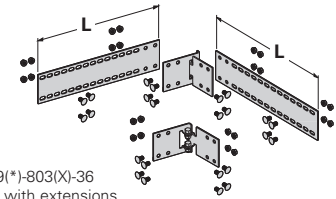
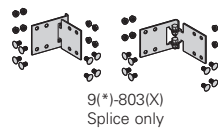

Catalog No.	Cable Tray End Cut	Thru Tray Width		'L'
		in.	(mm)	in. (mm)
9(*)-803(X)	Mitered	36	(914)	N/A (NA)
9(*)-803(X)-12	Not mitered	12	(305)	16 (406)
9(*)-803(X)-36	Not mitered	36	(914)	41 (1041)

Requires supports within 24" on both sides, per NEMA VE 2.

## Offset Reducing Splice Plate

- This plate is used for joining cable trays having different widths. When used in pairs they form a straight reduction; when used singly with a standard splice plate, they form an offset reduction.
- Furnished as one plate with hardware.
- (‡) Insert reduction
- (\*) Insert **G** or **P**

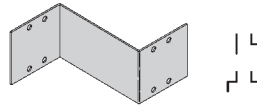

Catalog No.	Height	
	in.	mm
9(*)-8064-(‡)	4	(101)
9(*)-8065-(‡)	5	(127)
9(*)-8066-(‡)	6	(152)
9(*)-8067-(‡)	7	(178)

## Tray to Box Splice Plates

- Used to attach the end of a cable tray run to a distribution box or control panel.
- Furnished in pairs with hardware.
- (\*) Insert **G** or **P**

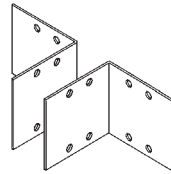

Catalog No.	Height	
	in.	mm
9(*)-8054	4	(101)
9(*)-8055	5	(127)
9(*)-8056	6	(152)
9(*)-8057	7	(178)

## Frame Type Box Connector

- Designed to attach the end of a cable tray run to a distribution cabinet or control center to help reinforce the box at the point of entry.
- Furnished with tray connection hardware.
- (\*) Insert **ZN** or **G**
- (‡) Insert tray width

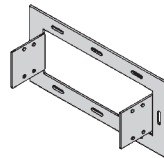

Catalog No.	Height	
	in.	mm
9(*)-8074-(‡)	4	(101)
9(*)-8075-(‡)	5	(127)
9(*)-8076-(‡)	6	(152)
9(*)-8077-(‡)	7	(178)

## Blind End

- This plate forms a closure for a dead end cable tray.
- Furnished as one plate with hardware.
- (\*) Insert **G** or **P**
- (‡) Insert tray width

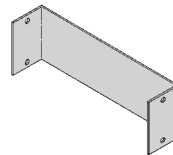

Catalog No.	Height	
	in.	mm
9(*)-8084-(‡)	4	(101)
9(*)-8085-(‡)	5	(127)
9(*)-8086-(‡)	6	(152)
9(*)-8087-(‡)	7	(178)

## Cross Connector Bracket

- For field connecting crossing section.
- Furnished in pairs with <sup>3</sup>/<sub>8</sub>" hardware.
- (\*) Insert **ZN** or **G**

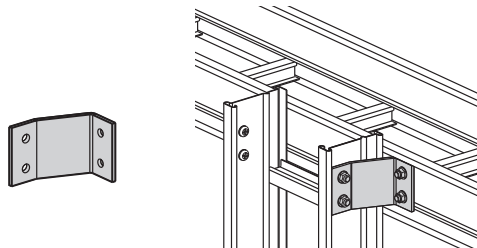

**Catalog No.**  
**9(\*)-1240**

● Green = Fastest shipped items   ● Black = Normal lead-time items   ● Red = Normally long lead-time items

All dimensions in parentheses are millimeters unless otherwise specified.



# Series 2, 3, 4, & 5 Steel - Accessories

## Standard Tray Hardware (for field installation drill $1\frac{3}{32}$ " hole)

- Finishes: [ZN] Zinc Plated ASTM B633 SC1 for pre-galvanized tray  
[CZ] Chromium Zinc Plated F1136-88 Grade A for hot dip galvanized tray

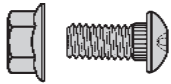

Catalog No.	Description
● <b>RNCB <math>\frac{3}{8}</math>" x <math>\frac{3}{4}</math>" ZN</b>	Ribbed Neck Carriage Bolt ASTM A307 Grade A
● <b>SFHN <math>\frac{3}{8}</math>"-16 ZN</b>	Serrated Flange Hex Nut ASTM A563 Grade A
● <b>RNCB <math>\frac{3}{8}</math>" x <math>\frac{3}{4}</math>" CZ</b>	Ribbed Neck Carriage Bolt ASTM F1136-88 Grade 3
● <b>SFHN <math>\frac{3}{8}</math>"-16 CZ</b>	Serrated Flange Hex Nut ASTM F1136-88 Grade A

## Optional Tray Hardware (for field installation drill $1\frac{3}{32}$ " hole)

- To order 316 stainless steel hardware add SS6 suffix to catalog number - Example: 9G-8004SS6

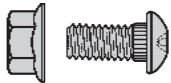

Catalog No.	Description
● <b>RNCB <math>\frac{3}{8}</math>" x <math>\frac{3}{4}</math>" SS6</b>	Ribbed Neck Carriage Bolt AISI 316 Stainless Steel
● <b>SFHN <math>\frac{3}{8}</math>"-16 SS6</b>	Serrated Flange Hex Nut AISI 316 Stainless Steel

## Conduit to Cable Tray Adaptor

- For easy attachment of conduit terminating at a cable tray.
- Use on aluminum or steel cable trays.

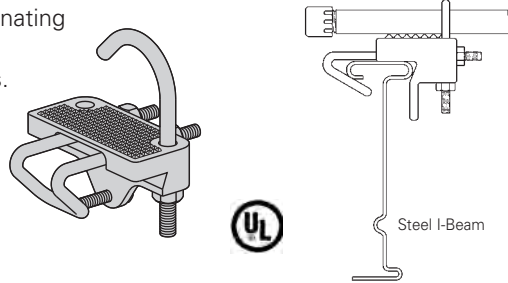

Catalog No.	Conduit Size	
	in.	mm
● <b>9G-1158-1/2, 3/2</b>	$1\frac{1}{2}, \frac{3}{4}$	(15, 20)
● <b>9G-1158-1, 1 1/4</b>	1, $1\frac{1}{4}$	(25, 32)
● <b>9G-1158-1 1/2, 2</b>	$1\frac{1}{2}, 2$	(40, 50)
● <b>9G-1158-2 1/2, 3</b>	$2\frac{1}{2}, 3$	(65, 80)
● <b>9G-1158-3 1/2, 4</b>	$3\frac{1}{2}, 4$	(90, 100)

## Conduit to Cable Tray Adaptor

- Assembly required.
- Mounting hardware included.
- Conduit clamps provided.
- (‡) = Insert conduit size ( $\frac{1}{2}$ " thru 4").

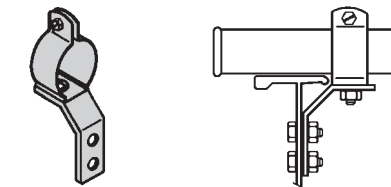

Catalog No.
● <b>9ZN-1150-(‡)</b>

## Conduit to Cable Tray Adaptor

- Assembly required.
- Conduit clamps included.
- (‡) = Insert conduit size ( $\frac{1}{2}$ " thru 4").

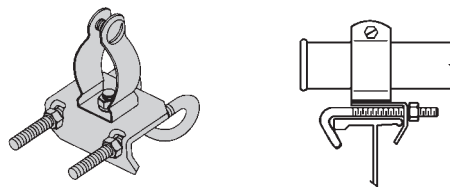

Catalog No.
● <b>9ZN-1155-(‡)</b>

## Cable Tie (Ladder Tray)

- Nylon ties provide easy attachment of cable to ladder rungs; maximum cable O.D. is 3" (76mm).

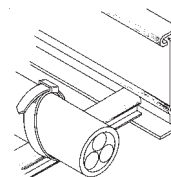
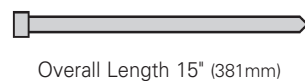

Catalog No.
● <b>99-2125-15</b>

● Green = Fastest shipped items    ● Black = Normal lead-time items    ● Red = Normally long lead-time items

All dimensions in parentheses are millimeters unless otherwise specified.

## Ladder Drop-Out

- Specially-designed Ladder Drop-Outs provide a rounded surface with 4" (101 mm) radius to protect cable as it exits the cable tray, preventing damage to insulation. The drop-out will attach to any desired rung.
- (\*) Insert **P** or **G**
- (‡) Insert tray width

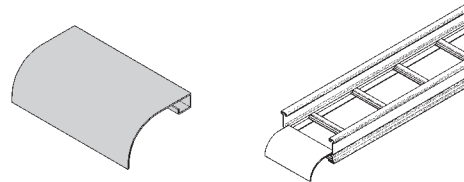

Catalog No.
● <b>9(*)-1104-(‡)</b>

## Trough Drop-Out & Drop-Out Bushing

- These devices provide a rounded surface to protect cable as it exits from the trough-type cable tray.
- Hardware is included for attachment of the trough bottom drop-out.
- (\*) Insert **P** or **G**
- (‡) Insert tray width

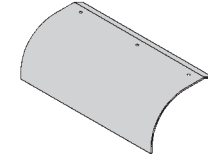
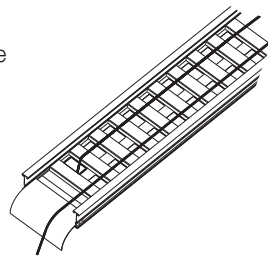

Trough-Type Drop-Out

Catalog No.
● <b>9(*)-1104T-(‡)</b>

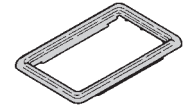

Snap-In Plastic Bushing

Catalog No.
● <b>99-1124</b>

## Barrier - Straight Section

- Length: Insert 120 for [120" - 10 ft.] (3.0 m) or 144 for [144" - 12 ft.] (3.6 m)
- Order catalog number based on loading depth.
- Furnished with four #10 x 1/2" plated self-drilling screws and a 99-9982 Barrier Strip Splice.
- (\*) Insert **P** or **G**

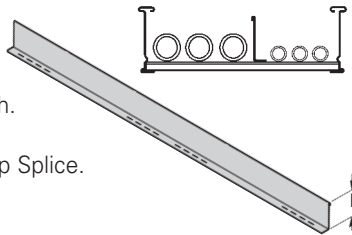

Catalog No.	Side Rail Height in. mm	Loading Depth 'H' in. mm
<b>73(*)-Length</b>	4 (101)	3 (76)
<b>74(*)-Length</b>	5 (127)	4 (101)
<b>75(*)-Length</b>	6 (152)	5 (127)
<b>76(*)-Length</b>	7 (178)	6 (152)

## Barrier - Horizontal Bend

- Horizontal Bend Barriers are flexible in order to conform to any horizontal fitting radius. Can be cut to desired length.
- Standard length is 72" [6 ft.] (1.8 m) - sold individually
- Order catalog number based on loading depth.
- Furnished with three #10 x 1/2" plated self-drilling screws and a 99-9982 Barrier Strip Splice.
- (\*) Insert **P** or **G**

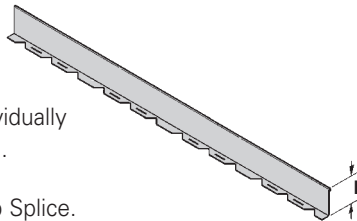

Catalog No.	Side Rail Height in. mm	Loading Depth 'H' in. mm
<b>73(*)-90HBFL</b>	4 (101)	3 (76)
<b>74(*)-90HBFL</b>	5 (127)	4 (101)
<b>75(*)-90HBFL</b>	6 (152)	5 (127)
<b>76(*)-90HBFL</b>	7 (178)	6 (152)

## Barrier - Vertical Outside Bend

- Vertical Outside Bend Barriers are preformed to conform to a specific vertical outside bend fitting.
- Furnished with three #10 x 1/2" plated self-drilling screws and a 99-9982 Barrier Strip Splice.
- (\*) Insert **P** or **G**
- (\*\*) Insert 30, 45, 60 or 90 for degrees
- (t) Insert 12, 24, 36 or 48 for radius

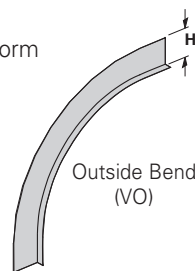

Catalog No.	Side Rail Height in. mm	Loading Depth 'H' in. mm
<b>73(*)-(**)VO(t)</b>	4 (101)	3 (76)
<b>74(*)-(**)VO(t)</b>	5 (127)	4 (101)
<b>75(*)-(**)VO(t)</b>	6 (152)	5 (127)
<b>76(*)-(**)VO(t)</b>	7 (178)	6 (152)

## Barrier - Vertical Inside Bend

- Vertical Inside Bend Barriers are preformed to conform to a specific vertical inside bend fitting.
- Furnished with three #10 x 1/2" plated self-drilling screws and a 99-9982 Barrier Strip Splice.
- (\*) Insert **P** or **G**
- (\*\*) Insert 30, 45, 60 or 90 for degrees
- (t) Insert 12, 24, 36 or 48 for radius

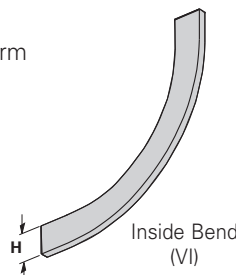

Catalog No.	Side Rail Height in. mm	Loading Depth 'H' in. mm
<b>73(*)-(**)VI(t)</b>	4 (101)	3 (76)
<b>74(*)-(**)VI(t)</b>	5 (127)	4 (101)
<b>75(*)-(**)VI(t)</b>	6 (152)	5 (127)
<b>76(*)-(**)VI(t)</b>	7 (178)	6 (152)

● Green = Fastest shipped items   ● Black = Normal lead-time items   ● Red = Normally long lead-time items

All dimensions in parentheses are millimeters unless otherwise specified.

# Series 2, 3, 4, & 5 Steel - Accessories

Series 2, 3, 4, & 5 Steel

## Barrier Strip Clip

- Zinc plated steel barrier clip fastens to either aluminum or steel ladder rung.
- Furnished with one #10 x 1/2" zinc plated self-drilling screw.

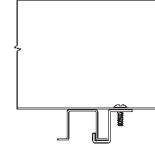
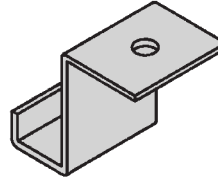

**Catalog No.**

● 92N-9002

## Barrier Strip Splice

- 2.85" (72.4mm) long
- Ribbed edge for increased rigidity and grip
- Comfort edge for ease of installation
- Slotted top window with center mark for accurate placement and inspection capability
- Patent pending

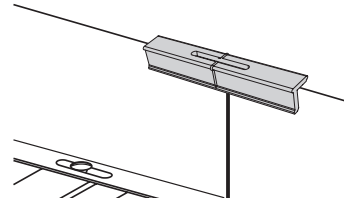
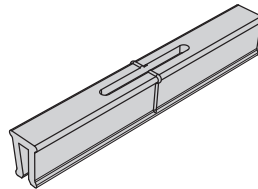

**Catalog No.**

● 99-9982

## Bonding Jumper

Use at each expansion splice and where the cable tray is not mechanically/electrically continuous to ground. Sold individually.

- Hardware included.
- See table 392.7(B)(2) on page CTS-9 for amperage ratings required to match the UL cross-sectional area of the tray.
- See tray loading chart for UL cross-sectional area.
- Bonding jumper is 14 1/2" (368mm) long.

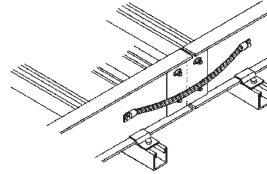

Catalog No.	Copper Wire Size	Ampacity
● 99-N1	#1	600

● 99-N1	#1	600
---------	----	-----

## Grounding Clamp

B-Line series cable tray is UL® classified as to its suitability as an equipment grounding conductor. If a separate conductor for additional grounding capability is desired, we offer this clamp for bolting the conductor at least once to each cable tray section.

- Accepts #6 AWG to 250 MCM.

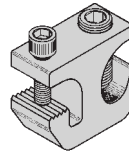

Catalog No.	Material
● 9A-2130	Tin Plated Aluminum

● 9A-2130	Tin Plated Aluminum
-----------	---------------------

## Ground Wire Clamp

- Mechanically attaches grounding cables to cable tray.
- Hardware included.
- (\*) Insert **ZN** or **SS4**

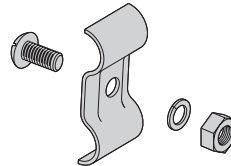

Catalog No.	Material
9(*)-2351	#1 thru 2/0
9(*)-2352	3/0 thru 250 MCM

9(*)-2351	#1 thru 2/0
9(*)-2352	3/0 thru 250 MCM

## Thread Rod (ATR) & Rod Couplings

Loading based on safety factor 5.  
Standard Finish: Zinc plated

See B-Line series Strut Systems Catalog for other sizes and finishes.

B655  
Rod Coupling

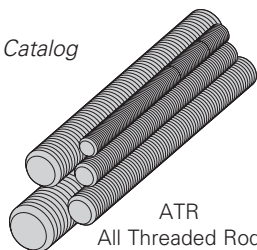
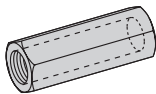

ATR  
All Threaded Rod

Size	Catalog No.	Available Length	Loading
<b>All Threaded Rod</b>			
3/8"-16	● ATR 3/8" x Length	36", 72", 120", 144"	730 lbs.
1/2"-13	● ATR 1/2" x Length	36", 72", 120", 144"	1350 lbs.
<b>Rod Coupling</b>			
3/8"-16	● B655-3/8"	NA	730 lbs.
1/2"-13	● B655-1/2"	NA	1350 lbs.

● Green = Fastest shipped items   ● Black = Normal lead-time items   ● Red = Normally long lead-time items

All dimensions in parentheses are millimeters unless otherwise specified.

## Stainless Steel Cable Clamp

- Fits with series 2, 3, 4 & 5 standard steel rungs.
- Shipped flat. Field form around the cable at the time of installation.

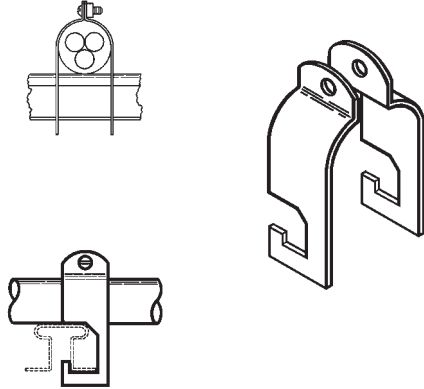

Refer to Section CF  
Cable Fixing

Catalog No.	Cable Size	
	in.	mm
● 9SS4-4050	0.50 - 0.75	(13 - 19)
● 9SS4-4075	0.75 - 1.00	(19 - 25)
● 9SS4-4100	1.00 - 1.25	(25 - 32)
● 9SS4-4125	1.25 - 1.50	(32 - 38)
● 9SS4-4150	1.50 - 1.75	(38 - 45)
● 9SS4-4175	1.75 - 2.00	(45 - 51)
● 9SS4-4200	2.00 - 2.25	(51 - 57)
● 9SS4-4225	2.25 - 2.50	(57 - 64)
● 9SS4-4250	2.50 - 2.75	(64 - 70)
● 9SS4-4275	2.75 - 3.00	(70 - 76)
● 9SS4-4300	3.00 - 3.25	(76 - 82)
● 9SS4-4325	3.25 - 3.50	(82 - 89)
● 9SS4-4350	3.50 - 3.75	(89 - 95)
● 9SS4-4375	3.75 - 4.00	(95 - 100)
● 9SS4-4400	4.00 - 4.25	(100 - 106)
● 9SS4-4425	4.25 - 4.50	(106 - 113)
● 9SS4-4450	4.50 - 4.75	(113 - 121)
● 9SS4-4475	4.75 - 5.00	(121 - 125)

## Hanger Rod Clamp

- For 1/2" ATR.
- Furnished in pairs.
- Order ATR and hex nuts separately.
- Two-piece "J"-hanger design.
- 1350 lbs./pair capacity.
- (\*) Insert **ZN** or **G**

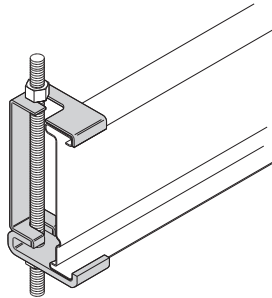

Catalog No.	Height	
	in.	mm
9(*)-5324	4	(101)
9(*)-5325	5	(127)
9(*)-5326	6	(152)
9(*)-5327	7	(178)

## Cable Tray Clamp/Guide

- Features a no-twist design.
- Has four times the strength of the traditional design.
- Each side is labeled to ensure proper installation.
- Furnished in pairs, with or without hardware.
- Not recommended for vertical support.

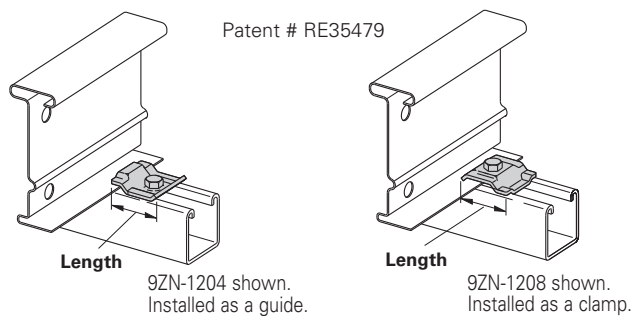

When installing this device as an expansion guide on the outside flange of *Steel Side Rail*, use the Catalog No. **B202** Square Washer in order to properly elevate the guide.

Note: For heavy duty or vertical applications see 9(\*)-1241 or 9(\*)-1242 page HAT-20

Catalog No.		Overall Length in. (mm)	Hardware Size in.	Finish
Without Hardware	With Hardware			
● 9ZN-1204	● 9ZN-1204NB	1 1/2 (38)	1/4"	G90
● 9ZN-1208	● 9ZN-1208NB	2 1/4 (57)	3/8"	G90
● 9A-1205	--	2 1/4 (57)	1/2"	Alum.
● 9G-1205	--	2 1/4 (57)	1/2"	HDGAF
● 9SS6-1205	--	2 1/4 (57)	1/2"	316SS
● 9ZN-1205	--	2 1/4 (57)	1/2"	G90

● Green = Fastest shipped items    ● Black = Normal lead-time items    ● Red = Normally long lead-time items

All dimensions in parentheses are millimeters unless otherwise specified.

# Series 2, 3, 4, & 5 Steel - Accessories

Series 2, 3, 4, & 5 Steel

## Cable Tray Clamp

- Hold-down clamps for single or double cable tray runs.
- No drilling of support I-beam or channel is required.
- Sold in pieces - two clamps are required per tray.
- Maximum beam flange thickness 1 1/8" (28.58 mm).

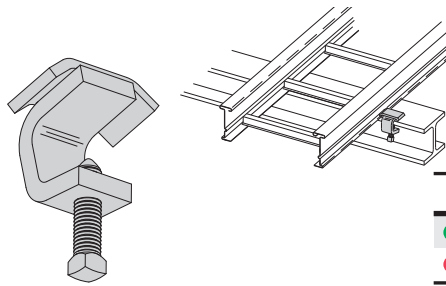

Catalog No.	Finish
● 9ZN-1249HD	Znplt
● 9G-1249HD	HDGAF

## Cable Tray Guide

- Expansion guide for single or double cable tray runs.
- Guide allows for longitudinal movement of the cable tray.
- No field drilling of support I-beam or channel is required.
- Guides are required on both sides of cable tray to prevent lateral movement - can be placed on either the inside or outside flange of cable tray.
- Guides are sold in pieces - two guides are required per tray.
- Maximum flange thickness 1 1/8" (28.58 mm).

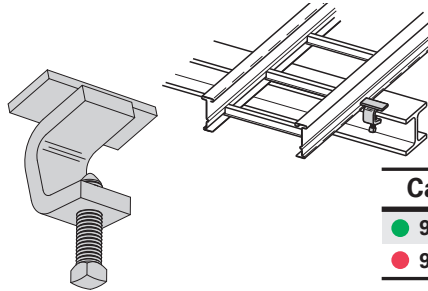

Catalog No.	Finish
● 9ZN-1249	Znplt
● 9G-1249	HDGAF

## Nylon Pad

- Use for friction reduction.
- Hardness: Shore D80.
- Low friction coefficient.
- UV resistant.
- Excellent weatherability.
- UL - 94HB.

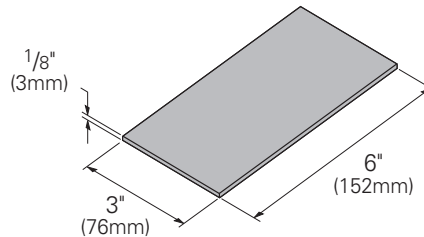

Catalog No.
● 99-PE36

## Neoprene Roll

- Use for material isolation.
- 1/8" x 2" x 25' roll.
- Hardness: Shore A60.
- Good weatherability.

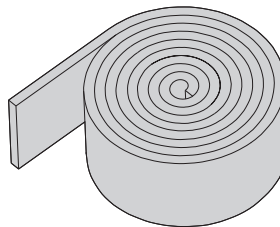

Catalog No.
● 99-NP300

## DURA-BLOK™ Rooftop Support Bases with B22 Channel

- Designed as a superior rooftop support for cable tray.
- UV resistant and approved for most roofing material or other flat surfaces.
- Can be used with any of B-Line series cable tray clamps and guides.
- Ultimate Load Capacity: 1,000 lbs. (uniform load)



Catalog No.	Height x Width x Length in. (mm)
● DB10-28	5 5/8 x 6 x 28.0 (143 x 152 x 711)
● DB10-36	5 5/8 x 6 x 36.0 (143 x 152 x 914)
● DB10-42	5 5/8 x 6 x 42.0 (143 x 152 x 1067)
● DB10-50	5 5/8 x 6 x 50.0 (143 x 152 x 1270)
● DB10-60	5 5/8 x 6 x 60.0 (143 x 152 x 1524)



LEEDS credit available, base made from 100% recycled material.

General Note: Consult roofing manufacturer or engineer for roof load capacity. The weakest point may be the insulation board beneath the rubber membrane.

● Green = Fastest shipped items   ● Black = Normal lead-time items   ● Red = Normally long lead-time items

All dimensions in parentheses are millimeters unless otherwise specified.

## Trapeze Support Kit

- Eaton's B-Line series trapeze kits provide the components required for a single trapeze support in one package. These kits are available in pre-galvanized steel with zinc-plated hardware, hot dip galvanized steel with 316 stainless steel hardware, or DURA GREEN™ painted steel with zinc-plated hardware.
- The SH channel provides the convenience of pre-punched slots, which eliminate the need for field drilling.
- The illustrated hardware is sealed in a plastic bag and boxed with the channel, which is pre-cut to the appropriate length as shown in the chart.
- Designed for use with 1/2" threaded rod. Order rod separately.

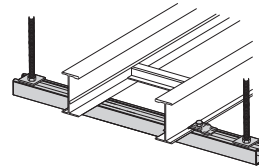
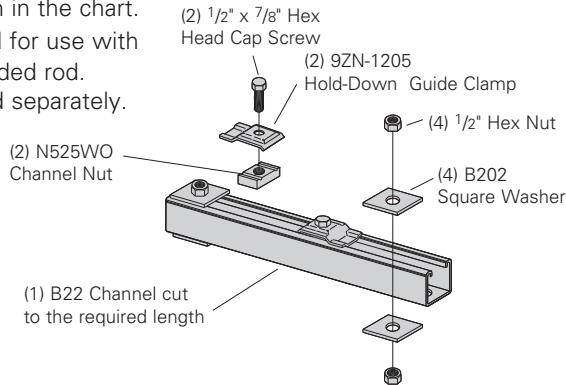

Catalog No.	Tray Width		Channel Length		Uniform Load	
	in.	mm	in.	mm	lbs	kN
● 9(*)-5506-22SH(†)	6	(152)	16	(406)	1350	(6.00)
● 9(*)-5509-22SH(†)	9	(229)	18	(457)	1250	(5.56)
● 9(*)-5512-22SH(†)	12	(305)	22	(559)	1125	(5.00)
● 9(*)-5518-22SH(†)	18	(457)	28	(711)	865	(3.85)
● 9(*)-5524-22SH(†)	24	(610)	34	(864)	700	(3.11)
● 9(*)-5530-22SH(†)	30	(762)	40	(1016)	590	(2.62)
● 9(*)-5536-22SH(†)	36	(914)	46	(1168)	510	(2.27)
● 9(*)-5542-22SH(†)	42	(1067)	52	(1321)	450	(2.00)

- (\*) Insert **P** **G** or **GRN**
- (†) Insert 3/8 for 3/8" threaded rod hardware. Safety factor of 3.0 on all loads.

## Heavy Duty Trapeze Support Kit

- Eaton's B-Line series trapeze kits provide the components required for a single trapeze support in one package. These kits are available in pre-galvanized steel with zinc-plated hardware, hot dip galvanized steel with 316 stainless steel hardware, or DURA GREEN™ painted steel with zinc-plated hardware.
- The SH channel provides the convenience of pre-punched slots, which eliminates the need for field drilling.
- The illustrated hardware is sealed in a plastic bag and boxed with the channel, which is pre-cut to the appropriate length as shown in the chart.
- Designed for use with 1/2" threaded rod. Order rod separately.

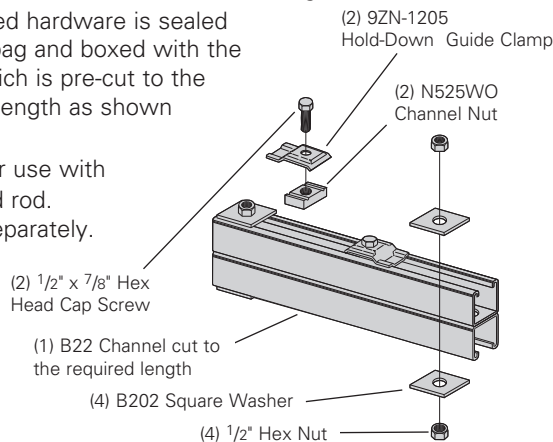

Catalog No.	Tray Width		Channel Length		Uniform Load	
	in.	mm	in.	mm	lbs	kN
● 9(*)-5506-22SHA	6	(152)	16	(406)	1350	(6.00)
● 9(*)-5509-22SHA	9	(229)	18	(457)	1350	(6.00)
● 9(*)-5512-22SHA	12	(305)	22	(559)	1350	(6.00)
● 9(*)-5518-22SHA	18	(457)	28	(711)	1350	(6.00)
● 9(*)-5524-22SHA	24	(610)	34	(864)	1350	(6.00)
● 9(*)-5530-22SHA	30	(762)	40	(1016)	1350	(6.00)
● 9(*)-5536-22SHA	36	(914)	46	(1168)	1350	(6.00)
● 9(*)-5542-22SHA	42	(1067)	52	(1321)	1350	(6.00)

- (\*) Insert **P** **G** or **GRN**
- Safety factor of 3.0 on all loads.

## Trapeze Hardware Kit

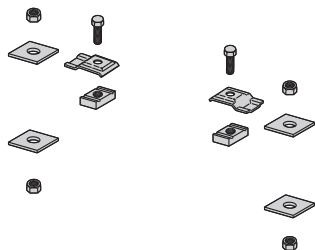

Catalog No.	● 9ZN-5500-1/2	● 9G-5500-1/2
In plastic bag	1 pr. 9ZN-1205 2 HHC Screw 1/2 x 7/8 ZN 2 N525 WO ZN 4 B202 ZN 1/2" sq washer 4 HN 1/2" ZN	1 pr. 9G-1205 2 HHC Screw 1/2 x 7/8 SS6 2 N525 WO SS6 4 B202 HDG 1/2" sq washer 4 HN 1/2" SS6

● Green = Fastest shipped items   ● Black = Normal lead-time items   ● Red = Normally long lead-time items

All dimensions in parentheses are millimeters unless otherwise specified.

# Series 2, 3, 4, & 5 Steel - Accessories

Series 2, 3, 4, & 5 Steel

## Center Hung Tray Support

- Center Hung Cable Tray Support allows cable to be laid-in from both sides.
- Eliminates costly cable pulling and field cutting of cable tray supports. Labor costs are dramatically reduced.
- Required hardware and threaded rod material for trapeze assemblies are reduced by up to 50%.
- Designed for use with 1/2" threaded rod. (Order rod separately)
- Use with all aluminum and steel cable trays through 24" width.
- Load capacity is 700 lbs. (311kN) per support. Safety factor of 3.0. Eccentric loading is not to exceed a 60% vs. 40% load differential.
- The maximum recommended unsupported span length is 144"/12 ft. (3.66 m).
- Hardware shown is furnished.
- Finish available: Zinc Plated

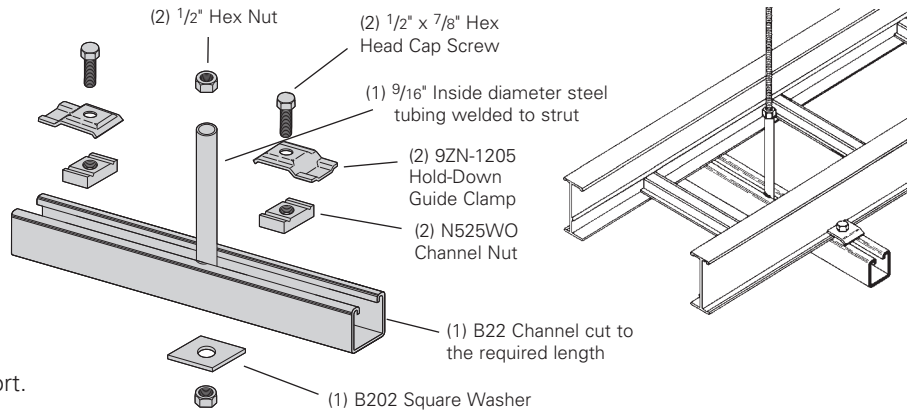

Catalog No.	Tray Width		Channel Length	
	in.	(mm)	in.	(mm)
● 9ZN-5212	6", 9", 12"	(152, 228, 305)	18"	(457)
● 9ZN-5224	18", 24"	(457, 609)	30"	(762)

## Center Hung Support Hardware Kit

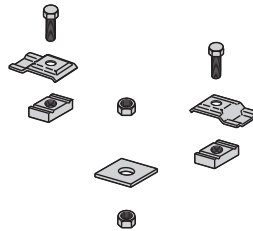

Catalog No.	● 9ZN-5200
In plastic bag	1 pr. 9ZN-1205 2 HHC Screw 1/2 x 7/8 ZN 2 N525 WO ZN 1 B202 ZN 1/2" sq washer 4 HN 1/2 ZN

## Bracket (12" - 48")

- (\*) Insert available finish: **ZN** **GRN** or **HDG**
- Safety Load Factor 2.5

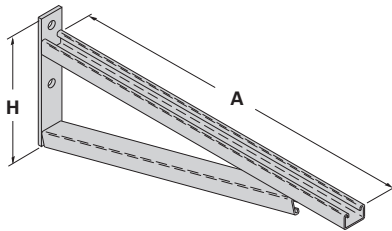

Bottom brace is B42 channel on B494-24 and smaller and B22 channel on B494-30 and larger

Catalog No.	Uniform Load		Tray Width		'A'		'H'	
	lbs	(kN)	in.	(mm)	in.	(mm)	in.	(mm)
● B494-12	2500	(11.12)	6 & 9	(152 & 229)	12	(305)	8 <sup>3</sup> / <sub>4</sub>	(222)
● B494-18	1700	(7.56)	12	(305)	18	(457)	8 <sup>3</sup> / <sub>4</sub>	(222)
● B494-24	1300	(5.78)	18	(457)	24	(610)	8 <sup>3</sup> / <sub>4</sub>	(222)
B494-30	1600	(7.11)	24	(610)	30	(762)	11 <sup>1</sup> / <sub>4</sub>	(286)
B494-36	1100	(4.89)	30	(762)	36	(914)	11 <sup>1</sup> / <sub>4</sub>	(286)
B494-42	980	(4.36)	36	(914)	42	(1067)	16	(406)
B494-48	980	(4.36)	42	(1067)	48	(1219)	16	(406)

For more dimensional data see Strut Systems catalog

## Cantilever Bracket

- (\*) Insert available finish: **ZN** **GRN** or **HDG**
- Safety Load Factor 2.5

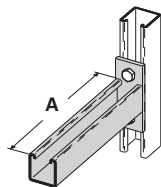

Catalog No.	Uniform Load		Tray Width		'A'	
	lbs	kN	in.	mm	in.	mm
B409-12	960	(4.27)	6 & 9	(152 & 229)	12	(305)
B409-18	640	(2.84)	12	(305)	18	(457)
B409-24	480	(2.13)	18	(457)	24	(610)

● Green = Fastest shipped items   ● Black = Normal lead-time items   ● Red = Normally long lead-time items

All dimensions in parentheses are millimeters unless otherwise specified.

## Cantilever Bracket

- (\*) Insert available finish: **ZN** **GRN** or **HDG**
- Safety Load Factor 2.5

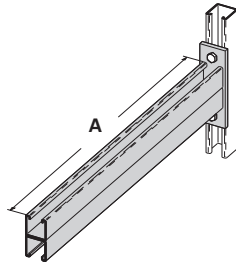

Catalog No.	Uniform Load		Tray Width		'A'	
	lbs	kN	in.	mm	in.	mm
<b>B297-12</b>	1660	(7.38)	6 & 9	(152 & 229)	12	(305)
<b>B297-18</b>	1100	(4.89)	12	(305)	18	(457)
<b>B297-24</b>	835	(3.71)	18	(457)	24	(610)
<b>B297-30</b>	665	(2.93)	24	(610)	30	(762)
<b>B297-36</b>	550	(2.44)	30	(762)	36	(914)
<b>B297-42</b>	465	(2.06)	36	(914)	42	(1067)

## Underfloor Support (U-Bolts not included)

- Finishes available: **ZN**
- Safety Load Factor 2.5

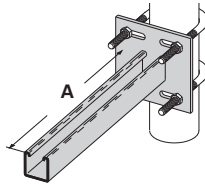

U-Bolt Size	Fits Pipe O.D.
B501-3/4	.841 - 1.050
B501-1	1.051 - 1.315
B501-1 1/4	1.316 - 1.660
B501-1 1/2	1.661 - 1.900
B501-2	1.901 - 2.375
B501-2 1/2	2.376 - 2.875

Catalog No.	Uniform Load		Tray Width		'A'	
	lbs	(kN)	in.	(mm)	in.	(mm)
<b>B409UF-12</b>	800	(3.56)	6 & 9	(152 & 229)	12	(305)
<b>B409UF-21</b>	450	(2.00)	12 & 18	(305 & 457)	21	(533)

## Vertical Hanger Splice Plates

- Design load is 1500 lbs (6.67kN) per pair.
- Safety Factor of 2.5
- Furnished in pairs.
- Hole size: 9/16" (14mm) for 1/2" threaded rod.
- (\*) Insert **ZN** or **G**

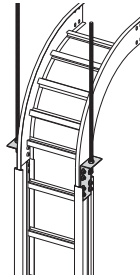
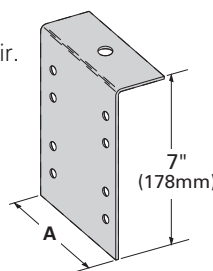

Catalog No.	Outside	'A'	
	Cable Tray Ht.	in.	(mm)
● <b>9(*)-8224</b>	4"	3.84	(97.54)
● <b>9(*)-8225</b>	5"	4.73	(120.14)
● <b>9(*)-8226</b>	6"	5.84	(148.34)
● <b>9(*)-8227</b>	7"	6.84	(173.74)

## Heavy Duty Hold Down Bracket

- Design load is 2000 lbs (8.89kN) per pair.
- Two bolt design.
- Sold in pairs.
- 3/8" cable tray attachment hardware provided.
- 1/2" support attachment hardware **not** provided.
- (\*) Insert **ZN** or **G**
- Recommended for support of vertical trays.

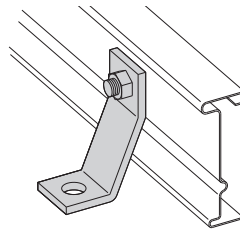

Catalog No.
<b>9(*)-1241</b>

## Heavy Duty Hold Down Bracket

- Design load is 4000 lbs (17.79kN) per pair.
- Four bolt design.
- Sold in pairs.
- 3/8" cable tray attachment hardware provided.
- 1/2" support attachment hardware **not** provided.
- (\*) Insert **ZN** or **G**
- Recommended for support of vertical trays.

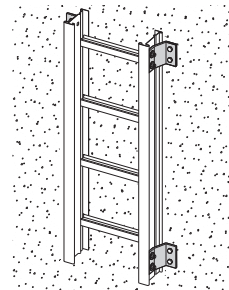
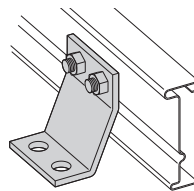

Catalog No.
<b>9(*)-1242</b>

## Beam Clamp

- Finishes available: **ZN** **GRN** **HDG** or **SS4**
- Sold in pieces.
- Design load is 1200 lbs (5.34kN) per pair.
- Safety Load Factor 5.0.
- Order HHCS and Channel Nuts separately.

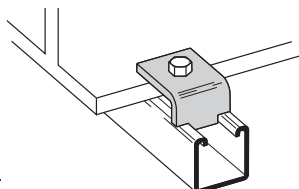

Catalog No.
<b>B355</b>

● Green = Fastest shipped items    ● Black = Normal lead-time items    ● Red = Normally long lead-time items

All dimensions in parentheses are millimeters unless otherwise specified.



# Series 2, 3, 4, & 5 Steel - Accessories

Series 2, 3, 4, & 5 Steel

## Beam Clamp

- Finishes available: **ZN** or **HDG**
- Sold in pieces.
- \*Design load when used in pairs. Safety Load Factor 5.0

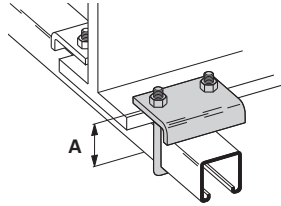

Catalog No.	Design Load lbs (kN)	'A' in. (mm)
<b>B441-22</b>	1200 (5.34)	3 <sup>3</sup> / <sub>8</sub> (86)
<b>B441-22A</b>	1200 (5.34)	5 (127)

## Beam Clamp

- Finishes available: **ZN** **GRN** or **HDG**
- Sold in pieces.
- \*Design load when used in pairs. Safety Load Factor 5.0

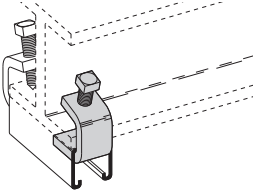

Catalog No.	B212-1/4	B212-3/8
<b>Design Load *</b>	600 lbs. (2.67kN)	1000 lbs. (4.45 kN)
<b>Max. Flange Thick</b>	3/4" (19 mm)	1 1/8" (28.6 mm)
<b>Mat'l. Thickness</b>	1/4" (6.3 mm)	3/8" (9.5 mm)

## B305 Thru B308 & B321 Series Beam Clamps

- Finishes available: **ZN** or **HDG**
- Setscrew included.
- Safety Load Factor 5.0

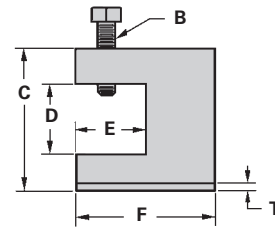
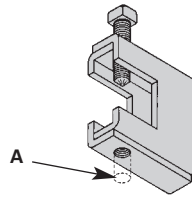

Catalog No.	Rod Size A	B	C in. (mm)	D in. (mm)	E in. (mm)	F in. (mm)	T in. (mm)	Design Load lbs (kN)
<b>B305</b>	3/8"-16	3/8"-16	2 <sup>5</sup> / <sub>16</sub> (58.7)	7/8 (22.2)	1 1/8 (28.6)	2 1/2 (63.5)	11 Ga. (3.0)	600 (2.67)
<b>B306</b>	3/8"-16	1/2"-13	2 <sup>7</sup> / <sub>16</sub> (61.9)	7/8 (22.2)	1 1/8 (28.6)	2 1/2 (63.5)	7 Ga. (4.5)	1100 (4.90)
<b>B307</b>	1/2"-13	1/2"-13	2 <sup>7</sup> / <sub>16</sub> (61.9)	7/8 (22.2)	1 1/8 (28.6)	2 1/2 (63.5)	7 Ga. (4.5)	1100 (4.90)
<b>B308</b>	1/2"-13	1/2"-13	2 <sup>9</sup> / <sub>16</sub> (65.1)	7/8 (22.2)	1 1/8 (28.6)	2 1/2 (63.5)	1/4 (6.3)	1500 (6.68)
<b>B321-1</b>	3/8"-16	1/2"-13	3 <sup>9</sup> / <sub>16</sub> (90.5)	1 11/16 (42.9)	1 <sup>5</sup> / <sub>8</sub> (41.3)	3 1/4 (82.5)	1/4 (6.3)	1300 (5.79)
<b>B321-2</b>	1/2"-13	1/2"-13	3 <sup>9</sup> / <sub>16</sub> (90.5)	1 11/16 (42.9)	1 <sup>5</sup> / <sub>8</sub> (41.3)	3 1/4 (82.5)	1/4 (6.3)	1400 (6.23)

## Anchor Strap - for B305 thru B308 & B321 Series

- Finish available: **ZN**
- For a maximum beam thickness of 3/4" (19mm).
- For thicker beams, step up one flange width size.

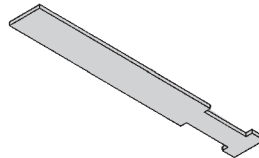

Catalog No.	Flange Width in. (mm)
<b>B312-6</b>	Up to 6 (Up to 152)
<b>B312-9</b>	6 - 9 (152 to 228)
<b>B312-12</b>	9 - 12 (228 to 305)

## Beam Clamp

- Finish available: **ZN**
- Design Load 500 lbs. (2.22 kN)
- Safety Load Factor 5.0
- Recommended torque:  
'J'-Hook Nut 125 In.-Lbs. (14.1 kN/m)
- Maximum flange thickness of 3/4" (19mm).

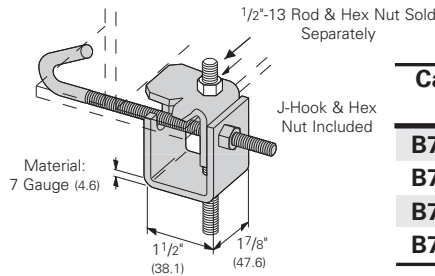

Catalog No.	For Flange Width in. (mm)	Wt./C lbs (kg)
<b>B750-J4</b>	3 - 6 (76.2 - 152.4)	109 (49.4)
<b>B750-J6</b>	5 - 9 (127.0 - 228.6)	124 (56.2)
<b>B750-J9</b>	8 - 12 (203.2 - 304.8)	135 (61.2)
<b>B750-J12</b>	11 - 15 (279.4 - 381.0)	147 (66.7)

## 'J'-Hook

- Finishes available: **ZN**
- Hex Nut included.

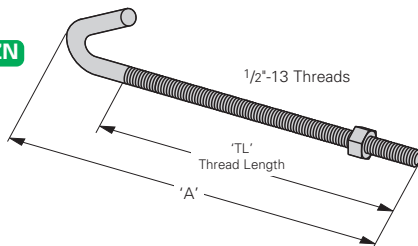

Catalog No.	'A' in. (mm)	'TL' in. (mm)	Wt./C lbs (kg)
<b>B700-J4</b>	8 1/2 (215.9)	5 (127.0)	44 (19.9)
<b>B700-J6</b>	11 1/2 (292.1)	6 (152.4)	53 (24.0)
<b>B700-J9</b>	12 1/4 (368.3)	6 (152.4)	63 (28.6)
<b>B700-J12</b>	17 1/2 (444.5)	6 (152.4)	78 (35.4)

● Green = Fastest shipped items   ● Black = Normal lead-time items   ● Red = Normally long lead-time items

All dimensions in parentheses are millimeters unless otherwise specified.

## Covers

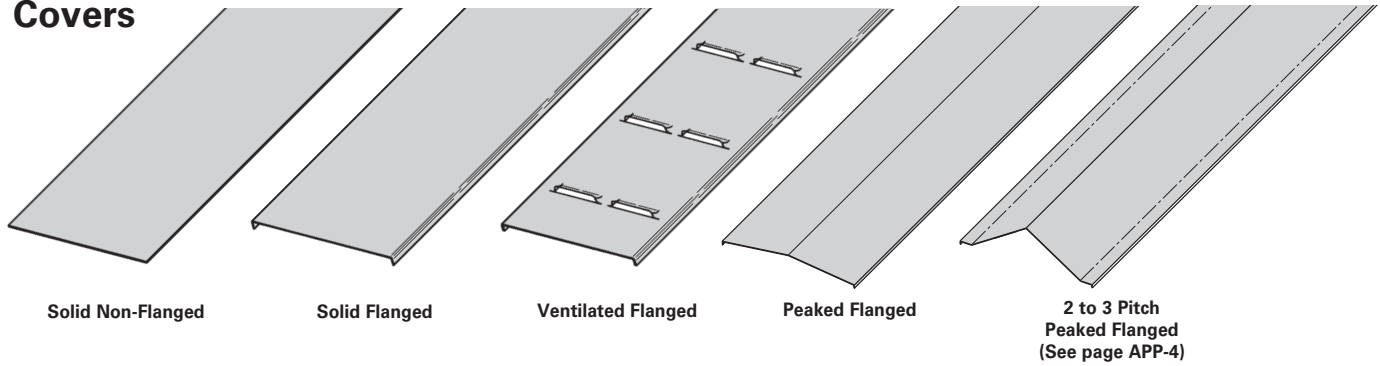

**A full range of covers is available for straight sections and fittings.**

**Solid covers** should be used when maximum enclosure of the cable is desired and no accumulation of heat is expected.

**Ventilated covers** provide an overhead cable shield, yet allow heat to escape.

We recommend that covers be placed on vertical cable tray runs to a height of 6 ft. (1.83 m) to 8 ft. (2.44 m) above the floor to isolate both cables and personnel. **Flanged covers** have a 1/2 in. (13 mm) flange. Cover clamps are not included with the cover and must be ordered separately. All **peaked covers** are flanged. Standard peaked covers have 1/2" peak. Special purpose peaked covers, having a 2 to 3 pitch, provide additional slope and material thickness. The 2 to 3 pitch fitting covers are of multiple piece, welded construction.

## Steel Cover Part Numbering

Example: <sup>Prefix</sup> **80 2 P - 24 - 144**

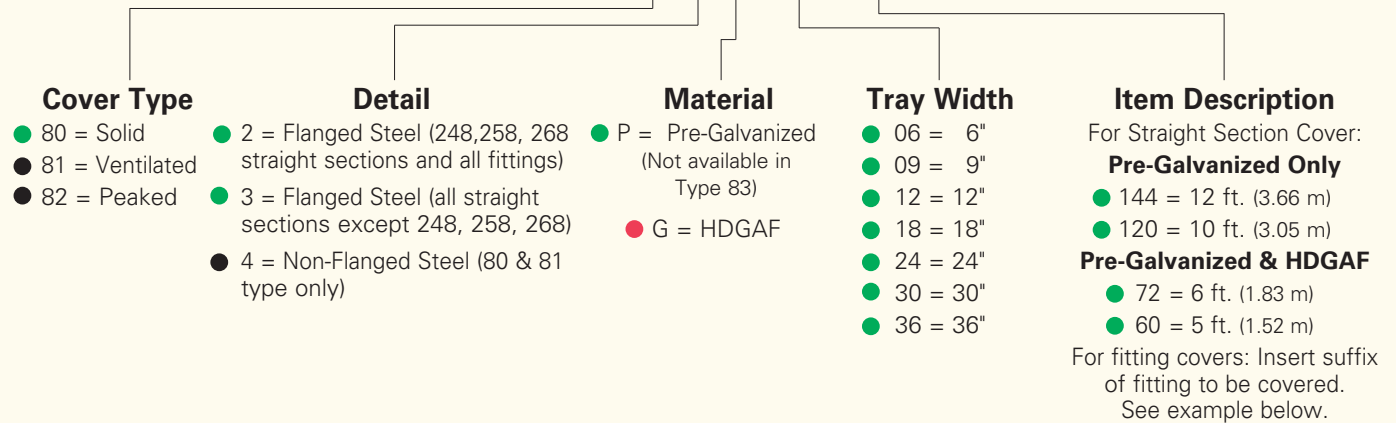

### Examples of Catalog Numbers for Fitting Covers:

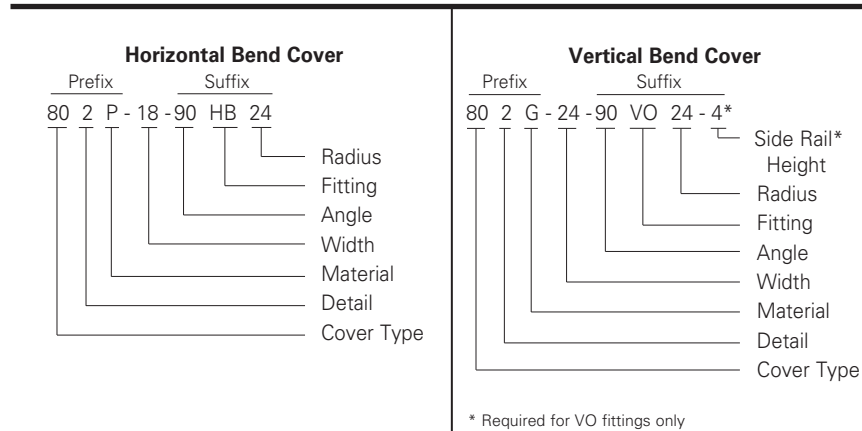

● Green = Fastest shipped items    ● Black = Normal lead-time items    ● Red = Normally long lead-time items

All dimensions in parentheses are millimeters unless otherwise specified.

# Series 2, 3, 4, & 5 Steel - Accessories

Series 2, 3, 4, & 5 Steel

## Standard Cover Clamp

- For indoor service only.
- Screw included.
- Sold per piece.
- (\*) Insert **ZN** or **G**

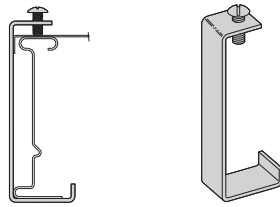

Tray Type	Catalog No.	Side Rail Height in. (mm)
Steel	<b>9(*)-9014</b>	4 (101)
	<b>9(*)-9015</b>	5 (127)
	<b>9(*)-9016</b>	6 (152)
	<b>9(*)-9017</b>	7 (78)

## Combination Cover and Hold Down Clamp

- Sold per piece.
- For indoor service only.
- (\*) Insert **P** or **G**

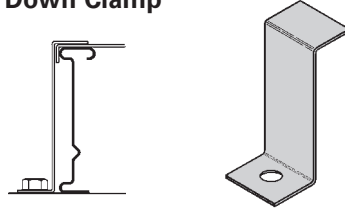

Tray Type	Catalog No.	Side Rail Height in. (mm)
Steel	<b>9(*)-9043</b>	4 (101)
	<b>9(*)-9053</b>	5 (127)
	<b>9(*)-9063</b>	6 (152)
	<b>9(*)-9073</b>	7 (78)

## Raised Cover Clamp

- For indoor service only.
- For use with flanged covers only.
- † Specify gap of 1", 2", 3" or 4".

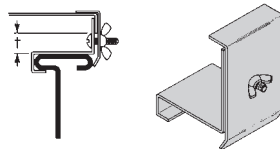

Tray Type	Catalog No.	Tray Type
● <b>9ZN-9114-†</b>	Series 2 Steel Straight Section	
● <b>9ZN-9115-†</b>	Series 3 & 4 Steel Straight Section	
● <b>9ZN-910†</b>	All Steel Fittings (Also Series 1 Steel Straight Sections)	

## Heavy Duty Cover Clamp

- Recommended for outdoor service.
- (‡) Insert tray width
- † Add P to Catalog No. for peaked cover clamp.
- (\*) Insert **P** or **G**

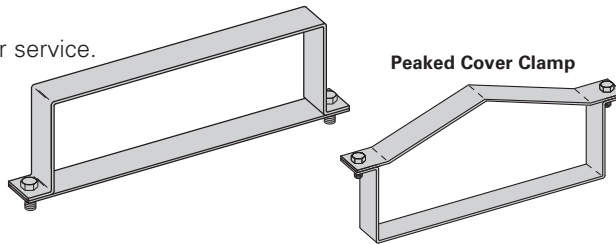

Catalog No.	Side Rail Height in. mm
<b>9(*)-(‡)-9044†</b>	4 (101)
<b>9(*)-(‡)-9054†</b>	5 (127)
<b>9(*)-(‡)-9064†</b>	6 (152)
<b>9(*)-(‡)-9074†</b>	7 (178)

## Quantity of Standard Cover Clamps Required

Notes:  
When using the Heavy Duty Cover Clamp, only on-half the number of clamps stated above is required.  
Additional clamps may be necessary in extreme wind applications.

Straight Section 60" or 72" .....	4 pcs.
Straight Section 120" or 144" .....	6 pcs.
Horizontal/Vertical Bends .....	4 pcs.
Tees .....	6 pcs.
Crosses .....	8 pcs.

## Cover Joint Strip

- Used to join covers
- Plastic
- (‡) Insert tray width

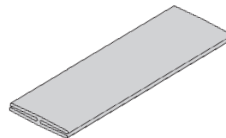

Catalog No.
● <b>99-9980-(‡)</b>

## Cable Cleats

(see pages O-1 thru O-5) Standard

**Trefoil Cable Cleats**



**Single Cable Cleats**



● Green = Fastest shipped items   ● Black = Normal lead-time items   ● Red = Normally long lead-time items

All dimensions in parentheses are millimeters unless otherwise specified.

## Section 1- Acceptable Manufacturers

- 1.01 Manufacturer: Subject to compliance with these specifications, Eaton's B-Line series cable tray systems shall be as manufactured by Eaton.

## Section 2- Cable Tray Sections and Components

- 2.01 General: Except as otherwise indicated, provide metal cable trays, of types, classes and sizes indicated; with splice plates, bolts, nuts and washers for connecting units. Construct units with rounded edges and smooth surfaces; in compliance with applicable standards; and with the following additional construction features. Cable tray shall be installed according to the latest revision of NEMA VE 2.
- 2.02 Pre-Galvanized Steel: Straight sections, fitting side rails, rungs, and covers shall be made from structural quality steel meeting the minimum mechanical properties and mill galvanized in accordance with ASTM A653 SS, Grade 33, coating designation G90. Hardware finish shall be electrogalvanized zinc per ASTM B633.
- 2.03 Hot Dip Galvanized Steel: All side rails, covers, splice plates, and rungs shall be made from structural quality steel meeting the minimum mechanical properties of ASTM A1011 SS, Grade 33 for 14 gauge and heavier, ASTM A1008, Grade 33 Type 2 for 16 gauge and lighter, and shall be hot dip galvanized after fabrication in accordance with ASTM A123. Mill galvanized covers are not acceptable for hot dip galvanized cable tray. Hardware finish shall be chromium zinc per ASTM F-1136-88.
- 2.04 Ladder Cable Trays shall consist of two longitudinal members (side rails) with transverse members (rungs) welded to the side rails. Rungs shall be spaced [6] [9] [12] inches apart. Rung spacing in radiused fittings shall be industry standard 9" and measured at the center of the tray's width. No portion of the rungs shall protrude below the bottom plane of the side rails. Each rung must be capable of supporting a 200 lb. concentrated load at the center of the cable tray over and above the cable load with a safety factor of 1.5.
- 2.05 Ventilated Trough Cable Trays shall consist of two longitudinal members (side rails) with a corrugated bottom welded to the side rails or rungs spaced 4" apart. The peaks of the corrugated bottom shall have a minimum flat cable bearing surface of 2<sup>3</sup>/<sub>4</sub>" and shall be spaced on 6" centers. To provide ventilation in the tray, the valleys of the corrugated bottom shall have 2<sup>1</sup>/<sub>4</sub>" x 4" rectangular holes punched along the width of the bottom.
- 2.06 Non-Ventilated Bottom Trough Cable Trays shall consist of two longitudinal members (side rails) with a corrugated bottom welded to the side rails or a solid sheet over rungs. The peaks of the corrugated bottom shall have a minimum flat cable bearing surface of 2<sup>3</sup>/<sub>4</sub>" and shall be spaced on 6" centers.
- 2.07 Cable tray loading depth shall be [3] [4] [5] [6] inches per NEMA VE 1.
- 2.08 Straight sections shall have side rails fabricated as I-beams. Straight sections shall be supplied in standard [12 foot] [24 foot] [10 foot (3 m)] [20 foot (6 m)] lengths.
- 2.09 Cable tray widths shall be [6] [9] [12] [18] [24] [30] [36] inches or as shown on drawings.
- 2.10 Splice plates shall be manufactured of high strength steel, meeting the minimum mechanical properties of ASTM A1011 HSLAS, Grade 50, Class 1 and be secured with 8 nuts and bolts per plate. The resistance of fixed splice connections between an adjacent section of tray shall not exceed 0.00033 ohm.
- 2.11 All fittings must have a minimum radius of [12] [24] [36] [48] inches.

## Section 3- Loading Capacities and Testing

- 3.01 Cable tray shall be capable of carrying a uniformly distributed load of \_\_\_\_\_ lbs./ft. on a \_\_\_\_\_ ft. support span with a safety factor of 1.5 when supported as a simple span and tested per NEMA VE 1 5.2. In addition to the uniformly distributed load the cable tray shall support 200 lbs. concentrated load at mid-point of span. Load and safety factors specified are applicable to both the side rails and rung capacities. Cable tray shall be made to manufacturing tolerances as specified by NEMA.
- 3.02 Upon request, manufacturer shall provide test reports in accordance with the latest revision of NEMA VE 1 or CSA C22.2 No. 126.

# Series 3 & 4 Stainless Steel - Straight Sections

Series 3 & 4 Stainless Steel



For Stainless Steel Fittings  
see fittings section pages L-1 thru L-17

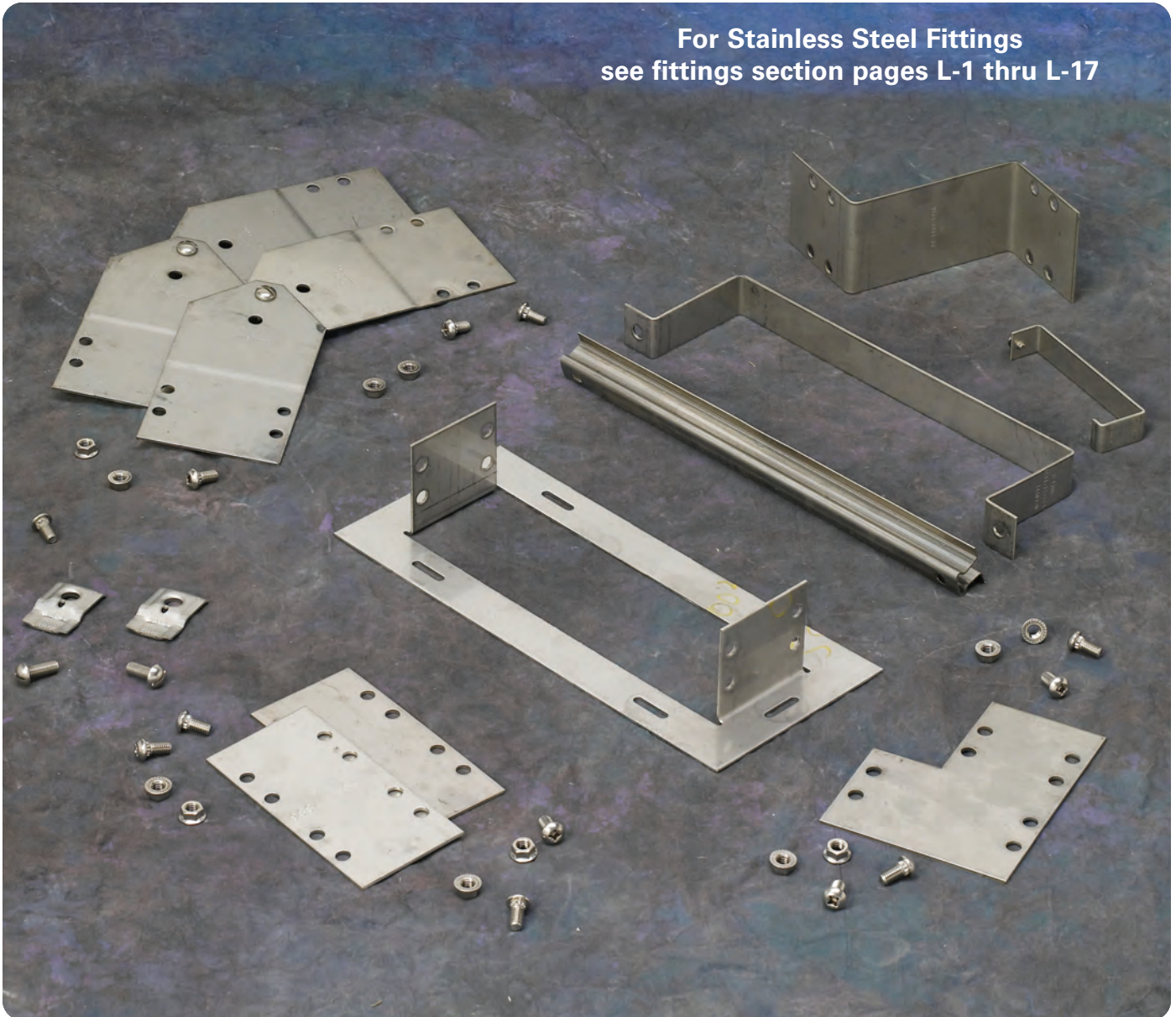

## How The Service Advisor Works

We know that your time is important! That's why the color-coding system in this catalog is designed to help you select products that fit your service needs. Products are marked to indicate the typical lead time for orders of 50 pieces or less.

**Customer:** How do I select my straight sections, covers, or fittings so that I get the quickest turnaround?

**Service Advisor:** Each part of our selection chart is shown in colors. If any section of a part number is a different color, the part will typically ship with the longer lead time represented by the colors.

- Green = Fastest shipped items
- Black = Normal lead-time items
- Red = Normally long lead-time items

**Example:**            348SS4 09 - 12 - 144  
                                 ●        ●        ●        ●

**Part will have a long lead time.**

# Series 3 & 4 Stainless Steel - Straight Sections

## 3" NEMA VE 1 Loading Depth 4" Side Rail Height

### Straight Section Part Numbering

Example: <sup>Prefix</sup> **348 SS6 09 - 24 - 144**

Series	Material	*Type	*Width	Length
● <b>348</b>	● <b>SS4</b> = 304 Stainless Steel	<b>Ladder-</b>	● <b>06</b> = 6"	● ① <b>144</b> = 12 ft.
	● <b>SS6</b> = 316 Stainless Steel	● <b>06</b> = 6" rung spacing	● <b>09</b> = 9"	● ② 120 = 10 ft.
		● <b>09</b> = 9" rung spacing	● <b>12</b> = 12"	①Primary Length.
		● <b>12</b> = 12" rung spacing	● <b>18</b> = 18"	②Secondary Length.
		<b>Trough-</b>	● <b>24</b> = 24"	See page C-23 for explanation of lengths.
		<b>6" and Wider</b>	● <b>30</b> = 30"	Passivation available see page C-2.
		● <b>04</b> = Vented Bottom	● <b>36</b> = 36"	
		● <b>SB</b> = Non-Ventilated		

See page APP-1 for additional rung options. \*Special sizes available.

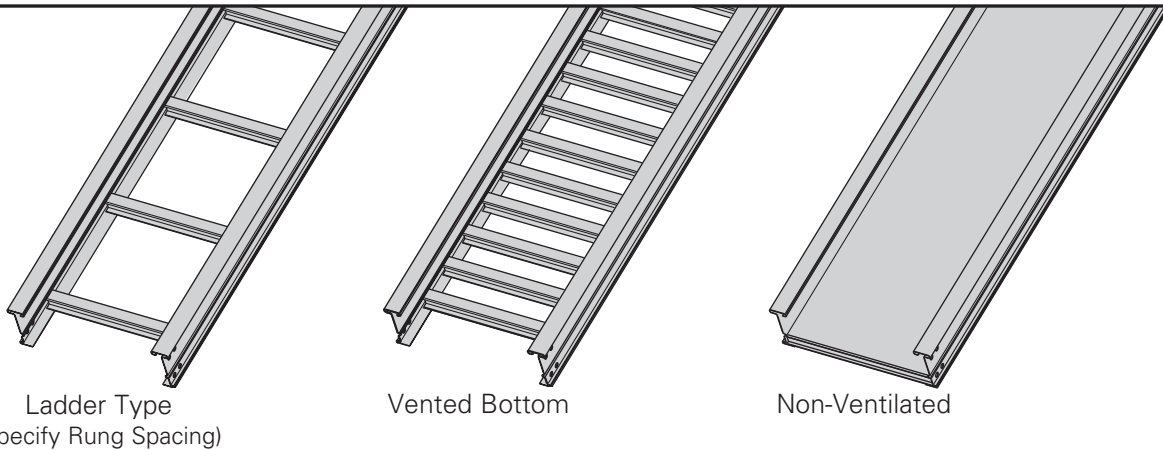
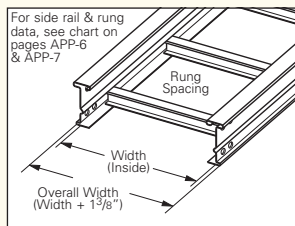

Values are based on simple beam tests per NEMA VE 1 on 36" wide cable tray rungs spaced on 12" centers. Cable trays will support without collapse a 200 lb. (90.7 kg) concentrated load over and above published loads. Published load safety factor is 1.5. To convert 1.5 safety factor to 2.0, multiply published load by 0.75. To obtain mid-span deflection, multiply a load by the deflection multiplier. Cable tray must be supported on spans shorter than or equal to the length of the cable being installed.

B-Line Series	Side Rail Dimensions	NEMA, CSA & UL Classifications	Span ft	Load lbs/ft	Deflection Multiplier	Design Factors for Two Rails	Span meters	Load kg/m	Deflection Multiplier	Design Factors for Two Rails
<b>348 SS†</b>		NEMA: 16A, 12C CSA: C1-3m UL Cross-Sectional Area: 0.40 in <sup>2</sup>	10	180	0.0042	Area = 0.74 in <sup>2</sup> Sx = 0.79 in <sup>3</sup> Ix = 1.85 in <sup>4</sup>	3.0	268	0.072	Area = 4.77 cm <sup>2</sup> Sx = 12.95 cm <sup>3</sup> Ix = 77.00 cm <sup>4</sup>
			12	125	0.009		3.7	186	0.148	
			14	92	0.016		4.3	137	0.275	
			16	70	0.027		4.9	105	0.469	
			18	56	0.044		5.5	83	0.752	
			20	45	0.067		6.1	67	1.145	

When cable trays are used in continuous spans, the deflection of the cable tray is reduced by as much as 50%. Design factors: Ix = Moment of Inertia, Sx = Section Modulus. † Insert 4 for 304 stainless steel or 6 for 316 stainless steel.

● Green = Fastest shipped items ● Black = Normal lead-time items ● Red = Normally long lead-time items

All dimensions in parentheses are millimeters unless otherwise specified.

## 4" NEMA VE 1 Loading Depth 5" Side Rail Height

### Straight Section Part Numbering

Example: **358 SS6 09 - 24 - 144**

Series	Material	*Type	*Width	Length
● <b>358</b>	● <b>SS4</b> = 304 Stainless Steel ● <b>SS6</b> = 316 Stainless Steel	<b>Ladder-</b> ● <b>06</b> = 6" rung spacing ● <b>09</b> = 9" rung spacing ● <b>12</b> = 12" rung spacing  <b>Trough-</b> <b>6" and Wider</b> ● <b>04</b> = Vented Bottom ● <b>SB</b> = Non-Ventilated	● <b>06</b> = 6" ● <b>09</b> = 9" ● <b>12</b> = 12" ● <b>18</b> = 18" ● <b>24</b> = 24" ● <b>30</b> = 30" ● <b>36</b> = 36"	● ① <b>144</b> = 12 ft. 358 ● ② 120 = 10 ft.  ①Primary Length. ②Secondary Length.  See page C-23 for explanation of lengths.  Passivation available see page C-2.

See page APP-1 for additional rung options. \*Special sizes available.

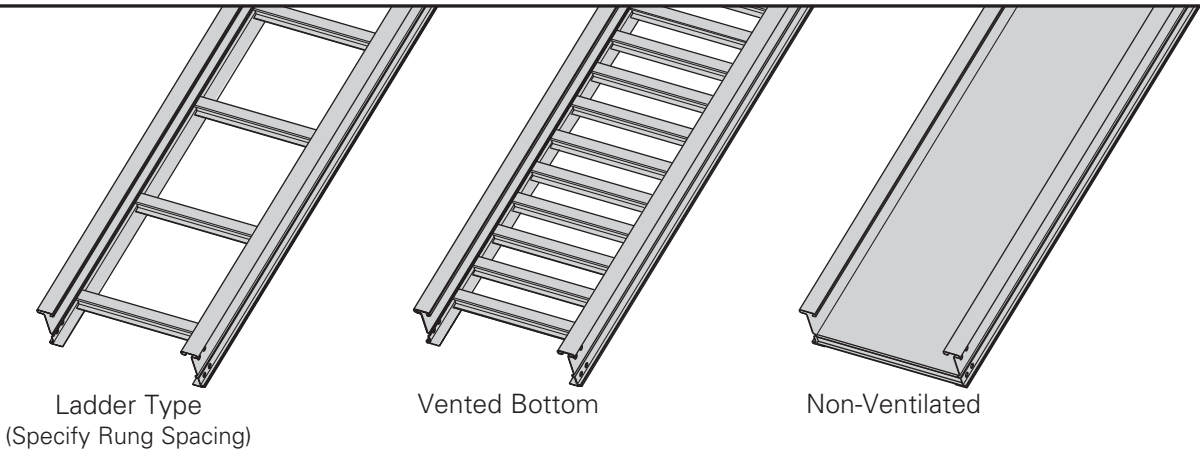
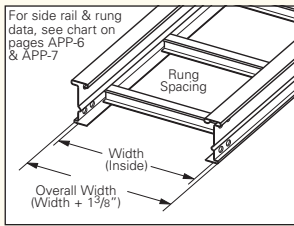

Values are based on simple beam tests per NEMA VE 1 on 36" wide cable tray rungs spaced on 12" centers. Cable trays will support without collapse a 200 lb. (90.7 kg) concentrated load over and above published loads. Published load safety factor is 1.5. To convert 1.5 safety factor to 2.0, multiply published load by 0.75. To obtain mid-span deflection, multiply a load by the deflection multiplier. Cable tray must be supported on spans shorter than or equal to the length of the cable being installed.

B-Line Series	Side Rail Dimensions	NEMA, CSA & UL Classifications	Span ft	Load lbs/ft	Deflection Multiplier	Design Factors for Two Rails	Span meters	Load kg/m	Deflection Multiplier	Design Factors for Two Rails
<b>358 SS†</b>		NEMA: <b>20A</b> , 16B CSA: 89kg/m 6.1m UL Cross-Sectional Area: 0.70 in <sup>2</sup>	10	248	0.0025	Area = 0.83 in <sup>2</sup> Sx = 1.09 in <sup>3</sup> Ix = 3.10 in <sup>4</sup>	3.0	369	0.043	Area = 5.35 cm <sup>2</sup> Sx = 17.86 cm <sup>3</sup> Ix = 129.03 cm <sup>4</sup>
			12	172	0.0052		3.7	256	0.089	
			14	127	0.010		4.3	188	0.164	
			16	97	0.016		4.9	144	0.280	
			18	77	0.026		5.5	114	0.448	
			20	62	0.040		6.1	92	0.684	

When cable trays are used in continuous spans, the deflection of the cable tray is reduced by as much as 50%. Design factors: Ix = Moment of Inertia, Sx = Section Modulus. † Insert 4 for 304 stainless steel or 6 for 316 stainless steel.

● Green = Fastest shipped items    ● Black = Normal lead-time items    ● Red = Normally long lead-time items

All dimensions in parentheses are millimeters unless otherwise specified.



# Series 3 & 4 Stainless Steel - Straight Sections

## 5" NEMA VE 1 Loading Depth 6" Side Rail Height

### Straight Section Part Numbering

Example: <sup>Prefix</sup> **358 SS6 09 - 24 - 144**

Series	Material	*Type	*Width	Length
● <b>368</b>	● <b>SS4</b> = 304 Stainless Steel	<b>Ladder-</b>	● <b>06</b> = 6"	● ① <b>144</b> = 12 ft.    368
● <b>464</b>	● <b>SS6</b> = 316 Stainless Steel	● <b>06</b> = 6" rung spacing	● <b>09</b> = 9"	● ② <b>120</b> = 10 ft.    464
		● <b>09</b> = 9" rung spacing	● <b>12</b> = 12"	① <b>144</b> = 12 ft.
		● <b>12</b> = 12" rung spacing	● <b>18</b> = 18"	② <b>120</b> = 10 ft.
		<b>Trough-</b>	● <b>24</b> = 24"	① Primary Length.
		<b>6" and Wider</b>	● <b>30</b> = 30"	② Secondary Length.
		● <b>04</b> = Vented Bottom	● <b>36</b> = 36"	See page C-23 for explanation of lengths.
		● <b>SB</b> = Non-Ventilated		Passivation available see page C-2.

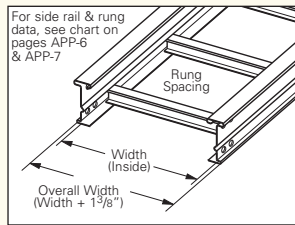

See page APP-1 for additional rung options. \*Special sizes available.

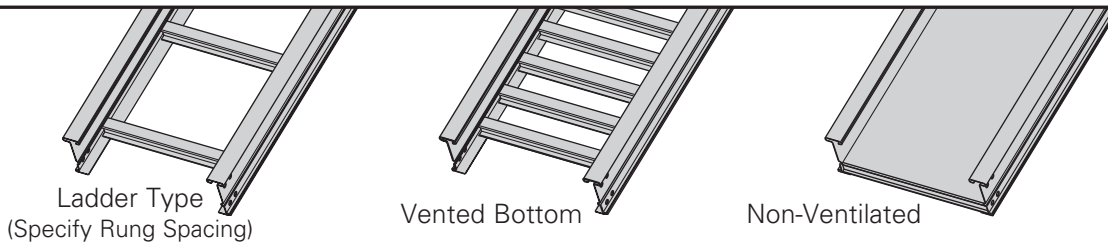

Values are based on simple beam tests per NEMA VE 1 on 36" wide cable tray rungs spaced on 12" centers. Cable trays will support without collapse a 200 lb. (90.7 kg) concentrated load over and above published loads. Published load safety factor is 1.5. To convert 1.5 safety factor to 2.0, multiply published load by 0.75. To obtain mid-span deflection, multiply a load by the deflection multiplier. Cable tray must be supported on spans shorter than or equal to the length of the cable being installed.

B-Line Series	Side Rail Dimensions	NEMA, CSA & UL Classifications	Span ft	Load lbs/ft	Deflection Multiplier	Design Factors for Two Rails	Span meters	Load kg/m	Deflection Multiplier	Design Factors for Two Rails
<b>368 SS†</b>		NEMA: <b>20A, 16B</b> CSA: D1-3m  UL Cross-Sectional Area: 0.70 in <sup>2</sup>	10	236	0.0016	Area = 0.92 in <sup>2</sup> Sx = 1.41 in <sup>3</sup> Ix = 4.77 in <sup>4</sup>	3.0	351	0.028	Area = 5.94 cm <sup>2</sup> Sx = 23.11 cm <sup>3</sup> Ix = 198.54 cm <sup>4</sup>
			12	164	0.0034		3.7	244	0.058	
			14	120	0.0062		4.3	179	0.107	
			16	92	0.011		4.9	137	0.182	
			18	73	0.017		5.5	108	0.291	
			20	59	0.026		6.1	88	0.444	

B-Line Series	Side Rail Dimensions	NEMA, CSA & UL Classifications	Span ft	Load lbs/ft	Deflection Multiplier	Design Factors for Two Rails	Span meters	Load kg/m	Deflection Multiplier	Design Factors for Two Rails
<b>464 SS†</b>		NEMA: <b>20C+</b> CSA: E-6m  UL Cross-Sectional Area: 1.00 in <sup>2</sup>	12	342	0.002	Area = 1.49 in <sup>2</sup> Sx = 2.28 in <sup>3</sup> Ix = 7.65 in <sup>4</sup>	3.7	508	0.036	Area = 9.61 cm <sup>2</sup> Sx = 37.36 cm <sup>3</sup> Ix = 318.42 cm <sup>4</sup>
			16	192	0.007		4.9	286	0.113	
			18	152	0.011		5.5	226	0.182	
			20	123	0.016		6.1	183	0.277	
			22	102	0.024		6.7	151	0.406	
			24	85	0.034		7.3	127	0.574	

When cable trays are used in continuous spans, the deflection of the cable tray is reduced by as much as 50%. Design factors: Ix = Moment of Inertia, Sx = Section Modulus. † Insert 4 for 304 stainless steel or 6 for 316 stainless steel.

● Green = Fastest shipped items    ● Black = Normal lead-time items    ● Red = Normally long lead-time items

All dimensions in parentheses are millimeters unless otherwise specified.

## Splice Plates

- Standard 8-hole pattern for all steel splice plates.
- Furnished in pairs with hardware.
- One pair including hardware provided with straight section. (Expansion splice quantity subtracted)
- Boxed in pairs with hardware.
- (\*) Insert **SS4** or **SS6**

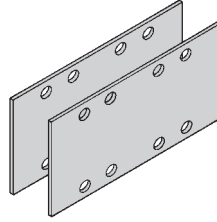

Catalog No.	Height	
	in.	mm
<b>9(*)-8004</b>	4	(101)
<b>9(*)-8005</b>	5	(127)
<b>9(*)-8006</b>	6	(152)

## Expansion Splice Plates

- Expansion plates allow for one inch expansion or contraction of the cable tray, or where expansion joints occur in the support structure.
- Furnished in pairs with hardware.
- Bonding Jumpers are required on each side rail. Order Separately.
- (\*) Insert **SS4** or **SS6**

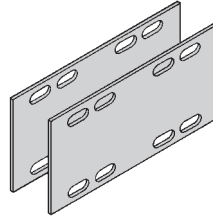

For heavy duty expansion splice plates see page APP-3.

Catalog No.	Height	
	in.	mm
<b>9(*)-8014</b>	4	(101)
<b>9(*)-8015</b>	5	(127)
<b>9(*)-8016</b>	6	(152)

## Universal Splice Plates

- Used to splice to existing cable tray systems.
- Furnished in pairs with hardware.
- (\*) Insert **SS4** or **SS6**

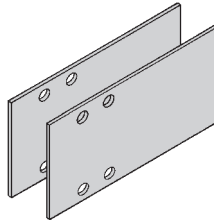

Catalog No.	Height	
	in.	mm
<b>9(*)-8004-1/2</b>	4	(101)
<b>9(*)-8005-1/2</b>	5	(127)
<b>9(*)-8006 -1/2</b>	6	(152)

## Step Down Splice Plates

- These splice plates are offered for connecting cable tray sections having side rails of different heights.
- Furnished in pairs with hardware.
- (\*) Insert **SS4** or **SS6**

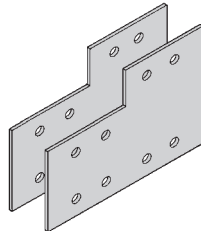

Catalog No.	Height	
	in.	mm
<b>9(*)-8045</b>	5 to 4	(127 to 101)
<b>9(*)-8046</b>	6 to 4	(152 to 101)
<b>9(*)-8060</b>	6 to 5	(152 to 127)

## Vertical Adjustable Splice Plates

- These plates provide for changes in elevation that do not conform to standard vertical fittings.
- Furnished in pairs with hardware.
- Bonding Jumpers not required.
- (\*) Insert **SS4** or **SS6**

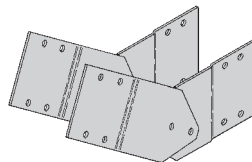

Requires supports within 24" on both sides, per NEMA VE 2.

Catalog No.	Height	
	in.	mm
<b>9(*)-8024</b>	4	(101)
<b>9(*)-8025</b>	5	(127)
<b>9(*)-8026</b>	6	(152)

## Branch Pivot Connectors

- Branch from existing cable tray runs at any point.
- Pivot to any required angle.
- UL Classified for grounding (bonding jumpers not required).
- Furnished in pairs with hardware.
- (\*) Insert **SS4** or **SS6**

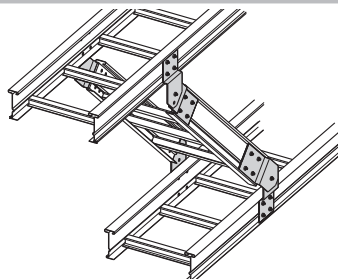

Catalog No.	Height	
	in.	mm
<b>9(*)-8244</b>	4	(101)
<b>9(*)-8245</b>	5	(127)
<b>9(*)-8246</b>	6	(152)

● Green = Fastest shipped items ● Black = Normal lead-time items ● Red = Normally long lead-time items

All dimensions in parentheses are millimeters unless otherwise specified.

# Series 3 & 4 Stainless Steel - Accessories

## Horizontal Adjustable Splice Plates

- Offered to adjust a cable tray run for changes in direction in a horizontal plane that do not conform to standard horizontal fittings.
- Furnished in pairs with hardware.
- Bonding jumpers **not** required.
- (\*) Insert **SS4** or **SS6**
- (X) Insert 4, 5, 6 or 7 for side rail height.

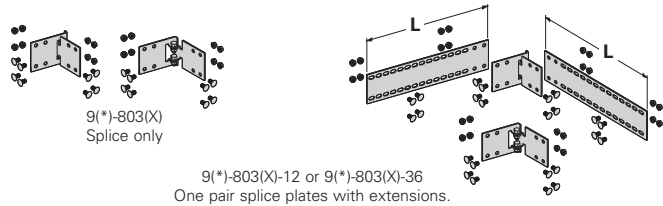

Catalog No.	Cable Tray End Cut	Thru Tray Width		'L'
		in.	(mm)	
<b>9(*)-803(X)</b>	Mitered	36	(914)	N/A (NA)
<b>9(*)-803(X)-12</b>	Not mitered	12	(305)	16 (406)
<b>9(*)-803(X)-36</b>	Not mitered	36	(914)	41 (1041)

Requires supports within 24" on both sides, per NEMA VE 2.

## Offset Reducing Splice Plate

- This plate is used for joining cable trays having different widths. When used in pairs they form a straight reduction; when used singly with a standard splice plate, they form an offset reduction.
- Furnished as one plate with hardware.
- (‡) Insert reduction
- (\*) Insert **SS4** or **SS6**

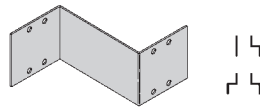

Catalog No.	Height	
	in.	mm
<b>9(*)-8064-(‡)</b>	4	(101)
<b>9(*)-8065-(‡)</b>	5	(127)
<b>9(*)-8066-(‡)</b>	6	(152)

## Tray to Box Splice Plates

- Used to attach the end of a cable tray run to a distribution box or control panel.
- Furnished in pairs with hardware.
- (\*) Insert **SS4** or **SS6**

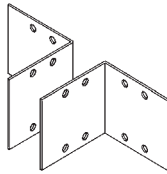

Catalog No.	Height	
	in.	mm
<b>9(*)-8054</b>	4	(101)
<b>9(*)-8055</b>	5	(127)
<b>9(*)-8056</b>	6	(152)

## Frame Type Box Connector

- Designed to attach the end of a cable tray run to a distribution cabinet or control center to help reinforce the box at the point of entry.
- Furnished with tray connection hardware.
- (\*) Insert **SS4** or **SS6**
- (‡) Insert tray width

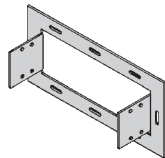

Catalog No.	Height	
	in.	mm
<b>9(*)-8074-(‡)</b>	4	(101)
<b>9(*)-8075-(‡)</b>	5	(127)
<b>9(*)-8076-(‡)</b>	6	(152)

## Blind End

- This plate forms a closure for a dead end cable tray.
- Furnished as one plate with hardware.
- (\*) Insert **SS4** or **SS6**
- (‡) Insert tray width

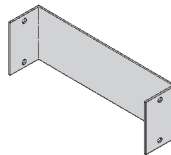

Catalog No.	Height	
	in.	mm
<b>9(*)-8084-(‡)</b>	4	(101)
<b>9(*)-8085-(‡)</b>	5	(127)
<b>9(*)-8086-(‡)</b>	6	(152)

## Cross Connector Bracket

- For field connecting crossing section.
- Furnished in pairs with <sup>3</sup>/<sub>8</sub>" hardware.
- (\*) Insert **SS4** or **SS6**

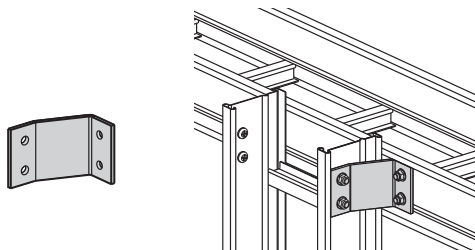

Catalog No.
<b>9(*)-1240</b>

● Green = Fastest shipped items   ● Black = Normal lead-time items   ● Red = Normally long lead-time items

All dimensions in parentheses are millimeters unless otherwise specified.

## Standard Tray Hardware (for field installation drill $1\frac{3}{32}$ " hole)

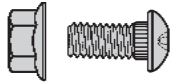

Catalog No.	Description
● <b>RNCB <math>\frac{3}{8}</math>" x <math>\frac{3}{4}</math>" SS6</b>	Ribbed Neck Carriage Bolt AISI 316 Stainless Steel
● <b>SFHN <math>\frac{3}{8}</math>"-16 SS6</b>	Serrated Flange Hex Nut AISI 316 Stainless Steel

## Conduit to Cable Tray Adaptor

- For easy attachment of conduit terminating at a cable tray.
- Use on aluminum or steel cable trays.

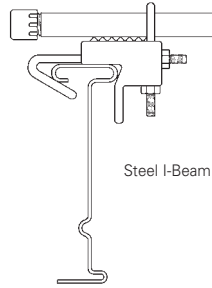
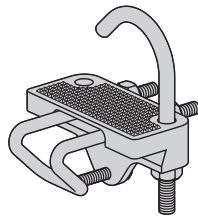

Steel I-Beam

Catalog No.	Conduit Size	
	in.	mm
● <b>9G-1158-1/2, 3/2</b>	$\frac{1}{2}$ , $\frac{3}{4}$	(15, 20)
● <b>9G-1158-1, 1 1/4</b>	1, 1 1/4	(25, 32)
● <b>9G-1158-1 1/2, 2</b>	1 1/2, 2	(40, 50)
● <b>9G-1158-2 1/2, 3</b>	2 1/2, 3	(65, 80)
● <b>9G-1158-3 1/2, 4</b>	3 1/2, 4	(90, 100)

## Conduit to Cable Tray Adaptor

- Assembly required.
- Mounting hardware included.
- Conduit clamps provided.
- (‡) = Insert conduit size ( $\frac{1}{2}$ " thru 4").

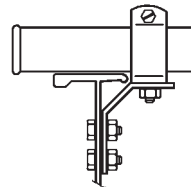

Catalog No.
● <b>9SS4-1150-(‡)</b>

## Conduit to Cable Tray Adaptor

- Assembly required.
- Conduit clamps included.
- (‡) = Insert conduit size ( $\frac{1}{2}$ " thru 4").

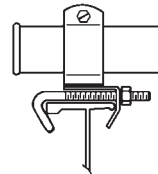
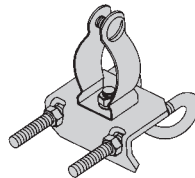

Catalog No.
● <b>9SS4-1155-(‡)</b>

## Cable Tie (Ladder Tray)

- Nylon ties provide easy attachment of cable to ladder rungs; maximum cable O.D. is 3" (76mm).



Overall Length 15" (381mm)

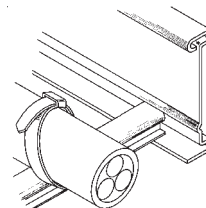

Catalog No.
● <b>99-2125-15</b>

● Green = Fastest shipped items   ● Black = Normal lead-time items   ● Red = Normally long lead-time items

All dimensions in parentheses are millimeters unless otherwise specified.

# Series 3 & 4 Stainless Steel - Accessories

## Ladder Drop-Out

- Specially-designed Ladder Drop-Outs provide a rounded surface with 4" (101 mm) radius to protect cable as it exits from the cable tray, preventing damage to insulation. The drop-out will attach to any desired rung.
- (\*) Insert **SS4** or **SS6**
- (‡) Insert tray width

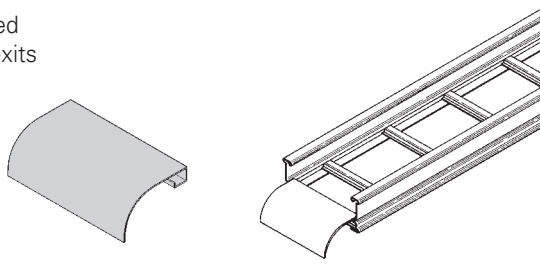

Catalog No.
● <b>9(*)-1104-(‡)</b>

## Barrier - Straight Section

- Length: Insert 120 for [120" - 10 ft.] (3.0 m) or 144 for [144" - 12 ft.] (3.6 m)
- Order catalog number based on loading depth.
- Furnished with four #10 x 1/2" plated self-drilling screws and a 99-9982 Barrier Strip Splice.
- (\*) Insert **SS4** or **SS6**

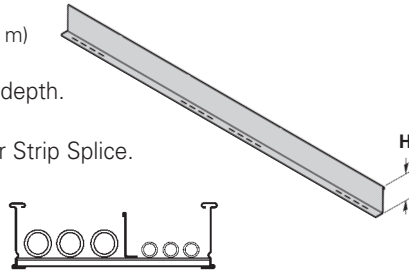

Catalog No.	Side Rail Height in. mm	Loading Depth 'H' in. mm
<b>73(*)-Length</b>	4 (101)	3 (76)
<b>74(*)-Length</b>	5 (127)	4 (101)
<b>75(*)-Length</b>	6 (152)	5 (127)

## Barrier - Horizontal Bend

- Horizontal Bend Barriers are flexible in order to conform to any horizontal fitting radius. Can be cut to desired length.
- Standard length is 72" [6 ft.] (1.8 m) - sold individually
- Order catalog number based on loading depth.
- Furnished with three #10 x 1/2" plated self-drilling screws and a 99-9982 Barrier Strip Splice.
- (\*) Insert **SS4** or **SS6**

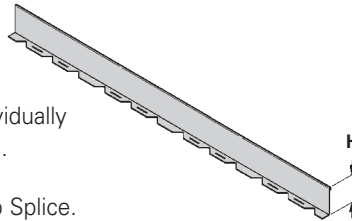

Catalog No.	Side Rail Height in. mm	Loading Depth 'H' in. mm
<b>73(*)-90HBFL</b>	4 (101)	3 (76)
<b>74(*)-90HBFL</b>	5 (127)	4 (101)
<b>75(*)-90HBFL</b>	6 (152)	5 (127)

## Barrier - Vertical Outside Bend

- Vertical Outside Bend Barriers are preformed to conform to a specific vertical outside bend fitting.
- Furnished with three #10 x 1/2" plated self-drilling screws and a 99-9982 Barrier Strip Splice.
- (\*) Insert or
- (\*\*\*) Insert 30, 45, 60 or 90 for degrees
- (†) Insert 12, 24, 36 or 48 for radius

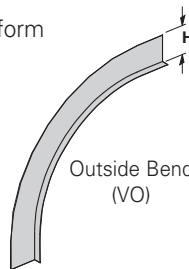

Catalog No.	Side Rail Height in. mm	Loading Depth 'H' in. mm
<b>73(*)-(***)VO(†)</b>	4 (101)	3 (76)
<b>74(*)-(***)VO(†)</b>	5 (127)	4 (101)
<b>75(*)-(***)VO(†)</b>	6 (152)	5 (127)

## Barrier - Vertical Inside Bend

- Vertical Inside Bend Barriers are preformed to conform to a specific vertical inside bend fitting.
- Furnished with three #10 x 1/2" plated self-drilling screws and a 99-9982 Barrier Strip Splice.
- (\*) Insert or
- (\*\*\*) Insert 30, 45, 60 or 90 for degrees
- (†) Insert 12, 24, 36 or 48 for radius

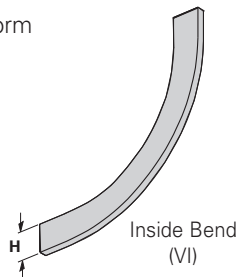

Catalog No.	Side Rail Height in. mm	Loading Depth 'H' in. mm
<b>73(*)-(***)VI(†)</b>	4 (101)	3 (76)
<b>74(*)-(***)VI(†)</b>	5 (127)	4 (101)
<b>75(*)-(***)VI(†)</b>	6 (152)	5 (127)

● Green = Fastest shipped items   ● Black = Normal lead-time items   ● Red = Normally long lead-time items

All dimensions in parentheses are millimeters unless otherwise specified.

## Barrier Strip Clip

- Barrier clip fastens to either aluminum or steel ladder rung.
- Furnished with one #10 x 1/2" zinc plated self-drilling screw.
- (\*) Insert **SS4** or **SS6**

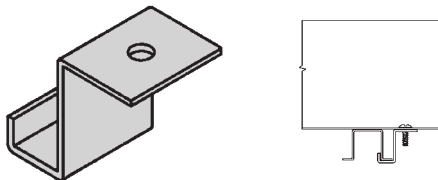

**Catalog No.**  
**9(\*)-9902**

## Barrier Strip Splice

- 2.85" (72.4mm) long
- Ribbed edge for increased rigidity and grip
- Comfort edge for ease of installation
- Slotted top window with center mark for accurate placement and inspection capability
- Patent pending

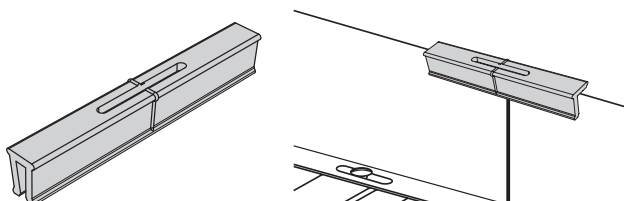

**Catalog No.**  
**99-9982**

## Thread Rod (ATR) & Rod Couplings

Loading based on safety factor 5.  
Standard Finish: Zinc plated  
See B-Line series Strut Systems Catalog for other sizes and finishes.

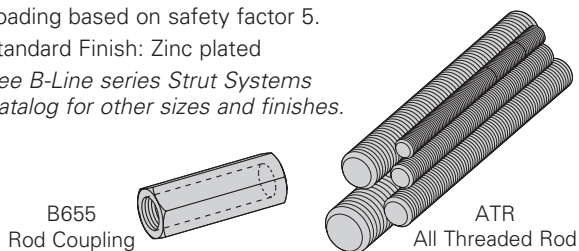

Size	Catalog No.	Available Length	Loading
<b>All Threaded Rod</b>			
3/8"-16	● <b>ATR 3/8" x Length</b>	36", 72", 120", 144"	730 lbs.
1/2"-13	● <b>ATR 1/2" x Length</b>	36", 72", 120", 144"	1350 lbs.
<b>Rod Coupling</b>			
3/8"-16	● <b>B655-3/8"</b>	NA	730 lbs.
1/2"-13	● <b>B655-1/2"</b>	NA	1350 lbs.

## Stainless Steel Cable Clamp

- Fits with series 2, 3, 4 & 5 standard steel rungs.
- Shipped flat. Field form around the cable at the time of installation.

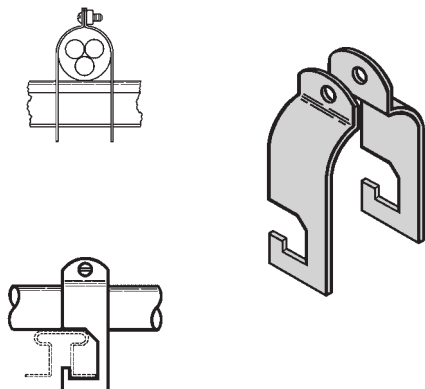

Refer to Section CF  
Cable Fixing

Catalog No.	Cable Size	
	in.	mm
● <b>9SS4-4050</b>	0.50 - 0.75	(13 - 19)
● <b>9SS4-4075</b>	0.75 - 1.00	(19 - 25)
● <b>9SS4-4100</b>	1.00 - 1.25	(25 - 32)
● <b>9SS4-4125</b>	1.25 - 1.50	(32 - 38)
● <b>9SS4-4150</b>	1.50 - 1.75	(38 - 45)
● <b>9SS4-4175</b>	1.75 - 2.00	(45 - 51)
● <b>9SS4-4200</b>	2.00 - 2.25	(51 - 57)
● <b>9SS4-4225</b>	2.25 - 2.50	(57 - 64)
● <b>9SS4-4250</b>	2.50 - 2.75	(64 - 70)
● <b>9SS4-4275</b>	2.75 - 3.00	(70 - 76)
● <b>9SS4-4300</b>	3.00 - 3.25	(76 - 82)
● <b>9SS4-4325</b>	3.25 - 3.50	(82 - 89)
● <b>9SS4-4350</b>	3.50 - 3.75	(89 - 95)
● <b>9SS4-4375</b>	3.75 - 4.00	(95 - 100)
● <b>9SS4-4400</b>	4.00 - 4.25	(100 - 106)
● <b>9SS4-4425</b>	4.25 - 4.50	(106 - 113)
● <b>9SS4-4450</b>	4.50 - 4.75	(113 - 121)
● <b>9SS4-4475</b>	4.75 - 5.00	(121 - 125)

● Green = Fastest shipped items    ● Black = Normal lead-time items    ● Red = Normally long lead-time items

All dimensions in parentheses are millimeters unless otherwise specified.

# Series 3 & 4 Stainless Steel - Accessories

## Cable Tray Clamp/Guide

- Features a no-twist design.
- Has four times the strength of the traditional design.
- Each side is labeled to ensure proper installation.
- Furnished in pairs without hardware.
- Not recommended for vertical support.

When installing this device as an expansion guide on the outside flange of *Steel Side Rail*, use the Catalog No. **B202** Square Washer in order to properly elevate the guide.

Note: For heavy duty or vertical applications see 9(\*)-1241 or 9(\*)-1242 page HAT-20

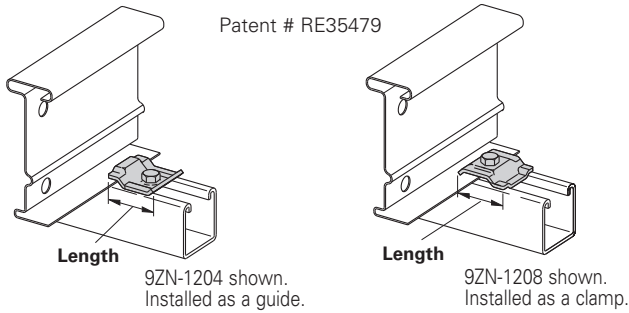

Catalog No.		Overall Length in. (mm)	Hardware Size in.	Finish
Without Hardware	With Hardware			
● 9SS6-1205	--	2 1/4 (57)	1/2"	316SS

## Vertical Hanger Splice Plates

- Design load is 1500 lbs (6.67kN) per pair.
- Safety Factor of 2.5
- Furnished in pairs.
- Hole size: 9/16" (14mm) for 1/2" threaded rod.
- (\*) Insert **SS4** or **SS6**

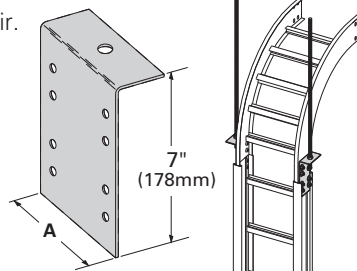

Catalog No.	Outside	'A'	
	Cable Tray Ht.	in.	(mm)
9(*)-8224	4"	3.84	(97.54)
9(*)-8225	5"	4.73	(120.14)
9(*)-8226	6"	5.84	(148.34)
9(*)-8227	7"	6.84	(173.74)

## Cable Tray Clamp

- Hold-down clamps for single or double cable tray runs.
- No drilling of support I-beam or channel is required.
- Sold in pieces - two clamps are required per tray.
- Maximum beam flange thickness 1 1/8" (28.58 mm).
- (\*) Insert **SS4** or **SS6**

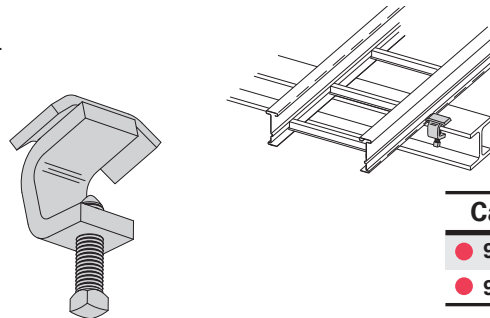

Catalog No.	Finish
● 9SS4-1249HD	304SS
● 9SS6-1249HD	316SS

## Cable Tray Guide

- Expansion guide for single or double cable tray runs.
- Guide allows for longitudinal movement of the cable tray.
- No field drilling of support I-beam or channel is required.
- Guides are required on both sides of cable tray to prevent lateral movement - can be placed on either the inside or outside flange of cable tray.
- Guides are sold in pieces - two guides are required per tray.
- Maximum flange thickness 1 1/8" (28.58 mm).
- (\*) Insert **SS4** or **SS6**

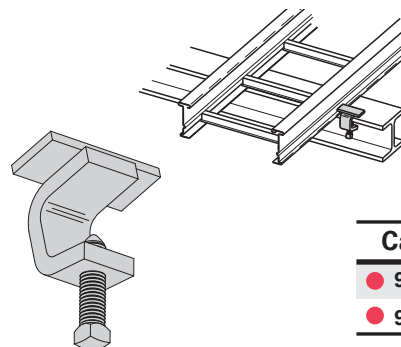

Catalog No.	Finish
● 9SS4-1249	304SS
● 9SS6-1249	316SS

● Green = Fastest shipped items    ● Black = Normal lead-time items    ● Red = Normally long lead-time items

All dimensions in parentheses are millimeters unless otherwise specified.

## Nylon Pad

- Use for friction reduction.
- Hardness: Shore D80.
- Low friction coefficient.
- UV resistant.
- Excellent weatherability.
- UL - 94HB.

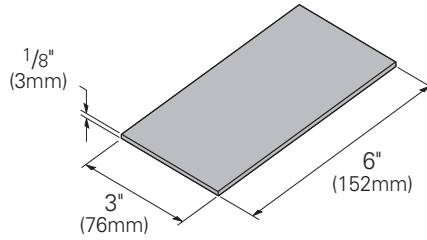

Catalog No.

● 99-PE36

## Neoprene Roll

- Use for material isolation.
- 1/8" x 2" x 25' roll.
- Hardness: Shore A60.
- Good weatherability.

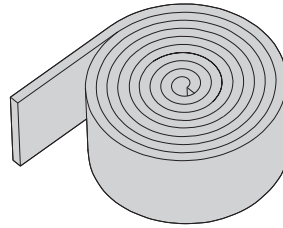

Catalog No.

● 99-NP300

## DURA-BLOK™ Rooftop Support Bases with B22 Channel

- Designed as a superior rooftop support for cable tray,
- UV resistant and approved for most roofing material or other flat surfaces.
- Can be used with any of B-Line series cable tray clamps and guides.
- Ultimate Load Capacity: 1,000 lbs. (uniform load)

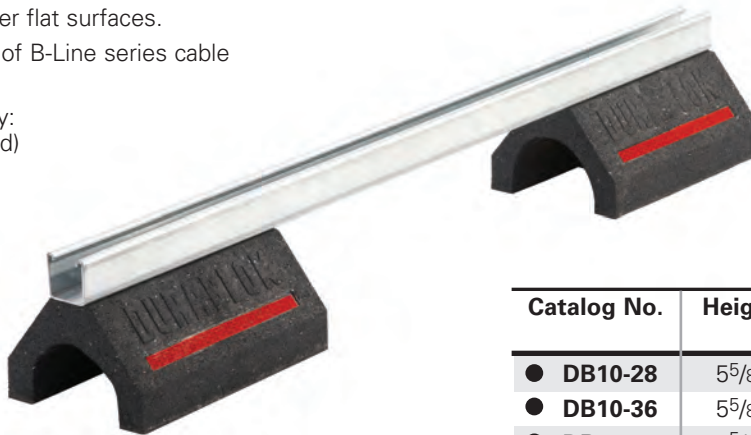

Catalog No.	Height x Width x Length	
	in.	(mm)
● DB10-28	5 <sup>5</sup> / <sub>8</sub> x 6 x 28.0	(143 x 152 x 711)
● DB10-36	5 <sup>5</sup> / <sub>8</sub> x 6 x 36.0	(143 x 152 x 914)
● DB10-42	5 <sup>5</sup> / <sub>8</sub> x 6 x 42.0	(143 x 152 x 1067)
● DB10-50	5 <sup>5</sup> / <sub>8</sub> x 6 x 50.0	(143 x 152 x 1270)
● DB10-60	5 <sup>5</sup> / <sub>8</sub> x 6 x 60.0	(143 x 152 x 1524)



LEEDS credit available, base made from 100% recycled material.

General Note: Consult roofing manufacturer or engineer for roof load capacity. The weakest point may be the insulation board beneath the rubber membrane.

● Green = Fastest shipped items    ● Black = Normal lead-time items    ● Red = Normally long lead-time items

All dimensions in parentheses are millimeters unless otherwise specified.



# Series 3 & 4 Stainless Steel - Accessories

## Trapeze Support Kit

- Eaton's B-Line series trapeze kits provide the components required for a single trapeze support in one package. These kits are available in Type 304 or Type 316 stainless steel.
- The SH channel provides the convenience of pre-punched slots, which eliminate the need for field drilling.
- The illustrated hardware is sealed in a plastic bag and boxed with the channel, which is pre-cut to the appropriate length as shown in the chart.
- Designed for use with 1/2" threaded rod. Order rod separately.

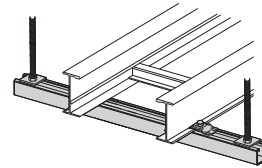
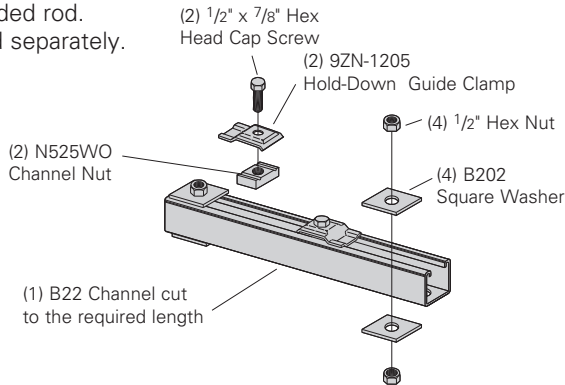

Catalog No.	Tray Width		Channel Length		Uniform Load	
	in.	mm	in.	mm	lbs	kN
● 9(*)-5506-22SH(†)	6	(152)	16	(406)	1350	(6.00)
● 9(*)-5509-22SH(†)	9	(229)	18	(457)	1250	(5.56)
● 9(*)-5512-22SH(†)	12	(305)	22	(559)	1125	(5.00)
● 9(*)-5518-22SH(†)	18	(457)	28	(711)	865	(3.85)
● 9(*)-5524-22SH(†)	24	(610)	34	(864)	700	(3.11)
● 9(*)-5530-22SH(†)	30	(762)	40	(1016)	590	(2.62)
● 9(*)-5536-22SH(†)	36	(914)	46	(1168)	510	(2.27)
● 9(*)-5542-22SH(†)	42	(1067)	52	(1321)	450	(2.00)

- (\*) Insert **SS4** or **SS6**
- (†) Insert 3/8 for 3/8" threaded rod hardware. Safety factor of 3.0 on all loads.

Series 3 & 4 Stainless Steel

## Heavy Duty Trapeze Support Kit

- Eaton's B-Line series trapeze kits provide the components required for a single trapeze support in one package. These kits are available in Type 304 or Type 316 stainless steel.
- The SH channel provides the convenience of pre-punched slots, which eliminates the need for field drilling.
- The illustrated hardware is sealed in a plastic bag and boxed with the channel, which is pre-cut to the appropriate length as shown in the chart.
- Designed for use with 1/2" threaded rod. Order rod separately.

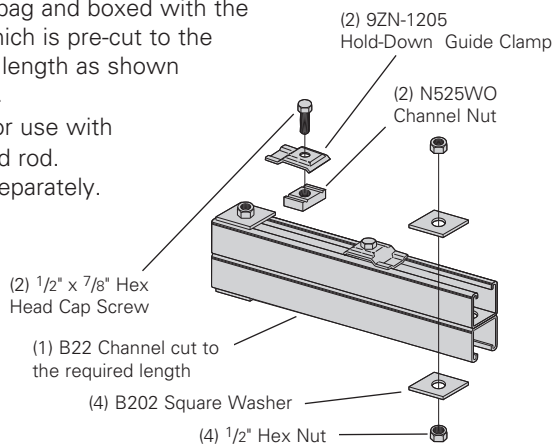

Catalog No.	Tray Width		Channel Length		Uniform Load	
	in.	mm	in.	mm	lbs	kN
● 9(*)-5506-22SHA	6	(152)	16	(406)	1350	(6.00)
● 9(*)-5509-22SHA	9	(229)	18	(457)	1350	(6.00)
● 9(*)-5512-22SHA	12	(305)	22	(559)	1350	(6.00)
● 9(*)-5518-22SHA	18	(457)	28	(711)	1350	(6.00)
● 9(*)-5524-22SHA	24	(610)	34	(864)	1350	(6.00)
● 9(*)-5530-22SHA	30	(762)	40	(1016)	1350	(6.00)
● 9(*)-5536-22SHA	36	(914)	46	(1168)	1350	(6.00)
● 9(*)-5542-22SHA	42	(1067)	52	(1321)	1350	(6.00)

- (\*) Insert **SS4** or **SS6**
- Safety factor of 3.0 on all loads.

## Trapeze Hardware Kit

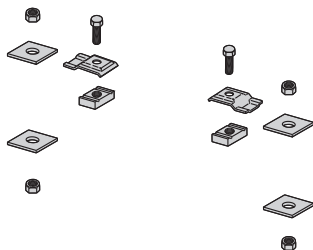

Catalog No.	● 9SS4-5500-1/2	● 9SS6-5500-1/2
In plastic bag	1 pr. 9SS6-1205 2 HHC Screw 1/2 x 7/8 SS4 2 N525 WO SS6 4 B202 SS4 1/2" sq washer 4 HN 1/2 SS4	1 pr. SS6-1205 2 HHC Screw 1/2 x 7/8 SS6 2 N525 WO SS6 4 B202 SS6 1/2" sq washer 4 HN 1/2" SS6

● Green = Fastest shipped items   ● Black = Normal lead-time items   ● Red = Normally long lead-time items

All dimensions in parentheses are millimeters unless otherwise specified.

## Bracket (12"-42")

- (\*) Insert available finish: **SS4** or **SS6**
- Safety Load Factor 2.5

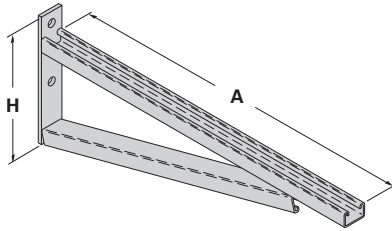

Bottom brace is B42 channel on B494-24 and smaller and B22 channel on B494-30 and larger

Catalog No.	Uniform Load		Tray Width		'A'		'H'	
	lbs	(kN)	in.	(mm)	in.	(mm)	in.	(mm)
<b>B494-12</b>	2500	(11.12)	6 & 9	(152 & 229)	12	(305)	8 <sup>3</sup> / <sub>4</sub>	(222)
<b>B494-18</b>	1700	(7.56)	12	(305)	18	(457)	8 <sup>3</sup> / <sub>4</sub>	(222)
<b>B494-24</b>	1300	(5.78)	18	(457)	24	(610)	8 <sup>3</sup> / <sub>4</sub>	(222)
<b>B494-30</b>	1600	(7.11)	24	(610)	30	(762)	11 <sup>1</sup> / <sub>4</sub>	(286)
<b>B494-36</b>	1100	(4.89)	30	(762)	36	(914)	11 <sup>1</sup> / <sub>4</sub>	(286)
<b>B494-42</b>	980	(4.36)	36	(914)	42	(1067)	16	(406)
<b>B494-48</b>	980	(4.36)	42	(1067)	48	(1219)	16	(406)

For more dimensional data see Strut Systems catalog

## Cantilever Bracket

- (\*) Insert available finish: **SS4** or **SS6**
- Safety Load Factor 2.5

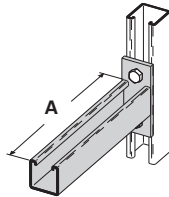

Catalog No.	Uniform Load		Tray Width		'A'	
	lbs	kN	in.	mm	in.	mm
<b>B409-12(*)</b>	960	(4.27)	6 & 9	(152 & 229)	12	(305)
<b>B409-18(*)</b>	640	(2.84)	12	(305)	18	(457)
<b>B409-24(*)</b>	480	(2.13)	18	(457)	24	(610)

## Cantilever Bracket

- (\*) Insert available finish: **SS4** or **SS6**
- Safety Load Factor 2.5

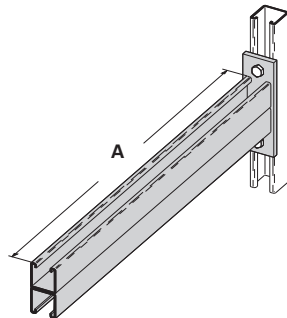

Catalog No.	Uniform Load		Tray Width		'A'	
	lbs	kN	in.	mm	in.	mm
<b>B297-12(*)</b>	1660	(7.38)	6 & 9	(152 & 229)	12	(305)
<b>B297-18(*)</b>	1100	(4.89)	12	(305)	18	(457)
<b>B297-24(*)</b>	835	(3.71)	18	(457)	24	(610)
<b>B297-30(*)</b>	665	(2.93)	24	(610)	30	(762)
<b>B297-36(*)</b>	550	(2.44)	30	(762)	36	(914)
<b>B297-42(*)</b>	465	(2.06)	36	(914)	42	(1067)

● Green = Fastest shipped items ● Black = Normal lead-time items ● Red = Normally long lead-time items

All dimensions in parentheses are millimeters unless otherwise specified.

# Series 3 & 4 Stainless Steel - Accessories

## Heavy Duty Hold Down Bracket

- Design load is 2000 lbs (8.89kN) per pair.
- Two bolt design.
- Sold in pairs.
- 3/8" cable tray attachment hardware provided.
- 1/2" support attachment hardware **not** provided.
- (\*) Insert **SS4** or **SS6**
- Recommended for support of vertical trays.

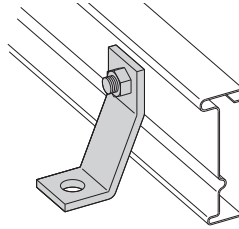

Catalog No.

9(\*)-1241

## Heavy Duty Hold Down Bracket

- Design load is 4000 lbs (17.79kN) per pair.
- Four bolt design.
- Sold in pairs.
- 3/8" cable tray attachment hardware provided.
- 1/2" support attachment hardware **not** provided.
- (\*) Insert **SS4** or **SS6**
- Recommended for support of vertical trays.

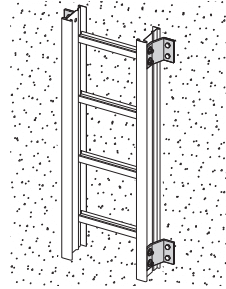
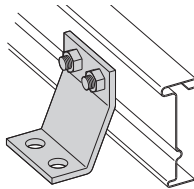

Catalog No.

9(\*)-1242

## Beam Clamp

- Finishes available: **SS4**
- Sold in pieces.
- Design load is 1200 lbs (5.34kN) per pair.
- Safety Load Factor 5.0.
- Order HHCS and Channel Nuts separately.

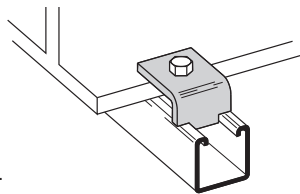

Catalog No.

B35SS4

## Beam Clamp

- (\*) Insert **SS4** or **SS6**
- Sold in pieces.
- \*Design load when used in pairs. Safety Load Factor 5.0

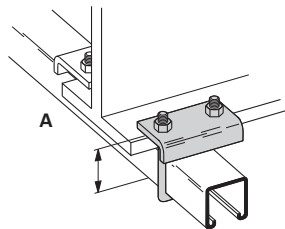

Catalog No.	Design Load		'A'	
	lbs	(kN)	in.	(mm)
<b>B441-22(*)</b>	1200	(5.34)	3 3/8	(86)
<b>B441-22A(*)</b>	1200	(5.34)	5	(127)

## Beam Clamp

- Finishes available: **SS4**
- Sold in pieces.
- \*Design load when used in pairs. Safety Load Factor 5.0

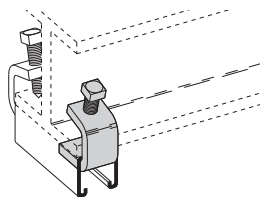

Catalog No.	B212-1/4SS4	B212-3/8SS6
<b>Design Load *</b>	600 lbs. (2.67kN)	1000 lbs. (4.45 kN)
<b>Max. Flange Thick</b>	3/4" (19 mm)	1 1/8" (28.6 mm)
<b>Mat'l. Thickness</b>	1/4" (6.3 mm)	3/8" (9.5 mm)

● Green = Fastest shipped items   ● Black = Normal lead-time items   ● Red = Normally long lead-time items

All dimensions in parentheses are millimeters unless otherwise specified.

## Covers

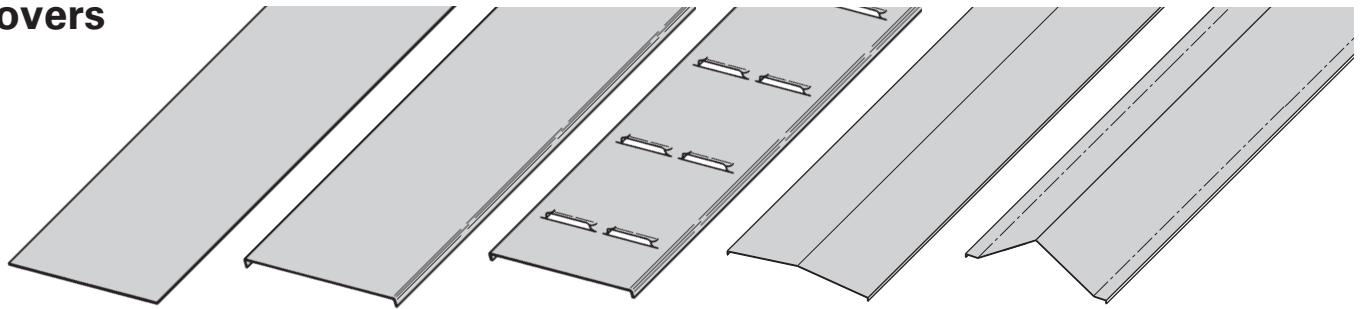

Solid Non-Flanged

Solid Flanged

Ventilated Flanged

Peaked Flanged

2 to 3 Pitch Peaked Flanged  
(See page APP-4)

A full range of covers is available for straight sections and fittings.

**Solid covers** should be used when maximum enclosure of the cable is desired and no accumulation of heat is expected.

**Ventilated covers** provide an overhead cable shield yet allow heat to escape.

We recommends that covers be placed on vertical cable tray runs to a height of 6 ft. (1.83 m) to 8 ft. (2.44 m) above the floor to isolate both cables and personnel. **Flanged covers** have a 1/2 in. (13 mm) flange. Cover clamps are not included with the cover and must be ordered separately. All **peaked covers** are flanged. Standard peaked covers have 1/2" peak. Special purpose peaked covers, having a 2 to 3 pitch, provide additional slope and material thickness. The 2 to 3 pitch fitting covers are of multiple piece, welded construction.

## Steel Cover Part Numbering

Example: **80 2 SS4 - 24 - 144**

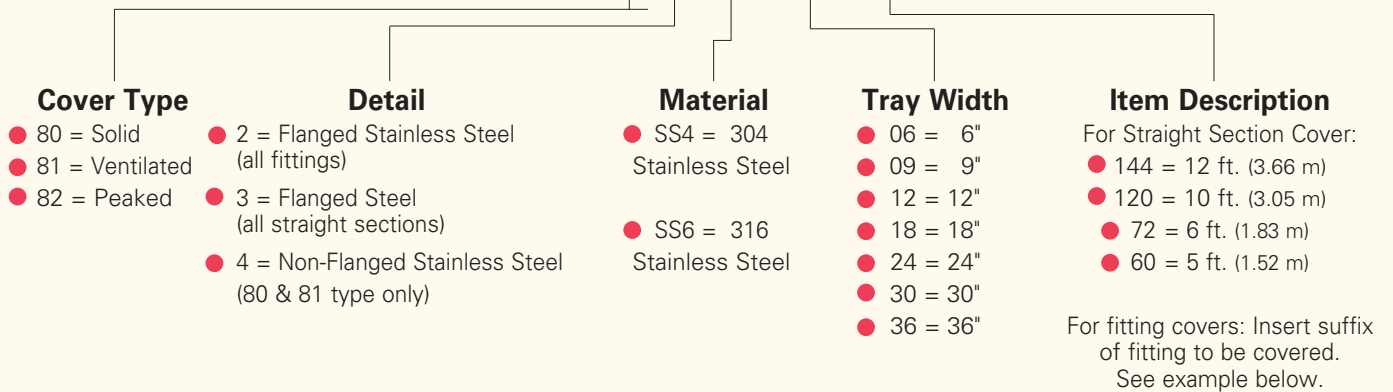

### Examples of Catalog Numbers for Fitting Covers:

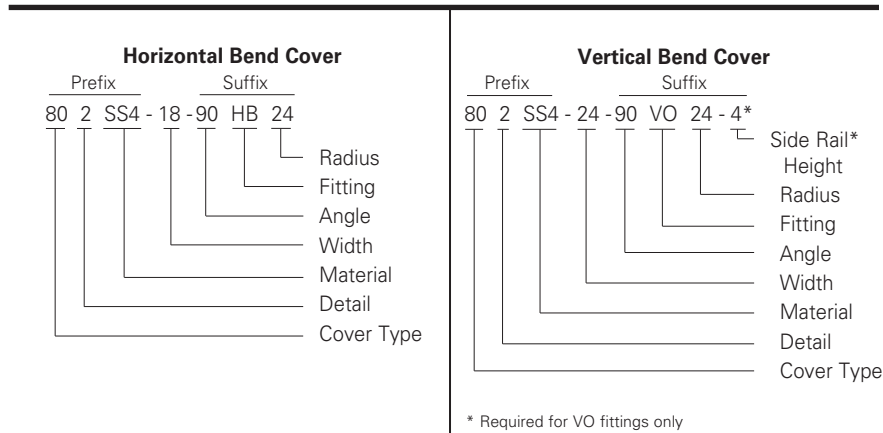

● Green = Fastest shipped items    ● Black = Normal lead-time items    ● Red = Normally long lead-time items

All dimensions in parentheses are millimeters unless otherwise specified.

# Series 3 & 4 Stainless Steel - Accessories

## Standard Cover Clamp

- For indoor service only.
- Screw included.
- Sold per piece.

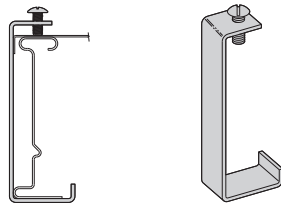

Tray Type	Catalog No.	Side Rail Height	
		in.	(mm)
Stainless Steel	<b>9SS6-9014</b>	4	(101)
	<b>9SS6-9015</b>	5	(127)
	<b>9SS6-9016</b>	6	(152)

## Combination Cover and Hold Down Clamp

- Sold per piece.
- For indoor service only.
- (\*) Insert **SS4** or **SS6**

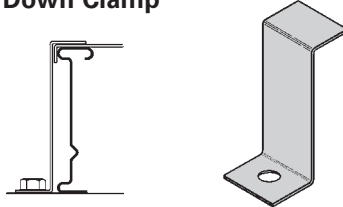

Tray Type	Catalog No.	Side Rail Height	
		in.	(mm)
Stainless Steel	<b>9(*)-9043</b>	4	(101)
	<b>9(*)-9053</b>	5	(127)
	<b>9(*)-9063</b>	6	(152)

## Raised Cover Clamp

- For indoor service only.
- For use with flanged covers only.
- † Specify gap of 1", 2", 3" or 4".
- (\*) Insert **SS4** or **SS6**

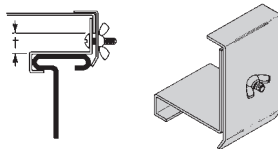

Tray Type	Catalog No.	Tray Type
● <b>9(*)-9115-†</b>	Series 3 & 4 Steel Straight Section	
● <b>9(*)-910†</b>	All Steel Fittings (Also Series 1 Steel Straight Sections)	

## Heavy Duty Cover Clamp

- Recommended for outdoor service.
- (‡) Insert tray width
- † Add P to Catalog No. for peaked cover clamp.
- (\*) Insert **SS4** or **SS6**

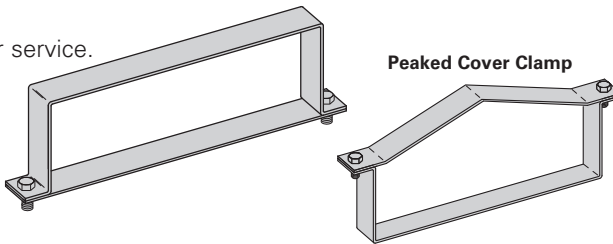

Catalog No.	Side Rail Height	
	in.	mm
<b>9(*)-(‡)-9044†</b>	4	(101)
<b>9(*)-(‡)-9054†</b>	5	(127)
<b>9(*)-(‡)-9064†</b>	6	(152)

## Quantity of Standard Cover Clamps Required

Notes:

When using the Heavy Duty Cover Clamp, only on-half the number of clamps stated above is required.

Additional clamps may be necessary in extreme wind applications.

Straight Section 60" or 72" .....	4 pcs.
Straight Section 120" or 144" .....	6 pcs.
Horizontal/Vertical Bends .....	4 pcs.
Tees .....	6 pcs.
Crosses .....	8 pcs.

## Cover Joint Strip

- Used to join covers
- Plastic
- (‡) Insert tray width

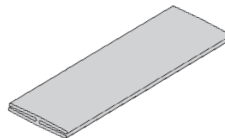

Catalog No.
● <b>99-9980-(‡)</b>

## Cable Cleats

(see pages O-1 thru O-5) Standard

**Trefoil Cable Cleats**



**Single Cable Cleats**

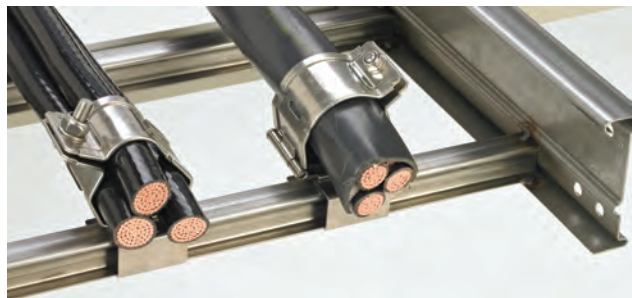
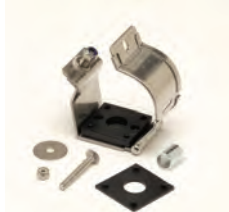

● Green = Fastest shipped items    ● Black = Normal lead-time items    ● Red = Normally long lead-time items

All dimensions in parentheses are millimeters unless otherwise specified.

## Section 1- Acceptable Manufacturers

- 1.01 Manufacturer: Subject to compliance with these specifications, Eaton's B-Line series cable tray systems shall be as manufactured by Eaton.

## Section 2- Cable Tray Sections and Components

- 2.01 General: Except as otherwise indicated, provide metal cable trays, of types, classes and sizes indicated; with splice plates, bolts, nuts and washers for connecting units. Construct units with rounded edges and smooth surfaces; in compliance with applicable standards; and with the following additional construction features. Cable tray shall be installed according to the latest revision of NEMA VE 2.
- 2.02 Stainless Steel: Straight section and fitting side rails and rungs shall be made of AISI Type [304] [316] stainless steel. Transverse members (rungs) or corrugated bottoms shall be welded to the side rails with Type 316 stainless steel welding wire. Hardware shall be AISI Type 316 stainless steel.
- 2.03 Ladder Cable Trays shall consist of two longitudinal members (side rails) with transverse members (rungs) welded to the side rails. Rungs shall be spaced [6] [9] [12] inches apart. Rung spacing in radiused fittings shall be industry standard 9" and measured at the center of the tray's width. Each rung must be capable of supporting a 200 lb. concentrated load at the center of the cable tray with a safety factor of 1.5.
- 2.04 Ventilated Trough Cable Trays shall consist of two longitudinal members (side rails) with a corrugated bottom welded to the side rails or rungs spaced 4" apart. The peaks of the corrugated bottom shall have a minimum flat cable bearing surface of 2<sup>3</sup>/<sub>4</sub>" and shall be spaced on 6" centers. To provide ventilation in the tray, the valleys of the corrugated bottom shall have 2<sup>1</sup>/<sub>4</sub>" x 4" rectangular holes punched along the width of the bottom.
- 2.05 Non-Ventilated Bottom Trough Cable Trays shall consist of two longitudinal members (side rails) with a corrugated bottom welded to the side rails or a solid sheet over rungs. The peaks of the corrugated bottom shall have a minimum flat cable bearing surface of 2<sup>3</sup>/<sub>4</sub>" and shall be spaced on 6" centers.
- 2.06 Cable tray loading depth shall be [3] [4] [5] inches per NEMA VE 1.
- 2.07 Straight sections shall be fabricated as I-beams. Straight sections shall be supplied in standard [12 foot] [24 foot] [10 foot (3 m)] [20 foot (6 m)] lengths.
- 2.08 Cable tray widths shall be [6] [9] [12] [18] [24] [30] [36] inches or as shown on drawings.
- 2.09 Splice plates shall be manufactured of high strength steel and be secured with 8 nuts and bolts per plate. The resistance of fixed splice connections between an adjacent section of tray shall not exceed 0.00033 ohm.
- 2.11 All fittings must have a minimum radius of [12] [24] [36] [48] inches.

## Section 3- Loading Capacities and Testing

- 3.01 Cable tray shall be capable of carrying a uniformly distributed load of \_\_\_\_\_ lbs./ft. on a \_\_\_\_\_ ft. support span with a safety factor of 1.5 when supported as a simple span and tested per NEMA VE 1 5.2. In addition to the uniformly distributed load the cable tray shall support 200 lbs. concentrated load at mid-point of span. Load and safety factors specified are applicable to both the side rails and rung capacities. Cable tray shall be made to manufacturing tolerances as specified by NEMA.
- 3.02 Upon request, manufacturer shall provide test reports in accordance with the latest revision of NEMA VE 1 or CSA C22.2 No. 126.

# Series 2, 3, 4, & 5 - Fittings



Series 2, 3, 4, & 5 Fittings



## How The Service Advisor Works

We know that your time is important! That's why the color-coding system in this catalog is designed to help you select products that fit your service needs. Products are marked to indicate the typical lead time for orders of 50 pieces or less.

**Customer:** How do I select my fittings so that I get the quickest turnaround?

**Service Advisor:** Each part of our selection chart is shown in colors. If any section of a part number is a different color, the part will typically ship with the longer lead time represented by the colors.

- Green = Fastest shipped items
- Black = Normal lead-time items
- Red = Normally long lead-time items

**Example:**                    5     G   - 09   - 90   HB   24

●     ●     ●     ●     ●     ●

**Part will have a long lead time because of the G material.**

Changing the part number from G to A or P will change the coding to black and reduce lead time.



# Series 2, 3, 4, & 5 - Fittings

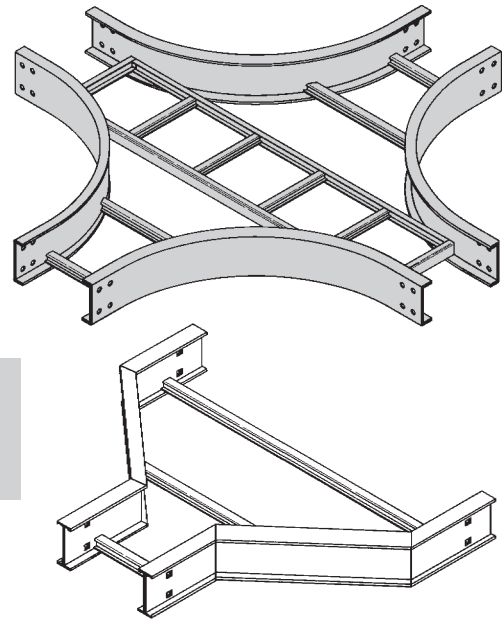
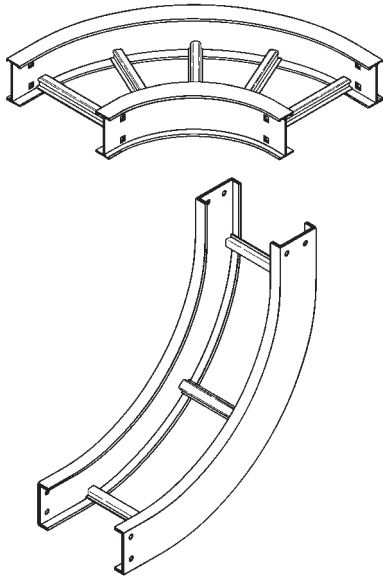

Fittings engineered with 3" tangents for splicing integrity.

## Fittings Part Numbering

Example: **4 A - 24 - 90 HB 24** (9" rung spacing is standard)

Side Rail Height	Material	Width	Angle	Type	Radius
● 4 = 4" (101)	● A = Aluminum	● 06 = 6" (152)	● 30 = 30°	● HB = Horizontal Bend	● 12 = 12" (305)
● 5 = 5" (127)	● G = HDGAF	● 09 = 9" (228)	● 45 = 45°	● HT = Horizontal Tee	● 24 = 24" (609)
● 6 = 6" (152)	● P = Pre-Galvanized	● 12 = 12" (305)	● 60 = 60°	● HX = Horizontal Cross	● 36 = 36" (914)
● 7 = 7" (178)	● SS4 = 304 Stainless Steel	● 18 = 18" (457)	● 90 = 90°	● VI = Vertical Inside Bend	● 48 = 48" (1219)
	● SS6 = 316 Stainless Steel	● 24 = 24" (609)		● VO = Vertical Outside Bend	
		● 30 = 30" (762)		● VT = Vertical Tee	
		● 36 = 36" (914)		● VTU = Vertical Tee, Up	
				● HYR = Horizontal Wye, Right	
				● HYL = Horizontal Wye, Left	
				● CSF = Cable Support Fitting	
				● LR = Left Reducer Fitting	
				● RR = Right Reducer Fitting	
				● SR = Straight Reducer Fitting	

See page APP-2 for 6" fittings with 9A-6006 and 9A-6007 splice plates.

For ventilated trough, solid trough, ventilated bottom or solid bottom, add VT, ST, 04 or SB as shown below: Available 6" thru 36"

Prefix  
**4AVT - 24 - 90HB24**  
Vented Trough

Prefix  
**4PST - 24 - 90HB24**  
Non-Ventilated Trough

For flat non-ventilated: Available 6" and Wider

Prefix  
**5PSB - 24 - 90HB24**  
Non-Ventilated

Note: Horizontal crosses and tees 30" or wider, with a radius of 36" or larger, will be of two-piece construction.

● Green = Fastest shipped items    ● Black = Normal lead-time items    ● Red = Normally long lead-time items

All dimensions in parentheses are millimeters unless otherwise specified.

# Series 2, 3, 4, & 5 - Fittings

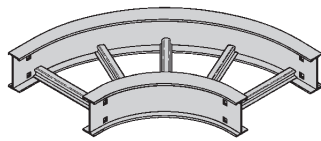

90° Horizontal Bend

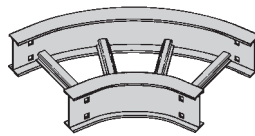

60° Horizontal Bend

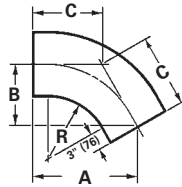
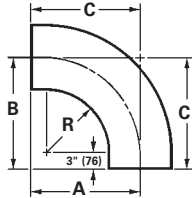

## Horizontal Bend 90° 60° (HB)

1 pair splice plates with hardware included.

**Bottoms manufactured:**

Ladder = 9" Rung Spacing

VT & 04 = 4" Rung Spacing

ST & SB = Flat sheet over 12" Rung Spacing

Bend Radius R	Tray Width	90° Horizontal Bend Dimensions				60° Horizontal Bend Dimensions			
		Catalog No.	A	B	C	Catalog No.	A	B	C
in. (mm)	in. (mm)		in. (mm)	in. (mm)	in. (mm)		in. (mm)	in. (mm)	in. (mm)
12 (305)	6 (152)	(Pre)-06-90HB12	18 (457)	18 (457)	18 (457)	(Pre)-06-60HB12	17 <sup>1</sup> / <sub>2</sub> (445)	10 <sup>1</sup> / <sub>8</sub> (257)	11 <sup>11</sup> / <sub>16</sub> (297)
	9 (228)	(Pre)-09-90HB12	19 <sup>1</sup> / <sub>2</sub> (495)	19 <sup>1</sup> / <sub>2</sub> (495)	19 <sup>1</sup> / <sub>2</sub> (495)	(Pre)-09-60HB12	18 <sup>13</sup> / <sub>16</sub> (478)	10 <sup>7</sup> / <sub>8</sub> (276)	12 <sup>1</sup> / <sub>2</sub> (318)
	12 (305)	(Pre)-12-90HB12	21 (533)	21 (533)	21 (533)	(Pre)-12-60HB12	20 <sup>1</sup> / <sub>16</sub> (510)	11 <sup>5</sup> / <sub>8</sub> (295)	13 <sup>3</sup> / <sub>8</sub> (340)
	18 (457)	(Pre)-18-90HB12	24 (610)	24 (610)	24 (610)	(Pre)-18-60HB12	22 <sup>11</sup> / <sub>16</sub> (576)	13 <sup>1</sup> / <sub>8</sub> (333)	15 <sup>1</sup> / <sub>8</sub> (384)
	24 (609)	(Pre)-24-90HB12	27 (686)	27 (686)	27 (686)	(Pre)-24-60HB12	25 <sup>5</sup> / <sub>16</sub> (643)	14 <sup>5</sup> / <sub>8</sub> (372)	16 <sup>7</sup> / <sub>8</sub> (429)
	30 (762)	(Pre)-30-90HB12	30 (762)	30 (762)	30 (762)	(Pre)-30-60HB12	27 <sup>7</sup> / <sub>8</sub> (708)	16 <sup>1</sup> / <sub>8</sub> (410)	18 <sup>9</sup> / <sub>16</sub> (472)
	36 (914)	(Pre)-36-90HB12	33 (838)	33 (838)	33 (838)	(Pre)-36-60HB12	30 <sup>1</sup> / <sub>2</sub> (775)	17 <sup>5</sup> / <sub>8</sub> (448)	20 <sup>5</sup> / <sub>16</sub> (516)
42 (1067)	(Pre)-42-90HB12	36 (914)	36 (914)	36 (914)	(Pre)-42-60HB12	33 <sup>1</sup> / <sub>16</sub> (840)	19 <sup>1</sup> / <sub>8</sub> (486)	22 <sup>1</sup> / <sub>16</sub> (560)	
24 (610)	6 (152)	(Pre)-06-90HB24	30 (762)	30 (762)	30 (762)	(Pre)-06-60HB24	27 <sup>7</sup> / <sub>8</sub> (708)	16 <sup>1</sup> / <sub>8</sub> (410)	18 <sup>9</sup> / <sub>16</sub> (472)
	9 (228)	(Pre)-09-90HB24	31 <sup>1</sup> / <sub>2</sub> (800)	31 <sup>1</sup> / <sub>2</sub> (800)	31 <sup>1</sup> / <sub>2</sub> (800)	(Pre)-09-60HB24	29 <sup>3</sup> / <sub>16</sub> (741)	16 <sup>7</sup> / <sub>8</sub> (429)	19 <sup>7</sup> / <sub>16</sub> (494)
	12 (305)	(Pre)-12-90HB24	33 (838)	33 (838)	33 (838)	(Pre)-12-60HB24	30 <sup>1</sup> / <sub>2</sub> (775)	17 <sup>5</sup> / <sub>8</sub> (448)	20 <sup>5</sup> / <sub>16</sub> (516)
	18 (457)	(Pre)-18-90HB24	36 (914)	36 (914)	36 (914)	(Pre)-18-60HB24	33 <sup>1</sup> / <sub>16</sub> (708)	19 <sup>1</sup> / <sub>8</sub> (486)	22 <sup>1</sup> / <sub>16</sub> (560)
	24 (609)	(Pre)-24-90HB24	39 (991)	39 (991)	39 (991)	(Pre)-24-60HB24	35 <sup>11</sup> / <sub>16</sub> (907)	20 <sup>5</sup> / <sub>8</sub> (524)	23 <sup>13</sup> / <sub>16</sub> (605)
	30 (762)	(Pre)-30-90HB24	42 (1067)	42 (1067)	42 (1067)	(Pre)-30-60HB24	38 <sup>1</sup> / <sub>4</sub> (972)	22 <sup>1</sup> / <sub>8</sub> (564)	25 <sup>1</sup> / <sub>2</sub> (648)
	36 (914)	(Pre)-36-90HB24	45 (1143)	45 (1143)	45 (1143)	(Pre)-36-60HB24	40 <sup>7</sup> / <sub>8</sub> (1038)	23 <sup>5</sup> / <sub>8</sub> (600)	27 <sup>1</sup> / <sub>4</sub> (692)
42 (1067)	(Pre)-42-90HB24	48 (1219)	48 (1219)	48 (1219)	(Pre)-42-60HB24	43 <sup>1</sup> / <sub>2</sub> (1105)	25 <sup>1</sup> / <sub>8</sub> (638)	29 (737)	
36 (914)	6 (152)	(Pre)-06-90HB36	42 (1067)	42 (1067)	42 (1067)	(Pre)-06-60HB36	38 <sup>1</sup> / <sub>4</sub> (971)	22 <sup>1</sup> / <sub>8</sub> (562)	25 <sup>1</sup> / <sub>2</sub> (648)
	9 (228)	(Pre)-09-90HB36	43 <sup>1</sup> / <sub>2</sub> (1105)	43 <sup>1</sup> / <sub>2</sub> (1105)	43 <sup>1</sup> / <sub>2</sub> (1105)	(Pre)-09-60HB36	39 <sup>9</sup> / <sub>16</sub> (1005)	22 <sup>7</sup> / <sub>8</sub> (581)	26 <sup>3</sup> / <sub>8</sub> (670)
	12 (305)	(Pre)-12-90HB36	45 (1143)	45 (1143)	45 (1143)	(Pre)-12-60HB36	40 <sup>7</sup> / <sub>8</sub> (1038)	23 <sup>5</sup> / <sub>8</sub> (600)	27 <sup>1</sup> / <sub>4</sub> (692)
	18 (457)	(Pre)-18-90HB36	48 (1219)	48 (1219)	48 (1219)	(Pre)-18-60HB36	43 <sup>1</sup> / <sub>2</sub> (1105)	25 <sup>1</sup> / <sub>8</sub> (638)	29 (737)
	24 (609)	(Pre)-24-90HB36	51 (1295)	51 (1295)	51 (1295)	(Pre)-24-60HB36	46 <sup>1</sup> / <sub>16</sub> (1170)	26 <sup>5</sup> / <sub>8</sub> (676)	30 <sup>11</sup> / <sub>16</sub> (780)
	30 (762)	(Pre)-30-90HB36	54 (1372)	54 (1372)	54 (1372)	(Pre)-30-60HB36	48 <sup>1</sup> / <sub>16</sub> (1237)	28 <sup>1</sup> / <sub>8</sub> (714)	32 <sup>7</sup> / <sub>16</sub> (824)
	36 (914)	(Pre)-36-90HB36	57 (1448)	57 (1448)	57 (1448)	(Pre)-36-60HB36	51 <sup>1</sup> / <sub>4</sub> (1302)	29 <sup>5</sup> / <sub>8</sub> (753)	34 <sup>3</sup> / <sub>16</sub> (869)
42 (1067)	(Pre)-42-90HB36	60 (1524)	60 (1524)	60 (1524)	(Pre)-42-60HB36	53 <sup>7</sup> / <sub>8</sub> (1368)	31 <sup>1</sup> / <sub>8</sub> (791)	35 <sup>15</sup> / <sub>16</sub> (913)	
48 (1220)	6 (152)	(Pre)-06-90HB48	54 (1372)	54 (1372)	54 (1372)	(Pre)-06-60HB48	48 <sup>1</sup> / <sub>16</sub> (1221)	28 <sup>1</sup> / <sub>8</sub> (715)	32 <sup>11</sup> / <sub>16</sub> (830)
	9 (228)	(Pre)-09-90HB48	55 <sup>1</sup> / <sub>2</sub> (1410)	55 <sup>1</sup> / <sub>2</sub> (1410)	55 <sup>1</sup> / <sub>2</sub> (1410)	(Pre)-09-60HB48	49 <sup>15</sup> / <sub>16</sub> (1268)	28 <sup>7</sup> / <sub>8</sub> (734)	33 <sup>5</sup> / <sub>16</sub> (846)
	12 (305)	(Pre)-12-90HB48	57 (1448)	57 (1448)	57 (1448)	(Pre)-12-60HB48	51 <sup>1</sup> / <sub>4</sub> (1302)	29 <sup>5</sup> / <sub>8</sub> (753)	34 <sup>3</sup> / <sub>16</sub> (869)
	18 (457)	(Pre)-18-90HB48	60 (1524)	60 (1524)	60 (1524)	(Pre)-18-60HB48	53 <sup>7</sup> / <sub>8</sub> (1368)	31 <sup>1</sup> / <sub>8</sub> (737)	35 <sup>15</sup> / <sub>16</sub> (913)
	24 (609)	(Pre)-24-90HB48	63 (1600)	63 (1600)	63 (1600)	(Pre)-24-60HB48	56 <sup>7</sup> / <sub>16</sub> (1434)	32 <sup>5</sup> / <sub>8</sub> (829)	37 <sup>5</sup> / <sub>8</sub> (956)
	30 (762)	(Pre)-30-90HB48	66 (1676)	66 (1676)	66 (1676)	(Pre)-30-60HB48	59 <sup>1</sup> / <sub>16</sub> (1500)	34 <sup>1</sup> / <sub>8</sub> (867)	39 <sup>3</sup> / <sub>8</sub> (1000)
	36 (914)	(Pre)-36-90HB48	69 (1753)	69 (1753)	69 (1753)	(Pre)-36-60HB48	61 <sup>11</sup> / <sub>16</sub> (1567)	35 <sup>5</sup> / <sub>8</sub> (905)	41 <sup>1</sup> / <sub>8</sub> (1045)
42 (1067)	(Pre)-42-90HB48	72 (1829)	72 (1829)	72 (1829)	(Pre)-42-60HB48	64 <sup>1</sup> / <sub>4</sub> (1632)	37 <sup>1</sup> / <sub>8</sub> (943)	42 <sup>13</sup> / <sub>16</sub> (1087)	

(Pre) See page L-3 for catalog number prefix.

Width dimensions are to inside wall. For aluminum fittings add 1.5 inches (38mm) for total outside width.

Manufacturing tolerances apply to all dimensions.

All dimensions in parentheses are millimeters unless otherwise specified.

# Series 2, 3, 4, & 5 - Fittings

## Horizontal Bend 45° 30° (HB)

1 pair splice plates with hardware included.

**Bottoms manufactured:**

**Ladder = 9" Rung Spacing**

**VT & 04 = 4" Rung Spacing**

**ST & SB = Flat sheet over 12" Rung Spacing**

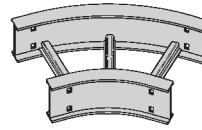

45° Horizontal Bend

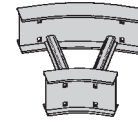

30° Horizontal Bend

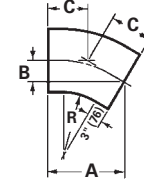
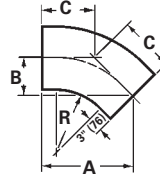

Bend Radius R	Tray Width	45° Horizontal Bend Dimensions				30° Horizontal Bend Dimensions			
		Catalog No.	A	B	C	Catalog No.	A	B	C
in. (mm)	in. (mm)		in. (mm)	in. (mm)	in. (mm)		in. (mm)	in. (mm)	in. (mm)
12 (305)	6 (152)	<b>(Pre)-06-45HB12</b>	15 <sup>3</sup> / <sub>4</sub> (400)	6 <sup>1</sup> / <sub>2</sub> (165)	9 <sup>3</sup> / <sub>16</sub> (233)	<b>(Pre)-06-30HB12</b>	13 <sup>1</sup> / <sub>8</sub> (333)	3 <sup>1</sup> / <sub>2</sub> (89)	7 (179)
	9 (228)	<b>(Pre)-09-45HB12</b>	16 <sup>13</sup> / <sub>16</sub> (427)	6 <sup>15</sup> / <sub>16</sub> (176)	9 <sup>13</sup> / <sub>16</sub> (249)	<b>(Pre)-09-30HB12</b>	13 <sup>7</sup> / <sub>8</sub> (352)	3 <sup>11</sup> / <sub>16</sub> (94)	7 <sup>7</sup> / <sub>16</sub> (189)
	12 (305)	<b>(Pre)-12-45HB12</b>	17 <sup>7</sup> / <sub>8</sub> (454)	7 <sup>3</sup> / <sub>8</sub> (187)	10 <sup>7</sup> / <sub>16</sub> (265)	<b>(Pre)-12-30HB12</b>	14 <sup>5</sup> / <sub>8</sub> (372)	3 <sup>15</sup> / <sub>16</sub> (100)	7 <sup>13</sup> / <sub>16</sub> (198)
	18 (457)	<b>(Pre)-18-45HB12</b>	20 (508)	8 <sup>1</sup> / <sub>4</sub> (210)	11 <sup>11</sup> / <sub>16</sub> (297)	<b>(Pre)-18-30HB12</b>	16 <sup>1</sup> / <sub>8</sub> (410)	4 <sup>5</sup> / <sub>16</sub> (135)	8 <sup>5</sup> / <sub>8</sub> (219)
	24 (609)	<b>(Pre)-24-45HB12</b>	22 <sup>1</sup> / <sub>16</sub> (560)	9 <sup>1</sup> / <sub>8</sub> (232)	12 <sup>15</sup> / <sub>16</sub> (329)	<b>(Pre)-24-30HB12</b>	17 <sup>5</sup> / <sub>8</sub> (448)	4 <sup>11</sup> / <sub>16</sub> (119)	9 <sup>7</sup> / <sub>16</sub> (240)
	30 (762)	<b>(Pre)-30-45HB12</b>	24 <sup>3</sup> / <sub>16</sub> (614)	10 (254)	14 <sup>3</sup> / <sub>16</sub> (360)	<b>(Pre)-30-30HB12</b>	19 <sup>1</sup> / <sub>8</sub> (486)	5 <sup>1</sup> / <sub>8</sub> (130)	10 <sup>1</sup> / <sub>4</sub> (260)
	36 (914)	<b>(Pre)-36-45HB12</b>	26 <sup>5</sup> / <sub>16</sub> (668)	10 <sup>15</sup> / <sub>16</sub> (278)	15 <sup>7</sup> / <sub>16</sub> (392)	<b>(Pre)-36-30HB12</b>	20 <sup>5</sup> / <sub>8</sub> (524)	5 <sup>1</sup> / <sub>2</sub> (140)	11 <sup>1</sup> / <sub>16</sub> (281)
	42 (1067)	<b>(Pre)-42-45HB12</b>	28 <sup>7</sup> / <sub>16</sub> (722)	11 <sup>13</sup> / <sub>16</sub> (300)	16 <sup>11</sup> / <sub>16</sub> (424)	<b>(Pre)-42-30HB12</b>	22 <sup>1</sup> / <sub>8</sub> (562)	5 <sup>15</sup> / <sub>16</sub> (151)	11 <sup>13</sup> / <sub>16</sub> (300)
24 (610)	6 (152)	<b>(Pre)-06-45HB24</b>	24 <sup>3</sup> / <sub>16</sub> (614)	10 (254)	14 <sup>3</sup> / <sub>16</sub> (360)	<b>(Pre)-06-30HB24</b>	19 <sup>1</sup> / <sub>8</sub> (486)	5 <sup>1</sup> / <sub>8</sub> (130)	10 <sup>1</sup> / <sub>4</sub> (260)
	9 (228)	<b>(Pre)-09-45HB24</b>	25 <sup>1</sup> / <sub>4</sub> (641)	10 <sup>1</sup> / <sub>2</sub> (267)	14 <sup>13</sup> / <sub>16</sub> (376)	<b>(Pre)-09-30HB24</b>	19 <sup>7</sup> / <sub>8</sub> (505)	5 <sup>5</sup> / <sub>16</sub> (135)	10 <sup>5</sup> / <sub>8</sub> (270)
	12 (305)	<b>(Pre)-12-45HB24</b>	26 <sup>5</sup> / <sub>16</sub> (668)	10 <sup>15</sup> / <sub>16</sub> (278)	15 <sup>7</sup> / <sub>16</sub> (392)	<b>(Pre)-12-30HB24</b>	20 <sup>5</sup> / <sub>8</sub> (524)	5 <sup>1</sup> / <sub>2</sub> (140)	11 <sup>1</sup> / <sub>16</sub> (281)
	18 (457)	<b>(Pre)-18-45HB24</b>	28 <sup>7</sup> / <sub>16</sub> (722)	11 <sup>13</sup> / <sub>16</sub> (300)	16 <sup>11</sup> / <sub>16</sub> (424)	<b>(Pre)-18-30HB24</b>	22 <sup>1</sup> / <sub>8</sub> (562)	5 <sup>15</sup> / <sub>16</sub> (151)	11 <sup>13</sup> / <sub>16</sub> (300)
	24 (609)	<b>(Pre)-24-45HB24</b>	30 <sup>9</sup> / <sub>16</sub> (766)	12 <sup>11</sup> / <sub>16</sub> (322)	17 <sup>15</sup> / <sub>16</sub> (456)	<b>(Pre)-24-30HB24</b>	23 <sup>5</sup> / <sub>8</sub> (600)	6 <sup>5</sup> / <sub>16</sub> (160)	12 <sup>5</sup> / <sub>8</sub> (321)
	30 (762)	<b>(Pre)-30-45HB24</b>	32 <sup>11</sup> / <sub>16</sub> (830)	13 <sup>9</sup> / <sub>16</sub> (344)	19 <sup>1</sup> / <sub>8</sub> (486)	<b>(Pre)-30-30HB24</b>	25 <sup>1</sup> / <sub>8</sub> (638)	6 <sup>3</sup> / <sub>4</sub> (172)	13 <sup>7</sup> / <sub>16</sub> (341)
	36 (914)	<b>(Pre)-36-45HB24</b>	34 <sup>13</sup> / <sub>16</sub> (884)	14 <sup>7</sup> / <sub>16</sub> (367)	20 <sup>3</sup> / <sub>8</sub> (518)	<b>(Pre)-36-30HB24</b>	26 <sup>5</sup> / <sub>8</sub> (676)	7 <sup>1</sup> / <sub>8</sub> (181)	14 <sup>1</sup> / <sub>4</sub> (362)
	42 (1067)	<b>(Pre)-42-45HB24</b>	36 <sup>15</sup> / <sub>16</sub> (938)	15 <sup>5</sup> / <sub>16</sub> (389)	21 <sup>5</sup> / <sub>8</sub> (549)	<b>(Pre)-42-30HB24</b>	28 <sup>1</sup> / <sub>8</sub> (715)	7 <sup>1</sup> / <sub>2</sub> (191)	15 <sup>1</sup> / <sub>16</sub> (383)
36 (914)	6 (152)	<b>(Pre)-06-45HB36</b>	32 <sup>11</sup> / <sub>16</sub> (830)	13 <sup>9</sup> / <sub>16</sub> (344)	19 <sup>1</sup> / <sub>8</sub> (486)	<b>(Pre)-06-30HB36</b>	25 <sup>1</sup> / <sub>8</sub> (638)	6 <sup>3</sup> / <sub>4</sub> (171)	13 <sup>7</sup> / <sub>16</sub> (341)
	9 (228)	<b>(Pre)-09-45HB36</b>	33 <sup>3</sup> / <sub>4</sub> (857)	14 (356)	19 <sup>3</sup> / <sub>4</sub> (502)	<b>(Pre)-09-30HB36</b>	25 <sup>7</sup> / <sub>8</sub> (657)	6 <sup>15</sup> / <sub>16</sub> (176)	13 <sup>7</sup> / <sub>8</sub> (352)
	12 (305)	<b>(Pre)-12-45HB36</b>	34 <sup>13</sup> / <sub>16</sub> (884)	14 <sup>7</sup> / <sub>16</sub> (367)	20 <sup>3</sup> / <sub>8</sub> (518)	<b>(Pre)-12-30HB36</b>	26 <sup>5</sup> / <sub>8</sub> (676)	7 <sup>1</sup> / <sub>8</sub> (181)	14 <sup>1</sup> / <sub>4</sub> (362)
	18 (457)	<b>(Pre)-18-45HB36</b>	36 <sup>15</sup> / <sub>16</sub> (938)	15 <sup>5</sup> / <sub>16</sub> (389)	21 <sup>5</sup> / <sub>8</sub> (549)	<b>(Pre)-18-30HB36</b>	28 <sup>1</sup> / <sub>8</sub> (715)	7 <sup>1</sup> / <sub>2</sub> (191)	15 <sup>1</sup> / <sub>16</sub> (383)
	24 (609)	<b>(Pre)-24-45HB36</b>	39 <sup>1</sup> / <sub>16</sub> (992)	16 <sup>3</sup> / <sub>16</sub> (411)	22 <sup>7</sup> / <sub>8</sub> (581)	<b>(Pre)-24-30HB36</b>	29 <sup>5</sup> / <sub>8</sub> (753)	7 <sup>15</sup> / <sub>16</sub> (202)	15 <sup>7</sup> / <sub>8</sub> (403)
	30 (762)	<b>(Pre)-30-45HB36</b>	41 <sup>3</sup> / <sub>16</sub> (1046)	17 <sup>1</sup> / <sub>16</sub> (433)	24 <sup>1</sup> / <sub>8</sub> (613)	<b>(Pre)-30-30HB36</b>	31 <sup>1</sup> / <sub>8</sub> (790)	8 <sup>5</sup> / <sub>16</sub> (211)	16 <sup>11</sup> / <sub>16</sub> (424)
	36 (914)	<b>(Pre)-36-45HB36</b>	43 <sup>5</sup> / <sub>16</sub> (1100)	17 <sup>15</sup> / <sub>16</sub> (456)	25 <sup>3</sup> / <sub>8</sub> (645)	<b>(Pre)-36-30HB36</b>	32 <sup>5</sup> / <sub>8</sub> (829)	8 <sup>3</sup> / <sub>4</sub> (222)	17 <sup>1</sup> / <sub>2</sub> (445)
	42 (1067)	<b>(Pre)-42-45HB36</b>	45 <sup>7</sup> / <sub>16</sub> (1154)	18 <sup>13</sup> / <sub>16</sub> (478)	26 <sup>5</sup> / <sub>8</sub> (676)	<b>(Pre)-42-30HB36</b>	34 <sup>1</sup> / <sub>8</sub> (867)	9 <sup>1</sup> / <sub>8</sub> (232)	18 <sup>1</sup> / <sub>4</sub> (464)
48 (1220)	6 (152)	<b>(Pre)-06-45HB48</b>	41 <sup>3</sup> / <sub>16</sub> (1046)	17 <sup>1</sup> / <sub>16</sub> (433)	24 <sup>1</sup> / <sub>8</sub> (613)	<b>(Pre)-06-30HB48</b>	31 <sup>1</sup> / <sub>8</sub> (791)	8 <sup>5</sup> / <sub>16</sub> (211)	16 <sup>11</sup> / <sub>16</sub> (424)
	9 (228)	<b>(Pre)-09-45HB48</b>	42 <sup>1</sup> / <sub>4</sub> (1073)	17 <sup>1</sup> / <sub>2</sub> (445)	24 <sup>3</sup> / <sub>4</sub> (629)	<b>(Pre)-09-30HB48</b>	31 <sup>7</sup> / <sub>8</sub> (810)	8 <sup>9</sup> / <sub>16</sub> (218)	17 <sup>1</sup> / <sub>16</sub> (433)
	12 (305)	<b>(Pre)-12-45HB48</b>	43 <sup>5</sup> / <sub>16</sub> (1100)	17 <sup>15</sup> / <sub>16</sub> (456)	25 <sup>3</sup> / <sub>8</sub> (645)	<b>(Pre)-12-30HB48</b>	32 <sup>5</sup> / <sub>8</sub> (829)	8 <sup>3</sup> / <sub>4</sub> (222)	17 <sup>1</sup> / <sub>2</sub> (445)
	18 (457)	<b>(Pre)-18-45HB48</b>	45 <sup>7</sup> / <sub>16</sub> (1154)	18 <sup>13</sup> / <sub>16</sub> (487)	26 <sup>5</sup> / <sub>8</sub> (676)	<b>(Pre)-18-30HB48</b>	34 <sup>1</sup> / <sub>8</sub> (867)	9 <sup>1</sup> / <sub>8</sub> (232)	18 <sup>1</sup> / <sub>4</sub> (464)
	24 (609)	<b>(Pre)-24-45HB48</b>	47 <sup>9</sup> / <sub>16</sub> (1208)	19 <sup>11</sup> / <sub>16</sub> (500)	27 <sup>7</sup> / <sub>8</sub> (708)	<b>(Pre)-24-30HB48</b>	35 <sup>5</sup> / <sub>8</sub> (905)	9 <sup>9</sup> / <sub>16</sub> (243)	19 <sup>1</sup> / <sub>16</sub> (484)
	30 (762)	<b>(Pre)-30-45HB48</b>	49 <sup>11</sup> / <sub>16</sub> (1262)	20 <sup>9</sup> / <sub>16</sub> (522)	29 <sup>1</sup> / <sub>8</sub> (740)	<b>(Pre)-30-30HB48</b>	37 <sup>1</sup> / <sub>8</sub> (943)	9 <sup>15</sup> / <sub>16</sub> (252)	19 <sup>7</sup> / <sub>8</sub> (505)
	36 (914)	<b>(Pre)-36-45HB48</b>	51 <sup>13</sup> / <sub>16</sub> (1316)	21 <sup>7</sup> / <sub>16</sub> (545)	30 <sup>5</sup> / <sub>16</sub> (770)	<b>(Pre)-36-30HB48</b>	38 <sup>5</sup> / <sub>8</sub> (981)	10 <sup>5</sup> / <sub>16</sub> (262)	20 <sup>11</sup> / <sub>16</sub> (525)
	42 (1067)	<b>(Pre)-42-45HB48</b>	54 <sup>15</sup> / <sub>16</sub> (1395)	22 <sup>5</sup> / <sub>16</sub> (567)	31 <sup>9</sup> / <sub>16</sub> (802)	<b>(Pre)-42-30HB48</b>	40 <sup>1</sup> / <sub>8</sub> (1019)	10 <sup>3</sup> / <sub>4</sub> (273)	21 <sup>1</sup> / <sub>2</sub> (546)

**(Pre) See page L-3 for catalog number prefix.**

Width dimensions are to inside wall. For aluminum fittings add 1.5 inches (38mm) for total outside width.

Manufacturing tolerances apply to all dimensions.

All dimensions in parentheses are millimeters unless otherwise specified.

## Horizontal Tee (HT)

2 pair splice plates with hardware included.

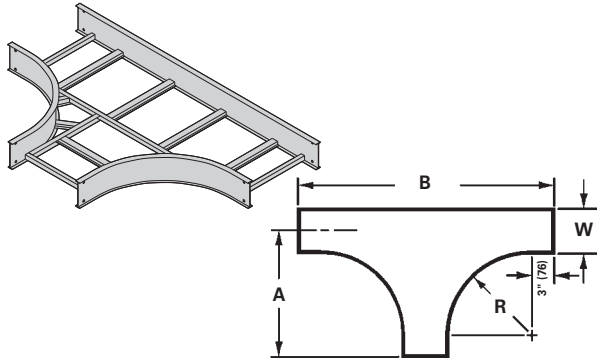

## Horizontal Cross (HX)

3 pair splice plates with hardware included.

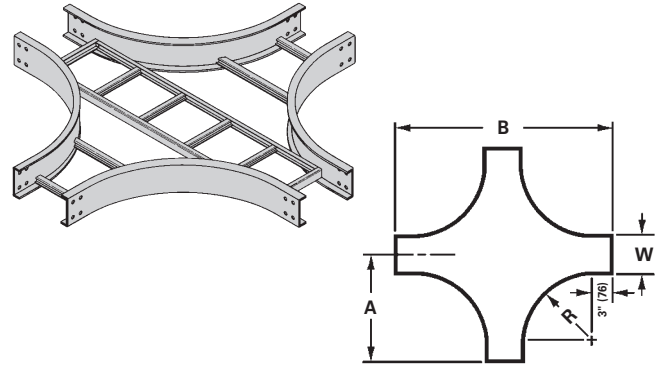

Bend Radius R	Tray Width	Horizontal Tee			Horizontal Cross		
		Catalog Number	Dimensions		Catalog Number	Dimensions	
			A	B		A	B
in. (mm)	in. (mm)	in. (mm)	in. (mm)	in. (mm)	in. (mm)	in. (mm)	
12 (305)	6 (152)	(Prefix)-06-HT12	18 (457)	36 (914)	(Prefix)-06-HX12	18 (457)	36 (914)
	9 (229)	(Prefix)-09-HT12	19 1/2 (496)	39 (991)	(Prefix)-09-HX12	19 1/2 (496)	39 (991)
	12 (305)	(Prefix)-12-HT12	21 (533)	42 (1067)	(Prefix)-12-HX12	21 (533)	42 (1067)
	18 (457)	(Prefix)-18-HT12	24 (609)	48 (1219)	(Prefix)-18-HX12	24 (609)	48 (1219)
	24 (609)	(Prefix)-24-HT12	27 (686)	54 (1372)	(Prefix)-24-HX12	27 (686)	54 (1372)
	30 (762)	(Prefix)-30-HT12	30 (762)	60 (1524)	(Prefix)-30-HX12	30 (762)	60 (1524)
	36 (914)	(Prefix)-36-HT12	33 (838)	66 (1676)	(Prefix)-36-HX12	33 (838)	66 (1676)
42 (1067)	(Prefix)-42-HT12	36 (914)	72 (1829)	(Prefix)-42-HX12	36 (914)	72 (1829)	
24 (610)	6 (152)	(Prefix)-06-HT24	30 (762)	60 (1524)	(Prefix)-06-HX24	30 (762)	60 (1524)
	9 (229)	(Prefix)-09-HT24	31 1/2 (800)	63 (1600)	(Prefix)-09-HX24	31 1/2 (800)	63 (1600)
	12 (305)	(Prefix)-12-HT24	33 (838)	66 (1676)	(Prefix)-12-HX24	33 (838)	66 (1676)
	18 (457)	(Prefix)-18-HT24	36 (914)	72 (1829)	(Prefix)-18-HX24	36 (914)	72 (1829)
	24 (609)	(Prefix)-24-HT24	39 (991)	78 (1982)	(Prefix)-24-HX24	39 (991)	78 (1982)
	30 (762)	(Prefix)-30-HT24	42 (1067)	84 (2134)	(Prefix)-30-HX24	42 (1067)	84 (2134)
	36 (914)	(Prefix)-36-HT24	45 (1143)	90 (2286)	(Prefix)-36-HX24	45 (1143)	90 (2286)
42 (1067)	(Prefix)-42-HT24	48 (1219)	96 (2438)	(Prefix)-42-HX24	48 (1219)	96 (2438)	
36 (914)	6 (152)	(Prefix)-06-HT36	42 (1067)	84 (2134)	(Prefix)-06-HX36	42 (1067)	84 (2134)
	9 (229)	(Prefix)-09-HT36	43 1/2 (1105)	87 (2210)	(Prefix)-09-HX36	43 1/2 (1105)	87 (2210)
	12 (305)	(Prefix)-12-HT36	45 (1143)	90 (2286)	(Prefix)-12-HX36	45 (1143)	90 (2286)
	18 (457)	(Prefix)-18-HT36	48 (1219)	96 (2438)	(Prefix)-18-HX36	48 (1219)	96 (2438)
	24 (609)	(Prefix)-24-HT36	51 (1295)	102 (2590)	(Prefix)-24-HX36	51 (1295)	102 (2590)
	30 (762)	(Prefix)-30-HT36	54 (1372)	108 (2744)	(Prefix)-30-HX36	54 (1372)	108 (2744)
	36 (914)	(Prefix)-36-HT36	57 (1448)	114 (2896)	(Prefix)-36-HX36	57 (1448)	114 (2896)
42 (1067)	(Prefix)-42-HT36	60 (1524)	120 (3048)	(Prefix)-42-HX36	60 (1524)	120 (3048)	
48 (1220)	6 (152)	(Prefix)-06-HT48	54 (1372)	108 (2744)	(Prefix)-06-HX48	54 (1372)	108 (2744)
	9 (229)	(Prefix)-09-HT48	55 1/2 (1410)	111 (2820)	(Prefix)-09-HX48	55 1/2 (1410)	111 (2820)
	12 (305)	(Prefix)-12-HT48	57 (1448)	114 (2896)	(Prefix)-12-HX48	57 (1448)	114 (2896)
	18 (457)	(Prefix)-18-HT48	60 (1524)	120 (3048)	(Prefix)-18-HX48	60 (1524)	120 (3048)
	24 (609)	(Prefix)-24-HT48	63 (1600)	126 (3200)	(Prefix)-24-HX48	63 (1600)	126 (3200)
	30 (762)	(Prefix)-30-HT48	66 (1676)	132 (3353)	(Prefix)-30-HX48	66 (1676)	132 (3353)
	36 (914)	(Prefix)-36-HT48	69 (1753)	138 (3535)	(Prefix)-36-HX48	69 (1753)	138 (3535)
42 (1067)	(Prefix)-42-HT48	72 (1829)	144 (3658)	(Prefix)-42-HX48	72 (1829)	144 (3658)	

**(Prefix)** See page L-3 for catalog number prefix.

Width dimensions are to inside wall. For aluminum fittings add 1.5 inches (38mm) for total outside width. Manufacturing tolerances apply to all dimensions.

All dimensions in parentheses are millimeters unless otherwise specified.

# Series 2, 3, 4, & 5 - Fittings

## Reducers (LR, SR, RR)

1 pair splice plates with hardware included.

### Reducer Part Numbering

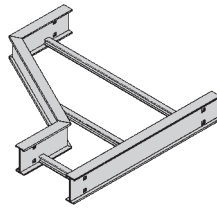
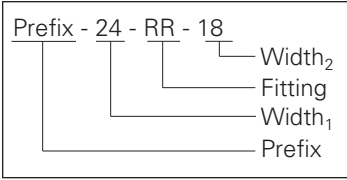

Left Reducer - LR

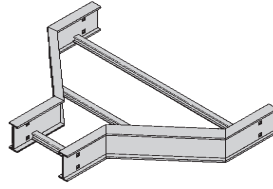

Straight Reducer SR

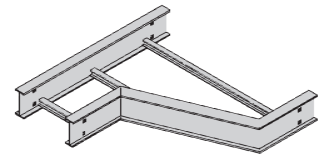

Right Reducer -RR

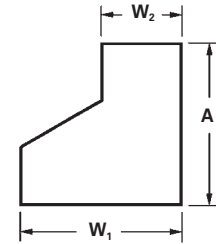
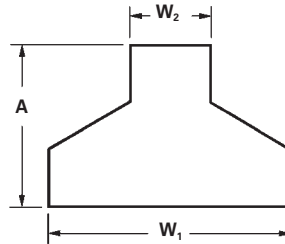
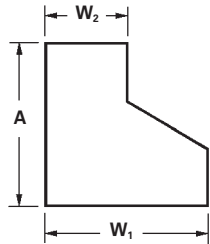

Tray Width		Left Hand Reducer		Straight Reducer		Right Hand Reducer	
W1	W2	Catalog No.	A	Catalog No.	A	Catalog No.	A
in. (mm)	in. (mm)		in. (mm)		in. (mm)		in. (mm)
9 (228)	6 (152)	(Prefix)-09-LR06	9 <sup>3</sup> / <sub>4</sub> (248)	(Prefix)-09-SR06	8 <sup>15</sup> / <sub>16</sub> (227)	(Prefix)-09-RR06	9 <sup>3</sup> / <sub>4</sub> (248)
12 (305)	6 (152)	(Prefix)-12-LR06	11 <sup>1</sup> / <sub>2</sub> (292)	(Prefix)-12-SR06	9 <sup>3</sup> / <sub>4</sub> (248)	(Prefix)-12-RR06	11 <sup>1</sup> / <sub>2</sub> (292)
	9 (228)	(Prefix)-12-LR09	9 <sup>3</sup> / <sub>4</sub> (248)	(Prefix)-12-SR09	8 <sup>15</sup> / <sub>16</sub> (227)	(Prefix)-12-RR09	9 <sup>3</sup> / <sub>4</sub> (248)
18 (457)	6 (152)	(Prefix)-18-LR06	14 <sup>15</sup> / <sub>16</sub> (379)	(Prefix)-18-SR06	11 <sup>1</sup> / <sub>2</sub> (292)	(Prefix)-18-RR06	14 <sup>15</sup> / <sub>16</sub> (379)
	9 (228)	(Prefix)-18-LR09	13 <sup>3</sup> / <sub>16</sub> (340)	(Prefix)-18-SR09	10 <sup>5</sup> / <sub>8</sub> (270)	(Prefix)-18-RR09	13 <sup>3</sup> / <sub>16</sub> (340)
	12 (305)	(Prefix)-18-LR12	11 <sup>1</sup> / <sub>2</sub> (292)	(Prefix)-18-SR12	9 <sup>3</sup> / <sub>4</sub> (248)	(Prefix)-18-RR12	11 <sup>1</sup> / <sub>2</sub> (292)
24 (609)	6 (152)	(Prefix)-24-LR06	18 <sup>3</sup> / <sub>8</sub> (467)	(Prefix)-24-SR06	13 <sup>1</sup> / <sub>4</sub> (336)	(Prefix)-24-RR06	18 <sup>3</sup> / <sub>8</sub> (467)
	9 (228)	(Prefix)-24-LR09	16 <sup>11</sup> / <sub>16</sub> (424)	(Prefix)-24-SR09	12 <sup>3</sup> / <sub>8</sub> (314)	(Prefix)-24-RR09	16 <sup>11</sup> / <sub>16</sub> (424)
	12 (305)	(Prefix)-24-LR12	14 <sup>15</sup> / <sub>16</sub> (379)	(Prefix)-24-SR12	11 <sup>1</sup> / <sub>2</sub> (292)	(Prefix)-24-RR12	14 <sup>15</sup> / <sub>16</sub> (379)
	18 (457)	(Prefix)-24-LR18	11 <sup>1</sup> / <sub>2</sub> (292)	(Prefix)-24-SR18	9 <sup>3</sup> / <sub>4</sub> (248)	(Prefix)-24-RR18	11 <sup>1</sup> / <sub>2</sub> (292)
30 (762)	6 (152)	(Prefix)-30-LR06	21 <sup>7</sup> / <sub>8</sub> (555)	(Prefix)-30-SR06	14 <sup>15</sup> / <sub>16</sub> (379)	(Prefix)-30-RR06	21 <sup>7</sup> / <sub>8</sub> (555)
	9 (228)	(Prefix)-30-LR09	20 <sup>1</sup> / <sub>8</sub> (511)	(Prefix)-30-SR09	14 <sup>1</sup> / <sub>8</sub> (359)	(Prefix)-30-RR09	20 <sup>1</sup> / <sub>8</sub> (511)
	12 (305)	(Prefix)-30-LR12	18 <sup>3</sup> / <sub>8</sub> (467)	(Prefix)-30-SR12	13 <sup>1</sup> / <sub>4</sub> (336)	(Prefix)-30-RR12	18 <sup>3</sup> / <sub>8</sub> (467)
	18 (457)	(Prefix)-30-LR18	14 <sup>15</sup> / <sub>16</sub> (379)	(Prefix)-30-SR18	11 <sup>1</sup> / <sub>2</sub> (292)	(Prefix)-30-RR18	14 <sup>15</sup> / <sub>16</sub> (379)
	24 (609)	(Prefix)-30-LR24	11 <sup>1</sup> / <sub>2</sub> (292)	(Prefix)-30-SR24	9 <sup>3</sup> / <sub>4</sub> (248)	(Prefix)-30-RR24	11 <sup>1</sup> / <sub>2</sub> (292)
36 (914)	6 (152)	(Prefix)-36-LR06	25 <sup>5</sup> / <sub>16</sub> (643)	(Prefix)-36-SR06	16 <sup>11</sup> / <sub>16</sub> (424)	(Prefix)-36-RR06	25 <sup>5</sup> / <sub>16</sub> (643)
	9 (228)	(Prefix)-36-LR09	23 <sup>9</sup> / <sub>16</sub> (598)	(Prefix)-36-SR09	15 <sup>13</sup> / <sub>16</sub> (402)	(Prefix)-36-RR09	23 <sup>9</sup> / <sub>16</sub> (598)
	12 (305)	(Prefix)-36-LR12	21 <sup>7</sup> / <sub>8</sub> (555)	(Prefix)-36-SR12	14 <sup>15</sup> / <sub>16</sub> (379)	(Prefix)-36-RR12	21 <sup>7</sup> / <sub>8</sub> (555)
	18 (457)	(Prefix)-36-LR18	18 <sup>3</sup> / <sub>8</sub> (467)	(Prefix)-36-SR18	13 <sup>1</sup> / <sub>4</sub> (336)	(Prefix)-36-RR18	18 <sup>3</sup> / <sub>8</sub> (467)
	24 (609)	(Prefix)-36-LR24	14 <sup>15</sup> / <sub>16</sub> (379)	(Prefix)-36-SR24	11 <sup>1</sup> / <sub>2</sub> (292)	(Prefix)-36-RR24	14 <sup>15</sup> / <sub>16</sub> (379)
	30 (762)	(Prefix)-36-LR30	11 <sup>1</sup> / <sub>2</sub> (292)	(Prefix)-36-SR30	9 <sup>3</sup> / <sub>4</sub> (248)	(Prefix)-36-RR30	11 <sup>1</sup> / <sub>2</sub> (292)
42 (1067)	6 (152)	(Prefix)-42-LR06	28 <sup>3</sup> / <sub>4</sub> (730)	(Prefix)-42-SR06	18 <sup>3</sup> / <sub>8</sub> (467)	(Prefix)-42-RR06	28 <sup>3</sup> / <sub>4</sub> (730)
	9 (228)	(Prefix)-42-LR09	27 <sup>1</sup> / <sub>16</sub> (687)	(Prefix)-42-SR09	17 <sup>9</sup> / <sub>16</sub> (446)	(Prefix)-42-RR09	27 <sup>1</sup> / <sub>16</sub> (687)
	12 (305)	(Prefix)-42-LR12	25 <sup>5</sup> / <sub>16</sub> (643)	(Prefix)-42-SR12	16 <sup>11</sup> / <sub>16</sub> (424)	(Prefix)-42-RR12	25 <sup>5</sup> / <sub>16</sub> (643)
	18 (457)	(Prefix)-42-LR18	21 <sup>7</sup> / <sub>8</sub> (555)	(Prefix)-42-SR18	14 <sup>15</sup> / <sub>16</sub> (379)	(Prefix)-42-RR18	21 <sup>7</sup> / <sub>8</sub> (555)
	24 (609)	(Prefix)-42-LR24	18 <sup>3</sup> / <sub>8</sub> (467)	(Prefix)-42-SR24	13 <sup>1</sup> / <sub>4</sub> (336)	(Prefix)-42-RR24	18 <sup>3</sup> / <sub>8</sub> (467)
	30 (762)	(Prefix)-42-LR30	14 <sup>15</sup> / <sub>16</sub> (379)	(Prefix)-42-SR30	11 <sup>1</sup> / <sub>2</sub> (292)	(Prefix)-42-RR30	14 <sup>15</sup> / <sub>16</sub> (379)
	36 (914)	(Prefix)-42-LR36	11 <sup>1</sup> / <sub>2</sub> (292)	(Prefix)-42-SR36	9 <sup>3</sup> / <sub>4</sub> (248)	(Prefix)-42-RR36	11 <sup>1</sup> / <sub>2</sub> (292)

(Prefix) See page L-3 for catalog number prefix.

Width dimensions are to inside wall. For aluminum fittings add 1.5 inches (38mm) for total outside width. Manufacturing tolerances apply to all dimensions.

All dimensions in parentheses are millimeters unless otherwise specified.

## Horizontal Reducing Tee (HT)

2 pair splice plates with hardware included.

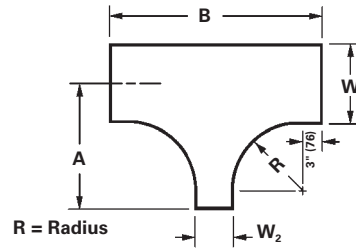
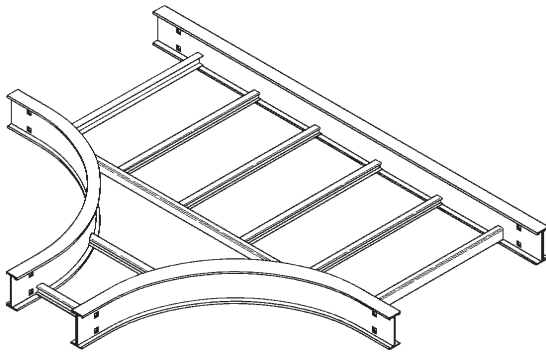

Prefix - 36 - 18 HT 24

Radius  
Fitting  
Width W<sub>2</sub>  
Width W<sub>1</sub>

To complete catalog number, insert fitting prefix.

Tray Width		* Insert Radius (12", 24", 36", or 48") Catalog No.	12" Radius		24" Radius		36" Radius		48" Radius	
W1	W2		A	B	A	B	A	B	A	B
in.	mm		in.	mm	in.	mm	in.	mm	in.	mm
9 (228)	6 (152)	(Prefix)-09-06-HT*	19 1/2 (496)	36 (914)	31 1/2 (800)	60 (1524)	43 (1092)	84 (2134)	55 1/2 (1410)	108 (2743)
12 (305)	6 (152)	(Prefix)-12-06-HT*	21 (533)	36 (914)	33 (838)	60 (1524)	45 (1143)	84 (2134)	57 (1448)	108 (2743)
	9 (228)	(Prefix)-12-09-HT*	21 (533)	39 (991)	33 (838)	63 (1600)	45 (1143)	87 (2210)	57 (1448)	111 (2819)
18 (457)	6 (152)	(Prefix)-18-06-HT*	24 (609)	36 (914)	36 (914)	60 (1524)	48 (1143)	84 (2134)	60 (1524)	108 (2743)
	9 (228)	(Prefix)-18-09-HT*	24 (609)	39 (991)	36 (914)	63 (1600)	48 (1219)	87 (2210)	60 (1524)	111 (2819)
	12 (305)	(Prefix)-18-12-HT*	24 (609)	42 (1067)	36 (914)	66 (1676)	48 (1219)	90 (2286)	60 (1524)	114 (2895)
24 (609)	6 (152)	(Prefix)-24-06-HT*	27 (686)	36 (914)	39 (991)	60 (1524)	51 (1295)	84 (2134)	63 (1600)	108 (2743)
	9 (228)	(Prefix)-24-09-HT*	27 (686)	39 (991)	39 (991)	63 (1600)	51 (1295)	87 (2210)	63 (1600)	111 (2819)
	12 (305)	(Prefix)-24-12-HT*	27 (686)	42 (1067)	39 (991)	66 (1676)	51 (1295)	90 (2286)	63 (1600)	114 (2895)
	18 (457)	(Prefix)-24-18-HT*	27 (686)	48 (1219)	39 (991)	72 (1829)	51 (1295)	96 (2438)	63 (1600)	120 (3048)
30 (762)	6 (152)	(Prefix)-30-06-HT*	30 (762)	36 (914)	42 (1067)	60 (1524)	54 (1372)	84 (2134)	66 (1676)	108 (2743)
	9 (228)	(Prefix)-30-09-HT*	30 (762)	39 (991)	42 (1067)	63 (1600)	54 (1372)	87 (2210)	66 (1676)	111 (2819)
	12 (305)	(Prefix)-30-12-HT*	30 (762)	42 (1067)	42 (1067)	66 (1676)	54 (1372)	90 (2286)	66 (1676)	114 (2895)
	18 (457)	(Prefix)-30-18-HT*	30 (762)	48 (1219)	42 (1067)	72 (1829)	54 (1372)	96 (2438)	66 (1676)	120 (3048)
	24 (609)	(Prefix)-30-24-HT*	30 (762)	54 (1372)	42 (1067)	78 (1981)	54 (1372)	102 (2591)	66 (1676)	126 (3200)
36 (914)	6 (152)	(Prefix)-30-06-HT*	33 (838)	36 (914)	45 (1143)	60 (1524)	57 (1448)	84 (2134)	69 (1753)	108 (2743)
	9 (228)	(Prefix)-36-09-HT*	33 (838)	39 (991)	45 (1143)	63 (1600)	57 (1448)	87 (2210)	69 (1753)	111 (2819)
	12 (305)	(Prefix)-36-12-HT*	33 (838)	42 (1067)	45 (1143)	66 (1676)	57 (1448)	90 (2286)	69 (1753)	114 (2895)
	18 (457)	(Prefix)-36-18-HT*	33 (838)	48 (1219)	45 (1143)	72 (1829)	57 (1448)	96 (2438)	69 (1753)	120 (3048)
	24 (609)	(Prefix)-36-24-HT*	33 (838)	54 (1372)	45 (1143)	78 (1981)	57 (1448)	102 (2591)	69 (1753)	126 (3200)
42 (1067)	30 (762)	(Prefix)-36-30-HT*	33 (838)	60 (1524)	45 (1143)	84 (2134)	57 (1448)	108 (2743)	69 (1753)	132 (3353)
	6 (152)	(Prefix)-42-06-HT*	36 (914)	36 (914)	48 (1219)	60 (1524)	60 (1524)	84 (2134)	72 (1829)	108 (2743)
	9 (228)	(Prefix)-42-09-HT*	36 (914)	39 (991)	48 (1219)	63 (1600)	60 (1524)	87 (2210)	72 (1829)	111 (2819)
	12 (305)	(Prefix)-42-12-HT*	36 (914)	42 (1067)	48 (1219)	66 (1676)	60 (1524)	90 (2286)	72 (1829)	114 (2895)
	18 (457)	(Prefix)-42-18-HT*	36 (914)	48 (1219)	48 (1219)	72 (1829)	60 (1524)	96 (2438)	72 (1829)	120 (3048)
	24 (609)	(Prefix)-42-24-HT*	36 (914)	54 (1372)	48 (1219)	78 (1981)	60 (1524)	102 (2591)	72 (1829)	126 (3200)
30 (762)	30 (762)	(Prefix)-42-30-HT*	36 (914)	60 (1524)	48 (1219)	84 (2134)	60 (1524)	108 (2743)	72 (1829)	132 (3353)
	36 (914)	(Prefix)-42-36-HT*	36 (914)	66 (1676)	48 (1219)	90 (2286)	60 (1524)	114 (2895)	72 (1829)	138 (3505)

(Prefix) See page L-3 for catalog number prefix.

Width dimensions are to inside wall. For aluminum fittings add 1.5 inches (38mm) for total outside width.

Manufacturing tolerances apply to all dimensions.

All dimensions in parentheses are millimeters unless otherwise specified.

# Series 2, 3, 4, & 5 - Fittings

## Horizontal Expanding Tee (HT)

2 pair splice plates with hardware included.

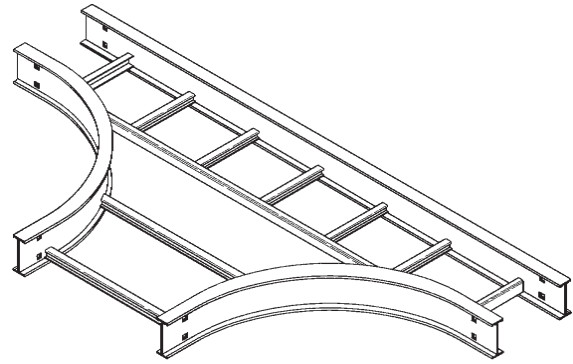
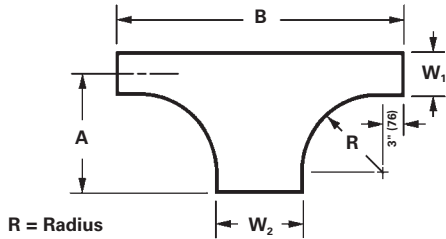

Prefix - 09 - 30 HT 12

- Radius
- Fitting
- Width W<sub>2</sub>
- Width W<sub>1</sub>

To complete catalog number, insert fitting prefix.

Series 2, 3, 4, & 5 Fittings

Tray Width		* Insert Radius (12", 24", 36", or 48") Catalog No.	12" Radius		24" Radius		36" Radius		48" Radius	
W1 in. mm	W2 in. mm		A in. mm	B in. mm	A in. mm	B in. mm	A in. mm	B in. mm	A in. mm	B in. mm
6 (152)	9 (228)	(Prefix)-06-09-HT*	18 (457)	39 (991)	30 (762)	63 (1600)	42 (1067)	87 (2210)	54 (1372)	111 (2819)
	12 (305)	(Prefix)-06-12-HT*	18 (457)	42 (1067)	30 (762)	66 (1676)	42 (1067)	90 (2286)	54 (1372)	114 (2895)
	18 (457)	(Prefix)-06-18-HT*	18 (457)	48 (1219)	30 (762)	72 (1829)	42 (1067)	96 (2438)	54 (1372)	120 (3048)
	24 (609)	(Prefix)-06-24-HT*	18 (457)	54 (1372)	30 (762)	78 (1981)	42 (1067)	102 (2591)	54 (1372)	126 (3200)
	30 (762)	(Prefix)-06-30-HT*	18 (457)	60 (1524)	30 (762)	84 (2134)	42 (1067)	108 (2743)	54 (1372)	132 (3353)
	36 (914)	(Prefix)-06-36-HT*	18 (457)	66 (1676)	30 (762)	90 (2286)	42 (1067)	114 (2895)	54 (1372)	138 (3503)
42 (1067)	(Prefix)-06-42-HT*	18 (457)	72 (1829)	30 (762)	96 (2438)	42 (1067)	120 (3048)	54 (1372)	144 (3658)	
9 (228)	12 (305)	(Prefix)-09-12-HT*	19 1/2 (496)	42 (1067)	31 1/2 (800)	66 (1676)	43 1/2 (1105)	90 (2286)	55 1/2 (1410)	114 (2895)
	18 (457)	(Prefix)-09-18-HT*	19 1/2 (496)	48 (1219)	31 1/2 (800)	72 (1829)	43 1/2 (1105)	96 (2438)	55 1/2 (1410)	120 (3048)
	24 (609)	(Prefix)-09-24-HT*	19 1/2 (496)	54 (1372)	31 1/2 (800)	78 (1981)	43 1/2 (1105)	102 (2591)	55 1/2 (1410)	126 (3200)
	30 (762)	(Prefix)-09-30-HT*	19 1/2 (496)	60 (1524)	31 1/2 (800)	84 (2134)	43 1/2 (1105)	108 (2743)	55 1/2 (1410)	132 (3353)
	36 (914)	(Prefix)-09-36-HT*	19 1/2 (496)	66 (1676)	31 1/2 (800)	90 (2286)	43 1/2 (1105)	114 (2895)	55 1/2 (1410)	138 (3503)
	42 (1067)	(Prefix)-09-42-HT*	19 1/2 (496)	72 (1829)	31 1/2 (800)	96 (2438)	43 1/2 (1105)	120 (3048)	55 1/2 (1410)	144 (3658)
12 (305)	18 (457)	(Prefix)-12-18-HT*	21 (533)	48 (1219)	33 (838)	72 (1829)	45 (1143)	96 (2438)	57 (1448)	120 (3048)
	24 (609)	(Prefix)-12-24-HT*	21 (533)	54 (1372)	33 (838)	78 (1981)	45 (1143)	102 (2591)	57 (1448)	126 (3200)
	30 (762)	(Prefix)-12-30-HT*	21 (533)	60 (1524)	33 (838)	84 (2134)	45 (1143)	108 (2743)	57 (1448)	132 (3353)
	36 (914)	(Prefix)-12-36-HT*	21 (533)	66 (1676)	33 (838)	90 (2286)	45 (1143)	114 (2895)	57 (1448)	138 (3503)
	42 (1067)	(Prefix)-12-42-HT*	21 (533)	72 (1829)	33 (838)	96 (2438)	45 (1143)	120 (3048)	57 (1448)	144 (3658)
18 (457)	24 (609)	(Prefix)-18-24-HT*	24 (609)	54 (1372)	36 (914)	78 (1981)	48 (1219)	102 (2591)	60 (1524)	126 (3200)
	30 (762)	(Prefix)-18-30-HT*	24 (609)	60 (1524)	36 (914)	84 (2134)	48 (1219)	108 (2743)	60 (1524)	132 (3353)
	36 (914)	(Prefix)-18-36-HT*	24 (609)	66 (1676)	36 (914)	90 (2286)	48 (1219)	114 (2895)	60 (1524)	138 (3503)
	42 (1067)	(Prefix)-18-42-HT*	24 (609)	72 (1829)	36 (914)	96 (2438)	48 (1219)	120 (3048)	60 (1524)	144 (3658)
24 (609)	30 (762)	(Prefix)-24-30-HT*	27 (686)	60 (1524)	39 (991)	84 (2134)	51 (1295)	108 (2743)	63 (1600)	132 (3353)
	36 (914)	(Prefix)-24-36-HT*	27 (686)	66 (1676)	39 (991)	90 (2286)	51 (1295)	114 (2895)	63 (1600)	138 (3503)
	42 (1067)	(Prefix)-24-42-HT*	27 (686)	72 (1829)	39 (991)	96 (2438)	51 (1295)	120 (3048)	63 (1600)	144 (3658)
30 (762)	36 (914)	(Prefix)-30-36-HT*	30 (762)	66 (1676)	42 (1067)	90 (2286)	54 (1372)	114 (2895)	66 (1676)	138 (3503)
	42 (1067)	(Prefix)-30-42-HT*	30 (762)	72 (1829)	42 (1067)	96 (2438)	54 (1372)	120 (3048)	66 (1676)	144 (3658)
36 (914)	42 (1067)	(Prefix)-36-42-HT*	33 (838)	72 (1829)	45 (1143)	96 (2438)	57 (1448)	120 (3048)	69 (1753)	144 (3658)

**(Prefix)** See page L-3 for catalog number prefix.

Width dimensions are to inside wall. For aluminum fittings add 1.5 inches (38mm) for total outside width.

Manufacturing tolerances apply to all dimensions.

All dimensions in parentheses are millimeters unless otherwise specified.

## Horizontal Expanding/Reducing Cross (HX)

3 pair splice plates with hardware included.

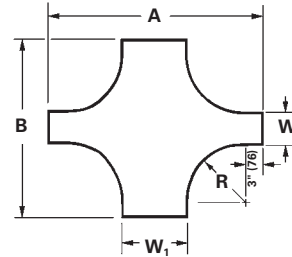
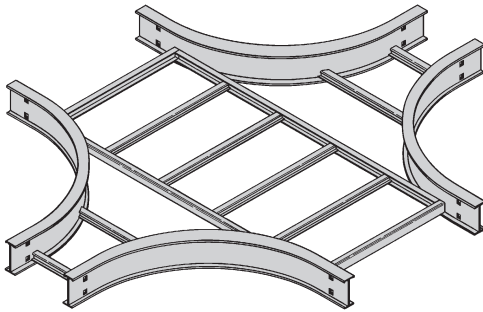

Prefix - 36 - 18 HX 24

Radius  
Fitting  
Width W<sub>2</sub>  
Width W<sub>1</sub>

To complete catalog number, insert fitting prefix.

Tray Width		* Insert Radius (12", 24", 36", or 48") Catalog No.	12" Radius		24" Radius		36" Radius		48" Radius			
W1	W2		A	B	A	B	A	B	A	B		
in.	mm		in.	mm	in.	mm	in.	mm	in.	mm	in.	mm
9	(228)	6 (152)	(Prefix)-09-06-HX*	39 (991)	36 (914)	63 1600	60 (1524)	87 (2210)	84 (2134)	111 2819	108 (2743)	
12	(305)	6 (152)	(Prefix)-12-06-HX*	42 (1067)	36 (914)	66 (1676)	60 (1524)	90 (2286)	84 (2134)	114 (2895)	108 (2743)	
		9 (228)	(Prefix)-12-09-HX*	42 (1067)	39 (991)	66 (1676)	63 (1600)	90 (2286)	87 (2210)	114 (2895)	111 (2819)	
18	(457)	6 (152)	(Prefix)-18-06-HX*	48 (1219)	36 (914)	72 (1829)	60 (1524)	96 (2438)	84 (2134)	120 (3048)	108 (2743)	
		9 (228)	(Prefix)-18-09-HX*	48 (1219)	39 (991)	72 (1829)	63 (1600)	96 (2438)	87 (2210)	120 (3048)	111 (2819)	
		12 (305)	(Prefix)-18-12-HX*	48 (1219)	42 (1067)	72 (1829)	66 (1676)	96 (2438)	90 (2286)	120 (3048)	114 (2895)	
24	(609)	6 (152)	(Prefix)-24-06-HX*	54 (1372)	36 (914)	78 (1981)	60 (1524)	102 (2591)	84 (2134)	126 (3200)	108 (2743)	
		9 (228)	(Prefix)-24-09-HX*	54 (1372)	39 (991)	78 (1981)	63 (1600)	102 (2591)	87 (2210)	126 (3200)	111 (2819)	
		12 (305)	(Prefix)-24-12-HX*	54 (1372)	42 (1067)	78 (1981)	66 (1676)	102 (2591)	90 (2286)	126 (3200)	114 (2895)	
		18 (457)	(Prefix)-24-18-HX*	54 (1372)	48 (1219)	78 (1981)	72 (1829)	102 (2591)	96 (2438)	126 (3200)	120 (3048)	
30	(762)	6 (152)	(Prefix)-30-06-HX*	60 (1524)	36 (914)	84 (2134)	60 (1524)	108 (2743)	84 (2134)	132 (3353)	108 (2743)	
		9 (228)	(Prefix)-30-09-HX*	60 (1524)	39 (991)	84 (2134)	63 (1600)	108 (2743)	87 (2210)	132 (3353)	111 (2819)	
		12 (305)	(Prefix)-30-12-HX*	60 (1524)	42 (1067)	84 (2134)	66 (1676)	108 (2743)	90 (2286)	132 (3353)	114 (2895)	
		18 (457)	(Prefix)-30-18-HX*	60 (1524)	48 (1219)	84 (2134)	72 (1829)	108 (2743)	96 (2438)	132 (3353)	120 (3048)	
		24 (609)	(Prefix)-30-24-HX*	60 (1524)	54 (1372)	84 (2134)	78 (1981)	108 (2743)	102 (2591)	132 (3353)	126 (3200)	
36	(914)	6 (152)	(Prefix)-30-06-HX*	66 (1676)	36 (914)	90 (2286)	60 (1524)	114 (2895)	84 (2134)	138 (3505)	108 (2743)	
		9 (228)	(Prefix)-36-09-HX*	66 (1676)	39 (991)	90 (2286)	63 (1600)	114 (2895)	87 (2210)	138 (3505)	111 (2819)	
		12 (305)	(Prefix)-36-12-HX*	66 (1676)	42 (1067)	90 (2286)	66 (1676)	114 (2895)	90 (2286)	138 (3505)	114 (2895)	
		18 (457)	(Prefix)-36-18-HX*	66 (1676)	48 (1219)	90 (2286)	72 (1829)	114 (2895)	96 (2438)	138 (3505)	120 (3048)	
		24 (609)	(Prefix)-36-24-HX*	66 (1676)	54 (1372)	90 (2286)	78 (1981)	114 (2895)	102 (2591)	138 (3505)	126 (3200)	
42	(1067)	30 (762)	(Prefix)-36-30-HX*	66 (1676)	60 (1524)	90 (2286)	84 (2134)	114 (2895)	108 (2743)	138 (3505)	132 (3353)	
		6 (152)	(Prefix)-42-06-HX*	72 (1829)	36 (914)	96 (2438)	60 (1524)	120 (3048)	84 (2134)	144 (3658)	108 (2743)	
		9 (228)	(Prefix)-42-09-HX*	72 (1829)	39 (991)	96 (2438)	63 (1600)	120 (3048)	87 (2210)	144 (3658)	111 (2819)	
		12 (305)	(Prefix)-42-12-HX*	72 (1829)	42 (1067)	96 (2438)	66 (1676)	120 (3048)	90 (2286)	144 (3658)	114 (2895)	
		18 (457)	(Prefix)-42-18-HX*	72 (1829)	48 (1219)	96 (2438)	72 (1829)	120 (3048)	96 (2438)	144 (3658)	120 (3048)	
		24 (609)	(Prefix)-42-24-HX*	72 (1829)	54 (1372)	96 (2438)	78 (1981)	120 (3048)	102 (2591)	144 (3658)	126 (3200)	
30	(762)	60 (1524)	(Prefix)-42-30-HX*	72 (1829)	60 (1524)	96 (2438)	84 (2134)	120 (3048)	108 (2743)	144 (3658)	132 (3353)	
		36 (914)	(Prefix)-42-36-HX*	72 (1829)	66 (1676)	96 (2438)	90 (2286)	120 (3048)	114 (2895)	144 (3658)	138 (3505)	

(Prefix) See page L-3 for catalog number prefix.

Width dimensions are to inside wall. For aluminum fittings add 1.5 inches (38mm) for total outside width.

Manufacturing tolerances apply to all dimensions.

All dimensions in parentheses are millimeters unless otherwise specified.



# Series 2, 3, 4, & 5 - Fittings

## Horizontal Wye (HYL, HYR)

2 pair splice plates with hardware included.

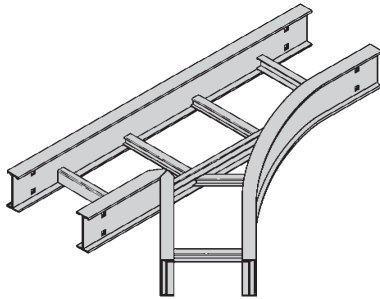

Left Hand Wye - HYL

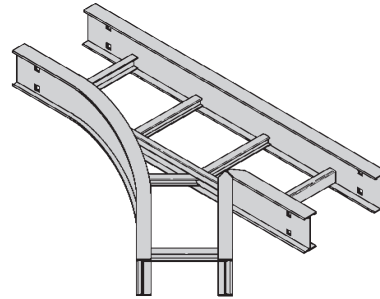

Right Hand Wye - HYR

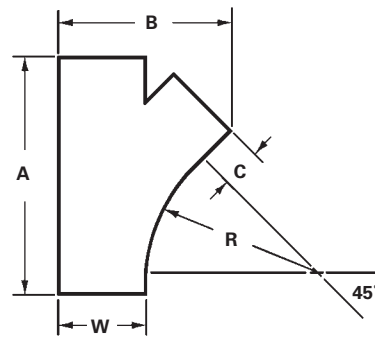
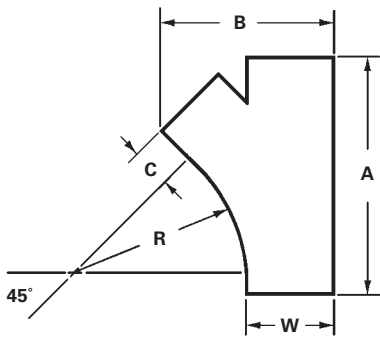

R = Radius

Bend Radius in. mm	Tray Width in. mm	Left Hand Wye Catalog No.	Right Hand Wye Catalog No.	A		B		C	
				in.	mm	in.	mm	in.	mm
24 (609)	6 (152)	(Prefix)-06-HYL	(Prefix)-06-HYR	28 <sup>7</sup> / <sub>16</sub>	(722)	15 <sup>3</sup> / <sub>16</sub>	(386)	3 <sup>1</sup> / <sub>16</sub>	(77)
	9 (228)	(Prefix)-09-HYL	(Prefix)-09-HYR	32 <sup>11</sup> / <sub>16</sub>	(831)	20 <sup>5</sup> / <sub>16</sub>	(516)	6 <sup>1</sup> / <sub>16</sub>	(154)
	12 (305)	(Prefix)-12-HYL	(Prefix)-12-HYR	36 <sup>15</sup> / <sub>16</sub>	(938)	25 <sup>7</sup> / <sub>16</sub>	(646)	9 <sup>1</sup> / <sub>16</sub>	(231)
	18 (457)	(Prefix)-18-HYL	(Prefix)-18-HYR	45 <sup>3</sup> / <sub>8</sub>	(1153)	35 <sup>13</sup> / <sub>16</sub>	(910)	15 <sup>1</sup> / <sub>16</sub>	(383)
	24 (609)	(Prefix)-24-HYL	(Prefix)-24-HYR	53 <sup>7</sup> / <sub>8</sub>	(1368)	45 <sup>15</sup> / <sub>16</sub>	(1167)	21 <sup>1</sup> / <sub>16</sub>	(535)
	30 (762)	(Prefix)-30-HYL	(Prefix)-30-HYR	62 <sup>3</sup> / <sub>8</sub>	(1585)	56 <sup>3</sup> / <sub>16</sub>	(1427)	27 <sup>1</sup> / <sub>16</sub>	(688)
	36 (914)	(Prefix)-36-HYL	(Prefix)-36-HYR	70 <sup>7</sup> / <sub>8</sub>	(1800)	66 <sup>7</sup> / <sub>16</sub>	(1687)	33 <sup>1</sup> / <sub>16</sub>	(840)
42 (1067)	(Prefix)-42-HYL	(Prefix)-42-HYR	79 <sup>3</sup> / <sub>8</sub>	(2016)	76 <sup>5</sup> / <sub>8</sub>	(1946)	39 <sup>1</sup> / <sub>16</sub>	(992)	

(Prefix) See page L-3 for catalog number prefix.

Width dimensions are to inside wall. For aluminum fittings add 1.5 inches (38mm) for total outside width.

Manufacturing tolerances apply to all dimensions.

All dimensions in parentheses are millimeters unless otherwise specified.

## Vertical Bend 90° (VO, VI)

1 pair splice plates with hardware included.

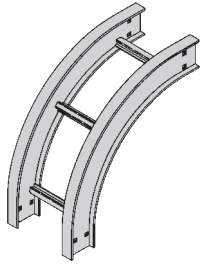

90° Vertical Outside - VO

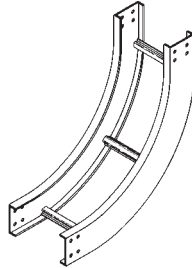

90° Vertical Inside - VI

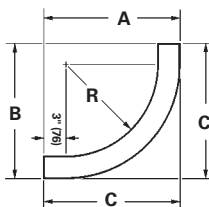
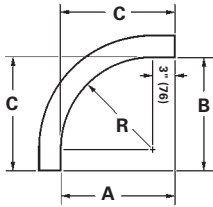

Bend Radius R	Tray Width Insert	(*) Insert "VO" for Vert. Outside Bend "VI" for Vert. Inside Bend Catalog No.	VO Side Rail Height 4" - 7"			VI Side Rail Height													
			4" - 7"			4"			5"			6"			7"				
			in./(mm)			in./(mm)			in./(mm)			in./(mm)			in./(mm)				
in./(mm)	in. (mm)		A	B	C	A	B	C	A	B	C	A	B	C	A	B	C		
12 (305)	6 (152)	(Prefix)-06-90(*)12																	
	9 (228)	(Prefix)-09-90(*)12																	
	12 (305)	(Prefix)-12-90(*)12																	
	18 (457)	(Prefix)-18-90(*)12	15	15	15	19	19	19	20	20	20	21	21	21	22	22	22	22	
	24 (609)	(Prefix)-24-90(*)12	(381)	(381)	(381)	(483)	(483)	(483)	(508)	(508)	(508)	(533)	(533)	(533)	(559)	(559)	(559)	(559)	
	30 (762)	(Prefix)-30-90(*)12																	
	36 (914)	(Prefix)-36-90(*)12																	
42 (1067)	(Prefix)-42-90(*)12																		
24 (609)	6 (152)	(Prefix)-06-90(*)24																	
	9 (228)	(Prefix)-09-90(*)24																	
	12 (305)	(Prefix)-12-90(*)24																	
	18 (457)	(Prefix)-18-90(*)24	27	27	27	31	31	31	32	32	32	33	33	33	34	34	34	34	
	24 (609)	(Prefix)-24-90(*)24	(686)	(686)	(686)	(787)	(787)	(787)	(813)	(813)	(813)	(838)	(838)	(838)	(864)	(864)	(864)	(864)	
	30 (762)	(Prefix)-30-90(*)24																	
	36 (914)	(Prefix)-36-90(*)24																	
42 (1067)	(Prefix)-42-90(*)24																		
36 (914)	6 (152)	(Prefix)-06-90(*)36																	
	9 (228)	(Prefix)-09-90(*)36																	
	12 (305)	(Prefix)-12-90(*)36																	
	18 (457)	(Prefix)-18-90(*)36	39	39	39	43	43	43	44	44	44	45	45	45	46	46	46	46	
	24 (609)	(Prefix)-24-90(*)36	(991)	(991)	(991)	(1092)	(1092)	(1092)	(1118)	(1118)	(1118)	(1143)	(1143)	(1143)	(1168)	(1168)	(1168)	(1168)	
	30 (762)	(Prefix)-30-90(*)36																	
	36 (914)	(Prefix)-36-90(*)36																	
42 (1067)	(Prefix)-42-90(*)36																		
48 (1219)	6 (152)	(Prefix)-06-90(*)48																	
	9 (228)	(Prefix)-09-90(*)48																	
	12 (305)	(Prefix)-12-90(*)48																	
	18 (457)	(Prefix)-18-90(*)48	51	51	51	55	55	55	56	56	56	57	57	57	58	58	58	58	
	24 (609)	(Prefix)-24-90(*)48	(1295)	(1295)	(1295)	(1397)	(1397)	(1397)	(1422)	(1422)	(1422)	(1448)	(1448)	(1448)	(1473)	(1473)	(1473)	(1473)	
	30 (762)	(Prefix)-30-90(*)48																	
	36 (914)	(Prefix)-36-90(*)48																	
42 (1067)	(Prefix)-42-90(*)48																		

(Prefix) See page L-3 for catalog number prefix.

Width dimensions are to inside wall. For aluminum fittings add 1.5 inches (38mm) for total outside width.

Manufacturing tolerances apply to all dimensions.

All dimensions in parentheses are millimeters unless otherwise specified.

# Series 2, 3, 4, & 5 - Fittings

## Vertical Bend 60° (VO, VI)

1 pair splice plates with hardware included.

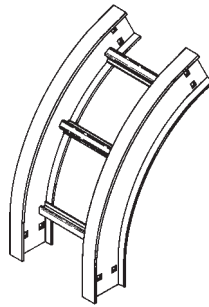

60° Vertical Outside - VO

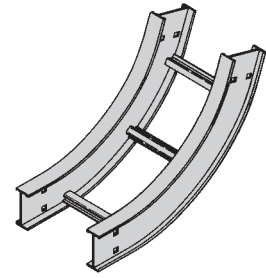

60° Vertical Inside - VI

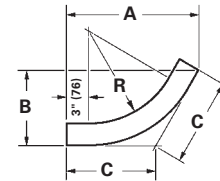
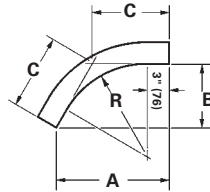

Bend Radius R	Tray Width Insert	(*) Insert "VO" for Vert. Outside Bend "VI" for Vert. Inside Bend Catalog No.	VO Side Rail Height 4" - 7"			VI Side Rail Height											
			in./(mm)			4"			5"			6"			7"		
			A	B	C	A	B	C	A	B	C	A	B	C	A	B	C
12 (305)	6 (152)	(Prefix)-06-60(*)12															
	9 (228)	(Prefix)-09-60(*)12															
	12 (305)	(Prefix)-12-60(*)12															
	18 (457)	(Prefix)-18-60(*)12	147/8	85/8	915/16	183/8	107/8	121/4	191/4	111/8	1213/16	201/16	115/8	133/8	2115/16	121/8	14
	24 (609)	(Prefix)-24-60(*)12	(378)	(219)	(253)	(467)	(270)	(311)	(489)	(283)	(326)	(510)	(296)	(340)	(557)	(308)	(356)
	30 (762)	(Prefix)-30-60(*)12															
	36 (914)	(Prefix)-36-60(*)12															
42 (1067)	(Prefix)-42-60(*)12																
24 (609)	6 (152)	(Prefix)-06-60(*)24															
	9 (228)	(Prefix)-09-60(*)24															
	12 (305)	(Prefix)-12-60(*)24															
	18 (457)	(Prefix)-18-60(*)24	255/16	145/8	167/8	283/4	165/8	193/16	295/8	171/8	193/4	301/2	175/8	205/16	313/8	181/8	207/8
	24 (609)	(Prefix)-24-60(*)24	(643)	(372)	(428)	(730)	(422)	(488)	(753)	(435)	(502)	(775)	(448)	(516)	(797)	(461)	(530)
	30 (762)	(Prefix)-30-60(*)24															
	36 (914)	(Prefix)-36-60(*)24															
42 (1067)	(Prefix)-42-60(*)24																
36 (914)	6 (152)	(Prefix)-06-60(*)36															
	9 (228)	(Prefix)-09-60(*)36															
	12 (305)	(Prefix)-12-60(*)36															
	18 (457)	(Prefix)-18-60(*)36	351/16	205/8	2313/16	391/8	225/8	261/8	40	231/8	2611/16	407/8	235/8	271/4	413/4	241/8	2713/16
	24 (609)	(Prefix)-24-60(*)36	(907)	(524)	(605)	(994)	(575)	(663)	(1016)	(587)	(687)	(1038)	(600)	(692)	(1060)	(613)	(706)
	30 (762)	(Prefix)-30-60(*)36															
	36 (914)	(Prefix)-36-60(*)36															
42 (1067)	(Prefix)-42-60(*)36																
48 (1219)	6 (152)	(Prefix)-06-60(*)48															
	9 (228)	(Prefix)-09-60(*)48															
	12 (305)	(Prefix)-12-60(*)48															
	18 (457)	(Prefix)-18-60(*)48	461/16	265/8	3011/16	499/16	285/8	33	503/8	291/8	335/8	511/4	295/8	343/16	521/8	301/8	343/4
	24 (609)	(Prefix)-24-60(*)48	(1170)	(676)	(780)	(1259)	(727)	(838)	(1280)	(740)	(854)	(1302)	(753)	(868)	(1324)	(765)	(883)
	30 (762)	(Prefix)-30-60(*)48															
	36 (914)	(Prefix)-36-60(*)48															
42 (1067)	(Prefix)-42-60(*)48																

(Prefix) See page L-3 for catalog number prefix.

Width dimensions are to inside wall. For aluminum fittings add 1.5 inches (38mm) for total outside width.

Manufacturing tolerances apply to all dimensions.

All dimensions in parentheses are millimeters unless otherwise specified.

## Vertical Bend 45° (VO, VI)

1 pair splice plates with hardware included.

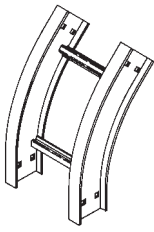

45° Vertical Outside -VO

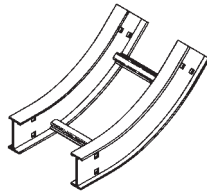

45° Vertical Inside -VI

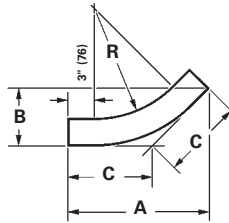
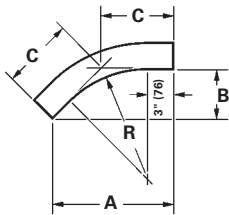

Bend Radius R	Tray Width Insert	(*) Insert "VO" for Vert. Outside Bend "VI" for Vert. Inside Bend Catalog No.	VO Side Rail Height 4" - 7"			VI Side Rail Height											
			in./(mm)			4"			5"			6"			7"		
			A	B	C	A	B	C	A	B	C	A	B	C	A	B	C
12 (305)	6 (152)	(Prefix)-06-45(*)12	13 <sup>5</sup> / <sub>8</sub> (346)	5 <sup>5</sup> / <sub>8</sub> (143)	8 (203)	16 <sup>7</sup> / <sub>16</sub> (417)	6 <sup>13</sup> / <sub>16</sub> (173)	9 <sup>5</sup> / <sub>8</sub> (245)	17 <sup>1</sup> / <sub>8</sub> (435)	7 <sup>1</sup> / <sub>8</sub> (181)	10 <sup>1</sup> / <sub>16</sub> (256)	17 <sup>7</sup> / <sub>8</sub> (454)	7 <sup>3</sup> / <sub>8</sub> (188)	10 <sup>7</sup> / <sub>16</sub> (265)	18 <sup>9</sup> / <sub>16</sub> (471)	7 <sup>11</sup> / <sub>16</sub> (195)	10 <sup>7</sup> / <sub>8</sub> (2176)
	9 (228)	(Prefix)-09-45(*)12															
	12 (305)	(Prefix)-12-45(*)12															
	18 (457)	(Prefix)-18-45(*)12															
	24 (609)	(Prefix)-24-45(*)12															
	30 (762)	(Prefix)-30-45(*)12															
	36 (914)	(Prefix)-36-45(*)12															
42 (1067)	(Prefix)-42-45(*)12																
24 (609)	6 (152)	(Prefix)-06-45(*)24	22 <sup>1</sup> / <sub>16</sub> (561)	9 <sup>1</sup> / <sub>8</sub> (232)	12 <sup>15</sup> / <sub>16</sub> (329)	24 <sup>15</sup> / <sub>16</sub> (634)	10 <sup>5</sup> / <sub>16</sub> (262)	14 <sup>5</sup> / <sub>8</sub> (372)	25 <sup>5</sup> / <sub>8</sub> (651)	10 <sup>5</sup> / <sub>8</sub> (270)	15 (381)	26 <sup>5</sup> / <sub>16</sub> (668)	10 <sup>15</sup> / <sub>16</sub> (278)	15 <sup>7</sup> / <sub>16</sub> (392)	27 <sup>1</sup> / <sub>16</sub> (687)	11 <sup>3</sup> / <sub>16</sub> (284)	15 <sup>13</sup> / <sub>16</sub> (402)
	9 (228)	(Prefix)-09-45(*)24															
	12 (305)	(Prefix)-12-45(*)24															
	18 (457)	(Prefix)-18-45(*)24															
	24 (609)	(Prefix)-24-45(*)24															
	30 (762)	(Prefix)-30-45(*)24															
	36 (914)	(Prefix)-36-45(*)24															
42 (1067)	(Prefix)-42-45(*)24																
36 (914)	6 (152)	(Prefix)-06-45(*)36	30 <sup>9</sup> / <sub>16</sub> (776)	12 <sup>11</sup> / <sub>16</sub> (323)	17 <sup>15</sup> / <sub>16</sub> (456)	33 <sup>3</sup> / <sub>8</sub> (848)	13 <sup>13</sup> / <sub>16</sub> (351)	19 <sup>9</sup> / <sub>16</sub> (497)	34 <sup>1</sup> / <sub>8</sub> (867)	14 <sup>1</sup> / <sub>8</sub> (359)	20 (508)	34 <sup>13</sup> / <sub>16</sub> (885)	14 <sup>7</sup> / <sub>16</sub> (367)	20 <sup>3</sup> / <sub>8</sub> (518)	35 <sup>1</sup> / <sub>2</sub> (902)	14 <sup>11</sup> / <sub>16</sub> (284)	20 <sup>13</sup> / <sub>16</sub> (402)
	9 (228)	(Prefix)-09-45(*)36															
	12 (305)	(Prefix)-12-45(*)36															
	18 (457)	(Prefix)-18-45(*)36															
	24 (609)	(Prefix)-24-45(*)36															
	30 (762)	(Prefix)-30-45(*)36															
	36 (914)	(Prefix)-36-45(*)36															
42 (1067)	(Prefix)-42-45(*)36																
48 (1219)	6 (152)	(Prefix)-06-45(*)48	39 <sup>1</sup> / <sub>16</sub> (992)	16 <sup>3</sup> / <sub>16</sub> (411)	22 <sup>7</sup> / <sub>8</sub> (581)	41 <sup>7</sup> / <sub>8</sub> (1064)	17 <sup>3</sup> / <sub>8</sub> (441)	24 <sup>9</sup> / <sub>16</sub> (624)	42 <sup>5</sup> / <sub>8</sub> (1083)	17 <sup>5</sup> / <sub>8</sub> (448)	24 <sup>15</sup> / <sub>16</sub> (633)	43 <sup>5</sup> / <sub>16</sub> (1100)	17 <sup>15</sup> / <sub>16</sub> (456)	25 <sup>3</sup> / <sub>8</sub> (645)	44 (1118)	18 <sup>1</sup> / <sub>4</sub> (464)	25 <sup>13</sup> / <sub>16</sub> (656)
	9 (228)	(Prefix)-09-45(*)48															
	12 (305)	(Prefix)-12-45(*)48															
	18 (457)	(Prefix)-18-45(*)48															
	24 (609)	(Prefix)-24-45(*)48															
	30 (762)	(Prefix)-30-45(*)48															
	36 (914)	(Prefix)-36-45(*)48															
42 (1067)	(Prefix)-42-45(*)48																

(Prefix) See page L-3 for catalog number prefix.

Width dimensions are to inside wall. For aluminum fittings add 1.5 inches (38mm) for total outside width.

Manufacturing tolerances apply to all dimensions.

All dimensions in parentheses are millimeters unless otherwise specified.

# Series 2, 3, 4, & 5 - Fittings

## Vertical Bend 30° (VO, VI)

1 pair splice plates with hardware included.

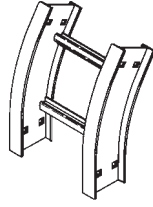

30° Vertical Outside -VO

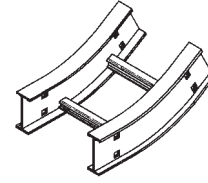

30° Vertical Inside -VI

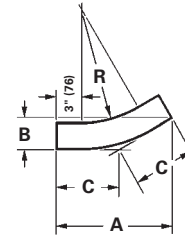
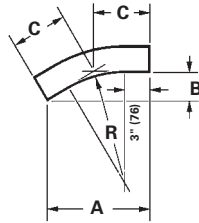

Bend Radius R	Tray Width Insert	(*) Insert "VO" for Vert. Outside Bend "VI" for Vert. Inside Bend Catalog No.	VO Side Rail Height 4" - 7"			VI Side Rail Height											
			in./(mm)			4"			5"			6"			7"		
			A	B	C	A	B	C	A	B	C	A	B	C	A	B	C
12 (305)	6 (152)	(Prefix)-06-30(*)12	11 <sup>5</sup> / <sub>8</sub> (296)	3 <sup>1</sup> / <sub>8</sub> (79)	6 <sup>3</sup> / <sub>16</sub> (157)	13 <sup>5</sup> / <sub>8</sub> (346)	3 <sup>5</sup> / <sub>8</sub> (92)	7 <sup>5</sup> / <sub>16</sub> (186)	14 <sup>1</sup> / <sub>8</sub> (359)	3 <sup>3</sup> / <sub>4</sub> (95)	7 <sup>9</sup> / <sub>16</sub> (192)	14 <sup>5</sup> / <sub>8</sub> (372)	3 <sup>15</sup> / <sub>16</sub> (100)	7 <sup>13</sup> / <sub>16</sub> (199)	15 <sup>1</sup> / <sub>8</sub> (384)	4 <sup>1</sup> / <sub>16</sub> (103)	8 <sup>1</sup> / <sub>16</sub> (205)
	9 (228)	(Prefix)-09-30(*)12															
	12 (305)	(Prefix)-12-30(*)12															
	18 (457)	(Prefix)-18-30(*)12															
	24 (609)	(Prefix)-24-30(*)12															
	30 (762)	(Prefix)-30-30(*)12															
	36 (914)	(Prefix)-36-30(*)12															
42 (1067)	(Prefix)-42-30(*)12																
24 (609)	6 (152)	(Prefix)-06-30(*)24	17 <sup>5</sup> / <sub>8</sub> (448)	4 <sup>11</sup> / <sub>16</sub> (120)	9 <sup>7</sup> / <sub>16</sub> (240)	19 <sup>5</sup> / <sub>8</sub> (499)	5 <sup>1</sup> / <sub>4</sub> (133)	10 <sup>1</sup> / <sub>2</sub> (267)	20 <sup>1</sup> / <sub>8</sub> (511)	5 <sup>3</sup> / <sub>8</sub> (137)	10 <sup>3</sup> / <sub>4</sub> (273)	20 <sup>5</sup> / <sub>8</sub> (524)	5 <sup>1</sup> / <sub>2</sub> (140)	11 <sup>1</sup> / <sub>16</sub> (282)	21 <sup>1</sup> / <sub>8</sub> (537)	5 <sup>5</sup> / <sub>8</sub> (143)	11 <sup>5</sup> / <sub>16</sub> (287)
	9 (228)	(Prefix)-09-30(*)24															
	12 (305)	(Prefix)-12-30(*)24															
	18 (457)	(Prefix)-18-30(*)24															
	24 (609)	(Prefix)-24-30(*)24															
	30 (762)	(Prefix)-30-30(*)24															
	36 (914)	(Prefix)-36-30(*)24															
42 (1067)	(Prefix)-42-30(*)24																
36 (914)	6 (152)	(Prefix)-06-30(*)36	23 <sup>5</sup> / <sub>8</sub> (600)	6 <sup>5</sup> / <sub>16</sub> (160)	12 <sup>5</sup> / <sub>8</sub> (321)	25 <sup>5</sup> / <sub>8</sub> (651)	6 <sup>7</sup> / <sub>8</sub> (174)	13 <sup>11</sup> / <sub>16</sub> (348)	26 <sup>1</sup> / <sub>8</sub> (663)	7 (175)	14 (356)	26 <sup>5</sup> / <sub>8</sub> (676)	7 <sup>1</sup> / <sub>8</sub> (181)	14 <sup>1</sup> / <sub>4</sub> (362)	27 <sup>1</sup> / <sub>8</sub> (689)	7 <sup>1</sup> / <sub>4</sub> (184)	14 <sup>1</sup> / <sub>2</sub> (287)
	9 (228)	(Prefix)-09-30(*)36															
	12 (305)	(Prefix)-12-30(*)36															
	18 (457)	(Prefix)-18-30(*)36															
	24 (609)	(Prefix)-24-30(*)36															
	30 (762)	(Prefix)-30-30(*)36															
	36 (914)	(Prefix)-36-30(*)36															
42 (1067)	(Prefix)-42-30(*)36																
48 (1219)	6 (152)	(Prefix)-06-30(*)48	29 <sup>5</sup> / <sub>8</sub> (753)	7 <sup>15</sup> / <sub>16</sub> (202)	15 <sup>7</sup> / <sub>8</sub> (403)	31 <sup>5</sup> / <sub>8</sub> (803)	8 <sup>7</sup> / <sub>16</sub> (214)	16 <sup>15</sup> / <sub>16</sub> (430)	32 <sup>1</sup> / <sub>8</sub> (816)	8 <sup>5</sup> / <sub>8</sub> (219)	17 <sup>3</sup> / <sub>16</sub> (437)	32 <sup>5</sup> / <sub>8</sub> (829)	8 <sup>3</sup> / <sub>4</sub> (222)	17 <sup>1</sup> / <sub>2</sub> (445)	33 <sup>1</sup> / <sub>8</sub> (842)	8 <sup>7</sup> / <sub>8</sub> (226)	17 <sup>3</sup> / <sub>4</sub> (451)
	9 (228)	(Prefix)-09-30(*)48															
	12 (305)	(Prefix)-12-30(*)48															
	18 (457)	(Prefix)-18-30(*)48															
	24 (609)	(Prefix)-24-30(*)48															
	30 (762)	(Prefix)-30-30(*)48															
	36 (914)	(Prefix)-36-30(*)48															
42 (1067)	(Prefix)-42-30(*)48																

(Prefix) See page L-3 for catalog number prefix.

Width dimensions are to inside wall. For aluminum fittings add 1.5 inches (38mm) for total outside width.

Manufacturing tolerances apply to all dimensions.

All dimensions in parentheses are millimeters unless otherwise specified.

Vertical Tee Up/Down (VTU/VT)

2 pair splice plates with hardware included.

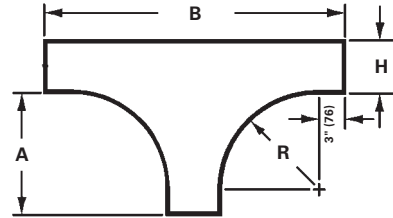
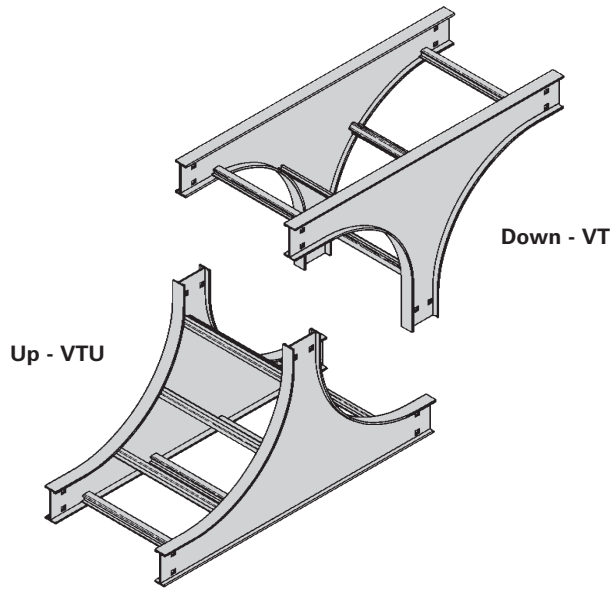

Bend Radius R in./mm	Tray Width in. mm	Vertical Tee Down Catalog No.	Vertical Tee Up Catalog No.	Side Rail Height "H"							
				4"		5"		6"		7"	
				A in./mm	B in./mm	A in./mm	B in./mm	A in./mm	B in./mm	A in./mm	B in./mm
12 (305)	6 (152)	(Prefix)-06-VT12	(Prefix)-06-VTU12	15 (381)	34 (846)	15 (381)	35 (889)	15 (381)	36 (914)	15 (381)	37 (940)
	9 (228)	(Prefix)-09-VT12	(Prefix)-09-VTU12								
	12 (305)	(Prefix)-12-VT12	(Prefix)-12-VTU12								
	18 (457)	(Prefix)-18-VT12	(Prefix)-18-VTU12								
	24 (609)	(Prefix)-24-VT12	(Prefix)-24-VTU12								
	30 (762)	(Prefix)-30-VT12	(Prefix)-30-VTU12								
	36 (914)	(Prefix)-36-VT12	(Prefix)-36-VTU12								
42 (1067)	(Prefix)-42-VT12	(Prefix)-42-VTU12									
24 (609)	6 (152)	(Prefix)-06-VT24	(Prefix)-06-VTU24	27 (6867)	58 (1473)	27 (686)	59 (1498)	27 (686)	60 (1524)	27 (686)	61 (1549)
	9 (228)	(Prefix)-09-VT24	(Prefix)-09-VTU24								
	12 (305)	(Prefix)-12-VT24	(Prefix)-12-VTU24								
	18 (457)	(Prefix)-18-VT24	(Prefix)-18-VTU24								
	24 (609)	(Prefix)-24-VT24	(Prefix)-24-VTU24								
	30 (762)	(Prefix)-30-VT24	(Prefix)-30-VTU24								
	36 (914)	(Prefix)-36-VT24	(Prefix)-36-VTU24								
42 (1067)	(Prefix)-42-VT24	(Prefix)-42-VTU24									
36 (914)	6 (152)	(Prefix)-06-VT36	(Prefix)-06-VTU36	39 (991)	82 (2083)	39 (991)	83 (2108)	39 (991)	84 (2134)	39 (991)	85 (2159)
	9 (228)	(Prefix)-09-VT36	(Prefix)-09-VTU36								
	12 (305)	(Prefix)-12-VT36	(Prefix)-12-VTU36								
	18 (457)	(Prefix)-18-VT36	(Prefix)-18-VTU36								
	24 (609)	(Prefix)-24-VT36	(Prefix)-24-VTU36								
	30 (762)	(Prefix)-30-VT36	(Prefix)-30-VTU36								
	36 (914)	(Prefix)-36-VT36	(Prefix)-36-VTU36								
42 (1067)	(Prefix)-42-VT36	(Prefix)-42-VTU36									
48 (1219)	6 (152)	(Prefix)-06-VT48	(Prefix)-06-VTU48	51 (1295)	106 (2692)	51 (1295)	107 (2718)	51 (1295)	108 (2743)	51 (1295)	109 (2769)
	9 (228)	(Prefix)-09-VT48	(Prefix)-09-VTU48								
	12 (305)	(Prefix)-12-VT48	(Prefix)-12-VTU48								
	18 (457)	(Prefix)-18-VT48	(Prefix)-18-VTU48								
	24 (609)	(Prefix)-24-VT48	(Prefix)-24-VTU48								
	30 (762)	(Prefix)-30-VT48	(Prefix)-30-VTU48								
	36 (914)	(Prefix)-36-VT48	(Prefix)-36-VTU48								
42 (1067)	(Prefix)-42-VT48	(Prefix)-42-VTU48									

Series 2, 3, 4, & 5 Fittings

(Prefix) See page L-3 for catalog number prefix.

Width dimensions are to inside wall. For aluminum fittings add 1.5 inches (38mm) for total outside width.

Manufacturing tolerances apply to all dimensions.

All dimensions in parentheses are millimeters unless otherwise specified.

# Series 2, 3, 4, & 5 - Fittings

## Cable Support Fittings (CSF)

1 pair splice plates with hardware included.

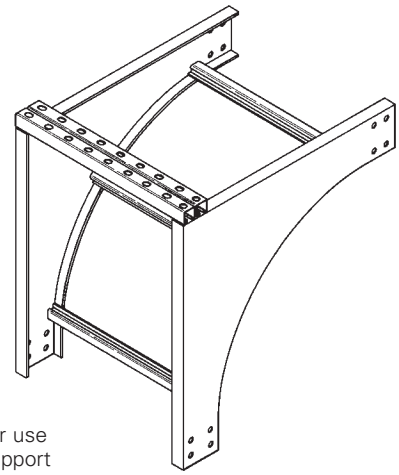
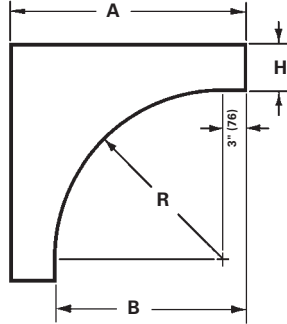

This fitting is recommended for use at the top of vertical runs to support the weight of the cables. The top cross brace is drilled for installing eyebolts, ordered separately.

Series 2, 3, 4, & 5 Fittings

Bend Radius R in./mm	Tray Width in. mm	Catalog No.	Side Rail Height "H"								
			4"		5"		6"		7"		
			A in./mm	B in./mm	A in./mm	B in./mm	A in./mm	B in./mm	A in./mm	B in./mm	
12 (305)	6 152	(Prefix)-06-CSF12									
	9 228	(Prefix)-09-CSF12									
	12 305	(Prefix)-12-CSF12									
	18 457	(Prefix)-18-CSF12	19	15	20	15	21	15	22	15	
	24 609	(Prefix)-24-CSF12	(483)	(381)	(508)	(381)	(533)	(381)	(559)	(381)	
	30 762	(Prefix)-30-CSF12									
	36 914	(Prefix)-36-CSF12									
42 1067	(Prefix)-42-CSF12										
24 (609)	6 152	(Prefix)-06-CSF24									
	9 228	(Prefix)-09-CSF24									
	12 305	(Prefix)-12-CSF24									
	18 457	(Prefix)-18-CSF24	31	27	32	27	33	27	34	27	
	24 609	(Prefix)-24-CSF24	(787)	(686)	(813)	(686)	(838)	(686)	(864)	(686)	
	30 762	(Prefix)-30-CSF24									
	36 914	(Prefix)-36-CSF24									
42 1067	(Prefix)-42-CSF24										
36 (914)	6 152	(Prefix)-06-CSF36									
	9 228	(Prefix)-09-CSF36									
	12 305	(Prefix)-12-CSF36									
	18 457	(Prefix)-18-CSF36	43	39	44	39	45	39	46	39	
	24 609	(Prefix)-24-CSF36	(1092)	(991)	(1118)	(991)	(1143)	(991)	(1168)	(991)	
	30 762	(Prefix)-30-CSF36									
	36 914	(Prefix)-36-CSF36									
42 1067	(Prefix)-42-CSF36										
48 (1219)	6 152	(Prefix)-06-CSF48									
	9 228	(Prefix)-09-CSF48									
	12 305	(Prefix)-12-CSF48									
	18 457	(Prefix)-18-CSF48	55	51	56	51	57	51	58	51	
	24 609	(Prefix)-24-CSF48	(1397)	(1295)	(1422)	(1295)	(1448)	(1295)	(1473)	(1295)	
	30 762	(Prefix)-30-CSF48									
	36 914	(Prefix)-36-CSF48									
42 1067	(Prefix)-42-CSF48										

**(Prefix)** See page L-3 for catalog number prefix.

Width dimensions are to inside wall. For aluminum fittings add 1.5 inches (38mm) for total outside width.

Manufacturing tolerances apply to all dimensions.

All dimensions in parentheses are millimeters unless otherwise specified.

