



Applies To: **2002–03 Civic** – Check the iN VIN status for eligibility  
**2002–03 Civic GX** – Check the iN VIN status for eligibility  
**2003 Civic Hybrid** – Check the iN VIN status for eligibility  
**2002–03 Civic Si** – Check the iN VIN status for eligibility  
**2004–05 Pilot** – Check the iN VIN status for eligibility

April 17, 2012

## Headlight Switch Inspection

### BACKGROUND

American Honda is inspecting headlight switches, connectors, and a harness wire from selected vehicles. With the customer's consent, complete the worksheet, and do the inspection. Based on the outcome of the inspection, you will be directed to either replace a harness wire or replace the headlight switch, the connector, and a harness wire.

If you are directed to replace the headlight switch, the combination light switch repair kit will be overnighted to your dealership. American Honda will pay 1 day for a rental car to help avoid any customer inconvenience. There is no rental coverage for customer vehicles that need only a harness wire.

This is a voluntary action, not a campaign. You **must** have the customer's permission **before** doing the inspection on eligible vehicles because replacing any part without the customer's permission is illegal. After the study is complete, this procedure will be discontinued.

### PARTS INFORMATION

Combination Light Switch Wire Kit:

P/N 06322-SAA-305

(Includes 250 mm wire with attached terminal, wire splice connector, and wire tie)

Combination Light Switch Repair Kit:

P/N 06323-SAA-307

P/N 06323-SAA-309 (2005 Pilots with Genuine Honda Accessory Fog Lights)

(Includes switch, 16P wire harness connector, 250 mm wire with attached terminal, wire splice connector, and wire tie)

### TOOL INFORMATION

NOTE: The tools listed below were previously sent to your dealership for the completion of Service Bulletin 04-015, *Safety Recall: Combination Light Switch*. If you need additional tools, order them through the parts ordering system.

Terminal Pin Kit C: T/N 07QAZ-003020C

(Contains the wire crimper and the heat gun used for wire splicing.)

Terminal Maintenance Set: T/N 070AZ-S5A0100

(Contains Terminal Remover Set [six small, plastic tools used to remove terminals from the 16P headlight wire harness connector], and Secondary Lock Opener [a miniature, flat-tip screwdriver used to open the secondary locks on the 16P headlight wire harness connector])

## WARRANTY CLAIM INFORMATION

OP#	Description	FRT
7281A4	Install a Combination Light Switch Wire Kit, complete worksheet, and take photos – Civic	0.9
	Install a Combination Light Switch Wire Kit, complete worksheet, and take photos – Pilot	0.8
7281A3	Install a Combination Light Switch Repair Kit, complete worksheet, and take photos – Civic	1.0
	Install a Combination Light Switch Repair Kit, complete worksheet, and take photos – Pilot	0.8

Failed Part: P/N 35255-S5A-A01

Defect Code: 5LH00

Symptom Code: S3600

Skill Level: Repair Technician

Enter the following information when submitting a warranty claim:

- **Customer Complaint:** Headlight Switch Inspection and/or Replacement
- **Cause:** AHM request
- **Correction:** Install the Combination Light Switch Repair Kit or the Combination Light Switch Wire Kit, and submit photos

You will need to enter sublet code P1 to attach photos even though there is no sublet invoice. Enter the following information in the sublet fields:

- **First Sublet Code:** P1
- **Invoice Number:** AHMPHOTO
- **Invoice Amount:** \$20

## PHOTOS

You will need to submit at least six photos as described in the INSPECTION AND REPLACEMENT PROCEDURE.

For detailed information instructions how to submit photos, refer to ATTACHING PHOTOS TO A CLAIM in Service Bulletin 10-002, *Photos for Warranty Paint Repair Claims*.

## INSPECTION AND REPLACEMENT PROCEDURE

### NOTE:

- SRS components are located in this area. Before you begin, review the SRS component locations, cautions, and procedures in the service manual.
  - Be careful not to damage the dashboard or other interior trim pieces.
  - For more information on wire terminal replacement and wire splicing, refer to Service Bulletin 00-099, *Terminal Replacement Instructions*.
1. Print out and complete a copy of the HEADLIGHT SWITCH WORKSHEET (2 pages) at the end of this bulletin. This completed worksheet **must** be included with the returned parts.
  2. Remove the three screws, then remove the steering column covers.

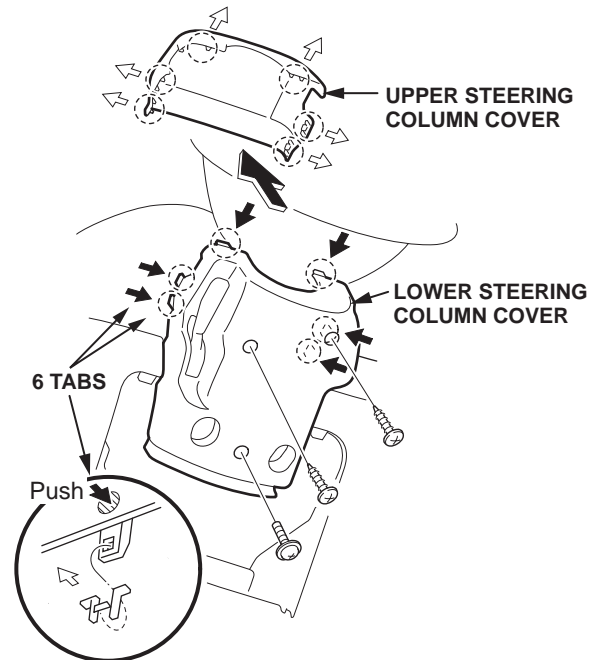

3. Take two clear photos of the switch connectors **before** you disconnect them:
- Take one image looking down on the connectors as shown.

*CIVIC*



*PILOT*



- Take the second photo from the side as shown.

*CIVIC*



*PILOT*



4. Inspect the 16P connector to see if it is twisted.
  - If it is twisted, take a close-up photo of the harness before going to step 5.
  - If it is not twisted, go to step 5.

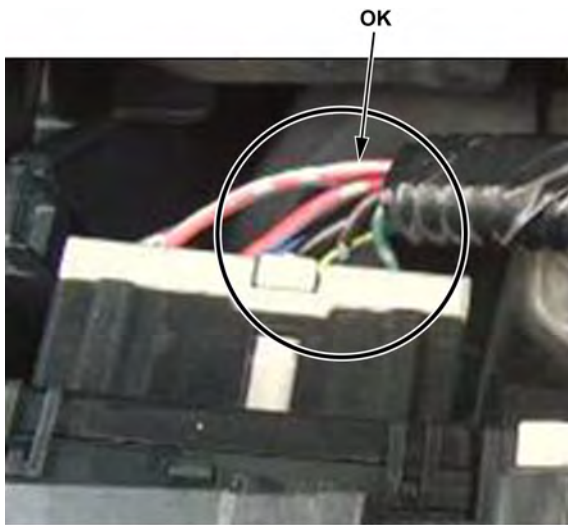

5. Disconnect the 16P connector from the combination light switch and the 5P connector from the cable reel (if equipped). On Civic Hatchbacks, also disconnect the 14P connector from the wiper switch. Then, carefully pull the wire harness to the right of the steering column.

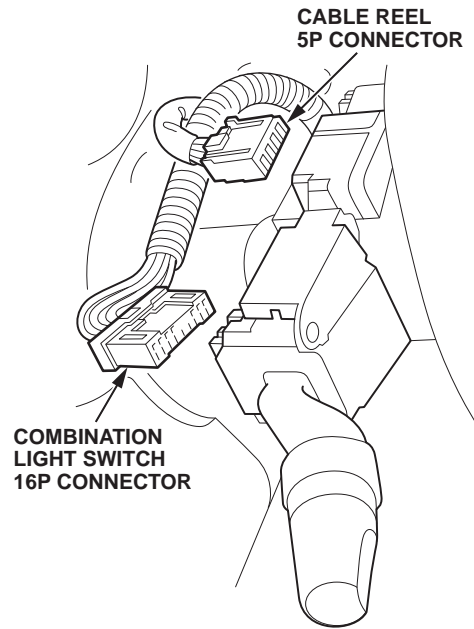

6. Turn the ignition switch to ACC (I), then turn the steering wheel 90 degrees to the left to allow room for removal of the combination light switch.
7. Remove the two screws from the combination light switch.

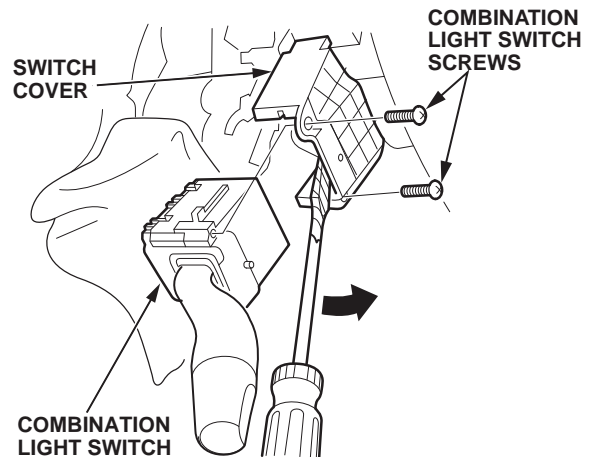

8. Using a flat-tip screwdriver wrapped with tape, slightly lift the switch cover, then remove the switch.

9. **For Civic** - Remove the tape or corrugated tubing/foam from the 16P connector wire harness to expose about 200 mm of wire. Discard the tape, but retain the tubing/foam.

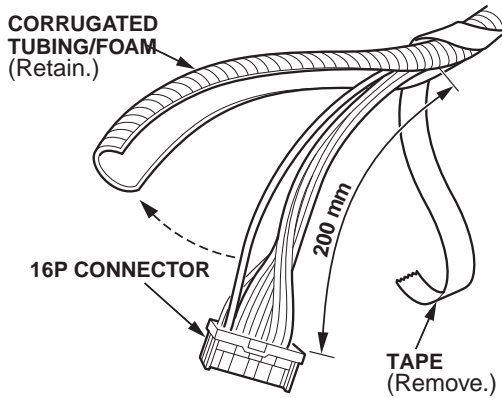

10. Using the photos below for reference, check for signs of heat damage on the 16P connector and the terminals of the combination light switch.

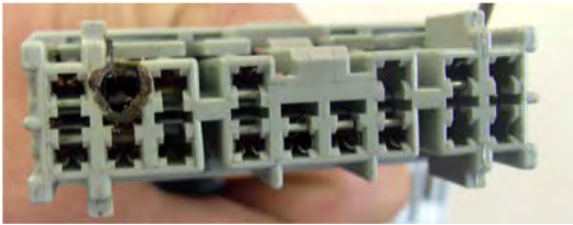

11. Take two clear photos:

- Take one photo of the headlight switch connector.
- Take one photo of the terminals on the headlight switch.

12. **For Pilot only** – If you see a splice connector on the terminal No. 6 wire, cut the wire above the splice connector as shown, and continue with the repair.

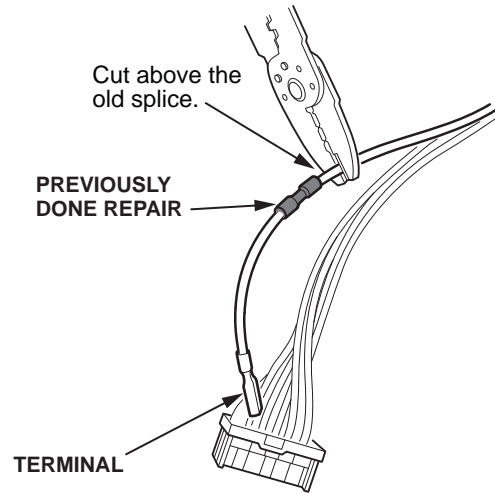

13. Determine if you need to install a combination light switch *repair* kit or a combination light switch *wire* kit.

- Install a combination light switch *repair* kit if **any box on the worksheet is marked YES** or there is heat damage to the headlight switch connector or the switch.
- Install a combination light switch *wire* kit if **all the boxes on the worksheet are marked NO** and there is no heat damage to the headlight switch connector or the switch.

14. Using the secondary lock opener from the Terminal Maintenance Set (T/N 070AZ-S5A0100), carefully pry open the secondary lock of the combination light switch 16P connector.

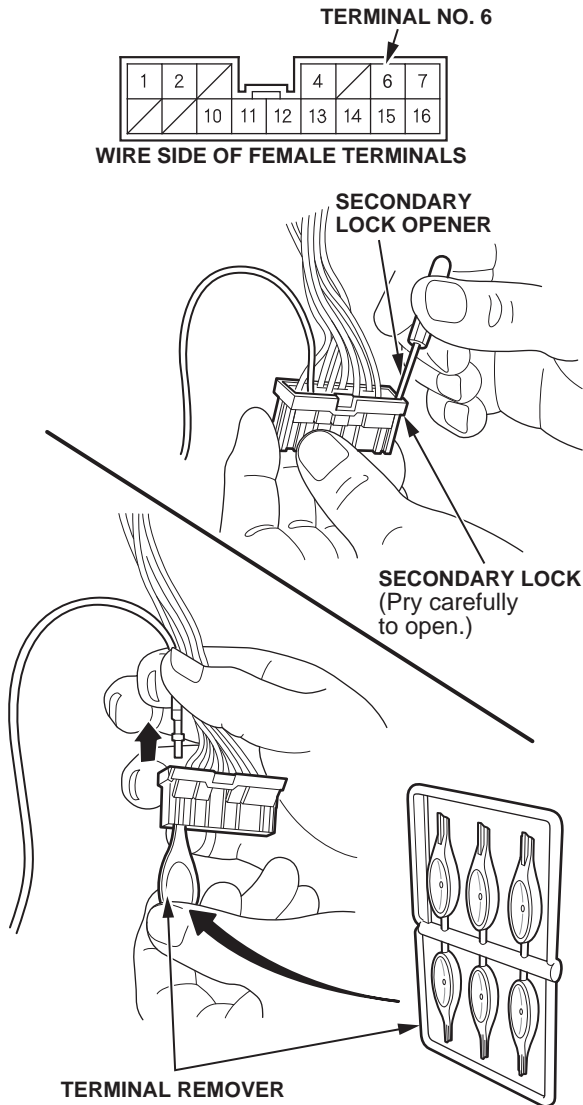

15. Twist off a terminal remover from the Terminal Maintenance Set (T/N 070AZ-S5A0100). Insert the terminal remover into the center row cavity of the 16P connector, above terminal No. 6, then remove the wire from the 16P connector.

- If you are installing a combination light switch *wire kit*, go to step 18.
- If you are installing a combination light switch *repair kit*, go to step 16.

NOTE: Make sure the wire you are removing is terminal No. 6 as different models have different wire colors:

- All Civics - RED/WHT
- 2004 Pilot - WHT/RED
- 2005 Pilot - YEL

16. Using the secondary lock opener from the Terminal Maintenance Set (T/N 070AZ-S5A0100), carefully pry open the other secondary lock on the 16P connector.
17. Twist off a terminal remover from the Terminal Maintenance Set (T/N 070AZ-S5A0100). Insert the terminal remover into a center row cavity of the original 16P connector, remove the corresponding wire from its cavity, and transfer it to the same cavity in the new 16P connector from the repair kit. Repeat this for all the wires *except* terminal No. 6; this wire will be installed later.

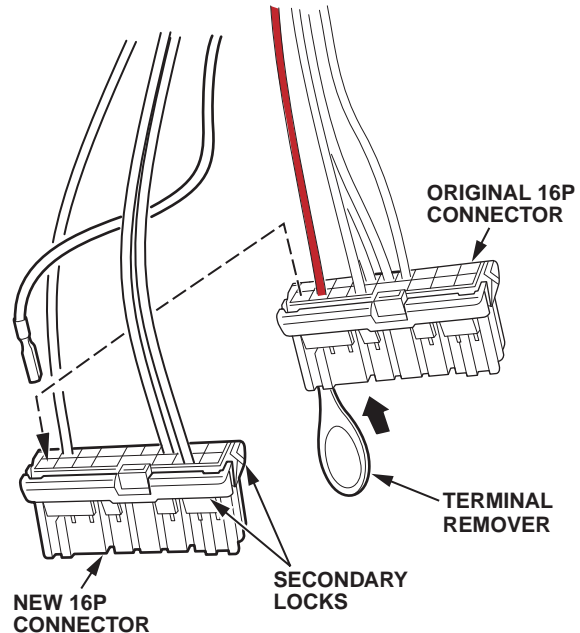

18. On the new RED/WHT wire provided in the kit, measure 50 mm from the terminal end, and wrap a 50 mm section of the wire with three turns of electrical tape. This taped section of the wire will be secured to the combination light switch in step 27.

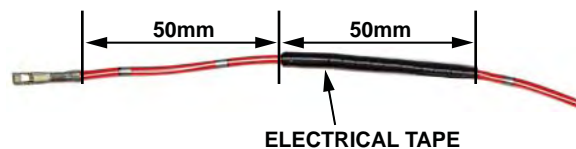

19. Strip off 7 mm of insulation from the opposite end of the new RED/WHT wire.

20. Cut the vehicle side terminal No. 6 wire near the terminal, then strip off 7 mm of insulation from the end of the wire.

NOTE: If there was any heat damage to the wire, make sure to cut off the damaged area before you strip off the insulation.

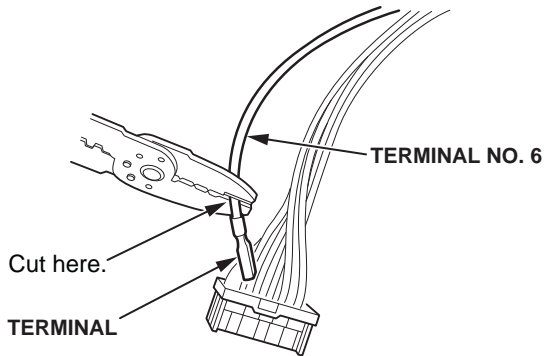

21. Insert the stripped end of the new and the original wire into each side of the splice connector from the kit, then, using the wire crimper from Terminal Pin Kit C, crimp the connector on both sides. Slightly pull on both sides of the wire to make sure it's secured in the splice connector.

NOTE: To get the correct amount of pressure on the splice connector, you need to use the wire crimper from Terminal Pin Kit C.

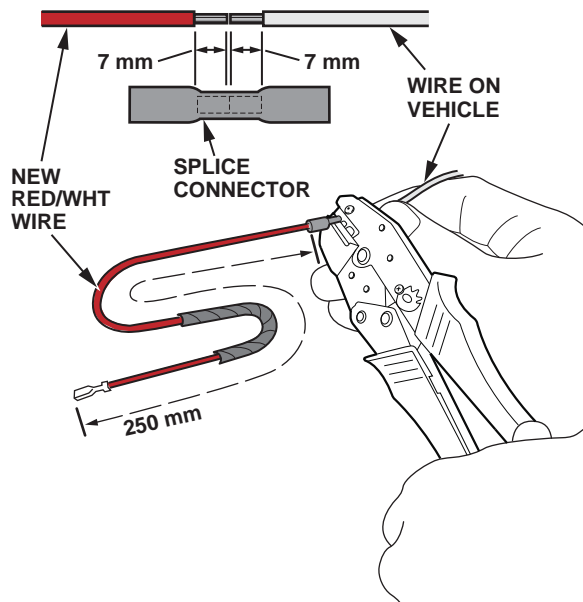

22. With a non-combustible material between the wire and the vehicle wire harness, use a heat gun to shrink the splice connector casing.

NOTE:

- Be careful not to get burned.
- Do not overheat the wire.

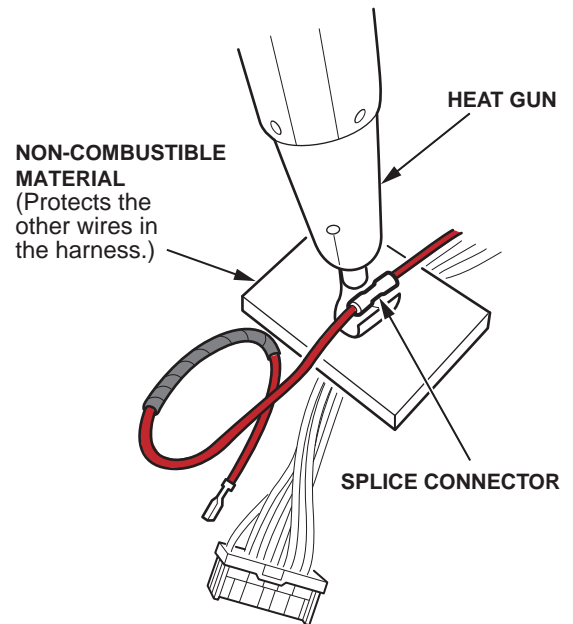

23. Using electrical tape, retape the wire harness or insert the wires into the corrugated tubing/foam and retape the tubing/foam.

24. Place the wire splice on top of the combination switch wire harness, then attach the splice to the harness by wrapping them together with electrical tape.

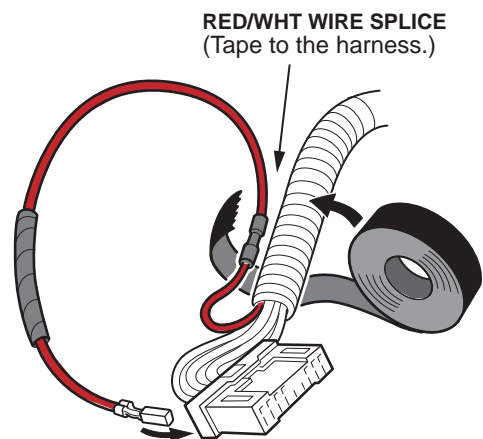

25. Insert the new RED/WHT wire into terminal No. 6 position in the 16P connector, then snap the connector secondary locks closed.

26. Release the cover locks on the combination light switch, then remove the switch cover.

NOTE: Make sure you are using the new headlight switch if you are installing the combination light switch *repair kit*.

Release the switch cover locks.

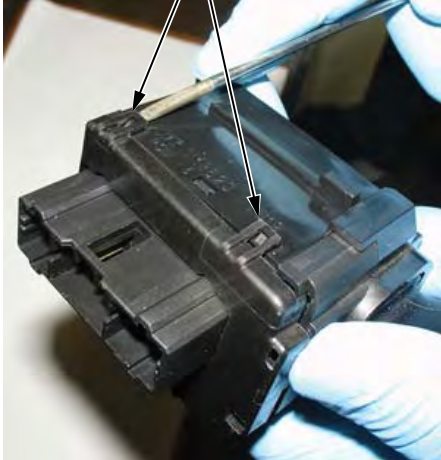

SWITCH COVER  
Remove.



27. As shown below, route the wire tie from the kit through the hole in the lower corner of the switch cover. Then, use the wire tie to secure the RED/WHT wire (in the section you taped in step 18) to the switch cover. Reinstall the cover, and cut off the excess wire tie.

SWITCH COVER

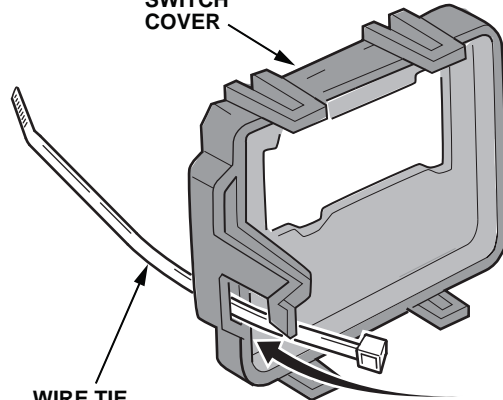

WIRE TIE  
Route through the switch cover hole in the direction of the arrow.

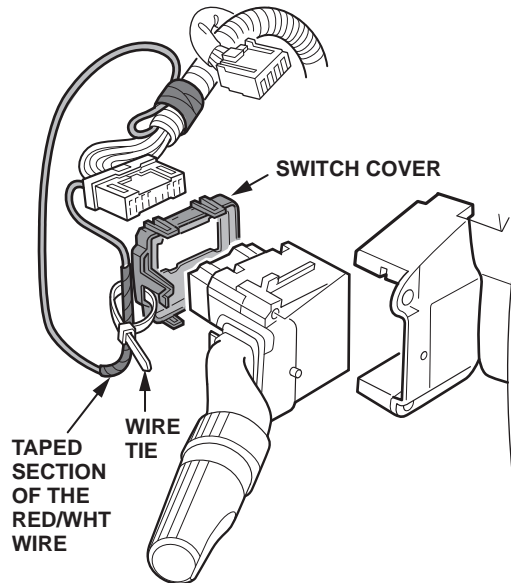



28. Reroute the wire harness over the steering column, then connect the 16P connector to the combination light switch, the 5P connector to the cable reel connector and, on Civic Hatchbacks, the 14P connector to the wiper switch.

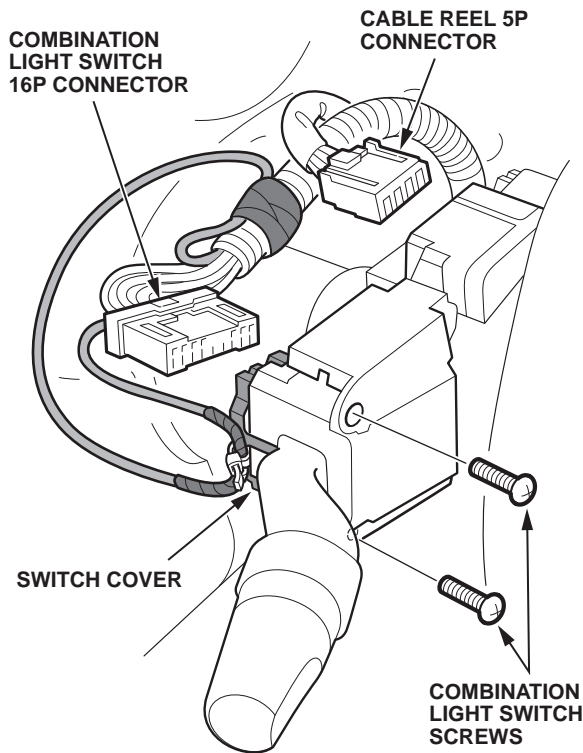

29. Install the combination light switch with the two original screws.
30. Check the operation of the headlights, the parking lights, and the turn signals.
31. Install the steering column covers.
32. Take one photo of each page of the completed worksheet, and forward your photos (at least six) to your warranty claims administrator.

33. Place the applicable parts and the completed headlight switch worksheet in a box or bag that will be collected by American Honda:

- If you installed the Combination Light Switch Wire Kit, attach the worksheet to the wire, and place it in a bag.
- If you installed the Combination Light Switch Repair Kit, place the original headlight switch, the wire, the connector, and the worksheet in the kit's box.

34. Return the parts to the parts department for collection by American Honda.

**Headlight Switch Worksheet**  
**02-03 Civic and 04-05 Pilot Headlight Switch**

**Note:** For the dealer to receive credit for this claim, this worksheet must be **completely** filled out and included with the returned parts.

**Section 1 - General Information**

Dealer # \_\_\_\_\_

Repair  
Order # \_\_\_\_\_

VIN \_\_\_\_\_

Mileage \_\_\_\_\_

**Please obtain the following information from the customer**

1. The number of times the turn signals are used on an average day: \_\_\_\_\_

2. The amount of time the low beam headlights are used on an average day: \_\_\_\_\_

**Section 2 - Repair History**

Has the Headlight Switch, Windshield Wiper Switch, Switch Body, Cable Reel, Ignition Switch, Ignition Lock or Steering Column ever been replaced?

Yes

No

Any other repairs that would require movement of the wiring under the steering column covers?

Yes

No

If answering "Yes" to either question explain briefly below. Include date and mileage if available.

---

---

---

---

---

---

---

---

---

---

**Please continue to Section 3 (next page)**

**Headlight Switch Worksheet**  
**02-03 Civic and 04-05 Pilot Headlight Switch**

**Section 3 - Vehicle Inspection**

**Please answer the following questions**

1. Turn the low beam headlights on. Does the vehicle have non-standard headlight bulbs (Halogen, HID, blue, etc.)?

Yes  No

If Yes please explain briefly:

---

---

Turn the headlights off.

2. Does the vehicle have an accessory security system?

Yes  No

If Yes, is it a Honda Genuine Accessory Security System or an aftermarket system?

---

3. Does the vehicle have fog lights?

Yes  No

If Yes, are they Honda Genuine Accessory Fog Lights or aftermarket fog lights?

---

4. Have any wires been spliced into the Ignition Switch Harness?

Yes  No

If Yes please explain briefly:

---

5. Was any abnormality of the wire layout noted in step 4 of the bulletin?

Yes  No

If Yes please explain briefly:

---

6. Was any heat damage noted in step 10 of the bulletin?

Yes  No

**Please take one clear photograph of each page of this worksheet (two photographs total of the worksheet) to be submitted with the warranty claim.**