

21. Exploded View and Replacement Parts List

21.1 Indoor Unit

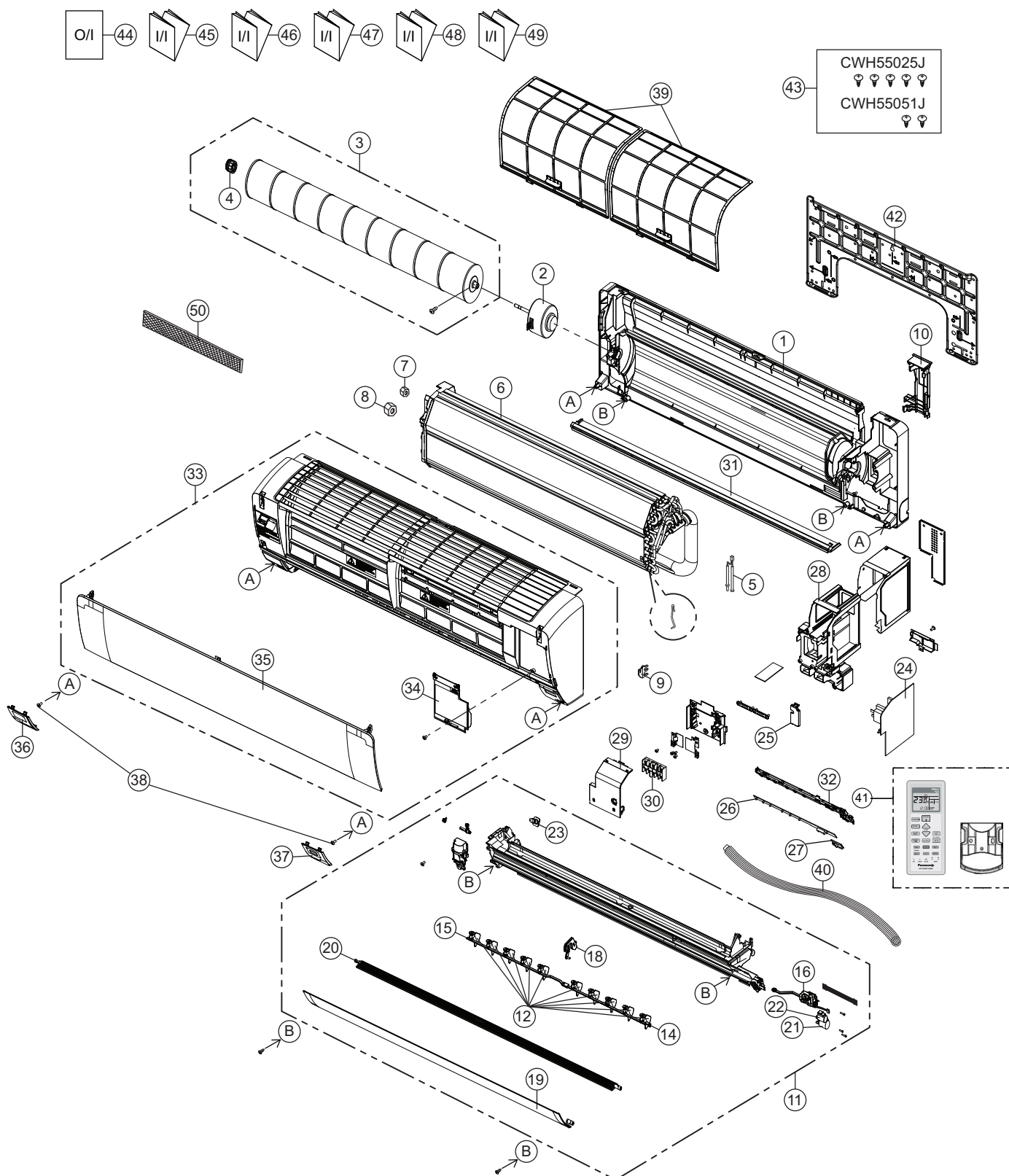





Note
 The above exploded view is for the purpose of parts disassembly and replacement.
 The non-numbered parts are not kept as standard service parts.

SAFETY	REF. NO.	PART NAME & DESCRIPTION	QTY	CS-HZ9RKE-1	CS-HZ9RKE-5	REMARK
	1	CHASSY COMPLETE	1	CWD50C1893	←	
	2	FAN MOTOR, DC 40W 3PH	1	ARW7676ACCB	←	O
	3	CROSS - FLOW FAN CO.	1	CWH02C1137	←	
	4	BEARING ASSY	1	CWH64K1010	←	O
	5	SENSOR COMPLETE	1	CWA50C2122	←	O
	6	EVAPORATOR CO.	1	CWB30C5060	←	
	7	FLARE NUT (LIQUID)	1	CWT251030	←	
	8	FLARE NUT (GAS)	1	CWT251031	←	
	9	HOLDER SENSOR	1	CWH32142	←	
	10	BACK COVER CHASSIS	1	CWD933463B	←	
	11	DISCHARGE GRILLE COMPLETE	1	CWE20C3560	←	
	12	VERTICAL VANE	10	CWE241389	←	
	14	CONNECTING BAR	1	CWE261261	←	
	15	CONNECTING BAR	1	CWE261262	←	
	16	AS MOTOR, DC SINGLE 12V 300 OHM	1	CWA98K1020	←	O
	18	FULCRUM	1	CWH621157	←	
	19	HORIZONTAL VANE COMPLETE	1	CWE24C1420	←	
	20	HORIZONTAL VANE COMPLETE	1	CWE24C1421	←	
	21	A.S.MOTOR, DC SINGLE 12V250 OHM	1	CWA981241	←	O
	22	A.S.MOTOR, DC SINGLE 12V250 OHM	1	CWA981299	←	O
	23	CAP - DRAIN TRAY	1	CWH521259	←	
	24	ELECTRONIC CONTROLLER - MAIN	1	ACXA73C08770	←	O
	25	ELECTRONIC CONTROLLER - RECEIVER	1	CWA746916	←	O
	26	ELECTRONIC CONTROLLER - INDICATOR	1	CWA747110	←	O
	27	ELECTRONIC CONTROLLER - FUSE	1	CWA748490	←	O
	28	CONTROL BOARD COVER CASING	1	CWH102456	←	
	29	CONTROL BOARD COVER CO.	1	CWH13C1286	←	
	30	TERMINAL BOARD CO	1	CWA28C2808	←	O
	31	PARTICULAR PLATE (FRONT GRILLE)	1	CWD912226	←	
	32	INDICATOR HOLDER	1	CWD933466	←	
	33	FRONT GRILLE COMPLETE	1	ACXE10C02130	←	O
	34	GRILLE DOOR	1	CWE14C1099	←	
	35	INTAKE GRILLE COMPLETE	1	CWE22K1605	←	
	36	DECORATION BASE ASS'Y (L)	1	CWE35K1135	←	
	37	DECORATION BASE ASS'Y (R)	1	CWE35C1182	←	
	38	SCREW - FRONT GRILLE	2	XTT4+16CFJ	←	
	39	AIR FILTER	2	CWD001326	←	O
	40	FLEXIBLE PIPE	1	CWH851173	←	
	41	REMOTE CONTROL COMPLETE	1	ACXA75C02250	←	O
	42	INSTALLATION HOLDER	1	CWH361134	←	
	43	BAG COMPLETE - INSTALLATION SCREW	1	CWH82C1705	←	
	44	OPERATING INSTRUCTION	1	ACXF55-04000	←	
	45	INSTALLATION INSTRUCTION (ENGLISH)	1	CWF616868	←	
	46	INSTALLATION INSTRUCTION (SWEDISH)	1	CWF616869	←	
	47	INSTALLATION INSTRUCTION (NORWEGIAN)	1	CWF616870	←	
	48	INSTALLATION INSTRUCTION (FINNISH)	1	CWF616871	←	

SAFETY	REF. NO.	PART NAME & DESCRIPTION	QTY	CS-HZ9RKE-1	CS-HZ9RKE-5	REMARK
	49	INSTALLATION INSTRUCTION (DANISH)	1	CWF616872	←	
	50	AIR FILTER COMPLETE	1	CWD00C1293	←	

(Note)

- All parts are supplied from PAPAMY, Malaysia (Vendor Code: 00029488).
- “O” marked parts are recommended to be kept in stock.

SAFETY	REF. NO.	PART NAME & DESCRIPTION	QTY	CS-AZ9RKE-1	CS-HZ12RKE-1	REMARK
	1	CHASSY COMPLETE	1	CWD50C1893	←	
	2	FAN MOTOR, DC 40W 3PH	1	ARW7676ACCB	←	O
	3	CROSS - FLOW FAN CO.	1	CWH02C1137	←	
	4	BEARING ASSY	1	CWH64K1010	←	O
	5	SENSOR COMPLETE	1	CWA50C2122	←	O
	6	EVAPORATOR CO.	1	CWB30C5060	←	
	7	FLARE NUT (LIQUID)	1	CWT251030	←	
	8	FLARE NUT (GAS)	1	CWT251031	←	
	9	HOLDER SENSOR	1	CWH32142	←	
	10	BACK COVER CHASSIS	1	CWD933463B	←	
	11	DISCHARGE GRILLE COMPLETE	1	CWE20C3560	←	
	12	VERTICAL VANE	10	CWE241389	←	
	14	CONNECTING BAR	1	CWE261261	←	
	15	CONNECTING BAR	1	CWE261262	←	
	16	AS MOTOR, DC SINGLE 12V 300 OHM	1	CWA98K1020	←	O
	18	FULCRUM	1	CWH621157	←	
	19	HORIZONTAL VANE COMPLETE	1	CWE24C1420	←	
	20	HORIZONTAL VANE COMPLETE	1	CWE24C1421	←	
	21	A.S.MOTOR, DC SINGLE 12V250 OHM	1	CWA981241	←	O
	22	A.S.MOTOR, DC SINGLE 12V250 OHM	1	CWA981299	←	O
	23	CAP - DRAIN TRAY	1	CWH521259	←	
	24	ELECTRONIC CONTROLLER - MAIN	1	ACXA73C08770	ACXA73C08780	O
	25	ELECTRONIC CONTROLLER - RECEIVER	1	CWA746916	←	O
	26	ELECTRONIC CONTROLLER - INDICATOR	1	CWA747110	←	O
	27	ELECTRONIC CONTROLLER - FUSE	1	CWA748490	←	O
	28	CONTROL BOARD COVER CASING	1	CWH102456	←	
	29	CONTROL BOARD COVER CO.	1	CWH13C1286	←	
	30	TERMINAL BOARD CO	1	CWA28C2808	←	O
	31	PARTICULAR PLATE (FRONT GRILLE)	1	CWD912226	←	
	32	INDICATOR HOLDER	1	CWD933466	←	
	33	FRONT GRILLE COMPLETE	1	ACXE10C02140	ACXE10C02130	O
	34	GRILLE DOOR	1	CWE14C1099	←	
	35	INTAKE GRILLE COMPLETE	1	CWE22K1605	←	
	36	DECORATION BASE ASS'Y (L)	1	CWE35K1135	←	
	37	DECORATION BASE ASS'Y (R)	1	CWE35C1182	←	
	38	SCREW - FRONT GRILLE	2	XTT4+16CFJ	←	
	39	AIR FILTER	2	CWD001326	←	O
	40	FLEXIBLE PIPE	1	CWH851173	←	
	41	REMOTE CONTROL COMPLETE	1	ACXA75C02250	←	O
	42	INSTALLATION HOLDER	1	CWH361134	←	
	43	BAG COMPLETE - INSTALLATION SCREW	1	CWH82C1705	←	
	44	OPERATING INSTRUCTION	1	ACXF55-04000	←	
	45	INSTALLATION INSTRUCTION (ENGLISH)	1	CWF616868	←	
	46	INSTALLATION INSTRUCTION (SWEDISH)	1	CWF616869	←	
	47	INSTALLATION INSTRUCTION (NORWEGIAN)	1	CWF616870	←	
	48	INSTALLATION INSTRUCTION (FINNISH)	1	CWF616871	←	

SAFETY	REF. NO.	PART NAME & DESCRIPTION	QTY	CS-AZ9RKE-1	CS-HZ12RKE-1	REMARK
	49	INSTALLATION INSTRUCTION (DANISH)	1	CWF616872	←	
	50	AIR FILTER COMPLETE	1	CWD00C1293	←	

(Note)

- All parts are supplied from PAPAMY, Malaysia (Vendor Code: 00029488).
- “O” marked parts are recommended to be kept in stock.

21.2 Outdoor Unit

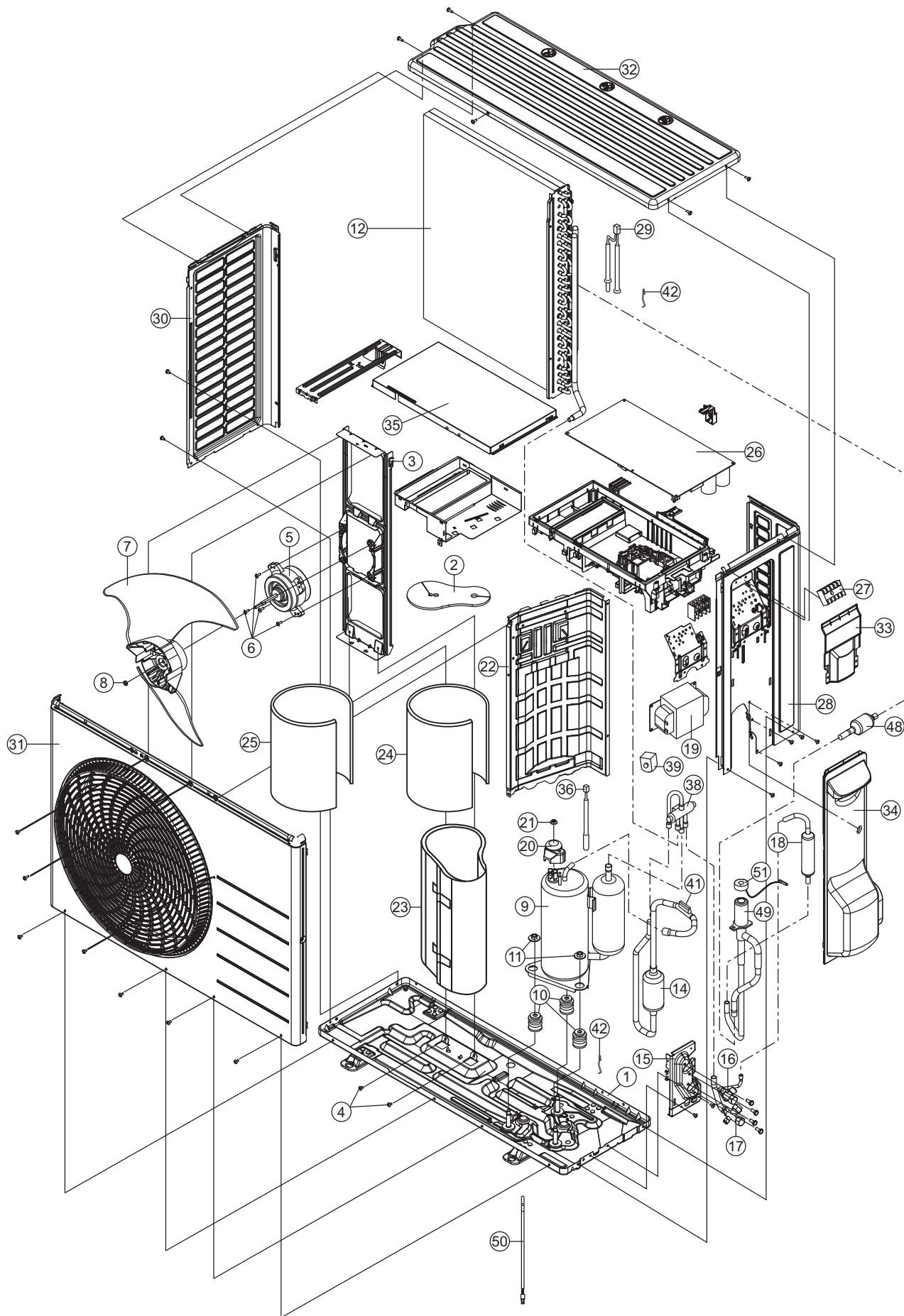

Note

The above exploded view is for the purpose of parts disassembly and replacement.
The non-numbered parts are not kept as standard service parts.

SAFETY	REF. NO.	PART NAME & DESCRIPTION	QTY	CU-HZ9RKE-1	CU-HZ9RKE-5	REMARK
	1	CHASSY ASS'Y	1	CWD52K1359	←	
	2	SOUND PROOF MATERIAL	1	CWG302630	←	
	3	FAN MOTOR BRACKET	1	CWD541167	←	
	4	SCREW - FAN MOTOR BRACKET	2	CWH551217	←	
⚠	5	FAN MOTOR, DC 40W 3PH	1	ARS6411AC	←	O
	6	SCREW - FAN MOTOR MOUNT	4	CWH55252J	←	
	7	PROPELLER FAN ASSY	1	CWH03K1066	←	
	8	NUT - PROPELLER FAN	1	CWH56053J	←	
⚠	9	COMPRESSOR	1	9RD132XAB21	←	O
	10	ANTI - VIBRATION BUSHING	3	CWH50077	←	
	11	NUT - COMPRESSOR MOUNT	3	CWH561096	←	
	12	CONDENSER COMPLETE	1	CWB32C4300	CWB32C4301	
	14	DISCHARGE MUFFLER	1	CWB121010	←	
	15	HOLDER - COUPLING	1	CWH351233	←	
	16	2-WAYS VALVE	1	CWB021589	←	O
	17	3-WAYS VALVE	1	CWB011374	←	O
	18	ACCUMULATOR	1	CWB131065	←	
⚠	19	REACTOR	1	G0C193J00004	←	O
	20	TERMINAL COVER	1	CWH171039A	←	
	21	NUT - TERMINAL COVER	1	CWH7080300J	←	
	22	SOUND - PROOF BOARD	1	CWH151273	←	
	23	SOUND PROOF MATERIAL	1	CWG302952	←	
	24	SOUND PROOF MATERIAL	1	CWG302745	←	
	25	SOUND PROOF MATERIAL	1	CWG302740	←	
⚠	26	ELECTRONIC CONTROLLER - MAIN	1	ACXA73C08790R	←	O
⚠	27	TERMINAL BOARD ASS'Y	1	CWA28K1110J	←	
	28	CABINET SIDE PLATE CO.	1	CWE04C1481	←	
	29	SENSOR - COMPLETE (OUTDOOR & PIPING TEMP)	1	CWA50C3079	←	O
	30	CABINET SIDE PLATE (L)	1	CWE041616A	←	
	31	CABINET FRONT PLATE - CO.	1	CWE06C1441	←	
	32	CABINET TOP PLATE	1	CWE031148A	←	
	33	PLATE - C.B.COVER	1	CWH131470	←	
	34	CONTROL BOARD COVER - COMPLETE	1	CWH13C1253	←	
	35	CONTROL BOARD COVER	1	CWH131473	←	
	36	SENSOR - COMPLETE (COMP. TEMP)	1	CWA50C2894	←	O
	38	4-WAYS VALVE	1	CWB001063	←	O
⚠	39	V-COIL COMPLETE - 4-WAY VALVE	1	CWA43C2431	←	O
	41	HOLDER - SENSOR	1	CWH32075	←	
	42	HOLDER - SENSOR	2	CWH32143	←	
	48	STRAINER	1	CWB11094	←	
	49	EXPANSION VALVE	1	CWB051078	←	O
	50	CRANKCASE HEATER	1	CWA341072	←	
⚠	51	V-COIL COMPLETE - EXP. VALVE	1	CWA43C2603	←	O

(Note)

- All parts are supplied from PAPAMY, Malaysia (Vendor Code: 00029488).
- "O" marked parts are recommended to be kept in stock.

SAFETY	REF. NO.	PART NAME & DESCRIPTION	QTY	CU-AZ9RKE-1	CU-HZ12RKE-1	REMARK
	1	CHASSY ASS'Y	1	CWD52K1359	←	
	2	SOUND PROOF MATERIAL	1	CWG302630	←	
	3	FAN MOTOR BRACKET	1	CWD541167	←	
	4	SCREW - FAN MOTOR BRACKET	2	CWH551217	←	
⚠	5	FAN MOTOR, DC 40W 3PH	1	ARS6411AC	←	O
	6	SCREW - FAN MOTOR MOUNT	4	CWH55252J	←	
	7	PROPELLER FAN ASSY	1	CWH03K1066	←	
	8	NUT - PROPELLER FAN	1	CWH56053J	←	
⚠	9	COMPRESSOR	1	9RD132XAB21	←	O
	10	ANTI - VIBRATION BUSHING	3	CWH50077	←	
	11	NUT - COMPRESSOR MOUNT	3	CWH561096	←	
	12	CONDENSER COMPLETE	1	CWB32C4300	←	
	14	DISCHARGE MUFFLER	1	CWB121010	←	
	15	HOLDER - COUPLING	1	CWH351233	←	
	16	2-WAYS VALVE	1	CWB021589	←	O
	17	3-WAYS VALVE	1	CWB011374	←	O
	18	ACCUMULATOR	1	CWB131065	←	
⚠	19	REACTOR	1	G0C193J00004	←	O
	20	TERMINAL COVER	1	CWH171039A	←	
	21	NUT - TERMINAL COVER	1	CWH7080300J	←	
	22	SOUND - PROOF BOARD	1	CWH151273	←	
	23	SOUND PROOF MATERIAL	1	CWG302952	←	
	24	SOUND PROOF MATERIAL	1	CWG302745	←	
	25	SOUND PROOF MATERIAL	1	CWG302740	←	
⚠	26	ELECTRONIC CONTROLLER - MAIN	1	ACXA73C08790R	ACXA73C08800R	O
⚠	27	TERMINAL BOARD ASS'Y	1	CWA28K1110J	←	
	28	CABINET SIDE PLATE CO.	1	CWE04C1481	←	
	29	SENSOR - COMPLETE (OUTDOOR & PIPING TEMP)	1	CWA50C3079	←	O
	30	CABINET SIDE PLATE (L)	1	CWE041616A	←	
	31	CABINET FRONT PLATE - CO.	1	CWE06C1441	←	
	32	CABINET TOP PLATE	1	CWE031148A	←	
	33	PLATE - C.B.COVER	1	CWH131470	←	
	34	CONTROL BOARD COVER - COMPLETE	1	CWH13C1253	←	
	35	CONTROL BOARD COVER	1	CWH131473	←	
	36	SENSOR - COMPLETE (COMP. TEMP)	1	CWA50C2894	←	O
	38	4-WAYS VALVE	1	CWB001063	←	O
⚠	39	V-COIL COMPLETE - 4-WAY VALVE	1	CWA43C2431	←	O
	41	HOLDER - SENSOR	1	CWH32075	←	
	42	HOLDER - SENSOR	2	CWH32143	←	
	48	STRAINER	1	CWB11094	←	
	49	EXPANSION VALVE	1	CWB051078	←	O
	50	CRANKCASE HEATER	1	CWA341072	←	
⚠	51	V-COIL COMPLETE - EXP. VALVE	1	CWA43C2603	←	O

(Note)

- All parts are supplied from PAPAMY, Malaysia (Vendor Code: 00029488).
- "O" marked parts are recommended to be kept in stock.

Printed in Malaysia
SZ0916-0