

Rinnai

SERVICE MANUAL

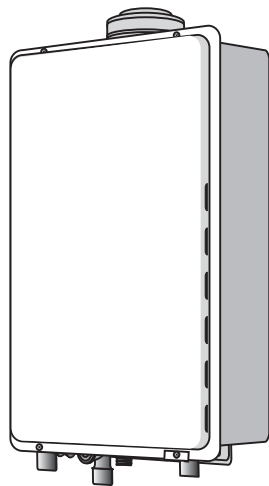

To Suit Models:

**REU-V2632FFUG
REU-VM2632FFUC**

Does NOT Suit Other Models



The Australian
Gas Association

All Rinnai products are certified by the Australian Gas Association as compliant to relevant Australian Standards.



Distributed and serviced in Australia under a Quality System certified as complying with ISO 9001 by SAI Global

Rinnai Australia Head Office is certified as complying with ISO 9001 by SAI Global.



Quality
Endorsed
Company

ISO 9001 Reg 415

Rinnai New Zealand has been certified to ISO 9001 Quality Assurance by Telarc.

Certified
Product



WaterMark

AS3498 Lic W208
SAI Global

All Rinnai products are Certified to WaterMark by SAI Global. WaterMark certification is awarded to products and fittings complying with safety and water contamination standards.

Glossary of Terms and Symbols

dB(A)	-	sound pressure level in decibels, “A” range
DC	-	direct current
AC	-	alternating current
WFCD	-	water flow control device
FB	-	feedback information
FF	-	feed forward information
Hz	-	Hertz
IC	-	integrated circuit
kcal/h	-	kilocalorie per hour
kPa	-	kilopascals
LED	-	light emitting diode
L/min	-	Litres per minute
mA	-	milliamps
MJ/h	-	megajoule per hour
mm	-	millimetres
mmH ₂ O	-	millimetres of water (gauge pressure)
OHS	-	overheat switch
PCB	-	printed circuit board
CPU	-	central processing unit
POT	-	potentiometer
rpm	-	revolutions per minute
SV	-	solenoid valve
∅	-	diameter
Δ °C	-	temperature rise above ambient
POV	-	modulating valve
TE	-	thermal efficiency
TH	-	thermistor
T _{IN}	-	temperature of incoming water
T _{OUT}	-	temperature of outgoing water

© Copyright Rinnai Australia Pty Ltd ABN 74 005 138 769
All rights reserved
Produced by Engineering & Technical Group

No portion or part of this manual may be copied without prior permission from Rinnai Australia.

Rinnai Australia reserves the right to make modifications and change specifications without notice.



W A R N I N G



Failure to comply with these instructions may result in serious personal injury or damage to the appliance.



- **All wiring inside this appliance may be at 240 Volts potential.**
- **All service work must be carried out by an authorised person.**

This manual has been published by Rinnai Australia Engineering & Technical Group.

We welcome users of this manual to provide feedback and suggestions for improvement purposes.

Table of Contents

Glossary of Terms and Symbols	iii
1. Specifications	1
2. Water Flow Rates and Pressures	3
3. Dimensions	4
4. Water Controllers	5
5. Smartstart	7
6. Operational Flow Chart	8
7. Cutaway Diagram	10
8. Operation Principles	11
9. Main Components	12
10. Time Charts	13
11. Wiring Diagram	14
12. Component Circuit Value Table	15
13. Dip Switch Settings	16
14. Fault Finding	17
15. Component and Circuit Checks	19
16. Maintenance Monitor / Error History	24
17. Gas Pressure Setting Procedure	27
18. Gas Conversion Procedure	27
19. Dismantling for Service	29
20. Parts List	37
21. Exploded Diagram	41
SERVICE CONTACT POINTS	45

1. Specifications

Rinnai model number	REU-V2632FFUG REU-VM2632FFUC	
Type of appliance	Temperature controlled continuous flow gas hot water system	
Combustion system	Room sealed, fan forced combustion	
Installation	Internal	
Dimensions	Width	350 mm
	Height	600 mm
	Depth	259 mm
Weight	21 kilograms	
Gas consumption (Min. / Max.)	Natural gas:	16~195 MJ/h
	Propane gas:	16~195 MJ/h
Connections	Gas connection	R3/4 (20A)
	Cold water connection	R3/4 (20A)
	Hot water connection	R 3/4 (20A)
Ignition system	Direct electronic ignition	
Electrical consumption	Normal	45 W
	Standby	2 W (with 1 water controller)
Delivery Temperatures	40°C, 42°C, 50°C, 55°C, 65°C, 75°C & 85°C (set by combination of dip switches on PCB)	
Water flow control	Water flow sensor, electronic water flow control device and electronic By-Pass flow control device.	
Maximum hot water capacity, raised @ 25°C	26 L/min	
Water pressure required to achieve maximum water flow	140 kPa	
Minimum water flow for operation	2.4 L/min	
Power supply	Appliance - AC 240 Volts 50 Hz Water controller - DC 12 Volts	
Water controllers (optional)	1. Up to 4 controllers can be fitted. See below for the combination limitation of water controllers	
	2. Wireless controllers can be fitted in the same manner of MC-91Q-2A	
	Kitchen control	MC-100V-1A or MC-91Q-2A
	Bathroom control	BC-100V-1A or MC-91Q-2A
	Second bathroom control	BC-100V-1A or MC-91Q-2A
	Third bathroom control	MC-91Q-2A
Water Controller Cable (Supplied with controller)	Non-polarized two core cable.	

Sensors and Safety Functions

- **Hot Water Delivery Thermistor:** Measures hot water temperature at the appliance outlet connection (i.e. the 'mixed' temperature).
- **Flame Rod:** Monitors combustion characteristics inside the combustion chamber. If the flame fails, gas supply is stopped.
- **Overheat Switch:** Situated on the heat exchanger, gas supply is stopped when water temperature reaches 97°C for a number of seconds.
- **Fusible Link:** Situated on the heat exchanger, electrical power supply is stopped if the temperature exceeds 129°C.
- **Water Pressure Relief Valve:** Safeguards the water circuit against excessive inlet pressure. Opens at 2060 kPa, closes at 1470 kPa.
- **Electrical Fuse:** (3A glass fuse) prevents against over-current.
Surge Protector: prevents against over-current.
- **Boil Dry Prevention:** If water flow sensor detects no flow, gas supply is stopped.
- **Combustion Fan Speed Sensor:** In case of combustion fan defect (no rotation of fan) gas supply is stopped.
- **Temperature Cutout:** If the delivered hot water temperature rises above the required delivery temperature for a number of seconds, the gas supply is stopped.

Combustion Specifications

See dataplate on appliance.

2. Water Flow Rates and Pressures

Water flow rate and pressure characteristics as shown below.

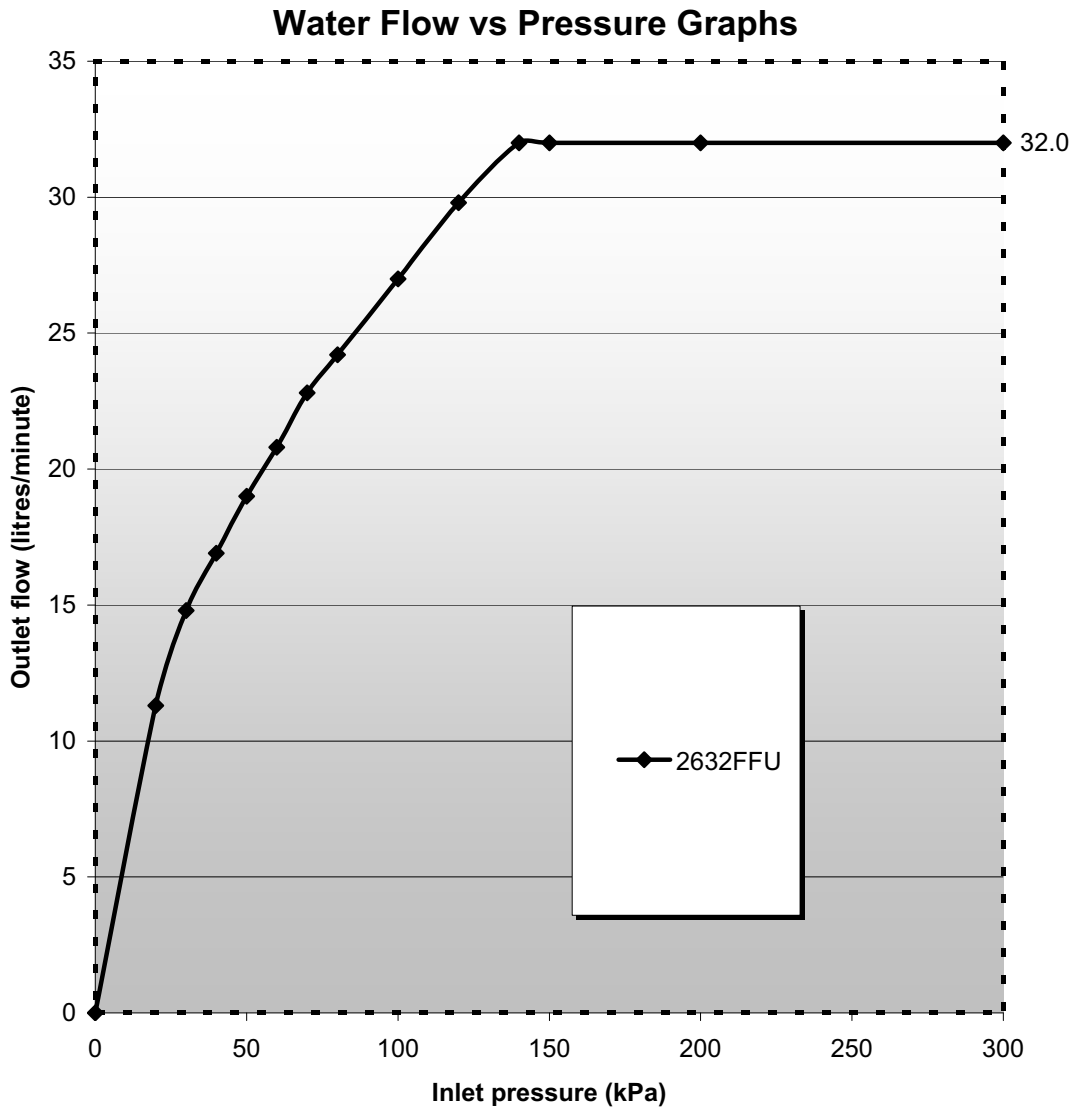

REU-V2632WC & FFU														
P(kPa)	0	20	30	40	50	60	70	80	100	120	140	150	200	300
Q(L/min)@Tset37	0	11.3	14.8	16.9	19	20.8	22.8	24.2	27	29.8	32	32	32	32
Q(L/min)@Tset60	0	6.4	10.4	13	15	16.5	18	19.4	21	22.5	23.5	23.8	24	

3. Dimensions

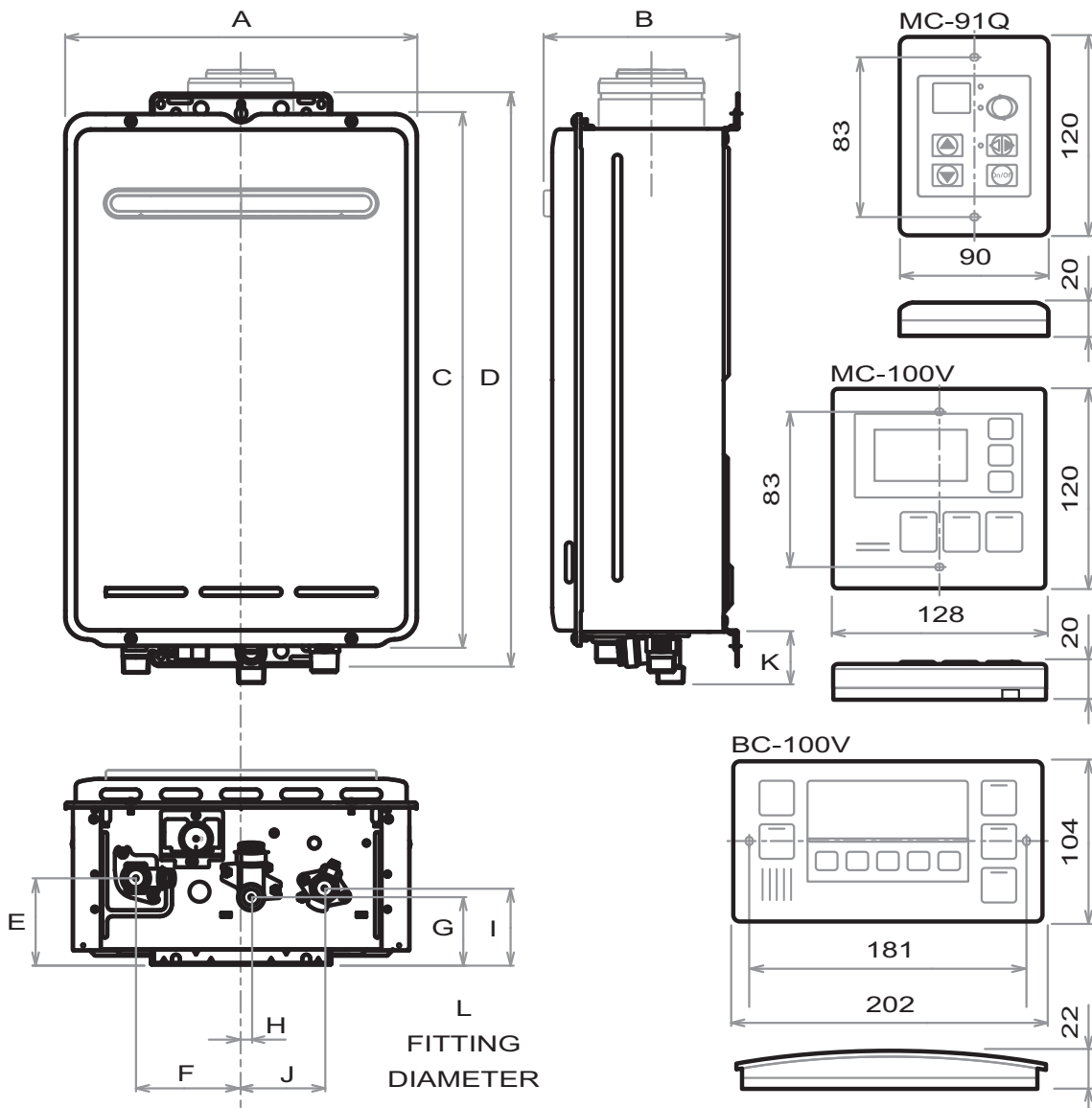

Dimensions	Description	REU-V2632FFUG REU-VM2632FFUC
A	Width	350
B	Depth	234.5 ~ 274.5
C	Height - Unit	600
D	Height - Including Brackets	641
E	Hot Water outlet (from wall)	91 ~ 131
F	Hot Water outlet (from centre)	110
G	Cold Water inlet (from wall)	70 ~ 110
H	Cold Water inlet (from centre)	27 *
I	Gas Connection (from wall)	99 ~ 139
J	Gas Connection (from centre)	89
K	Gas: Length (from base)	41
	Cold: Length (from base)	51
	Hot: Length (from base)	42
L	Gas: Fitting Diameter	20
	Cold: Fitting Diameter	20
	Hot: Fitting Diameter	20

* Please note that this measurement is to the left of the centre line.

4. Water Controllers



A
1
1

water controllers must be installed in accordance with the relevant operation/installation instructions supplied with the water heater or controllers.



Care should be taken to ensure power supply to the Infinity is isolated when connecting / disconnecting controller wiring or transponder on wireless controllers. Failure to isolate power supply may result in damage to the appliance PCB.

Care should be taken when closing the Ezi-connect access panel, to ensure internal wiring for controllers is not shortened or crushed.

Troubleshooting

Water Controller not showing display - (Wired Water Controllers)

- Check that the correct number and combination of controllers have been installed for the specific model Infinity. Refer to controller compatibility table below.
- Check water controller is turned ON.
- Check there is 12VDC power supply available to the controller from the Ezi-connect terminals.
- If there is 12VDC available from the Ezi Connect but no controller display, check wiring between Ezi-connect and controller is sound.
- If there is no power from the Ezi-connect terminals, but the hot water functions correctly, replace PCB.

Error Code 12 as soon as hot water tap is turned ON.

- Check 12VDC internal wiring to Ezi-connect terminal is not crushed or shorted.
- Rectify wiring and re-close Ezi-connect cover carefully.

Water Controller not showing display - (Wireless Water Controllers)

- Ensure transceiver module is mounted in the correct location, as per wireless controller installation instructions.
- Ensure 2 x AA batteries are in good working order and installed with the correct polarity within the wireless controller. (Battery polarity details on rear of wireless controller)
- Ensure distance between wireless controller and transceiver does not exceed 50 metres.
- Ensure channel has been allocated to each wireless controller.
- Ensure wireless controller has been programmed to the transceiver correctly, as per wireless controller installation instructions.

Water Controller Compatibility Table

Wireless Only Installation	A maximum of 4 wireless water controllers can be fitted with the following limitation: Only ONE MC-502RC / MC-503RC can be set as the Master Controller.
Wired & Wireless Installations	A maximum of 4 water controllers can be fitted. Any combination of deluxe, universal and wireless controllers can be used with the following limitation: Only ONE master controller can be installed. This can be a MC-100V, a MC-91Q (when programmed as a master controller) or a MC-502RC/MC-503RC water controller. Up to TWO BC-100V water controllers can be installed. The FOURTH water controllers in any installation MUST BE a MC-502RC / MC-503RC or a MC91Q.

PROGRAMMING FOR THE 'UNIVERSAL' WATER CONTROLLER (MC-91Q)



QUESTION

1 Are there four water controllers connected?

IF NO: (You have three water controllers or fewer), go to Question 2.

IF YES: You will need to activate the fourth water controller as follows:

STEP 1: For the water controller in the KITCHEN ONLY, press and hold the 'Transfer' and 'On/Off' buttons simultaneously (see Fig. 5) until a 'beep' is heard (approximately 5 seconds).

STEP 2: Check that the display on ALL FOUR water controllers is lit and displaying a temperature when 'switched on'. If any ONE of the controller displays two dashes (see Fig. 6) repeat STEP 1.

This completes the activation procedure for the fourth controller, you may ignore Question 2.

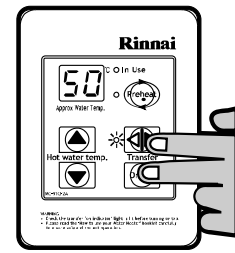

Fig. 5



Fig. 6



QUESTION

2 Is the water heater marked to state it delivers water not exceeding 50°C?

IF YES: No further action required.

IF NO: You will need to program the kitchen controller to enable selection of temperatures higher than 50°C.

STEP 1: For the controller in the KITCHEN ONLY, press and hold the 'Transfer' and 'On/Off' buttons simultaneously (Fig. 7) until a 'beep' is heard (approximately 5 seconds).

STEP 2: When the controller fitted in the KITCHEN is switched On, it should be possible to select temperatures higher than 50°C. If not, repeat STEP 1.

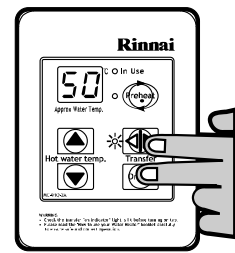

Fig. 7



NOTE

If the water controller in the kitchen is replaced, repeat STEP 1 above for the replacement controller.

If the water controller in the kitchen is swapped with another controller (for example, the controller fitted in a bathroom), repeat STEP 1 for the controller moved from the kitchen to the bathroom. Then perform STEP 1 for the controller moved from bathroom to the kitchen.

5. Smartstart

At least one temperature controller model MC-91Q must be used in conjunction with the water heater and the Smartstart® system. Alternatively, if water controllers cannot be used a manual activation switch must be used. Water Controllers cannot be used with the REU-V2426WS model.

At least one water controller model MC-91Q must be used in conjunction with the water heater and the Smartstart® system. Alternatively, if water controllers cannot be used a manual activation switch is available. Refer to the installation manual for the Smartstart® system.

The installation of the water heater and water controllers must be performed in accordance with the operating/installation instructions supplied with the water heater.

The Smartstart® system is designed for domestic installations. However, it may be suitable for certain non domestic installations.

Principle of operation

The "Smartstart®" system heats the water in the pipework water connected between the water heater and the hot water outlets before any outlets are opened using the 'flow and return' pipework principle. This results in water savings and reduced waiting time for heated water delivery from the outlet when opened.

Traditional 'flow and return' systems usually keep the water in the pipework heated continuously. The Smartstart® system however, only heats the water before the outlet is opened. This results in significant energy savings because water is not heated unnecessarily whilst retaining the benefits of traditional flow and return systems.

A schematic of the Smartstart® system installed in conjunction with a Rinnai continuous flow water heater and water controller as shown below.

If problems are experienced with Smartstart® operation refer to the Smartstart® Service Manual.

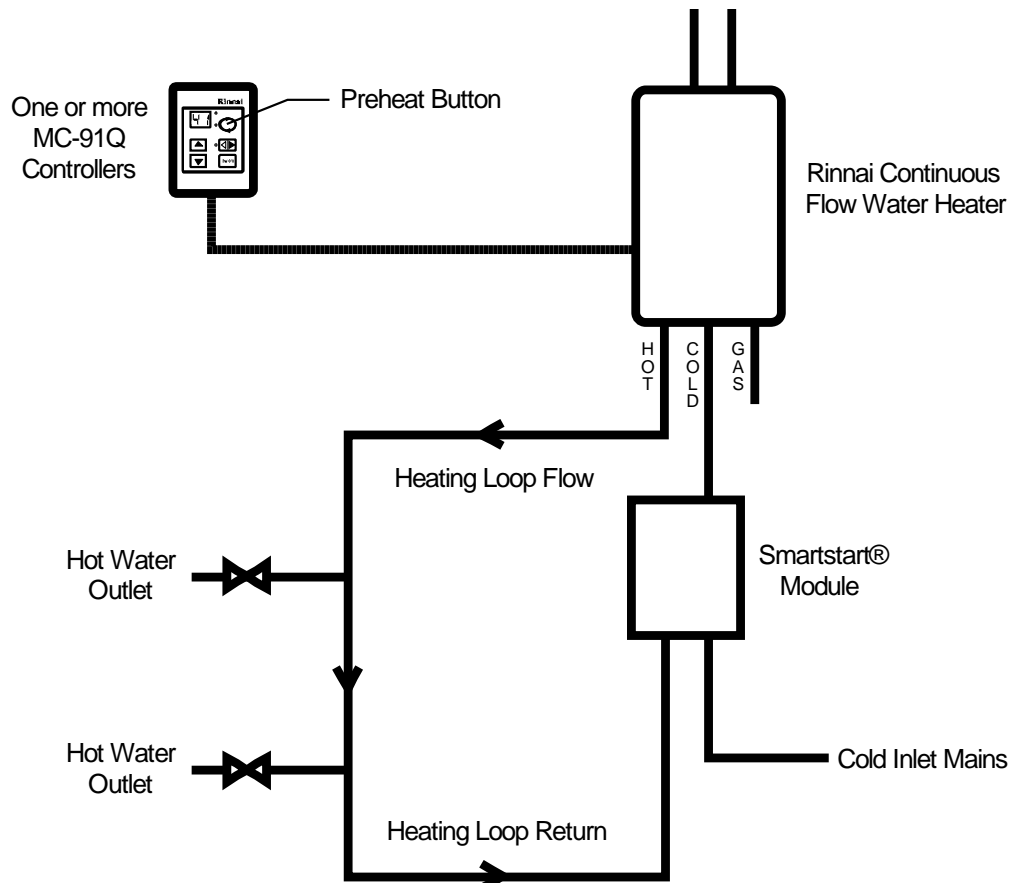

6. Operational Flow Chart

REU-V2632FFUG/VRM2632FFUC

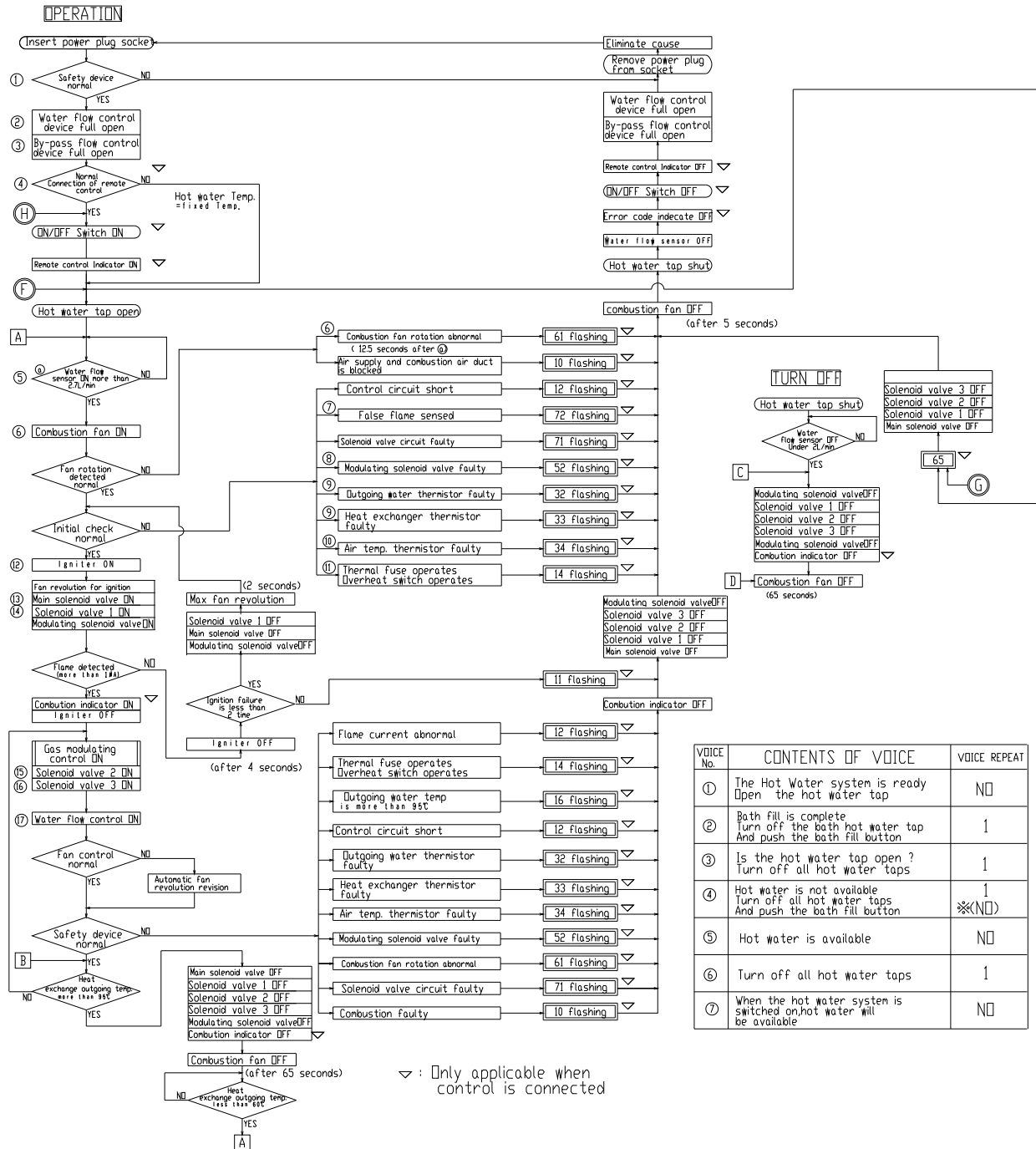

Operational Flow Chart - Continued

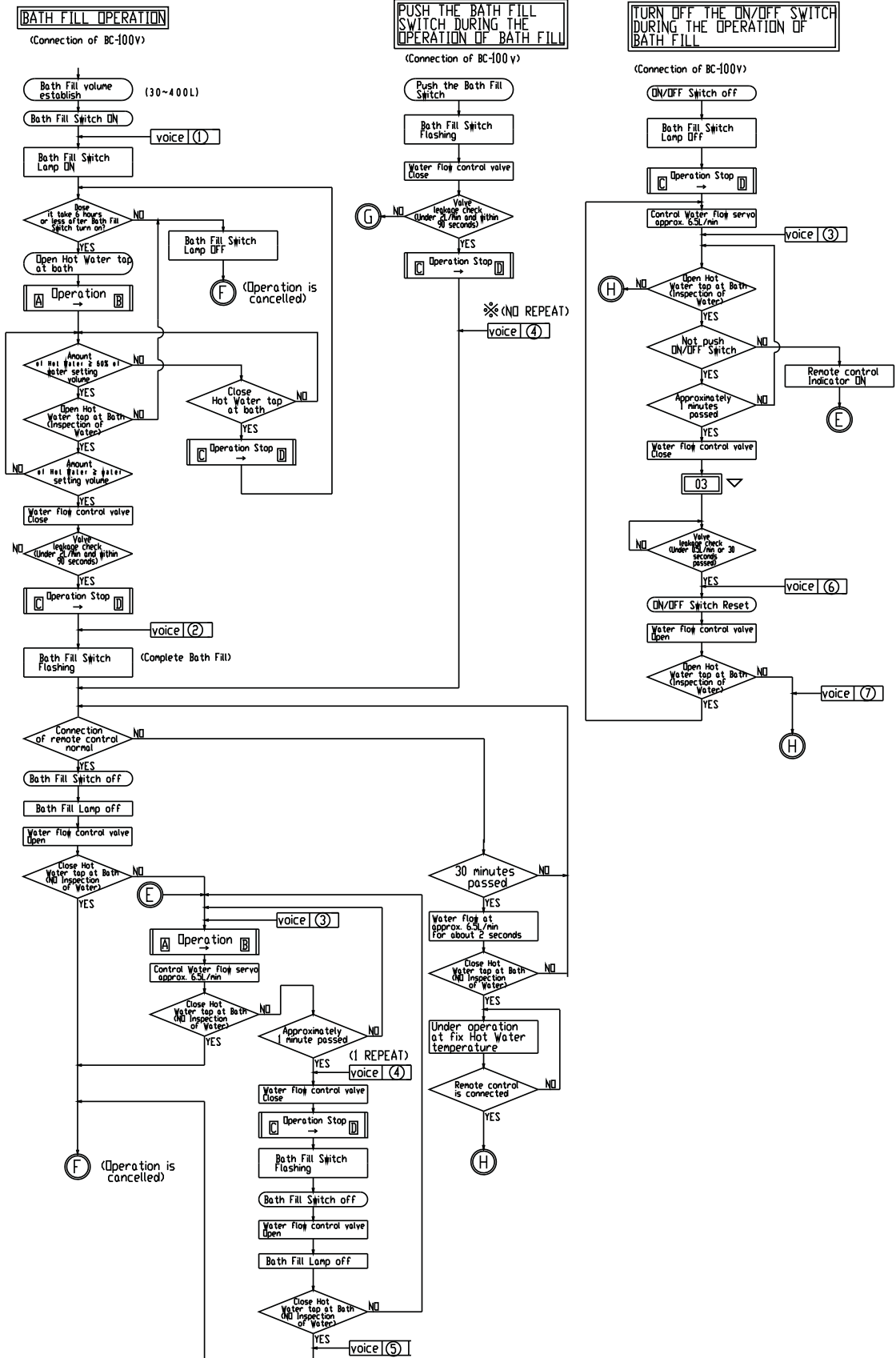

7. Cutaway Diagram

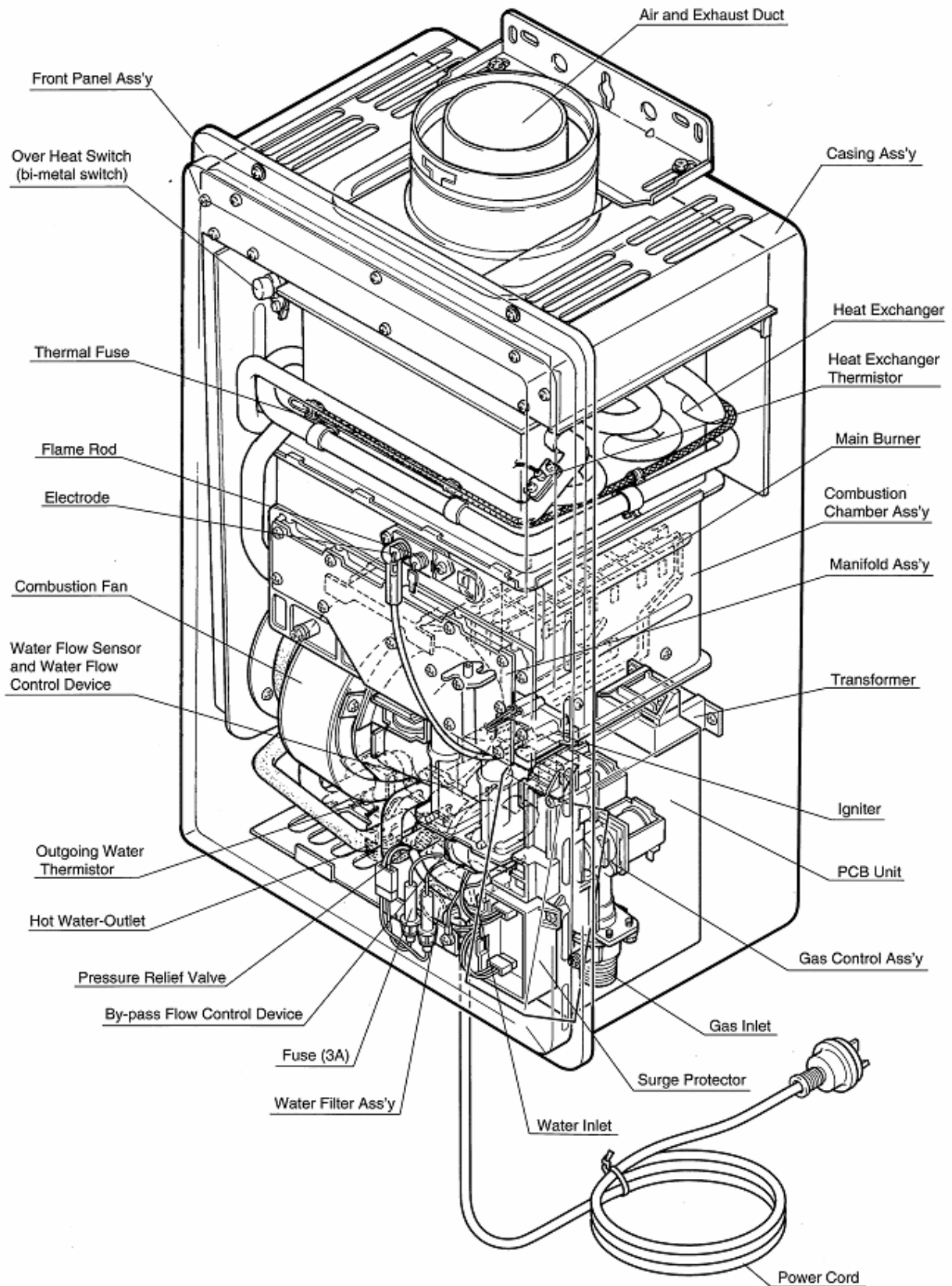

8. Operation Principles

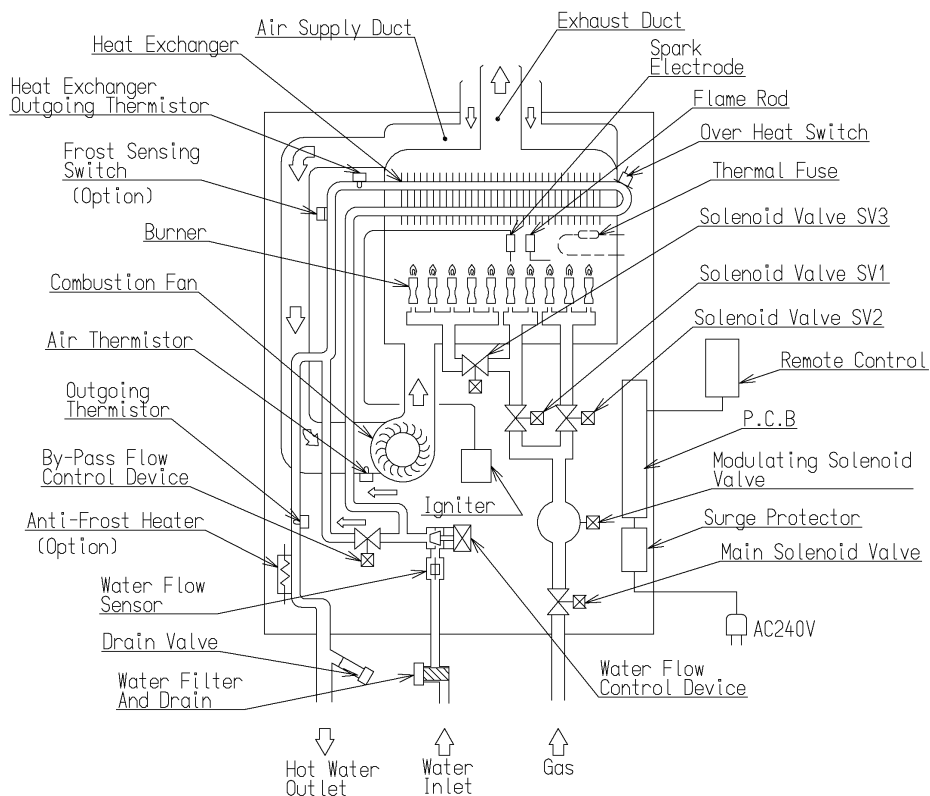

Hot Water Operation

1. Ignition

- Activate water controllers (if fitted) and open the hot water tap (for full details regarding operation of controllers refer to the 'Customer Operation/Installation manual' supplied with water heater).
- When water flows through the unit, the water flow sensor rotates and sends an electrical 'pulse' signal to the Printed Circuit Board (PCB). This signal is proportional to the water flow rate.
- The PCB sends electrical current to the combustion fan motor causing it to turn. The fan motor sends an electrical pulse signal to the PCB. If fan rotation is OK, the main solenoid and changeover solenoid valves open as required, the spark generator activates and the spark electrode ignites the burner.

2. Water Temperature and Flow

- The PCB will automatically control operation of the internal components to achieve the programmed temperature. When a high temperature rise is required, the PCB may cause the Water Flow Servo to close partially resulting in a lower flow rate to achieve the programmed temperature. This is a necessary operational feature of the unit.
- When operating in 'Bath Fill' mode, the signal from the water flow sensor is also used by the PCB to compute the volume of water that has been passed through the unit at any instant whilst the bath is filling.

3. Shut Down

- When operating in 'Bath Fill' mode, the PCB causes the Water Flow Servo to close when the programmed Bath Fill volume has passed through the unit. Alternatively, flow is stopped when the user closes the hot water tap.
- When water flow stops, the water flow sensor stops rotating and the pulse signal to the PCB stops. The PCB then causes the main solenoid and solenoid valves to close and the burner is extinguished. The combustion fan will continue to operate for some time to purge the combustion chamber.

9. Main Components

1) Printed Circuit Board (PCB)

- The Printed Circuit Board controls all operational functions including Air Supply Control, Gas Control, Water Flow Measurement, Water Flow Control, Combustion System and all sensors and safety devices.

2) Gas Flow Control

- During normal operation, the PCB keeps the main solenoid valve open whilst there is flow through the unit and the burner needs to be lit.
- Gas flow rate is controlled by the modulating valve assembly and changeover solenoid valves to always ensure constant outlet water temperature, regardless of flow rate or incoming water temperature.
- The modulating valve is electronically controlled by the PCB using signals from the water flow sensor, water flow control device, bypass flow control device, water temperature thermistors and combustion fan speed sensor. The modulating valve directs gas to the changeover solenoid valves.
- The changeover solenoid valves direct gas to each of the three burner banks independently. Any of the solenoid valves may be open during operation.
- Gas flow is modulated by a combination of the modulating valve and changeover solenoid positions.
- The maximum gas rate is predetermined and the appliance cannot be overloaded when correctly installed.

3) Water Flow Control

- Water flow is detected by a turbine coupled to a magnetic pulse generating device. The magnetic pulses are detected and counted by the PCB. The PCB calculates the exact water flow from the frequency of pulses generated by the turbine, as well as the volume of water that has passed through the unit at any instant during 'Bath Fill' operation. A minimum flow rate of 2.4 l/min is required for the burner to ignite.
- Water flow control is achieved through the use of servo driven water flow and bypass valves. Both servo motors are controlled by the PCB. The 'Water Flow Valve' restricts the flow of water into the heat exchanger assembly if the programmed temperature cannot be achieved. Also, when the Bath Fill function is activated, flow of water is stopped when the bath is full. During normal operation, cold water from the inlet valve is mixed with hot water from the heat exchanger outlet. The 'Bypass Valve' mixes the correct proportion of cold and hot water to ensure accurate hot water delivery temperature over the available range of flow rates. The water flow and bypass valves are a combined assembly on the cold water inlet of the appliance.

4) Air Supply Control

- Air for combustion is supplied by a centrifugal fan driven by a variable speed DC motor. The voltage to the motor is determined by the PCB based on water flow, delivered water temperature and programmed water temperature. The actual fan speed is monitored by a magnetic pulse counter. This counter emits a signal to the PCB. From the voltage supplied to the DC motor and the fan speed signal, the PCB determines whether an error condition exists with the fan.

5) Combustion System

The combustion chamber is housed within the heat exchanger assembly and comprises:

- A multi chamber aluminium alloy manifold with multiple injectors, arranged in multiple rows. The middle chamber houses eight injectors, the left chamber, twelve, and the right chamber, multiple injectors. Gas flow to each chamber is controlled by an electronic solenoid valve (refer 'Gas Flow Control' above).
- A burner assembly comprising multiple identical modular stainless steel bunsen burners secured by an aluminised steel framework. The manifold is attached to the front of the burner module. Each bunsen burner is supplied by two injectors.
- A combustion chamber. Integrated into the combustion chamber front panel are the flame rod and ignition electrode(s).

11. Wiring Diagram

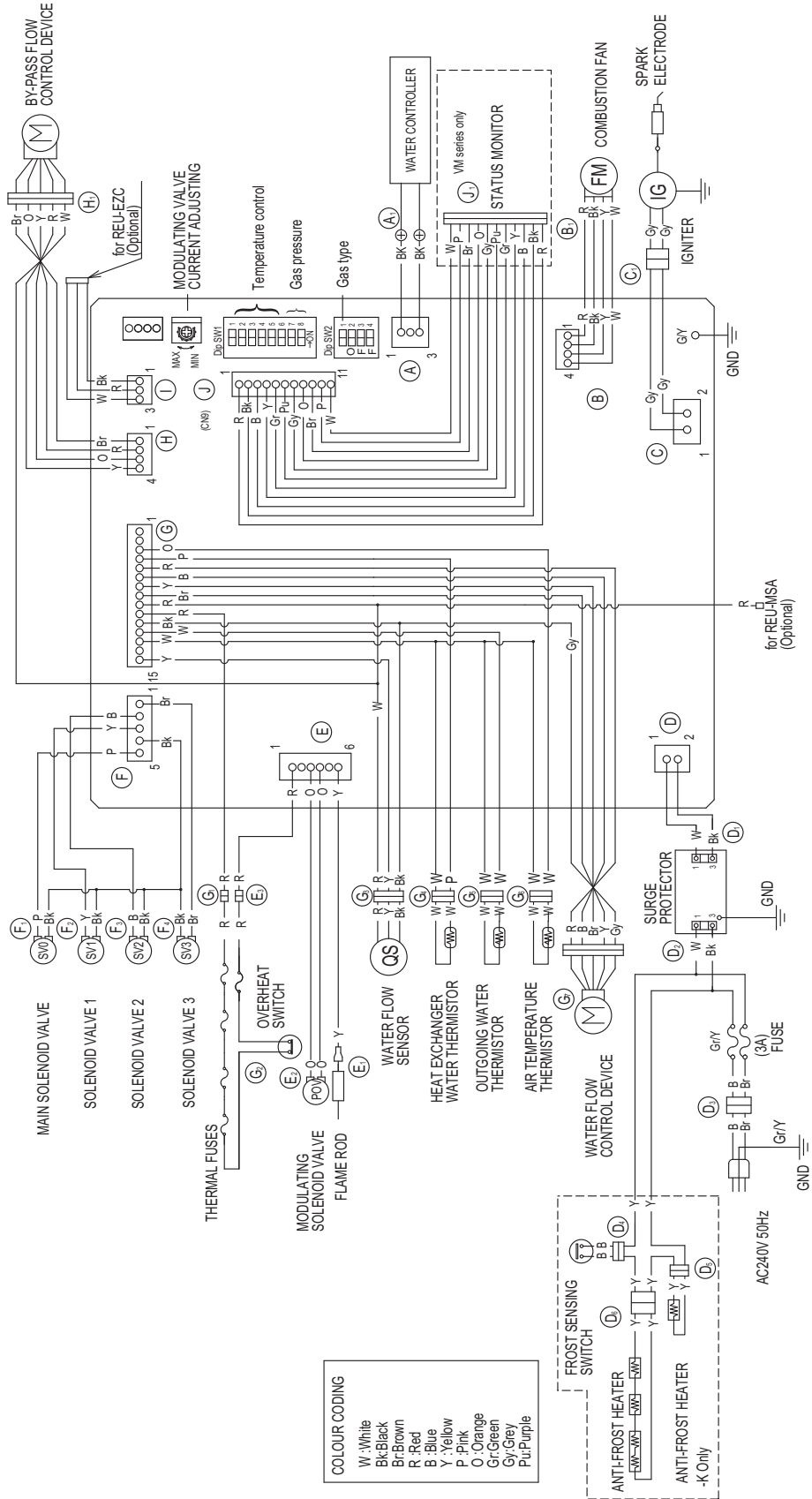

12. Component Circuit Value Table

FLOW CHART NO.	COMPONENT	MEASUREMENT POINT		NORMAL VALUE	NOTE
		CN	WIRE COLOUR		
①	SURGE PROTECTOR	D ₁	B-Br	AC207~264V	
② ⑬	WATER FLOW CONTROL DEVICE	G ₆	R-B	DC11~13V	OPERATE ELECTRICITY
			Gy-O	DC11~13V	CONTROL ELECTRICITY
			Gy-Y	BELOW DC1V (LIMITER ON)	FULL OPEN POSITION
				DC4~6V (LIMITER OFF)	
			Gy-Br	BELOW DC1V (LIMITER ON)	FULL CLOSE POSITION
DC4~6V (LIMITER OFF)					
③	BY-PASS FLOW CONTROL DEVICE	H ₁	Br-W O-W Y-W R-W GND	DC12V (OPERATING DC2~6V)	OPERATE CONDITION
			15~35 Ω		
④	WATER CONTROLLER	A ₁	Bk-Bk	DC11~13V	
⑤	WATER FLOW SENSOR	G ₃	R - Bk	DC11~13V	ON 2.7 L/min (30Hz) OVER 1800PULSE/min
			Y - Bk GND	DC4~7V (PULSE 17~460Hz)	OFF 2.0 L/min (20Hz) BELOW 1200PULSE/min
⑥	COMBUSTION FAN	B ₁	R - Bk	DC6~45V	
			Y - Bk	DC11~13V	
			W-Bk GND	DC6~45V (33~400 Hz)	
⑦	FLAME ROD	E ₁	Y - BODY EARTH	AC5~150V	AFTER IGNITION
			Y - FLAME ROD	OVER DC1μA	FLAME CONDITION
⑧	MODULATING VALVE	E ₂	P-P	DC2~15V 67~81Ω	
⑨	OUTGOING THERMISTOR	G ₅	W-W	15° C ... 11.4~14.0 kΩ 30° C ... 6.4~ 7.8 kΩ 45° C ... 3.6~ 4.5 kΩ 60° C ... 2.2~2.7 kΩ 105° C ... 0.6~0.8 kΩ	
⑩	HEAT EXCHANGER OUTGOING THERMISTOR	G ₄	W-P		
⑪	AIR THERMISTOR	G ₆	W-O		
⑫	THERMAL FUSE	G ₁	R-R	BELOW 1Ω	
		E ₃			
⑬	IGNITER	C ₁	Gy-Gy	AC207~264V	
⑭	MAIN SOLENOID VALVE	F ₁	P-Bk	DC11~13V 37~43Ω	
⑮	SOLENOID VALVE 1	F ₂	Y-Bk	DC11~13V 37~43Ω	
⑯	SOLENOID VALVE 2	F ₃	B-Bk	DC11~13V 37~43Ω	
⑰	SOLENOID VALVE 3	F ₄	Br-Bk	DC11~13V 35~41Ω	

13. Dip Switch Settings

Contact Rinnai for Dipswitch settings.

14. Fault Finding



If there is a fault with the appliance, and controllers are installed, a numerical fault code may appear on the digital display controller. If controllers are not installed, one may be fitted to find out the fault code. Fault finding without controllers (and thus fault codes) is possible but more time consuming.

To diagnose and rectify faults, the **Fault Finding Table** is used as illustrated below:

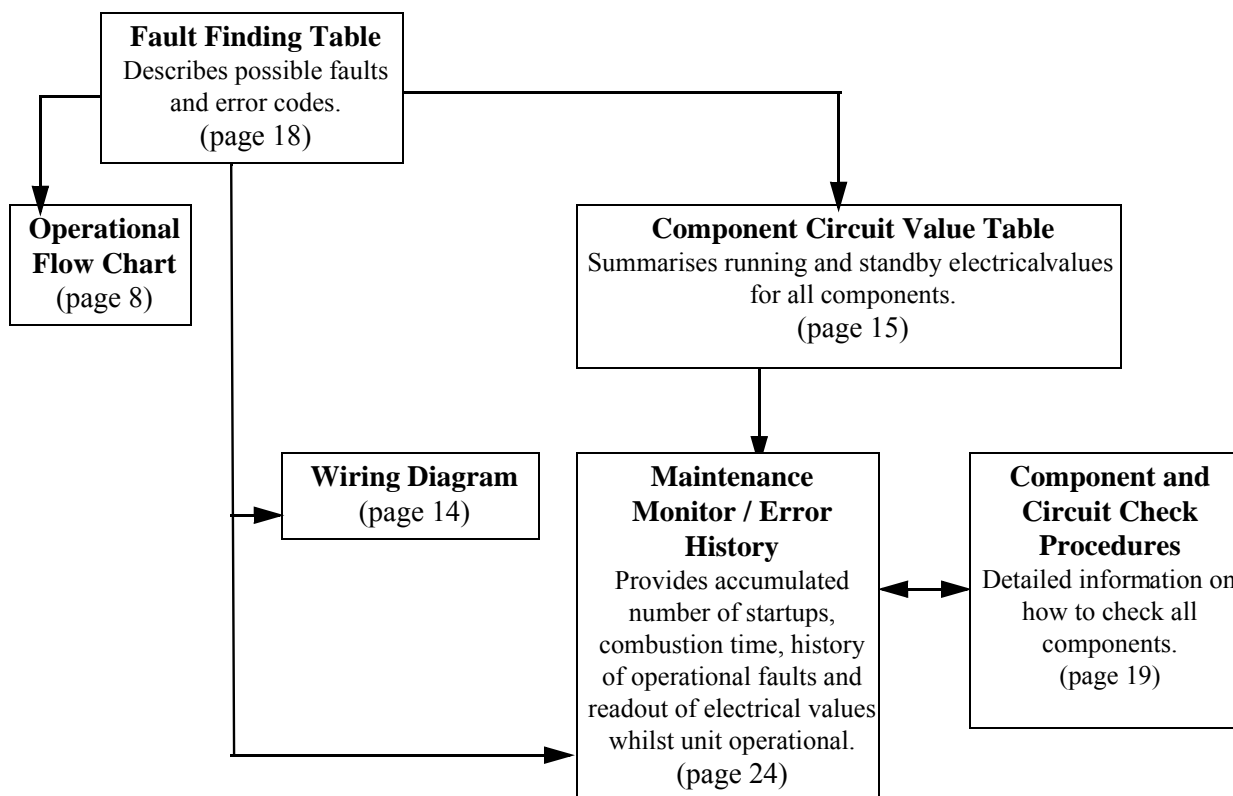

Fault Finding Table

Code on Water Controller	Fault	Action
03	Power interruption during Bathfill. Water will not flow when power restored.	1. Turn off all hot water taps. 2. Press the ON/OFF button on a controller twice.
10	Combustion fan current too high. Unit operates, then stops.	1. Check blockage of air intake/flue outlet. 2. Check combustion fan.
11	No ignition. Unit stops without flame igniting	1. Check gas supply 2. Check sparker unit 3. Check gas valves
12	Flame Failure / Earth Leakage	1. Check gas supply 2. Check flame rod 3. Check earth wire lead 4. Check water controller
14	Thermal fuse and/or overheat switch activated. Unit operates, then stops.	1. Check thermal fuse 2. Check overheat switch IMPORTANT- If thermal fuse or overheat switch were faulty: a. Check heater for damage b. Confirm "Gas Type" & "Combustion" dip switch settings. c. Confirm test point pressures.
16	Over temperature warning. Unit operates, then stops.	1. Confirm "Gas Type" and "Combustion" dip switch settings. 2. Confirm test point pressure. 3. Check gas valves 4. Check water flow sensor and water flow servo 6. Check heat exchanger outlet temperature thermistor 7. Check hot water outlet temperature thermistor
32	Outlet water thermistor flow	Check hot water outlet thermistor
33	Heat exchanger thermistor error	Check heat exchanger thermistor
52	Modulating solenoid valve fault. Unit stops without flame ignition.	Check modulating solenoid valve
61	Combustion fan rotation error	Check combustion fan
65	Water flow control device error. Water flow is not controlled. Water temperature too low.	Check water flow servo
71	Solenoid valve circuit error. Unit does not operate.	Check gas valves
72	Flame rod circuit error. Unit does not operate.	Check flame rod
-	Appliance does not operate at all. No display on the controllers (if fitted).	1. Check power cord plugged in and supply turned on. 2. Check power supply voltage. 3. Check electrical fuse. 4. Check transformer. 5. Check gas valves 6. Check sparker unit. 7. Check earth leads and connections. 8. Check for short circuits 9. Check water controller(s) - if fitted.
-	No combustion despite water controller indicating that combustion is occurring - if controller(s) fitted)	1. Check water flow sensor. 2. Check flame rod. 3. Check heat exchanger outlet thermistor. 4. Check hot water outlet thermistor. 5. Check combustion fan. 6. Check the sparker unit. 7. Check gas valves. 8. Check thermal fuse. 9. Check overheat switch. IMPORTANT - If thermal fuse or overheat switch were faulty: a) check heater for damage; b) confirm "Gas Type" and "Combustion" dip switch settings; c) confirm test point pressure.
-	Combustion stops during operation.	1. Check gas supply 2. Check flame rod 3. Check earth leads and connections.
-	Cannot adjust the hot water temperature via the water controller(s) - only if water controller(s) fitted.	1. Check hot water outlet thermistor. 2. Check heat exchanger outlet thermistor. 3. Check gas valves 4. Check water flow servo.
-	Anti-frost heater does not operate.	1. Check anti-frost heater components 2. Check frost sensing switch

15. Component and Circuit Checks



REU-V2632FFUG / REU-VM2632FFUC

1. Combustion Fan Circuit

Check the Motor

Check the combustion fan if the error indicator displays “61”.

Measure voltages between Black-Red of the PCB connector (**B₁**).

Normal: DC6~45V (when fan ON)

DC0V (when fan OFF)

If normal proceed to check the rotation sensor

Faulty: Replace PCB

Check for the Fan Rotation Sensor

a.) Measure voltages between Red-Black of connector (**B₁**)

Normal: DC11~13V

If normal proceed to b.).

Faulty: Replace PCB.

b.) Measure voltages between Black-White of connector (**B₁**)

Normal: DC6~45V (33~400Hz)

If normal proceed to Sparker Circuit 2.

Faulty: Replace Combustion Fan.

2. Sparker Circuit

a.) Measure voltages between Grey-Grey of connector (**C₁**).

Normal: AC207~264V

If Normal proceed to b.).

Faulty: Replace PCB.

b.) Disconnect connector (**C₁**) and measure voltage between both terminals of the sparker.

Normal: 1M Ω

If not sparking, adjust or replace ignition plug.

Faulty: Replace Sparker.

3a). Main Solenoid Valve (SV₀) Circuit (F₁)

Check the main solenoid if error indicator “11” is displayed.

a.) Disconnect Main Solenoid connector (**F₁**) and measure voltage between Pink-Black

Normal: DC11~13V

If normal, proceed to b.).

Faulty: Replace PCB.

b.) Measure resistant between Pink-Black of Main Solenoid connectors.

Normal: 37~43 Ω

If normal, proceed to Solenoid Valve SV₁

Faulty: Replace Main Solenoid.

REU-V2632FFUG / REU-VM2632FFUC

3b). Solenoid Valve 1 (SV₁) (F₂)

Check Solenoid 1 if error indicator “11” is displayed.

- a.) Disconnect Solenoid Valve 1 connector (F₂) and measure voltage between Red-Black.

Normal: DC11~13V

If normal, proceed to b.

Faulty: Replace PCB.

- b.) Measure resistance between Red-Black of Solenoid 1 connector.

Normal: 35~43Ω

If normal, proceed to Solenoid Valve 2 (SV₂) Circuit

Faulty: Replace Solenoid 1.

3c). Solenoid Valve 2 (SV₂) (F₃)

Check Solenoid Valve 2 if error indicator “11” is displayed.

- a.) Disconnect Solenoid 2 connector (F₃) and measure voltage between Orange-Black.

Normal: 11~13V

If normal, proceed to b.

Faulty: Replace PCB.

- b.) Measure resistance between of Solenoid Valve 1 connectors.

Normal: 37~43Ω

If normal, proceed to Solenoid Valve 3 (F₄) Circuit

Faulty: Replace Solenoid 2.

3d). Solenoid Valve 3 (SV₃) (F₄)

Check Solenoid Valve 3 if error indicator “11” is displayed.

- a.) Disconnect Solenoid 3 connector (F₄) and measure voltage between Yellow-Black.

Normal: DC11~13V

If normal, proceed to b.

Faulty: Replace PCB.

- b.) Measure resistance between Solenoid Valve 3 connectors.

Normal: 35~41Ω

If normal, proceed to Modulating Valve Circuit

Faulty: Replace Solenoid Valve 3.

3e). Modulating Solenoid Valve (F₁)

- a.) Disconnect Modulating Valve fasten terminals and measure voltage between terminals.(E₂)

Normal: 67~81Ω

If normal, proceed to b.).

Faulty: Replace Modulating Valve.

- b.) Measure voltage between Pink-Pink of Modulating Valve fasten terminal.

Normal: DC2.0~15V

If normal, proceed to c.).

Faulty: Replace PCB.

- c.) Check the gas secondary pressure change when set temperature on the water control changes from 37°C to 55°C.

Normal: If secondary pressure changes, go to Water Flow Servo Circuit.

Faulty: Replace Modulating Valve.

REU-V2632FFUG / REU-VM2632FFUC

4). Flame Rod Circuit

Check flame rod. (**E₁**)

Yellow - flame rod. Over DC1 μ A

Disconnect flame rod terminal (**E₁**), & re-operate.

“72” indicated:- Proceed to 3.

“72” is not indicated:- check for electrical leaks from the flame rod.

Measure voltage between flame rod terminal (**E₁**) and appliance earth.

Normal: >1M Ω

If normal, replace PCB.

Faulty: Replace flame rod.

a.) Remove the Flame Rod terminal (**E₁**) repeat operation procedure, if “72” is displayed again check the Hot water outlet thermistor.

If “72” is not displayed check current leakage from the Flame Rod.

b.) Measure voltage between body earth and Flame Rod terminal (**E₁**).

Normal: voltage AC100~160V

If normal, replaced PCB

Faulty: Replace Flame Rod.

c.) Check if the Flame Rod is securely fitted.

Normal: replace the PCB

Faulty: Adjust the fitting of the Flame Rod.

5). Electrical Fuse

a.) Measure voltage between Blue-Brown on the connector (**D₁**)

Normal: AC 207~264V

If normal proceed to b.). (11~13 Ω)

Faulty: Check if voltage on the fuse terminal is AC207~264V

b.) Measure voltage between White-White on the (**F₁**).

Normal: AC207~264V.

Faulty: replace surge protector unit.

6). Thermal Fuse Circuit

Check the Thermal Fuse.

Disconnect relay connector (**G₁**) & (**E₃**) measure voltage between Red-Red

Normal: < 1 Ω

If normal, replace PCB.

Faulty: Replace Thermal Fuse if after confirming there is no damage to appliance.

7). Water Flow Sensor

a.) Measure voltage between Yellow-Black of relay connector (**G₃**).

Normal: DC 11~13V

If normal, proceed to b.

Faulty: Replace PCB.

b.) Measure voltage between Yellow-Black of relay connector (**G₃**).

Normal: DC 4~7V

If normal, proceed to 2.

Faulty: Replace water flow sensor.

Note: For water controller readout of water flow whilst operational refer maintenance monitor. (Chapter 15) No. 1.

REU-V2632FFUG / REU-VM2632FFUC

7). Water Flow Servo Circuit

- a.) Disconnect relay connector (**G₆**), and measure voltage between Red (+) and Black (-) on PCB unit side (while operating).

Normal: DC11-13V

If normal: proceed to c.).

Faulty: Replace PCB unit.

- b.) Measure voltage between Black and Yellow with relay connector (**G₆**) connected (with no water flowing, water flow servo fully open).

Normal: DC4~7V (Pulse 17~460Hz)

Faulty: Replace Water Flow Servo with Water Flow Sensor.

- c.) Measure voltage between Black and Brown with relay connector (**G₁**) connected (with no water flowing, water flow servo fully open).

Normal: DC4~6V

Faulty: Replace Water Flow Servo and Water Flow Sensor.

8). Hot Water Outlet Thermistor Circuit

Check Hot Water Thermistor if error code “32” is displayed.

Disconnect relay connector (**G₅**) or (**G₄**) and measure voltage White -White.

When disconnected: voltage $> 1M\Omega$

When short circuit: voltage $> 1\Omega$

Normal: Check Heat exchanger outlet thermistor

Faulty: Replace hot water outlet thermistor.

If normal proceed to Flame Rod circuit.

Faulty: Replace the Hot water Outlet Thermistor.

Note: For controller readout of thermistor temperature whilst operational refer maintenance monitor. Disconnect relay connector (**G₅**) and measure voltage White -White.

9). Surge Protector (**D₁**)

Check the fuse. Blue-Brown
AC207~264V

- a.) Unplug the power plug.

- b.) Check whether or not the fuse (3A) x 2 has blown by measuring the voltage.

Normal: $< 1\Omega$

If normal go to step Electrical Fuse 13.

Faulty: Replace fuse/s (3A x 2). Check for a short next time it's turned off.

10). Electrical Fuse

- a.) Measure voltage between Blue-Brown on the connector (**D₁**)

Normal : AC 207~264V

If normal proceed to b.). (11~13 Ω)

Faulty: Check if voltage on the fuse terminal is AC207~264V

- b.) Measure voltage between White-White on the (**F₁**).

Normal: AC207~264V.

Faulty: replace surge protector unit.

REU-V2632FFUG / REU-VM2632FFUC

11). Water Flow Control Device

Check the voltage between the 2-core water controller cable.

Measure the voltage between terminals on the water control terminal (**G₆**).Grey-Yellow.

Normal: DC 11~13V

If normal, replace the water control after confirming that the cable hasn't been damaged or shorted.

Faulty: Because normal voltage is not given due a short circuit, despite the PCB being in normal state, check Water Flow Servo circuit.

If solution is not given from the above replace PCB.

12). Anti-frost Heater Circuit

a.) Disconnect relay connectors (**D₄**) and (**D₅**) and measure voltage between Yellow-Yellow on heater side (water flow servo and HW connection).

Normal: 53Ω

If normal, proceed to b.).

Faulty: Replace Valve Heater.

b.) Disconnect relay connector (**D₄**) and (**D₅**) and measure voltage between Yellow-Yellow on each connector on heater side.

Normal: 618Ω

If normal, proceed to c.).

Faulty: Replace Anti-frost Heater.

13). Frost Sensing Switch

a.) Disconnect relay connector (**D₄**) and measure voltage between Blue-Blue.

Normal: < 1Ω

If normal, check wiring (AC240V circuit).

Faulty: Replace Frost Sensing Switch.

14). Water Controller Connections

a.) Power to water controllers

Connections on the easy connect 12 V DC

Faulty:

If appliance works but no output voltage to water controllers replace PCB.

16. Maintenance Monitor / Error History

Wireless Controllers



Maintenance Function - Wireless Controller Transceiver

- 1.) Press maintenance button once.
- 2.) Temperature light (orange) will illuminate & the Led display will show current water temperature in heat exchanger.
- 3.) Press maintenance button again.
'Volume' light - (orange) will illuminate. Led display to show l/minimum water flow through Infinity.
- 4.) Press maintenance button again and the previous 10 error codes will be displayed.
First number shown on Led display will be 1 - followed by error code then 2 and the error code.



If error code reads — —, it means there was no error recorded.
Press maintenance button again to return to transceiver to normal mode.

This feature is available where the appliances are connected with a deluxe controller. This will enable service personnel to locate the maintenance history and faulty components, with the appliance in operation.

NB. When the maintenance information, error history is shown, use only one controller. If two or more water controllers are used at the same time, it may not operate correctly.

To display Maintenance Information

- 1.) With the controller in the "OFF" position press the Water Temperature "DOWN" (Cooler) button while holding the "ON/OFF" button to activate the maintenance monitor. Press the "ON/OFF" button a second time to set the controller in the "ON" mode. This feature can now be used with the appliance in operation.
 - 2.) The maintenance number will be shown in the Water Temperature display.
1. Data will be shown in the Clock display.
 2. To select the required maintenance number, press the Water Temperature "UP" and "DOWN" buttons.

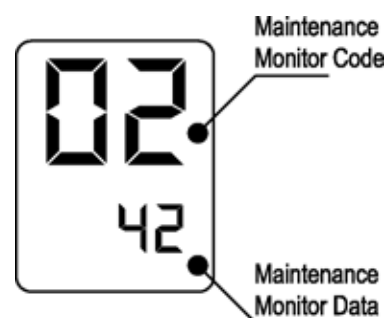

Display Monitor Contents			
No.	Contents	Units	Data Range
01	Water flow sensor recognition flow (Example 123 = 12.3L/min).	0.1L/min	0~400
02	Hot water Outlet thermistor temperature (Example 20 = 20°C)	°C	0~999
03	Hot water combustion time (Example 6 = 600 hours)	100 hours	000~999
04	Hot water operation frequency (Example 6 = 600 Operations)	100	0~999
05	Hot water fan frequency	Hz pulses/sec	0~999 *Note 1

*Note 1 Fan Frequency rpm Conversion
 (rpm) = (Hz) x15

06	water control connection	none	0 or 1 *Note 2
----	--------------------------	------	----------------

*Note 2 Water Control Connections

Bathroom water

Additional controller

“0”

Kitchen controller

1”

Controls connected	Display
No	“0”
Yes	“1”

07	Water flow servo present recognising positioning	None	0~2 *Note 3
----	--	------	-------------

*Note 3 Water Flow Servo Positioning

Servo Position	Open	Centre	Closed
Display	“1”	“0”	“2”

08	Inlet water temperature (PCB recognition value) (Example 25 = 25°C)	°C	0~999
09	Hot water fan current flow value (Example 6 x 10 = 60 mA)	10 mA	0~999
10	Bath fill amount (this counts the litres during bath fill operation).	Litres	0~999
11	Heat exchanger exit thermistor temperature (Example 55 = 55°C)	°C	0~999
12	Bypass servo present recognition positioning (Example 0 = Closed 250 = Half open 500 = Open)	Degrees	0~500

To return to normal operation

- Press the ON/OFF button again while holding down the Water Temperature "DOWN" (Cooler button)

Error History

To Display Error Memory (History)
(This feature will show the last 10 faults in sequence)

1. Turn off at the ON/OFF button. (This can be done during operation)
2. Press the ON/OFF button while holding the Water Temperature "UP" (Hotter) button.

- The Sequence will be shown in the Water Temperature display.
- Error Code will be shown in the Clock display. (See service Manual for error codes).
- Where there are less than a total of 9 errors, "FFF" or " - - " will be displayed in the Clock display.

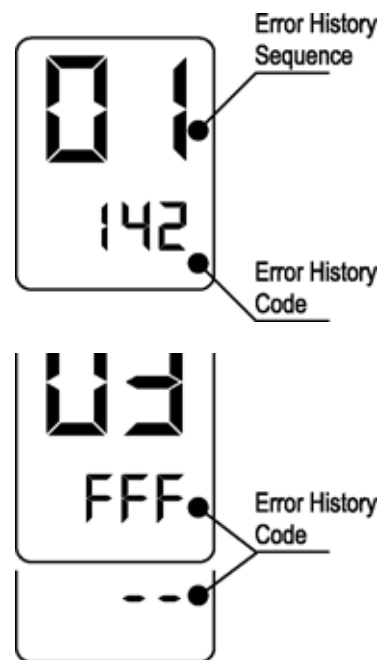

To return to normal operation

- Press the ON/OFF button again while holding the Water Temperature "UP" (Hotter) button.
- This feature will automatically shut down after 3 minutes.

17. Gas Pressure Setting Procedure



Refer separate Rinnai document behind front cover of appliance.

18. Gas Conversion Procedure



Refer separate document available from Rinnai.

19. Dismantling for Service



240 Volt potential exposure. Isolate the appliance and reconfirm with a neon screwdriver or multimeter.

NOTE: These dismantle procedures were written for a wide range of models, some details of the dismantling procedure may be slightly different to those depicted in this manual.

<i>Item</i>	<i>Page</i>
1. Removal of the Front Panel	30
2. Removal of the PCB Unit	30
3. Removal of the Water Flow Sensor, Servo and Bypass Servo	30
4. Removal of the Bypass Servo	30
5. Removal of Sparker	31
6. Removal of the manifold and burner unit	31
7. Removal of the Gas Control	32
8. Removal of Flame rod and spark plug	32
9. Removal of outgoing water thermistor	33
10. Removal of heat exchanger thermistor	33
11. Removal of air intake thermistor	33
12. Removal of Bypass Servo	33
13. Removal of Anti Frost Switch	34
14. Removal of Anti Frost heater	34
15. Removal of the Fan Motor	34
16. Removal of Heat Exchanger	35
17. Removal of Thermal Fuse	36

Unless otherwise stated, re-assembly is the reverse of dismantling.

IMPORTANT

For some areas of dismantling you may need to isolate any or all of the following:

- * Isolate gas supply.
- * Disconnect electrical supply from wall socket.
- * Isolate water supply.
- * Drain **all** water from appliance.

1) Removal of the **Front Panel**

- a. Remove four (4) screws.



2) Removal of the **PCB Unit**

- a. Remove the front panel. (Refer Item 1.)
- b. Remove two (2) PCB unit fixing screws and pull out forward.

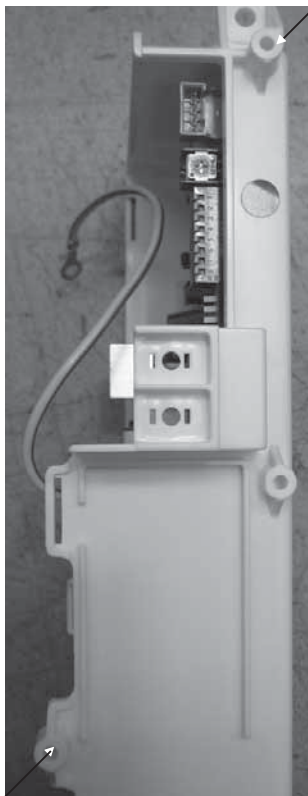

3) Removal of the **Water Flow Sensor, Servo and Bypass Servo**

- a. Remove the front panel. (Refer Item 1.)
- b. Remove two (2) screws and locking plates located on the water supply pipe and bypass pipe. Pull bypass pipe and water supply pipe forward to clear servo valves. Ensure O-rings are not lost or damaged.

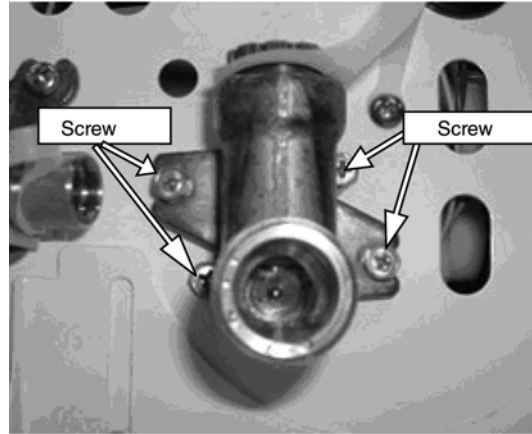

4) Removal of the **Bypass Servo**

- c. Remove two (2) screws from the water flow servo body, and pull the bypass servo out forwards. Ensure O-rings are not lost or damaged.

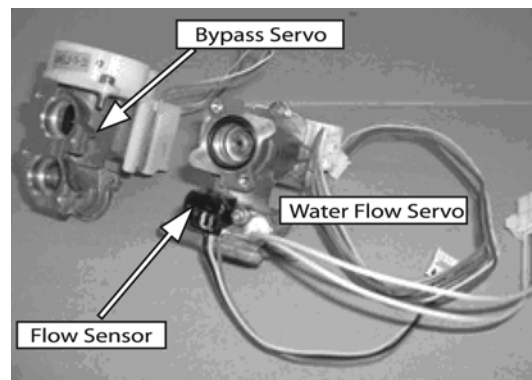

5) Removal of Sparker

- a. Remove sparker
- b. Remove 3 pin connector
- c. Remove high tension cord

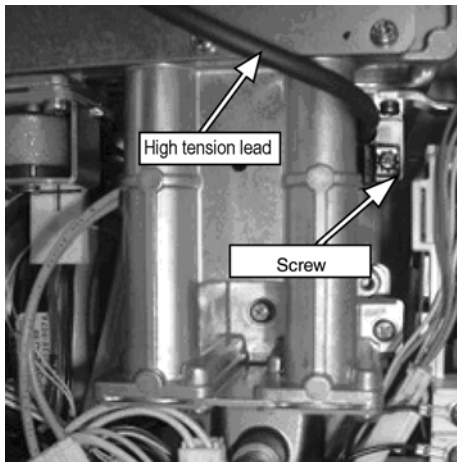

6) Removal of the manifold and burner unit

- a. Remove high tension cord and flame rod.
- b. Remove 2 pin connection of the solenoid valve
- c. Remove manifold.

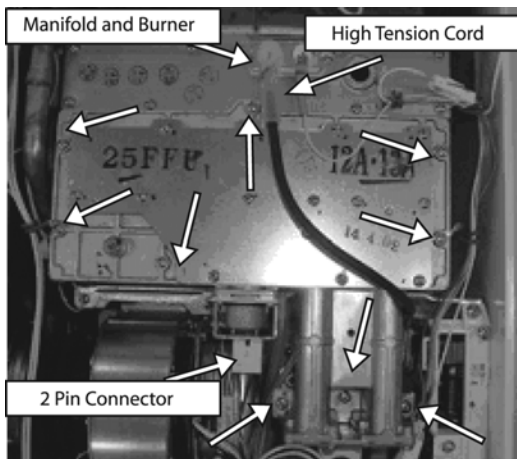

Manifold Assembly

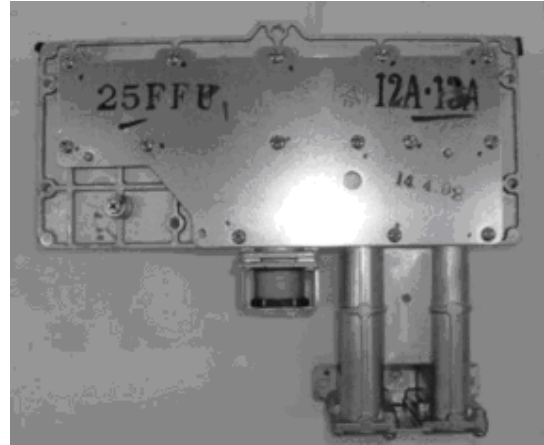

- a. Remove combustion chamber front panel.
- b. Remove burner unit.

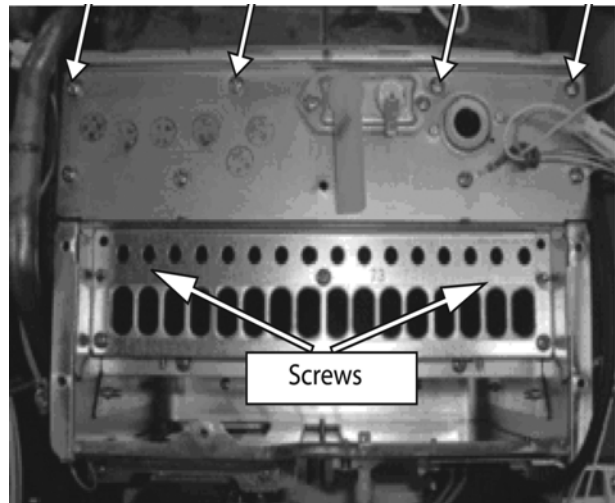

- c. Pull off burner unit

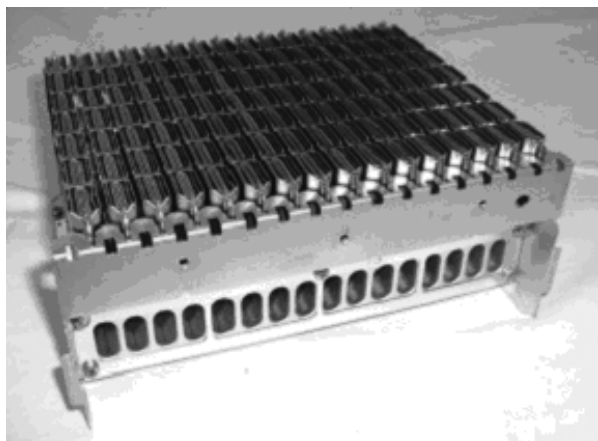

7) Removal of the Gas Control

- a. Remove manifold (refer to 7)
- b. Remove back tube
- c. Remove gas connection.

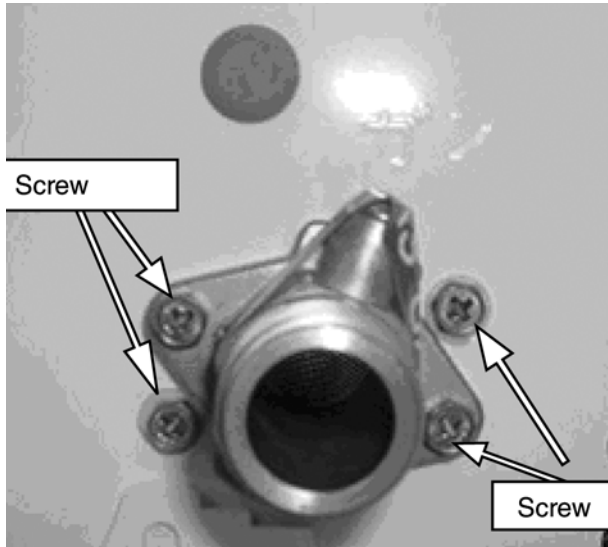

- d. Pull off connectors for gas control modulation valve and solenoid valve.

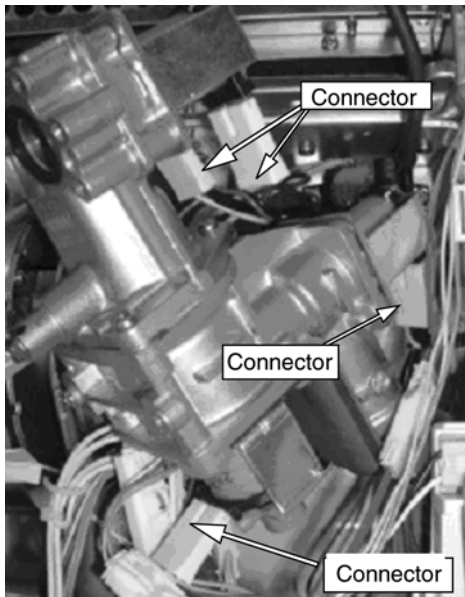

Gas Control

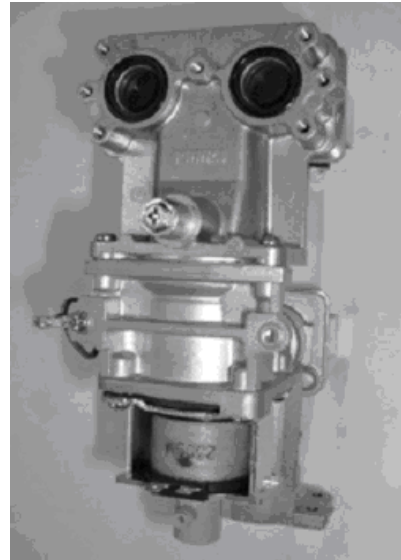

8) Removal of Flame rod and spark plug

- a. Remove flame rod terminal and tighten span cord.
- b. Remove flame rod and spark plug.

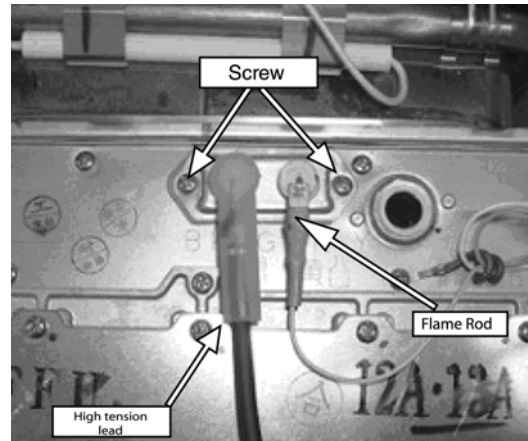

- c. Remove of High Tension lead

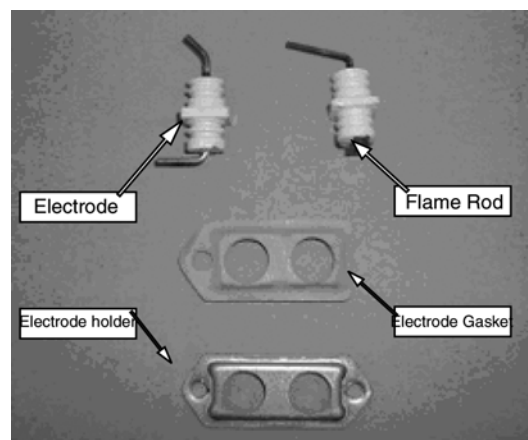

9) Removal of outgoing water thermistor

- a. Remove thermistor fixing screw.
- b. Remove 2 pin connection outgoing water thermistor

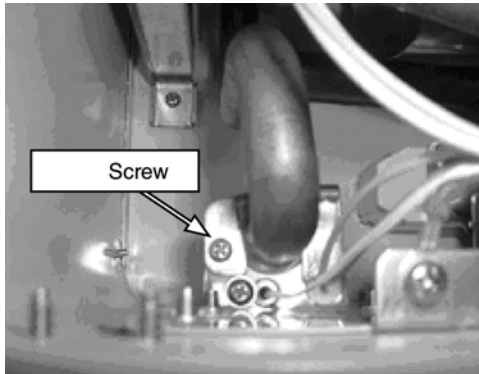

Heat Exchanger Thermistor



10) Removal of heat exchanger thermistor

- a. Remove thermistor holder
- b. Remove 2 pin connector

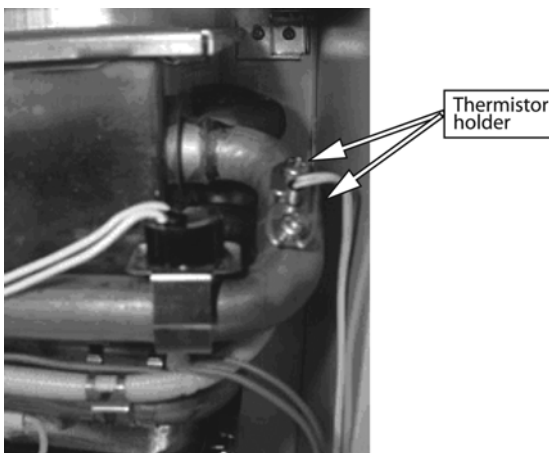

11) Removal of air intake thermistor

- a. Remove fan motor
- b. Remove 2 pin connector of inlet thermistor
- c. Remove inlet thermistor (care with O-ring)
- d. Thermistor

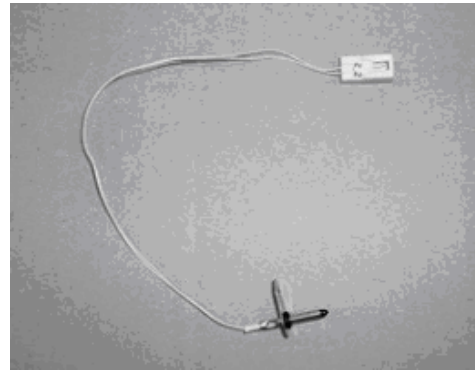
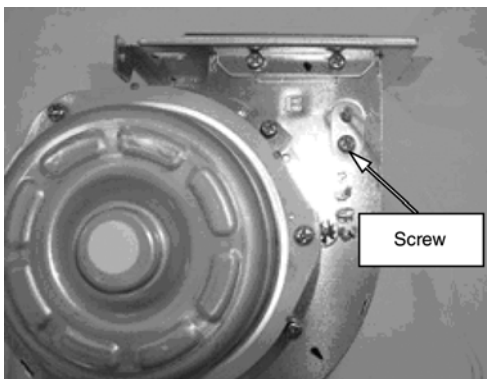

12) Removal of Bypass Servo

- a. Remove fan motor (Refer to 14)
- b. Remove 3 pin connector
- c. Remove 2 pin connector
- d. Remove 6 pin connector and 5 pin connector
- e. Remove bracket for water connection tube.

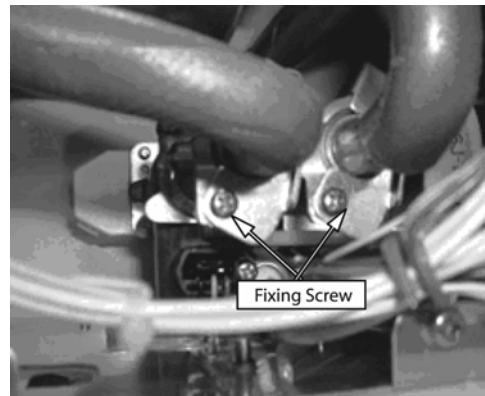

f. Removal of inlet water connection

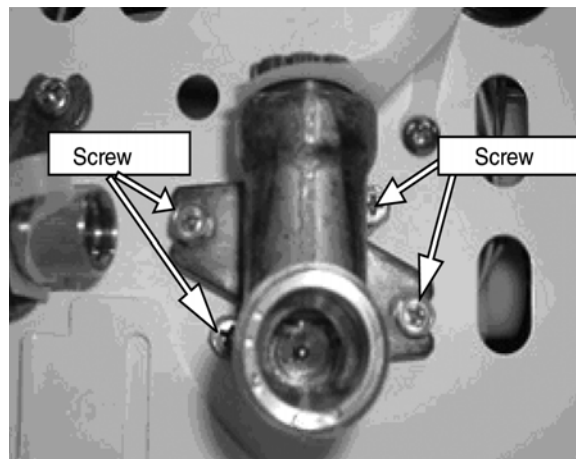

- g. Remove bypass servo and water flow servo
- h. Remove fitting screws of bypass servo

i. Flow sensor and water flow servo

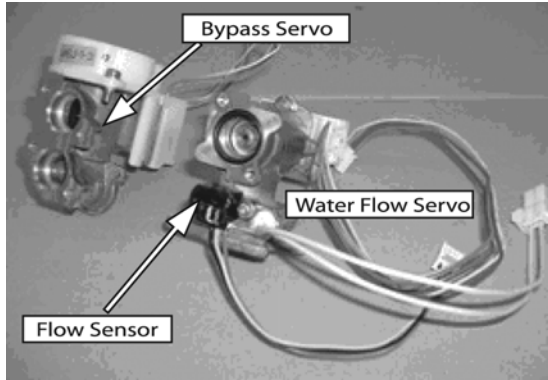

13) Removal of Anti Frost Switch

- a. Remove 2 pin connection for anti frost switch
- b. Remove Anti Frost switch

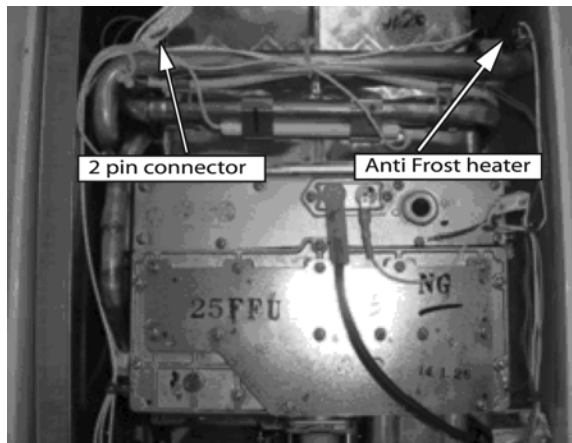

c. Anti Frost switch



14) Removal of Anti Frost heater

- a. Remove 2 pin connection of Anti Frost heater
- b. Remove bracket of hot water connection.
- c. Remove Anti Frost heater.

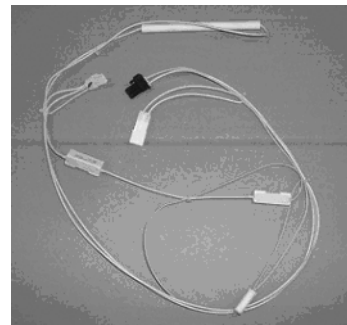
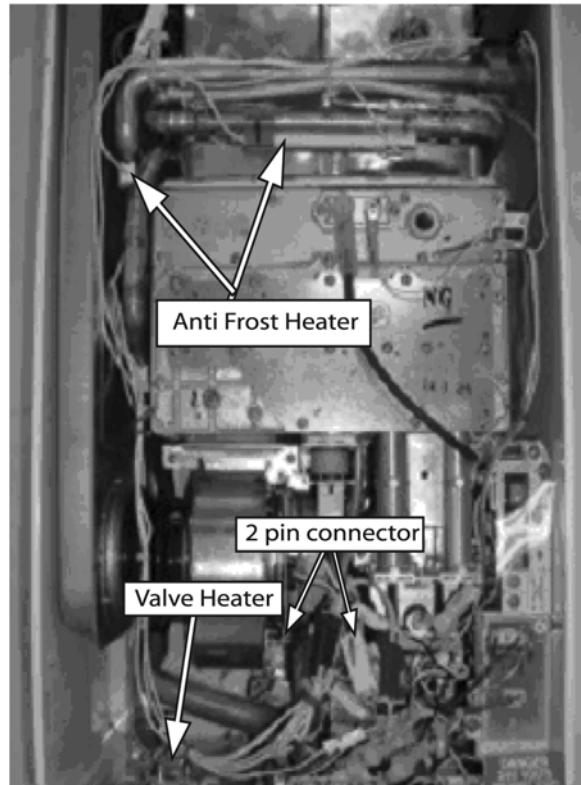

15) Removal of the Fan Motor

- a. Remove 4 pin connector
- b. Remove 2 pin connector of solenoid valve.

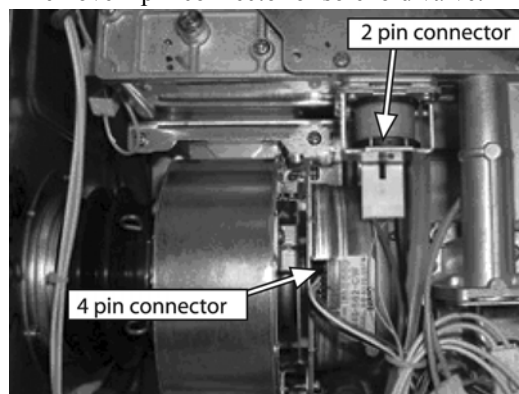

- c. Remove joint bracket
- d. Remove connection joint from the fan motor
- e. Remove fan motor screw

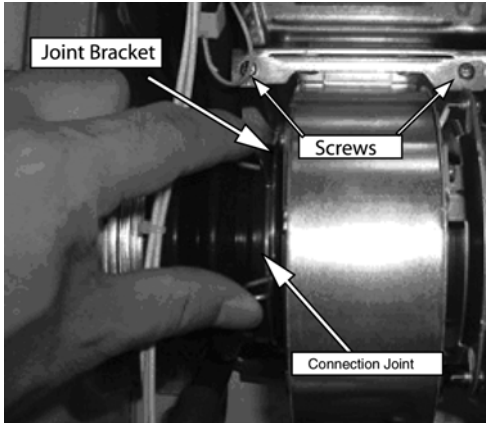

f. Remove fan motor

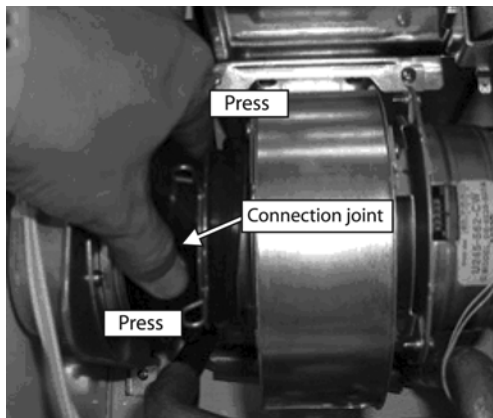
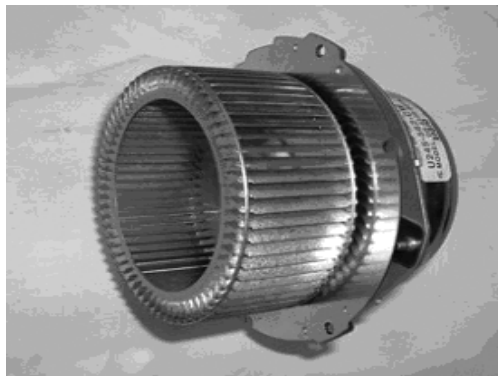
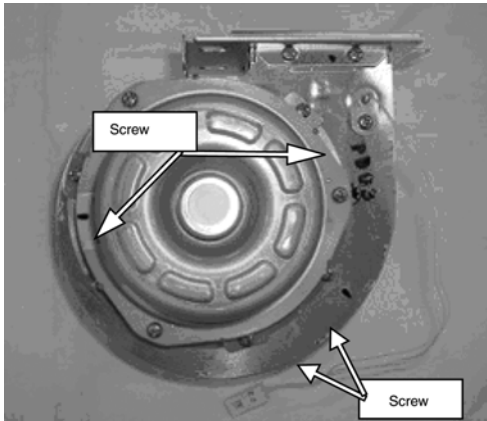

16) Removal of Heat Exchanger

- a. Remove PCB
- b. Remove fan motor
- c. Remove 2 pin connector of thermal fuse
- d. Remove flame rod terminal of high tension cord
- e. Remove anti frost heater switch
- f. Remove 2 pin connector
- g. Remove 3 pin connector
- h. Remove back pressure tube
- i. Remove air intake.

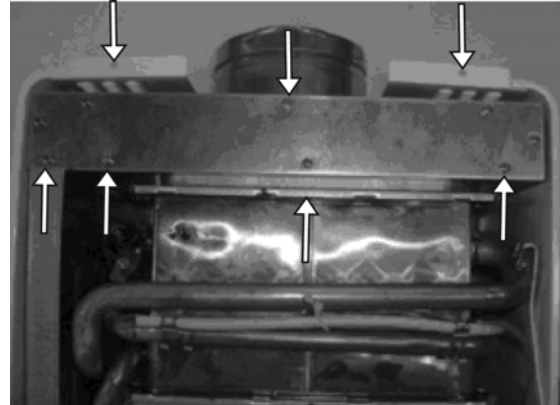

j. Remove fixing screw

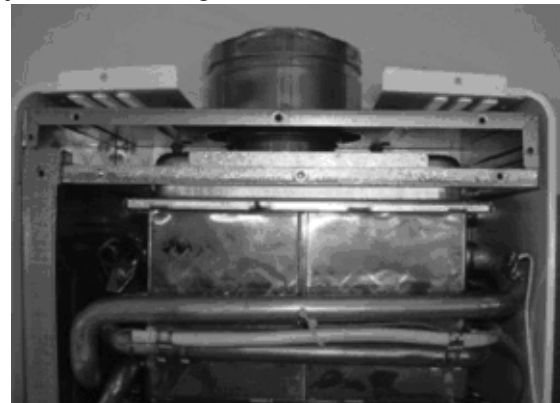

k. Remove fixing screws of the heat exchanger unit

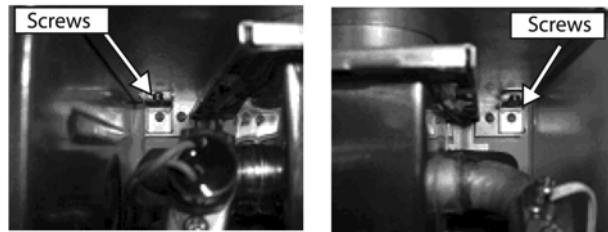

l. Remove heat exchanger screws

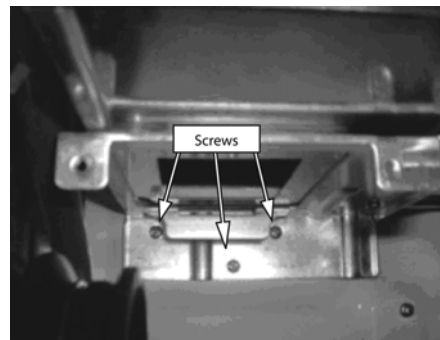

m. Remove **Bypass tube**

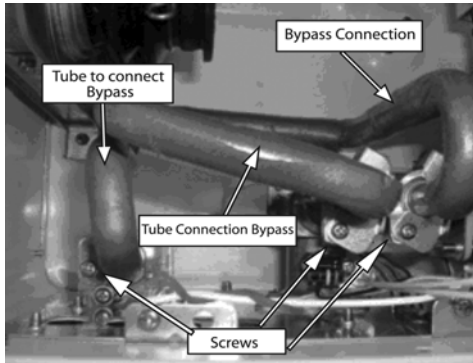

n. Pull out **heat exchanger screws**

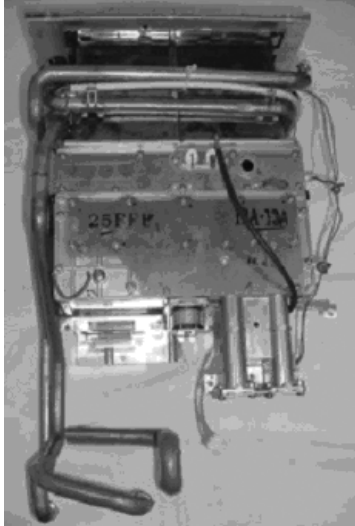

o. Remove **manifold and burner unit.**

p. Remove **thermal fuse, over heat switch, sparker, hex thermistor and back pressure joint.**

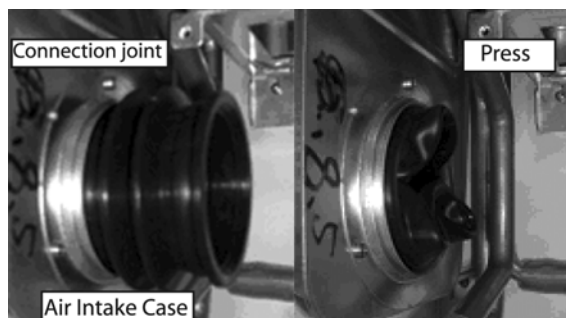
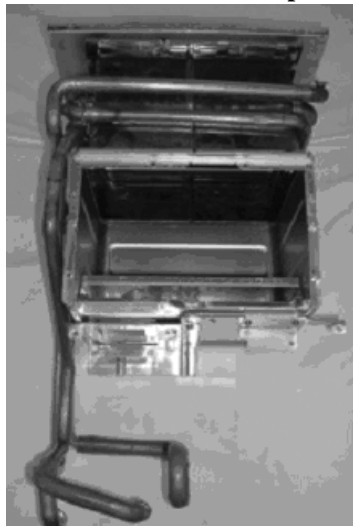

17) Removal of **Thermal Fuse**

- a. Remove heat exchanger.
- b. Remove Thermal Fuse

After removal of thermal fuse fitting procedure is as follows:

Heat Exchanger Front

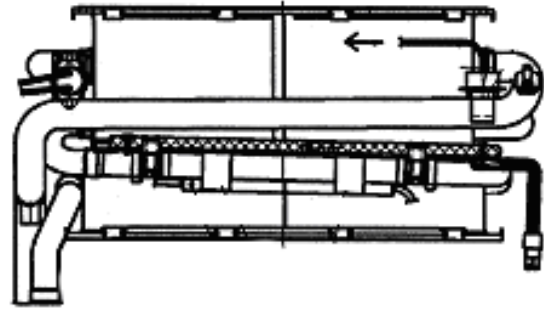

Heat Exchanger Rear

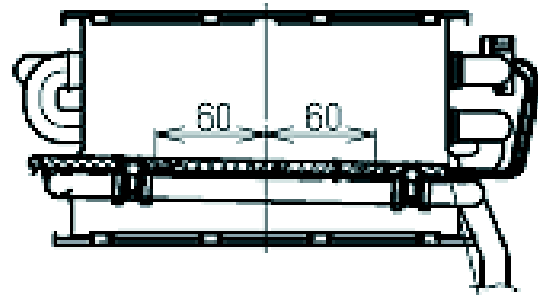

Heat Exchanger Left

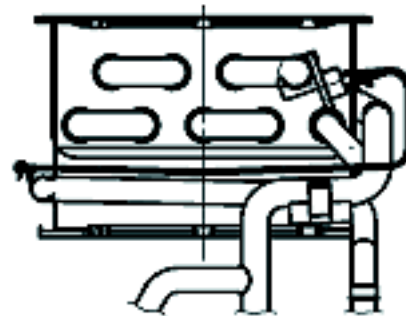

Heat Exchanger Right

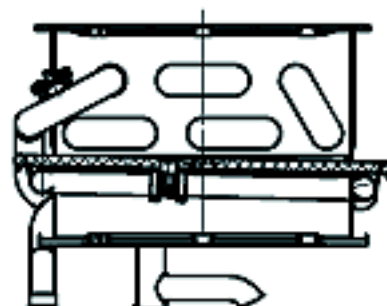

20. Parts List

NOTE:

Some Part details may have changed since publication of this manual.

Contact Rinnai to confirm spare parts details before ordering

Effective: 01/11/2006

REU-V2632FFUG-A / REU-VM2632FFUC(65)-A

REU-V2632FFUG-A / REU-VM2632FFUC(65)-A				REU-V2632FFUG	REU-VM 2632FFUC(65)
NO	Part Name	RA Part No	11 Digit Code	Quantity	
000	Main Body (Outer Case)	92092052	014-449-000		1
000	Main Body (Outer Case)	92092051	014-448-000	1	
002	Wall Fitting Bracket-2		106-577-000	1	
002	Wall Fitting Bracket-7		106-578-000		1
004	Panel Connection Reinforcement		044-064-000	1	1
005	Heat Protection Plate		030-915-000	1	1
006	Panel Front	92092056	019-3461000	1	
006	Panel Front	92092057	019-3462000		1
007	Panel Seal Front Top	92086909	580-453-000	1	1
008	Panel Seal Front Side	92063361	510-990-000	2	2
009	INF20 Cable Entry	92073352	106-104-000	1	1
010	Gasket Blind		510-893-000	2	2
011	Harness Easy Connect	92099986	106-641-000	1	1
012	Clip Support	92095896	538-840-000	1	1
100	Gas Control Assembly	92086736	120-0016000	1	1
101	Screw Test Point	92099956	501-275-005	3	3
102	Inlet Gas 3/4"	92081587	106-290-000	1	1
103	Burner Assembly LP / NG	92092212	000-059-000	1	1
104	U Burner Case Front Panel		098-902-000	1	1
105	24 Burner Case Bottom Panel		005-137-000	1	1
106	Packing		580-440-000	1	1
107	Lean and Rich Bunsen Burner		157-090-000	16	16
108	U Burner Case Front Panel		098-904-000	1	1
109	Damper LPG	92099906	140-597-000	1	1
110	Manifold Assembly (LPG)	92094318	101-705-000	1	1
110	Manifold Assembly (NG)	92094319	101-706-000	1	1
111	Combustion Chamber Packing		580-547-000	1	1
112	24 Comb Chamber Packing Lower		580-569-000	1	1
114	Combustion Chamber Front Panel		019-1337000	1	1
116	Electrode	92086974	202-156-000	1	1
117	Electrode FR	92093914	0U711467800	1	1
118	Packing Electrode RH	92086990	580-507-000	1	1
119	Electrode Holder RH	92087006	580-505-000	1	1

REU-V2632FFUG-A / REU-VM2632FFUC(65)-A

REU-V2632FFUG	REU-VM 2632FFUC(65)
---------------	------------------------

NO	Part Name	RA Part No	11 Digit Code	Quantity	
120	Combustion Chamber Packing Upper		580-998-000	1	1
121	Back Pressure Joint		197-951-000	1	1
122	Tube Pressure	92071570	513-208-000	1	1
125	Fan Comb Assy	92092097	222-513-000	1	1
126	Fan Casing All		098-0421000	1	1
127	Connecting Combustion Fan	92098870	106-320-000	1	1
128	Packing Fan Connecting	92098888	580-338-000	1	1
129	Fan Motor		222-514-000	1	1
130	Bell Mouth		036-201-000	1	1
131	Joint Fixing Pipe		055-740-000	1	1
132	Combustion Chamber Bracket		538-512-000	1	1
135	Air Inlet Duct Assembly		527-266-000	1	1
136	Joint Bracket		538-513-000	1	1
137	Connecting joint		197-960-000	1	1
138	Joint Fixing Bracket		538-590-000	1	1
139	Exhaust Flue	92095983	055-758-000	1	1
140	Joint Exhaust Tube Frame		047-719-000	1	1
141	Joint Exhaust Tube Frame Supporter		538-514-000	2	2
142	Air Inlet Box Cover		035-0413000	1	1
145	Heat Exchanger Assembly	92092106	314-694-000	1	1
400	Inlet Water 3/4	92089044	333-301-NPB	1	1
401	Water Flow Sensor	92092114	301-156-000	1	1
402	Rectifier Water	92093552	330-107-000	1	1
403	By-pass Servo Assembly	92092122	301-158-000	1	1
404	Stop Bracket		512-401-000	2	2
405	Plug Band		553-119-000	1	1
406	Filter Water 0 Large	92083773	196-062-000	1	1
408	Outlet Water 3/4	92093806	333-386-000	1	1
409	Stop Bracket		538-515-000	1	1
410	Plug Band		553-043-000	1	1
411	Valve Pressure Relief	92081751	337-048-000	1	1
700	PCB Main	92092140	210-813-000	1	1

REU-V2632FFUG-A / REU-VM2632FFUC(65)-A

				REU-V2632FFUG	REU-VM 2632FFUC(65)
NO	Part Name	RA Part No	11 Digit Code	Quantity	
701	Surge Arrestor	92093699	210-605-000	1	1
702	Electric Unit Cover		098-1868000	1	1
703	EC Cover		098-1869000	1	1
705	Electric Unit Fixing Plate		537-0060000	1	1
706	Sparker	92095026	261-157-000	1	1
707	Lead HT	92075119	203-154-000	1	1
708	Sleeve Electrode	92087030	518-035-000	1	1
709	Thermistor 1	92095030	233-246-000	1	1
709	Thermistor 2	92095031	233-247-000	1	1
710	Bracket Flame Rod	92086388	508-836-000	1	1
711	Temperature Fuse Fixing Plate		537-505-000	5	5
712	Switch Frost Sensing	92092170	234-540-000	1	1
713	Heater Anti Frost	92093294	235-368-000	1	1
714	Heater Water Flow	92092262	235-369-000	1	1
716	Bracket Heater	92093301	538-493-000	1	1
717	Heater Fixing Plate A		537-155-000	1	1
718	Clip Heater	92076123	537-174-000	1	1
719	Thermistor Fan	92099991	233-261-000	1	1
720	Elec Cord	92089051	206-226-000	1	1
721	Harness Fuse	92094003	290-1299000	1	1
723	Harness Magnet Valve	92099985	290-1301000	1	1
724	Harness Sensor	92099987	290-1302000	1	1
725	Thermal Fuse	92092189	232-191-000	1	1
726	Sensor MR	92099988	243-133-000	1	1
727	Harness Sparker	92099989	290-1303000	1	1
728	Harness Power	92099990	290-1304000	1	1
729	Harness Remote Controller	92099961	290-1288000	1	1
800	Hexagon FT Bolt		501-577-000	8	8
801	Truss Screw		501-399-010	3	3
801	Screw		501-409-000	1	1
802	Resin Washer		503-022-010	3	3
803	Screw		501-0064000	3	3
804	Thermistor Stop Screw		501-295-000	1	1

REU-V2632FFUG-A / REU-VM2632FFUC(65)-A				REU-V2632FFUG	REU-VM 2632FFUC(65)
NO	Part Name	RA Part No	11 Digit Code	Quantity	
805	Screw		501-262-000	3	3
810	O-ring Thermistor	92062249	520-209-010	2	2
811	O-ring		520-046-010	1	1
812	O-ring Test Point	90195165	520-300-010	3	3
813	O-ring In / Out Water	92071182	520-049-010	2	2
814	O-ring	92062199	520-048-010	2	2
815	O-ring Heat Exchanger	92062207	520-193-010	2	2
816	O-ring	92062348	520-281-010	1	1
817	O-ring Gas Con	92072859	520-043-010	1	1
818	O-ring Gas Control	92096502	580-180-000	2	2
888	Operation Manual		623-344-700	1	1
889	Establishment Manual		K23-372-300	1	1

21. Exploded Diagram

NOTE: Some Part details may have changed since publication of this manual.
Contact Rinnai to confirm spare parts details before ordering.

REU-V2632FFUG

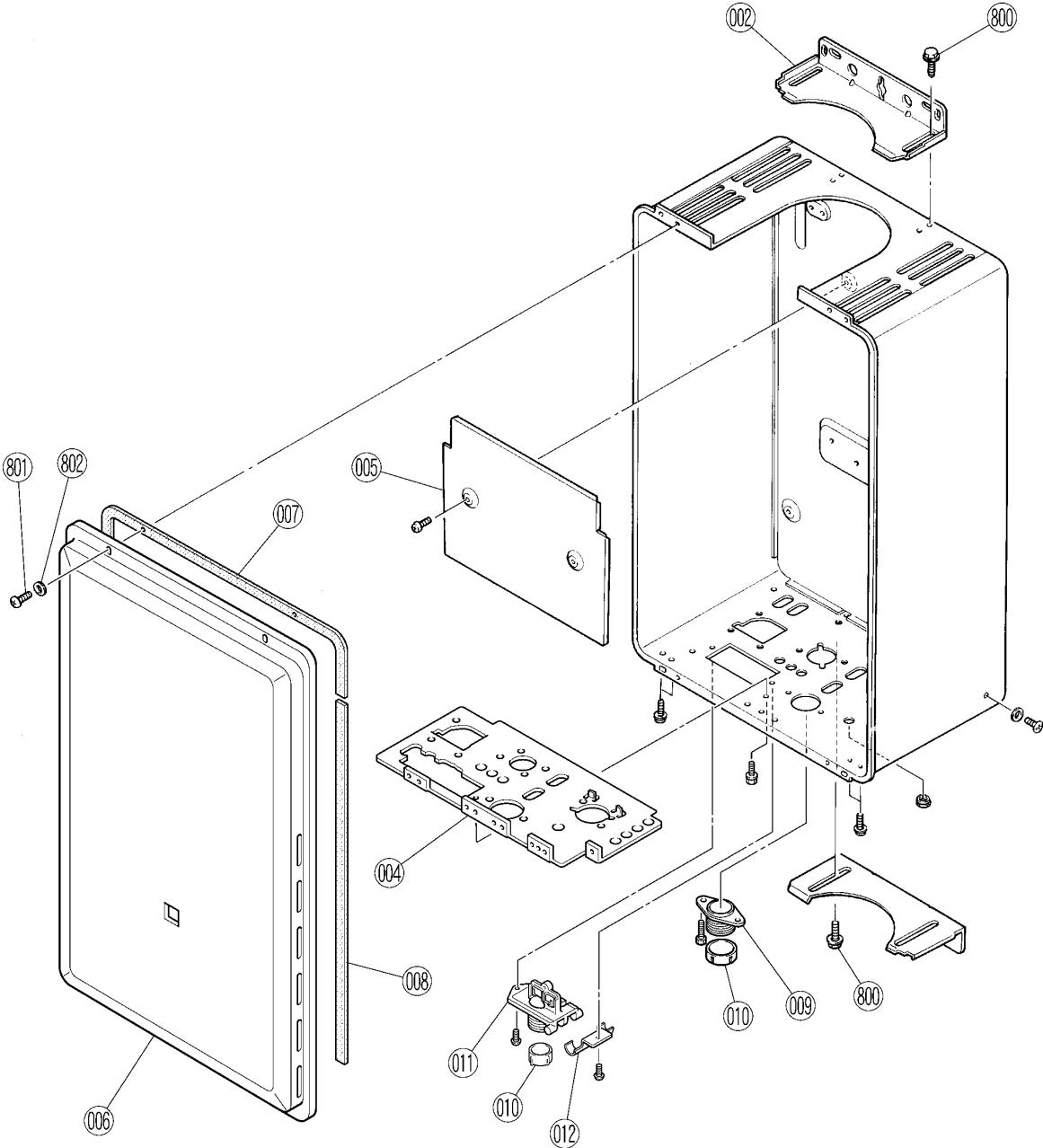

REU-V2632FFUG

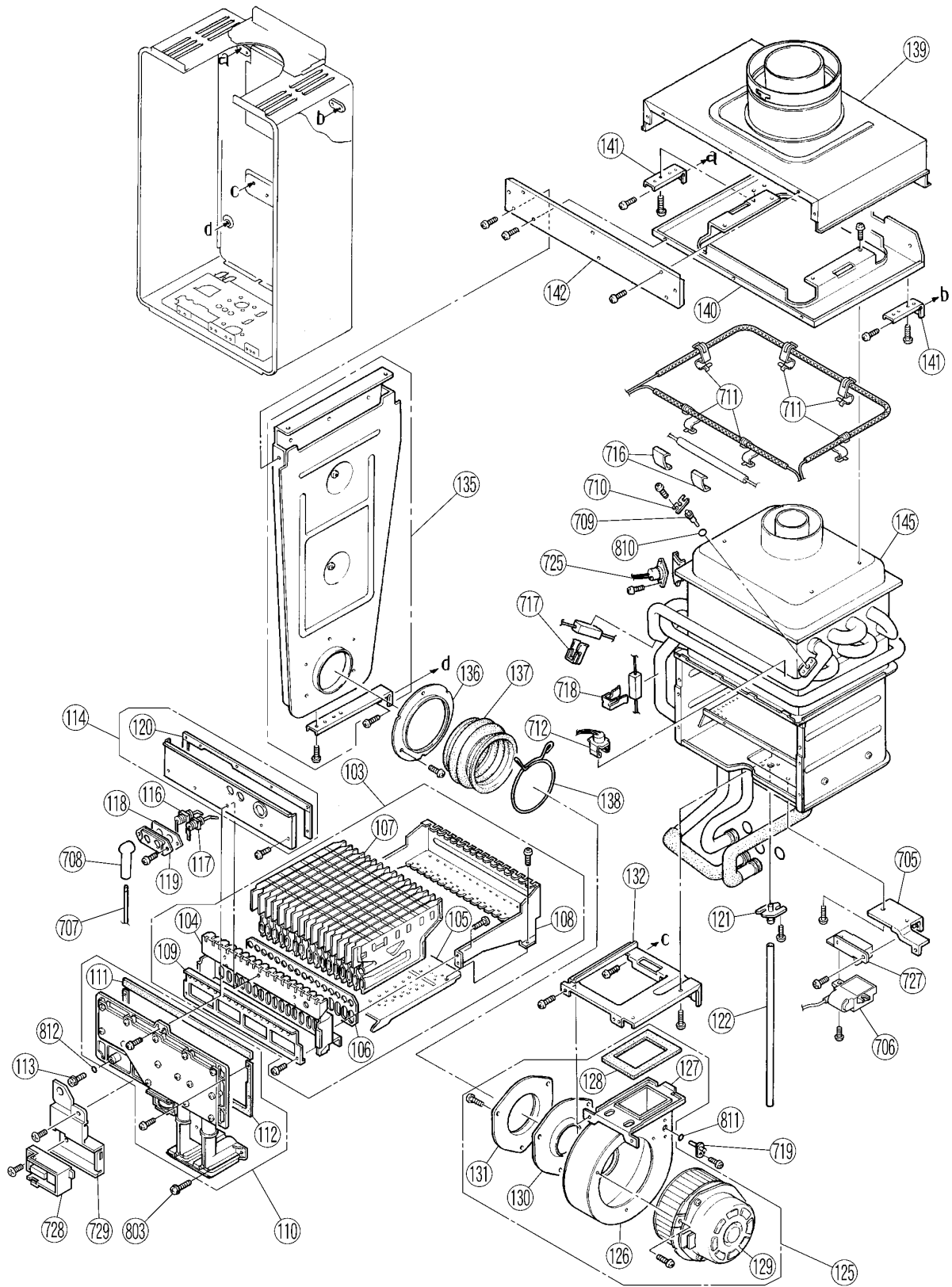

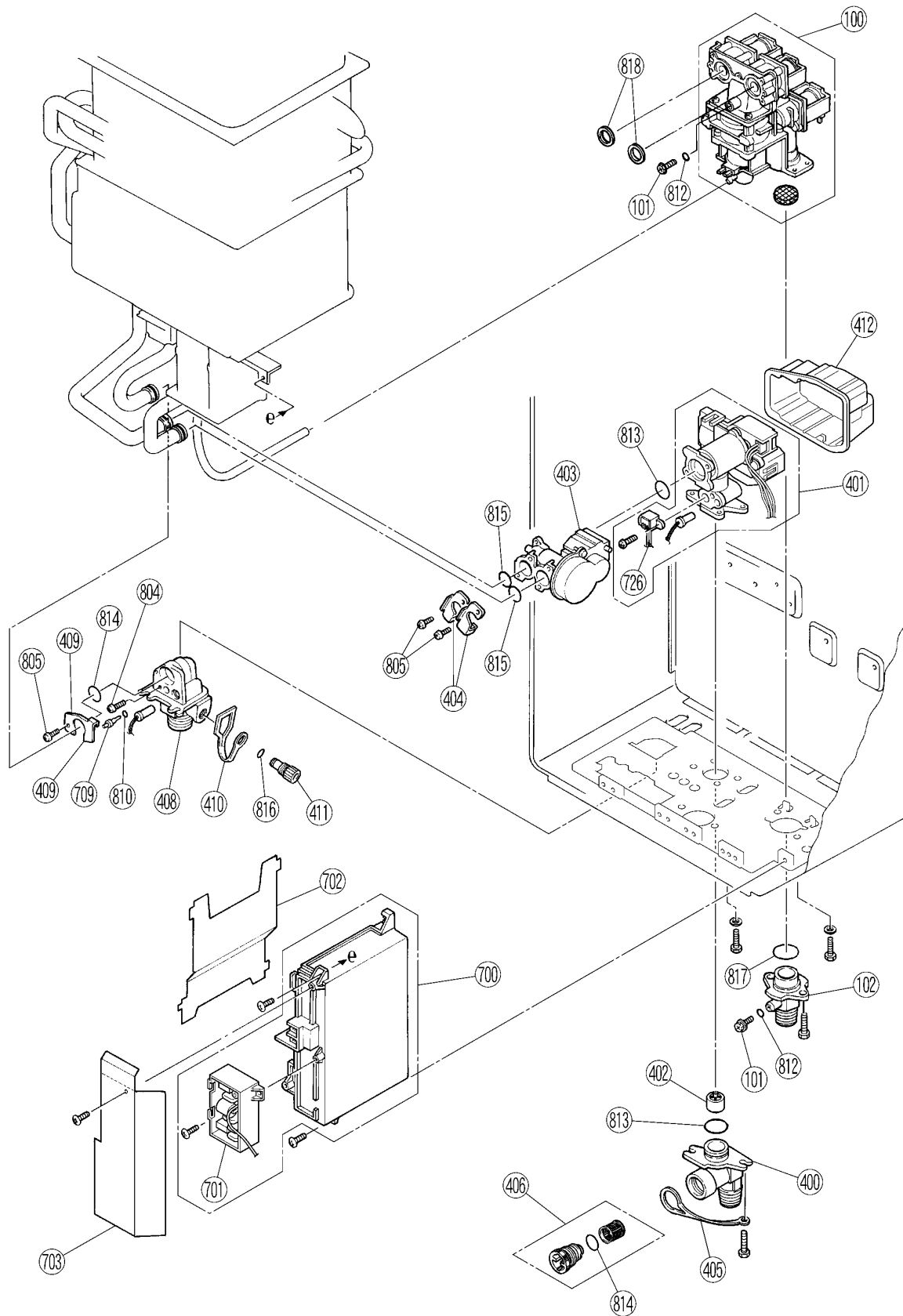

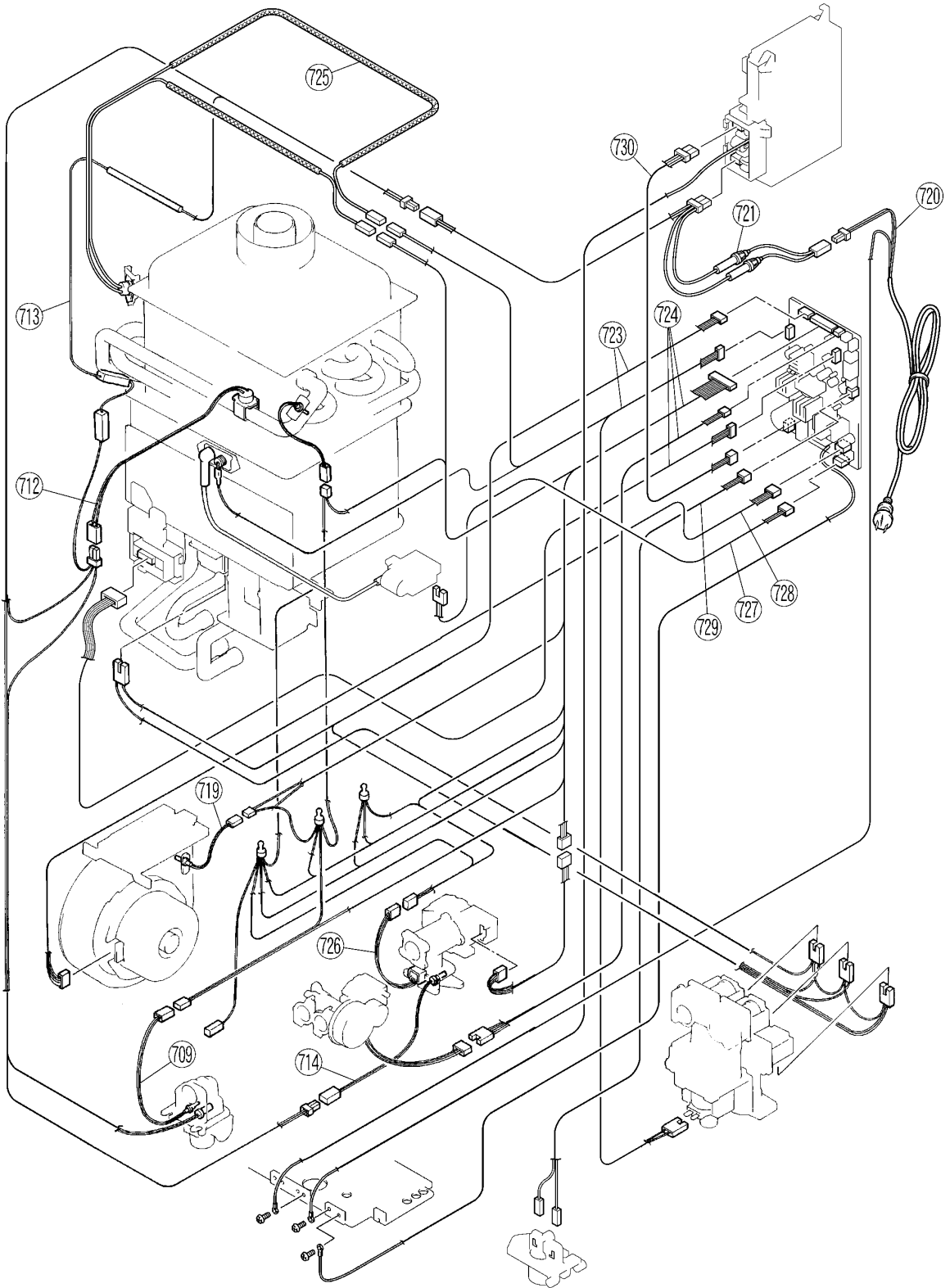

SERVICE CONTACT POINTS

Rinnai

Rinnai Australia Pty. Ltd. ABN 74 005 138 769

Head Office

10-11 Walker Street,
Braeside, Victoria 3195
P.O. Box 460
Tel: (03) 9271 6625
Fax: (03) 9271 6622

Rinnai has a Service and Spare Parts network with personnel who are fully trained and equipped to give the best service on your Rinnai appliance. If your appliance requires service, please call our Hot Water Service Line. Rinnai recommends that this appliance be serviced every 3 years.

Internet: www.rinnai.com.au E-mail: enquiry@rinnai.com.au

National Help Lines

Spare Parts & Technical Info

Tel: 1300 555 545*

Fax: 1300 300 141*

**Cost of a local call Higher from mobile or public phones.*

Hot Water Service Line

Tel: 1800 000 340