



SERVICE MANUAL

Navigator Series Scales



TABLE OF CONTENTS

	Page No.
1 GETTING STARTED	1
1.1 INTRODUCTION	1
1.2 SERVICE FACILITIES	1
1.3 TOOLS AND TEST EQUIPMENT REQUIRED	2
1.4 SPECIFICATIONS	2
1.5 CAPACITY AND READABILITY	5
1.6 SCALE OPERATION	10
1.6.1 Overview of the Controls	10
1.6.2 Overview of the Display Indicators	12
1.6.3 Power On	12
1.6.4 Power Off	13
1.6.5 Menu Setup	13
1.7 LEGAL FOR TRADE (LFT)	13
1.8 MENU STRUCTURE	14
1.8.1 User Menu	14
1.8.2 Service Menu	14
2 DIAGNOSTIC GUIDE	16
2.1 TROUBLESHOOTING	16
2.1.1 General procedures for Troubleshooting	16
2.2 DIAGNOSTIC GUIDE	16
3 MAINTENANCE PROCEDURES	19
3.1 PREVENTIVE MAINTENANCE	19
3.2 OPENING THE SCALE	19
3.3 REPLACING THE LOAD CELL	21
3.4 REPLACING THE PRINTED CIRCUIT BOARD AND DISPLAY	23
3.5 REPLACING THE FUNCTION LABEL	23
3.6 DOWN-STOP ADJUSTMENT	23
4 TESTING	25
4.1 TEST MASSES REQUIRED	25
4.2 OPERATIONAL TEST	26
4.3 SEGMENT DISPLAY TEST	26
4.4 LOAD CELL TEST USING RAMP	26
4.5 PERFORMANCE TESTS	27
4.5.1 Precision Test	27
4.5.2 Repeatability Test	28
4.5.3 Linearity Test	30
4.5.4 Off-Center Load Test	31
4.5.5 Adjusting Off Center Load	31
5 PARTS LISTS & DIAGRAMS	33
5.1 HOUSING & INTERNAL PARTS	34
APPENDIX A. STANDARD CALIBRATION	36
A.1 SPAN CALIBRATION	36
A.2 LINEARITY CALIBRATION	37
APPENDIX B. SERVICE MENU	38
B.1 ENTERING THE SERVICE MENU	38
B.2 RAMP	38
B.3 LINEAR CALIBRATION	38

TABLE OF CONTENTS

B.4 SPAN CALIBRATION	39
B.5 GEOGRAPHICAL ADJUSTMENT FACTOR (GEO)	40
B.6 FILTER SETTINGS	41
B.7 STABILITY SETTING	41
B.8 AUTO ZERO SETTING	41
B.9 EXPANDED RESOLUTION (E.PAnd)	42
B.10RESET	42
B.11END	43
APPENDIX C. SOFTWARE SERVICE TOOL INSTRUCTIONS	44
C.1 HARDWARE AND SOFTWARE SETUP	44
C.2 DEFINING LED DISPLAY VERSION	46
C.3 CONFIGURING THE SCALE	46
APPENDIX D. GEOGRAPHICAL ADJUSTMENT VALUES	48

TABLE OF CONTENTS

LIST OF TABLES

TABLE NO.	TITLE	Page No.
1-1	Specifications	2
1-2	Capacity and Readability	5
1-3	Functions of Display Controls	10
1-4	Display Indicators	11
1-5	Navigator User Menu Structure	13
1-6	Navigator Service Menu Structure	14
2-1	Diagnostic Guide	16
3-1	Load Cell Wire Color Identification	20
4-1	Calibration Mass Values	24
4-2	Tolerances	26
4-3	Repeatability Worksheet	28
4-4	Linearity Test Masses	29
5-1	NV: Housing & Internal Parts	34
5-2	NVL and NVT: Housing & Internal Parts	36
D-1.	Geographical Adjustment Values	48

LIST OF ILLUSTRATIONS

FIGURE NO.	TITLE	
1-1	Power Connection	10
1-2	Navigator Overlay	10
1-3	Navigator Display Indicators	11
1-4	Menu Lock Switch	12
3-1	Pan Support and Conductive Rubber Caps	19
3-2	Separating the Top and Bottom Housings	19
3-3	Load Cell Connections	21
3-4	Position Load Cell, PCB and AC Wires	21
3-5	Function Label Removal	22
3-6	Down-Stop Adjustment Screws	23
4-1	LCD Segment Display	25
4-2	LED Segment Display	25
4-3	Navigator Load Cell and Weighing Pan	30
5-1	Navigator NV: Housing & Internal Parts	33
5-2	Navigator NVL and NVT: Housing & Internal Parts	35
C-1	First screen of the Navigator Service Tool	45
C-2	Com port Configuration screen	46
C-3	Diagnostic screen	46
C-4	Model name on Data Label	47
C-4	Model name entered	47

1 GETTING STARTED

1.1 INTRODUCTION

This service manual contains the information needed to perform routine maintenance and service on the Ohaus Navigator Series scales. Familiarity with the scale's Instruction Manual is assumed. The contents of this manual are contained in five chapters:

Chapter 1 Getting Started – Contains information on service facilities, tools, specifications, and the mechanical and electronic functions of the scale.

Chapter 2 Troubleshooting – Contains a diagnostic guide and error code table.

Chapter 3 Maintenance Procedures – Contains preventive maintenance procedures and disassembly, repair and replacement procedures.

Chapter 4 Testing – Contains a list of required test masses, an operational test, segment display test, performance tests and adjustments.

Chapter 5 Drawings and Parts Lists – Contains exploded views of Navigator scales identifying all serviceable components.

Appendix A Standard Calibration – Explains procedures for Standard Calibration, performed prior to using a scale, and after service.

Appendix B Service Calibration – Describes the Service Menu and sub-menus, which allow authorized service personnel to perform factory Linearity and Span calibrations (no pre-set limits), take Ramp readings, adjust the GEO Factor, and use E.PAnd to temporarily increase readability to at least 1/10th of the standard readability.

Appendix C Software Service Tool Instructions – Used to re-configure the scale after replacing a Printed Circuit Board.

Appendix D Geographical Adjustment Values – The chart of scale settings for every geographical latitude away from the equator (in degrees and minutes) and every elevation above sea level (in meters or feet).

1.2 SERVICE FACILITIES

To service a scale, the service area should meet the following requirements:

- Should be temperature controlled and meet scale specifications for temperature environmental requirements.
- Must be free of vibrations such as fork lift trucks close by, large motors, air currents or drafts from air conditioning/heating ducts, open windows, people walking by, fans, etc.
- Area must be clean and free of excessive dust.
- Work surface must be stable and level.
- Scale must not be exposed to direct sunlight or radiating heat sources.
- Handle all electronic assemblies with appropriate Electro-Static protection.

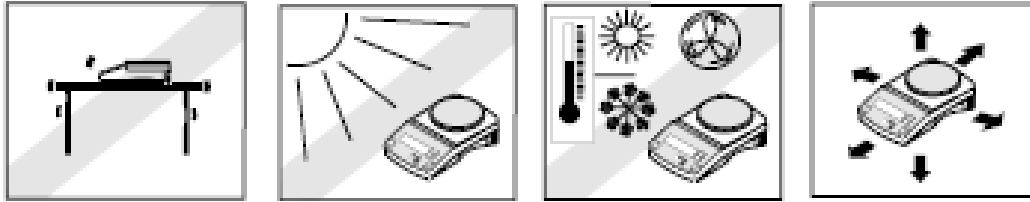

1.3 TOOLS AND TEST EQUIPMENT REQUIRED

1. Common hand tools are sufficient to disassemble the Navigator scales.
2. RS2323 Interface Kit – PN 83032106 or 71147376

1.4 SPECIFICATIONS

Specifications for the Ohaus Navigator Scales are listed in Table 1-1. When a scale has been serviced, it must meet the specifications listed in the table. Before servicing the scale, determine what specifications are not met.

Special Note regarding Approved scales

The specifications for the approved scales below are only for initial testing. These scales must be tested according to the requirements of the local Weights and Measures authority. Before returning the scale to service an approved representative of the local Weights and Measures authority must certify the scale. Ohaus does not generally recommend the repair of an approved scale that involves replacement of the load cell or PCB.

TABLE 1-1 SPECIFICATIONS

NV (non-Approved)

Model	NV212	NV511	NV1101	NV2101	NV4101	NV5101
Capacity (g)	210	510	1100	2100	4100	5100
Repeatability (g)	0.02	0.2	0.2	0.2	0.4	1
Linearity (g)	±0.02	±0.2	±0.2	±0.2	±0.4	±1
OCL (g)	±0.03	±0.3	±0.3	±0.3	±0.6	±1.5
Zero Drift (g/°C)	±0.03	±0.2	±0.2	±0.2	±0.4	±1
Span Sensitivity (g/°C)	±0.01	±0.1	±0.1	±0.1	±0.2	±0.5

NV (CMC Approved)

Model	NV212B	NV511B	NV1101B	NV2101B	NV3101B	NV5100B
Capacity	200	510	1100	2100	3100	5100
Repeatability (g)	0.02	0.2	0.2	0.2	0.4	1
Linearity (g)	±0.02	±0.2	±0.2	±0.2	±0.4	±1
OCL (g)	1 MPE	1 MPE	1 MPE	1 MPE	1 MPE	1 MPE
Zero Drift	1e / 5°C	1e / 5°C	1e / 5°C	1e / 5°C	1e / 5°C	1e / 5°C
Span Sensitivity	1 MPE	1 MPE	1 MPE	1 MPE	1 MPE	1 MPE

NV (EC / OIML Type Approved)

Model	NV311M	NV3100M
Capacity	310	3100
Repeatability (g)	0.1	1
Linearity (g)	±0.1	±1
OCL (g)	1 MPE	1 MPE
Zero Drift	1e / 5°C	1e / 5°C
Span Sensitivity (d/°C)	1 MPE	1 MPE

NV (NTEP / MC Type Approved)

Model	NV311N	NV3100N
Capacity	310	3100
Repeatability (g)	0.1	0.1
Linearity (g)	±0.1	±0.1
OCL (g)	1 MPE	1 MPE
Zero Drift	1e / 5°C	1e / 5°C
Span Sensitivity	1 MPE	1 MPE

NVL (non-Approved)

Model	NVL511	NVL1101	NVL2101	NVL5101	NVL10000	NVL20000
Capacity (g)	510	1100	2100	5100	10000	20000
Repeatability (g)	0.2	0.2	0.2	1	2	2
Linearity (g)	±0.2	±0.2	±0.2	±1	±2	±2
OCL (g)	±0.3	±0.3	±0.3	±1.5	±3	±3
Zero Drift (g/°C)	±0.2	±0.2	±0.3	±1	±2	±2
Span Sensitivity (d/°C)	±0.1	±0.1	±0.1	±0.5	±1	±1

NVL (CMC Approved)

Model	NVL511B	NVL1101B	NVL2101B	NVL5101B	NVL10000B	NVL20000B
Capacity (g)	510	1100	2100	5100	10000	20000
Repeatability (g)	0.2	0.2	0.2	2	2	2
Linearity (g)	±0.2	±0.2	±0.2	±2	±2	±2
OCL (g)	1 MPE	1 MPE	1 MPE	1 MPE	1 MPE	1 MPE
Zero Drift	1e / 5°C	1e / 5°C	1e / 5°C	1e / 5°C	1e / 5°C	1e / 5°C
Span Sensitivity	1 MPE	1 MPE	1 MPE	1 MPE	1 MPE	1 MPE

CHAPTER 1 GETTING STARTED

NVT (non-Approved)

Model	NVT1601	NVT3201	NVT6401	NVT10000	NVT16000
Capacity (g)	1600	3200	6400	10000	16000
Repeatability (g)	0.2	0.4	1	1	2
Linearity (g)	±0.2	±0.4	±1	±1	±2
OCL (g)	±0.3	±0.6	±1.5	±1.5	±3
Zero Drift (g/°C)	±0.3	±0.4	±1	±1	±2
Span Sensitivity (g/°C)	±0.1	±0.2	±0.5	±0.5	±1

NVT (CMC Approved)

Model	NVT1601B	NVT3201B	NVT6400B	NVT10000B	NVT16000B
Capacity (g)	1600	3200	6400	10000	16000
Repeatability (g)	±0.2	±0.4	±2	±2	±2
Linearity (g)	±0.2	±0.4	±2	±2	±2
OCL (g)	1 MPE	1 MPE	1 MPE	1 MPE	1 MPE
Zero Drift	1e / 5°C	1e / 5°C	1e / 5°C	1e / 5°C	1e / 5°C
Span Sensitivity	1 MPE	1 MPE	1 MPE	1 MPE	1 MPE

NVT (EC / OIML Type Approved)

Model	NVT1601M	NVT3200M	NVT6400M	NVT16000M
Capacity (g)	1600	3200	6400	16000
Repeatability (g)	±0.5	±1	±2	±5
Linearity (g)	±0.5	±1	±2	±5
OCL (g)	1 MPE	1 MPE	1 MPE	1 MPE
Zero Drift	1e / 5°C	1e / 5°C	1e / 5°C	1e / 5°C
Span Sensitivity	1 MPE	1 MPE	1 MPE	1 MPE

NVT (NTEP / MC Type Approved)

Model	NVT1601N	NVT3200N	NVT6400N	NVT16000N
Capacity (g)	±0.5	±1	±2	±5
Repeatability (g)	±0.5	±1	±2	±5
Linearity (g)	±0.5	±1	±2	±5
OCL (g)	1 MPE	1 MPE	1 MPE	1 MPE
Zero Drift	1e / 5°C	1e / 5°C	1e / 5°C	1e / 5°C
Span Sensitivity	1 MPE	1 MPE	1 MPE	1 MPE

1.5 CAPACITY AND READABILITY

The capacity and readability of the available units of measure for the Ohaus Navigator Scales are listed in Table 1-2.

TABLE 1-2 CAPACITY AND READABILITY

NV Models (Non-Approved)

Units	NV212	NV511	NV1101	NV2101	NV4101	NV5101
ct	1050 x 0.05	2550 x 0.5	5500 x 0.5	10500 x 0.5	20500 x 1	25500 x 5
g	210 x 0.01	511 x 0.1	1100 x 0.1	2100 x 0.1	4100 x 0.2	5100 x 0.5
kg	NA	NA	1.1 x 0.0001	2.1 x 0.0001	4.1 x 0.0002	5.1 x 0.0005
lb	NA	1.1245 x 0.0005	2.425 x 0.0005	4.6295 x 0.0005	9.039 x 0.0005	11.244 x 0.002
oz (dec)	7.4075 x 0.0005	17.990 x 0.005	38.8 x 0.005	74.075 x 0.005	144.63 x 0.01	179.9 x 0.02
oz (frac)	7 x 1/8	17 7/8 x 1/8	38 3/4 x 1/8	74 x 1/8	144 5/8 x 1/8	179 7/8 x 1/8
lb:oz (dec)	NA	1lb:1.99oz x 0.01oz	2lb:6.8oz x 0.01oz	4lb:10.07oz x 0.01oz	9lb:0.63oz x 0.01oz	11lb:3.9oz x 0.02oz
lb:oz (frac)	NA	1lb:1 7/8oz x 1/8 oz	2lb:6 3/4oz x 1/8oz	4lb: 10oz x 1/8oz	9lb:0 5/8oz x 1/8oz	11lb:3 7/8oz x 1/8oz
ozt	6.7515 x 0.0005	16.395 x 0.005	35.365 x 0.005	67.517 x 0.005	131.82 x 0.01	163.96 x 0.02
gr / grn	3240 8 x 0.2	7870 x 2	16976 x 2	32408 x 2	63275 x 5	78700 x 10
N	2.0594 x 0.0001	5.001 x 0.001	10.787 x 0.001	20.594 x 0.001	40.206 x 0.002	50.015 x 0.005
dwt	135.03 x 0.01	327.9 x 0.1	707.3 x 0.1	1350.3 x 0.1	2636.4 x 0.2	3279.5 x 0.5
thk	5.6105 x 0.0005	13.625 x 0.005	29.39 x 0.005	56.105 x 0.005	109.54 x 0.01	136.26 x 0.02
tsg	5.5555 x 0.0005	13.49 x 0.005	29.1 x 0.005	55.555 x 0.005	108.47 x 0.01	134.92 x 0.02
ttw	5.6 x 0.0005	13.6 x 0.005	29.335 x 0.005	56 x 0.005	109.34 x 0.01	136.00 x 0.02
tola	18.004 x 0.001	43.72 x 0.01	94.31 x 0.01	180.04 x 0.01	351.5 x 0.02	437.25 x 0.05

CHAPTER 1 GETTING STARTED

tical	12.860 x 0.001	31.23 x 0.01	67.36 x 0.01	128.6 x 0.01	251.08 x 0.02	312.30 x 0.05
--------------	-------------------	-----------------	-----------------	-----------------	------------------	------------------

NV Models (EC / OIML Type Approved)

Units	NV311M	NV3100M
ct	2550 x 0.5	15500 x 5
g	311 x 0.1	3100 x 1
kg	NA	3.1 x 0.001

NV Models (NTEP / MC Type Approved)

Units	NV311N	NV3100N
ct	2550 x 0.5	15500 x 5
g	311 x 0.1	3100 x 1
kg	NA	3.1 x 0.001
lb	NA	6.835 x 0.005
oz	10.935 x 0.005	109.35 x 0.05
ozt	9.965 x 0.005	99.65 x 0.05
gr / grn	4784 x 2	47840 x 20
dwt	199.3 x 0.1	1993 x 1

NVL Models (Non-Approved)

Units	NVL511	NVL1101	NVL2101	NVL5101	NVL10000	NVL20000
ct	2550 x 0.5	5500 x 0.5	10500 x 0.5	25500 x 5	50000 x 5	100000 x 5
g	511 x 0.1	1100 x 0.1	2100 x 0.1	5100 x 0.5	10000 x 0.5	20000 x 1
kg	NA	1.1 x 0.0001	2.1 x 0.0001	5.1 x 0.0005	10 x 0.0005	20 x 0.001
lb	1.1245 x 0.0005	2.425 x 0.0005	4.6295 x 0.0005	11.244 x 0.002	22.046 x 0.002	44.09 x 0.005
oz (dec)	17.990 x 0.005	38.8 x 0.005	74.075 x 0.005	179.9 x 0.02	352.74 x 0.02	705.5 x 0.05
oz (frac)	17 ⁷ / ₈ x ¹ / ₈	38 ³ / ₄ x ¹ / ₈	74 x ¹ / ₈	179 ⁷ / ₈ x ¹ / ₈	352 ⁵ / ₈ x ¹ / ₈	705 ¹ / ₂ x ¹ / ₈
lb:oz (dec)	1lb:1.99oz x 0.01oz	2lb:6.8oz x 0.01oz	4lb:10.07oz x 0.01oz	11lb:3.9oz x 0.02oz	22lb:0.74oz x 0.02oz	44lb: 1.5oz x 0.05oz
lb:oz (frac)	1lb:1 ⁷ / ₈ oz x ¹ / ₈ oz	2lb:6 ³ / ₄ oz x ¹ / ₈ oz	4lb: 10oz x ¹ / ₈ oz	11lb:3 ⁷ / ₈ oz x ¹ / ₈ oz	22lb:0 ⁵ / ₈ oz x ¹ / ₈ oz	44lb: 1 ¹ / ₂ oz x ¹ / ₈ oz
ozt	16.395 x 0.005	35.365 x 0.005	67.517 x 0.005	163.96 x 0.02	321.50 x 0.02	643 x 0.05
gr / grn	7870 x 2	16976 x 2	32408 x 2	78700 x 10	154320 x 10	308640 x 20
N	5.001 x 0.001	10.787 x 0.001	20.594 x 0.001	50.015 x 0.005	98.065 x 0.005	196.13 x 0.01
dwt	327.9 x 0.1	707.3 x 0.1	1350.3 x 0.1	3279.5 x 0.5	6430 x 0.5	12860 x 1
thk	13.625 x 0.005	29.39 x 0.005	56.105 x 0.005	136.26 x 0.02	267.16 x 0.02	534.35 x 0.05
tsg	13.49 x 0.005	29.1 x 0.005	55.555 x 0.005	134.92 x 0.02	264.54 x 0.02	529.10 x 0.05
ttw	13.6 x 0.005	29.335 x 0.005	56 x 0.005	136.00 x 0.02	266.66 x 0.02	533.35 x 0.05
tola	43.72 x 0.01	94.31 x 0.01	180.04 x 0.01	437.25 x 0.05	857.35 x 0.05	1714.67 x 0.1
tical	31.23 x 0.01	67.36 x 0.01	128.6 x 0.01	312.30 x 0.05	612.40 x 0.05	1224.79 x 0.1

CHAPTER 1 GETTING STARTED

NVT Models (Non-Approved)

Units	NVT1601	NVT3201	NVT6401	NVT10001	NVT16000
ct	8000 x 0.5	16000 x 1	32000 x 5	50000 x 5	800000 x 5
g	1600 x 0.1	3200 x 0.2	6400 x 0.5	10000 x 0.5	16000 x 1
kg	1.6 x 0.0001	3.2 x 0.0002	6.4 x 0.0005	10 x 0.0005	16 x 0.001
lb	3.2 x 0.0002	6.4 x 0.0005	16 x 0.001	22 x 0.002	32 x 0.002
oz (dec)	51.2 x 0.005	102.4 x 0.01	256 x 0.02	352 x 0.02	512 x 0.05
oz (frac)	51 ¹ / ₈ x ¹ / ₈	102 ³ / ₈ x ¹ / ₈	256 x ¹ / ₈	352 x ¹ / ₈	512 x ¹ / ₈
lb:oz (dec)	3lb:3.2oz x 0.01oz	6lb:6.4oz x 0.01oz	16lb:0oz x 0.02oz	22lb:0oz x 0.02oz	32lb: 0oz x 0.05oz
lb:oz (frac)	3lb:3 ¹ / ₈ oz x ¹ / ₈ oz	6lb: 6 ³ / ₈ oz x ¹ / ₈ oz	16lb:0oz x ¹ / ₈ oz	22lb:0oz x ¹ / ₈ oz	32lb: 0oz x ¹ / ₈ oz
ozt	46.665 x 0.005	93.33 x 0.01	233.32 x 0.02	320.85 x 0.02	466.65 x 0.05
gr / grn	22400 x 2	44800 x 5	112000 x 10	154000 x 10	22400 x 20
N	15.691 x 0.001	31.38 x 0.002	62.765 x 0.005	98.065 x 0.005	156.91 x 0.01
dwt	933.3 x 0.1	1866.6 x 0.2	4115.5 x 0.5	6417 x 0.5	9333 x 1
thk	42.750 x 0.005	85.5 x 0.01	170.98 x 0.02	267.16 x 0.02	427.5 x 0.05
tsg	42.33 x 0.005	84.66 x 0.01	169.32 x 0.02	264.54 x 0.02	423.3 x 0.05
ttw	42.665 x 0.005	85.33 x 0.01	170.66 x 0.02	266.66 x 0.02	426.65 x 0.05
tola	137.17 x 0.01	274.34 x 0.02	548.7 x 0.05	857.35 x 0.05	1371.7 x 0.1
tical	97.98 x 0.01	195.96 x 0.02	391.95 x 0.05	612.40 x 0.05	979.8 x 0.1

NVT Models (EC / OIML Type Approved)

Units	NVT1601M	NVT3200M	NVT6400M	NVT16000M
ct	8000 x 5	16000 x 5	32000 x 10	80000 x 50
g	1600 x 0.5	3200 x 1	6400 x 2	16000 x 5
kg	1.6 x 0.0005	3.2 x 0.001	6.4 x 0.002	16 x 0.005

NVT Models (NTEP / MC Type Approved)

Units	NVT1601N	NVT3200N	NVT6400N	NVT16000N
ct	8000 x 5	16000 x 5	32000 x 10	80000 x 50
g	1600 x 0.5	3200 x 1	6400 x 2	16000 x 5
kg	1.6 x 0.0005	3.2 x 0.001	6.4 x 0.002	16 x 0.005
lb	3.2 x 0.001	6.4 x 0.002	16 x 0.005	32 x 0.01
oz	51.20 x 0.02	102.40 x 0.05	256 x 0.1	512 x 0.2
ozt	466.66 x .02	93.35 x 0.05	233.3 x 0.1	466.6 x 0.2
gr / grn	22400 x 10	44800 x 20	112000 x 50	224000 x 100
dwt	933.5 x .5	1867 x 1	4666 x 2	9335 x 5

1.6 SCALE OPERATION

This section contains information on the basic operation of the scale.

The included AC adapter may be used to power the scale when battery power is not available.

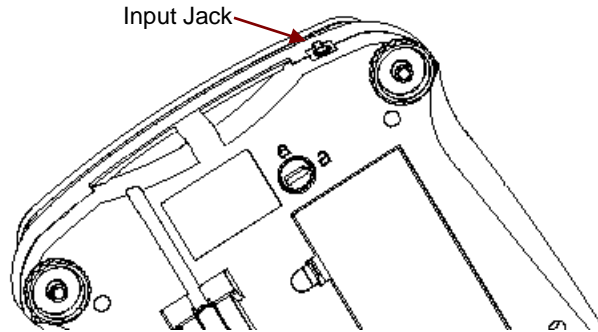

Figure 1-1. Power Connection

1.6.1 Overview of the Controls

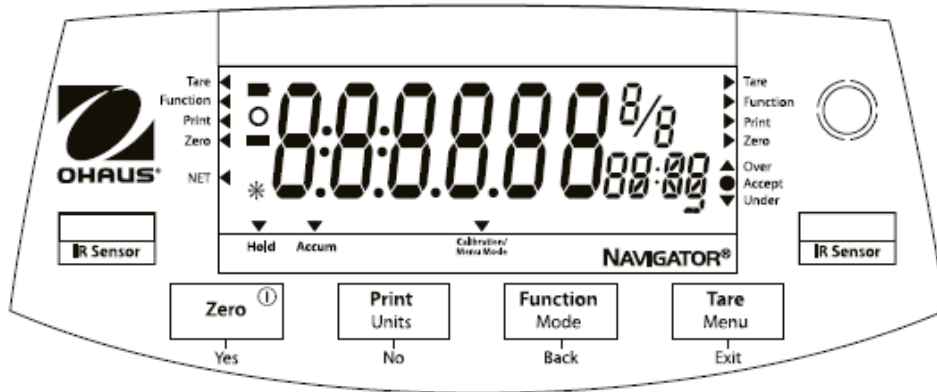

Figure 1-2. Navigator (non-approved models) Overlay

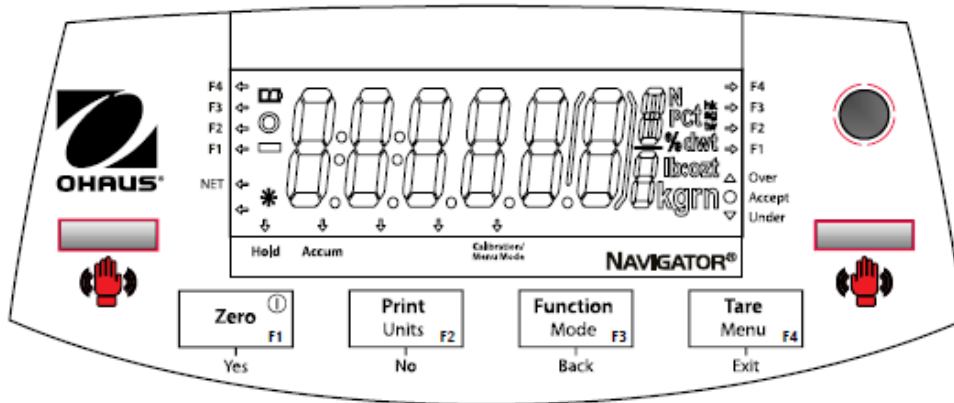

Figure 1-2. Navigator (approved models) Overlay

TABLE 1-3 FUNCTIONS OF DISPLAY CONTROLS

Button	Functions
Zero ① Yes	Short Press (when on): Sets display to zero (when off): Turns balance on Long Press (when on): Turns the balance off Short Press (in Menu): Selects/accepts displayed setting
Print Units No	Short Press: See Interface Manual for operation description. Long Press: Toggles through active units Short Press (in Menu): Toggles through available settings
Function Mode Back	Short Press: Selects function setting Long Press: Selects active Mode Short Press (in Menu): returns to previous settings
Tare Menu Exit	Short Press: Enter / clear a Tare value Long Press: Enters User Menu Short Press (in Menu): Quickly exit User Menu
IR Sensor-Left IR Sensor-Right	IR Sensors can be programmed to act as “touchless” buttons. They can be programmed to perform the Tare, Function, Print and Zero functions or be disabled. Each sensor is programmed individually.

1.6.2 Overview of the Display Indicators

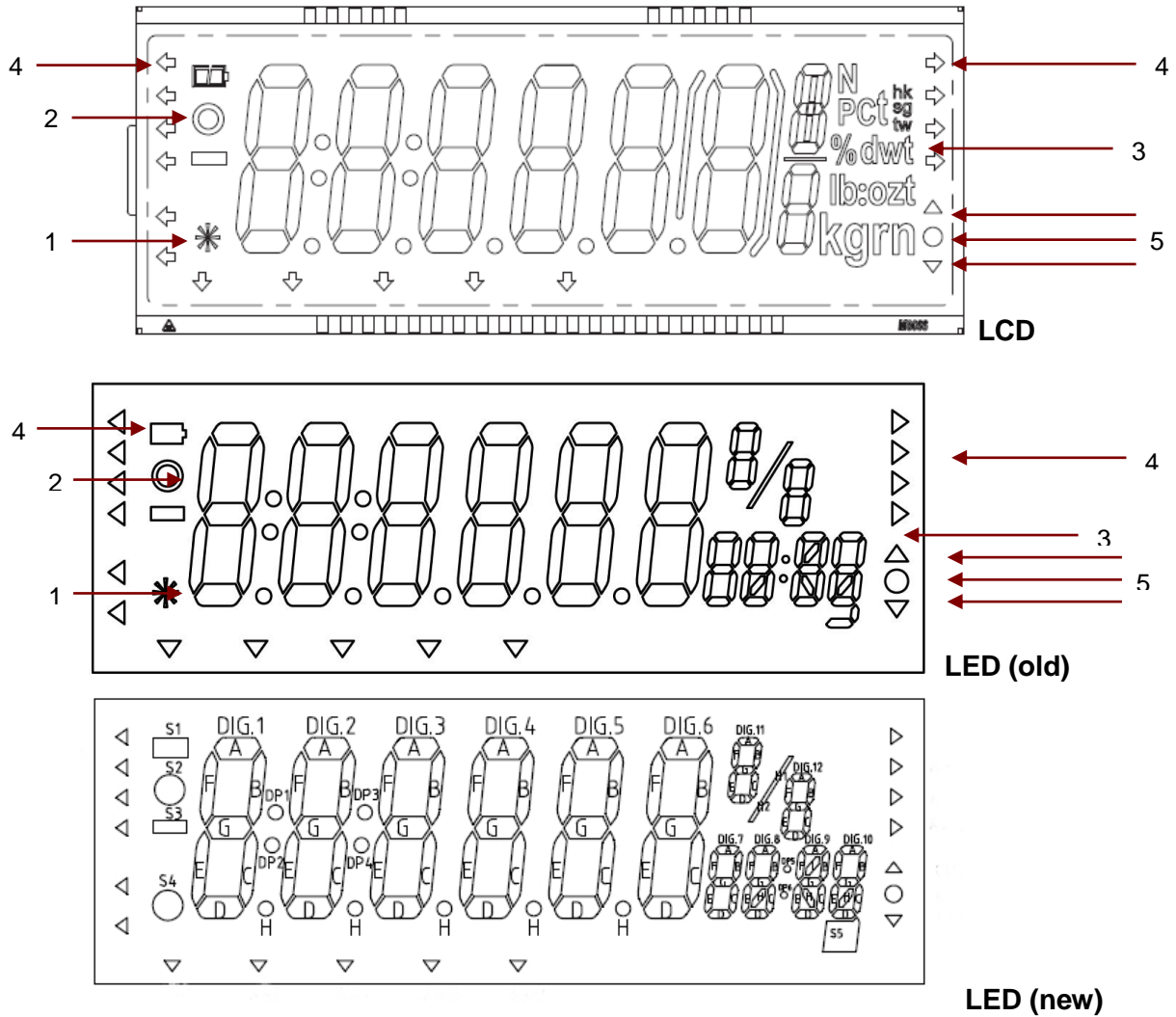



Figure 1-3. Navigator Display Indicators

TABLE 1-4 DISPLAY INDICATORS

No.	Function
1	Indicates that the measured value has become stable.
2	Indicates that the indicated value is within the center of zero.
3	Symbols for weighing units or modes
4	Arrows indicate the current operation mode of the IR Sensors
5	High, Accept, Low indicators for check weigh mode.

1.6.3 Power On

With power connected, AC Adapter or battery, press **Zero** . After segment display, “OHAUS” and software revision number, the display will show * **0.00** and the current unit (standard weighing mode).

If the scale is set for LFT (Legal for Trade – EC / OIML “M” or NTEP / MC “N” models), **LFT** flashes briefly after the software revision number and before a countdown which allows for the scale electronics to stabilize.

Allow time for the scale to stabilize after moving it from an area which is at a different temperature than the area where it is to be operated. Allow one hour for each 5°F (2.7°C) temperature change before using the scale. After temperature stabilization, allow an additional 20 minutes after turning the scale on, for the scale electronics to stabilize.

When the scale is turned on, the last mode and unit will be active.

1.6.4 Power Off

To turn the scale OFF, press and hold **Zero**  until the display indicates **OFF**, then release.

1.6.5 Menu Setup

Programmable features of the Navigator scales are contained in menus which are accessed through the Display Panel’s control switches. The Menu Structure is described in Section 1.8. (For more detail on using the menus, see the Instruction Manual.)

Note: The Menu Lock switch limits changes to the Cal, Setup, Mode and Unit menus. The switch in type approved models may set some balance settings as required by the approval agency. To gain access to these submenus, see the next section.

1.7 LEGAL FOR TRADE (LFT)

When the scale is set for LFT (on “M” and “N” models), the following menu settings cannot be accessed / changed: Calibration, Mode and Units. The switch in type approved models may set some balance settings as required by the approval agency. In non-approved models the Menu lock switch will also limit access to certain menu items. The Service Menu (see section 1.8.2) is not available when the switch is “on”.

To regain access to the locked menu settings, move the Menu lock switch to the left (away from the middle), which turns LFT off.

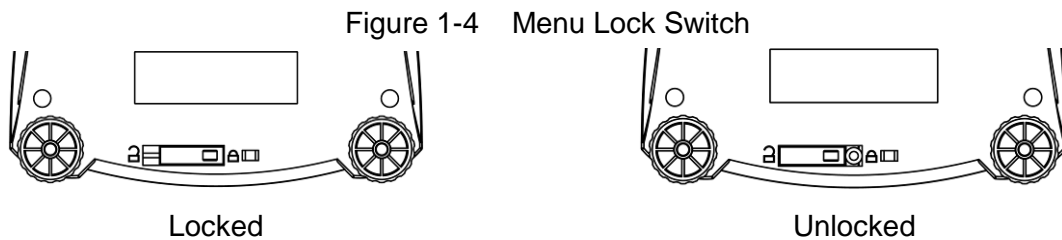

After the Menu Lock setting has been turned off, the scale must be inspected in accordance with local weights and measures regulations before it can be used in LFT mode again. Local authorities may secure the switch using paper seals, wire seals or plastic ties.

Note: “M” and “M” models- When the Menu Lock switch is set to “on” certain menu items will be forced to the required setting and the required menus will be locked.

LFT SETUP PROCEDURE

1. Set the Geographical Adjustment Factor (GEO) according to the current location. (See Appendix D. Possible values are from 1 to 31.) The setting is in the Service Menu: press **ZERO** and **Tare** simultaneously during power on, hold until “Ramp” is seen. Press **No** three times until GEO appears, then press **Yes**. Then continuously press **No** until the desired

number appears. Press **Yes**, then **No** until END appears. Press **Yes** to return to weighing mode. This allows the scale to be calibrated at the current location with the local GEO factor. Later the GEO factor can be changed to match the intended destination so that the correct deviations will be implemented.

2. Access the Mode menu (Press and hold **No** until **.M.o.d.E.** appears. Press **Yes** to enter the displayed menu, or **No** to advance to the next menu, etc.)
Set the following: Modes as per local LFT requirements
3. Access the Unit menu (Press and hold **No** until **.U.n.i.t.** appears. Press **Yes** to enter the displayed menu, or **No** to advance to the next menu, etc.)
Set the following: Units as per local LFT requirements
4. Perform an accurate calibration. (See Appendix A.)
5. Set the GEO code to the intended destination. Repeat procedure in step 1 except enter the new GEO factor.
6. Move the Menu Lock switch to the right (closer to the center), which sets LFT on.
7. Turn the Scale off and disconnect the AC power connection.
8. Reconnect the AC power, press **On/Off** to turn on the scale. During power on, the display sequence will now include: "LFT." This message confirms the proper setting of the LFT mode and the hardware lock switch. Verify proper scale operation and that the required legal requirements are met. (CAL is locked, available modes and units are correct, etc.)
9. The scale can now be sealed if the proper authority is present. If the scale cannot be sealed at the current location then the customer must do so at his or her location before the scale is put into legal service.

1.8 MENU STRUCTURE

Programmable features of the Navigator are contained in the User Menu and Service Menu which are accessed through the Display Panel's control switches. The menu structures are illustrated below.

1.8.1 User Menu

The User Menu is easily accessed and documented for the scale operator. For more detail on using the menu, see the Navigator Instruction Manual.

TABLE 1-5 NAVIGATOR USER MENU STRUCTURE

Sub-Menus:	.C.a.l.	.S.e.t.u.p.	.M.o.d.e.	.U.n.i.t.	.E.n.d.
Menu Items:	Span Lin End	A-off Disply Bright IR.LEFT IR.RGHT End	Count Percnt Hold Accum Check End	ct, g, kg, grn, lb, oz, lb:oz, ozt, N, dwt, thk, tsg, ttw, tola, tical End	

Note: Available units and modes vary by model and local regulations.

1.8.2 Service Menu

The Service Menu is intended for use by service personnel. The menu items are generally used when servicing the scale but there are setting that may be changed to satisfy a customer's special requirements. For more detail on using the service menu see Appendix B.

TABLE 1-6 NAVIGATOR SERVICE MENU STRUCTURE

	Service Menu
Menu Items:	Ramp Lin Span Geo Filter Stability AZT Expand Reset End

2 DIAGNOSTIC GUIDE

This section of the manual contains troubleshooting information. Information is contained to isolate specific problems using Table 2-1, Diagnostic Guide. Follow all directions step by step. Make certain that the work area is clean. Handle scale components with care. Use appropriate electro-static protection devices to prevent damage to the sensitive electronic components.

2.1 TROUBLESHOOTING

2.1.1 General procedures for Troubleshooting

1. Do the most obvious, user-level remedies.
2. Visual Check:
 - Check that the internal parts are clean and free from debris.
 - Examine the scale for damage or signs of abuse, replace any damaged items.
 - Examine the load cell for signs of bending, twisting or corrosion.
 - Check the overload stops, adjust if necessary. (see Section 3.6)
3. Use the error code table for solutions for specific codes.
4. Use the Diagnostic Guide; locate the symptom then follow the suggested remedies in order.

2.2 DIAGNOSTIC GUIDE

Table 2-1 is a Diagnostic Guide designed to help locate the problem area quickly and easily. The probable causes are listed with the most common cause first. If the first remedy does not fix the problem, proceed to the next remedy. Before attempting to repair the scale, read all chapters of this manual to be familiar with the scale components and operation.

Diagnosis:

1. Isolate and identify the symptom.
2. Refer to Table 2-1, Diagnostic Guide and locate the symptom.
3. Follow the suggested remedies in the order they appear.
4. Perform the indicated checks, or see the appropriate section of the manual.
5. Repair or replace the defective section of the scale.

NOTE:

If more than one symptom is observed, approach one area at a time, and remember that the symptoms may be interrelated. If a problem arises that is not covered in this manual, contact Ohaus Corporation for further information.

TABLE 2-1. DIAGNOSTIC GUIDE

Symptom	Possible Cause	Remedy
Cannot turn on	No power to scale	Check battery and / or AC Adapter connections. Verify 12VAC at the Power Jack wire connection to the PCB. If using batteries check battery voltage at the PCB battery connections.
	Defective PCB	Replace PCB
Incorrect weight reading	Internal mechanical interference	Verify the pan Support is not contacting the top housing Check that the shipping lock is not touching the Pan Support. Verify that the down-stops are not hitting during normal operation.
	Improper calibration Calibration performed with the Shipping Lock "On"	Perform span calibration
	Poor linearity performance	Perform linearity calibration
	Unstable environment- vibration, air currents or changing temperature	Move scale to suitable location, allow scale to stabilize its temperature
	Bad load cell	Replace load cell
Poor repeatability	Internal mechanical interference	Verify the pan Support is not contacting the top housing Check that the shipping lock is not touching the Pan Support.
	Bad load cell	Replace load cell
Cannot calibrate	Unstable environment- vibration, air currents or changing temperature	Move scale to suitable location, allow scale to stabilize its temperature
	Incorrect calibration weight	Use correct calibration weight
	Poor accuracy	See above – Incorrect weight reading
Cannot access mode or unit	Mode or unit not enabled	Enter menu and enable mode or unit
RS232, USB or Ethernet interface not working	Scale menu settings not proper Connected computer settings are not correct.	See Interface User Manual for proper settings
	Poor Cable connection	Check cable connection

CHAPTER 2 DIAGNOSTIC GUIDE

	Defective Interface or cable	Replace
Lo rEF	Reference weight is too low	Increase reference weight or continue to weigh with less accurate results.
rEF Err	Parts counting– sample weight <1d.	Shows error - exits mode or goes to [CLr.APU].
Err 3.0 CAL	Incorrect calibration weight	See Table 4.1 for correct weights
Err 4.4 Full	RS232 buffer is full	Set Handshake on, see Interface User Manual.
Err 8.1 Load	Power on zero range exceeded	Clear pan, check Shipping Lock setting
	Zero has drifted	View RAMP (in scale service menu) to check Load Cell, and then calibrate.
	Load Cell is damaged	Replace Load Cell.
Err 8.2 Load	Power on zero under range, pan was removed prior to power on	Install pan, check Shipping Lock setting and re-zero.
	Zero has shifted	View RAMP (in scale service menu) to check Load Cell, and then calibrate.
	Load Cell is damaged	Replace Load Cell.
Err 8.3 Load	Overload (>cap+9e)	Load exceeds balance maximum capacity, remove weight from the pan
Err 8.4 Load	Under load	Reading below min. range - Re-install pan.
Err 8.5 tArE	Tare out of range	<ol style="list-style-type: none"> 1. Switch to a unit where the tare <=Max; 2. Clear the tare --- No load on the pan, Press “tare” button; 3. Clear the tare --- Perform “Zero” operation if it is allowable, this will also clear the tare; 4. New tare is established --- Perform tare if load <=Max;
Err 8.6 999999	Displayed value >999999	Result exceeds display capability.
Err 9 dAtA	Internal data error.	Contact Ohaus or an authorized service agent
Err 13 rErE	Fail to write EEPROM.	Contact Ohaus or an authorized service agent
Err 53 cSuE	Invalid checksum data	Contact Ohaus or an authorized service agent
Some Menus or menu settings are locked out or cannot be changed.	Menu Lock switch is “on”.	Non-approved models: turn Menu Lock switch off. Approved models will require “re-sealing” of the scale if the switch is moved.

3 MAINTENANCE PROCEDURES

3.1 PREVENTIVE MAINTENANCE

Ohaus scales are precision instruments and should be carefully handled, stored in a clean, dry, dust-free area, and cleaned periodically. Follow these precautionary steps:

- When a scale has had chemicals or liquids spilled on it, all exterior surfaces should be cleaned as soon as possible with warm water on a damp cloth.
- Do not leave a mass on the scale when the scale is not in use.
- Allow time for the scale to stabilize after moving it from an area which is at a different temperature than the area where it is to be operated. Allow one hour for each 5°F (2.7°C) temperature change before using the scale. After temperature stabilization, allow an additional 20 minutes after turning the scale on, for the scale electronics to stabilize.

Preventive Maintenance Checklist

The scale should be inspected and checked regularly, as follows:

1. Remove the Pan and Sub Pan to inspect and clean the area beneath the Pan.
2. Clean the outside of the scale using a damp cloth with warm water.



CAUTION

DO NOT USE CHEMICAL CLEANERS OR SOLVENTS OF ANY TYPE.
SOME CLEANERS ARE ABRASIVE AND MAY AFFECT THE SCALE'S FINISH.

3. Check the Power Cord for broken or damaged insulation.
4. If using batteries and the scale malfunctions, first replace the batteries to see if this resolves the problem. To isolate a problem with the rechargeable battery option kit, the scale can be converted back to standard alkaline batteries (see Rechargeable Battery Option User Manual).
5. Make a visual inspection for faulty connectors, wiring, and loose hardware.

3.2 OPENING THE SCALE

Opening the Navigator scale varies slightly according to the specific model, as detailed below. Use these procedures in order to replace the Load Cell, the Printed Circuit Board or other components.

Opening Navigator Models

Common hand tools are sufficient to disassemble the Navigator scales. Turn the scale off and unplug the power cord before you begin. Remove any installed batteries. On models with the Rechargeable Battery Option installed, the battery and the Recharge PCB must be removed. See the Rechargeable Battery Option Kit instructions for additional information.

1. Remove the stainless steel Weigh Pan.
2. Remove the conductive rubber cap over the Pan Support Screws.



NV Models



NVL and NVT Models

Figure 3-1 Pan Support Conductive Rubber Caps.

3. Remove the Pan Support by removing the two screws shown in Figure 3-1.
4. Remove the 5 screws holding the Top and Bottom Housings in place. (See Figure 3-2.)

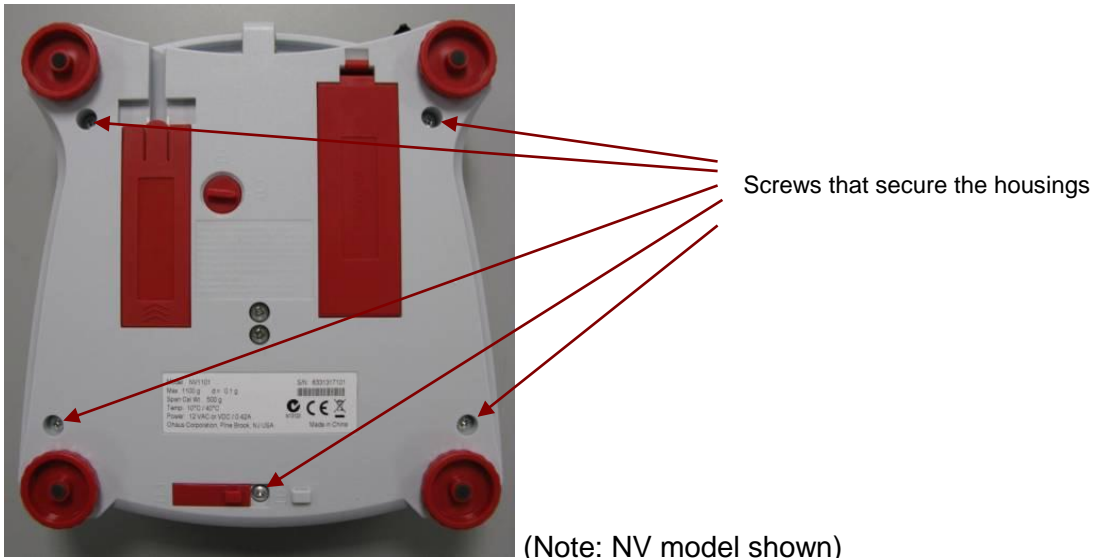

(Note: NV model shown)

Figure 3-2 Separating the Top and Bottom Housings

5. Turn the scale over and remove the upper housing.

3.3 REPLACING THE LOAD CELL

The Load Cell may need to be replaced because of scale instability, or because the scale does not calibrate or repeat, or because it is physically broken or displays an error code.

Disassembly:

1. Open the scale – see Section 3.2. Verify that there is no mechanical interference, pinched wire or bad solder connection that may be causing the load cell to appear defective.
2. Remove the Load Cell – turn the scale over, holding the Load Cell by hand, and remove the 2 load cell screws from the bottom housing. The NV model uses cross-recess screw heads (Phillips type) while the NVL and NVT use hex socket head screws.
3. Turn the scale back on its feet and gently lift off the Load Cell, the attached PCB and the AC Adapter cable. Place the Load cell and the PCB on a static protected work area.
4. The load cell connection is a five-wire cable that is soldered directly to the PCB. Before disconnecting the cable record the wire colors and their location on the PCB. (Hint: A digital picture is an easy and reliable record.) Disconnect the cable connecting the PCB to the Load Cell by unsoldering the 5 wires from the PCB. Take care not to over heat the PCB which will damage the thin PCB conductors.

Re-Assembly:

1. Re-solder the new load cell to the PCB, connection J3.

NOTE: The spare part Load Cell may not have the same wire color identifications as the original load cell. It is necessary to identify the wires from the table below.

J3 has 5 solder pads with the following connections (left to right); Shield, -EXE, -SIG, +SIG, +EXE.

TABLE 3-1. Load Cell Wire Color Identification

Spare Part Load Cell	Wire Color Identification	
Load cell,NV212	Shield	Bare wire with sleeve
Load cell,NV311	-EXE	Black wire
Load cell,NV511,NV1101,NV2101	-SIG	White wire
Load cell,NV3100	+SIG	Red wire
Load cell,NV4101,NV5101	+EXE	Green wire
Load cell,NVL20000		
	Shield	Bare wire with black sleeve
Loadcell,NVT1601,NVL511,NVL1101,NVL2101	-EXE	Black wire
Loadcell,NVT3200	-SIG	Red wire
Loadcell,NVT6400,NVL5101	+SIG	White wire
Loadcell,NVT10000,NVT16000,NVL10000	+EXE	Green wire

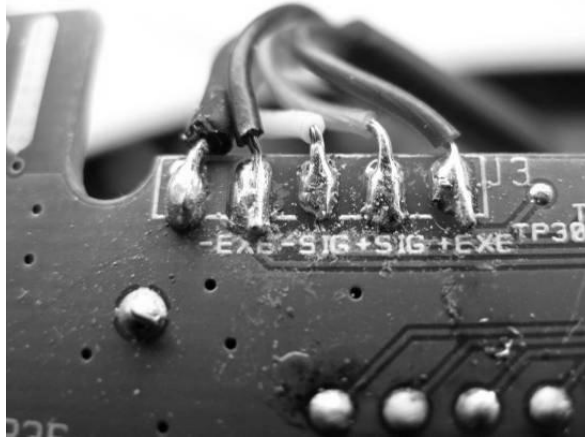

Figure 3-3 Load cell connections, J3

2. NV models and the NVL20000 model require a load cell spacer to be positioned between the load cell and the Base. Position the load cell back into the lower housing. NVL and NVT models, place a lock washer then a flat washer on the load cell screws (NV models do not use the washers.). Turn the scale over to install the (2) load cell screws. Loosely tighten the screws so that the load cell can be aligned in the housing. While holding the load cell, fully tighten the screws. The screws should be tight enough so that the load cell does not move when pushed from the side. Verify that the load cell is centrally located between the ribs.
3. Turn the scale over onto its feet. Position the PCB on to its locating pins. Coil the excess load cell cable in front of the load cell.
4. Slide the AC jack into its position in the lower housing. Route the AC adapter cable as shown in Figure 3-4.

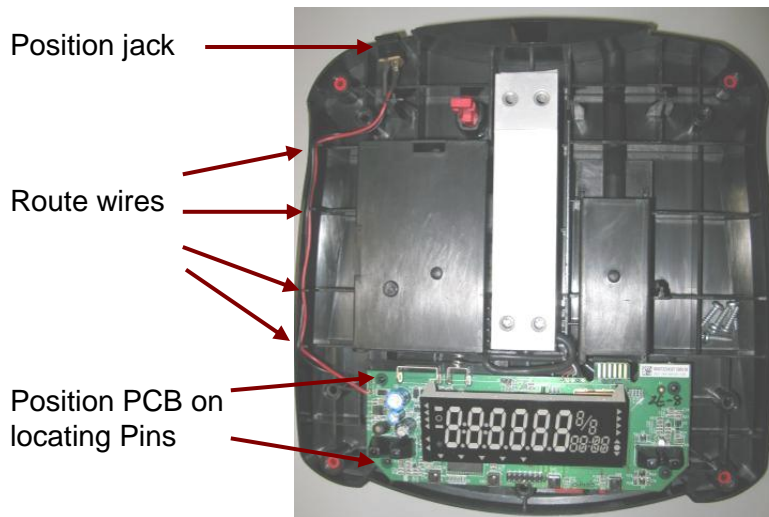

Figure 3-4 Position load cell, PCB and AC wires

5. To assemble the Housing, follow the steps in Section 3.2.1 in reverse order.

3.4 REPLACING THE PRINTED CIRCUIT BOARD AND DISPLAY

1. Open the scale – see Section 3.2.
2. Pick the PCB off its mounting pins and position the PCB upside-down so that the load cell wire connection is easy to access.
3. Disconnect the Load Cell cable from the PCB. The load cell connection is a five-wire cable that is soldered directly to the PCB. Before disconnecting the cable record the wire colors and their location on the PCB. (Hint: A digital picture is an easy and reliable record.) Disconnect the cable connecting the PCB to the Load Cell by un-soldering the 5 wires from the PCB. Take care not to over heat the PCB which will damage the thin PCB conductors.
4. Unsolder the AC Cable wires from the PCB.
5. Follow these steps in reverse order to install the new PCB.
6. Configure the Scale. (See Appendix C.)

Note: The PCB and the LCD Display are supplied as a single unit. However, if only the LCD Display needs replacement, it can be separated from the PCB by unsoldering the fine lead-wires connecting it to the PCB. When installing the new LCD Display, carefully feed the lead-wires through their holes, check that the new assembly is seated properly on the PCB and then solder the lead-wires.

3.5 REPLACING THE FUNCTION LABEL

The Function Label may need to be replaced. (See Chapter 5 for parts information.) Use a broad blade, such as a wide X-Acto™ knife, to remove the label. Clean the glue residue from the Housing surface. Then carefully place the new label where the old one was. (See Figure 3-8.)

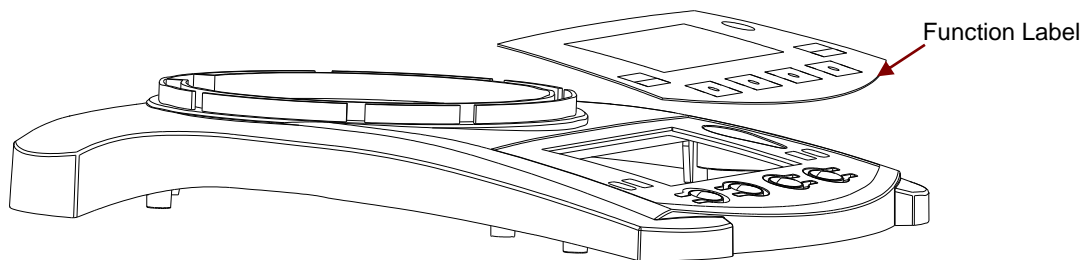

Figure 3-5. Function Label Removal

3.6 DOWN-STOP ADJUSTMENT

The purpose of the down-stops is to protect the load cell from physical damage. The down-stops are created by contacting bosses in the Base and adjustment screws or bosses in the Sub-Pan. The NV models have 3 down-stops, left, right and center near the load cell attachment to the Sub-Pan. The NVL and NVT models have 5 down-stops, left-front, left-rear, right-front, right-rear and center near the load cell attachment to the Sub-Pan.

NV models with capacity greater than 2kg and NVL / NVT models with a capacity greater than 10kg do not have adjustable down-stops. The down-stop bosses on the Sub-pan are designed to be at the correct distance to protect these load cells. The smaller capacity load cells require the down-stop clearance to be decreased for proper load cell protection. Adjustment screws are placed in the Sub-pan down-stop bosses to reduce the clearance, see figure 3-6.

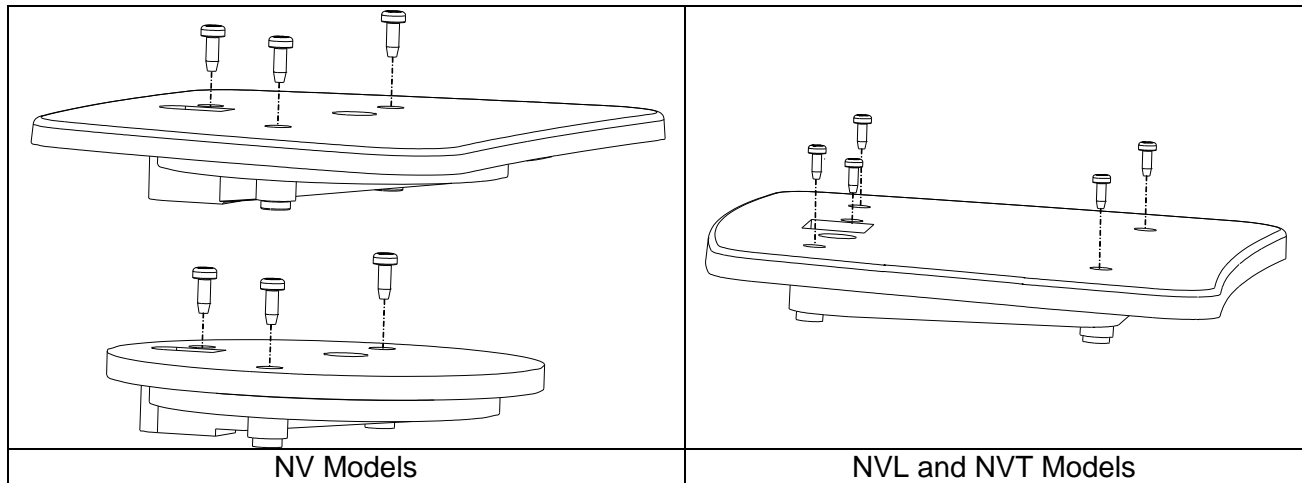

Figure3-6. Down Stop Adjustment Screws

To adjust the down-stops on the applicable models follow the procedures below. Models without adjustable down-stops need no action.

To ensure full weight reading:

The proper down-stop adjustment will allow full weight reading provided the center of the mass is less than $\frac{1}{2}$ the distance from the pan center to the pan edge. To allow for tolerance this adjustment is being done at 120% of scale capacity or at scale capacity but $\frac{3}{4}$ of the distance to the pan edge.

To protect the load cell:

To protect the load cell from physical damage the down-stops should touch at about 200% of scale capacity. Again to allow for adjusting tolerance the adjustment is made using a 150% weight.

The adjustment screws in the Sub-Pan can be adjusted with a #2 cross-recess (Phillips) screw driver. Each adjustment screw should contact the Base when 120% to 150% of the scale capacity is placed in the center of the 4 quadrants of the scale. The Top Housing must be removed to visually check if the down-stops are touching. Turn the adjustment screw counterclockwise to increase the clearance and clockwise to decrease the clearance.

An easy method to check the down-stop adjustment is to use the scales weight reading to detect if the down-stop is touching. This method can only check if the down-stop is set too close preventing accurate weighing.

1. Place 100% scale's capacity in the center of the Pan.
2. Note the reading.
3. Move the mass $\frac{3}{4}$ of the way (between the center and the edge) to the front of the Pan. Note any significant difference in the displayed weight reading.
4. Repeat the test for the back, left, and right position of the Pan.
5. If there was a weight reading change turn the adjustment screw nearest the quadrant counterclockwise $\frac{1}{4}$ turn. Repeat the test to see if it is corrected.
6. If the weight is placed at the edges of the pan there may be a weight change which indicates the down-stop is working and this is okay.

4 TESTING

Before and after servicing a Navigator scale, an operational test and various performance tests should be made to confirm that the scale meets specifications. Turn the scale on and allow it to warm up for at least one hour before performing these tests.



NOTE:

Make sure the test area is free from drafts and that the scale rests on a level and vibration-free surface.

4.1 TEST MASSES REQUIRED

The masses required to test the Ohaus Navigator scales must meet the requirements of ASTM Class 4 or OIML F2 Tolerance. The mass values are listed in Table 4-1.

TABLE 4-1 CALIBRATION MASS VALUES

Model	Span Calibration mass	Linearity Calibration masses
NV212	200g	100g, 200g
NV311(N or M)	200g	200g, 300g
NV511	300g	300g, 500g
NV1101	500g	500g, 1000g
NV2101	1kg	1kg, 2kg
NV3100(N or M)	2kg	2kg, 3kg
NV4101	2kg	2kg, 4kg
NV5101	3kg	3kg, 5kg
NVL511	300g	300g, 500g
NVL1101	500g	500g, 1000g
NVL2101	1kg	1kg, 2kg
NVL5101	3kg	3kg, 5kg
NVL10000	5kg	5kg, 10kg
NVL20000	10kg	10kg, 20kg
NVT1601	1kg	1kg, 1.5kg
NVT1601(N or M)	1kg	1kg, 1.5kg
NVT3201	2kg	2kg, 3kg
NVT3200(N or M)	2kg	2kg, 3kg
NVT6400(N or M)	5kg	3kg, 6kg
NVT6401	5kg	3kg, 6kg
NVT10001	5kg	5kg, 10kg
NVT16000	10kg	10kg, 15kg
NVT16000(N or M)	10kg	10kg, 15kg

4.2 OPERATIONAL TEST

- 1 Connect a functioning Power Adapter to the scale power receptacle located on the bottom of the scale, or install the required batteries.
- 2 Plug the Power Cord into a suitable power source.

4.3 SEGMENT DISPLAY TEST

Turn the scale on, and ensure that all segments are enabled and displayed briefly. This is a Segment Display Test. (See Figure 4-1 and Figure 4-2)

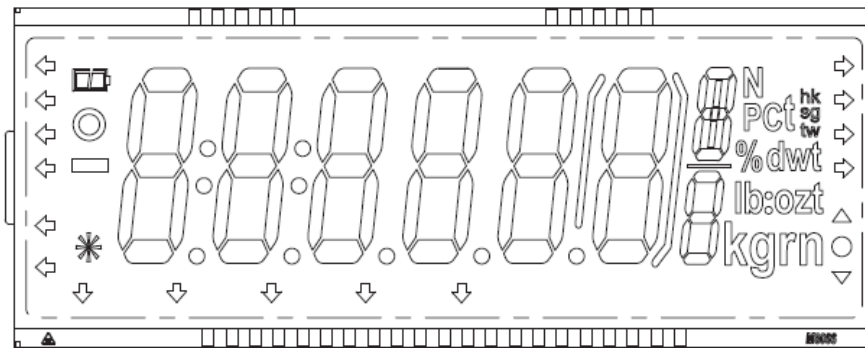

Figure 4-1 LCD Segment Display

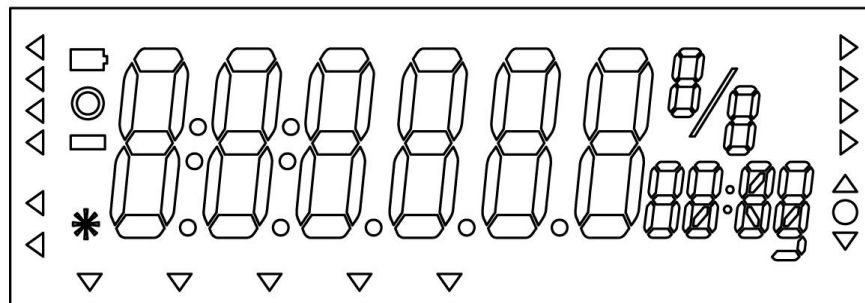

Figure 4-2 LED (old) Segment Display

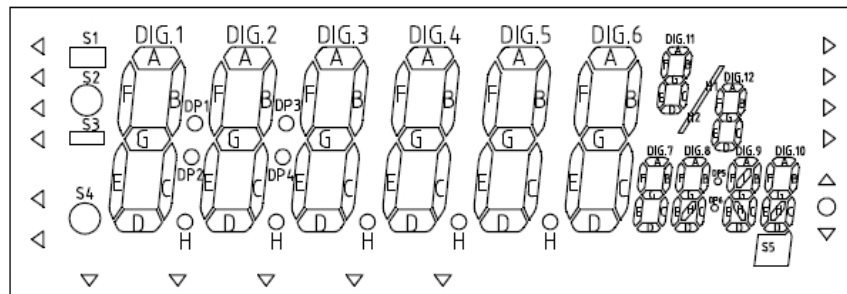

Figure 4-3 LED (new) Segment Display

4.4 LOAD CELL TEST USING RAMP

To test the Load Cell using RAMP, see Appendix B.

4.5 PERFORMANCE TESTS

Accurate performance of the Navigator scales is determined by a series of four performance tests. The displayed readings are compared with the tolerances listed in Tables 4-2 and 4-3. Tolerance values are expressed in counts. A one-count difference is shown in the last digit on the scale display.

TABLE 4-2 TOLERANCES

Model	Precision (d)	Repeatability (d)	Linearity (d)	OCL
NV212	±1	2	±2	±3
NV311(N or M)	±1	1	±2	1 MPE
NV511	±1	2	±2	±3
NV1101	±1	2	±2	±3
NV2101	±1	2	±2	±3
NV4101	±1	2	±2	±3
NV5101	±1	2	±2	±3
NVL511	±1	2	±2	±3
NVL1101	±1	2	±2	±3
NVL2101	±1	2	±2	±3
NV3100(N or M)	±1	1	±2	1 MPE
NVL5101	±1	2	±2	±3
NVL10000	±1	2	±2	±3
NVL20000	±1	2	±2	±3
NVT1601	±1	2	±2	±3
NVT1601(N or M)	±1	1	±2	1 MPE
NVT3201	±1	2	±2	±3
NVT3200(N or M)	±1	1	±2	1 MPE
NVT6400(N or M)	±1	1	±2	1 MPE
NVT6401	±1	2	±2	±3
NVT10001	±1	2	±2	±3
NVT16000	±1	2	±2	±3
NVT16000(N or M)	±1	1	±2	1 MPE

NOTE:

The following performance tests are used to evaluate scale operation before and after repairs. The scale must meet the requirements specified in each test as well as the specifications listed in Table 4-2. Before proceeding with the following tests, the scale should be calibrated. (See Appendix A)

4.5.1 Precision Test

The Precision Test is a quick test that measures the deviation of a limited number of weight readings, which should match the specification for each model, listed in Tolerance Table 4-2.

1. Power on the balance. The reading on the display should be 0g.
2. Select a mass weighing near the maximum capacity of the balance, and place it on the center of the Pan. Observe and record the reading.
3. Remove the mass. The reading should return to 0g ± the precision tolerance in Table 4-2.

4. Repeat this test three times. The readings should be within tolerances. If so, the balance passes the Precision Test.
5. If the deviation for any set of readings (using the same mass placed on the center of the Pan) is greater than the tolerance listed in Table 4-2, the balance does not meet the precision specification. Inspect and correct the following areas:
 - Check for mechanical obstructions. Any foreign object touching any part of the moving assemblies will cause a balance to fail the Precision Test. Inspect and correct as necessary.
 - If the scale does not meet specifications, move it to a suitable location, ensure that it is level, and try again. If it still does not meet specifications, perform a service calibration, and try again. (See Appendix B for Service Calibration.)
 - If the scale does not pass this test, the Load Cell may need to be replaced.

4.5.2 Repeatability Test

The repeatability specification is defined as the Standard Deviation value derived from a set of weight readings. This test uses more weight data than the Precision Test and will allow for occasional weight deviations due to testing variations.

Requirements:

- To perform this test a single mass must be used for all readings.
- The test mass should be approximately ½ of the capacity of the instrument.
- Wear gloves when handling the mass.

Set Up:

Before starting a repeatability test, set up the instrument as follows.

Enter the service menu (see appendix B.1) and adjust and record the following settings:

- A. Set the Stability setting to 0.5d (its lowest setting).
- B. Set the Filter level to L2 (close to mid range).
- C. Set the AZT (Auto Zero Tracking) to .5d (its lowest setting). Do not turn it off.

Enter the User Menu (see 1.8.1) and adjust the following settings:

- A. Set the instrument to display the same units as the performance specifications. (Usually kg, g, or mg)

Record Settings:

Stability Setting = _____
Filter Level Setting = _____
Auto Zero Tracking Setting = _____
Displayed Units = _____
Mass Used = _____

Test Procedure:

1. Zero the instrument.
2. Using a test mass approximately half the capacity of the instrument, place the mass on the center of platform. Record the reading on the worksheet provided.
3. Remove the mass from the platform.
4. Repeat this test starting at Step 1 until you record a total of ten readings

Fill in the worksheet (Table 4-3) with the ten (10) readings.

TABLE 4-3. REPEATABILITY WORKSHEET

n	Reading	Delta = Reading – Mean	Delta x Delta
1			
2			
3			
4			
5			
6			
7			
8			
9			
10			
n = number of Reading Mean = Sum of readings / 10 Delta = Reading – Mean Standard Deviation = Square Root of (sum of (Delta x Delta) / 9)			

5. Add the ten readings and divide the total by 10 to find the Mean (average).
6. Mean = (Reading 1 + Reading 2 + Reading 3 + Reading 4 + Reading 5
7. + Reading 6 + Reading 7+ Reading 8 + Reading 9 + Reading 10) / 10

Mean = _____

6. Calculate the Delta for each reading and record in the work sheet.

Delta = Reading – Mean

7. Calculate the Delta x Delta for each reading and record in worksheet.
8. Add the ten Delta x Delta values and divide by 9
9. Calculate the Standard Deviation by applying the square root of the result from step 8.

Standard Deviation = _____

Note: If the balance does not meet specifications, move it to a suitable location, ensure that it is level, and try again. If it still does not meet specifications, perform a service calibration, and try again. (See Appendix B for Service Calibration)

4.5.3 Linearity Test

This test is used to determine the linearity of the unit throughout its operating range. The masses used to perform this test can be utility masses.



NOTE:

The scale must pass the Precision and Repeatability Tests, and be calibrated before the Linearity Test may be performed.

TABLE 4-4 LINEARITY TEST MASSES

Model	Reference Wt.	Load 1	Load 2	Load 3
NV212	50g	50g	100g	150g
NV311(N or M)	75g	75g	150g	225g
NV511	125g	125	250g	375g
NV1101	250g	250g	500g	750g
NV2101	500g	500g	1000g	1500g
NV4101	1000g	1000g	2000g	3000g
NV5101	1250g	1250g	2500g	3750g
NVL511	125g	125	250g	375g
NVL1101	250g	250g	500g	750g
NVL2101	500g	500g	1000g	1500g
NV3100(N or M)	750g	750g	1500g	2250g
NVL5101	1250g	1250g	2500g	3750g
NVL10000	2500g	2500g	5000g	7500g
NVL20000	5000g	5000g	10000g	15000g
NVT1601	400g	400g	800g	1200g
NVT1601(N or M)	400g	400g	800g	1200g
NVT3201	750g	750g	1500g	2250g
NVT3200(N or M)	750g	750g	1500g	2250g
NVT6400(N or M)	1500g	1500g	3000g	4500g
NVT6401	1500g	1500g	3000g	4500g
NVT10001	2500g	2500g	5000g	7500g
NVT16000	4000g	4000g	8000g	12000g
NVT16000(N or M)	4000g	4000g	8000g	12000g

NOTE: All masses are nominal values. Be certain to use the same reference mass throughout the procedure.

2. Place the test mass on the Scale, record the weight and remove.
3. Place Load 1 on the Scale and press TARE.
4. Place the test mass on the Scale, record the weight and remove.
5. Place Load 2 on the Scale and press TARE.
6. Place the test mass on the Scale, record the weight and remove.
7. Place Load 3 on the Scale and press TARE.
8. Place the test mass on the Scale and record the weight.

9. The difference in the weights of the test mass should be within the tolerance in Table 4-2. If the differences are out of tolerance, calibrate (see Appendix A.1) and repeat the test.
10. If the Scale remains out of tolerance, the Load Cell may need to be replaced.

4.5.4 Off-Center Load Test

The Off-Center Load Test is used to determine whether displayed weight values are affected by moving the sample to different areas of the Pan.

11. Place half of the scale’s capacity in the center of the Pan.
7. Note the reading.
8. Move the mass halfway (between the center and the edge) to the front of the Pan. Note any differences in the displayed weight reading.
9. Repeat the test for the back, left, and right position of the Pan.
10. Maximum allowable change in displayed weight readings for each of the four positions can be found in Specifications Tables (Chapter 1). If this maximum is exceeded, follow procedures in Section 4.5.5, Adjusting Off Center Load.

4.5.5 Adjusting Off Center Load

If the Off Center Load (OCL) is excessive, perform adjustment as follows:

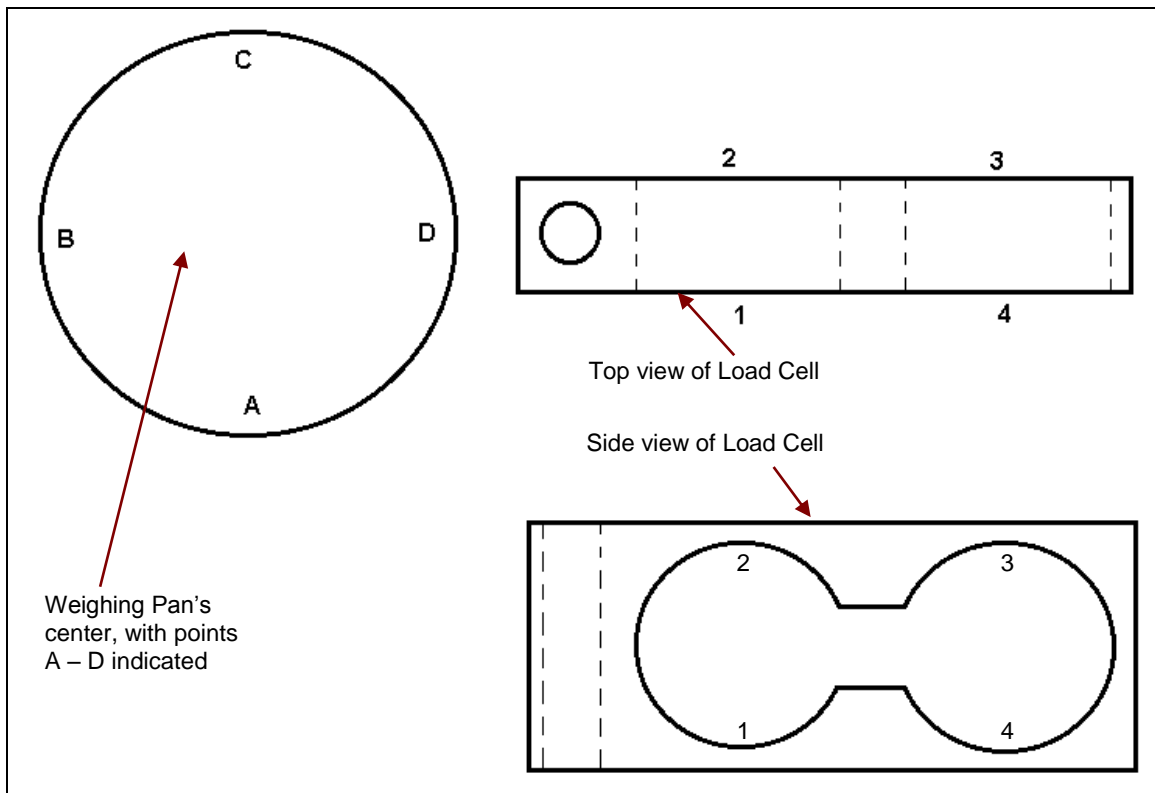

Figure 4-4. Navigator Load Cell and Weighing Pan

1. Place the test weight in the center of the Weighing Pan.
2. Tare the balance.
3. Move the weight to point A and record the reading.

CHAPTER 4 TESTING

4. Move the weight to point B and record the reading.
5. Move the weight to point C and record the reading.
6. Move the weight to point D and record the reading.
7. If the reading at point A is negative, file at points 1 and 4 AT AN ANGLE.
8. If the reading at point B is negative, file at points 1 and 2 STRAIGHT ACROSS.
9. If the reading at point C is negative, file at points 2 and 3 AT AN ANGLE.
10. If the reading at point D is negative, file at points 3 and 4 STRAIGHT ACROSS.
11. Repeat 1 to 10 until within specifications.



Note: It is not recommended that you try to adjust more than -5 counts if the beam has been filed already. If the beam has not been filed previously, you can adjust -10 counts. Remember, when filing you are weakening the beam. File a little at a time.

5 PARTS LISTS & DIAGRAMS

This section of the manual contains exploded views for the Navigator series scales. The exploded view drawings are designed to identify the parts which can be serviced on the scale in the field.

NOTE:

In all cases where a part is replaced, the scale must be thoroughly checked after the replacement is made. The scale **MUST** meet the parameters of all applicable specifications in this manual.

If further technical information is needed, please contact your local Ohaus distributor, or:

Ohaus Corporation, www.ohaus.com
7 Campus Drive
Suite 310
Parsippany, NJ 07054 USA

Tel: 973-377-9000

Fax: 973-944-7177

In the United States call toll free, 800-526-0659 between 8:00 a.m. and 6:00 p.m. EST.

5.1 HOUSING & INTERNAL PARTS

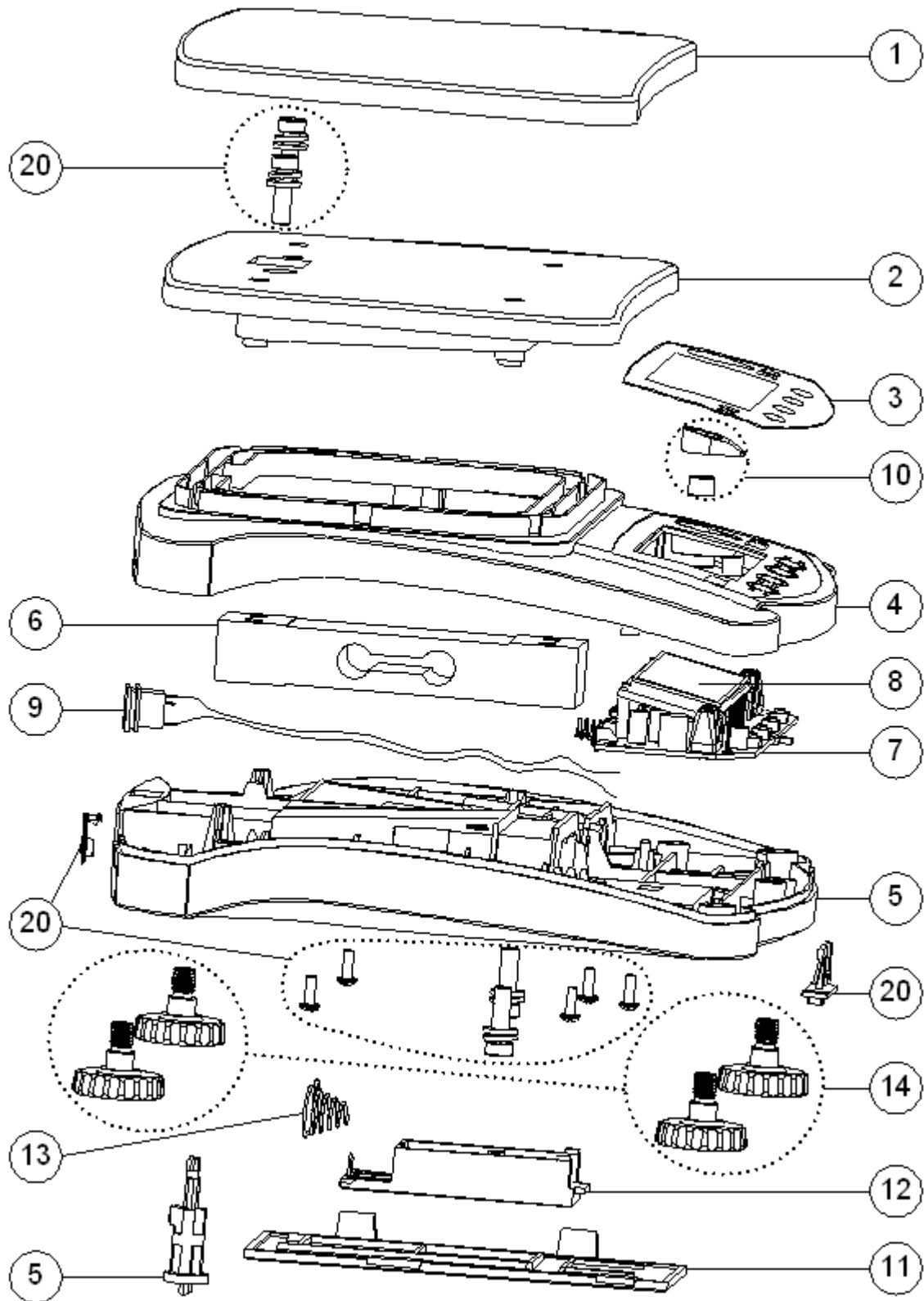

Figure 5-1. Navigator NVL and NVT: Housing & Internal Parts

TABLE 5-1 HOUSING & INTERNAL PARTS

Drawing Item	Description
1	Pan
2	Pan Support
3a	Function Label, LCD
3b	Function Label, LED
4	Housing, Top, No Labels
5	Housing, Bottom (Shipping Lock)
6	Load Cell
7a	Main PCB, LCD
7b	Main PCB, LED
8a	LCD Display and Backlight
8b	LED Display
9	Cable Kit (Power Adapter Jack Cable shown)
10	Level Bubble and Light Guide
11	Battery Cover
12	Interface Cover
13	Battery Connection Spring
14	Feet
20	Hardware Kit
Not shown	Power Adapter (no plugs)
Not shown	Power Adapter Plug Set
Not shown	Packaging, Insert
Not shown	Box, Shipping

APPENDIX A. STANDARD CALIBRATION

A.1 SPAN CALIBRATION

Standard calibration should be performed prior to using a scale, and after service. See Section 4.1 for Calibration Masses required for each model.

Note: This menu is locked out in Legal for Trade applications. To regain access, see Section 1.7.



Note:

Be careful not to touch the scale or the table while calibration is in progress, as it will cause the process to fail.

1. With scale powered on, press and hold the **MENU** button until *MENU* appears. When the button is released *.CAL.* will then be displayed.



2. Press **Yes** to enter the sub-menu. *SPAN* will be the first menu item. Press **Yes** again to accept, the display will show a flashing *--L--* while the zero point weight data is stored.

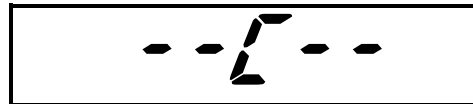

3. The specified calibration weight value will appear. Place the weight on the pan. Note: Early production scales (e.g SW version 1.02) require a **Yes** press to start the calibration. The display shows *--L--* while the span point weight data is stored.



4. When calibration is complete, the display shows *done*, and then returns to the previous application mode and scale is ready for use.



NOTE: If calibration fails, ensure that the test area is free from drafts and the surface the scale rests on is level and free of vibrations. Then try to calibrate again. If it continues to fail, there may be an internal problem. To resolve internal problems, follow procedures in Chapters 2 and 3.

A.2 LINEARITY CALIBRATION

Note: This menu is locked out in Legal for Trade applications. To regain access, see Section 1.7.

See Section 4.1 for Calibration Masses required for each model.



Note:

Be careful not to touch the scale or the table while calibration is in progress, as it will cause the process to fail.

1. With scale powered on, press and hold the **MENU** button until *MENU* appears. When the button is released *.CAL.* will then be displayed.



2. Press **Yes** to enter the sub-menu. *SPAN* will be the first menu item. Press **No** to advance to the *L IN* menu item.

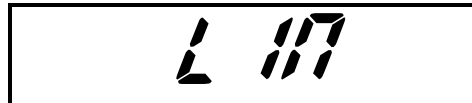

3. Press **Yes** to accept, the display will show a flashing *--L--* while a zero point weight data is stored.

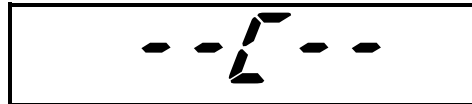

4. The first linearity calibration point weight value will appear. Place the weight on the pan. Note: Early production scales required a **Yes** press to continue.



The display shows *--L--* while the weight data is stored.

5. The second linearity point weight value will appear. Place the weight on the pan. Note: Early production scales (e.g SW version 1.02) require a **Yes** press to start the calibration.



The display shows *--L--* while the weight data is stored.

6. When calibration is complete, the display shows done, and then returns to the previous application mode and scale is ready for use.



NOTE: If calibration fails, ensure that the test area is free from drafts and the surface the scale rests on is level and free of vibrations. Then try to calibrate again. If it continues to fail, there may be an internal problem. To resolve internal problems, follow procedures in Chapters 2 and 3.

APPENDIX B. SERVICE MENU

This section describes the Service Menu and sub-menus, which allow authorized service personnel to perform factory Linearity and Span calibrations (no pre-set limits).

B.1 ENTERING THE SERVICE MENU

Turn the scale off.

Enter the Service Menu by pressing and holding **Zero/On** and **Tare** together until **RAMP** appears. This will take approximately 8 seconds. Press **Yes** to select **Ramp**.



B.2 RAMP

The ramp display shows the percentage of use of the A to D circuit, that is, of the temperature-compensated duty cycle. The actual value is not as important as how it changes. It should increase as the weight on the scale is increased. The ramp display should remain constant without fluctuations.

If you press **Yes** to select **Ramp**, a number appears. It should be constant. Add masses from minimum to maximum capacity. The reading will increase, but should not fluctuate. The example at right is with no weight on the Pan. It will vary with other scales. To exit the ramp function, press **Yes**. The scale advances to the **Linear** calibration menu. Press **Yes** to perform Linear Calibration.

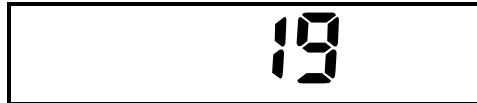

B.3 LINEAR CALIBRATION

Linear calibration automatically follows Ramp. To start from the Service Menu, press and hold **Zero/On** and **Tare** together. As the scale powers up, **RAMP** appears. Press **No** to bypass Ramp. Service Linearity does not have limit ranges on the weights used as does the standard user linearity procedure.



Note:

Be careful not to touch the scale or the table while calibration is in progress, as it will cause the process to fail.

When **L IN** appears, press **Yes**.

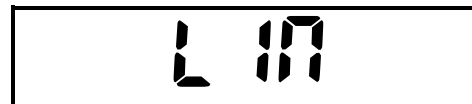

The display shows **--[--** while the scale acquires the zero point weight data.

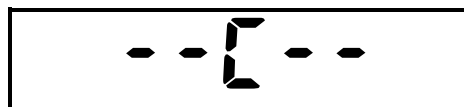

The display then shows the first calibration point value. Place the indicated weight on the Pan, and press **Yes**.



The display shows **--[--** while the scale acquires the weight data.

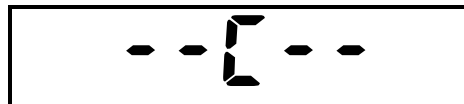

After the first calibration point value is acquired, the display shows the second calibration point value.



Pressing **Yes** after placing the prompted weight accepts the second linearity calibration point weight. The display shows **--[--** while the scale acquires the weight data.

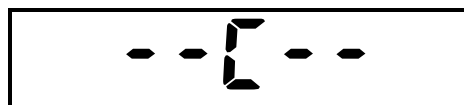

After the second linearity calibration point weight value is acquired, the display shows **done** for 2 seconds and advances to **SPAN**.



Press **Yes** to confirm a span calibration.



B.4 SPAN CALIBRATION

Span calibration from the service menu allows you to set a new zero and maximum setting. This is distinct from user level span calibration, which allows a user to adjust the zero and maximum setting within the range established by the service menu span setting.

Span calibration automatically follows linear calibration. To start from the Service Menu, press and hold **Zero/On** and **Tare** together. As the scale powers up, **RAMP** appears. Press **No** to bypass Ramp, when **L in** appears press **No**.

SPAN appears. Press **Yes**.



The display shows **--[--** while the scale acquires the zero point weight value.

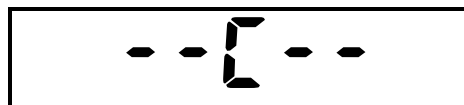

The specified span weight flashes. Place the indicated weight in the center of the Pan.



Pressing **Yes** after placing the prompted weight accepts the span weight shown on the display. The display then shows **--[--** while the scale acquires the span point

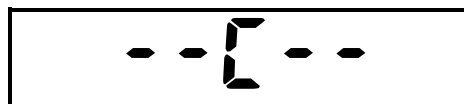

weight data.

After the span value is acquired, the display shows **done** for 2 seconds and advances to **GEO**. (To exit the Service Menu, press **No** until **End** appears. Then press **Yes**.)



NOTE: If calibration fails, ensure that the test area is free from drafts and the surface the scale rests on is level and free of vibrations. Then try to calibrate again. If it continues to fail, there may be an internal problem. To resolve internal problems, follow procedures in Chapters 2 and 3.

B.5 GEOGRAPHICAL ADJUSTMENT FACTOR (GEO)

The Geo Factor adjustment allows entry of values from 0 to 31 and is used to compensate for slight variations in gravity at different geographical locations around the world.

This feature allows authorized personnel to accurately calibrate the scale at a location other than the location where the scale is to be used. Prior to calibration, the Geo Factor is set to correspond to the geographical location where the calibration is being performed. Following calibration, the Geo Factor is changed to match the location where the scale is to be used. If required, the scale may also be sealed according to the required approval regulations.



NOTE:

Only an authorized manufacturer's representative or certified verification personnel should make these changes. Changing the Geo Factor alters the calibration values.

In the Service Menu, press **No** until **GEO** appears.

Press **Yes** to edit the GEO setting. The current setting is the first to be shown.

NOTE: Factory setting for GEO is 13 in general and 19 for Europe



See Appendix D to determine the correct Geo value. Values from 1 to 31 are available. **No** will increase the GEO value while **Back** will decrease it. Press **Yes** to accept the value shown on the display. The menu returns to the next item, **Filter**



B.6 FILTER SETTINGS

There are four filter settings.

- | | | |
|----|-----------------|--|
| L1 | High filtering | The display will change slower as the scale analyzes more data before making display changes. This is used in less than ideal conditions where the scale display is changing too often. |
| L2 | Default | This factory setting that is useful for most situations. |
| L3 | Lower filtering | The display will update quicker than the factory default setting. |
| L4 | Low filtering | The display will update rapidly. This setting is only useful where the weighing conditions are optimal and when fast response is needed. The stability indication will have a difficult time indicating a stable weight at this setting. |

In the Service Menu, press **No** until **F ILT** appears.

Press **Yes** to enter the **Filter** setting menu.

The current filter setting is displayed. Press **No** to increment the setting.

Press **Yes** to accept the displayed value and advance to the next menu item, **Stability**.

B.7 STABILITY SETTING

There are four stability settings.

- | | |
|------|--|
| 0.5d | This setting requires the weight reading to vary less than 0.5d for the stable indicator to be on. This setting will require more time for the stable indication. Less than ideal weighing conditions may prevent stable indication. |
| 1d | This factory setting that is useful for most situations. |
| 2d | The stable indication will come on quicker than the factory default setting. |
| 5d | This setting is useful where the weighing conditions are less than optimal and when fast stable indications are needed. |

In the Service Menu, press **No** until **StAb** displays.

Press **Yes** to enter the stability setting menu.

The current stability setting is displayed.

Press **No** to increment the setting. Press **Yes** to accept the displayed value and advance to the next menu item, **A-Zero**.

B.8 AUTO ZERO SETTING

APPENDIX B THE SERVICE MENU

There are four settings for the automatic zero setting mechanism (AZSM).

- 0.5d The display will maintain a zero indication if the scale does not detect a change of more than 0.5d. This is the factory default.
- 1d The display will maintain a zero indication if the scale does not detect a change of more than 1d.
- 3d The display will maintain a zero indication if the scale does not detect a change of more than 3d.
- OFF The setting will disable the automatic zero setting mechanism (AZSM). This is generally used for testing purposes only.

In the Service Menu, press **No** until **A-ZEr0** displays.

Press **Yes** to enter the auto zero setting menu.

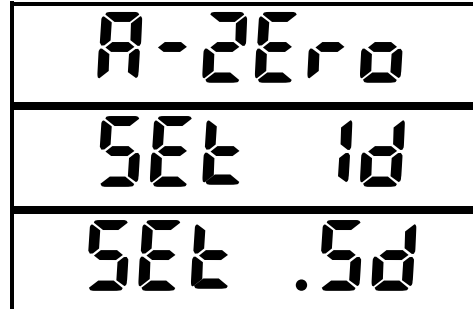

The current auto zero setting is displayed.

Press **No** to increment the setting. Press **Yes** to accept the displayed value and advance to the next menu item, **LFT**.

B.9 EXPANDED RESOLUTION (E.PAnd)

E.PAnd sets the readability to $1/10^{\text{th}}$ of the standard readability. (That is, if standard readability is .01, with **E.PAnd** on it would be .001.) Raw scale data is displayed, zero, tare and other modes/functions will not operate.

In the Service Menu, press **No** until **E.PAnd** appears.

Press **Yes** to enter the **E.PAnd** setting menu, **OFF** appears. Press **No** to toggle the setting, **On** appears.

Pressing **Yes** again accepts the **On** setting. When the Service Menu is exited the scale will read with expanded resolution until it is turned off in the Service Menu.

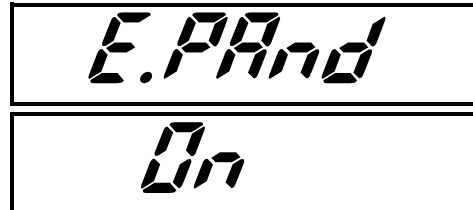

B.10 RESET

rESEt returns the scale to its factory default conditions. All the user and service settings will return to the factory defaults. All reference weights, average piece weights and set points will be reset.

In the Service Menu, press **No** until **rESEt** appears.

Press **Yes** to enter the **rESEt** setting menu, **No** appears. Press **No** to toggle the setting, **YES** appears.

To accept a chosen setting (either **No** or **Yes**) press **Yes**. The display will advance to the next menu item, **End**.

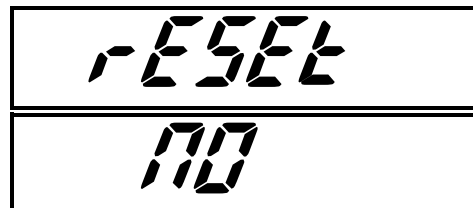

B.11 END

Accepting **End** will exit the Service Menu.
In the Service Menu, press **No** until **End** appears.

Press **Yes** to exit the service menu or **No** to advance to the ramp menu setting. When the Service Menu is exited the scale will return to the last active mode with any changes from the Service menu.



APPENDIX C. SOFTWARE SERVICE TOOL INSTRUCTIONS

The Software Service Tool (Part Number 83032124) is required when a main PC Board is replaced in a Navigator scale. It is used to re-configure the scale to its original parameters in the case of a PCB replacement.

The latest software service tool and support files are available on the Ohaus DMX site.

A personal computer running the Microsoft Windows operating system, Windows NT 4.0 or later, or Windows 98 or later, is required. A RS232 communications port is needed.

An RS232 Interface Kit (PN 83032107, 72206287 or 71147376)

C.1 HARDWARE AND SOFTWARE SETUP

1. First, check that the scale's **A-Off** feature, under the **SETUP** menu, is set to **OFF**. If this setting is left **ON**, the scale will shut off during configuration.
2. Install the RS232 Interface Kit into the scale. Follow the instructions in the RS232 Interface Kit User Manual.
3. Plug the cable into the PC's RS232 port.
4. Install the software on the PC.
5. Download the Service Software ZIP file from the Ohaus DMX Navigator directory.
6. Place the Zip file in its own directory on the PC, un-Zip the file.
7. Run the program Service Tool by double clicking the "exe" application file. Figure C-1 will appear.

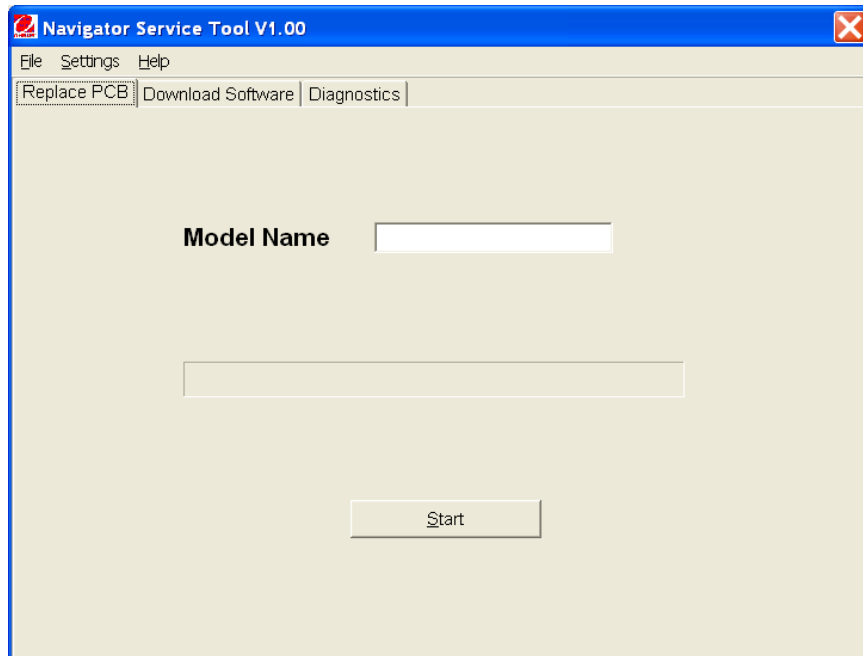

Figure C-1. First screen of the Navigator Service Tool

8. Click **Settings** on the tool bar then select **Com Port** from the dropdown menu. Set the "Port" to match where the RS232 is connected to the PC. Set baudrate, data and parity to match the settings of the scale. If these settings are unknown check the RS232 Menu in the scale. Note: In the scale user menu, data and parity are combined in the Parity menu selection (e.g. 7-none). The scale settings shown in Fig.C-2 are the default values for Navigator.

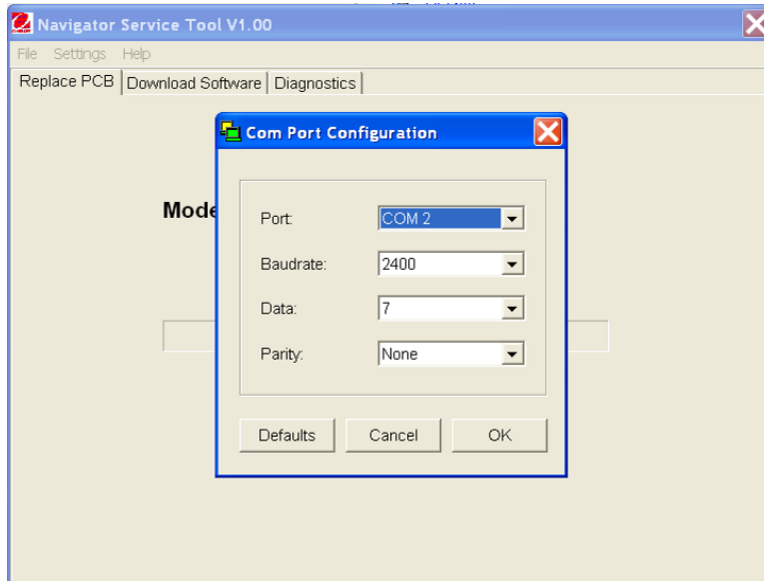

Figure C-2. Com Port Configuration screen

9. Click the **Diagnostics** tab to test the communications. (See Figure C-3.)

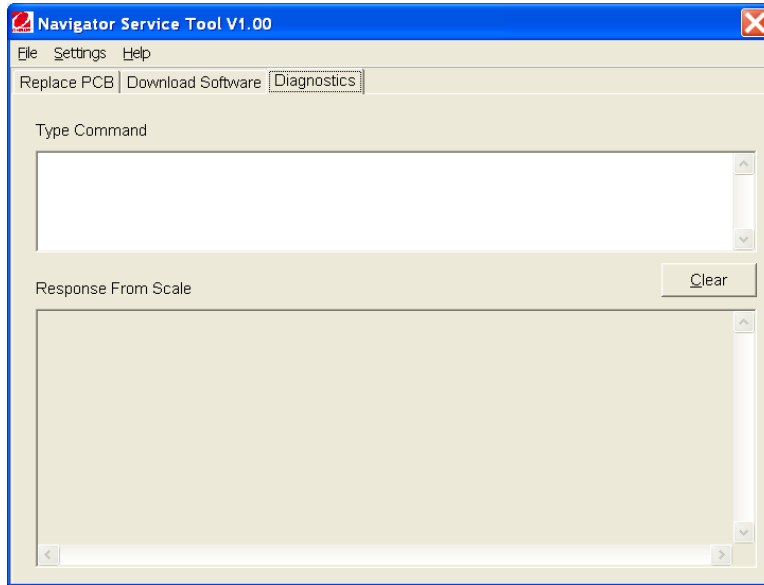

Figure C-3. Diagnostic screen

- Enter a “P” command. The scale should respond with a weight value (e.g., 0.2g). Enter a “V” command. The response should be the software version (e.g., Sr: 1.03).

C.2 DEFINING LED DISPLAY VERSION

If the software version has been updated to version 1.04 or later, the following commands needs to be sent to the scale to define the LED display version. Please refer to Figure 1-3 for LED version.

Old LED version:

- 1: MFG Enable service mode.
- 2: (esc)OLED Define current display as old LED display, store this data into EEPROM.

New LED version:

- 1: MFG Enable service mode.
- 2: (esc)NLED Define current display as old LED display, store this data into EEPROM.

C.3 CONFIGURING THE SCALE

If the PC Board has been replaced, the scale needs to be configured. The software tool will send the PCB the required data for the Model Name entered.

1. When communications are reliable, return to the **Replace PCB** tab.
2. To configure the scale, enter the model name that appears on the Data Label (e.g. NVL5101, See figu.C-4) in the **Model Name** text box (See Fig.C-5).

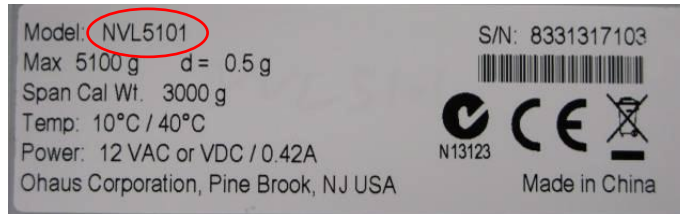

Figure C-4. Model Name on Data Label

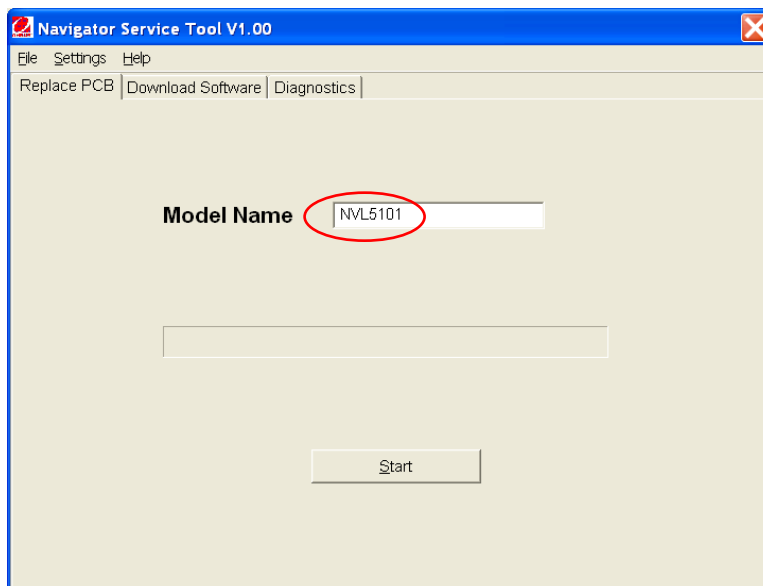

Figure C-6. Model Name entered

3. Click **Start**.
4. The bar is a graphical measure of the configuration progress.
5. When the downloading is complete, turn the scale off.
6. Turn the scale on and perform a Service Calibration (see Appendix B), followed by Operational and Performance tests (Chapter 4).

APPENDIX D. GEOGRAPHICAL ADJUSTMENT VALUES

TABLE D-1. GEOGRAPHICAL ADJUSTMENT VALUES.

Geographical latitude away from the equator (North or South), in degrees and minutes.	Elevation above sea level in meters										
	0 325	325 650	650 975	975 1300	1300 1625	1625 1950	1950 2275	2275 2600	2600 2925	2925 3250	3250 3575
	Elevation above sea level in feet										
	0 1060	1060 2130	2130 3200	3200 4260	4260 5330	5330 6400	6400 7460	7460 8530	8530 9600	9600 10660	10660 11730
0°00' - 5°46'	5	4	4	3	3	2	2	1	1	0	0
5°46' - 9°52'	5	5	4	4	3	3	2	2	1	1	0
9°52' - 12°44'	6	5	5	4	4	3	3	2	2	1	1
12°44' - 15°06'	6	6	5	5	4	4	3	3	2	2	1
15°06' - 17°10'	7	6	6	5	5	4	4	3	3	2	2
17°10' - 19°02'	7	7	6	6	5	5	4	4	3	3	2
19°02' - 20°45'	8	7	7	6	6	5	5	4	4	3	3
20°45' - 22°22'	8	8	7	7	6	6	5	5	4	4	3
22°22' - 23°54'	9	8	8	7	7	6	6	5	5	4	4
23°54' - 25°21'	9	9	8	8	7	7	6	6	5	5	4
25°21' - 26°45'	10	9	9	8	8	7	7	6	6	5	5
26°45' - 28°06'	10	10	9	9	8	8	7	7	6	6	5
28°06' - 29°25'	11	10	10	9	9	8	8	7	7	6	6
29°25' - 30°41'	11	11	10	10	9	9	8	8	7	7	6
30°41' - 31°56'	12	11	11	10	10	9	9	8	8	7	7
31°56' - 33°09'	12	12	11	11	10	10	9	9	8	8	7
33°09' - 34°21'	13	12	12	11	11	10	10	9	9	8	8
34°21' - 35°31'	13	13	12	12	11	11	10	10	9	9	8
35°31' - 36°41'	14	13	13	12	12	11	11	10	10	9	9
36°41' - 37°50'	14	14	13	13	12	12	11	11	10	10	9
37°50' - 38°58'	15	14	14	13	13	12	12	11	11	10	10
38°58' - 40°05'	15	15	14	14	13	13	12	12	11	11	10
40°05' - 41°12'	16	15	15	14	14	13	13	12	12	11	11
41°12' - 42°19'	16	16	15	15	14	14	13	13	12	12	11
42°19' - 43°26'	17	16	16	15	15	14	14	13	13	12	12
43°26' - 44°32'	17	17	16	16	15	15	14	14	13	13	12
44°32' - 45°38'	18	17	17	16	16	15	15	14	14	13	13
45°38' - 46°45'	18	18	17	17	16	16	15	15	14	14	13
46°45' - 47°51'	19	18	18	17	17	16	16	15	15	14	14
47°51' - 48°58'	19	19	18	18	17	17	16	16	15	15	14
48°58' - 50°06'	20	19	19	18	18	17	17	16	16	15	15
50°06' - 51°13'	20	20	19	19	18	18	17	17	16	16	15
51°13' - 52°22'	21	20	20	19	19	18	18	17	17	16	16
52°22' - 53°31'	21	21	20	20	19	19	18	18	17	17	16
53°31' - 54°41'	22	21	21	20	20	19	19	18	18	17	17

APPENDIX D GEOGRAPHICAL ADJUSTMENT VALUES

TABLE D-1. GEOGRAPHICAL ADJUSTMENT VALUES.

Geographical latitude away from the equator (North or South), in degrees and minutes.	Elevation above sea level in meters										
	0 325	325 650	650 975	975 1300	1300 1625	1625 1950	1950 2275	2275 2600	2600 2925	2925 3250	3250 3575
	Elevation above sea level in feet										
	0 1060	1060 2130	2130 3200	3200 4260	4260 5330	5330 6400	6400 7460	7460 8530	8530 9600	9600 10660	10660 11730
54°41' - 55°52'	22	22	21	21	20	20	19	19	18	18	17
55°52' - 57°04'	23	22	22	21	21	20	20	19	19	18	18
57°04' - 58°17'	23	23	22	22	21	21	20	20	19	19	18
58°17' - 59°32'	24	23	23	22	22	21	21	20	20	19	19
59°32' - 60°49'	24	24	23	23	22	22	21	21	20	20	19
60°49' - 62°09'	25	24	24	23	23	22	22	21	21	20	20
62°09' - 63°30'	25	25	24	24	23	23	22	22	21	21	20
63°30' - 64°55'	26	25	25	24	24	23	23	22	22	21	21
64°55' - 66°24'	26	26	25	25	24	24	23	23	22	22	21
66°24' - 67°57'	27	26	26	25	25	24	24	23	23	22	22
67°57' - 69°35'	27	27	26	26	25	25	24	24	23	23	22
69°35' - 71°21'	28	27	27	26	26	25	25	24	24	23	23
71°21' - 73°16'	28	28	27	27	26	26	25	25	24	24	23
73°16' - 75°24'	29	28	28	27	27	26	26	25	25	24	24
75°24' - 77°52'	29	29	28	28	27	27	26	26	25	25	24
77°52' - 80°56'	30	29	29	28	28	27	27	26	26	25	25
80°56' - 85°45'	30	30	29	29	28	28	27	27	26	26	25
85°45' - 90°00'	31	30	30	29	29	28	28	27	27	26	26



Ohaus Corporation
7 Campus Drive
Suite 310
Parsippany, NJ 07054
Tel: (973) 377-9000

With offices worldwide

www.ohaus.com



P/N 83032210 B © 2011 Ohaus Corporation, all rights reserved
™ Registered trademark of Ohaus Corporation.

The information contained in this manual is believed to be accurate at the time of publication, but Ohaus Corporation assumes no liability arising from the use or misuse of this material. Reproduction of this material is strictly prohibited.

Material in this manual is subject to change.